

EMISSIONS TEST REPORT

POLK POWER STATION
FACILITY ID NUMBER: 1050233

IGCC – UNIT 1, EMISSIONS UNIT ID -001

NITROGEN OXIDES, SULFUR DIOXIDE, SULFURIC ACID MIST,
CARBON MONOXIDE, AND VISIBLE EMISSIONS

SULFURIC ACID PLANT, EMISSIONS UNIT ID -004

SULFUR DIOXIDE, SULFURIC ACID MIST AND VISIBLE
EMISSIONS

November 8, 2006

Prepared For:
Tampa Electric Company
Polk Power Station
P.O. Box 111
Tampa, Florida 33601-0111

Prepared By:
Tampa Electric Company
Environmental, Health and Safety
Environmental Services
Air Services Group



Environmental Services
Air Services Group
5010 Causeway Boulevard
Tampa, Florida 33619- 6130

EMISSIONS TEST REPORT

POLK POWER STATION
FACILITY ID NUMBER: 1050233

IGCC – UNIT 1, EMISSIONS UNIT ID -001

NITROGEN OXIDES, SULFUR DIOXIDE, SULFURIC ACID MIST,
CARBON MONOXIDE, AND VISIBLE EMISSIONS

SULFURIC ACID PLANT, EMISSIONS UNIT ID -004

SULFUR DIOXIDE, SULFURIC ACID MIST AND VISIBLE
EMISSIONS

November 8, 2006

Prepared For:
Tampa Electric Company
Polk Power Station
P.O. Box 111
Tampa, Florida 33601-0111

RECEIVED

DEC 21 2006

BUREAU OF AIR REGULATION

Prepared By:
Tampa Electric Company
Environmental, Health and Safety
Environmental Services
Air Services Group



Environmental Services
Air Services Group
5010 Causeway Boulevard
Tampa, Florida 33619- 6130

REPORT CERTIFICATION

The sampling and subsequent data entry/reduction detailed in this report was conducted at my direction, and I hereby certify that this test report is authentic and accurate to the best of my knowledge.

Signature: _____

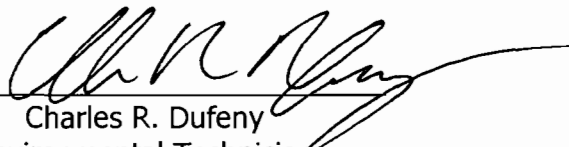
Charles R. Dufeny
Environmental Technician
Test Team Lead
Air Services Group
Environmental Health & Safety
Tampa Electric Company

I have reviewed the test performance, associated quality assurance activities, the resultant calculations, and the contents of this report, and certify that all project quality objectives have been met. This report is approved for submittal.

Signature: _____

Raymond A. McDarby, Jr.
Senior Environmental Technician
Quality Assurance/Quality Control Specialist
Air Services Group
Environmental Health & Safety
Tampa Electric Company

I have reviewed the testing details and results submitted in this report, and hereby certify that this test report is authentic and accurate to the best of my knowledge.

Signature: _____



David A. Smith
Coordinator – Air Services Group
Environmental Health & Safety
Tampa Electric Company

TABLE OF CONTENTS

<u>SECTION</u>	<u>PAGE</u>
1.0 INTRODUCTION	1
2.0 DISCUSSION OF RESULTS	2
3.0 SOURCE DESCRIPTION	5
4.0 FUEL INFORMATION	6
5.0 TESTING PROCEDURES	8
6.0 TABULATED RESULTS	
<u>IGCC COMBUSTION TURBINE</u>	
NITROGEN OXIDES FROM CEMS	10
SULFUR DIOXIDE FROM CEMS	11
SULFURIC ACID MIST DATA SUMMARY	12
CARBON MONOXIDE DATA SUMMARY	13
HEAT INPUT CALCULATION	14
<u>SULFURIC ACID PLANT</u>	
SULFUR DIOXIDE DATA SUMMARY	15
SULFURIC ACID MIST DATA SUMMARY	16
7.0 FIGURES	
FIGURE 1 SULFURIC ACID PLANT SAMPLING LOCATION	18
FIGURE 2 IGCC SAMPLING LOCATION	19

LIST OF TABLES

EXECUTIVE SUMMARY	2
TABLE 1 – FUEL INFORMATION, BLEND COAL	6
TABLE 2 – FUEL INFORMATION, BASELINE BLENDED FUEL	7

APPENDICIES

APPENDIX A – IGCC CEMS DATA – SO ₂ , NO _x , CO ₂ , STACK FLOW	
APPENDIX B – SULFURIC ACID MIST TEST DATA – IGCC	
FIELD DATA SHEETS	
CALCULATED DATA	
LABORATORY ANALYSIS	
CALIBRATION DATA	

APPENDIX C – SULFURIC ACID MIST TEST DATA – SULFURIC ACID PLANT
FIELD DATA SHEETS
CALCULATED DATA
LABORATORY ANALYSIS
CALIBRATION DATA

APPENDIX D – INSTRUMENTAL REFERENCE METHOD TEST DATA – IGCC
OXYGEN, CARBON DIOXIDE, CARBON MONOXIDE DATA
CALIBRATION GAS CERTIFICATIONS

APPENDIX E – INSTRUMENTAL REFERENCE METHOD TEST DATA – SULFURIC
ACID PLANT
SULFUR DIOXIDE, OXYGEN, CARBON DIOXIDE SUMMARY
QUALITY ASSURANCE ACTIVITIES
RUN LOG
CALIBRATION GAS CERTIFICATIONS

APPENDIX F – FUEL ANALYSIS
SYNTHETIC GAS ANALYSIS – NOVEMBER 8, 2006

APPENDIX G – PLANT OPERATIONS DATA
IGCC
SULFURIC ACID PLANT

APPENDIX H – VISIBLE EMISSIONS OBSERVATIONS
IGCC
SULFURIC ACID PLANT

APPENDIX I – CHAIN OF CUSTODY

APPENDIX J – PROJECT PARTICIPANTS

1.0 INTRODUCTION

On November 08, 2006, Tampa Electric Company's Air Services Group (ASG), and Trigon Engineering Consultants performed relative concurrent emissions testing on Polk Power Station's Integrated Gasification and Combined Cycle (IGCC) Combustion Turbine (Unit 1, E.U. 001), and its attendant Sulfuric Acid Plant (SAP, E.U. 004). Testing was conducted as part of the project specified in Florida Department of Environmental Protection (FDEP) Draft Air Permit No. 1050233-019-AC and demonstrate annual compliance with the applicable emission limits. The permitted emissions limits and test methodologies are consistent with the requirements of Title V Permit No. 1050233-016-AV. This specific test was conducted at baseline or normal conditions with a blended fuel content of 60% petroleum coke/40% coal gasification. For the purposes of Permit No. 1050233-019-AC this test establishes representative baseline emissions for Nitrogen Oxides (NO_x, IGCC only), Sulfur Dioxide (SO₂, SAP and IGCC), Sulfuric Acid Mist (H₂SO₄, SAP and IGCC), Carbon Monoxide (CO, IGCC), and Visible Emissions (SAP and IGCC). All testing was performed using approved United States Environmental Protection Agency (USEPA) Reference Methods. SO₂ and NO_x for E.U. 001 were provided by the installed, certified CEM system.

2.0 DISCUSSION OF RESULTS

**Executive Summary
Tampa Electric Company
Polk Power Station
IGCC Combustion Turbine Unit 1 and Sulfuric Acid Plant
Emission Unit -001 and -004
Firing Petroleum Coke/Coal Gasification Syngas Fuel**

IGCC Combustion Turbine		
Compliance Parameter	Test Result	FDEP Permit Limit
NO _x , ppmvd @ 15% O ₂	12	25
NO _x , lbs/hr	108.57	220.25
SO ₂ , lb/mmBtu	0.12	0.17
SO ₂ , lbs/hr	200	357
H ₂ SO ₄ , lbs/hr	28	55
CO, ppmvd	3	25
CO, lbs/hr	16	98
VE, % Opacity	0	10
Calculated Heat Input, mmBtu/hr	1702	--
Permitted Heat Input, mmBtu/hr ¹	1737	--
Unit Capacity Factor, % of Permit ²	98%	90 – 100 %
Sulfuric Acid Plant		
SO ₂ , lbs/ton of acid produced	Two	four
H ₂ SO ₄ , lbs/ton of acid produced	0.05	0.15
VE, % Opacity	0	10

¹ Permitted Heat Input Corrected to Inlet Vane Temperature.

² Calculated Heat Input divided by Permitted Heat Input, result times 100.

IGCC Combustion Turbine

Nitrogen Oxides (NO_x)

During the Sulfuric Acid Mist test time period (10:35 to 15:36) on the IGCC, the average NO_x concentration was 12 ppmvd @ 15% O₂, and the average emission rate was 108.57 lbs/hr. The permitted concentration and emission rate is 25 ppmvd @ 15% O₂, and 220.25 lbs/hr.

Sulfur Dioxide SO₂

During the Sulfuric Acid Mist test time period (10:35 to 15:36) on the IGCC, the average SO₂ concentration was 0.12 lb/mmBtu, and the average emission rate was 200 lbs/hr. The permitted concentration and emission rate is 0.17 lb/mmBtu and 357 lbs/hr.

Sulfuric Acid Mist (H₂SO₄)

The Sulfuric Acid Mist test was conducted from 10:35 to 15:36. The average H₂SO₄ emission rate for the test period was 28 pounds per hour. The permitted emission rate is 55 lbs/hr.

Carbon Monoxide (CO)

During the Sulfuric Acid Mist test time period (10:35 to 15:36) on the IGCC, the average CO concentration was 3 ppmvd, and the average emission rate was 16 lbs/hr. The permitted concentration and emission rate is 25 ppmvd, and 98 lbs/hr.

Visible Emissions

The Visible Emissions test was conducted from 13:15 through 13:45. The average opacity from the IGCC was 0%. The permitted opacity from this source is 10%.

Heat Input

During the test the IGCC was operated at an average Heat input of 1702 mmBtu/hr. The FDEP permitted heat input is 1755 mmBtu/hr, at an ambient temperature of 59° (corrected to 1737 mmBtu/hr based on an average inlet vane temperature of 71°F, and the manufacturer's heat input correction curve for this unit). The calculated capacity factor during the test was 98% of the FDEP permitted heat input.

Sulfuric Acid Plant

Sulfur Dioxide SO₂

During the Sulfuric Acid Mist test time period (10:30 to 15:28) on the SAP, the average SO₂ emission rate was two pounds per ton of 100% acid produced. The permitted emission rate is four pounds per ton of 100 percent acid produced.

Sulfuric Acid Mist (H₂SO₄)
SAP

The Sulfuric Acid Mist test was conducted from 10:30 to 15:28. The average H₂SO₄ emission rate for the test period was 0.05 pound per ton of 100 percent acid produced. The permitted emission rate is 0.15 pound per ton of 100 percent acid produced.

Visible Emissions

The Visible Emissions test was conducted from 13:15 through 13:45. The average opacity from the Sulfuric Acid Plant was 0%. The permitted opacity from this source is 10%.

3.0 SOURCE DESCRIPTION

The Polk Power Station facility is located at 9995 State Road 37 South, Mulberry, Polk County, Florida. The UTM Coordinates are, Zone 17, 402.45 km East and 3067.35 km North. Title V Air Operation Permit No. 1050233-016-AV regulates the emissions from this facility.

The Sulfuric Acid Plant at this facility takes the sulfur gas stream from the solid fuel gasification plant's hot or cold gas cleanup systems and converts it to sulfuric acid using a double contact process. The sulfuric acid plant has a 15 MMBtu/hr, propane fired, H₂S to SO₂ conversion furnace, and a 9 MMBtu/hr, propane fired non-contact SO₂ to SO₃ converter pre-heater, which vents to the atmosphere through a 198-foot exhaust stack. The exhaust stack is designed to maintain ultra low flow velocities to prevent sulfuric acid liquid from becoming entrained in the exhaust stream, eliminating the emissions of acid droplets. A diagram of the exhaust stack is included as Figure 1 in this report.

Unit No. 1 is an Integrated Gasification Combined Cycle Combustion Turbine generating unit, with a net capacity of 192 MW when fired with Syngas fuel. The source sampling location consists of a circular stack 19 feet in diameter with four sample ports located 90 degrees apart on the stack circumference. A diagram of the stack sampling location is included as Figure 2 in this report.

4.0 FUEL INFORMATION

Blending Procedure

Coal and petroleum coke for Polk Power Station are blended at Tampa Electric's Big Bend Power Station and delivered by truck to the Polk site. Blending is accomplished as follows. Polk's blend coal is stored in a dedicated pile at Big Bend Power Station. As each petroleum coke barge is received and unloaded using a conveyor system with a calibrated scale, coal is reclaimed from the coal pile, weighed and blended with the petroleum coke on the unloading conveyor. The blended fuel is stacked in a separate dedicated blended fuel pile for Polk. The sulfur content and other parameters of the blended fuel are measured using ASTM methods on each barge of petroleum coke and coal (individually) and calculated based on their ratio in the blended fuel.

Coal

The coal portion of the blended fuel for the November 8 stack tests was assumed to be an equal mixture of the previous two coal shipments (August 9, 2006 and October 4, 2006) for Polk Power Station. The composition of each shipment is shown in Table 1 below.

Fuel Analysis (As Received Basis)	Units	Coal Shipment 8/9/06	Coal Shipment 10/4/06	Coal Mixture
Total Moisture	Wt %	11.10	14.06	12.58
Ash	Wt %	10.96	10.88	10.92
Carbon	Wt %	62.03	59.83	60.93
Hydrogen	Wt %	4.29	4.13	4.21
Nitrogen	Wt %	1.40	1.37	1.39
Sulfur	Wt %	0.64	0.64	0.64
Chlorine	Wt %	0.02	0.02	0.02
Oxygen (By Difference)	Wt %	9.56	9.08	9.32
Volatiles	Wt %	33.10	32.90	33.00
Fixed Carbon	Wt %	44.84	42.16	43.50
HHV	Btu/lb	11,044	10,651	10,848

Table 1 Blend Coal

Blended Fuel

The fuel consumed during this stack test was from the blends of two petroleum coke barges received on October 13, 2006 and November 1, 2006, as well as the coal blend detailed in Table 1. The petroleum coke analysis, the calculated composition of the coal blend, and the calculated composition of the final blend are shown in Table 2. The tonnages of both the petroleum coke and coal blend from the Big Bend certified scales used in the blending operation are also included in Table 2.

Fuel Analysis (As Received Basis)	Units	Blend Coal	Petroleum Coke Barge #1	Petroleum Coke Barge #2	Blended Fuel
Quantity	Tons	9,832	9,123	5,352	24,307
Total Moisture	Wt %	12.58	4.29	6.31	8.09
Ash	Wt %	10.92	0.78	0.90	4.91
Carbon	Wt %	60.93	82.96	80.75	73.56
Hydrogen	Wt %	4.21	3.68	3.55	3.87
Nitrogen	Wt %	1.39	1.67	1.67	1.55
Sulfur	Wt %	0.64	4.95	4.53	3.11
Chlorine	Wt %	0.02	0.02	0.02	0.02
Oxygen	Wt %	9.32	1.65	2.27	4.89
Volatiles	Wt %	33.00	9.61	10.16	19.19
Fixed Carbon	Wt %	43.50	85.33	82.63	67.82
HHV	Btu/lb	10,848	14,465	14,113	12,924

Table 2 Base-Line Blended Fuel

5.0 TESTING PROCEDURES

Nitrogen Oxides (NO_x) and Sulfur Dioxide (SO₂) data for the IGCC for the test period was supplied by the installed, certified CEM system on that unit.

Sulfur Dioxide (SO₂) data for the SAP was derived from 3 United States Environmental Protection Agency (USEPA) Reference Method 6C – “DETERMINATION OF SULFUR DIOXIDE EMISSIONS FROM STATIONARY SOURCES (INSTRUMENTAL ANALYZER PROCEDURE)” test runs.

Sulfuric Acid Mist (H₂SO₄) data for the IGCC, and the SAP were derived from 3 USEPA Reference Method 8 – “DETERMINATION OF SULFURIC ACID MIST AND SULFUR DIOXIDE EMISSIONS FROM STATIONARY SOURCES” test runs.

Carbon Monoxide (CO) data for the IGCC was derived from 3 USEPA Reference Method 10 – “DETERMINATION OF CARBON MONOXIDE EMISSIONS FROM STATIONARY SOURCES (INSTRUMENTAL ANALYZER PROCEDURE)” test runs.

Visible Emissions data for the IGCC and SAP were derived from 30-minute visible emissions observations using USEPA Reference Method 9 – “VISUAL DETERMINATION OF THE OPACITY OF EMISSIONS FROM STATIONARY SOURCES” test runs. These tests were conducted concurrently.

6.0 TABULATED RESULTS



**POLK POWER STATION - INTEGRATED GASIFICATION COMBINED CYCLE
NITROGEN OXIDES FROM CEMS DATA SUMMARY**

**IGCC COMBUSTION TURBINE - UNIT 1
November 08, 2006**

Test Period Start Time: 10:35 Test Period Stop Time: 15:36

CEMS Data

Average NO_x, ppmvw for Test Period: 18.64 ppmvw
Average NO_x, ppmvd @ 15% O₂ for Test Period: 12.36 ppmvd@ 15% O₂
Average Stack Flow for Test Period: 813.0 kscfm

Calculated Data

NO_x, lbs/hr: 108.57 lbs/hr

NO_x in lbs/hr is calculated as:
NO_x, ppmvw x 1.194E-07 x Stack Flow, kscfm x 1,000/k x 60 min/hr



**POLK POWER STATION - INTEGRATED GASIFICATION COMBINED CYCLE
SULFUR DIOXIDE FROM CEMS DATA SUMMARY**

**IGCC COMBUSTION TURBINE - UNIT 1
November 08, 2006**

Test Period Start Time: 10:35 Test Period Stop Time: 15:36

CEMS Data

Average SO₂, ppmvw for Test Period: 37.94 ppmvw
Average CO₂, % volume for Test Period: 8.71 % volume

Calculated Data

Heat Input: 1702 mmBtu/hr
SO₂, lb/mmBtu 0.12 lb/mmBtu
SO₂, lbs/hr: 199.80 lbs/hr

SO₂ in lb/mmBtu is calculated as:

$$\text{SO}_2, \text{ ppmvw} \times 1.660\text{E-}07 \times F_c \times (100/\text{CO}_2, \%)$$

Where:

$$F_c = 2310 \text{ scf/mmBtu}$$

SO₂ in lbs/hr is calculated as:

$$\text{SO}_2, \text{ lb/mmBtu} \times \text{Heat Input, mmBtu/hr}$$



**POLK POWER STATION - INTEGRATED GASIFICATION COMBINED CYCLE
SULFURIC ACID MIST DATA SUMMARY**

**IGCC COMBUSTION TURBINE - UNIT 1
November 08, 2006**

	<u>Run #1</u>	<u>Run #2</u>	<u>Run #3</u>	<u>Average</u>
Gas Flow Rates				
Q _{sr} , acfm:	1446136.6	1401205.4	1425842.8	1424394.96
Q _{s(std)} , dscfm:	919750.9	886657.5	892568.9	899659.07
Sampled Volume, V _{m(std)} , dscf:	35.95	34.58	35.05	35.195
Stack Moisture, B _{ws} × 100, %:	3.81	4.18	5.24	4.409
Isokinetic Sampling Rate, I, %:	99	98.7	99.4	99.03
<hr/>				
C _{H2SO4r} , lb/dscf:	3.957E-07	6.095E-07	5.712E-07	5.255E-07
Q _{s(std)} , dscfm:	919750.9	886657.5	892568.9	899659.07
E _{H2SO4r} , lbs/hr:	21.834	32.425	30.591	28.364

Emission Rate Calculated as C_{H2SO4} × Q_{s(std)} × 60 minutes/hr



**POLK POWER STATION - INTEGRATED GASIFICATION COMBINED CYCLE
CARBON MONOXIDE DATA SUMMARY**

IGCC COMBUSTION TURBINE - UNIT 1 November 08, 2006

Run Number	Test Times		CO ppmvd	O2 % volume	CO ppmvd@15% O2	CO lbs/hr
1	8:17	9:33	4.900	12.281	3.354	17.383
2	10:53	11:53	4.413	12.380	3.056	15.655
3	12:31	13:31	4.265	12.368	2.949	15.130
Averages :					3.1198	16.0562

CO, ppmvd @ 15% O2 is calculated as:

$$\text{CO, ppmvd} \times (5.9 / (20.9 - \text{O2, \% volume}))$$

CO, lbs/hr is calculated as:

$$\text{CO, ppmvd} \times \text{Cf} \times \text{Stack Flow} \times 1000/\text{k} \times 60 \text{ minutes/hr}$$

Where:

$$\text{Cf} = 7.272\text{E-}08$$

$$\text{Stack Flow} = 813.0043 \text{ kscfm}$$



**POLK POWER STATION - INTEGRATED GASIFICATION COMBINED CYCLE
HEAT INPUT CALCULATION**

<p align="center">IGCC COMBUSTION TURBINE - UNIT 1 November 08, 2006</p>

Average fuel flow:	6830.9742	Kcfh
Mole weight correction to meter cal:	0.9883	mole weight correction factor
Corrected fuel flow: ¹	6751.0518	Kcfh, corrected for density
Average moisture:	0.2352024	% H ₂ O added to fuel
Corrected fuel flow: ²	6735.1731	Kscfh, corrected for moisture
Gross heating value of fuel (HHV):	252.05	Btu/scf
Heat Input:	1702	mmBtu/hr

Average fuel flow from Plant Information Data Base.

Mole weight correction factor to meter calibration is taken from ratio of syngas mole weight to calibration gas mole weight.

¹Average fuel flow times mole weight correction factor.

²Corrected fuel flow times (1 - (Average moisture / 100)).

Gross Heating value of fuel (HHV) is from fuel analysis.

Heat input is (HHV x Corrected fuel flow) / 1000.



Environmental Services
Air Services Group

**POLK POWER STATION
SULFUR DIOXIDE CALCULATIONS**

**SULFURIC ACID PLANT
November 8, 2006**

Data Calculated from Plant Operational Measurements:

	<u>Run 1</u>	<u>Run 2</u>	<u>Run 3</u>
Gallons of Acid Produced During The Test Period, P _{gal} =	1336.162	1495.006	1236.200 gallons
Density of Water, D =	8.345	8.345	8.345 lbs/gallon
Specific Gravity of Sulfuric Acid, SG =	1.84	1.84	1.84 dimensionless
Average Concentration of Acid Produced, C _{acid} =	93.491	93.491	93.495 %
Tons of Acid Produced During The Test Period, P _{st} =	9.591	10.731	8.873 short tons

Where:

$$\text{Tons of acid produced} = (P_{gal} \times D \times SG \times (C_{acid})) / 2000 \text{ lbs/ton}$$

Data Calculated from Stack Measurements:

Volumetric Flow Rate Through Stack, Q _{std} =	990690.0	962766.0	1016724.0 dscf/hr
Sulfur Dioxide Concentration in Stack, C _{SO2} =	129.22	124.54	118.01 ppmvd
Sulfur Dioxide Concentration in Stack, C _{SO2} =	2.145E-05	2.067E-05	1.959E-05 lbs/scf
Sulfur Dioxide Emission Rate, E _{SO2} =	2.22	1.85	2.24 lbs/ton of acid
Average Sulfur Dioxide Emission Rate, E _{SO2} =	2.11		lbs/ton of acid

Where:

$$C_{SO2} \text{ lbs/scf} = C_{SO2, ppm} \times 1.66E-07$$

$$E_{SO2} = (C_{SO2, lbs/scf} \times Q_{std}) / \text{tons of acid produced}$$



**POLK POWER STATION - SULFURIC ACID PLANT
SULFURIC ACID MIST DATA SUMMARY**

SULFURIC ACID PLANT November 08, 2006
--

	<u>Run #1</u>	<u>Run #2</u>	<u>Run #3</u>	<u>Average</u>
Gas Flow Rates				
Q_s , acfm:	20828.4	21248.1	21180.6	21085.68
$Q_{s(std)}$, dscfm:	16511.5	16046.1	16945.4	16500.98
Sampled Volume, $V_{m(std)}$, dscf:	52.19	31.80	53.98	45.991
Stack Moisture, $B_{ws} \times 100$, %:	6.10	8.08	5.39	6.524
Isokinetic Sampling Rate, I , %:	100.4	114.8	101.2	105.47
<hr/>				
$C_{H_2SO_4}$, lb/dscf:	6.966E-07	5.301E-07	4.978E-07	5.748E-07
Tons of Acid Produced:	9.200	12.415	10.383	10.66608
$E_{H_2SO_4}$, lbs/ton of acid:	0.07501	0.04111	0.04874	0.05496

$E_{H_2SO_4}$, lbs/ton of acid is calculated as:

$$(C_{H_2SO_4}, \text{ lb/dscf} \times Q_{s(std)}, \text{ dscfm} \times 60 \text{ minutes/hr}) / \text{Tons of Acid Produced}$$

7.0 FIGURES

**POLK POWER STATION
UNIT NO.1 ACID PLANT TEST LOCATION
SAMPLING TRAVERSE POINTS**

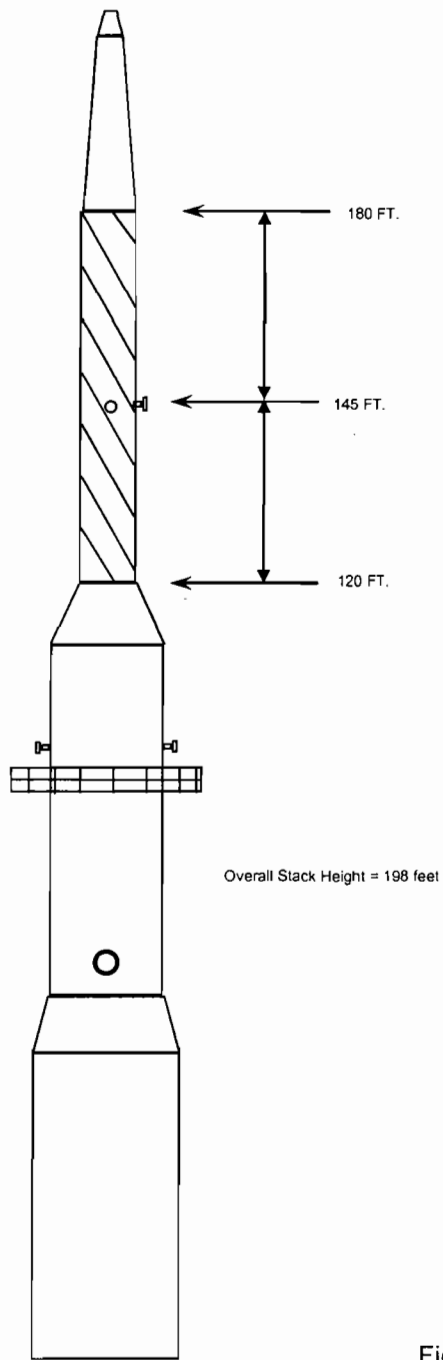

TRAVERSE POINTS	% OF STACK DIAMETER	IN. FROM STACK WALL
1	3.2 %	2.30
2	10.5 %	7.56
3	19.4 %	13.97
4	32.3 %	23.26
5	67.7 %	48.74
6	80.6 %	58.03
7	89.5 %	64.44
8	96.8 %	69.70

STACK DIAMETERS DOWNSTREAM FROM DISTURBANCE = 4.2

STACK DIAMETERS UPSTREAM FROM DISTURBANCE = 5.8

STACK DIAMETER = 6.0 FT. ID.
STACK AREA = 28.274 SQ. FT.

PORT LENGTH = 5.0 IN.

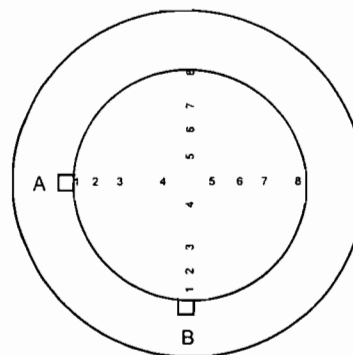

PORT LOCATION PLAN

Source is Monsanto Enviro-Chem Drawing no. 511-150 v. 2

Figure 1

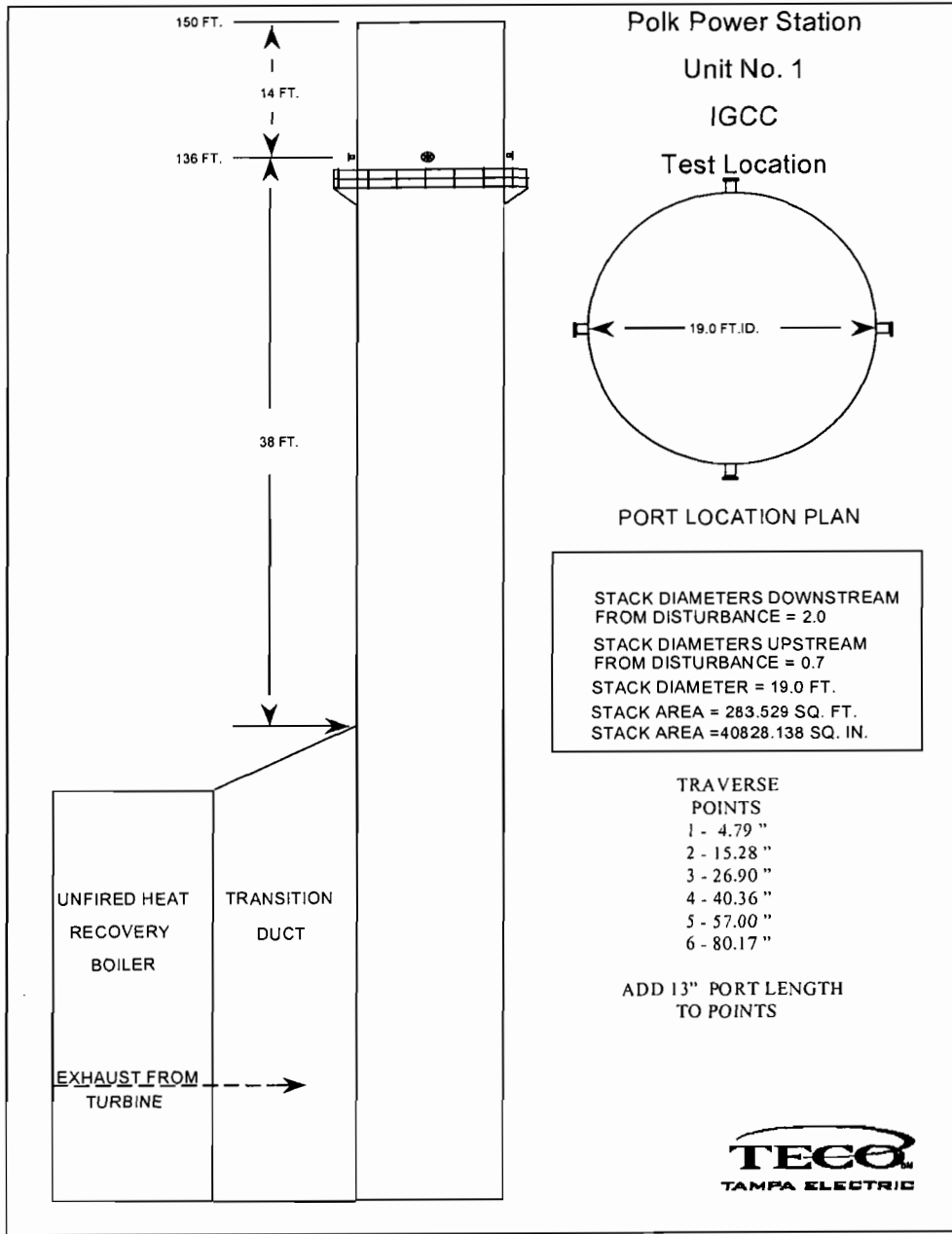

APPENDIX A
IGCC CEMS DATA
SO₂, NO_x, CO₂, STACK FLOW

HRSG CEMS Data

Date Time	SO21	NOX1	PC1NOXC1	FLO1	CO21
11/8/2006 10:35	33.14	18.9	12.499	810.6	8.8
11/8/2006 10:36	33.2	19	12.499	799.5	8.8
11/8/2006 10:37	31.97	19	12.547	787.5	8.8
11/8/2006 10:38	32.21	19.2	12.686	805.7	8.8
11/8/2006 10:39	33.67	19.1	12.582	812	8.8
11/8/2006 10:40	32.65	17.8	11.806	795.2	8.8
11/8/2006 10:41	32.12	18.3	12.015	817.2	8.8
11/8/2006 10:42	33.47	18.9	12.411	827.4	8.8
11/8/2006 10:43	34.07	18.9	12.477	812.6	8.8
11/8/2006 10:44	33.85	19.1	12.664	821.9	8.8
11/8/2006 10:45	33.12	18.9	12.524	822.6	8.8
11/8/2006 10:46	32.75	19	12.532	820.7	8.7
11/8/2006 10:47	32.92	19.1	12.62	822	8.8
11/8/2006 10:48	34.27	19.3	12.683	827.1	8.8
11/8/2006 10:49	34.12	18	12.012	804.3	8.7
11/8/2006 10:50	32.05	18	11.652	795.9	8.7
11/8/2006 10:51	32.39	19.2	12.694	803.6	8.8
11/8/2006 10:52	32.96	19.6	13.051	793.9	8.8
11/8/2006 10:53	33.47	20.1	13.364	830.4	8.8
11/8/2006 10:54	33.42	20	13.364	810.9	8.7
11/8/2006 10:55	33.24	19.9	13.331	821.5	8.7
11/8/2006 10:56	32.97	19.7	13.045	829.1	8.7
11/8/2006 10:57	32.81	19.4	12.84	807.5	8.7
11/8/2006 10:58	33.4	19.3	12.73	796.5	8.7
11/8/2006 10:59	34.09	19.2	12.669	791.8	8.7
11/8/2006 11:00	32.63	18.1	11.993	796.3	8.7
11/8/2006 11:01	32.1	18.6	12.246	796.7	8.7
11/8/2006 11:02	33.33	19.1	12.587	819.7	8.7
11/8/2006 11:03	33.83	19.1	12.669	812.4	8.7
11/8/2006 11:04	33.85	19.2	12.701	814.4	8.7
11/8/2006 11:05	33.01	19.1	12.73	813.2	8.7
11/8/2006 11:06	32.64	19.1	12.681	812.9	8.7
11/8/2006 11:07	32.91	19.2	12.76	812.3	8.7
11/8/2006 11:08	34.45	19.4	12.844	832.1	8.7
11/8/2006 11:09	34.81	18.3	12.323	814.6	8.7
11/8/2006 11:10	33.17	18.3	12.084	821.8	8.7
11/8/2006 11:11	33.37	19.3	12.819	789.6	8.7
11/8/2006 11:12	33.94	19.7	13.086	785.6	8.7
11/8/2006 11:13	33.62	20.2	13.486	812.8	8.7
11/8/2006 11:14	33.75	20.2	13.497	817.2	8.7

HRSG CEMS Data

Date Time	SO21	NOX1	PC1NOXC1	FLO1	CO21
11/8/2006 11:15	33.59	20	13.475	810.9	8.7
11/8/2006 11:16	33.29	19.7	13.119	811.7	8.7
11/8/2006 11:17	32.66	19.9	13.275	822.6	8.7
11/8/2006 11:18	32.89	20.2	13.403	833.1	8.7
11/8/2006 11:19	33.47	19.7	13.138	819.5	8.7
11/8/2006 11:20	32.95	18.2	12.092	797.4	8.7
11/8/2006 11:21	32.98	18.9	12.422	816.2	8.7
11/8/2006 11:22	33.78	19.4	12.754	796.3	8.7
11/8/2006 11:23	34.63	19.7	13.108	815.3	8.7
11/8/2006 11:24	34.7	19.7	13.123	814.3	8.7
11/8/2006 11:25	34.31	19.2	12.697	810	8.7
11/8/2006 11:26	34.37	19.1	12.612	801.4	8.7
11/8/2006 11:27	34.82	19.1	12.668	818.5	8.7
11/8/2006 11:28	36.07	19.2	12.674	826	8.7
11/8/2006 11:29	36.7	18.2	12.045	826.2	8.7
11/8/2006 11:30	35.4	18.1	11.95	798.4	8.7
11/8/2006 11:31	35.67	19	12.549	807.4	8.7
11/8/2006 11:32	36.49	19.5	12.963	821.5	8.7
11/8/2006 11:33	36.49	19.8	13.219	803.7	8.7
11/8/2006 11:34	36.9	19.7	13.07	825.7	8.7
11/8/2006 11:35	37.19	19.6	13.086	814.3	8.7
11/8/2006 11:36	36.76	20.2	13.453	820.7	8.7
11/8/2006 11:37	36.73	20.5	13.654	822	8.7
11/8/2006 11:38	36.77	20.1	13.428	798.5	8.7
11/8/2006 11:39	36.95	19.6	13.028	791.5	8.7
11/8/2006 11:40	35.62	18.4	12.237	810.7	8.7
11/8/2006 11:41	34.92	19.3	12.774	814.7	8.7
11/8/2006 11:42	35.54	19.9	13.273	834.2	8.7
11/8/2006 11:43	35.98	19.9	13.375	820.1	8.7
11/8/2006 11:44	36.43	19.9	13.264	834.8	8.7
11/8/2006 11:45	36.81	19.8	13.217	824	8.7
11/8/2006 11:46	36.87	19.7	13.131	832.3	8.7
11/8/2006 11:47	36.46	19.8	13.242	815.5	8.7
11/8/2006 11:48	36.75	19.4	12.832	805.1	8.7
11/8/2006 11:49	36.47	18.5	12.309	800.6	8.7
11/8/2006 11:50	34.41	18.2	11.996	835	8.7
11/8/2006 11:51	34.78	19.2	12.752	809.2	8.7
11/8/2006 11:52	35.87	19.8	13.186	827.3	8.7
11/8/2006 11:53	36.03	20.3	13.509	843.5	8.7
11/8/2006 11:54	36.34	20.2	13.542	831.3	8.7

HRSO CEMS Data

Date Time	SO21	NOX1	PC1NOXC1	FLO1	CO21
11/8/2006 11:55	36.6	20.1	13.431	802.9	8.7
11/8/2006 11:56	37.36	20	13.398	822	8.7
11/8/2006 11:57	37.19	19.8	13.219	803.5	8.7
11/8/2006 11:58	37.99	19.9	13.264	795.5	8.7
11/8/2006 11:59	38.5	19.7	13.094	815	8.7
11/8/2006 12:00	37.03	18.4	12.237	803.3	8.7
11/8/2006 12:01	35.91	19	12.63	811.6	8.7
11/8/2006 12:02	36.9	19.6	13.019	802.3	8.7
11/8/2006 12:03	37.44	20	13.386	806.9	8.7
11/8/2006 12:04	37.02	19.8	13.275	814.6	8.7
11/8/2006 12:05	36.7	19.8	13.197	805.2	8.7
11/8/2006 12:06	36.98	19.9	13.23	820.3	8.7
11/8/2006 12:07	37.28	19.9	13.308	799.8	8.7
11/8/2006 12:08	38.26	20	13.306	805.6	8.7
11/8/2006 12:09	38.53	19.1	12.829	811	8.7
11/8/2006 12:10	37	18.9	12.496	813.8	8.7
11/8/2006 12:11	37.15	19.7	13.119	821.2	8.7
11/8/2006 12:12	38.16	19.8	13.204	828	8.7
11/8/2006 12:13	38.22	19.6	13.07	811.5	8.7
11/8/2006 12:14	38	19.3	12.811	807	8.7
11/8/2006 12:15	38.31	19.3	12.752	798.5	8.7
11/8/2006 12:16	39.88	19.2	12.852	826	8.7
11/8/2006 12:17	39.59	19.6	13.041	812.1	8.7
11/8/2006 12:18	40.72	19.8	13.208	812.7	8.7
11/8/2006 12:19	41.15	19.5	13.005	813	8.7
11/8/2006 12:20	39.44	18.5	12.336	817.1	8.7
11/8/2006 12:21	38.16	19	12.608	818.1	8.7
11/8/2006 12:22	38.77	19.8	13.175	824.2	8.7
11/8/2006 12:23	39.81	20.2	13.431	832.9	8.7
11/8/2006 12:24	39.76	20	13.408	823.7	8.7
11/8/2006 12:25	38.9	19.8	13.264	816.9	8.7
11/8/2006 12:26	35.03	14.7	11.851	813.7	5
11/8/2006 12:27	3.5	0.4	0.423	827.7	0.1
11/8/2006 12:28	12.28	9.3	5.393	826.8	5.6
11/8/2006 12:29	38.69	19.2	12.719	822.7	8.7
11/8/2006 12:30	38.44	19	12.574	830.4	8.7
11/8/2006 12:31	38.38	19.7	13.141	830.1	8.7
11/8/2006 12:32	39.16	20	13.208	814.9	8.7
11/8/2006 12:33	40.04	20.2	13.453	814.8	8.7
11/8/2006 12:34	40.07	20.3	13.528	825	8.7

HRSO CEMS Data

Date Time	SO21	NOX1	PC1NOXC1	FLO1	CO21
11/8/2006 12:35	39.96	20	13.38	812.7	8.8
11/8/2006 12:36	39.98	19.7	13.125	823.3	8.7
11/8/2006 12:37	40.04	19.6	13.075	826.7	8.7
11/8/2006 12:38	39.96	19.6	13.041	816.5	8.7
11/8/2006 12:39	40.53	19.6	13.005	799.8	8.7
11/8/2006 12:40	38.66	18.3	12.225	823.6	8.7
11/8/2006 12:41	36.93	18.9	12.473	832.6	8.7
11/8/2006 12:42	38.39	19.7	13.097	833.1	8.7
11/8/2006 12:43	38.64	19.9	13.275	808	8.7
11/8/2006 12:44	39.42	19.5	13.13	803.4	8.7
11/8/2006 12:45	38.62	19.2	12.819	806.7	8.7
11/8/2006 12:46	38.93	19.5	12.997	804.6	8.7
11/8/2006 12:47	38.91	19.4	12.975	811.3	8.7
11/8/2006 12:48	40.21	19.5	12.902	814.2	8.7
11/8/2006 12:49	40.56	18.8	12.552	816.8	8.7
11/8/2006 12:50	38.48	18.4	12.128	809.9	8.7
11/8/2006 12:51	37.64	19.2	12.719	799.8	8.7
11/8/2006 12:52	38.71	19.6	13.019	830.6	8.7
11/8/2006 12:53	39.18	19.5	13.086	779.7	8.7
11/8/2006 12:54	39.37	19.4	12.941	792.5	8.7
11/8/2006 12:55	39.63	19.5	12.997	790.7	8.7
11/8/2006 12:56	39.67	19.8	13.219	781.8	8.7
11/8/2006 12:57	39.92	19.6	13.153	831.1	8.7
11/8/2006 12:58	40.34	19.5	12.983	812.3	8.7
11/8/2006 12:59	41.95	19.1	12.741	825.5	8.7
11/8/2006 13:00	40.86	18	11.961	820	8.7
11/8/2006 13:01	38.69	18.7	12.351	814.5	8.7
11/8/2006 13:02	39.16	19.4	12.863	813	8.8
11/8/2006 13:03	39.23	19.7	13.153	814.4	8.8
11/8/2006 13:04	39.19	19.5	13.053	840.5	8.8
11/8/2006 13:05	39.85	19.3	12.897	819.8	8.8
11/8/2006 13:06	40.15	19.4	12.986	818	8.8
11/8/2006 13:07	40.15	19.6	13.097	821.3	8.8
11/8/2006 13:08	41.34	19.6	13.035	843.8	8.8
11/8/2006 13:09	42.32	18.6	12.521	810.9	8.8
11/8/2006 13:10	40.29	18.4	12.107	815	8.8
11/8/2006 13:11	39.41	19.4	12.897	807.6	8.8
11/8/2006 13:12	40.5	19.5	13.03	798.8	8.8
11/8/2006 13:13	39.63	19.8	13.186	809	8.8
11/8/2006 13:14	39.46	19.7	13.164	834.4	8.8

HRSO CEMS Data

Date Time	SO21	NOX1	PC1NOXC1	FLO1	CO21
11/8/2006 13:15	39.5	19.1	12.808	835.4	8.8
11/8/2006 13:16	40.33	18.8	12.574	822	8.7
11/8/2006 13:17	40.36	18.7	12.519	839.6	8.7
11/8/2006 13:18	41.25	18.6	12.371	817.3	8.8
11/8/2006 13:19	42.72	18.8	12.399	807.2	8.8
11/8/2006 13:20	41.57	17.5	11.641	798.2	8.8
11/8/2006 13:21	39.46	18.1	11.894	809.2	8.8
11/8/2006 13:22	40.08	18.7	12.361	837.6	8.8
11/8/2006 13:23	41.21	18.8	12.519	804.5	8.8
11/8/2006 13:24	41.91	18.9	12.477	808.5	8.8
11/8/2006 13:25	42.24	18.4	12.202	832.7	8.8
11/8/2006 13:26	43.12	18.3	12.07	816.7	8.8
11/8/2006 13:27	43.22	18.5	12.295	826.7	8.8
11/8/2006 13:28	44.92	18.7	12.427	809.4	8.8
11/8/2006 13:29	45.31	17.9	11.926	828.8	8.8
11/8/2006 13:30	42.86	17.7	11.564	826.7	8.8
11/8/2006 13:31	42.56	18.2	11.993	830.2	8.8
11/8/2006 13:32	44	18.4	12.136	827	8.8
11/8/2006 13:33	44.2	18.4	12.169	814.6	8.8
11/8/2006 13:34	43.23	18.1	11.971	818.2	8.8
11/8/2006 13:35	42.64	18.3	12.048	801.9	8.8
11/8/2006 13:36	41.23	18.3	12.081	827.8	8.8
11/8/2006 13:37	40.8	18.3	12.103	815.9	8.8
11/8/2006 13:38	41.31	18.3	12.194	816.9	8.8
11/8/2006 13:39	42.16	18.1	11.982	813.7	8.8
11/8/2006 13:40	41.73	17	11.184	806.3	8.8
11/8/2006 13:41	40.58	17.7	11.62	794.9	8.8
11/8/2006 13:42	40.64	18.1	12.084	802.8	8.8
11/8/2006 13:43	41.54	18.1	11.994	806.1	8.8
11/8/2006 13:44	42.06	18.1	11.971	819.3	8.8
11/8/2006 13:45	41.61	18	11.872	808.5	8.8
11/8/2006 13:46	41.57	18.1	11.983	814.9	8.8
11/8/2006 13:47	41.66	18.2	12.117	810.7	8.8
11/8/2006 13:48	43.3	18.2	12.06	807.5	8.8
11/8/2006 13:49	44.26	17.4	11.575	796.3	8.8
11/8/2006 13:50	42.23	17.3	11.278	802.3	8.8
11/8/2006 13:51	42.45	18.2	11.961	800.4	8.8
11/8/2006 13:52	43.02	18.5	12.248	837.2	8.8
11/8/2006 13:53	42.4	18.5	12.213	844.4	8.8
11/8/2006 13:54	42.29	18.5	12.224	799.1	8.8

HRSO CEMS Data

Date Time	SO21	NOX1	PC1NOXC1	FLO1	CO21
11/8/2006 13:55	41.8	18.4	12.17	809.1	8.8
11/8/2006 13:56	41.54	18.3	12.115	792.5	8.8
11/8/2006 13:57	41.97	18.5	12.169	804.2	8.8
11/8/2006 13:58	42.44	18.4	12.191	796.2	8.8
11/8/2006 13:59	44.02	18.1	11.982	802.2	8.8
11/8/2006 14:00	42.93	17.2	11.377	799.3	8.8
11/8/2006 14:01	41.56	17.8	11.663	828	8.8
11/8/2006 14:02	41.58	18.2	12.004	819.1	8.8
11/8/2006 14:03	42.33	18.3	12.116	814	8.8
11/8/2006 14:04	42.31	18.1	11.971	811.1	8.8
11/8/2006 14:05	41.91	17.9	11.861	809.2	8.8
11/8/2006 14:06	41.3	18	11.872	809.1	8.8
11/8/2006 14:07	42.6	18	11.905	815.7	8.8
11/8/2006 14:08	44.06	18	11.983	785	8.8
11/8/2006 14:09	45.12	17.5	11.533	803.6	8.8
11/8/2006 14:10	42.57	17.2	11.256	800.3	8.8
11/8/2006 14:11	41.72	18	11.784	818	8.8
11/8/2006 14:12	42.51	18.2	12.049	819.2	8.8
11/8/2006 14:13	42.19	18.3	12.195	796.5	8.8
11/8/2006 14:14	42.06	18.4	12.263	829.9	8.8
11/8/2006 14:15	42.08	18.7	12.394	811	8.8
11/8/2006 14:16	42.14	19	12.639	814	8.8
11/8/2006 14:17	42.18	18.8	12.552	798.8	8.8
11/8/2006 14:18	42.56	18.7	12.552	801.6	8.8
11/8/2006 14:19	43.47	18.5	12.201	811.8	8.8
11/8/2006 14:20	41.88	17.2	11.399	812.6	8.8
11/8/2006 14:21	40.43	17.8	11.696	814.2	8.8
11/8/2006 14:22	41.24	18.5	12.226	817.1	8.8
11/8/2006 14:23	40.22	18.4	12.225	816.5	8.8
11/8/2006 14:24	39.23	18.2	12.07	819.2	8.8
11/8/2006 14:25	38.12	18.2	11.993	826.9	8.8
11/8/2006 14:26	38.21	18.2	12.037	823.7	8.8
11/8/2006 14:27	38.44	18.4	12.125	808.6	8.8
11/8/2006 14:28	38.93	18.1	11.96	798.9	8.8
11/8/2006 14:29	39.53	17.4	11.533	808.2	8.8
11/8/2006 14:30	37.32	16.9	11.058	810.1	8.8
11/8/2006 14:31	36.93	17.5	11.531	798.3	8.8
11/8/2006 14:32	38.3	17.6	11.608	808.6	8.8
11/8/2006 14:33	38.43	17.7	11.696	792.3	8.8
11/8/2006 14:34	37.3	17.8	11.784	805.8	8.8

HRSO CEMS Data

Date Time	SO21	NOX1	PC1NOXC1	FLO1	CO21
11/8/2006 14:35	37.06	18.1	11.983	818.9	8.8
11/8/2006 14:36	37.24	18.1	11.993	819.2	8.8
11/8/2006 14:37	37.35	17.9	11.839	820.8	8.8
11/8/2006 14:38	38.05	18	11.906	818.8	8.8
11/8/2006 14:39	39.37	18.1	11.927	822.2	8.8
11/8/2006 14:40	38.22	17.2	11.421	813.4	8.8
11/8/2006 14:41	36.17	17.8	11.641	788.3	8.8
11/8/2006 14:42	37.2	18.3	12.092	818.1	8.8
11/8/2006 14:43	37.6	18.3	12.103	806.1	8.8
11/8/2006 14:44	37.14	18.2	12.037	814.3	8.8
11/8/2006 14:45	36.75	18.3	12.07	821.4	8.8
11/8/2006 14:46	36.48	18.7	12.334	797	8.8
11/8/2006 14:47	36.09	18.6	12.279	801.9	8.8
11/8/2006 14:48	37.23	18.5	12.257	798.5	8.8
11/8/2006 14:49	38.21	17.8	11.818	812.1	8.8
11/8/2006 14:50	36	17.1	11.223	801.6	8.8
11/8/2006 14:51	34.81	17.7	11.674	797.8	8.8
11/8/2006 14:52	36.21	17.8	11.729	810	8.8
11/8/2006 14:53	36.79	17.8	11.718	826.4	8.8
11/8/2006 14:54	36.57	17.8	11.751	810.7	8.8
11/8/2006 14:55	36.16	17.7	11.674	794.8	8.8
11/8/2006 14:56	36.17	17.5	11.575	770.8	8.8
11/8/2006 14:57	36.31	17.6	11.641	805.7	8.8
11/8/2006 14:58	37.12	17.8	11.74	816.3	8.8
11/8/2006 14:59	38.99	18	11.795	818	8.8
11/8/2006 15:00	39.08	16.9	11.224	823.1	8.8
11/8/2006 15:01	37.88	17.6	11.509	802	8.8
11/8/2006 15:02	38.33	17.9	11.828	803.5	8.8
11/8/2006 15:03	39.31	18.3	12.037	806.1	8.8
11/8/2006 15:04	38.93	18.1	11.949	798.3	8.8
11/8/2006 15:05	38.15	18.1	11.971	815.4	8.8
11/8/2006 15:06	37.59	18.3	12.049	816.8	8.8
11/8/2006 15:07	37.29	18.4	12.172	805.5	8.8
11/8/2006 15:08	38.37	18.5	12.202	786.2	8.8
11/8/2006 15:09	38.74	17.8	11.708	795.3	8.8
11/8/2006 15:10	36.46	17.2	11.256	803.4	8.8
11/8/2006 15:11	35.3	18.1	11.905	811.4	8.8
11/8/2006 15:12	35.54	18.1	11.949	831.4	8.8
11/8/2006 15:13	36.37	17.9	11.817	787.7	8.8
11/8/2006 15:14	37.29	17.9	11.817	806.4	8.8

HRSO CEMS Data

Date Time	SO21	NOX1	PC1NOXC1	FLO1	CO21
11/8/2006 15:15	37.49	18	11.85	801	8.8
11/8/2006 15:16	37.15	18.2	12.004	798.3	8.8
11/8/2006 15:17	36.93	18.2	12.048	807.3	8.8
11/8/2006 15:18	37.43	18.4	12.158	796	8.8
11/8/2006 15:19	38.53	17.9	11.807	821.6	8.8
11/8/2006 15:20	38.19	16.8	11.159	821.2	8.8
11/8/2006 15:21	36.84	17.2	11.256	817.3	8.8
11/8/2006 15:22	37.65	17.5	11.542	810.6	8.8
11/8/2006 15:23	39.09	17.8	11.696	806	8.8
11/8/2006 15:24	39.25	17.9	11.817	805.2	8.8
11/8/2006 15:25	38.51	17.8	11.718	826.2	8.8
11/8/2006 15:26	38.05	17.9	11.795	829.4	8.8
11/8/2006 15:27	38.5	18.1	11.916	788.8	8.8
11/8/2006 15:28	39.58	18.1	11.927	819.9	8.8
11/8/2006 15:29	40.3	17.6	11.653	808.9	8.8
11/8/2006 15:30	37.98	17	11.179	838.9	8.8
11/8/2006 15:31	37.45	17.8	11.707	827.3	8.8
11/8/2006 15:32	38.23	18.4	12.048	828.7	8.8
11/8/2006 15:33	38.75	18.5	12.246	829.3	8.8
11/8/2006 15:34	38.38	18.4	12.18	830	8.8
11/8/2006 15:35	38.8	18.2	12.004	828.1	8.8
11/8/2006 15:36	37.69	18.4	12.147	823	8.8

APPENDIX B

SULFURIC ACID MIST TEST DATA – IGCC

FIELD DATA SHEETS

Isokinetic Field Data Sheet - EPA Method

Client TECO - Polk Power station Run Number 3
 City/State Polk County, FL Date 11/08/06
 Sampling Location Unit #1 Operators J.S. JTD

Bar. Press., In. Hg 29.65 NOMOGRAPH SET-UP: K Factor 0.3075 LEAK CHECKS
 Static Press., In. H₂O -0.50 ΔH @ 1.74 y = 1.04 Avg. Δ P 1.45 Pre-Test 0.002 @ 1.5 In. Hg.
 Meter Box No. 300 200 Meter Temp. 84 Ref. Δ P _____ Post-Test 0.001 @ 4.5 In. Hg.
 Sample Box No. 11 Stack Temp. 331 Desired Nozzle 0.21 Pre-Test Pitot <0.1 @ 4.6 In. H₂O
 Probe/Pitot No. 300 10920 Pitot Coeff. 0.84 Nozzle No. 300.038 Post-Test Pitot <0.1 @ 4.4 In. H₂O
 Probe Temp. Setting 250 % Moisture 5 Nozzle Calibration 185 185 185
 Sample ID No. 613- C Factor _____ Nozzle Diameter 0.185 Observer R. Reich
 Filter No. _____ Start Time 1435/1430 End Time 1540 Agency FDEP

Sample Point	Clock Time	Dry Gas Meter Cubic Feet	Pitot Reading Δ P In. H ₂ O	Orifice Setting ΔH Inches H ₂ O		Dry Gas Meter Temp. °F	Pump Vacuum Inches Hg	Stack Temp °F	Probe Temp °F	Filter Box °F	Imp. Temp °F
				Ideal	Actual						
A1	0	133.00	1.50	1.12	1.10	74	3	331	250		60
2	2.5	134.51	1.50	1.12	1.10	74	3	331	250		55
3	5	136.00	1.50	1.12	1.10	76	3	332	251		52
4	7.5	137.50	1.60	1.20	1.20	77	3	331	251		53
5	10	139.00	1.60	1.20	1.20	78	3	332	252		53
6	12.5	140.45	1.50	1.12	1.10	79	3	330	250		54
B1	15	141.51	1.50	1.12	1.10	78	3	331	250		60
2	17.5	142.81	1.40	1.05	1.05	80	3	330	250		54
3	20	144.79	1.40	1.05	1.05	80	3	331	250		51
4	22.5	146.11	1.40	1.05	1.05	80	3	331	252		51
5	25	147.58	1.40	1.05	1.05	80	3	331	246		52
6	27.5	149.00	1.40	1.05	1.05	80	3	331	247		51
C1	30	150.25	1.40	1.05	1.05	80	3	330	254		56
2	32.5	151.70	1.50	1.10	1.10	81	3	330	247		56
3	35	153.00	1.50	1.10	1.10	81	3	331	248		53
4	37.5	154.56	1.50	1.10	1.10	81	3	332	246		53
5	40	156.14	1.60	1.20	1.20	81	3	333	249		54
6	42.5	157.46	1.60	1.20	1.20	81	3	333	247		25
D1	45	158.93	1.50	1.10	1.10	80	3	330	243		57
2	47.5	160.42	1.50	1.10	1.10	79	3	331	243		54
3	50	161.88	1.50	1.10	1.10	80	3	332	252		54
4	52.5	163.35	1.50	1.10	1.10	79	3	332	253		55
5	55	164.81	1.60	1.20	1.20	81	3	330	248		56
6	57.5	166.11	1.40	1.05	1.05	80	3	330	239		57
	60	167.734									
		34.654	1.492	1.106		79.2		331.1			

Comments: _____

Isokinetic Check: _____

Audited by: B Date: 11/9/06



**EPA Methods 4 and 8 - Moisture Determination
and Sample Recovery - Data Analysis**

Client Name TECO
 City/State Polk County, FL
 Sampling Location Unit #1
 Clean-Up Box Number 2758
 Chain of Custody: Date Received 11/8/06

Project Number 046-06-113
 Sample Date 11/08/06
 Samples Recovered By WAB
 Recovery Date 11/08/06
 Received By TECO Locked?

Equipment Documentation

Run Number	1	2	3
Sample ID Number	6113-01	6113-02	6113-03
Sample Box Number	11	11	11
Probe Number	200.109	200.109	200.109

Analysis of Moisture and Sample Recovery - Sulfuric Acid

Reagent Recovery Container #	6113-01	6113-02	6113-03
Impinger Absorbing Solution	80% Isopropanol		
Description of Reagent	Clear, foam	Clear	Clear
Reagent Level Marked?	✓	✓	✓
Final Volume, ml	55	53	67
Initial Volume, ml	100	100	100
Net Condensed Volume, ml	-45	-47	-33
80% Isopropanol Rinse?	✓	✓	✓
Dilute to 250 ml in Isopropanol?	✓	✓	✓

Analysis of Moisture and Sample Recovery - Sulfur Dioxide

Reagent Recovery Container #	6113-01	6113-02	6113-03
Impinger Absorbing Solution	3% H ₂ O ₂		
Description of Reagent	Clear	Clear	Clear
Reagent Level Marked?	✓	✓	✓
Final Volume, ml	240	240	240
Initial Volume, ml	200	200	200
Net Condensed Volume, ml	60	60	60
Distilled Water Rinse?	✓	✓	✓
Dilute to 1000 ml in DI Water?	✓	✓	✓

Analysis of Moisture Recovery

Silica Gel Recovery Container #	1	2	3
Percent Silica Gel Spent	40	40	40
Final Weight, g	215.2	219.0	214.1
Initial Weight, g	200	200	200
Net Absorbed Water, g	15.2	19.0	14.1
Total Moisture Collected, ml	30.20 ✓	30.0 ✓	41.10 ✓

Reagent Blanks

Absorbing Reagent Blank	80% Isopropanol	Rinsing Reagent Blank	
Absorbing Blank Identification #	6113-04	Rinsing Blank Identification #	
Absorbing Reagent Blank	3% H ₂ O ₂	Rinsing Reagent Blank	
Absorbing Blank Identification #	6113-04	Rinsing Blank Identification #	



CALCULATED DATA



40 CFR 60, Appendix A - Test Methods
Reference Method 8
Test Calculations

Customer: Polk Power Station
Facility: IGCC - HRSG
Sampling Location: Stack
Operating Conditions: Full Load
Run Number: 1
Date: 11/08/06

Sample Time, θ :	60 minutes	Nozzle Diameter, D_n :	0.185 inches
Barometric Pressure, P_b :	29.65 "Hg	Nozzle Area, A_n :	0.0001867 ft ²
Stack Pressure, P_s :	29.61 "Hg	Average Orifice Meter, ΔH :	1.144 "H ₂ O
Effective Stack Area, A_s :	283.529 ft ²	Sample Volume, V_m :	35.244 ft ³
Pitot Coefficient, C_p :	0.84 dimensionless	Average Meter Temp., T_m :	74.9 °F
Gas Analysis:	8.7 % CO ₂	Average Stack Temp., T_s :	330.4 °F
	12.3 % O ₂	Average $\sqrt{\Delta p}$:	1.243 "H ₂ O
	0.0 % CO	Condensate Volume, V_{lc} :	30.2 ml
	79.0 % N ₂	Meter Box Y:	1.040 dimensionless

Data Calculated from Source Measurements:

$V_{w(std)} = 4.714E-02 \times V_{lc}$	1.424 scf
$V_{m(std)} = 17.647 \times V_m \times Y \times (P_b + (\Delta H / 13.6)) / (T_m + 460)$	35.955 dscf
$B_{ws} = V_{w(std)} / (V_{m(std)} + V_{w(std)})$	0.038 %
$FDA = 1.0 - B_{ws}$	0.962 %
$M_d = (0.44 \times \%CO_2) + (0.32 \times \%O_2) + (0.28 \times (\%N_2 + \%CO))$	29.88 lb./lb. mole
$M_s = (M_d \times FDA) + (18.0 \times B_{ws})$	29.43 lb./lb. mole
$v_s = 85.49 \times C_p \times (\sqrt{\Delta p}) \times (\sqrt{(T_s + 460)} / (M_s \times P_s))$	85.01 ft/second
$Q_s = v_s \times A_s \times 60$	1446136.6 acf/minute
$Q_{s(std)} = Q_s \times FDA \times (528 / (T_s + 460)) \times (P_s / 29.92)$	919750.9 dscf/minute
$I = (T_s + 460) \times ((2.67E-03 \times V_{lc}) + (V_{m(std)} / 17.647)) \times 100 / (\theta \times P_s \times A_n \times v_s \times 60)$	99.0 %

Data from Laboratory Analysis:

H₂SO₄

Normality of Barium Chloride titrant, N	0.00975
Volume Titrant Blank, V_{tb}	0.1
Volume Titrant Sample, V_t	500
Volume of Sample Aliquot, V_a	50
Total Volume of Solution, V_{soln}	1.35

Calculated Concentration and Emission Rate Data:

$C_{H_2SO_4} = 1.081E-04 \times (N \times (V_t - V_{tb}) \times (V_{soln} / V_a)) / V_{m(std)}$	= 3.957E-07 lb/dscf
$F_c\text{-factor} =$	2310 dscf/mmBtu
$E_{H_2SO_4} = C_{H_2SO_4} \times F_c\text{-factor} \times (100/\%CO_2)$	= 0.01053 lb/mmBtu
$E_{H_2SO_4} = C_{H_2SO_4} \times Q_{s(std)} \times 60$	= 21.8344 lb/hr



40 CFR 60, Appendix A - Test Methods
Reference Method 8
Test Calculations

Customer: Polk Power Station
Facility: IGCC - HRSG
Sampling Location: Stack
Operating Conditions: Full Load
Run Number: 2
Date: 11/08/06

Sample Time, θ :	60 minutes	Nozzle Diameter, D_n :	0.185 inches
Barometric Pressure, P_b :	29.65 "Hg	Nozzle Area, A_n :	0.00018666 ft ²
Stack Pressure, P_s :	29.61 "Hg	Average Orifice Meter, ΔH :	1.075 "H ₂ O
Effective Stack Area, A_s :	283.529 ft ²	Sample Volume, V_m :	34.312 ft ³
Pitot Coefficient, C_p :	0.84 dimensionless	Average Meter Temp., T_m :	81.4 °F
Gas Analysis:	8.5 % CO ₂	Average Stack Temp., T_s :	331.3 °F
	12.4 % O ₂	Average $\sqrt{\Delta p}$:	1.202 "H ₂ O
	0.0 % CO	Condensate Volume, V_c :	32.0 ml
	79.1 % N ₂	Meter Box Y:	1.040 dimensionless

Data Calculated from Source Measurements:

$V_{w(std)} = 4.714E-02 \times V_{lc}$	1.508 scf
$V_{m(std)} = 17.647 \times V_m \times Y \times (P_b + (\Delta H / 13.6)) / (T_m + 460)$	34.578 dscf
$B_{ws} = V_{w(std)} / (V_{m(std)} + V_{w(std)})$	0.042 %
$FDA = 1.0 - B_{ws}$	0.958 %
$M_d = (0.44 \times \%CO_2) + (0.32 \times \%O_2) + (0.28 \times (\%N_2 + \%CO))$	29.85 lb./lb. mole
$M_s = (M_d \times FDA) + (18.0 \times B_{ws})$	29.36 lb./lb. mole
$v_s = 85.49 \times C_p \times (\sqrt{\Delta p}) \times (\sqrt{(T_s + 460)} / (M_s \times P_s))$	82.37 ft/second
$Q_s = v_s \times A_s \times 60$	1401205.4 acf/minute
$Q_{s(std)} = Q_s \times FDA \times (528 / (T_s + 460)) \times (P_s / 29.92)$	886657.5 dscf/minute
$I = (T_s + 460) \times ((2.67E-03 \times V_c) + (V_{m(std)} / 17.647)) \times 100 / (\theta \times P_s \times A_n \times v_s \times 6)$	98.7 %

Data from Laboratory Analysis:

	H ₂ SO ₄
Normality of Barium Chloride titrant, N	0.00975
Volume Titrant Blank, V_{tb}	0.1
Volume Titrant Sample, V_t	500
Volume of Sample Aliquot, V_a	50
Total Volume of Solution, V_{soln}	2

Calculated Concentration and Emission Rate Data:

$C_{H_2SO_4} = 1.081E-04 \times (N \times (V_t - V_{tb}) \times (V_{soln} / V_a)) / V_{m(std)}$	6.095E-07 lb/dscf
$F_c\text{-factor} =$	2310 dscf/MMBtu
$E_{H_2SO_4} = C_{H_2SO_4} \times F_c\text{-factor} \times (100/\%CO_2) =$	0.01660 lb/MMBtu
$E_{H_2SO_4} = C_{H_2SO_4} \times Q_{s(std)} \times 60 =$	32.4251 lb/hr



40 CFR 60, Appendix A - Test Methods
Reference Method 8
Test Calculations

Customer: Polk Power Station
Facility: IGCC - HRSG
Sampling Location: Stack
Operating Conditions: Full Load
Run Number: 3
Date: 11/08/06

Sample Time, θ :	60 minutes	Nozzle Diameter, D_n :	0.185 inches
Barometric Pressure, P_b :	29.65 "Hg	Nozzle Area, A_n :	0.00018666 ft ²
Stack Pressure, P_s :	29.61 "Hg	Average Orifice Meter, ΔH :	1.106 "H ₂ O
Effective Stack Area, A_s :	283.529 ft ²	Sample Volume, V_m :	34.634 ft ³
Pitot Coefficient, C_p :	0.84 dimensionless	Average Meter Temp., T_m :	79.2 °F
Gas Analysis:	8.5 % CO ₂	Average Stack Temp., T_s :	331.1 °F
	12.3 % O ₂	Average $\sqrt{\Delta p}$:	1.221 "H ₂ O
	0.0 % CO	Condensate Volume, V_{lc} :	41.1 ml
	79.2 % N ₂	Meter Box Y:	1.040 dimensionless

Data Calculated from Source Measurements:

$V_{w(std)} = 4.714E-02 \times V_{lc}$	1.937 scf
$V_{m(std)} = 17.647 \times V_m \times Y \times (P_b + (\Delta H / 13.6)) / (T_m + 460)$	35.051 dscf
$B_{ws} = V_{w(std)} / (V_{m(std)} + V_{w(std)})$	0.052 %
$FDA = 1.0 - B_{ws}$	0.948 %
$M_d = (0.44 \times \%CO_2) + (0.32 \times \%O_2) + (0.28 \times (\%N_2 + \%CO))$	29.86 lb./lb. mole
$M_s = (M_d \times FDA) + (18.0 \times B_{ws})$	29.24 lb./lb. mole
$v_s = 85.49 \times C_p \times (\sqrt{\Delta p}) \times (\sqrt{(T_s + 460)} / (M_s \times P_s))$	83.82 ft/second
$Q_s = v_s \times A_s \times 60$	1425842.8 acf/minute
$Q_{s(std)} = Q_s \times FDA \times (528 / (T_s + 460)) \times (P_s / 29.92)$	892568.9 dscf/minute
$I = (T_s + 460) \times ((2.67E-03 \times V_{lc}) + (V_{m(std)} / 17.647)) \times 100 / (\theta \times P_s \times A_n \times v_s \times 6)$	99.4 %

Data from Laboratory Analysis:

	H ₂ SO ₄
Normality of Barium Chloride titrant, N	0.00975
Volume Titrant Blank, V_{tb}	0.1
Volume Titrant Sample, V_t	500
Volume of Sample Aliquot, V_a	50
Total Volume of Solution, V_{soln}	1.9

Calculated Concentration and Emission Rate Data:

$C_{H_2SO_4} = 1.081E-04 \times (N \times (V_t - V_{tb}) \times (V_{soln} / V_a)) / V_{m(std)}$	= 5.712E-07 lb/dscf
$F_c\text{-factor} =$	2310 dscf/MMBtu
$E_{H_2SO_4} = C_{H_2SO_4} \times F_c\text{-factor} \times (100/\%CO_2)$	= 0.01548 lb/MMBtu
$E_{H_2SO_4} = C_{H_2SO_4} \times Q_{s(std)} \times 60$	= 30.5909 lb/hr

LABORATORY ANALYSIS



Laboratory Services

5012 Causeway Blvd * Tampa Fl. 33619 * Ph (813)630-7378 * Fax (813)630-7360 * DOH #E54272

Report For:

Report Date: 12/14/2006

Laboratory ID: AA85644

Location Code: TE_PPS_1_SAM_SYNGAS

Sample Information

Description: Polk No. 1 Acid Mist Comp on Syngas

Sampled By:

Project Account Code:

Date and Time Collected: 11/9/2006 12:00:00 AM

Sample Collection Method:

Date of Sample Receipt: 11/9/2006

Laboratory Results

PARAMETER	Result	Units	MDL	Qualifier Code	Test Method	Analyst	Analysis Date & Time	Lower Limit	Upper Limit	Violation Check
Normality of BaCl2 * 2H2O	0.00975		0.0001			MM	11/8/2006 11:00:00 AM			
SO3 emission rate, lbs/hr	28	lbs/hr			EPA - RM8	RAM	12/14/2006 10:56:00 AM			
SO3, Avg. of Blank Titrations	0.1	milliliters	0.01		EPA - Meth.8	MM	11/8/2006 11:00:00 AM			
SO3, Run #1, Avg. of Titrations	1.35	milliliters	0.01		EPA - Meth.8	MM	11/8/2006 11:00:00 AM			
SO3, Run #2, Avg. of Titrations	2.0	milliliters	0.01		EPA - Meth.8	MM	11/8/2006 11:00:00 AM			
SO3, Run #3, Avg. of Titrations	1.9	milliliters	0.01		EPA - Meth.8	MM	11/8/2006 11:00:00 AM			
SO3, Volume of Contained Sample	500	milliliters	1		EPA - Meth.8	MM	11/8/2006 11:00:00 AM			
SO3, Volume of Sample Aliquot	50	milliliters	0.1		EPA - Meth.8	MM	11/8/2006 11:00:00 AM			

Comments

All results calculated on a wet to wet basis, unless otherwise indicated.

Data Qualifier Codes Explanation:

Subcontracted Laboratories:

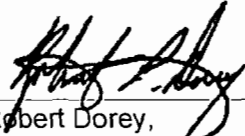

Robert Dorey,
Manager, Laboratory Services

CALIBRATION DATA

Meter Console Information

Console Number	300.200
Dry Gas Meter Number	7811505
Calibration Date:	10/25/2006
Expiration Date:	10/25/2007

Calibration Condition

Time	
Barometric Pressure (P _b)	29.18
Calibration Technician	S. Margus
Wet Test Meter ID	11088.00
Wet Test Meter Verification Date	8/1/2006

Pass Positive Leak Check?	Yes
Pass Negative Leak Check?	Yes

DGM Orifice Setting (P _m)	Vacuum Setting (2-4 in Hg)	Console Meter						Wet Test Meter						Run Elapsed minutes
		Meter Initial Volume (V _{di})	Meter Final Volume (V _{df})	Sample Volume (V _m)	Outlet Temp. Initial (T _{di})	Outlet Temp. Final (T _{df})	Outlet Temp. Average (T _a)	Wet Test Initial Volume (V _{wi})	Wet Test Final Volume (V _{wf})	Wet Test Volume (V _w)	Wet Test Temp. Initial (T _{wi})	Wet Test Temp. Final (T _{wf})	Wet Test Temp. Average (T _{wa})	
in H ₂ O	in Hg	cubic feet	cubic feet	cubic feet	°F	°F	°F	cubic feet	cubic feet	cubic feet	°F	°F	°F	minutes
0.5	3.0	0	4.945	4.945	76	76	76.0	0	5	5.000	68	68	68.0	12.32
1.0	3.3	0	7.834	7.834	80	76	78.0	0	8	8.000	68	68	68.0	13.7
1.5	3.0	0	9.63	9.630	68	78	73.0	0	10	10.000	68	68	68.0	14.17
2.0	3.0	0	30.403	30.403	80	88	84.0	0	31	31.000	68	68	68.0	39
3.0	3.0	0	11.316	11.316	85	90	87.5	0	11.51	11.510	68	68	68.0	12
4.0	3.0	0	9.834	9.834	90	91	90.5	0	10	10.000	68	68	68.0	9.1

DGM Orifice Setting (P _m)	DGM Factor γ	DGM Factor Δγ	Orifice Meter ΔH _{or}	Orifice Meter ΔΔH _{or}
in H ₂ O			in. H ₂ O	in. H ₂ O
0.5	1.025	-0.016	1.715	-0.029
1	1.038	-0.004	1.651	-0.093
1.5	1.044	0.003	1.711	-0.033
2	1.045	0.004	1.762	0.018
3	1.047	0.005	1.804	0.059
4	1.050	0.008	1.822	0.078

1.042 γ Average 1.744 ΔH_{or} Average

Meter Box Thermocouple Calibration.

Test Points	30	50	75	90	120
Reading	31	51	75	90	120

$$\gamma = V_w * P_b * (T_d + 460) / V_d * (P_s - \Delta H / 13.6) * (T_w + 460)$$

$$\Delta H_{or} = ((0.0319 * \Delta H) / (P_b * (T_d + 460))) * (((T_w - 460) * 0) / V_w)^2$$

Note: For Calibration Factor γ, the ratio of the calibration meter to dry gas meter, acceptable tolerance of individual values from the average is ±0.02

Note: For ΔH_{or}, orifice pressure differential that equates to 0.75 Lfm (0.0212 m³/min) at standard temperature and pressure.

acceptable tolerance of individual values from the average is ±0.2 inches (5.1mm) H₂O

APPENDIX C

SULFURIC ACID MIST TEST DATA – SULFURIC ACID PLANT

FIELD DATA SHEETS

ISOKINETIC FIELD DATA SHEET

Plant: Pulke
 Location: Acid Plant
 Date: 11-8-06
 Method No.: 8
 Box Operator: DAS
 Probe Operator: SAU
 Time - Start: 10:35 End: 11:49
 Sampling Time: 64 M
 Min. Pt.: 4 M
 Meter Box No.: PYRO 1007
 Pyrometer No.: PY10
 Barometer No.:
 Meter Cal. (ΔH): 1.647
 Meter Cal. (ΔY): 1.000

Run No.: 1
 Nozzle I.D. No.: 73
 Nozzle Diameter: .505
 Pitot Tube No.: 05125
 Pitot Tube (C_p): .84
 Probe Length: 9'
 Probe Liner Material: Glass
 Pressure: Pb (Hg): 29.81 Pp (H₂O): 0.5
 Assumed Moisture (%): 0.0%
 Filter Holder No.:
 Comments:
 Start Imp#1 Imp#2 Imp#3
 Finish Imp#1 Imp#2 Imp#3
 O₂ 6 CO₂ 26

Dry Gas Meter Volume
 Final: 632.584 Ft.³
 Initial: 580.401 Ft.³
 Net: 52.183 Ft.³

Equipment Leak Checks
 Initial: 0 CFM @ 10 "Hg
 Final: 0 CFM @ 12 "Hg
 Pitot Tube: "H₂O

Moisture Determination
 Impinger: 51.1 ml
 Silica Gel: 20.9 gm
 Total: 71.9

Part A
 2
 3
 4
 5
 6
 7
 8

Part B
 1
 2
 3
 4
 5
 6
 7
 8

Traverse Point No.	Clock Time	Gas Sample Volume (Ft ³)	Stack Temp. Ts (F)	Meter Temp. (F)	ΔH (In. H ₂ O)	ΔY (In. H ₂ O)	Probe Temp. (F)	Filter Box Temp. Tm (F)	Last Imp. Temp. (F)	Vacuum (In. Hg)
1	10:35	583.5	158	69	.04	2.19	185	216	68	9
2		587.0	164	71	.048	2.26	209	202	68	12
3		590.0	165	71	.035	1.70	195	207	68	10
4		573.1	168	71	.043	2.03	207	186	68	9
5		576.4	168	71	.054	2.92	209	185	68	12
6		577.8	164	71	.043	2.34	207	185	68	11
7		603.5	164	71	.052	2.83	210	174	67	12
8	11:09	606.5	164	71	.047	2.56	209	173	67	12
1	11:17	609.7	161	68	.045	2.45	218	217	68	8.5
2		613.1	162	69	.049	2.67	216	224	69	12
3		616.4	164	70	.051	2.77	215	234	68	12
4		619.9	164	70	.043	2.34	214	236	68	11
5		622.9	164	69	.036	1.75	207	220	67	9
6		626.4	164	69	.044	2.39	208	206	68	10
7		629.4	163	69	.040	2.15	210	203	68	9.5
8	11:49	632.584	160	69	.038	2.08	210	199	66	9

Quality Assurance / Quality Control Information

Console Operator Signature: [Signature] Date: 11-8-06
 Complete: Legible: Accurate: Project Set: Reasonableness:
 Reviewer's Signature: [Signature] Title: _____ Date: _____

ISOKINETIC FIELD DATA SHEET

Plant: Polk
 Location: Acid Plant
 Date: 11-8-06
 Method No.: 8
 Box Operator: DB
 Probe Operator: SM
 Time - Start: 12:37 End: 14:07
 Sampling Time: 64
 Min. Pt.: 4
 Meter Box No.: PYD 1607
 Pyrometer No.: PYD
 Barometer No.:
 Meter Cal. (ΔH): 1.647
 Meter Cal. (ΔY): 1.000

Run No.: 2
 Nozzle I.D. No.: 74
 Nozzle Diameter: .374
 Pilot Tube No.: 00125
 Pilot Tube (C.): .84
 Probe Length: 9'
 Probe Liner Material:
 Pressure: Pb ("Hg): 28.7 Pg ("H₂O): 5
 Assumed Moisture (%): 0.0
 Filter Holder No.:
 Comments:
 Start Imp#1 Imp#2 Imp#3
 Finish Imp#1 Imp#2 Imp#3
 O₂: 6 CO₂: 26

Dry Gas Meter Volume
 Final: 666.131 Ft.³
 Initial: 633.235 Ft.³
 Net: 32.896 Ft.³

Equipment Leak Checks
 Initial: 0 CFM @ 14 "Hg
 Final: 0 CFM @ 10 "H₂O
 Pitot Tube: "H₂O

Moisture Determination
 Impinger: 48 ml
 Silica Gel: 11.3 gm
 Total: 59.3

Stepped
 on point
 4.

Traverse Point No.	Clock Time	Gas Sample Volume (Ft ³)	Stack Temp. Ts (°F)	Meter Temp. (°F)	ΔH (In. H ₂ O)	ΔH (In. H ₂ O)	Probe Temp. (°F)	Filter Box Temp. Tm (°F)	Last Imp. Temp. (°F)	Vacuum (In. Hg)
1	12:37	635.2	160	68	.047	.77	203	187	68	5
2		637.7	161	68	.044	2.37	201	204	67	8
3		648.4	164	70	.047	2.55	204	200	68	11
4	12:54	644.4	164	70	.039	0.64	204	200	68	10
5	13:05	646.3	164	71	.049	0.80	213	157	68	4
6		648.3	162	70	.051	.84	205	154	68	4
7		650.1	161	70	.053	.87	203	160	68	4
8	13:26	652.0	160	69	.047	.77	163	204	67	4
1	13:25	653.9	160	69	.048	.77	219	197	68	4
2		655.7	163	69	.043	.70	218	204	68	4
3		657.5	164	69	.042	.69	220	207	69	4
4		659.2	164	69	.039	.64	214	200	68	4
5		660.8	165	69	.036	.57	214	204	68	4
6		662.4	161	69	.045	.74	215	197	68	4
7		664.4	159	69	.036	.57	214	184	68	4
8	14:07	666.1	160	69	.036	.57	214	184	68	4

Quality Assurance / Quality Control Information

Console Operator Signature: [Signature] Date: 11-8-06
 Complete: Legible: Accurate: Project Scope: Reasonableness:
 Reviewer's Signature: [Signature] Title: _____ Date: _____

ISOKINETIC FIELD DATA SHEET

Plant: Polk
 Location: Acid Plant
 Date: 11-8-06
 Method No.: 8
 Box Operator: DAS
 Probe Operator: SAV
 Time - Start: 14:35 End: 15:46
 Sampling Time (Min.): 4
 Meter Box No.: P410 1007
 Pyrometer No.: PV10
 Barometer No.:
 Meter Cal. (ΔH): 1.647
 Meter Cal. (ΔY): 1.000

Run No.: 3
 Nozzle I.D. No.: 73
 Nozzle Diameter: .605
 Pitot Tube No.: 00125
 Pitot Tube (C_p): 84
 Probe Length: 9'
 Probe Liner Material:
 Pressure: Pb ("Hg): 29.8 Pg ("H₂O): .5
 Assumed Moisture (%): 0.0
 Filter Holder No.:
 Comments:
 Start Imp#1: Imp#2: Imp#3:
 Finish Imp#1: Imp#2: Imp#3:
 O₂: 6 CO₂: 26

Dry Gas Meter Volume
 Final: 720.130 Ft.³
 Initial: 666.325 Ft.³
 Net: 53.805 Ft.³
 Equipment Leak Checks
 Initial: 0 CFM @ 14 "Hg
 Final: 0 CFM @ 14 "H₂O
 Pitot Tube: "H₂O
 Moisture Determination
 Impinger: 49 ml
 Silica Gel: 16.3 gm
 Total: 65.3

Traverse Point No.	Clock Time	Gas Sample Volume (Ft ³)	Stack Temp. Ts (°F)	Meter Temp. (°F)	Δ (In. H ₂ O)	Δ H (In. H ₂ O)	Probe Temp. (°F)	Filter Box Temp. Tm (°F)	Last Imp. Temp. (°F)	Vacuum (In. Hg)
1	14:35	669.8	164	69	.048	2.60	191	159	69	13
2		673.1	163	69	.046	2.50	197	169	67	13
3		676.5	165	69	0.050	2.71	201	197	67	13
4		679.75	165	69	.040	2.17	206	194	69	11
5		683.16	164	69	.049	2.64	199	165	68	12
6		686.6	164	69	.051	2.77	196	164	68	14
7		690.7	161	69	.056	3.05	197	165	68	15
8	14:07	693.7	161	69	.053	2.87	197	165	68	14
1	15:13	707.1	140	67	.048	2.61	190	201	68	13
2		700.78	164	67	.051	2.76	187	223	68	13
3		704.2	163	67	.047	2.54	186	215	68	13
4		707.67	164	67	.046	2.49	186	209	66	13
5		710.765	164	69	.036	1.95	187	184	68	10
6		713.81	162	69	.038	2.07	187	182	69	10
7		716.96	160	69	.040	2.18	187	180	66	11
8	15:46	720.130	158	69	.037	2.03	187	184	66	10

Quality Assurance / Quality Control Information

Console Operator Signature: [Signature] Date: 11-8-06
 Complete: Legible: Accurate: Project Set: Reasonableness:
 Reviewer's Signature: [Signature] Title: _____ Date: _____

CALCULATED DATA



40 CFR 60, Appendix A - Test Methods
Reference Method 8
Test Calculations

Customer: Polk Power Station
Facility: Acid Plant
Sampling Location: Stack
Operating Conditions: Full Load
Run Number: 1
Date: 11/08/06

Sample Time, θ :	64 minutes	Nozzle Diameter, D_n :	0.505 inches
Barometric Pressure, P_b :	29.80 "Hg	Nozzle Area, A_n :	0.00139086 ft ²
Stack Pressure, P_s :	29.84 "Hg	Average Orifice Meter, ΔH :	2.407 "H ₂ O
Effective Stack Area, A_s :	28.274 ft ²	Sample Volume, V_m :	52.183 ft ³
Pitot Coefficient, C_p :	0.84 dimensionless	Average Meter Temp., T_m :	70.0 °F
Gas Analysis:	26.0 % CO ₂	Average Stack Temp., T_s :	163.7 °F
	6.0 % O ₂	Average $\sqrt{\Delta p}$:	0.210 "H ₂ O
	0.0 % CO	Condensate Volume, V_c :	71.9 ml
	68.0 % N ₂	Meter Box Y:	1.002 dimensionless

Data Calculated from Source Measurements:

$V_{w(std)} = 4.714E-02 \times V_c$	3.389 scf
$V_{m(std)} = 17.647 \times V_m \times Y \times (P_b + (\Delta H / 13.6)) / (T_m + 460)$	52.189 dscf
$B_{ws} = V_{w(std)} / (V_{m(std)} + V_{w(std)})$	0.061 %
$FDA = 1.0 - B_{ws}$	0.939 %
$M_d = (0.44 \times \%CO_2) + (0.32 \times \%O_2) + (0.28 \times (\%N_2 + \%CO))$	32.40 lb./lb. mole
$M_s = (M_d \times FDA) + (18.0 \times B_{ws})$	31.52 lb./lb. mole
$v_s = 85.49 \times C_p \times (\sqrt{\Delta p}) \times (\sqrt{T_s + 460}) / (M_s \times P_s)$	12.28 ft/second
$Q_s = v_s \times A_s \times 60$	20828.4 acf/minute
$Q_{s(std)} = Q_s \times FDA \times (528 / (T_s + 460)) \times (P_s / 29.92)$	16511.5 dscf/minute
$I = (T_s + 460) \times ((2.67E-03 \times V_c) + (V_{m(std)} / 17.647)) \times 100 / (\theta \times P_s \times A_n \times v_s \times 60)$	100.4 %

Data from Laboratory Analysis:

H₂SO₄

Normality of Barium Chloride titrant, N	0.00975
Volume Titrant Blank, V_{tb}	0.1
Volume Titrant Sample, V_t	500
Volume of Sample Aliquot, V_a	50
Total Volume of Solution, V_{soln}	3.45

Calculated Concentration and Emission Rate Data:

$C_{H_2SO_4} = 1.081E-04 \times (N \times (V_t - V_{tb}) \times (V_{soln} / V_a)) / V_{m(std)}$	6.966E-07 lb/dscf
$F_c\text{-factor} =$	2310 dscf/mmBtu
$E_{H_2SO_4} = C_{H_2SO_4} \times F_c\text{-factor} \times (100/\%CO_2) =$	0.00619 lb/mmBtu
$E_{H_2SO_4} = C_{H_2SO_4} \times Q_{s(std)} \times 60 =$	0.6901 lb/hr



40 CFR 60, Appendix A - Test Methods
Reference Method 8
Test Calculations

Customer: Polk Power Station
Facility: Acid Plant
Sampling Location: Stack
Operating Conditions: Full Load
Run Number: 2
Date: 11/08/06

Sample Time, θ :	64 minutes	Nozzle Diameter, D_n :	0.374 inches
Barometric Pressure, P_b :	28.90 "Hg	Nozzle Area, A_n :	0.00076286 ft ²
Stack Pressure, P_s :	28.94 "Hg	Average Orifice Meter, ΔH :	0.728 "H ₂ O
Effective Stack Area, A_s :	28.274 ft ²	Sample Volume, V_m :	32.896 ft ³
Pitot Coefficient, C_p :	0.84 dimensionless	Average Meter Temp., T_m :	69.6 °F
Gas Analysis:	26.0 % CO ₂	Average Stack Temp., T_s :	161.6 °F
	6.0 % O ₂	Average $\sqrt{\Delta p}$:	0.210 "H ₂ O
	0.0 % CO	Condensate Volume, V_{lc} :	59.3 ml
	68.0 % N ₂	Meter Box Y:	1.002 dimensionless

Data Calculated from Source Measurements:

$V_{w(std)} = 4.714E-02 \times V_{lc}$	2.795 scf
$V_{m(std)} = 17.647 \times V_m \times Y \times (P_b + (\Delta H / 13.6)) / (T_m + 460)$	31.803 dscf
$B_{ws} = V_{w(std)} / (V_{m(std)} + V_{w(std)})$	0.081 %
$FDA = 1.0 - B_{ws}$	0.919 %
$M_d = (0.44 \times \%CO_2) + (0.32 \times \%O_2) + (0.28 \times (\%N_2 + \%CO))$	32.40 lb./lb. mole
$M_s = (M_d \times FDA) + (18.0 \times B_{ws})$	31.24 lb./lb. mole
$v_s = 85.49 \times C_p \times (\sqrt{\Delta p}) \times (\sqrt{(T_s + 460)} / (M_s \times P_s))$	12.53 ft/second
$Q_s = v_s \times A_s \times 60$	21248.1 acf/minute
$Q_{s(std)} = Q_s \times FDA \times (528 / (T_s + 460)) \times (P_s / 29.92)$	16046.1 dscf/minute
$I = (T_s + 460) \times ((2.67E-03 \times V_{lc}) + (V_{m(std)} / 17.647)) \times 100 / (\theta \times P_s \times A_n \times v_s \times 6)$	114.8 %

Data from Laboratory Analysis:

	H ₂ SO ₄
Normality of Barium Chloride titrant, N	0.00975
Volume Titrant Blank, V_{tb}	0.1
Volume Titrant Sample, V_t	500
Volume of Sample Aliquot, V_a	50
Total Volume of Solution, V_{soln}	1.6

Calculated Concentration and Emission Rate Data:

$C_{H_2SO_4} = 1.081E-04 \times (N \times (V_t - V_{tb}) \times (V_{soln} / V_a)) / V_{m(std)}$	5.301E-07 lb/dscf
$F_c\text{-factor} =$	2310 dscf/MMBtu
$E_{H_2SO_4} = C_{H_2SO_4} \times F_c\text{-factor} \times (100/\%CO_2)$	0.00471 lb/MMBtu
$E_{H_2SO_4} = C_{H_2SO_4} \times Q_{s(std)} \times 60$	0.5104 lb/hr



40 CFR 60, Appendix A - Test Methods
Reference Method 8
Test Calculations

Customer: Polk Power Station
Facility: Acid Plant
Sampling Location: Stack
Operating Conditions: Full Load
Run Number: 3
Date: 11/08/06

Sample Time, θ :	64 minutes	Nozzle Diameter, D_n :	0.505 inches
Barometric Pressure, P_b :	29.80 "Hg	Nozzle Area, A_n :	0.00139086 ft ²
Stack Pressure, P_s :	29.84 "Hg	Average Orifice Meter, ΔH :	2.499 "H ₂ O
Effective Stack Area, A_s :	28.274 ft ²	Sample Volume, V_m :	53.805 ft ³
Pitot Coefficient, C_p :	0.84 dimensionless	Average Meter Temp., T_m :	68.4 °F
Gas Analysis:	26.0 % CO ₂	Average Stack Temp., T_s :	162.6 °F
	6.0 % O ₂	Average $\sqrt{\Delta p}$:	0.214 "H ₂ O
	0.0 % CO	Condensate Volume, V_{lc} :	65.3 ml
	68.0 % N ₂	Meter Box Y:	1.002 dimensionless

Data Calculated from Source Measurements:

$V_{w(std)} = 4.714E-02 \times V_{lc}$	3.078 scf
$V_{m(std)} = 17.647 \times V_m \times Y \times (P_b + (\Delta H / 13.6)) / (T_m + 460)$	53.983 dscf
$B_{ws} = V_{w(std)} / (V_{m(std)} + V_{w(std)})$	0.054 %
$FDA = 1.0 - B_{ws}$	0.946 %
$M_d = (0.44 \times \%CO_2) + (0.32 \times \%O_2) + (0.28 \times (\%N_2 + \%CO))$	32.40 lb./lb. mole
$M_s = (M_d \times FDA) + (18.0 \times B_{ws})$	31.62 lb./lb. mole
$v_s = 85.49 \times C_p \times (\sqrt{\Delta p}) \times (\sqrt{(T_s + 460)} / (M_s \times P_s))$	12.49 ft/second
$Q_s = v_s \times A_s \times 60$	21180.6 acf/minute
$Q_{s(std)} = Q_s \times FDA \times (528 / (T_s + 460)) \times (P_s / 29.92)$	16945.4 dscf/minute
$I = (T_s + 460) \times ((2.67E-03 \times V_{lc}) + (V_{m(std)} / 17.647)) \times 100 / (\theta \times P_s \times A_n \times v_s \times 6)$	101.2 %

Data from Laboratory Analysis:

	H ₂ SO ₄
Normality of Barium Chloride titrant, N	0.00975
Volume Titrant Blank, V_{tb}	0.1
Volume Titrant Sample, V_t	500
Volume of Sample Aliquot, V_a	50
Total Volume of Solution, V_{soln}	2.55

Calculated Concentration and Emission Rate Data:

$C_{H_2SO_4} = 1.081E-04 \times (N \times (V_t - V_{tb}) \times (V_{soln} / V_a)) / V_{m(std)}$	4.978E-07 lb/dscf
$F_c\text{-factor} =$	2310 dscf/MMBtu
$E_{H_2SO_4} = C_{H_2SO_4} \times F_c\text{-factor} \times (100/\%CO_2) =$	0.00442 lb/MMBtu
$E_{H_2SO_4} = C_{H_2SO_4} \times Q_{s(std)} \times 60 =$	0.5061 lb/hr

LABORATORY ANALYSIS



Laboratory Services

5012 Causeway Blvd * Tampa Fl. 33619 * Ph (813)630-7378 * Fax (813)630-7360 * DOH #E54272

Report For:

Report Date: 12/14/2006

Laboratory ID: **AA85645**

Location Code: TE_PPS_SAP_COMP_SYNGAS

Sample Information

Description: Polk Sulfuric Acid Plant Compliance

Sampled By:

Project Account Code:

Date and Time Collected: 11/9/2006 12:00:00 AM

Sample Collection Method:

Date of Sample Receipt: 11/9/2006

Laboratory Results

PARAMETER	Result	Units	MDL	Qualifier Code	Test Method	Analyst	Analysis Date & Time	Lower Limit	Upper Limit	Violation Check
Normality of BaCl2 * 2H2O	0.00975		0.0001			MM	11/8/2006 11:00:00 AM			
SO2 emission rate, lbs/ton of acid	Two	lbs/ton acid			EPA - RM6C	RAM	12/14/2006 11:18:00 AM			
SO3 emission rate, lbs/ton of acid	0.06	lbs/ton acid			EPA - RM8	RAM	12/14/2006 11:18:00 AM			
SO3, Avg. of Blank Titrations	0.1	milliliters	0.01		EPA - Meth.8	MM	11/8/2006 11:00:00 AM			
SO3, Run #1, Avg. of Titrations	3.45	milliliters	0.01		EPA - Meth.8	MM	11/8/2006 11:00:00 AM			
SO3, Run #2, Avg. of Titrations	1.6	milliliters	0.01		EPA - Meth.8	MM	11/8/2006 11:00:00 AM			
SO3, Run #3, Avg. of Titrations	2.55	milliliters	0.01		EPA - Meth.8	MM	11/8/2006 11:00:00 AM			
SO3, Volume of Contained Sample	500	milliliters	1		EPA - Meth.8	MM	11/8/2006 11:00:00 AM			
SO3, Volume of Sample Aliquot	50	milliliters	0.1		EPA - Meth.8	MM	11/8/2006 11:00:00 AM			

Comments

All results calculated on a wet to wet basis, unless otherwise indicated.

Data Qualifier Codes Explanation:

Subcontracted Laboratories:

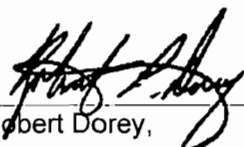

 Robert Dorey,
 Manager, Laboratory Services

CALIBRATION DATA



Environmental Services
Air Services Group

SUMMARY OF EQUIPMENT CALIBRATIONS

<u>EQUIPMENT</u>	<u>CAL DATE</u>	<u>METHOD</u>	<u>RESULTS</u>
<u>CONSOLE (MB 06)</u>		USEPA RM 5	
INITIAL	10/03/2006	(ORIFICE)	1.002
POST TEST	11/09/2006		0.981
<u>NOZZLE (SN73)</u>			
INITIAL	10/02/2006	CALIPER	0.504
POST TEST	11/09/2006	MEASUREMENTS	0.504
PYROMETER (PY 10)	10/02/2006	ASTM THERMOMETER	$\pm 2^{\circ}$ F
PITOT TUBE (PT 05)	10/03/2006	USEPA RM 2	$C_p = 0.84$
BAROMETER (BR 07)	10/02/2006	NWS COMPARISON	± 0.01 " Hg



**USEPA Reference Method 5
Dry Gas Meter Calibration
Critical Orifice Method
Quarterly Calibration**

**Environmental Services
Air Services Group**

Red Team

Manufacturer: Thermo Anderson
Model Number: MST-C1
Instrument Code Number: ^MB06
LabWorks Sample Number:

Calibration Date: 10/3/2006
Barometric Pressure: 30.15 "Hg
Theoretical Critical Vacuum: 14.22 "Hg
Calibrated By: JAV

IMPORTANT

For valid test results, the Actual Vacuum should be 1 to 2 "Hg greater than the Theoretical Critical Vacuum Shown above.
The Critical Orifice Coefficient, K', should be in English units.

IMPORTANT

Dry Gas Meter Readings

ΔH "H ₂ O	Time Minutes	Initial	Final	Total	Initial Temperatures		Final Temperatures	
		Volume ft ³	Volume ft ³	Volume ft ³	Inlet °F	Outlet °F	Inlet °F	Outlet °F
0.64	15	543.504	550.351	6.847	75	73	75	74
1.10	15	534.420	543.504	9.084	75	72	77	73
1.90	15	566.360	578.180	11.820	80	75	81	76
3.60	15	550.351	566.360	16.009	76	74	85	75

Critical Orifice Readings

Orifice Serial Number	K' Orifice Coefficient	Actual Vacuum "Hg	Ambient Temperatures		
			Initial °F	Final °F	Average °F
48	0.3483	20.5	72	72	72.0
55	0.4660	19.5	72	72	72.0
63	0.5971	17.5	72	72	72.0
73	0.8177	16.0	72	72	72.0

CALCULATED DATA

Dry Gas Meter	Critical Orifice		Calibration	Calibration		
Volume Corrected Vm _(std) , ft ³	Volume Corrected Vcr _(std) , ft ³	Volume Nominal Vcr _(std) , ft ³	Y Value (ratio)	QA/QC ± 0.02	ΔHα Value "H ₂ O	QA/QC ± 0.2
6.827	6.829	6.831	1.000	-0.002	1.730	0.010
9.067	9.137	9.140	1.008	0.006	1.661	-0.059
11.739	11.708	11.711	0.997	-0.005	1.735	0.015
15.980	16.033	16.038	1.003	0.001	1.754	0.035
Averages:			1.002		1.720	

For Calibration Y, the ratio of the reading of the calibration orifice to the dry gas meter, acceptable tolerance from average is ± 0.02.

For Calibration ΔHα, the acceptable tolerance of individual values from the average is + 0.2.

Review/Approval 

5-Oct-06



**USEPA Reference Method 5
Dry Gas Meter Calibration
Critical Orifice Method
POST - TEST CALIBRATION CHECK**

**Environmental Services
Air Services Group**

Manufacturer: Thermo	Calibration Date: 11/9/2006
Model Number: MST	Barometric Pressure: 30.02 "Hg
Instrument Code Number: MB06	Theoretical Critical Vacuum: 14.16 "Hg
LabWorks Sample Number:	Calibrated By: SEG/GDB
Associated Test: Polk Acid Plant	Team: RED

IMPORTANT

For valid test results, the Actual Vacuum should be 1 to 2 "Hg greater than the Theoretical Critical Vacuum Shown above.
The Critical Orifice Coefficient, K', should be in English units.

IMPORTANT

Dry Gas Meter Readings

ΔH "H ₂ O	Time Minutes	Initial	Final	Total	Initial Temperatures		Final Temperatures	
		Volume ft ³	Volume ft ³	Volume ft ³	Inlet °F	Outlet °F	Inlet °F	Outlet °F
2	10	727.720	735.544	7.824	75	72	74	72
2	10	735.544	743.370	7.826	74	72	76	73
2	10	743.370	751.200	7.830	76	73	77	74

Critical Orifice Readings

Orifice Serial Number	K' Orifice Coefficient	Actual Vacuum "Hg	Ambient Temperatures		
			Initial °F	Final °F	Average °F
63	0.5877	19.5	72	72	72.0
63	0.5877	19.5	72	72	72.0
63	0.5877	19.5	72	72	72.0

CALCULATED DATA

Dry Gas Meter	Critical Orifice		Calibration		Calibration	
Volume Corrected Vm _(std) , ft ³	Volume Corrected Vcr _(std) , ft ³	Volume Nominal Vcr _(std) , ft ³	Y Value (ratio)	QA/QC ± 0.02	ΔH _α Value "H ₂ O	QA/QC ± 0.2
7.808	7.649	7.684	0.980	-0.001	1.910	0.003
7.802	7.649	7.684	0.980	0.000	1.908	0.001
7.788	7.649	7.684	0.982	0.001	1.904	-0.004

Averages: 0.981

Prior Y: 1.002

% Difference: 2.12%

1.908

For Calibration Y, the ratio of the reading of the calibration orifice to the dry gas meter, acceptable tolerance from average is ± 0.02.

For Calibration ΔH_α, the acceptable tolerance of individual values from the average is + 0.2.

Review/Approval

Date:



Environmental Services
Air Services Group

QUARTERLY NOZZLE CALIBRATIONS

Shared Resource

STEEL NOZZLE SET

Calibration Date: 10/2/2006 Responsible Party: SEG

Nozzle I.D.	Nozzle Diameter, D _n (cm)			Maximum Difference, "	Average D _n , inches
	D ₁	D ₂	D ₃		
^SN01	0.296	0.294	0.290	0.002	0.115
^SN04	0.320	0.320	0.320	0.000	0.126
^SN05	0.380	0.380	0.378	0.001	0.149
^SN06	0.500	0.496	0.500	0.002	0.196
^SN09	0.695	0.689	0.690	0.002	0.272
^SN10	0.755	0.750	0.755	0.002	0.297
^SN12	0.985	0.985	0.983	0.001	0.388
^SN15	0.420	0.420	0.420	0.000	0.165
^SN16	0.504	0.505	0.505	0.000	0.199
^SN19	0.717	0.714	0.715	0.001	0.282
^SN22	0.932	0.930	0.934	0.002	0.367
^SN30	0.795	0.792	0.795	0.001	0.313
^SN36	0.480	0.477	0.477	0.001	0.188
^SN37	0.535	0.534	0.532	0.001	0.210
^SN38	0.635	0.640	0.640	0.002	0.251
^SN46	0.482	0.485	0.483	0.001	0.190
^SN47	0.515	0.516	0.516	0.000	0.203
^SN48	0.645	0.640	0.640	0.002	0.253
^SN50	0.788	0.790	0.791	0.001	0.311
^SN58	0.619	0.611	0.615	0.003	0.242
^SN68	0.630	0.625	0.632	0.003	0.248
^SN69	0.950	0.950	0.950	0.000	0.374
^SN70	1.565	1.565	1.565	0.000	0.616
^SN71	1.558	1.560	1.560	0.001	0.614
^SN72	0.955	0.953	0.950	0.002	0.375
^SN73	1.277	1.280	1.280	0.001	0.504
^SN74	1.245	1.240	1.245	0.002	0.490

Data Notations: All micrometer readings are converted from cm to inches by multiplying by 0.393700787. Maximum Difference must be ≤ 0.004".

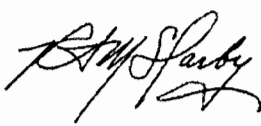
QA/QC Review by: 

5-Oct-06



POST TEST NOZZLE CALIBRATION

Shared Resource

Calibration Date: 11/9/2006
Calibration Personnel: McDarby
Test Designation: Polk SAP

Nozzle Identifier	Nozzle Diameter, D _n (cm)			Maximum Difference, "	Average D _n , inches
	D ₁	D ₂	D ₃		
SN 73	1.280	1.280	1.280	0.000	0.504

Data Notations: All micrometer readings are converted from cm to inches by multiplying by 0.393700787. Maximum Difference must be ≤ 0.004 ".

Quarterly (pre-test) value for nozzle ID SN 73 was 0.504

Difference (Pre-test/Post-test) is: 0



Environmental Services
Air Services Group

Pyrometer Calibration

Red Team

Pyrometer Under Test

Pyrometer Number: ^PY10
Labworks Sample # 0
Calibration Date: 10/2/2006

Calibrator Information

Calibrator Type/Manufacturer: Hart Scientific
Calibrator Serial Number: AOA024
Date of Last Calibration: 7/11/2006
Calibration Personnel (Typed and Signature): JAV

Calibration Data

Calibration Point	Reference Temperature	Pyrometer Indication	Difference
1	400	399	1
2	212	210	2
3	32	33	-1

Reference temperatures must encompass the expected range of measurement. These three points should be ~ 32 degrees, ~212 degrees, and ~ 400 degrees Farenheit.
Difference is calculated as follows:

$$(\text{reference temperature}) - (\text{pyrometer indication})$$

Quality Control Data

Calibration Point	Difference
1	Pass
2	Pass
3	Pass

Reviewer:

5-Oct-06



PITOT TUBE CALIBRATION DATA SHEET

Environmental Services Air Services Group

Pitot Tube ID # PT05

Calibration Date 10/3/2006 Operating Quarter/Year:

Red Team

Openings Damaged? [] Y [x] N Repaired? [] Y [x] N [] N/A

Labworks #: 0

Alpha and Beta Angle Determinations

alpha 1 2 degrees Pass
alpha 2 0.8 degrees Pass
beta 1 2.1 degrees Pass
beta 2 3.1 degrees Pass

Acceptable Limits:

Dt 0.48 < Dt > 0.95 cm
alpha < 10 degrees
(alpha 1 measured across top impact openings)
(alpha 2 measured across bottom impact openings)
beta 1 < 5 degrees (alongside top impact openings)
beta 2 < 5 degrees (alongside bottom impact openings)
Z < 0.32 cm (Asin psi)
W < 0.08 cm (Asino)
A distance between tips
o angle of plane on side of pitots
psi angle between tips

Gamma, Theta, A, Z, and W Determinations

psi 0.3 degrees
A 2.31 cm
Z 0.012 cm Pass
o 0.1 degrees
W 0.004 cm Pass

NOTES

All measurements are taken in accordance with the requirements of 40 CFR 60, Appendix A - Test Methods, Method 2, "Determination of stack gas velocity and volumetric flow rate (Type S pitot tube)". Measurement details are found in EPA/600/4-77/027b, "Quality Assurance Handbook for Air Pollution Measurement Systems: Stationary Source Specific Methods", sub-section 3.1.1, Procurement of Apparatus and Supplies.

Comments: REMOVABLE

Calibrated by:

Quality Assurance Review / Approval:

[Signature]

16-Oct-06



Environmental Services
Air Services Group

BAROMETER CALIBRATION

Blue Team

Instrument Number: ^BR04
Calibration Date: 10/2/2006
Calibration Personnel: JAV

Labworks #:

Time	Barometer Reading Inches Mercury	Reference Reading Inches Mercury	Difference "Hg
11:00	30.25	30.18	0.07
13:00	30.2	30.15	0.05
14:50	30.2	30.12	0.08
Average Difference:			0.07

Note: Barometric readings must agree within ± 0.1 "Hg.
Current Reference is National Weather Service, TIA.
Current Conditions at Tampa International Airport

Comments (Note any adjustments):

QA/QC Review by: 

Date: 5-Oct-06

APPENDIX D

INSTRUMENTAL REFERENCE METHOD TEST DATA – IGCC

OXYGEN, CARBON DIOXIDE, CARBON MONOXIDE DATA

Run averages corrected for bias

Operator: W. Quentin Best

Plant Name: TECO Polk Plant

Location: UNit 1

Run	O2 OT %	CO2 OT %	CO ppm	
1	12.281	8.676	4.9	Stratification study
2	12.38	8.48	4.413	Run 1
3	12.368	8.537	4.265	Run 2
4	12.319	8.524	4.673	Run 3

Calibration Error Test at Run 1 . STRATA Version 2.01

		O2 OT	CO2 OT	CO
		%	%	ppm
11/7/2006	15:56:14	0.017	0.034	-0.075
11/7/2006	15:57:14	0.04	0.014	0.14
11/7/2006	15:58:14	8.295	6.678	-0.296
11/7/2006	15:59:14	21.948	17.191	-3.382
11/7/2006	16:00:14	21.29	16.708	-2.947
11/7/2006	16:01:14	12.514	9.9	-2.893
11/7/2006	16:02:14	3.807	2.792	8.509
11/7/2006	16:03:14	0.075	0.02	29.969
11/7/2006	16:04:14	0.085	0.018	28.488
11/7/2006	16:05:13	0.076	0.015	19.555
11/7/2006	16:06:13	0.078	0.015	15.334

Calibration Error Test at Run 1

Operator: W. Quentin Best
 Plant Name: TECO Polk Plant
 Location: UNit 1

Reference Cylinder Numbers

	Zero	Low-range	Mid-range	High-range
O2 OT	CC-136551		CC-107096	CC-250656
CO2 OT	CC-136551		CC-107096	CC-250656
CO	CC-136551		CC-150548	CC-50737

Date/Time	11/7/2006	16:06:59	PASSED
Analyte	O2 OT	CO2 OT	CO
Units	%	%	ppm
Zero Ref Cyl	0	0	0
Zero Avg	0.046	0.016	0.206
Zero Error%	0.2	0.1	0.7
Low Ref Cyl			
Low Avg			
Low Error%			
Mid Ref Cyl	12.5	9.81	15.9
Mid Avg	12.478	9.89	15.974
Mid Error%	0.1	0.4	0.2
High Ref Cyl	21.9	17.7	29.8
High Avg	21.952	17.451	29.657
High Error%	0.2	1.2	0.5

Initial System Bias Check for Run 1 . STRATA Version 2.01

		O2 OT	CO2 OT	CO
		%	%	ppm
11/7/2006	16:08:01	15.043	0.09	14.619
11/7/2006	16:09:02	5.488	0.097	4.505
11/7/2006	16:10:02	0.072	0.085	0.654
11/7/2006	16:11:02	0.044	0.086	0.213
11/7/2006	16:12:01	8.094	4.504	0.066
11/7/2006	16:13:01	12.424	9.679	-1.6
11/7/2006	16:14:01	12.039	8.808	-2.237
11/7/2006	16:15:01	0.149	0.212	2.084
11/7/2006	16:16:01	0.034	0.126	13.505

Initial System Bias Check for Run 1

Operator: W. Quentin Best
 Plant Name: TECO Polk Plant
 Location: UNit 1

Reference Cylinder Numbers

	Zero	Span
O2 OT	CC-136551	CC-107096
CO2 OT	CC-136551	CC-107096
CO	CC-136551	CC-150548

Date/Time	11/7/2006	16:16:47	PASSED
Analyte	O2 OT	CO2 OT	CO
Units	%	%	ppm
Zero Ref Cyl	0	0	0
Zero Cal	0.046	0.016	0.206
Zero Avg	0.052	0.088	0.199
Zero Bias%	0	0.4	0
Zero Drift%			
Span Ref Cyl	12.5	9.81	15.9
Span Cal	12.478	9.89	15.974
Span Avg	12.322	9.795	15.561
Span Bias%	0.6	0.5	1.4
Span Drift%			

Final System Bias Check for Run 1 . STRATA Version 2.01

		O2 OT	CO2 OT	CO
		%	%	ppm
11/7/2006	16:42:42	18.365	0.191	-0.002
11/7/2006	16:43:42	0.098	0.12	-0.022
11/7/2006	16:44:41	0.02	0.11	0.101
11/7/2006	16:45:42	0.012	0.107	0.058
11/7/2006	16:46:41	9.037	7.328	-0.506
11/7/2006	16:47:41	12.289	9.808	-2.291
11/7/2006	16:48:41	6.272	4.82	-1.817
11/7/2006	16:49:41	0.026	0.162	7.418
11/7/2006	16:50:42	0.012	0.128	14.957
11/7/2006	16:51:41	0.008	0.114	15.58

Final System Bias Check for Run 1

Operator: W. Quentin Best
 Plant Name: TECO Polk Plant
 Location: Unit 1

Reference Cylinder Numbers

	Zero	Span
O2 OT	CC-136551	CC-107096
CO2 OT	CC-136551	CC-107096
CO	CC-136551	CC-150548

Date/Time	11/7/2006	16:52:11	PASSED
Analyte	O2 OT	CO2 OT	CO
Units	%	%	ppm
Zero Ref Cyl	0	0	0
Zero Cal	0.046	0.016	0.206
Zero Avg	0.015	0.11	0.138
Zero Bias%	0.1	0.5	0.2
Zero Drift%	-0.1	0.1	-0.2
Span Ref Cyl	12.5	9.81	15.9
Span Cal	12.478	9.89	15.974
Span Avg	12.284	9.794	15.783
Span Bias%	0.8	0.5	0.6
Span Drift%	-0.2	0	0.7
Ini Zero Avg	0.052	0.088	0.199
Ini Span Avg	12.322	9.795	15.561
Run Avg	12.508	8.054	2.33
Co	0.034	0.099	0.169
Cm	12.303	9.795	15.672
Correct Avg	12.708	8.049	2.216

Test Run 1 Begin. STRATA Version 2.01

Operator: W. Quentin Best

Plant Name: TECO Polk Plant

Location: UNit 1

		O2 OT	CO2 OT	CO	
		%	%	ppm	
11/7/2006	16:17:47	0.136	0.102	15.684	
11/7/2006	16:18:48	19.477	0.13	11.79	
11/7/2006	16:19:48	20.669	0.134	1.6	
11/7/2006	16:20:48	14.98	5.844	-0.018	
11/7/2006	16:21:48	11.683	8.849	1.774	
11/7/2006	16:22:48	11.678	8.874	2.527	
11/7/2006	16:23:48	11.687	8.879	2.378	
11/7/2006	16:24:47	11.698	8.872	2.521	
Begin calculating run averages					
11/7/2006	16:25:49	11.707	8.868	2.375	Stratification Study 3 points per port
11/7/2006	16:26:49	11.706	8.869	2.208	
11/7/2006	16:27:49	11.711	8.866	2.14	
11/7/2006	16:28:49	11.704	8.861	2.113	Port
11/7/2006	16:29:49	11.668	8.867	2.301	Average
11/7/2006	16:30:49	11.603	8.887	2.57	2.40
11/7/2006	16:31:49	11.654	8.888	2.877	2.90
11/7/2006	16:32:49	11.683	8.87	2.619	1.90
11/7/2006	16:33:49	11.691	8.864	2.431	
11/7/2006	16:34:49	11.673	8.875	2.34	
11/7/2006	16:35:49	11.651	8.878	2.585	
11/7/2006	16:36:49	11.66	8.876	2.722	
11/7/2006	16:37:49	11.673	8.876	2.399	
11/7/2006	16:38:49	11.657	8.886	2.536	
11/7/2006	16:39:49	12.274	8.091	2.666	
11/7/2006	16:40:49	20.584	0.233	1.511	

Calibration Error Test at Run 1 . STRATA Version 2.01

		O2 OT %	CO2 OT %	CO ppm
11/8/2006	7:37:11	8.448	0.035	-0.435
11/8/2006	7:38:10	0.041	0.005	-0.211
11/8/2006	7:39:10	1.492	1.136	0.262
11/8/2006	7:40:10	21.915	17.439	-1.648
11/8/2006	7:41:10	22.02	17.514	-2.097
11/8/2006	7:42:10	14.167	10.849	-2.024
11/8/2006	7:43:10	6.854	4.628	-0.718
11/8/2006	7:44:10	0.076	0.027	8.344
11/8/2006	7:45:10	0.072	0.019	14.839
11/8/2006	7:46:10	0.072	0.018	15.308
11/8/2006	7:47:10	0.072	0.018	15.987
11/8/2006	7:48:11	0.073	0.015	15.975
11/8/2006	7:49:11	0.728	0.098	15.132
11/8/2006	7:50:10	0.074	0.008	10.471

Calibration Error Test at Run 1

Operator: W. Quentin Best
 Plant Name: TECO Polk Plant
 Location: UNit 1

Reference Cylinder Numbers

	Zero	Low-range	Mid-range	High-range
O2 OT	CC-136551		CC-107096	CC-250656
CO2 OT	CC-136551		CC-107096	CC-250656
CO	CC-136551	CC-165111	CC-150548	CC-50737

Date/Time	11/8/2006 7:51:00 PASSED		
Analyte	O2 OT	CO2 OT	CO
Units	%	%	ppm
Zero Ref Cyl	0	0	0
Zero Avg	0.052	0.011	0.128
Zero Error%	0.2	0.1	0.8
Low Ref Cyl			9.26
Low Avg			9.221
Low Error%			0.2
Mid Ref Cyl	12.5	9.81	15.9
Mid Avg	12.548	9.898	15.915
Mid Error%	0.2	0.4	0.1
High Ref Cyl	21.9	17.7	
High Avg	22.019	17.515	
High Error%	0.5	0.9	

Initial System Bias Check for Run 1 . STRATA Version 2.01

		O2 OT	CO2 OT	CO
		%	%	ppm
11/8/2006	7:52:22	16.904	0.093	5.997
11/8/2006	7:53:22	20.74	0.116	0.829
11/8/2006	7:54:22	20.722	0.118	0.252
11/8/2006	7:55:22	20.716	0.124	0.215
11/8/2006	7:56:22	20.711	0.124	0.341
11/8/2006	7:57:22	20.71	0.125	0.066
11/8/2006	7:58:21	20.597	0.125	-0.048
11/8/2006	7:59:21	20.679	0.121	0.002
11/8/2006	8:00:22	5.797	0.091	0.199
11/8/2006	8:01:21	0.048	0.076	0.245
11/8/2006	8:02:21	5.593	4.108	0.125
11/8/2006	8:03:22	12.375	9.799	-1.113
11/8/2006	8:04:22	12.437	9.84	-1.348
11/8/2006	8:05:22	3.655	2.739	-0.267
11/8/2006	8:06:22	0.033	0.116	5.987
11/8/2006	8:07:22	0.024	0.091	8.652
11/8/2006	8:08:22	0.019	0.085	8.784
11/8/2006	8:09:21	0.017	0.084	9.047

Initial System Bias Check for Run 1

Operator: W. Quentin Best
 Plant Name: TECO Polk Plant
 Location: UNit 1
 Reference Cylinder Numbers
 Zero Span
 O2 OT CC-136551 CC-107096
 CO2 OT CC-136551 CC-107096
 CO CC-136551 CC-165111

Date/Time	11/8/2006	8:09:28	PASSED
Analyte	O2 OT	CO2 OT	CO
Units	%	%	ppm
Zero Ref Cyl	0	0	0
Zero Cal	0.052	0.011	0.128
Zero Avg	0.052	0.079	0.211
Zero Bias%	0	0.3	0.5
Zero Drift%			
Span Ref Cyl	12.5	9.81	9.26
Span Cal	12.548	9.898	9.221
Span Avg	12.435	9.829	9.056
Span Bias%	0.5	0.3	1
Span Drift%			

Test Run 1 Begin. STRATA Version 2.01

Operator: W. Quentin Best
 Plant Name: TECO Polk Plant
 Location: UNit 1

		O2 OT	CO2 OT	CO
		%	%	ppm
11/8/2006	8:10:29	0.39	0.08	8.993
11/8/2006	8:11:29	20.108	0.118	6.574
11/8/2006	8:12:29	20.852	0.121	0.843
11/8/2006	8:13:29	20.855	0.122	0.05
11/8/2006	8:14:29	16.126	4.989	0.15
11/8/2006	8:15:28	11.703	9.158	2.525
11/8/2006	8:16:28	11.684	9.164	4.32
Begin calculating run averages				
11/8/2006	8:17:57	11.676	9.174	4.415
11/8/2006	8:18:57	11.663	9.178	4.895
11/8/2006	8:19:56	11.674	9.177	4.803
11/8/2006	8:20:56	11.626	9.167	4.395
11/8/2006	8:21:56	11.612	9.169	4.598
11/8/2006	8:22:56	11.639	9.202	4.979
11/8/2006	8:23:56	11.67	9.199	4.563
11/8/2006	8:24:57	11.678	9.204	4.492
11/8/2006	8:25:57	11.678	9.204	4.337
11/8/2006	8:26:56	11.694	9.193	4.126
11/8/2006	8:27:56	11.721	9.181	3.997
11/8/2006	8:28:56	11.722	9.172	3.894
11/8/2006	8:29:56	11.704	9.196	4.109
Pause				
End Pause				
11/8/2006	8:30:56	11.675	9.192	4.752
Pause				
11/8/2006	8:31:57	11.646	9.142	5.109
11/8/2006	8:32:57	19.345	1.435	4.448
11/8/2006	8:33:56	20.846	0.131	0.766
11/8/2006	8:34:56	20.641	0.358	-0.22
11/8/2006	8:35:56	20.007	0.972	0.143
11/8/2006	8:36:56	20.119	0.866	0.331
11/8/2006	8:37:56	20.082	0.902	0.182
11/8/2006	8:38:57	20.108	0.876	0.249
11/8/2006	8:39:57	20.115	0.874	0.196
End Pause				
Pause				
11/8/2006	8:40:56	20.125	0.858	0.174
11/8/2006	8:41:56	20.176	0.803	0.377
11/8/2006	8:42:56	20.168	0.82	0.314
11/8/2006	8:43:56	17.569	0.569	0.451
11/8/2006	8:44:56	8.429	0.076	0.799
11/8/2006	8:45:57	8.286	0.073	0.216
11/8/2006	8:46:57	8.255	0.074	-0.017
11/8/2006	8:47:56	8.167	0.076	0.115
11/8/2006	8:48:56	7.618	0.073	0.009
11/8/2006	8:49:56	0.102	0.06	0.031

Stratification Study

Port Average 4.431 4.931
 3.931

Test Run 1 Begin. STRATA Version 2.01

Operator: W. Quentin Best

Plant Name: TECO Polk Plant

Location: UNIT 1

		O2 OT	CO2 OT	CO			
		%	%	ppm			
11/8/2006	8:50:56	6.557	4.808	0.292			
11/8/2006	8:51:56	12.394	8.4	2.978			
11/8/2006	8:52:57	12.474	8.374	5.207			
End Pause							
11/8/2006	8:53:57	12.457	8.448	5.284			
11/8/2006	8:54:57	12.469	8.444	5.501			
11/8/2006	8:55:56	12.494	8.421	5.495			
11/8/2006	8:56:56	12.489	8.413	5.218			
11/8/2006	8:57:56	12.491	8.407	5.335			
11/8/2006	8:58:56	12.474	8.443	5.356			
11/8/2006	8:59:56	12.448	8.479	5.183			
11/8/2006	9:00:56	12.457	8.407	5.272			
11/8/2006	9:01:57	12.446	8.398	5.43			
11/8/2006	9:02:57	12.456	8.446	5.469	Port Average	5.26	5.76
11/8/2006	9:03:56	12.456	8.458	5.314			4.76
11/8/2006	9:04:56	12.469	8.442	5.39			
11/8/2006	9:05:56	12.472	8.438	5.377			
11/8/2006	9:06:56	12.462	8.445	5.334			
11/8/2006	9:07:56	12.471	8.446	4.732			
11/8/2006	9:08:57	12.486	8.447	4.4			
Pause							
11/8/2006	9:09:57	12.477	8.438	4.289			
11/8/2006	9:10:57	16.079	4.706	4.378			
11/8/2006	9:11:57	20.851	0.153	1.743			
11/8/2006	9:12:56	20.865	0.133	-0.055			
11/8/2006	9:13:56	20.871	0.122	0.044			
11/8/2006	9:14:56	20.875	0.116	0.065			
11/8/2006	9:15:56	16.931	4.213	0.056			
11/8/2006	9:16:57	12.413	8.481	2.144			
11/8/2006	9:17:57	12.395	8.491	4.762			
End Pause							
11/8/2006	9:18:56	12.421	8.474	5.049			
11/8/2006	9:19:57	12.42	8.489	4.913			
11/8/2006	9:20:56	12.364	8.514	5.072			
11/8/2006	9:21:56	12.33	8.492	5.351			
11/8/2006	9:22:56	12.351	8.524	5.195			
11/8/2006	9:23:56	12.348	8.55	4.951			
11/8/2006	9:24:56	12.387	8.522	4.902			
11/8/2006	9:25:56	12.416	8.493	4.438			
11/8/2006	9:26:56	12.42	8.468	4.279			
11/8/2006	9:27:56	12.39	8.478	4.438			
11/8/2006	9:28:56	12.368	8.504	4.835			
11/8/2006	9:29:57	12.381	8.486	4.618	Port Average	4.94	5.44
11/8/2006	9:30:57	12.319	8.541	4.673			4.44
11/8/2006	9:31:57	12.265	8.494	5.133			
11/8/2006	9:32:56	12.299	8.471	5.565			

Test Run 1 Begin. STRATA Version 2.01

Operator: W. Quentin Best

Plant Name: TECO Polk Plant

Location: UNit 1

		O2 OT	CO2 OT	CO
		%	%	ppm
11/8/2006	9:33:56	12.361	8.455	5.661
Average of Test Run		O2 OT	CO2 OT	CO
		%	%	ppm
11/8/2006	9:34:53	12.224	8.652	4.879

Test Run 1 End

Final System Bias Check for Run 1 . STRATA Version 2.01

		O2 OT	CO2 OT	CO
		%	%	ppm
11/8/2006	9:36:42	2.031	0.828	4.225
11/8/2006	9:37:41	0.507	0.078	0.783
11/8/2006	9:38:41	0.296	0.062	0.291
11/8/2006	9:39:41	0.228	0.056	0.099
11/8/2006	9:40:41	0.227	0.053	0.205
11/8/2006	9:41:41	0.221	0.048	0.26
11/8/2006	9:42:41	0.224	0.042	0.09
11/8/2006	9:43:41	3.97	3.065	-0.056
11/8/2006	9:44:41	12.31	9.511	-0.915
11/8/2006	9:45:41	12.401	9.61	-1.351
11/8/2006	9:46:41	12.443	9.699	-1.095
11/8/2006	9:47:41	10.836	8.282	-1.047
11/8/2006	9:48:41	-0.273	0.12	2.019
11/8/2006	9:49:41	-0.306	0.064	8.046
11/8/2006	9:50:41	-0.311	0.049	8.809

Final System Bias Check for Run 1

Operator: W. Quentin Best
 Plant Name: TECO Polk Plant
 Location: UNit 1

Reference Cylinder Numbers

	Zero	Span
O2 OT	CC-136551	CC-107096
CO2 OT	CC-136551	CC-107096
CO	CC-136551	CC-165111

Date/Time	11/8/2006	9:51:37	PASSED
Analyte	O2 OT	CO2 OT	CO
Units	%	%	ppm
Zero Ref Cyl	0	0	0
Zero Cal	0.052	0.011	0.128
Zero Avg	0.225	0.042	0.093
Zero Bias%	0.7	0.2	0.2
Zero Drift%	0.7	-0.2	-0.7
Span Ref Cyl	12.5	9.81	9.26
Span Cal	12.548	9.898	9.221
Span Avg	12.444	9.722	9.117
Span Bias%	0.4	0.9	0.7
Span Drift%	0	-0.5	0.4
Ini Zero Avg	0.052	0.079	0.211
Ini Span Avg	12.435	9.829	9.056
Run Avg	12.224	8.652	4.879
Co	0.138	0.06	0.152
Cm	12.439	9.775	9.086
Correct Avg	12.281	8.676	4.9

Test Run 2 Begin. STRATA Version 2.01

Operator: W. Quentin Best

Plant Name: TECO Polk Plant

Location: UNit 1

		O2 OT	CO2 OT	CO
		%	%	ppm
11/8/2006	9:52:38	-0.317	0.039	9.125
11/8/2006	9:53:38	7.195	5.194	8.664
11/8/2006	9:54:39	10.874	7.49	5.93
11/8/2006	9:55:39	12.259	8.471	5.011
11/8/2006	9:56:38	12.25	8.48	4.894
11/8/2006	9:57:38	12.24	8.488	5.016
11/8/2006	9:58:38	12.252	8.492	5.104
11/8/2006	9:59:38	12.281	8.467	4.835
11/8/2006	10:00:38	12.273	8.469	4.584
11/8/2006	10:01:38	12.2	8.463	4.563
11/8/2006	10:02:39	12.252	8.47	5.057
11/8/2006	10:03:39	12.276	8.462	4.548
11/8/2006	10:04:38	12.286	8.459	4.329
11/8/2006	10:05:38	12.293	8.462	4.435
11/8/2006	10:06:38	12.309	8.456	4.536
11/8/2006	10:07:38	12.315	8.44	4.338
11/8/2006	10:08:38	12.312	8.44	4.172
11/8/2006	10:09:38	12.302	8.448	4.452
11/8/2006	10:10:38	12.294	8.447	4.821
11/8/2006	10:11:38	12.23	8.432	5.009
11/8/2006	10:12:38	12.226	8.437	5.341
11/8/2006	10:13:39	12.266	8.458	4.968
11/8/2006	10:14:39	12.293	8.449	4.626
11/8/2006	10:15:39	12.301	8.448	4.381
11/8/2006	10:16:39	12.293	8.443	4.189
11/8/2006	10:17:38	12.297	8.459	4.306
11/8/2006	10:18:38	12.321	8.464	4.598
11/8/2006	10:19:38	12.314	8.469	4.393
11/8/2006	10:20:38	12.3	8.463	4.742
11/8/2006	10:21:38	12.207	8.453	4.598
11/8/2006	10:22:38	12.247	8.474	4.954
11/8/2006	10:23:38	12.292	8.469	4.991
11/8/2006	10:24:39	12.33	8.451	4.812
11/8/2006	10:25:39	12.335	8.446	4.533
11/8/2006	10:26:39	12.299	8.46	4.485
11/8/2006	10:27:38	12.296	8.45	4.571
11/8/2006	10:28:38	12.313	8.435	4.743
11/8/2006	10:29:38	12.321	8.435	4.501
11/8/2006	10:30:39	12.327	8.433	4.729
11/8/2006	10:31:39	12.269	8.436	4.559
11/8/2006	10:32:38	12.228	8.434	4.879
11/8/2006	10:33:38	12.289	8.426	4.872
11/8/2006	10:34:38	12.314	8.41	4.486
11/8/2006	10:35:38	12.317	8.414	4.385
11/8/2006	10:36:38	12.312	8.415	4.571
11/8/2006	10:37:38	12.319	8.405	4.68

Test Run 2 Begin. STRATA Version 2.01

Operator: W. Quentin Best

Plant Name: TECO Polk Plant

Location: UNit 1

		O2 OT	CO2 OT	CO
		%	%	ppm
11/8/2006	10:38:38	12.312	8.407	4.358
11/8/2006	10:39:38	12.31	8.422	4.566
11/8/2006	10:40:38	12.304	8.425	4.51
11/8/2006	10:41:39	12.223	8.403	4.744
11/8/2006	10:42:39	12.267	8.406	4.995
11/8/2006	10:43:38	12.312	8.408	5.098
11/8/2006	10:44:38	12.318	8.413	4.845
11/8/2006	10:45:38	12.34	8.406	4.582
11/8/2006	10:46:38	12.331	8.409	4.565
11/8/2006	10:47:38	12.326	8.393	4.532
11/8/2006	10:48:38	12.326	8.386	4.523
11/8/2006	10:49:39	12.299	8.384	4.717
11/8/2006	10:50:39	12.297	8.394	4.692
11/8/2006	10:51:39	12.253	8.39	4.592
11/8/2006	10:52:38	12.237	8.38	4.884
11/8/2006	10:53:38	12.26	8.397	4.679
Begin calculating run averages				
11/8/2006	10:54:40	12.303	8.387	4.96
11/8/2006	10:55:40	12.314	8.381	4.611
11/8/2006	10:56:40	12.342	8.36	4.483
11/8/2006	10:57:40	12.329	8.364	4.428
11/8/2006	10:58:40	12.344	8.353	4.394
11/8/2006	10:59:40	12.328	8.366	4.242
11/8/2006	11:00:40	12.335	8.355	4.324
11/8/2006	11:01:39	12.261	8.357	4.194
11/8/2006	11:02:40	12.319	8.353	4.283
11/8/2006	11:03:40	12.363	8.345	4.098
11/8/2006	11:04:40	12.368	8.354	3.944
11/8/2006	11:05:40	12.372	8.372	4.347
11/8/2006	11:06:40	12.37	8.371	4.436
11/8/2006	11:07:40	12.359	8.347	4.475
11/8/2006	11:08:39	12.354	8.359	4.227
11/8/2006	11:09:40	12.373	8.355	4.564
11/8/2006	11:10:40	12.376	8.356	4.325
11/8/2006	11:11:40	12.288	8.36	4.424
11/8/2006	11:12:40	12.242	8.366	4.637
11/8/2006	11:13:40	12.31	8.357	4.882
11/8/2006	11:14:40	12.307	8.378	4.747
11/8/2006	11:15:39	12.355	8.361	4.88
11/8/2006	11:16:40	12.334	8.367	4.495
11/8/2006	11:17:40	12.303	8.382	4.43
11/8/2006	11:18:40	12.322	8.375	4.582
11/8/2006	11:19:40	12.335	8.371	4.196
11/8/2006	11:20:40	12.314	8.381	4.366
11/8/2006	11:21:40	12.221	8.387	4.558
11/8/2006	11:22:39	12.267	8.39	4.932

Test Run 2 Begin. STRATA Version 2.01

Operator: W. Quentin Best

Plant Name: TECO Polk Plant

Location: UNit 1

		O2 OT	CO2 OT	CO
		%	%	ppm
11/8/2006	11:23:40	12.321	8.381	4.786
11/8/2006	11:24:40	12.345	8.384	4.478
11/8/2006	11:25:40	12.333	8.385	4.274
11/8/2006	11:26:40	12.331	8.392	4.5
11/8/2006	11:27:40	12.355	8.389	4.005
11/8/2006	11:28:40	12.395	8.377	4.155
11/8/2006	11:29:39	12.372	8.387	4.012
11/8/2006	11:30:40	12.353	8.38	4.022
11/8/2006	11:31:40	12.312	8.373	4.215
11/8/2006	11:32:40	12.296	8.366	4.317
11/8/2006	11:33:40	12.343	8.38	4.197
11/8/2006	11:34:40	12.349	8.393	4.341
11/8/2006	11:35:40	12.38	8.375	4.33
11/8/2006	11:36:39	12.383	8.376	3.984
11/8/2006	11:37:40	12.368	8.376	4.172
11/8/2006	11:38:40	12.369	8.375	4.443
11/8/2006	11:39:40	12.365	8.376	4.596
11/8/2006	11:40:40	12.354	8.372	4.29
11/8/2006	11:41:40	12.24	8.384	4.671
11/8/2006	11:42:40	12.289	8.387	5.178
11/8/2006	11:43:39	12.357	8.374	4.779
11/8/2006	11:44:40	12.355	8.389	4.552
11/8/2006	11:45:40	12.378	8.377	4.56
11/8/2006	11:46:40	12.36	8.377	4.514
11/8/2006	11:47:40	12.359	8.372	4.604
11/8/2006	11:48:40	12.368	8.358	4.288
11/8/2006	11:49:40	12.356	8.366	4.336
11/8/2006	11:50:39	12.368	8.369	4.35
11/8/2006	11:51:40	12.311	8.37	4.163
11/8/2006	11:52:40	12.295	8.369	4.236
11/8/2006	11:53:40	12.353	8.354	4.13
Average of Test Run		O2 OT	CO2 OT	CO
		%	%	ppm
11/8/2006	11:53:40	12.335	8.371	4.416

Test Run 2 End

Final System Bias Check for Run 2 . STRATA Version 2.01

		O2 OT	CO2 OT	CO
		%	%	ppm
11/8/2006	11:55:02	6.617	3.981	3.873
11/8/2006	11:56:02	0.341	0.07	1.499
11/8/2006	11:57:02	0.32	0.047	0.075
11/8/2006	11:58:02	0.319	0.04	0.131
11/8/2006	11:59:01	3.208	2.415	0.186
11/8/2006	12:00:02	12.448	9.595	-0.782
11/8/2006	12:01:02	12.459	9.654	-1.242
11/8/2006	12:02:01	2.29	1.81	0.095
11/8/2006	12:03:01	-0.304	0.054	6.728
11/8/2006	12:04:01	-0.31	0.036	8.95

Final System Bias Check for Run 2

Operator: W. Quentin Best
 Plant Name: TECO Polk Plant
 Location: UNit 1

Reference Cylinder Numbers

	Zero	Span
O2 OT	CC-136551	CC-107096
CO2 OT	CC-136551	CC-107096
CO	CC-136551	CC-165111

Date/Time	11/8/2006	12:04:39	PASSED
Analyte	O2 OT	CO2 OT	CO
Units	%	%	ppm
Zero Ref Cyl	0	0	0
Zero Cal	0.052	0.011	0.128
Zero Avg	0.32	0.04	0.165
Zero Bias%	1.1	0.1	0.2
Zero Drift%	0.4	0	0.5
Span Ref Cyl	12.5	9.81	9.26
Span Cal	12.548	9.898	9.221
Span Avg	12.46	9.634	9.129
Span Bias%	0.4	1.3	0.6
Span Drift%	0.1	-0.4	0.1
Ini Zero Avg	0.225	0.042	0.093
Ini Span Avg	12.444	9.722	9.117
Run Avg	12.335	8.371	4.416
Co	0.272	0.041	0.129
Cm	12.452	9.678	9.123
Correct Avg	12.38	8.48	4.413

Test Run 3 Begin. STRATA Version 2.01

Operator: W. Quentin Best

Plant Name: TECO Polk Plant

Location: UNit 1

		O2 OT	CO2 OT	CO
		%	%	ppm
11/8/2006	12:05:40	-0.269	0.027	9.081
11/8/2006	12:06:40	10.788	7.451	7.884
11/8/2006	12:07:40	12.274	8.358	5.069
11/8/2006	12:08:40	12.301	8.358	4.95
11/8/2006	12:09:40	12.328	8.362	4.711
11/8/2006	12:10:40	12.352	8.369	4.566
11/8/2006	12:11:40	12.317	8.353	4.448
11/8/2006	12:12:40	12.283	8.359	4.596
11/8/2006	12:13:40	12.356	8.35	4.363
11/8/2006	12:14:40	12.364	8.367	4.232
11/8/2006	12:15:40	12.369	8.368	4.3
11/8/2006	12:16:40	12.371	8.353	4.411
11/8/2006	12:17:40	12.393	8.345	4.253
11/8/2006	12:18:40	12.395	8.354	3.861
11/8/2006	12:19:40	12.373	8.359	4.047
11/8/2006	12:20:40	12.377	8.365	4.236
11/8/2006	12:21:40	12.29	8.368	4.441
11/8/2006	12:22:40	12.33	8.37	4.625
11/8/2006	12:23:40	12.386	8.356	4.092
11/8/2006	12:24:40	12.379	8.376	3.795
11/8/2006	12:25:40	12.382	8.378	3.968
11/8/2006	12:26:39	12.406	8.366	4.082
11/8/2006	12:27:39	12.348	8.403	3.655
11/8/2006	12:28:40	12.346	8.389	3.698
11/8/2006	12:29:40	12.347	8.388	4.222
11/8/2006	12:30:40	12.35	8.392	4.296
11/8/2006	12:31:40	12.316	8.385	4.299
Begin calculating run averages				
11/8/2006	12:32:43	12.271	8.391	4.437
11/8/2006	12:33:43	12.306	8.411	4.688
11/8/2006	12:34:43	12.354	8.394	4.616
11/8/2006	12:35:43	12.359	8.397	4.199
11/8/2006	12:36:43	12.361	8.377	4.01
11/8/2006	12:37:43	12.376	8.369	3.562
11/8/2006	12:38:42	12.365	8.383	3.802
11/8/2006	12:39:42	12.376	8.372	3.886
11/8/2006	12:40:43	12.369	8.381	3.755
11/8/2006	12:41:43	12.268	8.397	4.049
11/8/2006	12:42:43	12.319	8.386	4.501
11/8/2006	12:43:43	12.373	8.382	4.091
11/8/2006	12:44:43	12.385	8.385	3.789
11/8/2006	12:45:42	12.39	8.374	3.819
11/8/2006	12:46:42	12.379	8.385	3.577
11/8/2006	12:47:43	12.373	8.407	3.358
11/8/2006	12:48:43	12.366	8.407	3.923
11/8/2006	12:49:43	12.363	8.404	4.078

Test Run 3 Begin. STRATA Version 2.01

Operator: W. Quentin Best
 Plant Name: TECO Polk Plant
 Location: UNit 1

		O2 OT	CO2 OT	CO
		%	%	ppm
11/8/2006	12:50:43	12.358	8.409	4.226
11/8/2006	12:51:43	12.305	8.41	4.364
11/8/2006	12:52:42	12.29	8.403	4.364
11/8/2006	12:53:42	12.357	8.397	4.141
11/8/2006	12:54:43	12.371	8.418	3.842
11/8/2006	12:55:43	12.364	8.419	3.939
11/8/2006	12:56:43	12.347	8.43	4.12
11/8/2006	12:57:43	12.353	8.43	4.194
11/8/2006	12:58:43	12.363	8.424	4.339
11/8/2006	12:59:42	12.355	8.435	4.079
11/8/2006	13:00:42	12.341	8.437	4.094
11/8/2006	13:01:43	12.271	8.418	4.179
11/8/2006	13:02:43	12.323	8.419	4.381
11/8/2006	13:03:43	12.344	8.42	4.276
11/8/2006	13:04:43	12.349	8.425	4.439
11/8/2006	13:05:43	12.358	8.424	4.249
11/8/2006	13:06:42	12.356	8.414	4.349
11/8/2006	13:07:42	12.359	8.4	4.389
11/8/2006	13:08:43	12.374	8.392	4.018
11/8/2006	13:09:43	12.364	8.393	4.006
11/8/2006	13:10:43	12.361	8.398	3.945
11/8/2006	13:11:43	12.295	8.416	4.192
11/8/2006	13:12:43	12.257	8.426	4.699
11/8/2006	13:13:42	12.284	8.437	4.828
11/8/2006	13:14:42	12.328	8.42	4.943
11/8/2006	13:15:43	12.322	8.428	4.457
11/8/2006	13:16:43	12.315	8.419	4.351
11/8/2006	13:17:43	12.3	8.415	4.486
11/8/2006	13:18:43	12.299	8.413	4.567
11/8/2006	13:19:43	12.315	8.418	4.57
11/8/2006	13:20:42	12.326	8.415	4.658
11/8/2006	13:21:42	12.245	8.415	4.068
11/8/2006	13:22:43	12.283	8.416	4.405
11/8/2006	13:23:43	12.297	8.43	4.55
11/8/2006	13:24:43	12.309	8.42	4.675
11/8/2006	13:25:43	12.283	8.439	4.608
11/8/2006	13:26:43	12.293	8.432	4.725
11/8/2006	13:27:42	12.279	8.46	4.757
11/8/2006	13:28:42	12.297	8.447	4.599
11/8/2006	13:29:43	12.31	8.436	4.863
11/8/2006	13:30:43	12.316	8.43	4.451
11/8/2006	13:31:43	12.25	8.439	4.382
Average of Test Run		O2 OT	CO2 OT	CO
		%	%	ppm
11/8/2006	13:31:43	12.33	8.411	4.265

Test Run 3 End

Final System Bias Check for Run 3 . STRATA Version 2.01

		O2 OT	CO2 OT	CO
		%	%	ppm
11/8/2006	13:33:14	4.617	2.765	4.786
11/8/2006	13:34:13	0.335	0.116	1.439
11/8/2006	13:35:14	0.328	0.097	0.041
11/8/2006	13:36:14	0.308	0.088	0.245
11/8/2006	13:37:14	7.672	5.945	-0.124
11/8/2006	13:38:14	12.451	9.636	-0.973
11/8/2006	13:39:14	12.456	9.669	-1.202
11/8/2006	13:40:13	12.218	9.405	-1.32
11/8/2006	13:41:13	-0.069	0.199	1.118
11/8/2006	13:42:13	-0.301	0.105	7.707
11/8/2006	13:43:13	-0.307	0.084	8.931
11/8/2006	13:44:13	-0.311	0.079	8.93
11/8/2006	13:45:13	-0.312	0.076	8.936

Final System Bias Check for Run 3

Operator: W. Quentin Best
 Plant Name: TECO Polk Plant
 Location: UNit 1

Reference Cylinder Numbers

	Zero	Span
O2 OT	CC-136551	CC-107096
CO2 OT	CC-136551	CC-107096
CO	CC-136551	CC-165111

Date/Time	11/8/2006	13:45:25	PASSED
Analyte	O2 OT	CO2 OT	CO
Units	%	%	ppm
Zero Ref Cyl	0	0	0
Zero Cal	0.052	0.011	0.128
Zero Avg	0.312	0.09	0.225
Zero Bias%	1	0.4	0.6
Zero Drift%	0	0.3	0.4
Span Ref Cyl	12.5	9.81	9.26
Span Cal	12.548	9.898	9.221
Span Avg	12.456	9.677	8.932
Span Bias%	0.4	1.1	1.8
Span Drift%	0	0.2	-1.2
Ini Zero Avg	0.32	0.04	0.165
Ini Span Avg	12.46	9.634	9.129
Run Avg	12.33	8.411	4.265
Co	0.316	0.065	0.195
Cm	12.458	9.656	9.03
Correct Avg	12.368	8.537	4.265

Test Run 4 Begin, STRATA Version 2.01

Operator: W. Quentin Best
 Plant Name: TECO Polk Plant
 Location: UNit 1

		O2 OT	CO2 OT	CO
		%	%	ppm
11/8/2006	13:46:25	-0.277	0.07	8.762
11/8/2006	13:47:26	10.694	7.445	7.653
11/8/2006	13:48:26	12.279	8.43	4.9
11/8/2006	13:49:26	12.291	8.443	4.398
11/8/2006	13:50:26	12.284	8.45	4.588
11/8/2006	13:51:26	12.26	8.456	4.823
11/8/2006	13:52:26	12.201	8.465	4.901
11/8/2006	13:53:26	12.26	8.467	4.723
11/8/2006	13:54:26	12.274	8.48	4.634
11/8/2006	13:55:25	12.291	8.469	4.601
11/8/2006	13:56:25	12.306	8.435	4.384
11/8/2006	13:57:25	12.286	8.432	4.06
11/8/2006	13:58:25	12.288	8.43	4.185
11/8/2006	13:59:25	12.278	8.438	4.483
11/8/2006	14:00:25	12.275	8.453	4.526
11/8/2006	14:01:26	12.23	8.447	4.507
11/8/2006	14:02:26	12.204	8.461	4.877
11/8/2006	14:03:26	12.257	8.464	4.84
11/8/2006	14:04:25	12.274	8.456	4.829
11/8/2006	14:05:25	12.293	8.445	4.532
11/8/2006	14:06:25	12.317	8.433	4.427
11/8/2006	14:07:25	12.323	8.431	4.294
11/8/2006	14:08:26	12.326	8.44	4.508
11/8/2006	14:09:26	12.318	8.442	4.465
11/8/2006	14:10:26	12.347	8.424	4.532
11/8/2006	14:11:25	12.316	8.43	4.536
11/8/2006	14:12:25	12.247	8.432	4.714
11/8/2006	14:13:25	12.274	8.454	4.688
11/8/2006	14:14:25	12.304	8.458	4.75
11/8/2006	14:15:26	12.315	8.437	4.636
11/8/2006	14:16:26	12.322	8.42	4.367
11/8/2006	14:17:26	12.301	8.428	4.227
11/8/2006	14:18:25	12.328	8.406	4.449
11/8/2006	14:19:25	12.309	8.412	4.428
11/8/2006	14:20:25	12.305	8.403	4.756
11/8/2006	14:21:25	12.249	8.403	4.67
11/8/2006	14:22:26	12.237	8.393	4.901
11/8/2006	14:23:26	12.293	8.382	4.537
11/8/2006	14:24:26	12.306	8.378	4.254
11/8/2006	14:25:25	12.318	8.371	4.335
11/8/2006	14:26:25	12.328	8.374	4.097
11/8/2006	14:27:25	12.346	8.373	4.111
11/8/2006	14:28:25	12.331	8.394	3.702
11/8/2006	14:29:26	12.335	8.381	3.523
11/8/2006	14:30:26	12.309	8.41	4.47
11/8/2006	14:31:26	12.302	8.409	4.552

Test Run 4 Begin. STRATA Version 2.01

Operator: W. Quentin Best

Plant Name: TECO Polk Plant

Location: UNit 1

		O2 OT	CO2 OT	CO
		%	%	ppm
11/8/2006	14:32:25	12.229	8.414	4.529
11/8/2006	14:33:25	12.274	8.416	5.177
Begin calculating run averages				
11/8/2006	14:35:23	12.298	8.421	4.791
11/8/2006	14:36:24	12.309	8.411	4.61
11/8/2006	14:37:24	12.308	8.411	4.456
11/8/2006	14:38:24	12.3	8.427	4.534
11/8/2006	14:39:24	12.293	8.423	4.47
11/8/2006	14:40:24	12.281	8.431	4.519
11/8/2006	14:41:24	12.243	8.417	4.504
11/8/2006	14:42:24	12.206	8.411	5.014
11/8/2006	14:43:24	12.254	8.409	5.017
11/8/2006	14:44:24	12.272	8.398	4.931
11/8/2006	14:45:24	12.271	8.404	4.668
11/8/2006	14:46:24	12.282	8.4	4.673
11/8/2006	14:47:24	12.294	8.389	4.447
11/8/2006	14:48:24	12.295	8.388	4.088
11/8/2006	14:49:23	12.302	8.391	4.307
11/8/2006	14:50:23	12.303	8.404	4.271
11/8/2006	14:51:24	12.286	8.422	4.345
11/8/2006	14:52:24	12.209	8.423	4.571
11/8/2006	14:53:24	12.254	8.418	4.885
11/8/2006	14:54:24	12.275	8.417	4.718
11/8/2006	14:55:24	12.292	8.419	5.025
11/8/2006	14:56:23	12.318	8.397	4.722
11/8/2006	14:57:23	12.301	8.413	4.448
11/8/2006	14:58:24	12.31	8.405	4.443
11/8/2006	14:59:24	12.314	8.41	4.467
11/8/2006	15:00:24	12.323	8.408	4.496
11/8/2006	15:01:24	12.275	8.396	4.373
11/8/2006	15:02:24	12.238	8.409	4.596
11/8/2006	15:03:23	12.291	8.399	4.598
11/8/2006	15:04:23	12.29	8.407	4.329
11/8/2006	15:05:24	12.311	8.38	4.194
11/8/2006	15:06:24	12.295	8.397	4.12
11/8/2006	15:07:24	12.289	8.399	4.605
11/8/2006	15:08:24	12.299	8.409	4.647
11/8/2006	15:09:24	12.314	8.4	4.565
11/8/2006	15:10:23	12.3	8.418	4.536
11/8/2006	15:11:23	12.297	8.403	4.653
11/8/2006	15:12:24	12.213	8.41	4.83
11/8/2006	15:13:24	12.238	8.419	4.854
11/8/2006	15:14:24	12.26	8.425	4.946
11/8/2006	15:15:24	12.277	8.429	4.799
11/8/2006	15:16:24	12.291	8.415	4.423
11/8/2006	15:17:24	12.291	8.412	4.458

Test Run 4 Begin. STRATA Version 2.01

Operator: W. Quentin Best

Plant Name: TECO Polk Plant

Location: UNit 1

		O2 OT	CO2 OT	CO
		%	%	ppm
11/8/2006	15:18:24	12.297	8.406	4.36
11/8/2006	15:19:24	12.302	8.414	4.417
11/8/2006	15:20:24	12.311	8.414	4.604
11/8/2006	15:21:24	12.284	8.403	4.368
11/8/2006	15:22:23	12.239	8.409	4.558
11/8/2006	15:23:23	12.306	8.397	4.58
11/8/2006	15:24:24	12.336	8.405	4.023
11/8/2006	15:25:24	12.319	8.42	4.141
11/8/2006	15:26:24	12.313	8.423	4.473
11/8/2006	15:27:24	12.321	8.426	4.507
11/8/2006	15:28:24	12.323	8.435	4.379
11/8/2006	15:29:23	12.309	8.449	4.115
11/8/2006	15:30:23	12.324	8.438	4.278
11/8/2006	15:31:24	12.319	8.426	4.344
11/8/2006	15:32:24	12.219	8.455	4.395
11/8/2006	15:33:24	12.259	8.453	4.77
11/8/2006	15:34:24	12.305	8.446	4.441
Average of Test Run		O2 OT	CO2 OT	CO
		%	%	ppm
11/8/2006	15:34:24	12.287	8.413	4.528

Test Run 4 End

Final System Bias Check for Run 4 . STRATA Version 2.01

		O2 OT	CO2 OT	CO
		%	%	ppm
11/8/2006	15:35:59	10.319	6.692	4.247
11/8/2006	15:36:58	0.415	0.181	3.13
11/8/2006	15:37:58	0.379	0.144	0.29
11/8/2006	15:38:58	0.372	0.132	-0.048
11/8/2006	15:39:58	11.388	8.73	-0.356
11/8/2006	15:40:58	12.47	9.67	-1.323
11/8/2006	15:41:59	2.944	2.395	-0.325
11/8/2006	15:42:58	-0.3	0.149	6.232
11/8/2006	15:43:58	-0.306	0.132	8.718
11/8/2006	15:44:58	-0.31	0.121	8.771

Final System Bias Check for Run 4

Operator: W. Quentin Best

Plant Name: TECO Polk Plant

Location: UNit 1

Reference Cylinder Numbers

	Zero	Span
O2 OT	CC-136551	CC-107096
CO2 OT	CC-136551	CC-107096
CO	CC-136551	CC-165111

Date/Time	11/8/2006	15:45:31	PASSED
Analyte	O2 OT	CO2 OT	CO
Units	%	%	ppm
Zero Ref Cyl	0	0	0
Zero Cal	0.052	0.011	0.128
Zero Avg	0.379	0.134	0.054
Zero Bias%	1.3	0.6	0.5
Zero Drift%	0.3	0.2	-1.1
Span Ref Cyl	12.5	9.81	9.26
Span Cal	12.548	9.898	9.221
Span Avg	12.47	9.655	8.738
Span Bias%	0.3	1.2	3
Span Drift%	0.1	-0.1	-1.2
Ini Zero Avg	0.312	0.09	0.225
Ini Span Avg	12.456	9.677	8.932
Run Avg	12.287	8.413	4.528
Co	0.345	0.112	0.14
Cm	12.463	9.666	8.835
Correct Avg	12.319	8.524	4.673

CALIBRATION GAS CERTIFICATIONS



Certificate of Analysis

EPA Protocol

Performed according to EPA-600/R-97/121, Procedure G1

Notice: This Cylinder is not to be used when pressure is under 150 psig.

Manufactured and certified at:

Linde Gas LLC
Maumee Specialty Gas Plant
6421 Monclova Road
MAUMEE OH 43537
419-893-7226

Produced for customer:

MFD/HOLOX LTD
4236 STATESVILLE RD
CHARLOTTE NC 28269-4298
USA
704-596-6262

Material:	6132	Blend Tolerance:	5 % Relative
EPA CO/N2 3-9.9 PPM	A31	Store/Use Temp:	35 to 90 F
Production #:	100065596	Blend Type:	EPA Protocol
Lot #:	02499D3040GD	Cyl. Pressure:	2000 psig
Cylinder #:	CC165111	Balance Gas:	Nitrogen
Expiration Date:	11/16/2009	CGA:	350
Shelf Life:	36 months	Analytical Accuracy:	1.00 % Relative

CAS #	Certified Component	Requested Concentration	Concentration and Uncertainty	Date of Certification
630-08-0	Carbon Monoxide	9	9.28 +/- 0.1 ppm	11/16/2006
7727-37-9	Nitrogen		Balance	11/16/2006
630-08-0	Carbon Monoxide	9	9.26 +/- 0.18 ppm	04/15/2003
7727-37-9	Nitrogen		Balance	04/15/2003

CAS #	Reference Standard	Cylinder/Standard #	Concentration	Expire Date
630-08-0	Carbon Monoxide	CC180333 , NTRM	10.17 ppm	07/11/2009

Instrument	Serial #	Analytical Principle	Calibration Date
MCTa FTIR	AET0600294	FTIR	11/16/2006

All analyses are performed under controlled environmental conditions. This product is manufactured using equipment which has been calibrated with NIST traceable, or equivalent, standards, weights, or equipment.

Linde Gas LLC

6055 Rockside Woods Blvd. Greg Eccleston
Independence, OH 44131
USA
Phone: (216) 642-6600
Fax: (216) 647-9675
www.us.lindegas.com

HiQ Analysis Certificate



P. O. Box 12013
Research Triangle Park, N.C. 27709
Phone 919/544-3772

CERTIFICATE OF ANALYSIS: EPA PROTOCOL GAS MIXTURE

Customer:	National Welders, Charlotte, NC	Reference #	88-94904
NSG PO#	4704164	Certification Date:	12/28/04
Customer PO#		Expiration Date:	12/28/07
Cylinder #	CC50737	Pressure, psig*	2000

ANALYTICAL INFORMATION

METHOD: This standard was analyzed according to EPA Traceability Protocol for Assay and Certification of Gaseous Calibration Standards: Procedure G1 (September 1997)

ANALYZED CYLINDER

<u>Components</u>	<u>Certified Concentration</u>	<u>Analytical Accuracy**</u>
Carbon Monoxide	29.6 ppm	+/-1%
Balance - Nitrogen		

REFERENCE STANDARD

<u>Type/SRM Sample #</u>	<u>Cylinder #</u>	<u>Concentration</u>
GMIS (Traceable to SRM # 1678c)	CC67177	50.2 ppm CO/N2

INSTRUMENTATION

<u>Instrument/Model/Serial #</u>	<u>Last Date Calibrated</u>	<u>Analytical Method</u>
Rosemount 880A CO 00172	12/08/04	Non-dispersive Infrared

Analyst:  Jeremy Kenworthy

This report states accurately the results of the investigation made upon the material submitted to the analytical laboratory. Every effort has been made to determine objectively the information requested. However, in connection with this report, National Specialty Gases shall have no liability in excess of established charge for this service. Assayed at National Specialty Gases, 630 United Drive, Durham, NC 27713 (919) 544-3772

*Do not use this standard when cylinder pressure is below 150 psig.

**Analytical accuracy includes typical known error sources which, at least, include precision of the analytical instrument.



Certificate of Analysis

HiQ® EPA Protocol
 Formed according to EPA-800/R-01/02, Procedure G1

Notice: This Cylinder is not to be used when pressure is under 150 psig.

Manufactured and certified at:

Linde Gas LLC
 Charlotte
 4236 Statesville Road
 CHARLOTTE NC 28269

Material:	18225	Blend Tolerance:	5 % Relative
EPA 20-25% O2/16-20% CO2/N2	A31	Blend Type:	EPA Protocol
Production #:	100124043	Cyl. Pressure:	2000 psig
Lot #:	30499H6210DC	Balance Gas:	Nitrogen
Cylinder #:	CC250656	CGA:	590
Expiration Date:	8/25/2009	Analytical Accuracy:	1.00 % Relative
Shelf Life:	36 months	Confidence:	95 %

CAS #	Certified Component	Requested Concentration	Concentration and Uncertainty	Date of Certification
124-38-9	Carbon Dioxide	18	17.7 +/- 0.17 %	08/25/2006
7782-44-7	Oxygen	22	21.9 +/- 0.2 %	08/25/2006
7727-37-9	Nitrogen		Balance	

CAS #	Reference Standard	Cylinder/Standard #	Concentration	Expir. Date
7782-44-7	Oxygen	AT9284 , GMIS	21.04 %	03/17/2009
124-38-9	Carbon Dioxide	CC234661 , GMIS	18.11 %	03/29/2009

Instrument	Serial #	Analytical Principle	Calibration Date
Teledyne 3000M	240141	Paramagnetic	05/24/2005
HORIBA MODEL VIA-510 CO2	4285416002	NDIR	11/22/2005

All analyses are performed under controlled environmental conditions. This product is manufactured using equipment which has been calibrated with NIST traceable, or equivalent, standards, weights, or equipment.

Analytical report approved by Lance Crayton



Linde Gas



Certificate of Analysis EPA Protocol

Performed according to EPA-600/R-97/121, Procedure G1

Notice: This Cylinder is not to be used when pressure is under -150 psig.

Manufactured and certified at:

Linde Gas LLC
Charlotte
4236 Statesville Road
CHARLOTTE NC 28269

Material:	18224	Blend Tolerance:	5 % Relative
EPA 10-15% O2/8-12% CO2/N2	A31	Blend Type:	EPA Protocol
Production #:	100118070	Cyl. Pressure:	2000 psig
Lot #:	30499E6010CC	Balance Gas:	Nitrogen
Cylinder #:	CC107096	CGA:	590
Expiration Date:	5/8/2009	Analytical Accuracy:	1.00 % Relative
Shelf Life:	36 months	Confidence:	95 %

CAS #	Certified Component	Requested Concentration	Concentration and Uncertainty	Date of Certification
7782-44-7	Oxygen	10 to 15	12.5 +/- 0.09 %	05/08/2006
124-38-9	Carbon Dioxide	8 to 12	9.81 +/- 0.09 %	05/08/2006
7727-37-9	Nitrogen		Balance	

CAS #	Reference Standard	Cylinder/Standard #	Concentration	Expiry Date
7782-44-7	Oxygen	112347 , GMIS	10.01 %	05/02/2009
124-38-9	Carbon Dioxide	HO2290685Y , GMIS	14.01 %	05/02/2009

Instrument	Serial #	Analytical Principle	Calibration Date
Teledyne 3000M	240141	Paramagnetic	05/08/2006
HORIBA MODEL VIA-510 CO2	4285416002	NDIR	05/08/2006

All analyses are performed under controlled environmental conditions. This product is manufactured using equipment which has been calibrated with NIST traceable, or equivalent, standards, weights, or equipment.

Analytical report approved by Lance Crayton

Lance Crayton

Analysis Certificate



Certificate of Analysis
 EPA Protocol
HiQ® Certificate
 Formed according to EPA Method 9712, Procedure G1

Notice: This Cylinder is not to be used when pressure is under 150 psig.

Manufactured and certified at:

Linde Gas LLC
 Charlotte
 4236 Statesville Road
 CHARLOTTE NC 28269

Material:	13968		Blend Tolerance:	5 % Relative
EPA 13 - 18 PPM CO/N2		A31	Blend Type:	GRAVIMETRIC
Production #:	100121715		Cyl. Pressure:	2000 psig
Lot #:	30499G6060DC		Balance Gas:	Nitrogen
Cylinder #:	CC150548		CGA:	350
Expiration Date:	7/19/2009		Analytical Accuracy:	1.00 % Relative
Shelf Life:	36 months		Confidence:	95 %

CAS #	Certified Component	Requested Concentration	Concentration and Uncertainty	Date of Certification
630-08-0	Carbon Monoxide	13 to 18	15.9 +/- 0.18 ppm	07/19/2006
7727-37-9	Nitrogen		Balance	07/19/2006

CAS #	Reference Standard	Cylinder/Standard #	Concentration	Expiry Date
630-08-0	Carbon Monoxide	CC180333 , NTRM	10.17 ppm	07/11/2009

Instrument	Serial #	Analytical Principle	Calibration Date
HORIBA MODEL VIA-510 CO	4345887002	NDIR	07/19/2006

All analyses are performed under controlled environmental conditions. This product is manufactured using equipment which has been calibrated with NIST traceable, or equivalent, standards, weights, or equipment.

Analytical report approved by Greg Eccleston





Certificate of Analysis
 EPA Protocol
 HiQ® Certificate
 Formed according to EPA 400/R-97/124 Procedure G1

Notice: This Cylinder is not to be used when pressure is under 150 psig.

Manufactured and certified at:

Linde Gas LLC
 Charlotte
 4236 Statesville Road
 CHARLOTTE NC 28269

Material:	13970	Blend Tolerance:	5 % Relative
EPA 43 - 47 PPM CO/N2	A31	Blend Type:	GRAVIMETRIC
Production #:	100121717	Cyl. Pressure:	2000 psig
Lot #:	30499G6060DB	Balance Gas:	Nitrogen
Cylinder #:	CC149754	CGA:	350
Expiration Date:	7/19/2009	Analytical Accuracy:	1.00 % Relative
Shelf Life:	36 months	Confidence:	95 %

CAS #	Certified Component	Requested Concentration	Concentration and Uncertainty	Date of Certification
630-08-0	Carbon Monoxide	43 to 47	46.3 +/- 0.3 ppm	07/19/2006
7727-37-9	Nitrogen		Balance	07/19/2006

CAS #	Reference Standard	Cylinder Standard #	Concentration	Expire Date
630-08-0	Carbon Monoxide	CC179892 , NTRM	49.33 ppm	07/11/2009

Instrument	Serial #	Analytical Principle	Calibration Date
HORIBA MODEL VIA-510 CO	4345887002	NDIR	07/19/2006

All analyses are performed under controlled environmental conditions. This product is manufactured using equipment which has been calibrated with NIST traceable, or equivalent, standards, weights, or equipment.

Analytical report approved by Greg Eccleston





Certificate of Analysis
 HiQ® EPA Protocol
 Certificate
 Formed according to EPA 600/4-97/129 Procedure G1

Notice: This Cylinder is not to be used when pressure is under 150 psig.

Manufactured and certified at:
 Linde Gas LLC
 Charlotte
 4236 Statesville Road
 CHARLOTTE NC 28269

Material:	18246	Blend Tolerance:	5 % Relative
EPA 60 PPM CO/N2 (+/-2%)	A31	Blend Type:	EPA Protocol
Production #:	100118386	Cyl. Pressure:	2000 psig
Lot #:	30499E6050DD	Balance Gas:	Nitrogen
Cylinder #:	CC174902	CGA:	350
Expiration Date:	7/12/2009	Analytical Accuracy:	1.00 % Relative
Shelf Life:	36 months	Confidence:	95 %

CAS #	Certified Component	Requested Concentration	Concentration and Uncertainty	Date of Certification
630-08-0	Carbon Monoxide	60	61.7 ppm	07/12/2006
7727-37-9	Nitrogen		Balance	

CAS #	Reference Standard	Cylinder Standard #	Concentration	Expire Date
630-08-0	Carbon Monoxide	CC179892 , NTRM	49.33 ppm	07/11/2009

Instrument	Serial #	Analytical Principle	Calibration Date
HORIBA MODEL VIA-510 CO	4345887002	NDIR	07/12/2006

All analyses are performed under controlled environmental conditions. This product is manufactured using equipment which has been calibrated with NIST traceable, or equivalent, standards, weights, or equipment.

Analytical report approved by Lance Crayton



Certificate of Analysis
EPA Protocol

Performed according to EPA-600/R-97/121, Procedure G1

Notice: This Cylinder is not to be used when pressure is under 150 psig.

Manufactured and certified at:

Linde Gas LLC
Charlotte
4236 Statesville Road
CHARLOTTE NC 28269

Material:	6198	Blend Tolerance:	5 % Relative
EPA CO/N2 100-999 PPM	A31	Blend Type:	EPA Protocol
Production #:	100117213	Cyl. Pressure:	2000 psig
Lot #:	30499D6060DD	Balance Gas:	Nitrogen
Cylinder #:	CC237798	CGA:	350
Expiration Date:	4/18/2009	Analytical Accuracy:	1.00 % Relative
Shelf Life:	36 months	Confidence:	95 %

CAS #	Certified Component	Requested Concentration	Concentration and Uncertainty	Date of Certification
630-08-0	Carbon Monoxide	100	101 +/- 0.7 ppm	04/18/2006
7727-37-9	Nitrogen		Balance	

CAS #	Reference Standard	Cylinder/Standard #	Concentration	Expire Date
630-08-0	Carbon Monoxide	CC179992 , NTRM	99.49 ppm	07/11/2009

Instrument	Serial #	Analytical Principle	Calibration Date
HORIBA MODEL VIA-510 CO	4345887002	NDIR	04/18/2006

All analyses are performed under controlled environmental conditions. This product is manufactured using equipment which has been calibrated with NIST traceable, or equivalent, standards, weights, or equipment.

Analytical report approved by Lance Crayton

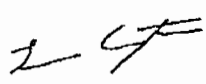

 **Analysis Certificate**

Certificate of Analysis

EPA Protocol

Performed according to EPA-600/R-97/121, Procedure G1

Notice: This Cylinder is not to be used when pressure is under 150 psig.

Manufactured and certified at:

Linde Gas LLC
 Charlotte
 4236 Statesville Road
 CHARLOTTE NC 28269

Material:	2179	Blend Tolerance:	5 % Relative
MISC 3 COMPONENT EPA	A31	Blend Type:	EPA Protocol
Production #:	100115060	Cyl. Pressure:	2000 psig
Lot #:	30499B6100DB	Balance Gas:	Nitrogen
Cylinder #:	CC7551	CGA:	590
Expiration Date:	2/21/2009	Analytical Accuracy:	1.00 % Relative
Shelf Life:	36 months	Confidence:	95 %

CAS #	Certified Component	Requested Concentration	Concentration and Uncertainty	Date of Certification
630-08-0	Carbon Monoxide	100	101 +/- 0.7 ppm	02/21/2006
7782-44-7	Oxygen	11	11.0 +/- 0.08 %	02/14/2006
7727-37-9	Nitrogen		Balance	

CAS #	Reference Standard	Cylinder/Standard #	Concentration	Expiry Date
7782-44-7	Oxygen	CC73289 , NTRM	9.90 %	06/13/2009
630-08-0	Carbon Monoxide	CC179992 , NTRM	99.49 ppm	07/11/2009

Instrument	Serial #	Analytical Principle	Calibration Date
Teledyne 3000M	240141	Paramagnetic	02/14/2006
HORIBA MODEL VIA-510 CO	4345887002	NDIR	02/21/2006

All analyses are performed under controlled environmental conditions. This product is manufactured using equipment which has been calibrated with NIST traceable, or equivalent, standards, weights, or equipment.

Analytical report approved by Lance Crayton

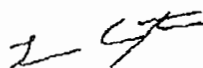



P. O. Box 12013
Research Triangle Park, N.C. 27709
Phone 919/544-3772

CERTIFICATE OF ANALYSIS

CERTIFIED MIXTURE

Customer: National Welders
Charlotte, NC

Reference #: 88-99088
Cylinder #: CC85291
Order #: 5031323
Date Reported: 8/8/2005
Expiration Date: 8/8/2008

Component	Specification	Concentration / *Cert. Accuracy	Analytical Method
Oxygen	12%	12.0% +/- 2%	Paramagnetic
Carbon Dioxide	10%	10.0% +/- 2%	Non-Dispersive Infrared
Balance - Nitrogen			

Carolyn S. Williams
Analyst Carolyn S. Williams

* CERTIFICATION ACCURACY IS A PERCENTAGE (+/-) OF THE COMPONENT
THIS REPORT STATES ACCURATELY THE RESULTS OF THE INVESTIGATION MADE UPON THE MATERIAL SUBMITTED TO THE ANALYTICAL LABORATORY
EVERY EFFORT HAS BEEN MADE TO DETERMINE OBJECTIVELY THE INFORMATION REQUESTED. HOWEVER, IN CONNECTION WITH ITS RENDERING OF THIS REPORT,
NATIONAL SPECIALTY GASES SHALL HAVE NO LIABILITY IN EXCESS OF THE ESTABLISHED CHARGE FOR THE SERVICE

APPENDIX E

INSTRUMENTAL REFERENCE METHOD TEST DATA – SULFURIC ACID
PLANT

SULFUR DIOXIDE, OXYGEN, CARBON DIOXIDE SUMMARY

LabView QA Data

Polk Acid Plant - Report			
RUN 1			
	11/8/2006	10:30:25	
Linearity Check - Calibration Error	O2	SO2	CO22
Analyzer Range	25	300	50
Units	%	PPM	%
Low Level Certified Value (PPM or %)			
Mid Level Certified Value (PPM or %)	10.1	152.2	25.07
High Level Certified Value (PPM or %)	20.9	269	45.1
Zero Level Observed	0.002	0.437	-0.002
Low Level Observed	-	-	-
Mid Level Observed	10.134	152.312	24.902
High Level Observed	20.999	270.064	44.923
Actual Zero From Linearity	0.002	0.437	-0.002
Actual Span From Linearity	10.134	152.312	24.902
Initial Readings			
Zero	0.002	2.78	0.12
Span	10.012	149.237	24.536
Final Readings			
Zero	0.002	1.755	0.12
Span	10.073	151.434	24.78
Run Results			
Raw Results	6.03	127.98	26.07
Corrected Results (ppmv)	6.06	129.22	26.51
Polk Acid Plant - Report			
RUN 2			
	11/8/2006	12:30:13	
Initial Readings			
Zero	0.002	1.755	0.12
Span	10.073	151.434	24.78
Final Readings			
Zero	0.002	1.901	0.12
Span	10.012	155.681	24.78
Run Results			
Raw Results	6.37	125.98	25.89
Corrected Results (ppmv)	6.41	124.54	26.2
Polk Acid Plant - Report			
RUN 3			
	11/8/2006	14:28:02	
Initial Readings			
Zero	0.002	1.901	0.12
Span	10.012	155.681	24.78
Final Readings			
Zero	0.002	1.169	0.12
Span	10.073	154.07	24.78
Run Results			
Raw Results	6.46	120.43	26.03
Corrected Results (ppmv)	6.5	118.01	26.34

QUALITY ASSURANCE ACTIVITIES



**POLK POWER STATION
EMISSIONS UNIT ID 004**

INSTRUMENTAL REFERENCE METHOD QUALITY ASSURANCE CALCULATIONS

**SULFURIC ACID PLANT
Analyzer Calibration Error**

ACE = $((C_{Dir} - C_V) / CS) \times 100$

Eq. 7E-1

		O₂	SO₂	CO₂
Low-level gas	C_{Dir} =	n/a	n/a	n/a
	C_V =	n/a	n/a	n/a
	CS =	n/a	n/a	n/a
	C_{Dir} - C_V =	n/a	n/a	n/a
	(C_{Dir} - C_V) / CS =	n/a	n/a	n/a
	((C_{Dir} - C_V) / CS) x 100 =	n/a	n/a	n/a
Mid-level gas	C_{Dir} =	10.134	152.312	24.902
	C_V =	10.1	152.2	25.07
	CS =	20.9	269	45.1
	C_{Dir} - C_V =	0.034	0.112	-0.168
	(C_{Dir} - C_V) / CS =	0.00163	0.00042	-0.00373
	((C_{Dir} - C_V) / CS) x 100 =	0.16	0.04	-0.37
High-level gas	C_{Dir} =	20.999	270.064	44.923
	C_V =	20.9	269	45.1
	CS =	20.9	269	45.1
	C_{Dir} - C_V =	0.099	1.064	-0.177
	(C_{Dir} - C_V) / CS =	0.00474	0.00396	-0.00392
	((C_{Dir} - C_V) / CS) x 100 =	0.47	0.40	-0.39

Performance Specification is:

ACE ± 2% or $|C_{Dir} - C_V| \leq 0.5$ ppm or 0.5 % volume



**POLK POWER STATION
EMISSIONS UNIT ID 004
INSTRUMENTAL REFERENCE METHOD QUALITY ASSURANCE CALCULATIONS**

**COMBINED CYCLE COMBUSTION TURBINE - CT1A
System Bias Calculations**

SB = ((C_S - C_{Dir}) / CS) x 100

Eq. 7E-2

		O₂	SO₂	CO₂
Initial Zero	C_S =	0.002	2.78	0.12
	C_{Dir} =	0.002	0.437	-0.002
	CS =	20.9	269	45.1
	(C_S - C_{Dir}) =	0.000	2.343	0.122
	(C_S - C_{Dir}) / CS =	0.00000	0.00871	0.00271
	((C_S - C_{Dir}) / CS) x 100 =	0.00	0.87	0.27

		O₂	SO₂	CO₂
Initial Span	C_S =	10.012	149.237	24.536
	C_{Dir} =	10.134	152.312	24.902
	CS =	20.9	269	45.1
	(C_S - C_{Dir}) =	-0.122	-3.075	-0.366
	(C_S - C_{Dir}) / CS =	-0.00584	-0.01143	-0.00812
	((C_S - C_{Dir}) / CS) x 100 =	-0.58	-1.14	-0.81

		O₂	SO₂	CO₂
Run 1 Post Run Zero	C_S =	0.002	1.755	0.12
	C_{Dir} =	0.002	0.437	-0.002
	CS =	20.9	269	45.1
	(C_S - C_{Dir}) =	0.000	1.318	0.122
	(C_S - C_{Dir}) / CS =	0.00000	0.00490	0.00271
	((C_S - C_{Dir}) / CS) x 100 =	0.00	0.49	0.27



**POLK POWER STATION
EMISSIONS UNIT ID 004**

INSTRUMENTAL REFERENCE METHOD QUALITY ASSURANCE CALCULATIONS

**COMBINED CYCLE COMBUSTION TURBINE - CT1A
System Bias Calculations**

		O₂	SO₂	CO₂
Run 1 Post Run Span	C_S =	10.073	151.434	24.78
	C_{Dir} =	10.134	152.312	24.902
	CS =	20.9	269	45.1
	(C_S - C_{Dir}) =	-0.061	-0.878	-0.122
	(C_S - C_{Dir}) / CS =	-0.00292	-0.00326	-0.00271
	((C_S - C_{Dir}) / CS) x 100 =	-0.29	-0.33	-0.27

		O₂	SO₂	CO₂
Run 2 Post Run Zero	C_S =	0.002	1.901	0.12
	C_{Dir} =	0.002	0.437	-0.002
	CS =	20.9	269	45.1
	(C_S - C_{Dir}) =	0.000	1.464	0.122
	(C_S - C_{Dir}) / CS =	0.00000	0.00544	0.00271
	((C_S - C_{Dir}) / CS) x 100 =	0.00	0.54	0.27

		O₂	SO₂	CO₂
Run 2 Post Run Span	C_S =	10.012	155.681	24.78
	C_{Dir} =	10.134	152.312	24.902
	CS =	20.9	269	45.1
	(C_S - C_{Dir}) =	-0.122	3.369	-0.122
	(C_S - C_{Dir}) / CS =	-0.00584	0.01252	-0.00271
	((C_S - C_{Dir}) / CS) x 100 =	-0.58	1.25	-0.27



**POLK POWER STATION
EMISSIONS UNIT ID 004
INSTRUMENTAL REFERENCE METHOD QUALITY ASSURANCE CALCULATIONS**

**COMBINED CYCLE COMBUSTION TURBINE - CT1A
System Bias Calculations**

		O₂	SO₂	CO₂
Run 3 Post Run Zero	C_S =	0.002	1.169	0.12
	C_{Dir} =	0.002	0.437	-0.002
	CS =	20.9	269	45.1
	(C_S - C_{Dir}) =	0.000	0.732	0.122
	(C_S - C_{Dir}) / CS =	0.00000	0.00272	0.00271
	((C_S - C_{Dir}) / CS) x 100 =	0.00	0.27	0.27

		O₂	SO₂	CO₂
Run 3 Post Run Span	C_S =	10.073	154.07	24.78
	C_{Dir} =	10.134	152.312	24.902
	CS =	20.9	269	45.1
	(C_S - C_{Dir}) =	-0.061	1.758	-0.122
	(C_S - C_{Dir}) / CS =	-0.00292	0.00654	-0.00271
	((C_S - C_{Dir}) / CS) x 100 =	-0.29	0.65	-0.27

Performance Specification is:

SB ± 5% or |C_S - C_{dir}| ≤ 0.5 ppm or 0.5 % volume



**POLK POWER STATION
EMISSIONS UNIT ID 004
INSTRUMENTAL REFERENCE METHOD QUALITY ASSURANCE CALCULATIONS**

**COMBINED CYCLE COMBUSTION TURBINE - CT1A
Drift Assessment Calculations**

$D = SB_{final} - SB_i $		Eq. 7E-4		
		O_2	SO_2	CO_2
Run 1 Zero	$SB_{final} =$	0.00	0.49	0.27
	$SB_i =$	0.00	0.87	0.27
	$ SB_{final} - SB_i =$	0.00	0.38	0.00
Run 1 Span	$SB_{final} =$	-0.29	-0.33	-0.27
	$SB_i =$	-0.58	-1.14	-0.81
	$ SB_{final} - SB_i =$	0.29	0.82	0.54
Run 2 Zero	$SB_{final} =$	0.00	0.54	0.27
	$SB_i =$	0.00	0.49	0.27
	$ SB_{final} - SB_i =$	0.00	0.05	0.00
Run 2 Span	$SB_{final} =$	-0.58	1.25	-0.27
	$SB_i =$	-0.29	-0.33	-0.27
	$ SB_{final} - SB_i =$	0.29	1.58	0.00
Run 3 Zero	$SB_{final} =$	0.00	0.27	0.27
	$SB_i =$	0.00	0.54	0.27
	$ SB_{final} - SB_i =$	0.00	0.27	0.00
Run 3 Span	$SB_{final} =$	-0.29	0.65	-0.27
	$SB_i =$	-0.58	1.25	-0.27
	$ SB_{final} - SB_i =$	0.29	0.60	0.00

Performance Specification is:

$$D \pm 3\% \text{ of CS or } |C_{S \text{ post-run}} - C_{S \text{ pre-run}}| \leq 0.5 \text{ ppmv Or } 0.5 \% \text{ volume}$$



**POLK POWER STATION
EMISSIONS UNIT ID 004
INSTRUMENTAL REFERENCE METHOD QUALITY ASSURANCE CALCULATIONS**

**COMBINED CYCLE COMBUSTION TURBINE - CT1A
Effluent Gas Concentration**

$$C_{Gas} = (C_{Avg} - C_0) \times (C_{MA} / (C_M - C_0)) \quad \text{Eq. 7E-5}$$

		O₂	SO₂	CO₂
Run 1	C_{Avg} =	6.03	127.98	26.07
	C₀ =	0.002	2.2675	0.12
	C_{MA} =	10.1	152.2	25.07
	C_M =	10.0425	150.336	24.658
	(C_{Avg} - C₀) =	6.028	125.713	25.95
	(C_M - C₀) =	10.0405	148.068	24.538
	(C_{MA} / (C_M - C₀)) =	1.00593	1.02791	1.02168
	(C_{Avg} - C₀) x (C_{MA} / (C_M - C₀)) =	6.06	129.22	26.51

		O₂	SO₂	CO₂
Run 2	C_{Avg} =	6.37	125.98	25.89
	C₀ =	0.002	1.828	0.12
	C_{MA} =	10.1	152.2	25.07
	C_M =	10.0425	153.558	24.78
	(C_{Avg} - C₀) =	6.368	124.152	25.77
	(C_M - C₀) =	10.0405	151.73	24.66
	(C_{MA} / (C_M - C₀)) =	1.00593	1.0031	1.01663
	(C_{Avg} - C₀) x (C_{MA} / (C_M - C₀)) =	6.41	124.54	26.20



**POLK POWER STATION
 EMISSIONS UNIT ID 004
 INSTRUMENTAL REFERENCE METHOD QUALITY ASSURANCE CALCULATIONS**

**COMBINED CYCLE COMBUSTION TURBINE - CT1A
 Effluent Gas Concentration**

		O₂	SO₂	CO₂
Run 3	C_{Avg} =	6.46	120.43	26.03
	C₀ =	0.002	1.535	0.12
	C_{MA} =	10.1	152.2	25.07
	C_M =	10.0425	154.876	24.78
	(C_{Avg} - C₀) =	6.458	118.895	25.91
	(C_M - C₀) =	10.0405	153.341	24.66
	(C_{MA} / (C_M - C₀)) =	1.00593	0.99256	1.01663
	(C_{Avg} - C₀) x (C_{MA} / (C_M - C₀)) =	6.50	118.01	26.34

RUN LOG

LabView Run Log

Date	Time	Status	O2 (%)	SO2 (PPM)	CO22 (%)
11/8/2006	8:08:00 AM		0.12	0.58	0.12
11/8/2006	8:08:30 AM		0.06	0.44	0.12
11/8/2006	8:09:00 AM		-0.06	0.44	0.12
11/8/2006	8:09:30 AM		-0.06	0.44	0
11/8/2006	8:10:00 AM		-0.06	0.44	0.12
11/8/2006	8:10:30 AM	Linearity Check	0	0.44	0
11/8/2006	8:11:00 AM	Linearity Check	1.1	0.14	0
11/8/2006	8:11:30 AM	Linearity Check	9.46	0	6.71
11/8/2006	8:12:00 AM	Linearity Check	9.83	0	8.3
11/8/2006	8:12:30 AM	Linearity Check	10.13	0	8.3
11/8/2006	8:13:00 AM	Linearity Check	13.8	0	10.13
11/8/2006	8:13:30 AM	Linearity Check	20.88	0	15.75
11/8/2006	8:14:00 AM	Linearity Check	21.06	0	16.36
11/8/2006	8:14:30 AM	Linearity Check	11.48	0.14	26.73
11/8/2006	8:15:00 AM	Linearity Check	1.16	0.29	41.38
11/8/2006	8:15:30 AM	Linearity Check	-0.06	0.29	43.7
11/8/2006	8:16:00 AM	Linearity Check	-0.12	0.44	44.92
11/8/2006	8:16:30 AM	Linearity Check	-0.12	0.29	45.04
11/8/2006	8:17:00 AM	Linearity Check	0.61	0.14	44.92
11/8/2006	8:17:30 AM	Linearity Check	15.57	0	12.57
11/8/2006	8:18:00 AM	Linearity Check	4.76	0.14	19.65
11/8/2006	8:18:30 AM	Linearity Check	-0.06	0.44	24.66
11/8/2006	8:19:00 AM	Linearity Check	-0.06	0.29	24.78
11/8/2006	8:19:30 AM	Linearity Check	-0.06	1.17	22.58
11/8/2006	8:20:00 AM	Linearity Check	-0.06	125.07	8.79
11/8/2006	8:20:30 AM	Linearity Check	-0.06	157	9.64
11/8/2006	8:21:00 AM	Linearity Check	-0.06	152.02	9.89
11/8/2006	8:21:30 AM	Linearity Check	-0.06	153.92	9.89
11/8/2006	8:22:00 AM	Linearity Check	-0.06	150.7	9.89
11/8/2006	8:22:30 AM	Linearity Check	0.31	191.71	12.57
11/8/2006	8:23:00 AM	Linearity Check	-0.06	244.43	17.09
11/8/2006	8:23:30 AM	Linearity Check	-0.12	268.75	17.58
11/8/2006	8:24:00 AM	Linearity Check	-0.06	271.67	17.82
11/8/2006	8:24:30 AM	Linearity Check	-0.06	55.21	17.7
11/8/2006	8:25:00 AM	Linearity Check	17.46	1.61	3.66
11/8/2006	8:25:30 AM	Linearity Check	21.06	0.14	0.12
11/8/2006	8:26:00 AM	Linearity Check	21.06	0	0.12
11/8/2006	8:26:30 AM	Linearity Check	21.06	0	0.12
11/8/2006	8:27:00 AM	Linearity Check	21.06	0	0
11/8/2006	8:27:30 AM	Linearity Check	21.06	0	0
11/8/2006	8:28:00 AM	Linearity Check	21	0	0.12
11/8/2006	8:28:30 AM	Linearity Check	21.06	-0.15	0
11/8/2006	8:29:00 AM	Linearity Check	21	0	0
11/8/2006	8:29:30 AM	Linearity Check	21	-0.15	0.12
11/8/2006	8:30:00 AM	Linearity Check	21.06	0	0
11/8/2006	8:30:30 AM	Linearity Check	21.06	-0.15	0
11/8/2006	8:31:00 AM	Linearity Check	21	0	0
11/8/2006	8:31:30 AM	Linearity Check	21.06	0	0
11/8/2006	8:32:00 AM	Linearity Check	21.06	0	0
11/8/2006	8:32:30 AM	Linearity Check	21.06	-0.15	0

LabView Run Log

Date	Time	Status	O2 (%)	SO2 (PPM)	CO22 (%)
11/8/2006	8:33:00 AM	Linearity Check	21.06	0	0
11/8/2006	8:33:30 AM	Linearity Check	21.06	-0.15	0
11/8/2006	8:34:00 AM	Linearity Check	21.06	-0.15	0
11/8/2006	8:34:30 AM	Linearity Check	21.06	0	0
11/8/2006	8:35:00 AM	Linearity Check	21.06	-0.15	0
11/8/2006	8:35:30 AM	Linearity Check	21	0	0
11/8/2006	8:36:00 AM	Linearity Check	21.06	-0.15	0
11/8/2006	8:36:30 AM	Linearity Check	21.06	-0.15	0
11/8/2006	8:37:00 AM	Linearity Check	21.06	0	0
11/8/2006	8:37:30 AM	Linearity Check	21	0	0
11/8/2006	8:38:00 AM	Linearity Check	21.06	0	0
11/8/2006	8:38:30 AM	Linearity Check	21.06	-0.15	0
11/8/2006	8:39:00 AM	Linearity Check	10.99	39.98	15.62
11/8/2006	8:39:30 AM	Linearity Check	5.19	101.49	26.12
11/8/2006	8:40:00 AM	Linearity Check	4.89	125.8	26.86
11/8/2006	8:40:30 AM	Linearity Check	4.95	135.47	26.86
11/8/2006	8:41:00 AM	Linearity Check	4.95	142.21	26.98
11/8/2006	8:41:30 AM	Linearity Check	4.95	146.31	26.98
11/8/2006	8:42:00 AM	Linearity Check	5.01	147.04	26.98
11/8/2006	8:42:30 AM	Linearity Check	4.95	146.45	27.1
11/8/2006	8:43:00 AM	Linearity Check	5.25	35.59	15.26
11/8/2006	8:43:30 AM	Linearity Check	0.61	11.42	2.2
11/8/2006	8:44:00 AM	Linearity Check	0	6.59	0.12
11/8/2006	8:44:30 AM	Linearity Check	0	4.54	0.12
11/8/2006	8:45:00 AM	- ZERO	0	3.22	0
11/8/2006	8:45:30 AM	- ZERO	0	2.63	0
11/8/2006	8:46:00 AM	- ZERO	0	2.34	0
11/8/2006	8:46:30 AM	- ZERO	0	2.19	14.04
11/8/2006	8:47:00 AM	- ZERO	-0.06	1.9	23.8
11/8/2006	8:47:30 AM	- Span	-0.06	1.75	24.66
11/8/2006	8:48:00 AM	- Span	-0.06	1.46	24.66
11/8/2006	8:48:30 AM	- Span	-0.06	1.32	24.66
11/8/2006	8:49:00 AM	- Span	-0.06	99.15	17.58
11/8/2006	8:49:30 AM	- Span	-0.06	133.57	10.13
11/8/2006	8:50:00 AM	- Span	-0.06	141.04	9.89
11/8/2006	8:50:30 AM	- Span	-0.06	143.52	9.89
11/8/2006	8:51:00 AM	- Span	-0.06	144.84	9.89
11/8/2006	8:51:30 AM	- Span	-0.06	146.01	9.89
11/8/2006	8:52:00 AM	- Span	-0.06	147.19	9.89
11/8/2006	8:52:30 AM	- Span	-0.06	149.38	9.89
11/8/2006	8:53:00 AM	- Span	-0.06	149.82	9.89
11/8/2006	8:53:30 AM	- Span	-0.06	149.24	9.89
11/8/2006	8:54:00 AM	- Span	-0.06	149.97	9.89
11/8/2006	8:54:30 AM	- Span	2.38	36.32	9.64
11/8/2006	8:55:00 AM	- Span	9.95	12.59	8.54
11/8/2006	8:55:30 AM	- Span	10.01	7.76	8.67
11/8/2006	8:56:00 AM	- Span	10.01	5.27	8.67
11/8/2006	8:56:30 AM	- Span	10.07	3.81	8.67
11/8/2006	8:57:00 AM	- Span	8.24	108.23	14.4
11/8/2006	8:57:30 AM	- Span	5.01	149.09	25.88

LabView Run Log

Date	Time	Status	O2 (%)	SO2 (PPM)	CO22 (%)
11/8/2006	8:58:00 AM		4.64	158.17	27.59
11/8/2006	8:58:30 AM		4.58	162.71	27.59
11/8/2006	8:59:00 AM		4.58	164.76	27.59
11/8/2006	8:59:30 AM		4.52	165.93	27.59
11/8/2006	9:00:00 AM		4.52	166.81	27.47
11/8/2006	9:00:30 AM		4.64	166.81	27.34
11/8/2006	9:01:00 AM		4.7	166.96	27.47
11/8/2006	9:01:30 AM		4.64	167.98	27.47
11/8/2006	9:02:00 AM		4.7	169.01	27.47
11/8/2006	9:02:30 AM		4.76	169.74	27.34
11/8/2006	9:03:00 AM		4.76	169.89	27.47
11/8/2006	9:03:30 AM		4.7	170.47	27.47
11/8/2006	9:04:00 AM		4.7	171.35	27.34
11/8/2006	9:04:30 AM		4.76	171.21	27.34
11/8/2006	9:05:00 AM		4.76	171.06	27.34
11/8/2006	9:05:30 AM		4.82	170.62	27.34
11/8/2006	9:06:00 AM		4.89	171.21	27.47
11/8/2006	9:06:30 AM		4.82	171.35	27.47
11/8/2006	9:07:00 AM		4.76	172.38	27.47
11/8/2006	9:07:30 AM		4.7	172.67	27.47
11/8/2006	9:08:00 AM		4.64	172.52	27.59
11/8/2006	9:08:30 AM		4.52	173.11	27.47
11/8/2006	9:09:00 AM		4.64	172.82	27.34
11/8/2006	9:09:30 AM		4.82	172.67	27.22
11/8/2006	9:10:00 AM		4.89	172.08	27.1
11/8/2006	9:10:30 AM		5.01	170.91	26.98
11/8/2006	9:11:00 AM		5.13	169.3	26.86
11/8/2006	9:11:30 AM		5.19	168.13	26.86
11/8/2006	9:12:00 AM		5.19	167.1	26.86
11/8/2006	9:12:30 AM		5.31	166.23	26.86
11/8/2006	9:13:00 AM		5.31	165.05	26.86
11/8/2006	9:13:30 AM		5.25	164.91	26.86
11/8/2006	9:14:00 AM		5.25	163.88	26.73
11/8/2006	9:14:30 AM		5.37	162.56	26.73
11/8/2006	9:15:00 AM		5.31	161.69	26.73
11/8/2006	9:15:30 AM		5.31	160.81	26.86
11/8/2006	9:16:00 AM		5.25	160.07	26.98
11/8/2006	9:16:30 AM		5.19	159.05	26.98
11/8/2006	9:17:00 AM		5.13	158.61	27.22
11/8/2006	9:17:30 AM		5.07	158.76	27.22
11/8/2006	9:18:00 AM		5.01	126.54	27.34
11/8/2006	9:18:30 AM		1.89	149.53	14.4
11/8/2006	9:19:00 AM		-0.06	151.58	10.01
11/8/2006	9:19:30 AM		-0.06	153.04	9.89
11/8/2006	9:20:00 AM		2.75	156.27	19.16
11/8/2006	9:20:30 AM		4.82	155.97	27.1
11/8/2006	9:21:00 AM		5.01	155.1	27.34
11/8/2006	9:21:30 AM		5.01	155.1	27.34
11/8/2006	9:22:00 AM		5.07	156.41	27.34
11/8/2006	9:22:30 AM		5.13	156.85	27.22

LabView Run Log

Date	Time	Status	O2 (%)	SO2 (PPM)	CO22 (%)
11/8/2006	9:23:00 AM		5.31	155.97	27.1
11/8/2006	9:23:30 AM		5.25	155.1	27.22
11/8/2006	9:24:00 AM		5.31	154.51	27.1
11/8/2006	9:24:30 AM		5.62	153.48	27.1
11/8/2006	9:25:00 AM		5.74	151.87	27.1
11/8/2006	9:25:30 AM		5.8	152.17	27.1
11/8/2006	9:26:00 AM		5.8	150.7	27.1
11/8/2006	9:26:30 AM		5.8	149.38	27.22
11/8/2006	9:27:00 AM		5.74	147.77	27.22
11/8/2006	9:27:30 AM		5.68	148.5	27.22
11/8/2006	9:28:00 AM		5.68	148.07	27.22
11/8/2006	9:28:30 AM		5.74	147.33	27.1
11/8/2006	9:29:00 AM		5.68	146.45	27.22
11/8/2006	9:29:30 AM		5.74	144.84	26.98
11/8/2006	9:30:00 AM		5.74	143.67	26.98
11/8/2006	9:30:30 AM		5.68	143.82	26.98
11/8/2006	9:31:00 AM		5.8	143.96	26.86
11/8/2006	9:31:30 AM		5.86	143.09	26.61
11/8/2006	9:32:00 AM		5.92	141.91	26.49
11/8/2006	9:32:30 AM		5.98	139.57	26.37
11/8/2006	9:33:00 AM		6.04	138.4	26.37
11/8/2006	9:33:30 AM		6.11	138.25	26.37
11/8/2006	9:34:00 AM		6.11	137.81	26.37
11/8/2006	9:34:30 AM		6.17	136.79	26.12
11/8/2006	9:35:00 AM		6.29	135.18	26.24
11/8/2006	9:35:30 AM		6.53	132.25	26.24
11/8/2006	9:36:00 AM		6.17	135.32	25.63
11/8/2006	9:36:30 AM		0.8	151.58	12.57
11/8/2006	9:37:00 AM		-0.06	150.55	10.01
11/8/2006	9:37:30 AM		0.06	133.27	10.01
11/8/2006	9:38:00 AM		5.68	124.78	23.07
11/8/2006	9:38:30 AM		6.66	123.61	26
11/8/2006	9:39:00 AM		6.72	121.85	26.12
11/8/2006	9:39:30 AM		6.78	122.73	26
11/8/2006	9:40:00 AM		6.9	121.26	25.88
11/8/2006	9:40:30 AM	Traverse - 1	6.96	119.36	25.88
11/8/2006	9:41:00 AM	Traverse - 1	7.02	116.87	25.76
11/8/2006	9:41:30 AM	Traverse - 1	7.02	115.55	25.88
11/8/2006	9:42:00 AM	Traverse - 1	7.08	115.7	25.88
11/8/2006	9:42:30 AM	Traverse - 1	7.02	115.41	26
11/8/2006	9:43:00 AM	Traverse - 1	6.96	115.11	26.12
11/8/2006	9:43:30 AM	Traverse - 1	6.84	115.11	26.24
11/8/2006	9:44:00 AM	Traverse - 1	6.59	112.77	26.49
11/8/2006	9:44:30 AM	Traverse - 1	6.59	112.48	26.49
11/8/2006	9:45:00 AM	Traverse - 1	6.47	112.77	26.61
11/8/2006	9:45:30 AM	Traverse - 1	6.41	112.48	26.61
11/8/2006	9:46:00 AM	Traverse - 1	6.47	111.45	26.49
11/8/2006	9:46:30 AM	Traverse - 1	6.53	110.57	26.37
11/8/2006	9:47:00 AM	Traverse - 1	6.59	110.43	26.24
11/8/2006	9:47:30 AM	Traverse - 1	6.59	110.87	26.12

LabView Run Log

Date	Time	Status	O2 (%)	SO2 (PPM)	CO22 (%)
11/8/2006	9:48:00 AM	Traverse - 1	6.66	110.87	26.24
11/8/2006	9:48:30 AM	Traverse - 1	6.78	110.43	26.24
11/8/2006	9:49:00 AM	Traverse - 1	6.66	110.13	26.24
11/8/2006	9:49:30 AM	Traverse - 1	6.59	110.28	25.88
11/8/2006	9:50:00 AM	Traverse - 1	6.78	109.55	25.63
11/8/2006	9:50:30 AM	Traverse - 1	6.72	109.55	26
11/8/2006	9:51:00 AM	Traverse - 1	6.53	109.84	26.24
11/8/2006	9:51:30 AM	Traverse - 1	6.41	109.99	26.49
11/8/2006	9:52:00 AM	Traverse - 1	6.29	110.13	26.61
11/8/2006	9:52:30 AM	Traverse - 1	6.17	109.84	26.73
11/8/2006	9:53:00 AM	Traverse - 1	6.17	110.43	26.73
11/8/2006	9:53:30 AM	Traverse - 1	6.11	110.87	26.86
11/8/2006	9:54:00 AM	Traverse - 1	5.86	111.89	26.98
11/8/2006	9:54:30 AM	Traverse - 1	5.8	112.62	26.98
11/8/2006	9:55:00 AM	Traverse - 1	5.74	112.48	26.98
11/8/2006	9:55:30 AM	Traverse - 1	5.74	113.5	26.98
11/8/2006	9:56:00 AM	Traverse - 1	5.68	115.26	27.22
11/8/2006	9:56:30 AM	Traverse - 1	5.56	116.43	27.22
11/8/2006	9:57:00 AM	Traverse - 1	5.62	117.6	27.1
11/8/2006	9:57:30 AM	Traverse - 1	5.62	118.04	26.98
11/8/2006	9:58:00 AM	Traverse - 1	5.62	118.77	26.98
11/8/2006	9:58:30 AM	Run Paused	5.68	119.95	26.73
11/8/2006	9:59:00 AM	Run Paused	5.74	94.02	26.61
11/8/2006	9:59:30 AM	Run Paused	14.96	27.24	11.6
11/8/2006	10:00:00 AM	Run Paused	20.88	25.63	0.61
11/8/2006	10:00:30 AM	Run Paused	12.39	126.68	14.28
11/8/2006	10:01:00 AM	Run Paused	6.66	123.75	24.9
11/8/2006	10:01:30 AM	Traverse - 1	6.47	122	25.76
11/8/2006	10:02:00 AM	Traverse - 1	6.53	120.53	25.76
11/8/2006	10:02:30 AM	Traverse - 1	6.53	121.12	25.88
11/8/2006	10:03:00 AM	Traverse - 1	6.53	120.97	25.88
11/8/2006	10:03:30 AM	Traverse - 1	6.53	119.07	25.88
11/8/2006	10:04:00 AM	Traverse - 1	6.53	119.36	25.88
11/8/2006	10:04:30 AM	Traverse - 1	6.53	119.8	25.88
11/8/2006	10:05:00 AM	Traverse - 1	6.41	120.09	26.12
11/8/2006	10:05:30 AM	Traverse - 1	6.35	120.38	26.12
11/8/2006	10:06:00 AM	Traverse - 1	6.29	119.36	26.24
11/8/2006	10:06:30 AM	Traverse - 1	6.11	118.92	26.49
11/8/2006	10:07:00 AM	Traverse - 1	5.98	119.21	26.61
11/8/2006	10:07:30 AM	Traverse - 1	5.86	120.24	26.73
11/8/2006	10:08:00 AM	Traverse - 1	5.74	121.26	26.98
11/8/2006	10:08:30 AM	Traverse - 1	5.56	122	27.1
11/8/2006	10:09:00 AM	Traverse - 1	5.5	122.73	27.1
11/8/2006	10:09:30 AM	Traverse - 1	5.43	123.17	27.22
11/8/2006	10:10:00 AM	Traverse - 1	4.82	125.36	28.32
11/8/2006	10:10:30 AM	Traverse - 1	5.19	126.98	26.73
11/8/2006	10:11:00 AM	Traverse - 1	5.8	126.39	25.88
11/8/2006	10:11:30 AM	Traverse - 1	6.11	124.63	25.88
11/8/2006	10:12:00 AM	Traverse - 1	6.29	123.61	25.76
11/8/2006	10:12:30 AM	Traverse - 1	6.35	123.31	25.88

LabView Run Log

Date	Time	Status	O2 (%)	SO2 (PPM)	CO22 (%)
11/8/2006	10:13:00 AM	Traverse - 1	6.41	124.19	26
11/8/2006	10:13:30 AM	Traverse - 1	6.35	125.07	26.12
11/8/2006	10:14:00 AM	Traverse - 1	6.29	125.8	26.12
11/8/2006	10:14:30 AM	Traverse - 1	6.23	124.63	26.24
11/8/2006	10:15:00 AM	Traverse - 1	6.23	124.19	26.37
11/8/2006	10:15:30 AM	Traverse - 1	6.17	124.92	26.37
11/8/2006	10:16:00 AM	Traverse - 1	6.04	125.36	26.37
11/8/2006	10:16:30 AM	Traverse - 1	5.98	125.36	26.61
11/8/2006	10:17:00 AM	Traverse - 1	5.92	125.07	26.73
11/8/2006	10:17:30 AM	Traverse - 1	5.8	125.36	26.73
11/8/2006	10:18:00 AM	Traverse - 1	5.74	125.8	26.86
11/8/2006	10:18:30 AM	Traverse - 1	5.62	126.83	26.86
11/8/2006	10:19:00 AM	Traverse - 1	5.62	127.56	26.86
11/8/2006	10:19:30 AM		5.37	128.59	27.1
11/8/2006	10:20:00 AM		5.5	44.08	26.73
11/8/2006	10:20:30 AM		1.22	6.88	7.32
11/8/2006	10:21:00 AM	- ZERO	-0.06	3.51	0.36
11/8/2006	10:21:30 AM	- ZERO	0	2.63	0.12
11/8/2006	10:22:00 AM	- ZERO	0	11.57	0.12
11/8/2006	10:22:30 AM	- ZERO	7.63	2.05	6.71
11/8/2006	10:23:00 AM	- Span	10.07	1.61	8.67
11/8/2006	10:23:30 AM	- Span	10.07	1.17	8.67
11/8/2006	10:24:00 AM	- Span	3.73	1.17	17.94
11/8/2006	10:24:30 AM	- Span	0	1.02	24.54
11/8/2006	10:25:00 AM	- Span	-0.06	0.73	24.78
11/8/2006	10:25:30 AM	- Span	-0.06	115.84	21.97
11/8/2006	10:26:00 AM	- Span	-0.06	146.31	10.74
11/8/2006	10:26:30 AM	- Span	-0.06	149.53	9.89
11/8/2006	10:27:00 AM	- Span	-0.06	146.75	9.89
11/8/2006	10:27:30 AM	- Span	3.66	126.83	19.41
11/8/2006	10:28:00 AM	- Span	5.92	126.39	25.88
11/8/2006	10:28:30 AM	- Span	5.8	125.07	26.49
11/8/2006	10:29:00 AM	- Span	5.74	125.36	26.49
11/8/2006	10:29:30 AM	- Span	5.74	125.66	26.49
11/8/2006	10:30:00 AM	- Span	5.74	126.39	26.37
11/8/2006	10:30:30 AM	Run 1 - 1	5.74	126.83	26.37
11/8/2006	10:31:00 AM	Run 1 - 1	5.8	126.98	26.24
11/8/2006	10:31:30 AM	Run 1 - 1	5.98	126.68	26.12
11/8/2006	10:32:00 AM	Run 1 - 1	6.04	126.1	26
11/8/2006	10:32:30 AM	Run 1 - 1	6.04	125.66	26.12
11/8/2006	10:33:00 AM	Run 1 - 1	6.17	126.1	26
11/8/2006	10:33:30 AM	Run 1 - 1	6.04	126.54	26.12
11/8/2006	10:34:00 AM	Run 1 - 1	6.04	126.68	26.12
11/8/2006	10:34:30 AM	Run 1 - 1	6.11	126.68	26
11/8/2006	10:35:00 AM	Run 1 - 1	6.11	126.54	25.88
11/8/2006	10:35:30 AM	Run 1 - 1	6.11	125.95	25.88
11/8/2006	10:36:00 AM	Run 1 - 1	6.17	126.39	25.88
11/8/2006	10:36:30 AM	Run 1 - 1	6.29	126.1	25.76
11/8/2006	10:37:00 AM	Run 1 - 1	6.35	125.07	25.76
11/8/2006	10:37:30 AM	Run 1 - 1	6.23	124.63	25.88

LabView Run Log

Date	Time	Status	O2 (%)	SO2 (PPM)	CO22 (%)
11/8/2006	10:38:00 AM	Run 1 - 1	6.23	124.49	26
11/8/2006	10:38:30 AM	Run 1 - 1	6.17	125.36	26
11/8/2006	10:39:00 AM	Run 1 - 1	6.04	126.24	26.24
11/8/2006	10:39:30 AM	Run 1 - 1	5.98	126.1	26.12
11/8/2006	10:40:00 AM	Run 1 - 1	5.92	125.22	26.12
11/8/2006	10:40:30 AM	Run 1 - 1	5.98	125.36	26.12
11/8/2006	10:41:00 AM	Run 1 - 1	5.98	125.51	26.12
11/8/2006	10:41:30 AM	Run 1 - 1	6.04	125.66	26.12
11/8/2006	10:42:00 AM	Run 1 - 1	6.04	125.51	26
11/8/2006	10:42:30 AM	Run 1 - 1	6.04	124.92	26
11/8/2006	10:43:00 AM	Run 1 - 1	6.11	124.63	26
11/8/2006	10:43:30 AM	Run 1 - 1	6.11	124.78	26.12
11/8/2006	10:44:00 AM	Run 1 - 1	6.11	125.66	26
11/8/2006	10:44:30 AM	Run 1 - 1	5.98	126.24	26.12
11/8/2006	10:45:00 AM	Run 1 - 1	5.98	126.24	26.12
11/8/2006	10:45:30 AM	Run 1 - 1	6.04	125.07	26.12
11/8/2006	10:46:00 AM	Run 1 - 1	6.04	125.8	26
11/8/2006	10:46:30 AM	Run 1 - 1	6.11	126.39	26
11/8/2006	10:47:00 AM	Run 1 - 1	6.11	126.24	26.12
11/8/2006	10:47:30 AM	Run 1 - 1	6.04	125.66	26
11/8/2006	10:48:00 AM	Run 1 - 1	6.11	125.07	26
11/8/2006	10:48:30 AM	Run 1 - 1	6.17	124.78	26
11/8/2006	10:49:00 AM	Run 1 - 1	6.11	125.51	26.12
11/8/2006	10:49:30 AM	Run 1 - 1	6.04	126.39	26.12
11/8/2006	10:50:00 AM	Run 1 - 1	6.04	126.39	26
11/8/2006	10:50:30 AM	Run 1 - 1	5.98	125.66	26
11/8/2006	10:51:00 AM	Run 1 - 1	5.92	125.8	26.24
11/8/2006	10:51:30 AM	Run 1 - 1	5.8	126.83	26.24
11/8/2006	10:52:00 AM	Run 1 - 1	5.8	128.73	26.24
11/8/2006	10:52:30 AM	Run 1 - 1	5.86	128.29	26.24
11/8/2006	10:53:00 AM	Run 1 - 1	5.8	127.71	26.37
11/8/2006	10:53:30 AM	Run 1 - 1	5.92	127.12	26.12
11/8/2006	10:54:00 AM	Run 1 - 1	5.92	127.71	26
11/8/2006	10:54:30 AM	Run 1 - 1	5.92	128.73	26.12
11/8/2006	10:55:00 AM	Run 1 - 1	5.92	128	26
11/8/2006	10:55:30 AM	Run 1 - 1	6.04	127.85	26.12
11/8/2006	10:56:00 AM	Run 1 - 1	6.04	127.41	26.12
11/8/2006	10:56:30 AM	Run 1 - 1	6.04	128	26.24
11/8/2006	10:57:00 AM	Run 1 - 1	6.04	128.59	26.24
11/8/2006	10:57:30 AM	Run 1 - 1	5.98	129.03	26.37
11/8/2006	10:58:00 AM	Run 1 - 1	5.92	129.32	26.49
11/8/2006	10:58:30 AM	Run 1 - 1	5.86	129.17	26.49
11/8/2006	10:59:00 AM	Run 1 - 1	5.92	129.32	26.37
11/8/2006	10:59:30 AM	Run 1 - 1	5.8	130.05	26.49
11/8/2006	11:00:00 AM	Run 1 - 1	5.8	130.34	26.37
11/8/2006	11:00:30 AM	Run 1 - 1	5.86	130.64	26.24
11/8/2006	11:01:00 AM	Run 1 - 1	5.86	129.47	26.24
11/8/2006	11:01:30 AM	Run 1 - 1	5.86	129.32	26.37
11/8/2006	11:02:00 AM	Run 1 - 1	5.92	129.76	26.24
11/8/2006	11:02:30 AM	Run 1 - 1	5.98	130.49	26.12

LabView Run Log

Date	Time	Status	O2 (%)	SO2 (PPM)	CO22 (%)
11/8/2006	11:03:00 AM	Run 1 - 1	5.98	131.37	26.24
11/8/2006	11:03:30 AM	Run 1 - 1	5.98	130.64	26.12
11/8/2006	11:04:00 AM	Run 1 - 1	5.98	130.34	26.12
11/8/2006	11:04:30 AM	Run 1 - 1	5.98	129.61	26.24
11/8/2006	11:05:00 AM	Run 1 - 1	5.98	130.49	26.12
11/8/2006	11:05:30 AM	Run 1 - 1	5.92	131.37	26.12
11/8/2006	11:06:00 AM	Run 1 - 1	5.92	131.22	26.24
11/8/2006	11:06:30 AM	Run 1 - 1	5.92	130.64	26.24
11/8/2006	11:07:00 AM	Run 1 - 1	5.98	130.93	26.24
11/8/2006	11:07:30 AM	Run 1 - 1	5.98	130.49	26.24
11/8/2006	11:08:00 AM	Run 1 - 1	5.92	131.08	26.37
11/8/2006	11:08:30 AM	Run 1 - 1	5.86	131.52	26.37
11/8/2006	11:09:00 AM	Run 1 - 1	5.8	131.52	26.37
11/8/2006	11:09:30 AM	Run 1 - 1	5.92	130.78	26.24
11/8/2006	11:10:00 AM	Run 1 - 1	5.98	130.2	26.12
11/8/2006	11:10:30 AM	Run 1 - 1	5.98	131.37	26.12
11/8/2006	11:11:00 AM	Run 1 - 1	6.04	131.95	26
11/8/2006	11:11:30 AM	Run 1 - 1	6.04	131.08	26.12
11/8/2006	11:12:00 AM	Run 1 - 1	6.11	130.64	26.12
11/8/2006	11:12:30 AM	Run 1 - 1	6.11	129.9	26.12
11/8/2006	11:13:00 AM	Run 1 - 1	5.98	130.93	26.24
11/8/2006	11:13:30 AM	Run 1 - 1	5.86	131.81	26.37
11/8/2006	11:14:00 AM	Run 1 - 1	5.8	132.25	26.37
11/8/2006	11:14:30 AM	Run 1 - 1	5.8	132.69	26.24
11/8/2006	11:15:00 AM	Run 1 - 1	5.86	131.52	26.12
11/8/2006	11:15:30 AM	Run 1 - 1	5.86	131.22	26
11/8/2006	11:16:00 AM	Run 1 - 1	5.98	131.52	25.88
11/8/2006	11:16:30 AM	Run 1 - 1	6.11	131.08	25.88
11/8/2006	11:17:00 AM	Run 1 - 1	6.17	130.64	25.88
11/8/2006	11:17:30 AM	Run 1 - 1	6.29	129.47	25.76
11/8/2006	11:18:00 AM	Run 1 - 1	6.35	129.03	25.63
11/8/2006	11:18:30 AM	Run 1 - 1	6.41	129.32	25.63
11/8/2006	11:19:00 AM	Run 1 - 1	6.53	129.17	25.51
11/8/2006	11:19:30 AM	Run 1 - 1	6.59	128.15	25.51
11/8/2006	11:20:00 AM	Run 1 - 1	6.59	126.24	25.51
11/8/2006	11:20:30 AM	Run 1 - 1	6.47	125.8	25.63
11/8/2006	11:21:00 AM	Run 1 - 1	6.41	125.8	25.63
11/8/2006	11:21:30 AM	Run 1 - 1	6.41	126.54	25.76
11/8/2006	11:22:00 AM	Run 1 - 1	6.29	126.24	26
11/8/2006	11:22:30 AM	Run 1 - 1	6.11	125.95	26
11/8/2006	11:23:00 AM	Run 1 - 1	5.98	125.8	26.12
11/8/2006	11:23:30 AM	Run 1 - 1	5.92	126.39	26.24
11/8/2006	11:24:00 AM	Run 1 - 1	5.74	126.98	26.37
11/8/2006	11:24:30 AM	Run 1 - 1	5.68	127.27	26.24
11/8/2006	11:25:00 AM	Run 1 - 1	5.74	127.41	26.37
11/8/2006	11:25:30 AM	Run 1 - 1	5.74	128	26.24
11/8/2006	11:26:00 AM	Run 1 - 1	5.8	127.56	26.24
11/8/2006	11:26:30 AM	Run 1 - 1	5.86	127.56	26
11/8/2006	11:27:00 AM	Run 1 - 1	5.92	128.29	25.88
11/8/2006	11:27:30 AM	Run 1 - 1	6.04	128.59	25.88

LabView Run Log

Date	Time	Status	O2 (%)	SO2 (PPM)	CO22 (%)
11/8/2006	11:28:00 AM	Run 1 - 1	6.17	128.59	25.63
11/8/2006	11:28:30 AM	Run 1 - 1	6.29	127.27	25.51
11/8/2006	11:29:00 AM	Run 1 - 1	6.35	126.68	25.63
11/8/2006	11:29:30 AM	Run 1 - 1	6.41	126.68	25.51
11/8/2006	11:30:00 AM	Run 1 - 1	6.47	126.54	25.39
11/8/2006	11:30:30 AM	Run 1 - 2	6.47	126.98	25.51
11/8/2006	11:31:00 AM		6.47	126.98	25.51
11/8/2006	11:31:30 AM		4.58	23.28	19.04
11/8/2006	11:32:00 AM		0.61	4.1	3.42
11/8/2006	11:32:30 AM	- ZERO	0	2.93	0.12
11/8/2006	11:33:00 AM	- ZERO	-0.06	2.19	0.12
11/8/2006	11:33:30 AM	- ZERO	0	1.75	0.12
11/8/2006	11:34:00 AM	- ZERO	-0.06	1.61	0.12
11/8/2006	11:34:30 AM	- ZERO	-0.06	1.46	15.87
11/8/2006	11:35:00 AM	- ZERO	-0.06	1.46	24.17
11/8/2006	11:35:30 AM	- Span	-0.06	1.32	24.66
11/8/2006	11:36:00 AM	- Span	-0.06	0.73	24.78
11/8/2006	11:36:30 AM	- Span	3.12	0.73	20.26
11/8/2006	11:37:00 AM	- Span	9.89	0.73	9.03
11/8/2006	11:37:30 AM	- Span	10.07	0.44	8.79
11/8/2006	11:38:00 AM	- Span	10.13	0.44	8.79
11/8/2006	11:38:30 AM	- Span	10.07	60.48	8.67
11/8/2006	11:39:00 AM	- Span	1.59	145.28	9.4
11/8/2006	11:39:30 AM	- Span	0	150.41	9.89
11/8/2006	11:40:00 AM	- Span	0	152.17	10.01
11/8/2006	11:40:30 AM	- Span	0.37	136.35	10.25
11/8/2006	11:41:00 AM	- Span	5.43	131.37	22.95
11/8/2006	11:41:30 AM	- Span	6.35	130.93	25.63
11/8/2006	11:42:00 AM	- Span	6.47	130.93	25.51
11/8/2006	11:42:30 AM	- Span	6.47	129.9	25.51
11/8/2006	11:43:00 AM	- Span	6.47	128.88	25.63
11/8/2006	11:43:30 AM	- Span	6.41	128.73	25.63
11/8/2006	11:44:00 AM	- Span	6.35	128.73	25.63
11/8/2006	11:44:30 AM	- Span	6.17	129.61	26
11/8/2006	11:45:00 AM	- Span	5.92	129.61	26.24
11/8/2006	11:45:30 AM	- Span	5.8	129.9	26.49
11/8/2006	11:46:00 AM	- Span	5.56	131.22	26.61
11/8/2006	11:46:30 AM	- Span	5.43	131.95	26.73
11/8/2006	11:47:00 AM	- Span	5.37	132.54	26.61
11/8/2006	11:47:30 AM	- Span	5.37	133.42	26.61
11/8/2006	11:48:00 AM	- Span	5.43	133.57	26.49
11/8/2006	11:48:30 AM	- Span	5.56	134.3	26.24
11/8/2006	11:49:00 AM	- Span	5.74	133.42	26
11/8/2006	11:49:30 AM	- Span	5.86	132.54	25.76
11/8/2006	11:50:00 AM	- Span	6.04	132.39	25.63
11/8/2006	11:50:30 AM	- Span	6.23	132.54	25.51
11/8/2006	11:51:00 AM	- Span	6.41	132.54	25.51
11/8/2006	11:51:30 AM	- Span	6.47	132.39	25.27
11/8/2006	11:52:00 AM	- Span	6.47	131.22	25.27
11/8/2006	11:52:30 AM	- Span	6.53	130.93	25.27

LabView Run Log

Date	Time	Status	O2 (%)	SO2 (PPM)	CO22 (%)
11/8/2006	11:53:00 AM	- Span	6.72	130.05	25.15
11/8/2006	11:53:30 AM	- Span	6.72	129.32	25.27
11/8/2006	11:54:00 AM	- Span	6.59	129.17	25.39
11/8/2006	11:54:30 AM	- Span	6.47	129.32	25.63
11/8/2006	11:55:00 AM	- Span	6.23	128.88	25.88
11/8/2006	11:55:30 AM	- Span	6.11	128.88	26.12
11/8/2006	11:56:00 AM	- Span	5.92	129.47	26.24
11/8/2006	11:56:30 AM	- Span	5.8	130.2	26.37
11/8/2006	11:57:00 AM	- Span	5.62	131.22	26.49
11/8/2006	11:57:30 AM	- Span	5.5	131.22	26.61
11/8/2006	11:58:00 AM	- Span	5.5	131.66	26.73
11/8/2006	11:58:30 AM	- Span	5.43	132.54	26.61
11/8/2006	11:59:00 AM	- Span	5.5	134.3	26.49
11/8/2006	11:59:30 AM	- Span	5.43	135.18	26.37
11/8/2006	12:00:00 PM	- Span	5.62	134.74	26.12
11/8/2006	12:00:30 PM	- Span	5.8	133.71	26
11/8/2006	12:01:00 PM	- Span	5.98	133.27	25.76
11/8/2006	12:01:30 PM	- Span	5.98	134.44	25.76
11/8/2006	12:02:00 PM	- Span	6.17	135.03	25.63
11/8/2006	12:02:30 PM	- Span	6.23	134.3	25.63
11/8/2006	12:03:00 PM	- Span	6.35	133.13	25.51
11/8/2006	12:03:30 PM	- Span	6.35	132.69	25.51
11/8/2006	12:04:00 PM	- Span	6.35	133.71	25.63
11/8/2006	12:04:30 PM	- Span	6.35	134.15	25.63
11/8/2006	12:05:00 PM	- Span	6.29	133.42	25.76
11/8/2006	12:05:30 PM	- Span	6.23	132.39	25.76
11/8/2006	12:06:00 PM	- Span	6.17	131.66	25.76
11/8/2006	12:06:30 PM	- Span	6.17	131.66	25.88
11/8/2006	12:07:00 PM	- Span	6.17	132.69	26
11/8/2006	12:07:30 PM	- Span	6.04	132.98	26.12
11/8/2006	12:08:00 PM	- Span	5.86	132.83	26.24
11/8/2006	12:08:30 PM	- Span	5.74	132.54	26.37
11/8/2006	12:09:00 PM	- Span	5.62	133.42	26.73
11/8/2006	12:09:30 PM	- Span	5.5	134.3	26.61
11/8/2006	12:10:00 PM	- Span	5.43	135.91	26.49
11/8/2006	12:10:30 PM	- Span	5.43	136.35	26.49
11/8/2006	12:11:00 PM	- Span	5.43	136.06	26.49
11/8/2006	12:11:30 PM	- Span	5.56	135.76	26.24
11/8/2006	12:12:00 PM	- Span	5.8	135.47	25.76
11/8/2006	12:12:30 PM	- Span	5.98	135.76	25.63
11/8/2006	12:13:00 PM	- Span	6.29	135.62	25.39
11/8/2006	12:13:30 PM	- Span	6.41	134.88	25.27
11/8/2006	12:14:00 PM	- Span	6.53	132.83	25.27
11/8/2006	12:14:30 PM	- Span	6.59	131.95	25.27
11/8/2006	12:15:00 PM	- Span	6.59	132.39	25.27
11/8/2006	12:15:30 PM	- Span	6.53	132.83	25.27
11/8/2006	12:16:00 PM	- Span	6.47	132.54	25.51
11/8/2006	12:16:30 PM	- Span	6.41	131.81	25.63
11/8/2006	12:17:00 PM	- Span	6.29	131.37	25.76
11/8/2006	12:17:30 PM	- Span	6.04	131.81	26.12

LabView Run Log

Date	Time	Status	O2 (%)	SO2 (PPM)	CO22 (%)
11/8/2006	12:18:00 PM	- Span	5.8	132.98	26.24
11/8/2006	12:18:30 PM	- Span	5.74	133.27	26.49
11/8/2006	12:19:00 PM	- Span	5.5	134.59	26.49
11/8/2006	12:19:30 PM	- Span	5.37	134.88	26.61
11/8/2006	12:20:00 PM	- Span	5.37	135.32	26.49
11/8/2006	12:20:30 PM	- Span	5.43	135.76	26.37
11/8/2006	12:21:00 PM	- Span	5.56	136.5	26.24
11/8/2006	12:21:30 PM	- Span	5.74	136.79	26
11/8/2006	12:22:00 PM	- Span	5.86	135.47	25.88
11/8/2006	12:22:30 PM	- Span	6.04	134.15	25.76
11/8/2006	12:23:00 PM	- Span	6.11	133.86	25.63
11/8/2006	12:23:30 PM	- Span	6.23	134.59	25.63
11/8/2006	12:24:00 PM	- Span	6.29	135.62	25.51
11/8/2006	12:24:30 PM	- Span	6.35	134.88	25.39
11/8/2006	12:25:00 PM	- Span	6.41	134.01	25.39
11/8/2006	12:25:30 PM	- Span	6.41	132.54	25.39
11/8/2006	12:26:00 PM	- Span	6.35	132.25	25.51
11/8/2006	12:26:30 PM	- Span	6.29	133.42	25.76
11/8/2006	12:27:00 PM	- Span	6.23	133.42	25.88
11/8/2006	12:27:30 PM	- Span	6.04	132.54	26
11/8/2006	12:28:00 PM	- Span	5.92	132.69	26.12
11/8/2006	12:28:30 PM	- Span	5.8	133.27	26.24
11/8/2006	12:29:00 PM	- Span	5.62	135.62	26.37
11/8/2006	12:29:30 PM	- Span	5.43	136.35	26.61
11/8/2006	12:30:00 PM	- Span	5.43	135.91	26.61
11/8/2006	12:30:30 PM	Run 2 - 1	5.5	135.18	26.49
11/8/2006	12:31:00 PM	Run 2 - 1	5.43	136.2	26.37
11/8/2006	12:31:30 PM	Run 2 - 1	5.56	137.52	26.37
11/8/2006	12:32:00 PM	Run 2 - 1	5.68	138.25	26.12
11/8/2006	12:32:30 PM	Run 2 - 1	5.8	137.37	26.12
11/8/2006	12:33:00 PM	Run 2 - 1	5.8	137.08	26
11/8/2006	12:33:30 PM	Run 2 - 1	5.8	137.37	26
11/8/2006	12:34:00 PM	Run 2 - 1	5.86	138.55	26.12
11/8/2006	12:34:30 PM	Run 2 - 1	5.86	139.86	26
11/8/2006	12:35:00 PM	Run 2 - 1	5.86	139.42	26
11/8/2006	12:35:30 PM	Run 2 - 1	5.92	138.55	25.88
11/8/2006	12:36:00 PM	Run 2 - 1	5.92	138.84	25.88
11/8/2006	12:36:30 PM	Run 2 - 1	5.92	139.42	26
11/8/2006	12:37:00 PM	Run 2 - 1	5.98	139.57	25.88
11/8/2006	12:37:30 PM	Run 2 - 1	5.98	139.57	25.88
11/8/2006	12:38:00 PM	Run 2 - 1	5.98	139.13	26
11/8/2006	12:38:30 PM	Run 2 - 1	5.92	139.72	25.88
11/8/2006	12:39:00 PM	Run 2 - 1	5.92	139.13	26
11/8/2006	12:39:30 PM	Run 2 - 1	5.86	139.57	26
11/8/2006	12:40:00 PM	Run 2 - 1	5.86	139.86	26
11/8/2006	12:40:30 PM	Run 2 - 1	5.86	139.13	26
11/8/2006	12:41:00 PM	Run 2 - 1	5.86	138.98	26
11/8/2006	12:41:30 PM	Run 2 - 1	5.86	138.25	26
11/8/2006	12:42:00 PM	Run 2 - 1	5.92	138.11	25.88
11/8/2006	12:42:30 PM	Run 2 - 1	5.92	138.4	26

LabView Run Log

Date	Time	Status	O2 (%)	SO2 (PPM)	CO22 (%)
11/8/2006	12:43:00 PM	Run 2 - 1	5.92	138.55	26
11/8/2006	12:43:30 PM	Run 2 - 1	5.98	138.69	25.88
11/8/2006	12:44:00 PM	Run 2 - 1	5.98	137.81	25.76
11/8/2006	12:44:30 PM	Run 2 - 1	5.98	137.67	25.88
11/8/2006	12:45:00 PM	Run 2 - 1	5.98	137.96	25.76
11/8/2006	12:45:30 PM	Run 2 - 1	6.11	137.23	25.76
11/8/2006	12:46:00 PM	Run 2 - 1	6.11	136.5	25.76
11/8/2006	12:46:30 PM	Run 2 - 1	6.11	135.91	25.76
11/8/2006	12:47:00 PM	Run 2 - 1	6.23	135.03	25.76
11/8/2006	12:47:30 PM	Run 2 - 1	6.35	134.44	25.63
11/8/2006	12:48:00 PM	Run 2 - 1	6.41	133.86	25.76
11/8/2006	12:48:30 PM	Run 2 - 1	6.35	134.3	25.76
11/8/2006	12:49:00 PM	Run 2 - 1	6.35	134.01	25.88
11/8/2006	12:49:30 PM	Run 2 - 1	6.29	132.83	26
11/8/2006	12:50:00 PM	Run 2 - 1	6.11	132.39	26
11/8/2006	12:50:30 PM	Run 2 - 1	6.23	131.81	26
11/8/2006	12:51:00 PM	Run 2 - 1	6.23	132.54	26
11/8/2006	12:51:30 PM	Run 2 - 1	6.23	131.95	26
11/8/2006	12:52:00 PM	Run 2 - 1	6.23	131.52	25.88
11/8/2006	12:52:30 PM	Run 2 - 1	6.29	130.64	25.88
11/8/2006	12:53:00 PM	Run 2 - 1	6.41	129.17	25.88
11/8/2006	12:53:30 PM	Run 2 - 1	6.53	128.29	25.88
11/8/2006	12:54:00 PM	Run 2 - 1	6.53	128.59	25.76
11/8/2006	12:54:30 PM	Run 2 - 1	6.59	128	25.88
11/8/2006	12:55:00 PM	Run 2 - 1	6.66	127.27	25.88
11/8/2006	12:55:30 PM	Run 2 - 1	6.66	126.83	25.76
11/8/2006	12:56:00 PM	Run 2 - 1	6.72	126.1	25.63
11/8/2006	12:56:30 PM	Run 2 - 1	6.72	125.22	25.63
11/8/2006	12:57:00 PM	Run 2 - 1	6.72	124.63	25.76
11/8/2006	12:57:30 PM	Run 2 - 1	6.72	123.9	25.76
11/8/2006	12:58:00 PM	Run 2 - 1	6.72	123.17	25.76
11/8/2006	12:58:30 PM	Run 2 - 1	6.66	123.17	25.88
11/8/2006	12:59:00 PM	Run 2 - 1	6.59	122.87	25.76
11/8/2006	12:59:30 PM	Run 2 - 1	6.66	123.17	25.76
11/8/2006	1:00:00 PM	Run 2 - 1	6.59	123.46	25.76
11/8/2006	1:00:30 PM	Run 2 - 1	6.53	122.87	25.88
11/8/2006	1:01:00 PM	Run 2 - 1	6.53	121.85	25.76
11/8/2006	1:01:30 PM	Run 2 - 1	6.53	121.56	25.76
11/8/2006	1:02:00 PM	Run 2 - 1	6.53	121.7	25.76
11/8/2006	1:02:30 PM	Run 2 - 1	6.59	121.41	25.76
11/8/2006	1:03:00 PM	Run 2 - 1	6.66	120.38	25.76
11/8/2006	1:03:30 PM	Run 2 - 1	6.72	119.36	25.63
11/8/2006	1:04:00 PM	Run 2 - 1	6.78	118.63	25.51
11/8/2006	1:04:30 PM	Run 2 - 1	6.72	118.48	25.51
11/8/2006	1:05:00 PM	Run 2 - 1	6.78	119.07	25.51
11/8/2006	1:05:30 PM	Run 2 - 1	6.72	119.21	25.76
11/8/2006	1:06:00 PM	Run 2 - 1	6.72	118.63	25.76
11/8/2006	1:06:30 PM	Run 2 - 1	6.72	117.6	25.76
11/8/2006	1:07:00 PM	Run 2 - 1	6.66	117.31	25.88
11/8/2006	1:07:30 PM	Run 2 - 1	6.59	117.9	25.88

LabView Run Log

Date	Time	Status	O2 (%)	SO2 (PPM)	CO22 (%)
11/8/2006	1:08:00 PM	Run 2 - 1	6.59	118.48	26
11/8/2006	1:08:30 PM	Run 2 - 1	6.53	118.33	26.12
11/8/2006	1:09:00 PM	Run 2 - 1	6.41	118.04	26.12
11/8/2006	1:09:30 PM	Run 2 - 1	6.35	117.9	26
11/8/2006	1:10:00 PM	Run 2 - 1	6.35	118.33	26
11/8/2006	1:10:30 PM	Run 2 - 1	6.41	119.21	26
11/8/2006	1:11:00 PM	Run 2 - 1	6.47	119.36	26
11/8/2006	1:11:30 PM	Run 2 - 1	6.47	118.92	25.88
11/8/2006	1:12:00 PM	Run 2 - 1	6.53	118.04	25.88
11/8/2006	1:12:30 PM	Run 2 - 1	6.53	118.19	25.76
11/8/2006	1:13:00 PM	Run 2 - 1	6.66	119.07	25.76
11/8/2006	1:13:30 PM	Run 2 - 1	6.66	119.21	25.88
11/8/2006	1:14:00 PM	Run 2 - 1	6.66	119.07	25.76
11/8/2006	1:14:30 PM	Run 2 - 1	6.72	117.75	25.76
11/8/2006	1:15:00 PM	Run 2 - 1	6.72	117.6	25.76
11/8/2006	1:15:30 PM	Run 2 - 1	6.72	117.6	25.63
11/8/2006	1:16:00 PM	Run 2 - 1	6.72	118.19	25.76
11/8/2006	1:16:30 PM	Run 2 - 1	6.84	117.9	25.63
11/8/2006	1:17:00 PM	Run 2 - 1	6.84	116.58	25.63
11/8/2006	1:17:30 PM	Run 2 - 1	6.84	115.99	25.63
11/8/2006	1:18:00 PM	Run 2 - 1	6.9	115.99	25.51
11/8/2006	1:18:30 PM	Run 2 - 1	6.84	116.87	25.63
11/8/2006	1:19:00 PM	Run 2 - 1	6.84	116.58	25.76
11/8/2006	1:19:30 PM	Run 2 - 1	6.78	116.14	25.63
11/8/2006	1:20:00 PM	Run 2 - 1	6.78	115.26	25.76
11/8/2006	1:20:30 PM	Run 2 - 1	6.59	115.7	26
11/8/2006	1:21:00 PM	Run 2 - 1	6.53	117.02	26.12
11/8/2006	1:21:30 PM	Run 2 - 1	6.47	117.02	26
11/8/2006	1:22:00 PM	Run 2 - 1	6.41	116.58	26.12
11/8/2006	1:22:30 PM	Run 2 - 1	6.41	116.28	26.12
11/8/2006	1:23:00 PM	Run 2 - 1	6.35	116.43	26.12
11/8/2006	1:23:30 PM	Run 2 - 1	6.41	116.58	26.12
11/8/2006	1:24:00 PM	Run 2 - 1	6.41	117.02	26
11/8/2006	1:24:30 PM	Run 2 - 1	6.47	117.16	26
11/8/2006	1:25:00 PM	Run 2 - 1	6.53	116.72	25.88
11/8/2006	1:25:30 PM	Run 2 - 1	6.59	116.14	25.88
11/8/2006	1:26:00 PM	Run 2 - 1	6.66	116.14	25.88
11/8/2006	1:26:30 PM	Run 2 - 1	6.66	116.58	25.88
11/8/2006	1:27:00 PM	Run 2 - 1	6.78	116.58	25.88
11/8/2006	1:27:30 PM	Run 2 - 1	6.53	117.02	26.24
11/8/2006	1:28:00 PM	Run 2 - 1	6.53	117.16	26.12
11/8/2006	1:28:30 PM	Run 2 - 1	6.47	117.46	26.12
11/8/2006	1:29:00 PM	Run 2 - 1	6.41	117.46	26.12
11/8/2006	1:29:30 PM	Run 2 - 1	6.41	117.75	26.24
11/8/2006	1:30:00 PM	Run 2 - 1	6.35	118.04	26.24
11/8/2006	1:30:30 PM		6.41	118.19	26.24
11/8/2006	1:31:00 PM		6.29	109.99	26.37
11/8/2006	1:31:30 PM		2.93	9.81	12.94
11/8/2006	1:32:00 PM		0.06	2.63	1.22
11/8/2006	1:32:30 PM	- ZERO	0	1.75	0.24

LabView Run Log

Date	Time	Status	O2 (%)	SO2 (PPM)	CO22 (%)
11/8/2006	1:33:00 PM	- ZERO	0	1.61	0.12
11/8/2006	1:33:30 PM	- ZERO	4.64	1.02	3.66
11/8/2006	1:34:00 PM	- ZERO	9.95	1.02	8.42
11/8/2006	1:34:30 PM	- Span	10.07	0.58	8.67
11/8/2006	1:35:00 PM	- Span	9.4	0.73	9.03
11/8/2006	1:35:30 PM	- Span	1.04	0.73	22.22
11/8/2006	1:36:00 PM	- Span	-0.06	0.73	24.66
11/8/2006	1:36:30 PM	- Span	-0.06	0.58	24.78
11/8/2006	1:37:00 PM	- Span	-0.06	94.75	24.66
11/8/2006	1:37:30 PM	- Span	-0.06	149.09	12.57
11/8/2006	1:38:00 PM	- Span	-0.06	153.92	10.01
11/8/2006	1:38:30 PM	- Span	-0.06	154.07	10.01
11/8/2006	1:39:00 PM	- Span	-0.06	154.36	10.01
11/8/2006	1:39:30 PM	- Span	-0.06	155.53	9.89
11/8/2006	1:40:00 PM	- Span	-0.06	154.22	9.89
11/8/2006	1:40:30 PM	- Span	-0.06	154.51	9.89
11/8/2006	1:41:00 PM	- Span	-0.06	155.1	9.89
11/8/2006	1:41:30 PM	- Span	-0.06	155.68	10.01
11/8/2006	1:42:00 PM	- Span	-0.06	155.24	9.89
11/8/2006	1:42:30 PM	- Span	-0.06	155.83	9.89
11/8/2006	1:43:00 PM	- Span	-0.06	155.83	9.76
11/8/2006	1:43:30 PM	- Span	-0.06	155.1	9.89
11/8/2006	1:44:00 PM	- Span	2.93	120.68	16.48
11/8/2006	1:44:30 PM	- Span	6.29	118.63	25.15
11/8/2006	1:45:00 PM	- Span	6.47	118.63	26.24
11/8/2006	1:45:30 PM	- Span	6.41	117.9	26.24
11/8/2006	1:46:00 PM	- Span	6.29	118.19	26.49
11/8/2006	1:46:30 PM	- Span	6.23	119.21	26.49
11/8/2006	1:47:00 PM	- Span	6.23	118.77	26.49
11/8/2006	1:47:30 PM	- Span	6.23	119.07	26.49
11/8/2006	1:48:00 PM	- Span	6.23	119.36	26.37
11/8/2006	1:48:30 PM	- Span	6.29	119.51	26.37
11/8/2006	1:49:00 PM	- Span	6.35	118.33	26.37
11/8/2006	1:49:30 PM	- Span	6.41	118.33	26.24
11/8/2006	1:50:00 PM	- Span	6.41	119.07	26.12
11/8/2006	1:50:30 PM	- Span	6.53	119.07	26
11/8/2006	1:51:00 PM	- Span	6.53	119.36	25.88
11/8/2006	1:51:30 PM	- Span	6.66	118.92	25.88
11/8/2006	1:52:00 PM	- Span	6.72	118.04	25.76
11/8/2006	1:52:30 PM	- Span	6.72	117.75	25.76
11/8/2006	1:53:00 PM	- Span	6.72	117.46	25.88
11/8/2006	1:53:30 PM	- Span	6.78	118.04	25.88
11/8/2006	1:54:00 PM	- Span	6.84	117.6	25.76
11/8/2006	1:54:30 PM	- Span	6.78	117.16	25.88
11/8/2006	1:55:00 PM	- Span	6.72	117.02	25.88
11/8/2006	1:55:30 PM	- Span	6.72	116.58	25.88
11/8/2006	1:56:00 PM	- Span	6.72	116.72	26
11/8/2006	1:56:30 PM	- Span	6.59	117.02	26
11/8/2006	1:57:00 PM	- Span	6.59	117.46	26
11/8/2006	1:57:30 PM	- Span	6.47	117.02	26.12

LabView Run Log

Date	Time	Status	O2 (%)	SO2 (PPM)	CO22 (%)
11/8/2006	1:58:00 PM	- Span	6.41	116.58	26.37
11/8/2006	1:58:30 PM	- Span	6.29	116.43	26.24
11/8/2006	1:59:00 PM	- Span	6.29	117.75	26.37
11/8/2006	1:59:30 PM	- Span	6.29	118.04	26.24
11/8/2006	2:00:00 PM	- Span	6.29	118.63	26.12
11/8/2006	2:00:30 PM	- Span	6.41	117.75	25.88
11/8/2006	2:01:00 PM	- Span	6.59	116.72	25.76
11/8/2006	2:01:30 PM	- Span	6.72	116.87	25.76
11/8/2006	2:02:00 PM	- Span	6.72	116.87	25.63
11/8/2006	2:02:30 PM	- Span	6.72	117.02	25.76
11/8/2006	2:03:00 PM	- Span	6.72	117.02	25.88
11/8/2006	2:03:30 PM	- Span	6.66	116.72	25.88
11/8/2006	2:04:00 PM	- Span	6.66	116.58	25.88
11/8/2006	2:04:30 PM	- Span	6.59	117.02	26
11/8/2006	2:05:00 PM	- Span	6.59	117.16	26
11/8/2006	2:05:30 PM	- Span	6.53	117.02	26
11/8/2006	2:06:00 PM	- Span	6.59	116.28	26
11/8/2006	2:06:30 PM	- Span	6.59	116.72	26
11/8/2006	2:07:00 PM	- Span	6.53	117.02	26
11/8/2006	2:07:30 PM	- Span	6.59	117.02	25.88
11/8/2006	2:08:00 PM	- Span	6.59	116.87	26
11/8/2006	2:08:30 PM	- Span	6.53	117.02	26
11/8/2006	2:09:00 PM	- Span	6.59	117.02	26
11/8/2006	2:09:30 PM	- Span	6.41	117.46	26.24
11/8/2006	2:10:00 PM	- Span	6.35	117.75	26.37
11/8/2006	2:10:30 PM	- Span	6.29	118.19	26.24
11/8/2006	2:11:00 PM	- Span	6.35	118.04	26.12
11/8/2006	2:11:30 PM	- Span	6.41	118.19	26.12
11/8/2006	2:12:00 PM	- Span	6.41	118.48	26
11/8/2006	2:12:30 PM	- Span	6.53	118.63	25.88
11/8/2006	2:13:00 PM	- Span	6.59	118.63	25.76
11/8/2006	2:13:30 PM	- Span	6.59	117.9	25.88
11/8/2006	2:14:00 PM	- Span	6.66	117.46	25.76
11/8/2006	2:14:30 PM	- Span	6.72	117.6	25.88
11/8/2006	2:15:00 PM	- Span	6.66	117.9	26
11/8/2006	2:15:30 PM	- Span	6.66	118.33	26
11/8/2006	2:16:00 PM	- Span	6.72	117.31	26
11/8/2006	2:16:30 PM	- Span	6.59	117.46	26.12
11/8/2006	2:17:00 PM	- Span	6.47	118.04	26.24
11/8/2006	2:17:30 PM	- Span	6.41	118.04	26.37
11/8/2006	2:18:00 PM	- Span	6.35	118.63	26.37
11/8/2006	2:18:30 PM	- Span	6.23	118.77	26.49
11/8/2006	2:19:00 PM	- Span	6.11	119.07	26.61
11/8/2006	2:19:30 PM	- Span	6.04	119.36	26.61
11/8/2006	2:20:00 PM	- Span	5.98	120.38	26.61
11/8/2006	2:20:30 PM	- Span	5.98	121.41	26.61
11/8/2006	2:21:00 PM	- Span	5.98	122	26.49
11/8/2006	2:21:30 PM	- Span	6.04	122.44	26.37
11/8/2006	2:22:00 PM	- Span	6.11	122	26.37
11/8/2006	2:22:30 PM	- Span	6.29	122.29	26.12

LabView Run Log

Date	Time	Status	O2 (%)	SO2 (PPM)	CO22 (%)
11/8/2006	2:23:00 PM	- Span	6.35	122	26.12
11/8/2006	2:23:30 PM	- Span	6.41	122.58	26.12
11/8/2006	2:24:00 PM	- Span	6.47	122.87	26.12
11/8/2006	2:24:30 PM	- Span	6.53	122.14	25.88
11/8/2006	2:25:00 PM	- Span	6.66	122.29	25.88
11/8/2006	2:25:30 PM	- Span	6.66	122.14	25.88
11/8/2006	2:26:00 PM	- Span	6.72	121.85	25.88
11/8/2006	2:26:30 PM	- Span	6.72	122.14	25.76
11/8/2006	2:27:00 PM	- Span	6.78	121.12	25.88
11/8/2006	2:27:30 PM	- Span	6.72	120.53	25.88
11/8/2006	2:28:00 PM	- Span	6.66	120.68	26
11/8/2006	2:28:30 PM	Run 3 - 1	6.53	120.68	26.12
11/8/2006	2:29:00 PM	Run 3 - 1	6.53	120.97	26.12
11/8/2006	2:29:30 PM	Run 3 - 1	6.41	120.68	26.24
11/8/2006	2:30:00 PM	Run 3 - 1	6.35	120.82	26.24
11/8/2006	2:30:30 PM	Run 3 - 1	6.23	120.68	26.37
11/8/2006	2:31:00 PM	Run 3 - 1	6.23	120.97	26.12
11/8/2006	2:31:30 PM	Run 3 - 1	6.29	120.82	26.12
11/8/2006	2:32:00 PM	Run 3 - 1	6.41	120.97	26
11/8/2006	2:32:30 PM	Run 3 - 1	6.41	121.12	26
11/8/2006	2:33:00 PM	Run 3 - 1	6.53	120.38	26
11/8/2006	2:33:30 PM	Run 3 - 1	6.53	119.8	26.12
11/8/2006	2:34:00 PM	Run 3 - 1	6.53	119.51	26
11/8/2006	2:34:30 PM	Run 3 - 1	6.53	120.53	26.12
11/8/2006	2:35:00 PM	Run 3 - 1	6.47	120.97	26
11/8/2006	2:35:30 PM	Run 3 - 1	6.53	119.95	26.12
11/8/2006	2:36:00 PM	Run 3 - 1	6.59	119.65	26
11/8/2006	2:36:30 PM	Run 3 - 1	6.53	119.36	26
11/8/2006	2:37:00 PM	Run 3 - 1	6.53	119.21	26
11/8/2006	2:37:30 PM	Run 3 - 1	6.53	119.51	26
11/8/2006	2:38:00 PM	Run 3 - 1	6.59	119.65	25.88
11/8/2006	2:38:30 PM	Run 3 - 1	6.59	119.36	25.88
11/8/2006	2:39:00 PM	Run 3 - 1	6.59	119.07	26
11/8/2006	2:39:30 PM	Run 3 - 1	6.53	118.77	26
11/8/2006	2:40:00 PM	Run 3 - 1	6.47	118.92	26
11/8/2006	2:40:30 PM	Run 3 - 1	6.47	119.07	26
11/8/2006	2:41:00 PM	Run 3 - 1	6.41	119.65	26.12
11/8/2006	2:41:30 PM	Run 3 - 1	6.41	119.8	26
11/8/2006	2:42:00 PM	Run 3 - 1	6.29	120.09	26.12
11/8/2006	2:42:30 PM	Run 3 - 1	6.35	120.24	26.12
11/8/2006	2:43:00 PM	Run 3 - 1	6.35	120.68	26
11/8/2006	2:43:30 PM	Run 3 - 1	6.29	120.97	26
11/8/2006	2:44:00 PM	Run 3 - 1	6.29	121.26	26
11/8/2006	2:44:30 PM	Run 3 - 1	6.29	120.68	26
11/8/2006	2:45:00 PM	Run 3 - 1	6.29	120.53	26
11/8/2006	2:45:30 PM	Run 3 - 1	6.29	120.97	26.12
11/8/2006	2:46:00 PM	Run 3 - 1	6.41	121.26	26
11/8/2006	2:46:30 PM	Run 3 - 1	6.53	121.41	25.88
11/8/2006	2:47:00 PM	Run 3 - 1	6.53	121.26	25.88
11/8/2006	2:47:30 PM	Run 3 - 1	6.53	120.82	25.88

LabView Run Log

Date	Time	Status	O2 (%)	SO2 (PPM)	CO22 (%)
11/8/2006	2:48:00 PM	Run 3 - 1	6.59	120.38	25.88
11/8/2006	2:48:30 PM	Run 3 - 1	6.59	120.38	25.88
11/8/2006	2:49:00 PM	Run 3 - 1	6.53	121.41	25.88
11/8/2006	2:49:30 PM	Run 3 - 1	6.53	121.41	25.88
11/8/2006	2:50:00 PM	Run 3 - 1	6.59	120.53	25.88
11/8/2006	2:50:30 PM	Run 3 - 1	6.53	119.65	25.88
11/8/2006	2:51:00 PM	Run 3 - 1	6.53	119.36	25.88
11/8/2006	2:51:30 PM	Run 3 - 1	6.53	120.09	25.76
11/8/2006	2:52:00 PM	Run 3 - 1	6.53	120.82	25.88
11/8/2006	2:52:30 PM	Run 3 - 1	6.59	120.24	25.88
11/8/2006	2:53:00 PM	Run 3 - 1	6.59	119.51	25.88
11/8/2006	2:53:30 PM	Run 3 - 1	6.53	118.77	25.88
11/8/2006	2:54:00 PM	Run 3 - 1	6.47	119.65	25.88
11/8/2006	2:54:30 PM	Run 3 - 1	6.47	120.38	25.88
11/8/2006	2:55:00 PM	Run 3 - 1	6.53	119.95	25.88
11/8/2006	2:55:30 PM	Run 3 - 1	6.53	119.36	25.76
11/8/2006	2:56:00 PM	Run 3 - 1	6.59	118.48	25.76
11/8/2006	2:56:30 PM	Run 3 - 1	6.78	117.9	25.76
11/8/2006	2:57:00 PM	Run 3 - 1	6.84	117.75	25.76
11/8/2006	2:57:30 PM	Run 3 - 1	6.78	117.9	25.88
11/8/2006	2:58:00 PM	Run 3 - 1	6.66	117.6	26
11/8/2006	2:58:30 PM	Run 3 - 1	6.53	118.19	26.12
11/8/2006	2:59:00 PM	Run 3 - 1	6.41	118.19	26.24
11/8/2006	2:59:30 PM	Run 3 - 1	6.35	118.48	26.24
11/8/2006	3:00:00 PM	Run 3 - 1	6.29	118.48	26.24
11/8/2006	3:00:30 PM	Run 3 - 1	6.23	118.48	26.24
11/8/2006	3:01:00 PM	Run 3 - 1	6.23	118.48	26.24
11/8/2006	3:01:30 PM	Run 3 - 1	6.29	118.19	26.24
11/8/2006	3:02:00 PM	Run 3 - 1	6.29	118.92	26.12
11/8/2006	3:02:30 PM	Run 3 - 1	6.23	120.09	26.12
11/8/2006	3:03:00 PM	Run 3 - 1	6.23	120.38	26.24
11/8/2006	3:03:30 PM	Run 3 - 1	6.29	120.24	26.24
11/8/2006	3:04:00 PM	Run 3 - 1	6.29	119.95	26.12
11/8/2006	3:04:30 PM	Run 3 - 1	6.29	121.12	26.24
11/8/2006	3:05:00 PM	Run 3 - 1	6.29	121.41	26.12
11/8/2006	3:05:30 PM	Run 3 - 1	6.35	121.41	26.24
11/8/2006	3:06:00 PM	Run 3 - 1	6.29	122	26.24
11/8/2006	3:06:30 PM	Run 3 - 1	6.35	121.7	26.12
11/8/2006	3:07:00 PM	Run 3 - 1	6.41	122.14	26.12
11/8/2006	3:07:30 PM	Run 3 - 1	6.41	122.44	26.12
11/8/2006	3:08:00 PM	Run 3 - 1	6.47	122.29	26
11/8/2006	3:08:30 PM	Run 3 - 1	6.53	122	25.88
11/8/2006	3:09:00 PM	Run 3 - 1	6.59	121.85	25.88
11/8/2006	3:09:30 PM	Run 3 - 1	6.59	121.41	26
11/8/2006	3:10:00 PM	Run 3 - 1	6.53	121.7	26
11/8/2006	3:10:30 PM	Run 3 - 1	6.59	122	25.88
11/8/2006	3:11:00 PM	Run 3 - 1	6.59	122	26
11/8/2006	3:11:30 PM	Run 3 - 1	6.59	121.26	26
11/8/2006	3:12:00 PM	Run 3 - 1	6.53	120.97	26
11/8/2006	3:12:30 PM	Run 3 - 1	6.53	121.26	26

LabView Run Log

Date	Time	Status	O2 (%)	SO2 (PPM)	CO22 (%)
11/8/2006	3:13:00 PM	Run 3 - 1	6.47	121.12	26
11/8/2006	3:13:30 PM	Run 3 - 1	6.53	120.38	26
11/8/2006	3:14:00 PM	Run 3 - 1	6.47	120.53	26
11/8/2006	3:14:30 PM	Run 3 - 1	6.41	120.97	26.12
11/8/2006	3:15:00 PM	Run 3 - 1	6.35	121.56	26.12
11/8/2006	3:15:30 PM	Run 3 - 1	6.41	120.97	26
11/8/2006	3:16:00 PM	Run 3 - 1	6.47	120.68	26.12
11/8/2006	3:16:30 PM	Run 3 - 1	6.41	119.8	26.12
11/8/2006	3:17:00 PM	Run 3 - 1	6.41	119.95	26
11/8/2006	3:17:30 PM	Run 3 - 1	6.47	120.24	26.12
11/8/2006	3:18:00 PM	Run 3 - 1	6.53	120.97	26
11/8/2006	3:18:30 PM	Run 3 - 1	6.41	120.97	26.12
11/8/2006	3:19:00 PM	Run 3 - 1	6.47	120.82	26.12
11/8/2006	3:19:30 PM	Run 3 - 1	6.47	120.82	26
11/8/2006	3:20:00 PM	Run 3 - 1	6.47	120.97	26
11/8/2006	3:20:30 PM	Run 3 - 1	6.47	120.38	25.88
11/8/2006	3:21:00 PM	Run 3 - 1	6.59	120.24	25.88
11/8/2006	3:21:30 PM	Run 3 - 1	6.59	120.97	26
11/8/2006	3:22:00 PM	Run 3 - 1	6.59	120.82	26
11/8/2006	3:22:30 PM	Run 3 - 1	6.47	120.82	26
11/8/2006	3:23:00 PM	Run 3 - 1	6.47	121.12	26.12
11/8/2006	3:23:30 PM	Run 3 - 1	6.35	121.26	26
11/8/2006	3:24:00 PM	Run 3 - 1	6.41	120.68	26
11/8/2006	3:24:30 PM	Run 3 - 1	6.35	120.53	26.12
11/8/2006	3:25:00 PM	Run 3 - 1	6.35	121.56	26.12
11/8/2006	3:25:30 PM	Run 3 - 1	6.35	122	26
11/8/2006	3:26:00 PM	Run 3 - 1	6.35	122.14	26
11/8/2006	3:26:30 PM	Run 3 - 1	6.29	122	26
11/8/2006	3:27:00 PM	Run 3 - 1	6.35	122	26
11/8/2006	3:27:30 PM	Run 3 - 1	6.47	121.56	25.88
11/8/2006	3:28:00 PM	Run 3 - 1	6.41	121.26	26
11/8/2006	3:28:30 PM		6.41	122	26
11/8/2006	3:29:00 PM		3.66	13.18	15.5
11/8/2006	3:29:30 PM		0.31	2.49	2.07
11/8/2006	3:30:00 PM	- ZERO	0	1.32	0.24
11/8/2006	3:30:30 PM	- ZERO	0	1.02	0.24
11/8/2006	3:31:00 PM	- ZERO	0	0.88	0.12
11/8/2006	3:31:30 PM	- ZERO	3.24	0.73	2.32
11/8/2006	3:32:00 PM	- ZERO	9.89	0.44	8.3
11/8/2006	3:32:30 PM	- Span	10.07	0.44	8.67
11/8/2006	3:33:00 PM	- Span	10.07	0.44	8.67
11/8/2006	3:33:30 PM	- Span	3.91	0.58	17.58
11/8/2006	3:34:00 PM	- Span	0	0.58	24.41
11/8/2006	3:34:30 PM	- Span	-0.06	0.44	24.66
11/8/2006	3:35:00 PM	- Span	-0.06	39.69	24.66
11/8/2006	3:35:30 PM	- Span	-0.06	143.52	16.36
11/8/2006	3:36:00 PM	- Span	-0.06	153.48	10.01
11/8/2006	3:36:30 PM	- Span	-0.06	155.24	10.01
11/8/2006	3:37:00 PM	- Span	0.25	129.03	10.13

CALIBRATION GAS CERTIFICATIONS

RDD0007

RATA CLASS



Scott Specialty Gases

Dual-Analyzed Calibration Standard

6141 EASTON ROAD, BLDG 1, PLUMSTEADVILLE, PA 18949-0310

Phone: 800-331-6953

Fax: 215-766-7226

CERTIFICATE OF ACCURACY: Interference Free Multi-Component EPA Protocol Gas

Assay Laboratory

SCOTT SPECIALTY GASES
6141 EASTON ROAD, BLDG 1
PLUMSTEADVILLE, PA 18949 0310

P.O. No.: E-N06925
Project No.: 01-22406-003

Customer

TAMPA ELECTRIC COMPANY
CHARLES DUFENY
5010 CAUSEWAY BLVD
TAMPA FL 33619

ANALYTICAL INFORMATION

This certification was performed according to EPA Traceability Protocol for Assay & Certification of Gaseous Calibration Standards; Procedure G-1, September, 1997

Cylinder Number: A1M057237 Certification Date: 28Dec2004 Exp. Date: 28Dec2006
Cylinder Pressure***: 1945 PSIG

COMPONENT	CERTIFIED CONCENTRATION (Moles)	ANALYTICAL ACCURACY**	TRACEABILITY
CARBON DIOXIDE	9.35 %	± 1%	Direct NIST and NMJ
SULFUR DIOXIDE *	152.5 PPM	± 1%	Direct NIST and NMJ
NITROGEN	BALANCE		

*** Do not use when cylinder pressure is below 1500 psig

** Analytical accuracy is based on the requirements of the procedure G-1, September 1997

Product certified as ± 1% analytical accuracy is traceable to NIST or NMJ standards

* This standard has been certified using a certified NIST Sulfur Dioxide gas and EPA procedure dated 7-24-99 and will not interfere with an uncalibrated flow check

REFERENCE STANDARD

TYPE/SRM NO.	EXPIRATION DATE	CYLINDER NUMBER	CONCENTRATION	COMPONENT
NIRM 0250	01/01/2005	E020140	5.000 %	CARBON DIOXIDE
NIRM 0250	01/01/2006	A1M057237	200.0 PPM	SULFUR DIOXIDE

INSTRUMENTATION

INSTRUMENT/MODEL/SERIAL#	DATE LAST CALIBRATED	ANALYTICAL PRINCIPLE
MKS Online 2030/MG-09-149	23Dec2004	FIR
MKS Online 2030/MG-09-149	17Dec2004	FTIR

ANALYZER READINGS

(Z = Zero Gas R = Reference Gas T = Test Gas r = Correlation Coefficient)

First Triad Analysis

Second Triad Analysis

Calibration Curve

CARBON DIOXIDE

Date: 20Dec2004 Response Unit: %

Z1 = -0.00111	R1 = 13.89007	T1 = 9.56443
R2 = 13.89295	Z2 = 0.00079	T2 = 9.97042
Z3 = -0.00076	T3 = 10.01719	R3 = 13.90864
Avg. Concentration: 10.01 %		

Date: 28Dec2004 Response Unit: %

Z1 = -0.00101	R1 = 9.01840	T1 = 9.57332
R2 = 9.02579	Z2 = -0.00056	T2 = 9.96000
Z3 = -0.00213	T3 = 9.90065	R3 = 9.02356
Avg. Concentration: 9.250 %		

Concentration = A + Bx + Cx² + Dx³ + Ex⁴
r = 0.99955E-1

Constants: A = 0.00000E+0
B = 9.47038E-1 C = 1.37310E-2
D = 0.00000E+0 E = 0.00000E+0

SULFUR DIOXIDE *

Date: 20Dec2004 Response Unit: PPM

Z1 = -0.08802	R1 = 266.3957	T1 = 152.2350
R2 = 266.4079	Z2 = -0.07565	T2 = 152.3949
Z3 = -0.02365	T3 = 152.4465	R3 = 266.5110
Avg. Concentration: 152.5 PPM		

Date: 28Dec2004 Response Unit: PPM

Z1 = -0.00025	R1 = 266.3565	T1 = 152.3805
R2 = 266.3786	Z2 = -0.01377	T2 = 152.4383
Z3 = -0.02103	T3 = 152.5542	R3 = 266.4603
Avg. Concentration: 152.5 PPM		

Concentration = A + Bx + Cx² + Dx³ + Ex⁴
r = 0.99974E-1

Constants: A = 0.00000E+0
B = 9.76119E-1 C = 1.20000E-5
D = 0.00000E+0 E = 0.00000E+0

APPROVED BY:

R00018

RATA CLASS



Scott Specialty Gases

Dual-Analyzed Calibration Standard

6141 EASTON ROAD, BLDG 1, PLUMSTEADVILLE, PA 18949-0310

Phone: 800-331-4953

Fax: 215-766-7226

CERTIFICATE OF ACCURACY: Interference Free Multi-Component EPA Protocol Gas

Assay Laboratory

SCOTT SPECIALTY GASES
6141 EASTON ROAD, BLDG 1
PLUMSTEADVILLE, PA 18949-0310

P.O. No.: E-N06925
Project No.: 01-22406-002

Customer

TAMPA ELECTRIC COMPANY
CHARLES DUFENY
5010 CAUSEWAY BLVD
TAMPA FL 33619

ANALYTICAL INFORMATION

This certification was performed according to EPA Traceability Protocol For Assay & Certification of Gaseous Calibration Standards; Procedure G-1; September, 1997.

Cylinder Number: ALM029767 Certification Date: 27Dec2004 Exp. Date: 27Dec2006
Cylinder Pressure: 1939 PSIG

Table with 4 columns: COMPONENT, CERTIFIED CONCENTRATION (Moles), ACCURACY, TRACEABILITY. Rows include CARBON DIOXIDE, SULFUR DIOXIDE, and NITROGEN.

** Do not use other cylinder pressure is below 150 psig

** Analytical accuracy is based on the requirements of EPA Protocol Procedure G-1, September 1997.

Product certified at +/- 1% analytical accuracy is directly traceable to NIST or NMI standards

* This Protocol has been certified using corrected NIST SO2 standard values, per EPA guidance dated 1/24/98 and will not correlate with interlaboratory protocols

REFERENCE STANDARD

Table with 5 columns: TYPE/SKM NO., EXPIRATION DATE, CYLINDER NUMBER, CONCENTRATION, COMPONENT. Rows include NTRM 1855 and NTRM 0269.

INSTRUMENTATION

Table with 3 columns: INSTRUMENT/MODEL/SERIAL#, DATE LAST CALIBRATED, ANALYTICAL PRINCIPLE. Rows include MRS Online/2030/AG-09-149 and MRS Online/2020/MG-09-149.

ANALYZER READINGS

(Z = Zero Gas R = Reference Gas T = Test Gas r = Correlation Coefficient)

First Triad Analysis

Second Triad Analysis

Calibration Curve

CARBON DIOXIDE

Table with 3 columns: Data, Response Unit:%, Avg. Concentration. Includes response data for Z1, R2, Z3 and average concentration of 17.97%.

Empty table box for Carbon Dioxide analysis.

Table with 2 columns: Concentration = A + Bx + Cx2 + Dx3 + Ex4, Constants. Includes calibration equation and constants A through E.

SULFUR DIOXIDE

Table with 3 columns: Data, Response Unit:PPM, Avg. Concentration. Includes response data for Z1, R2, Z3 and average concentration of 269.0 PPM.

Table with 3 columns: Data, Response Unit: PPM, Avg. Concentration. Includes response data for Z1, R2, Z3 and average concentration of 269.1 PPM.

Table with 2 columns: Concentration = A + Bx + Cx2 + Dx3 + Ex4, Constants. Includes calibration equation and constants A through E.

APPROVED BY:

Handwritten signature

BL501

RATA CLASS



Scott Specialty Gases

Dual-Analyzed Calibration Standard

1290 COMBERMERE STREET, TROY, MI 48063

Phone: 248-589-2950

Fax: 248-589-2134

CERTIFICATE OF ACCURACY: EPA Protocol Gas

Assay Laboratory

SCOTT SPECIALTY GASES
1290 COMBERMERE STREET
TROY, MI 48063

P.O. No.: E-806925
Project No.: 05-27508-004

Customer

TAMPA ELECTRIC COMPANY
CHARLES DUFENY
5010 CAUSEWAY BLVD
TAMPA FL 33619

ANALYTICAL INFORMATION

This certification was performed according to EPA Traceability Protocol For Assay & Certification of Gaseous Calibration Standards: Procedure G-1, September, 1997

Cylinder Number: ALM042687 Certification Date: 07Feb2005 Exp. Date: 07Feb2008
Cylinder Pressure***: 1850 PSIG

COMPONENT	CERTIFIED CONCENTRATION (Moles)	ANALYTICAL ACCURACY**	TRACEABILITY
CARBON DIOXIDE	25.07 %	+/- 1%	Direct NIST and NMI
NITROGEN	BALANCE		

*** Do not use when cylinder pressure is below 150 psig

** Analytical accuracy is based on the requirements of EPA Protocol Procedure G-1, September 1997

Product certified to +/- 1% analytical accuracy is directly traceable to NIST or NMI standards

REFERENCE STANDARD

TYPE/SRM NO.	EXPIRATION DATE	CYLINDER NUMBER	CONCENTRATION	COMPONENT
HTRM 7300	01Jan2008	ALM049147	23.34 %	CARBON DIOXIDE

INSTRUMENTATION

INSTRUMENT/MODEL/SERIAL#	DATE LAST CALIBRATED	ANALYTICAL PRINCIPLE
VARAN0600/10804	26Jan2005	THERMAL CONDUCTIVITY

ANALYZER READINGS

(Z = Zero Gas R = Reference Gas T = Test Gas r = Correlation Coefficient)

First Triad Analysis

Second Triad Analysis

Calibration Curve

CARBON DIOXIDE

Date: 07Feb2005	Response Unit: AREA
Z1 = 0.00000	R1 = 1714000, T1 = 1304309
R2 = 1213747	Z2 = 0.00000, T2 = 1304306
T3 = 0.00000	T3 = 1304309, R3 = 1214512
Avg. Concentration:	25.07 %

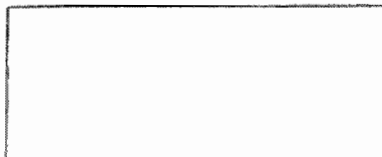

Concentration = A + Bx + Cx ² + Dx ³ + Ex ⁴	
r =	0.99999
Constants:	A = -0.25098732
	B = 1.94E-08
	C = 0
	D = 0
	E = 0

APPROVED BY:

DAVID BABCOCK

BL502

RATA CLASS



Scott Specialty Gases

Dual-Analyzed Calibration Standard

1290 COMBERMERE STREET, TROY, MI 48063

Phone: 248-589-2950

Fax: 248-589-2134

CERTIFICATE OF ACCURACY: EPA Protocol Gas

Assay Laboratory

SCOTT SPECIALTY GASES
1290 COMBERMERE STREET
TROY, MI 48083

P.O. No.: E-N06925
Project No.: 05-27508-005

Customer

TAMPA ELECTRIC COMPANY
CHARLES DUFENY
5010 CAUSEWAY BLVD
TAMPA FL 33619

ANALYTICAL INFORMATION

This certification was performed according to EPA Traceability Protocol For Assay & Certification of Gaseous Calibration Standards; Procedure G-1; September, 1997.

Cylinder Number: ALMO16344 Certification Date: 07Feb2005 Exp. Date: 07Feb2008
Cylinder Pressure***: 1850 PSIG

Table with 4 columns: COMPONENT, CERTIFIED CONCENTRATION (Moles), ANALYTICAL ACCURACY**, TRACEABILITY. Rows for CARBON DIOXIDE and NITROGEN.

*** Do not use when cylinder pressure is below 140 psig

** Analytical accuracy is based on the requirements of EPA Protocol Procedure G1, September 1997

Product certified at +/- 1% analytical accuracy & directly traceable to NIST or NMI standards

REFERENCE STANDARD

Table with 5 columns: TYPE/SRM NO., EXPIRATION DATE, CYLINDER NUMBER, CONCENTRATION, COMPONENT. Row for NITRM 2500.

INSTRUMENTATION

Table with 3 columns: INSTRUMENT/MODEL/SERIAL#, DATE LAST CALIBRATED, ANALYTICAL PRINCIPLE. Row for VARIAN 340010083.

ANALYZER READINGS

IZ = Zero Gas R = Reference Gas T = Test Gas r = Correlation Coefficient

First Triad Analysis

Second Triad Analysis

Calibration Curve

CARBON DIOXIDE

Table with 3 columns: Date, Response Unit, and three columns of data for Z1, R1, T1, Z2, R2, T2, Z3, R3, T3. Includes Avg. Concentration: 45.10 %

Table with 2 columns: Concentration = A + Bx - Cx2 - DxE + Ex4 and Constants: A, B, C, D, E.

APPROVED BY: _____

RATA CLASS



Scott Specialty Gases

Dual-Analyzed Calibration Standard

6141 EASTON ROAD, BLDG 1, PLUMSTEADVILLE, PA 18949-0310

Phone: 800-331-4953

Fax: 215-766-7226

CERTIFICATE OF ACCURACY: EPA Protocol Gas

Assay Laboratory

SCOTT SPECIALTY GASES
6141 EASTON ROAD, BLDG 1
PLUMSTEADVILLE, PA 18949-0310

P.O. No.: E-N08925
Project No.: 01-58671-001

Customer

TAMPA ELECTRIC COMPANY
CHARLES DUFENY
5010 CAUSEWAY BLVD
TAMPA FL 33619

ANALYTICAL INFORMATION

This certification was performed according to EPA Traceability Protocol For Assay & Certification of Gaseous Calibration Standards; Procedure G-1; September, 1997.

Cylinder Number: AAL20064 Certification Date: 12Oct2006 Exp. Date: 11Oct2009
Cylinder Pressure***: 2000 PSIG

COMPONENT	CERTIFIED CONCENTRATION (Moles)	ANALYTICAL ACCURACY**	TRACEABILITY
CARBON DIOXIDE	8.96 %	+/- 1%	Direct NIST and NMI
OXYGEN	10.1 %	+/- 1%	Direct NIST and NMI
NITROGEN	BALANCE		

*** Do not use when cylinder pressure is below 150 psig.

** Analytical accuracy is based on the requirements of EPA Protocol Procedure G1, September 1997.

REFERENCE STANDARD

TYPE/SRM NO.	EXPIRATION DATE	CYLINDER NUMBER	CONCENTRATION	COMPONENT
NTRM 1675	04Jul2008	K001509	13.93 %	CARBON DIOXIDE
NTRM 2658	02Oct2010	ALM065248	9.930 %	OXYGEN

INSTRUMENTATION

INSTRUMENT/MODEL/SERIAL#	DATE LAST CALIBRATED	ANALYTICAL PRINCIPLE
MTI/M200/170927	20Sep2006	GC-TCO
MTI/M200/170927	20Sep2006	GC-TCO

ANALYZER READINGS

(Z = Zero Gas R = Reference Gas T = Test Gas r = Correlation Coefficient)

First Triad Analysis

Second Triad Analysis

Calibration Curve

CARBON DIOXIDE

Date: 12Oct2006 Response Unit: AREA

Z1 = 0.00000	R1 = 643432.0	T1 = 412451.0
R2 = 643593.0	Z2 = 0.00000	T2 = 412322.0
Z3 = 0.00000	T3 = 412407.0	R3 = 643560.0
Avg. Concentration: 8.960 %		

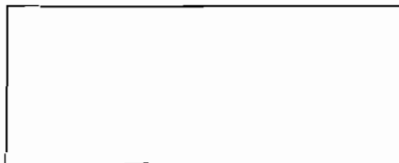

Concentration = A + Bx + Cx² + Dx³ + Ex⁴

r = .999988 1675

Constants: A = -2.56089E-02

B = 2.1778E-05 C =

D = E =

OXYGEN

Date: 12Oct2006 Response Unit: AREA

Z1 = 0.00000	R1 = 255181.0	T1 = 263879.0
R2 = 255371.0	Z2 = 0.00000	T2 = 263727.0
Z3 = 0.00000	T3 = 263736.0	R3 = 254821.0
Avg. Concentration: 10.10 %		



Concentration = A + Bx + Cx² + Dx³ + Ex⁴

r = .999988 2658

Constants: A = 1.9132E-02

B = 3.8059E-05 C =

D = E =

APPROVED BY:

JOHN C. FITZ

BLD04

RATA CLASS



Scott Specialty Gases

Dual-Analyzed Calibration Standard

6141 EASTON ROAD, BLDG 1, PLUMSTEADVILLE, PA 18949-0310

Phone: 800-331-4953

Fax: 215-766-7226

CERTIFICATE OF ACCURACY: EPA Protocol Gas

Assay Laboratory

SCOTT SPECIALTY GASES
6141 EASTON ROAD, BLDG 1
PLUMSTEADVILLE, PA 18949-0310

P.O. No.: E-N06925
Project No.: 01-46476-001

Customer

TAMPA ELECTRIC COMPANY
CHARLES DUFENY
5010 CAUSEWAY BLVD
TAMPA FL 33619

ANALYTICAL INFORMATION

This certification was performed according to EPA Traceability Protocol For Assay & Certification of Gaseous Calibration Standards; Procedure G-1; September, 1997.

Cylinder Number: ALM065020 Certification Date: 13Mar2006 Exp. Date: 12Mar2009
Cylinder Pressure***: 2000 PSIG

COMPONENT	CERTIFIED CONCENTRATION (Moles)	ANALYTICAL ACCURACY**	TRACEABILITY
CARBON DIOXIDE	18.0 %	+/- 1%	Direct NIST and NMI
OXYGEN	20.9 %	+/- 1%	Direct NIST and NMI
NITROGEN	BALANCE		

*** Do not use when cylinder pressure is below 150 psig.

** Analytical accuracy is based on the requirements of EPA Protocol Procedure G1, September 1997.

REFERENCE STANDARD

TYPE/SRM NO.	EXPIRATION DATE	CYLINDER NUMBER	CONCENTRATION	COMPONENT
NTRM 1800	04Jul2008	K004903	17.87 %	CARBON DIOXIDE
NTRM 2659	04Jul2008	K004610	20.85 %	OXYGEN

INSTRUMENTATION

INSTRUMENT/MODEL/SERIAL#	DATE LAST CALIBRATED	ANALYTICAL PRINCIPLE
MTI/M200/170927	21Feb2006	GC-TCD
MTI/M200/170927	21Feb2006	GC-TCD

ANALYZER READINGS

(Z = Zero Gas R = Reference Gas T = Test Gas r = Correlation Coefficient)

First Triad Analysis Second Triad Analysis Calibration Curve

CARBON DIOXIDE

Date: 13Mar2006 Response Unit: AREA

Z1 = 0.00000 R1 = 822312.0 T1 = 837441.0
R2 = 822904.0 Z2 = 0.00000 T2 = 836918.0
Z3 = 0.00000 T3 = 836920.0 R3 = 823055.0

Avg. Concentration: 18.00 %

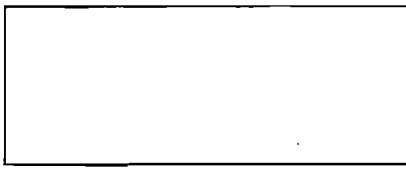

Concentration = A + Bx + Cx2 + Dx3 + Ex4

r = .999979 1800

Constants: A = -2.9027E-04

B = 2.1539E-05 C =

D = E =

OXYGEN

Date: 13Mar2006 Response Unit: AREA

Z1 = 0.00000 R1 = 540826.0 T1 = 550073.0
R2 = 540774.0 Z2 = 0.00000 T2 = 550168.0
Z3 = 0.00000 T3 = 551249.0 R3 = 540080.0

Avg. Concentration: 20.90 %



Concentration = A + Bx + Cx2 + Dx3 + Ex4

r = .999988 2659

Constants: A = 1.9807E-02

B = 3.7982E-05 C =

D = E =

APPROVED BY: JOHN C. FITZ

APPENDIX F
FUEL ANALYSIS

SYNTHETIC GAS ANALYSIS – NOVEMBER 8, 2006

UNIT 1 STACK TEST 11/08/06
CT & ACID PLANT
Calibration Standard Check

	% CO2	% O2	% N2	% CH4	% CO	Calc. % H2	% H2S/COS
True Value	14.70	1.010	2.99	0.1040	45.20	36.00	N.A.
Std. 1	14.67	0.970	2.93	0.1096	44.87	36.45	N.A.
Std. 2	14.73	0.960	2.94	0.1117	45.20	36.06	N.A.
Std. 3	14.77	0.980	2.96	0.1129	45.35	35.83	N.A.
Avg.	14.72	0.970	2.94	0.1114	45.14	36.11	N.A.

Clean Syngas Sampled @ 1040 11/08/06

	% CO2	% O2	% N2	% CH4	% CO	Calc. % H2	% H2S/COS
1st Bomb	17.06	0.890	3.82	0.0161	43.43	34.78	N.A.
2nd Bomb	17.10	0.900	4.13	0.0065	43.56	34.30	N.A.
Avg.	17.08	0.90	3.98	0.0113	43.50	34.54	N.A.

Clean Syngas Sampled @ 1120 11/08/06

	% CO2	% O2	% N2	% CH4	% CO	Calc. % H2	% H2S/COS
1st Bomb	17.39	0.860	3.25	< 0.0050	43.81	34.69	N.A.
2nd Bomb	17.37	0.870	3.51	< 0.0050	43.50	34.75	N.A.
Avg.	17.38	0.87	3.38	<0.0050	43.66	34.72	N.A.

Clean Syngas Sampled @ 1205 11/08/06

	% CO2	% O2	% N2	% CH4	% CO	Calc. % H2	% H2S/COS
1st Bomb	17.44	0.850	3.39	< 0.0050	43.21	35.11	N.A.
2nd Bomb	17.38	0.860	3.63	< 0.0050	43.44	34.69	N.A.
Avg.	17.41	0.86	3.51	<0.0050	43.33	34.90	N.A.

Clean Syngas Sampled @ 1255 11/08/06

	% CO2	% O2	% N2	% CH4	% CO	Calc. % H2	% H2S/COS
1st Bomb	17.67	0.860	3.57	< 0.0050	43.31	34.59	N.A.
2nd Bomb	17.90	0.850	3.28	0.0232	43.59	34.36	N.A.
Avg.	17.79	0.86	3.43	0.0141	43.45	34.47	N.A.

UNIT 1 STACK TEST 11/08/06 CT & ACID PLANT

Clean Syngas Sampled @ 1345 11/08/06

	% CO2	% O2	% N2	% CH4	% CO	Calc. % H2	% H2S/COS
1st Bomb	18.39	0.870	3.48	0.0249	43.11	34.13	N.A.
2nd Bomb	18.40	0.860	3.38	0.0167	42.91	34.43	N.A.
Avg.	18.40	0.87	3.43	0.0208	43.01	34.28	N.A.

Clean Syngas Sampled @ 1430 11/08/06

	% CO2	% O2	% N2	% CH4	% CO	Calc. % H2	% H2S/COS
1st Bomb	18.14	0.870	3.51	0.0166	42.93	34.53	N.A.

Clean Syngas Sampled @ 1520 11/08/06

	% CO2	% O2	% N2	% CH4	% CO	Calc. % H2	% H2S/COS
1st Bomb	18.16	0.900	3.3	0.0177	42.94	34.68	N.A.

Average for All Syngas Samples Using all Results

	% CO2	% O2	% N2	% CH4	% CO	Calc. % H2	% H2S/COS
Avg.	17.70	0.87	3.52	0.0174	43.31	34.59	0



Coal Derived Gas and Heating Value Calculations

Customer: Tampa Electric Company

Facility: Polk Power Station

Source: Unit 1

Sample ID: Polk GC

Analysis Date:

11/8/2006

CALCULATION OF DENSITY AND HEATING VALUE @ 60°F and 30 in Hg

Component	% Volume	Molecular Wt.	Density * (lb/ft ³)	% volume		Component		Gross * Heating Value (Btu/SCF)	Volume Fract. Btu
				x Density	weight %	Gross Btu/lb	Weight Fract. Btu		
Hydrogen	34.5874	2.016	0.0053	0.00183	3.1630	61100	1932.59	325.0	112.4089
Oxygen	0.8700	32.000	0.0846	0.00074	1.2700	0	0.00	0.0	0
Argon	0.0000	39.948	0.1065	0.00000	0.0000	0	0.00	0.0	0
Nitrogen	3.5208	28.016	0.0744	0.00262	4.5198	0	0.00	0.0	0
CO ₂	17.7000	44.010	0.1170	0.02071	35.7325	0	0.00	0.0	0
CO	43.3117	28.010	0.0740	0.03205	55.3020	4347	2403.98	322.0	139.4636
COS	0.0000	60.070	0.1602	0.00000	0.0000	0	0.00	0.0	0
Methane	0.0174	16.041	0.0424	0.00001	0.0127	23879	3.04	1013.0	0.176117
Ethane	0.000	30.067	0.0803	0.00000	0.0000	22320	0.00	1792.0	0
Ethylene	0.000	28.051	0.0746	0.00000	0.0000	21644	0.00	1614.0	0
Propane	0.000	44.092	0.1196	0.00000	0.0000	21661	0.00	2590.0	0
propylene	0.000	42.077	0.1110	0.00000	0.0000	21041	0.00	2336.0	0
Isobutane	0.000	58.118	0.1582	0.00000	0.0000	21257	0.00	3363.0	0
n-butane	0.000	58.118	0.1582	0.00000	0.0000	21308	0.00	3370.0	0
Isobutene	0.000	56.102	0.1480	0.00000	0.0000	20730	0.00	3068.0	0
Isopentane	0.000	72.144	0.1904	0.00000	0.0000	21052	0.00	4008.0	0
n-pentane		72.144	0.1904	0.00000	0.0000	21091	0.00	4016.0	0
n-hexane		86.169	0.2274	0.00000	0.0000	20940	0.00	4762.0	0
H ₂ S		34.076	0.0911	0.00000	0.0000	7100	0.00	647.0	0

Total: 100.01	Average Density	0.05796	100.0000
	Specific Gravity	0.75759	

Gross Heating Value			
Btu/lb	4340	Btu/SCF	252.05
Net Heating Values			
Btu/lb	4046	Btu/SCF	234

* Density (lb/ft³) and Gross Heating Value (Btu/scf) data from Perry's Chemical Engineering Handbook.
 Net Heating Value (Lower Heating Value), Btu/lb, calculated as Gross Heating Value (Higher Heating Value) - 10.30 (%H₂ x 8.94)



Coal Derived Gas and Heating Value Calculations

Customer: Tampa Electric Company

Facility: Polk Power Station

Source: Unit 1

Sample ID: Polk GC

Analysis Date:

11/8/2006

CALCULATION OF F FACTORS

Component	Mol. Wt.	C Factor	H Factor	% volume	Fract. Wt.	Weight Percents			
						Carbon	Hydrogen	Nitrogen	Oxygen
Hydrogen	2.016	0	1	34.587	69.7281	3.1859347			
Oxygen	32.000	0	0	0.870	27.8400				1.2720324
Argon	39.948	0	0	0.000	0.0000				
Nitrogen	28.016	0	0	3.521	98.6397			4.506927253	
CO2	44.010	0.272273	0	17.700	778.9770	9.69076727			25.875455
CO	28.010	0.42587	0	43.312	1213.1598	23.6060871			31.855773
COS	60.070	0.1998	0	0.000	0.0000	0			0
Methane	16.041	0.75	0.25	0.017	0.2789	0.00955684	0.0031856		
Ethane	30.067	0.8	0.2	0.000	0.0000	0	0		
Ethylene	28.051	0.85714	0.14286	0.000	0.0000	0	0		
Propane	44.092	0.81818	0.181818	0.000	0.0000	0	0		
Propene	42.077	0.85714	0.14286	0.000	0.0000	0	0		
Isobutane	58.118	0.82759	0.17247	0.000	0.0000	0	0		
n-butane	58.118	0.82759	0.17247	0.000	0.0000	0	0		
Isobutene	56.102	0.85714	0.14286	0.000	0.0000	0	0		
Isopentane	72.144	0.83333	0.16667	0.000	0.0000	0	0		
n-pentane	72.144	0.83333	0.16667	0.000	0.0000	0	0		
n-hexane	86.169	0.83721	0.16279	0.000	0.0000	0	0		
H2S	34.076	0	0.0586923	0.000	0.0000	0	0		
Totals				100.00724	2188.6234	33.3064112	3.19	4.506927253	59.003261

CALCULATED VALUES		
O2 F Factor (dry), Fd	8309	DSCF of Exhaust/MM Btu of Fuel Burned @ 0% excess air
O2 F Factor (wet), Fw	9727	SCF of Exhaust/MM Btu of Fuel Burned @ 0% excess air
Moisture F Factor	1418	SCF of Water/MM Btu of Fuel Burned @ 0% excess air
Combust. Moisture	14.58	volume % water in flue gas @ 0% excess air
CO2 F Factor, Fc	2464	DSCF of CO2/MM Btu of Fuel Burned @ 0% excess air
Carbon Dioxide	29.65	volume % CO2 in flue gas @ 0% O2
Predicted Fo Factor	0.70	EPA Method 3a Fo value

APPENDIX G
PLANT OPERATIONS DATA

IGCC

IGCC Operations Data

Plant Information Source: polk-1pisrv

Start Time: 11/8/2006 10:52

End Time: 11/8/2006 15:40

Time Interval: 1 Min

Tag Name:	1pwri900	1TSYFI100	1tmsti922m	1tsyai202
Tag Explanation:	Unit Load	Fuel Flow	Inlet Temp	Satuator
Tag Units:	Mwe	KCFH	oF	% H2O
Run Average:	175.462345	6830.97417	71.3324255	0.2352024
08-Nov-06 10:52:00	175.419449	6751.41211	68.596756	0.23703638
08-Nov-06 10:53:00	175.198822	6754.81348	68.673439	0.23702364
08-Nov-06 10:54:00	175.137482	6764.16357	68.590538	0.2370109
08-Nov-06 10:55:00	174.830521	6743.71777	68.4677505	0.23699817
08-Nov-06 10:56:00	175.241028	6747.67773	68.3449554	0.23698543
08-Nov-06 10:57:00	176.161041	6795.72314	68.2221603	0.23697269
08-Nov-06 10:58:00	176.127808	6786.35547	68.0993652	0.23695996
08-Nov-06 10:59:00	175.589996	6816.91846	68.1698837	0.23694722
08-Nov-06 11:00:00	175.22673	6782.37842	68.3232498	0.23693448
08-Nov-06 11:01:00	175.114899	6753.65479	68.4766159	0.23692176
08-Nov-06 11:02:00	175.102386	6728.50098	68.629982	0.23690902
08-Nov-06 11:03:00	175.332031	6727.41846	68.498848	0.23689628
08-Nov-06 11:04:00	175.210449	6750.8252	68.5604477	0.23688354
08-Nov-06 11:05:00	175.261108	6738.31689	68.4338303	0.23687081
08-Nov-06 11:06:00	175.522263	6747.66602	68.5364914	0.23685807
08-Nov-06 11:07:00	175.783432	6739.66309	68.6391525	0.23684533
08-Nov-06 11:08:00	175.627945	6753.71729	69.04039	0.2368326
08-Nov-06 11:09:00	176.477036	6914.79199	69.1173859	0.23681986
08-Nov-06 11:10:00	177.055038	6838.46826	69.1943817	0.23680712
08-Nov-06 11:11:00	176.220901	6788.00928	69.2713776	0.2367944
08-Nov-06 11:12:00	175.363174	6749.22803	69.4463196	0.23678166
08-Nov-06 11:13:00	174.654892	6764.62744	69.5049362	0.23676892
08-Nov-06 11:14:00	175.160675	6776.6792	69.555069	0.23675618
08-Nov-06 11:15:00	175.373383	6800.37549	69.6281357	0.23674345
08-Nov-06 11:16:00	175.73259	6807.49609	69.4210663	0.23673071
08-Nov-06 11:17:00	176.111374	6809.08398	69.433075	0.23671797
08-Nov-06 11:18:00	176.282471	6888.18311	69.0927963	0.23670524
08-Nov-06 11:19:00	176.678391	6911.16113	69.2739487	0.2366925
08-Nov-06 11:20:00	176.310654	6814.05957	69.1199493	0.23667976
08-Nov-06 11:21:00	176.861984	6781.33252	68.9659576	0.23666704
08-Nov-06 11:22:00	176.771927	6774.8335	68.8119659	0.2366543
08-Nov-06 11:23:00	176.853043	6772.14746	68.8119659	0.23664156
08-Nov-06 11:24:00	175.743271	6750.66992	69.2039032	0.23662883
08-Nov-06 11:25:00	175.967285	6761.54346	68.7002792	0.23661609

IGCC Operations Data

Tag Name:	1pwri900	1TSYFI100	1tmsti922m	1tsyai202
Tag Explanation:	Unit Load	Fuel Flow	Inlet Temp	Satuator
Tag Units:	Mwe	KCFH	°F	% H2O
08-Nov-06 11:26:00	175.26384	6790.63184	68.7769547	0.23660335
08-Nov-06 11:27:00	176.873993	6785.28809	68.8536377	0.23659061
08-Nov-06 11:28:00	175.079498	6796.24414	68.9303207	0.23657788
08-Nov-06 11:29:00	176.950409	6909.64551	69.0422974	0.23656514
08-Nov-06 11:30:00	175.216324	6822.74316	69.6281357	0.2365524
08-Nov-06 11:31:00	176.689087	6797.49756	69.607605	0.23653968
08-Nov-06 11:32:00	175.689865	6777.62354	69.3150101	0.23652694
08-Nov-06 11:33:00	176.522339	6788.771	69.6281357	0.2365142
08-Nov-06 11:34:00	176.935974	6795.62842	69.5169144	0.23650147
08-Nov-06 11:35:00	175.520187	6794.89941	69.7222366	0.23648873
08-Nov-06 11:36:00	175.602249	6780.875	69.9275665	0.23647599
08-Nov-06 11:37:00	175.518188	6760.63428	69.5569687	0.23646326
08-Nov-06 11:38:00	175.828445	6841.67383	69.4793396	0.23645052
08-Nov-06 11:39:00	175.443359	6879.06592	69.4017029	0.23643778
08-Nov-06 11:40:00	175.309433	6785.89844	69.3240662	0.23642504
08-Nov-06 11:41:00	175.408508	6768.66455	69.7153931	0.23641232
08-Nov-06 11:42:00	175.875183	6763.24512	69.8160858	0.23639958
08-Nov-06 11:43:00	176.487213	6796.18164	69.9167709	0.23638684
08-Nov-06 11:44:00	177.099243	6794.1123	70.0174561	0.23637411
08-Nov-06 11:45:00	176.921265	6807.01904	70.1181412	0.23636137
08-Nov-06 11:46:00	175.787476	6801.66211	70.2188263	0.23634863
08-Nov-06 11:47:00	175.049377	6785.26221	70.0296326	0.2363359
08-Nov-06 11:48:00	175.580765	6805.15088	70.046051	0.23632316
08-Nov-06 11:49:00	175.501709	6869.37305	70.1957703	0.23631042
08-Nov-06 11:50:00	175.419907	6845.18408	70.046051	0.2362977
08-Nov-06 11:51:00	175.607224	6762.14258	70.0997772	0.23628496
08-Nov-06 11:52:00	175.978729	6776.65527	70.3436508	0.23627222
08-Nov-06 11:53:00	176.1474	6738.46582	70.587532	0.23625948
08-Nov-06 11:54:00	175.878891	6810.89844	70.8314133	0.23624675
08-Nov-06 11:55:00	176.292236	6790.69775	71.0752869	0.23623401
08-Nov-06 11:56:00	175.74411	6791.25342	70.676857	0.23622127
08-Nov-06 11:57:00	175.556625	6744.38184	70.0885544	0.23620854
08-Nov-06 11:58:00	175.784637	6787.45947	70.0909653	0.2361958
08-Nov-06 11:59:00	176.909851	6903.38281	69.9520874	0.23618306
08-Nov-06 12:00:00	177.249359	6808.16797	69.6844559	0.23617034
08-Nov-06 12:01:00	177.019379	6792.5293	69.8051529	0.2361576
08-Nov-06 12:02:00	176.580261	6806.22461	69.9258423	0.23614486
08-Nov-06 12:03:00	176.715347	6807.75635	70.0465317	0.23613212
08-Nov-06 12:04:00	176.305573	6789.45313	70.1672211	0.23611939
08-Nov-06 12:05:00	175.638138	6793.02979	70.1391296	0.23610665

IGCC Operations Data

Tag Name:	1pwrij900	1TSYFI100	1tmsti922m	1tsyai202
Tag Explanation:	Unit Load	Fuel Flow	Inlet Temp	Satuator
Tag Units:	Mwe	KCFH	°F	% H2O
08-Nov-06 12:06:00	175.254501	6794.63428	69.9936523	0.23609391
08-Nov-06 12:07:00	175.219467	6776.48389	70.1433716	0.23608118
08-Nov-06 12:08:00	175.549133	6784.38281	70.027504	0.23606844
08-Nov-06 12:09:00	175.841812	6880.67871	70.2246399	0.2360557
08-Nov-06 12:10:00	176.150253	6864.76953	70.1503906	0.23604298
08-Nov-06 12:11:00	176.440674	6824.05371	70.0761414	0.23603024
08-Nov-06 12:12:00	176.260559	6806.52393	70.0018921	0.2360175
08-Nov-06 12:13:00	176.749115	6806.15723	69.9781723	0.23600477
08-Nov-06 12:14:00	176.477051	6799.30127	70.1795425	0.23599203
08-Nov-06 12:15:00	175.0383	6786.5166	70.3809128	0.23597929
08-Nov-06 12:16:00	176.623184	6811.07861	70.4867477	0.23596655
08-Nov-06 12:17:00	175.308395	6799.63037	70.2203064	0.23595382
08-Nov-06 12:18:00	176.46109	6858.94629	69.9665604	0.23594108
08-Nov-06 12:19:00	176.369614	6883.46191	70.2702713	0.23592834
08-Nov-06 12:20:00	176.25705	6797.73633	70.2456741	0.23591562
08-Nov-06 12:21:00	175.461334	6772.30371	70.5587921	0.23590288
08-Nov-06 12:22:00	175.386978	6776.6377	70.4022369	0.23589014
08-Nov-06 12:23:00	175.573608	6770.00439	70.2456741	0.23587741
08-Nov-06 12:24:00	176.670914	6816.47949	70.8567581	0.23586467
08-Nov-06 12:25:00	177.184357	6828.85498	70.5769043	0.23585193
08-Nov-06 12:26:00	176.645096	6832.70508	70.2663727	0.2358392
08-Nov-06 12:27:00	175.3013	6772.3335	70.6965637	0.23582646
08-Nov-06 12:28:00	175.402939	6778.42578	70.8468628	0.23581372
08-Nov-06 12:29:00	175.466476	6874.81836	70.7414474	0.23580098
08-Nov-06 12:30:00	175.684967	6872.59961	70.5848846	0.23578826
08-Nov-06 12:31:00	175.765396	6842.48291	70.0526123	0.23577552
08-Nov-06 12:32:00	176.629044	6815.90527	70.7012863	0.23576277
08-Nov-06 12:33:00	176.593018	6837.17236	71.123436	0.23575005
08-Nov-06 12:34:00	175.779526	6810.9165	70.8719101	0.23573731
08-Nov-06 12:35:00	174.577286	6779.09619	71.1850357	0.23572457
08-Nov-06 12:36:00	174.63147	6783.81396	70.8719101	0.23571184
08-Nov-06 12:37:00	175.41304	6795.84961	71.0721054	0.2356991
08-Nov-06 12:38:00	176.555832	6861.85449	70.9181061	0.23568636
08-Nov-06 12:39:00	176.619919	6923	71.0322876	0.23567364
08-Nov-06 12:40:00	176.548447	6836.49414	71.2613983	0.2356609
08-Nov-06 12:41:00	176.322205	6835.05811	71.4905167	0.23564816
08-Nov-06 12:42:00	176.45282	6835.82764	71.7196274	0.23563541
08-Nov-06 12:43:00	176.045563	6803.56641	71.6294632	0.23562269
08-Nov-06 12:44:00	175.246582	6786.68652	71.6785965	0.23560995
08-Nov-06 12:45:00	176.501663	6838.42627	71.7753372	0.23559721

IGCC Operations Data

Tag Name:	1pwrji900	1TSYFI100	1tmsti922m	1tsyai202
Tag Explanation:	Unit Load	Fuel Flow	Inlet Temp	Satuator
Tag Units:	Mwe	KCFH	°F	% H2O
08-Nov-06 12:46:00	177.422333	6854.28467	71.8112717	0.23558448
08-Nov-06 12:47:00	176.936554	6838.93945	71.659935	0.23557174
08-Nov-06 12:48:00	176.744781	6828.31689	71.5751495	0.235559
08-Nov-06 12:49:00	175.694122	6901.26318	71.7291412	0.23554628
08-Nov-06 12:50:00	175.52002	6853.75342	72.2004242	0.23553354
08-Nov-06 12:51:00	175.823456	6811.8042	72.3693924	0.23552079
08-Nov-06 12:52:00	177.430222	6838.38867	72.538353	0.23550805
08-Nov-06 12:53:00	176.646744	6844.0083	72.7073212	0.23549533
08-Nov-06 12:54:00	176.018616	6828.66309	72.6934586	0.23548259
08-Nov-06 12:55:00	175.57756	6835.64502	72.7755814	0.23546985
08-Nov-06 12:56:00	175.409256	6820.23047	72.6729202	0.23545712
08-Nov-06 12:57:00	175.501556	6798.24512	72.5702591	0.23544438
08-Nov-06 12:58:00	175.593872	6856.20801	72.9860458	0.23543164
08-Nov-06 12:59:00	175.686172	6877.90186	73.2707596	0.23541892
08-Nov-06 13:00:00	175.823807	6841.96094	72.8016739	0.23540618
08-Nov-06 13:01:00	175.681061	6796.67578	71.7636261	0.23539343
08-Nov-06 13:02:00	175.75386	6818.48096	71.5594177	0.23538071
08-Nov-06 13:03:00	176.781448	6836.1123	71.3552094	0.23536797
08-Nov-06 13:04:00	175.805359	6827.81641	71.210701	0.23535523
08-Nov-06 13:05:00	175.211426	6769.06885	71.3646927	0.23534249
08-Nov-06 13:06:00	175.436569	6821.58252	71.4570923	0.23532976
08-Nov-06 13:07:00	175.35939	6800.40674	71.1491013	0.23531702
08-Nov-06 13:08:00	175.282211	6814.06543	71.4459686	0.23530428
08-Nov-06 13:09:00	175.680267	6930.9751	71.1952209	0.23529156
08-Nov-06 13:10:00	176.368057	6919.36768	71.3479614	0.23527882
08-Nov-06 13:11:00	176.366623	6852.36523	71.5085907	0.23526607
08-Nov-06 13:12:00	175.331726	6820.79443	71.9678345	0.23525335
08-Nov-06 13:13:00	175.597702	6808.27441	71.9626999	0.23524061
08-Nov-06 13:14:00	175.497604	6859.75391	72.1166916	0.23522787
08-Nov-06 13:15:00	174.758469	6823.23047	71.9792862	0.23521514
08-Nov-06 13:16:00	174.403046	6823.57471	71.8265457	0.2352024
08-Nov-06 13:17:00	174.910995	6826.875	72.0884552	0.23518966
08-Nov-06 13:18:00	175.619232	6850.51807	71.8523331	0.23517692
08-Nov-06 13:19:00	176.078644	6907.59961	72.0954971	0.2351642
08-Nov-06 13:20:00	175.228241	6829.06543	72.4234467	0.23515145
08-Nov-06 13:21:00	174.521317	6823.90088	72.7513885	0.23513871
08-Nov-06 13:22:00	175.269363	6825.5376	72.7342911	0.23512599
08-Nov-06 13:23:00	174.748428	6806.82373	72.2463684	0.23511325
08-Nov-06 13:24:00	174.600052	6798.97656	72.648468	0.23510051
08-Nov-06 13:25:00	174.883881	6857.67822	71.9915009	0.23508778

IGCC Operations Data

Tag Name:	1pwrji900	1TSYFI100	1tmsti922m	1tsyai202
Tag Explanation:	Unit Load	Fuel Flow	Inlet Temp	Satuator
Tag Units:	Mwe	KCFH	°F	% H2O
08-Nov-06 13:26:00	175.120178	6854.92578	71.8112717	0.23507504
08-Nov-06 13:27:00	175.764343	6848.69238	72.2426682	0.2350623
08-Nov-06 13:28:00	175.865982	6833.30469	72.4116287	0.23504958
08-Nov-06 13:29:00	175.503311	6916.02441	72.5805969	0.23503684
08-Nov-06 13:30:00	175.19162	6842.59033	72.7495651	0.23502409
08-Nov-06 13:31:00	175.844666	6890.7749	73.195343	0.23501135
08-Nov-06 13:32:00	175.919418	6855.95264	73.1605682	0.23499863
08-Nov-06 13:33:00	175.082169	6799.6665	72.6985931	0.23498589
08-Nov-06 13:34:00	174.724686	6814.7207	72.4983978	0.23497315
08-Nov-06 13:35:00	175.346191	6874.146	72.1319275	0.23496042
08-Nov-06 13:36:00	175.209625	6852.43262	72.0847702	0.23494768
08-Nov-06 13:37:00	174.642288	6866.47021	72.0080872	0.23493494
08-Nov-06 13:38:00	174.192337	6835.70557	71.9314041	0.23492222
08-Nov-06 13:39:00	173.596298	6912.93506	71.8547211	0.23490947
08-Nov-06 13:40:00	174.450912	6844.5918	71.8785553	0.23489673
08-Nov-06 13:41:00	174.835037	6842.65039	72.0338211	0.23488399
08-Nov-06 13:42:00	175.553528	6855.92334	72.2324142	0.23487127
08-Nov-06 13:43:00	175.583054	6852.06396	71.8112717	0.23485853
08-Nov-06 13:44:00	174.785309	6845.18115	71.5338898	0.23484579
08-Nov-06 13:45:00	174.357117	6838.29834	71.635994	0.23483306
08-Nov-06 13:46:00	174.756851	6874.56152	71.7380981	0.23482032
08-Nov-06 13:47:00	176.080246	6865.3457	71.7225571	0.23480758
08-Nov-06 13:48:00	174.803314	6806.16357	71.5563278	0.23479486
08-Nov-06 13:49:00	174.035461	6909.20361	71.7616501	0.23478211
08-Nov-06 13:50:00	174.750824	6886.55078	71.9669724	0.23476937
08-Nov-06 13:51:00	175.486481	6867.69873	71.9829788	0.23475665
08-Nov-06 13:52:00	175.029663	6826.55127	71.5618362	0.23474391
08-Nov-06 13:53:00	175.884735	6852.82666	72.1243896	0.23473117
08-Nov-06 13:54:00	176.04306	6888.57813	72.4610519	0.23471843
08-Nov-06 13:55:00	175.904617	6884.97559	72.2369919	0.2347057
08-Nov-06 13:56:00	175.766174	6854.1499	72.0129318	0.23469296
08-Nov-06 13:57:00	174.813995	6820.41504	71.8788605	0.23468022
08-Nov-06 13:58:00	174.111115	6840.92871	72.4682388	0.23466749
08-Nov-06 13:59:00	175.573593	6931.92236	72.1427841	0.23465475
08-Nov-06 14:00:00	175.338409	6849.89063	72.4859314	0.23464201
08-Nov-06 14:01:00	175.477615	6847.04004	72.1472931	0.23462929
08-Nov-06 14:02:00	175.662231	6862.37061	72.4983978	0.23461655
08-Nov-06 14:03:00	175.286407	6819.94873	72.3757706	0.23460381
08-Nov-06 14:04:00	174.979691	6830.89404	72.2531433	0.23459108
08-Nov-06 14:05:00	175.19928	6818.84131	72.1305237	0.23457834

IGCC Operations Data

Tag Name:	1pwrij900	1TSYFI100	1tmsti922m	1tsyai202
Tag Explanation:	Unit Load	Fuel Flow	Inlet Temp	Satuator
Tag Units:	Mwe	KCFH	°F	% H2O
08-Nov-06 14:06:00	175.626129	6853.56299	71.8112717	0.2345656
08-Nov-06 14:07:00	175.323547	6818.77734	71.8112717	0.23455286
08-Nov-06 14:08:00	174.873276	6830.98975	71.8112717	0.23454013
08-Nov-06 14:09:00	175.214539	6903.99414	72.719902	0.23452739
08-Nov-06 14:10:00	175.413422	6883.63867	72.5861359	0.23451465
08-Nov-06 14:11:00	175.19458	6818.17773	72.6893616	0.23450193
08-Nov-06 14:12:00	175.788437	6828.67188	72.7925873	0.23448919
08-Nov-06 14:13:00	175.32045	6839.16602	72.2684631	0.23447645
08-Nov-06 14:14:00	174.476151	6849.66016	72.1243896	0.23446372
08-Nov-06 14:15:00	174.51297	6867.80908	72.1243896	0.23445098
08-Nov-06 14:16:00	175.223083	6883.88037	72.1243896	0.23443824
08-Nov-06 14:17:00	174.776596	6848.65137	71.8664551	0.23442551
08-Nov-06 14:18:00	173.935059	6871.89795	71.9434509	0.23441277
08-Nov-06 14:19:00	175.191467	6932.68701	72.0204468	0.23440003
08-Nov-06 14:20:00	175.320694	6866.50537	72.0974426	0.23438729
08-Nov-06 14:21:00	175.149597	6841.87793	71.8112717	0.23437457
08-Nov-06 14:22:00	174.508652	6856.83838	72.4179764	0.23436183
08-Nov-06 14:23:00	174.469986	6831.96094	72.608757	0.23434909
08-Nov-06 14:24:00	174.919205	6852.12109	72.2708282	0.23433636
08-Nov-06 14:25:00	175.948822	6875.77197	72.5830917	0.23432362
08-Nov-06 14:26:00	175.381714	6874.99219	72.7370834	0.23431088
08-Nov-06 14:27:00	175.143066	6830.00342	72.4679565	0.23429815
08-Nov-06 14:28:00	174.641235	6818.66748	72.4564972	0.23428541
08-Nov-06 14:29:00	174.139938	6902.58936	72.7746048	0.23427267
08-Nov-06 14:30:00	174.617218	6900.9585	72.6982346	0.23425995
08-Nov-06 14:31:00	174.924164	6853.27002	72.6218643	0.23424721
08-Nov-06 14:32:00	176.180603	6834.93604	72.5454941	0.23423447
08-Nov-06 14:33:00	174.372574	6821.35449	72.527916	0.23422173
08-Nov-06 14:34:00	174.288284	6836.21191	72.6049118	0.234209
08-Nov-06 14:35:00	175.605865	6837.03809	72.6819077	0.23419626
08-Nov-06 14:36:00	175.353714	6859.03906	72.7589035	0.23418352
08-Nov-06 14:37:00	174.901932	6826.22119	72.54422	0.23417079
08-Nov-06 14:38:00	173.774048	6814.87842	72.6969604	0.23415805
08-Nov-06 14:39:00	174.470764	6961.29004	72.6875153	0.23414531
08-Nov-06 14:40:00	175.059082	6872.36182	72.1915283	0.23413259
08-Nov-06 14:41:00	174.739212	6852.19385	72.1642456	0.23411985
08-Nov-06 14:42:00	175.885498	6853.47754	72.3481827	0.23410711
08-Nov-06 14:43:00	175.031509	6849.26074	72.6095047	0.23409437
08-Nov-06 14:44:00	174.977814	6842.80713	73.1013412	0.23408164
08-Nov-06 14:45:00	174.369461	6839.36035	72.9460754	0.2340689

IGCC Operations Data

Tag Name:	1pwrij900	1TSYFI100	1tmsti922m	1tsyai202
Tag Explanation:	Unit Load	Fuel Flow	Inlet Temp	Satuator
Tag Units:	Mwe	KCFH	°F	% H2O
08-Nov-06 14:46:00	173.761108	6838.48047	72.4983978	0.23405616
08-Nov-06 14:47:00	174.083542	6841.4873	72.4983978	0.23404343
08-Nov-06 14:48:00	174.405975	6847.86768	72.5394592	0.23403069
08-Nov-06 14:49:00	174.728394	6941.64746	73.1169357	0.23401795
08-Nov-06 14:50:00	175.245941	6932.20996	72.962944	0.23400523
08-Nov-06 14:51:00	175.777405	6847.07324	72.4922638	0.23399249
08-Nov-06 14:52:00	174.682907	6830.5874	72.1243896	0.23397975
08-Nov-06 14:53:00	173.81012	6833.40088	72.4863358	0.23396702
08-Nov-06 14:54:00	174.392075	6792.60889	72.1368561	0.23395428
08-Nov-06 14:55:00	174.710266	6813.50928	72.6448593	0.23394154
08-Nov-06 14:56:00	174.207214	6832.85791	72.7963638	0.2339288
08-Nov-06 14:57:00	174.672852	6808.25391	72.5343323	0.23391607
08-Nov-06 14:58:00	174.770905	6819.16846	72.7749863	0.23390333
08-Nov-06 14:59:00	174.026459	6889.37061	72.3031464	0.23389059
08-Nov-06 15:00:00	175.260849	6865.41895	72.077858	0.23387787
08-Nov-06 15:01:00	175.63707	6834.55664	71.8525772	0.23386513
08-Nov-06 15:02:00	175.373367	6812.00586	71.8112717	0.23385239
08-Nov-06 15:03:00	174.629105	6799.979	72.3162766	0.23383966
08-Nov-06 15:04:00	174.580292	6814.3042	72.5612335	0.23382692
08-Nov-06 15:05:00	174.507202	6816.14893	72.8061905	0.23381418
08-Nov-06 15:06:00	174.80484	6828.50537	73.0511475	0.23380145
08-Nov-06 15:07:00	174.751709	6839.63428	73.0168381	0.23378871
08-Nov-06 15:08:00	175.878128	6870.05176	72.8628464	0.23377597
08-Nov-06 15:09:00	175.650192	6962.90674	72.6006393	0.23376323
08-Nov-06 15:10:00	175.768417	6937.00293	72.7540054	0.23375051
08-Nov-06 15:11:00	175.006256	6847.94775	72.9073715	0.23373777
08-Nov-06 15:12:00	175.162994	6828.9834	73.06073	0.23372503
08-Nov-06 15:13:00	175.661331	6857.58447	72.947876	0.2337123
08-Nov-06 15:14:00	175.602112	6882.72021	72.9809113	0.23369956
08-Nov-06 15:15:00	175.40274	6881.62012	72.9603729	0.23368682
08-Nov-06 15:16:00	175.305649	6875.729	72.8062057	0.23367409
08-Nov-06 15:17:00	175.82431	6836.64111	72.1804047	0.23366135
08-Nov-06 15:18:00	175.498276	6841.5083	72.2924347	0.23364861
08-Nov-06 15:19:00	175.476044	6957.87109	72.4044647	0.23363589
08-Nov-06 15:20:00	175.354172	6844.21777	72.5165024	0.23362315
08-Nov-06 15:21:00	174.393051	6812.51953	72.6285324	0.23361041
08-Nov-06 15:22:00	175.169388	6829.45996	72.7405624	0.23359767
08-Nov-06 15:23:00	175.653641	6829.34766	72.7738724	0.23358494
08-Nov-06 15:24:00	175.334671	6821.69727	72.6712112	0.2335722
08-Nov-06 15:25:00	174.856049	6815.96631	72.5685501	0.23355946

IGCC Operations Data

Tag Name:	1pwrji900	1TSYFI100	1tmsti922m	1tsyai202
Tag Explanation:	Unit Load	Fuel Flow	Inlet Temp	Satuator
Tag Units:	Mwe	KCFH	°F	% H2O
08-Nov-06 15:26:00	173.714417	6849.1875	72.2878265	0.23354673
08-Nov-06 15:27:00	173.777344	6792.68213	71.8552628	0.23353399
08-Nov-06 15:28:00	174.531998	6837.45361	72.0105286	0.23352125
08-Nov-06 15:29:00	174.274689	6900.5083	71.8950653	0.23350853
08-Nov-06 15:30:00	174.423965	6887.8501	72.2302475	0.23349579
08-Nov-06 15:31:00	174.920807	6798.6958	72.3632278	0.23348305
08-Nov-06 15:32:00	174.9189	6830.0835	71.9331818	0.23347031
08-Nov-06 15:33:00	174.893387	6854.28418	72.4983978	0.23345758
08-Nov-06 15:34:00	175.337067	6870.48535	72.7704544	0.23344484
08-Nov-06 15:35:00	174.859772	6869.85938	72.5343323	0.2334321
08-Nov-06 15:36:00	175.143585	6853.23291	72.8038483	0.23341937
08-Nov-06 15:37:00	175.113068	6855.7998	72.7271652	0.23340663
08-Nov-06 15:38:00	175.84552	6863.30029	72.6504822	0.23339389
08-Nov-06 15:39:00	175.543991	6920.06641	72.5737991	0.23338117
08-Nov-06 15:40:00	173.95488	6835.84424	72.1243896	0.23336843

SULFURIC ACID PLANT

Ops Run 1

Polk Power Station

Acid Plant

Run No. 1

Start	Nov-08-2006 10:30:00 AM
End	Nov-08-2006 11:30:00 AM
Interval	1m

PI TAG	1SRGAI455	1SRGFI487	1SRGAI446b
PI DESCRIPTOR	SA MAIN CPRSR	SA PROD CLR ACID	SA FINAL TOWER
	OUT SO2 A	OUT FLOW	ACID CONC
UNITS	AVG. %	TOTAL GAL.	AVG. %
	7.518002924	1336.161551	93.49098406
08-Nov-06 10:30:00	7.605492592	25.6197052	93.50383759
08-Nov-06 10:31:00	7.637002468	25.59354973	93.49713898
08-Nov-06 10:32:00	7.598116875	25.56739235	93.49044800
08-Nov-06 10:33:00	7.540894985	25.54831696	93.48375702
08-Nov-06 10:34:00	7.521108627	25.53160095	93.47706604
08-Nov-06 10:35:00	7.512715816	25.51488495	93.47036743
08-Nov-06 10:36:00	7.504323483	25.49816895	93.46367645
08-Nov-06 10:37:00	7.473702908	25.48145294	93.45698547
08-Nov-06 10:38:00	7.436317921	25.46473694	93.46114349
08-Nov-06 10:39:00	7.442218304	25.44802094	93.47032166
08-Nov-06 10:40:00	7.501068115	25.36372566	93.47950745
08-Nov-06 10:41:00	7.515430927	25.25886536	93.48246765
08-Nov-06 10:42:00	7.512569904	24.93150902	93.48255157
08-Nov-06 10:43:00	7.509708405	24.8008709	93.48263550
08-Nov-06 10:44:00	7.506847382	24.67023277	93.48271179
08-Nov-06 10:45:00	7.530162334	24.53959465	93.48279572
08-Nov-06 10:46:00	7.52693224	24.40895653	93.48287964
08-Nov-06 10:47:00	7.513199329	24.27831841	93.48295593
08-Nov-06 10:48:00	7.499465942	24.10673714	93.48303986
08-Nov-06 10:49:00	7.485732555	23.92150688	93.48311615
08-Nov-06 10:50:00	7.500134945	23.83758163	93.48320007
08-Nov-06 10:51:00	7.523100376	23.79049683	93.48328400
08-Nov-06 10:52:00	7.546065807	23.70576668	93.48336029
08-Nov-06 10:53:00	7.569031239	23.60848808	93.48344421
08-Nov-06 10:54:00	7.59199667	23.5112114	93.48352814
08-Nov-06 10:55:00	7.576368332	23.4139328	93.48360443
08-Nov-06 10:56:00	7.550065041	23.31665611	93.48368835
08-Nov-06 10:57:00	7.523761749	23.21937752	93.48377228
08-Nov-06 10:58:00	7.5252285	23.07248878	93.48384857
08-Nov-06 10:59:00	7.53514719	22.90906334	93.48393250
08-Nov-06 11:00:00	7.545065403	22.74563599	93.48401642
08-Nov-06 11:01:00	7.554984093	22.58221054	93.48409271
08-Nov-06 11:02:00	7.564902782	22.41781044	93.48417664
08-Nov-06 11:03:00	7.561221123	22.25308609	93.48426056
08-Nov-06 11:04:00	7.553400993	22.08836365	93.48523712
08-Nov-06 11:05:00	7.545580387	21.9236393	93.48664093
08-Nov-06 11:06:00	7.537760258	21.75891495	93.48804474
08-Nov-06 11:07:00	7.545294285	21.5941925	93.48944092
08-Nov-06 11:08:00	7.557501793	21.24074936	93.49084473
08-Nov-06 11:09:00	7.569709301	20.97080231	93.49224091
08-Nov-06 11:10:00	7.559048176	20.74965858	93.49364471
08-Nov-06 11:11:00	7.541426182	20.52851295	93.49504852
08-Nov-06 11:12:00	7.523804665	20.30736923	93.49644470
08-Nov-06 11:13:00	7.506183147	20.0862236	93.49784851
08-Nov-06 11:14:00	7.536742687	19.86507988	93.49924469
08-Nov-06 11:15:00	7.580628872	19.58058301	93.50064850
08-Nov-06 11:16:00	7.580339909	19.28546715	93.50205231
08-Nov-06 11:17:00	7.528293133	18.98585129	93.50344849

Ops Run 1

08-Nov-06 11:18:00	7.464585781	18.77232742	93.50485229
08-Nov-06 11:19:00	7.400878429	18.58749962	93.50624847
08-Nov-06 11:20:00	7.337171078	18.36473274	93.50765228
08-Nov-06 11:21:00	7.327863216	18.12932014	93.50905609
08-Nov-06 11:22:00	7.335111141	17.74920845	93.51045227
08-Nov-06 11:23:00	7.403661728	17.32086563	93.51185608
08-Nov-06 11:24:00	7.490869522	16.97904205	93.51325226
08-Nov-06 11:25:00	7.578077316	16.6686821	93.51465607
08-Nov-06 11:26:00	7.619310856	16.35832214	93.51605988
08-Nov-06 11:27:00	7.574987411	16.04796219	93.51745605
08-Nov-06 11:28:00	7.508494377	15.73760223	93.51885986
08-Nov-06 11:29:00	7.442001343	15.42724228	93.51600647
08-Nov-06 11:30:00	7.409368038	15.11688232	93.51117706

Ops Run 2

Polk Power Station

Acid Plant

Run No. 2

Start	Nov-08-2006 12:30:00 PM
End	Nov-08-2006 1:30:00 PM
Interval	1m

PI TAG	1SRGAI455	1SRGFI487	1SRGAI446b
PI DESCRIPTOR	SA MAIN CPRSR OUT SO2 A	SA PROD CLR ACID OUT FLOW	SA FINAL TOWER ACID CONC
	Inlet Converter	Product Acid Flow	Acid Concentration
UNITS	AVG. %	TOTAL GAL.	AVG. %
Average	7.346494778	1495.005686	93.49105822
08-Nov-06 12:30:00	7.47407198	21.13378716	93.4407959
08-Nov-06 12:31:00	7.475979328	21.40785599	93.45956421
08-Nov-06 12:32:00	1.793878078	21.68192482	93.47834015
08-Nov-06 12:33:00	6.710124016	21.95599365	93.48512268
08-Nov-06 12:34:00	7.328524113	22.23006248	93.48634338
08-Nov-06 12:35:00	7.441480637	22.42717171	93.48757172
08-Nov-06 12:36:00	7.479857922	22.78603172	93.48880005
08-Nov-06 12:37:00	7.487487316	23.12661362	93.49002075
08-Nov-06 12:38:00	7.495117188	23.36897469	93.49124908
08-Nov-06 12:39:00	7.502746582	23.61133385	93.49247742
08-Nov-06 12:40:00	7.515450001	23.85369492	93.49369812
08-Nov-06 12:41:00	7.537575722	24.09605598	93.49492645
08-Nov-06 12:42:00	7.545882702	24.33841515	93.49614716
08-Nov-06 12:43:00	7.528525352	24.58077621	93.49737549
08-Nov-06 12:44:00	7.511168003	24.82005119	93.49860382
08-Nov-06 12:45:00	7.493810654	25.05740929	93.49982452
08-Nov-06 12:46:00	7.464636803	25.29476738	93.50105286
08-Nov-06 12:47:00	7.433546066	25.39313698	93.50228119
08-Nov-06 12:48:00	7.420156002	25.40510941	93.50350189
08-Nov-06 12:49:00	7.403500557	25.41708183	93.50473022
08-Nov-06 12:50:00	7.448013306	25.42905426	93.50595093
08-Nov-06 12:51:00	7.492526531	25.44102859	93.50717926
08-Nov-06 12:52:00	7.518706799	25.45300102	93.50840759
08-Nov-06 12:53:00	7.508221626	25.46497345	93.5096283
08-Nov-06 12:54:00	7.497735977	25.47694588	93.51085663
08-Nov-06 12:55:00	7.482375622	25.4889183	93.51208496
08-Nov-06 12:56:00	7.457960606	25.50089073	93.51330566
08-Nov-06 12:57:00	7.433546066	25.51286316	93.51264954
08-Nov-06 12:58:00	7.425086498	25.52483749	93.51111603
08-Nov-06 12:59:00	7.446259022	25.53680992	93.50957489
08-Nov-06 13:00:00	7.467431068	25.53240013	93.50804138
08-Nov-06 13:01:00	7.488603115	25.51780891	93.50650787
08-Nov-06 13:02:00	7.491015911	25.5032177	93.50497437
08-Nov-06 13:03:00	7.458590031	25.48862648	93.50344086
08-Nov-06 13:04:00	7.42616415	25.47403336	93.50190735
08-Nov-06 13:05:00	7.39373827	25.45944214	93.50037384
08-Nov-06 13:06:00	7.379070282	25.44485092	93.49884033
08-Nov-06 13:07:00	7.397381306	25.4302597	93.49730682
08-Nov-06 13:08:00	7.415692329	25.50864792	93.49577332
08-Nov-06 13:09:00	7.436317921	25.49943733	93.49423981
08-Nov-06 13:10:00	7.461241245	25.39984131	93.4927063
08-Nov-06 13:11:00	7.486165047	25.30024719	93.49117279
08-Nov-06 13:12:00	7.493916512	25.20065117	93.48963928
08-Nov-06 13:13:00	7.469777107	25.10105515	93.48809814
08-Nov-06 13:14:00	7.445637703	25.00146103	93.48656464
08-Nov-06 13:15:00	7.421498299	24.88484192	93.48503113
08-Nov-06 13:16:00	7.397358894	24.75687599	93.48349762
08-Nov-06 13:17:00	7.37321949	24.62890816	93.48196411
08-Nov-06 13:18:00	7.349080086	24.50094032	93.4804306
08-Nov-06 13:19:00	7.34023571	24.4967308	93.47889709

Ops Run 2

08-Nov-06 13:20:00	7.361979961	24.42976379	93.47736359
08-Nov-06 13:21:00	7.390968323	24.26967239	93.47583008
08-Nov-06 13:22:00	7.434444427	24.10958099	93.47429657
08-Nov-06 13:23:00	7.477920532	24.08027649	93.47276306
08-Nov-06 13:24:00	7.494877815	24.11157799	93.47122955
08-Nov-06 13:25:00	7.462586403	24.14288139	93.47059631
08-Nov-06 13:26:00	7.430294991	24.022892	93.47039032
08-Nov-06 13:27:00	7.398004055	23.8380661	93.47018433
08-Nov-06 13:28:00	7.389811993	23.74243927	93.46997833
08-Nov-06 13:29:00	7.429819584	23.68504143	93.46977234
08-Nov-06 13:30:00	7.458387852	23.62764549	93.46955872

Ops Run 3

Polk Power Station

Acid Plant

Run No. 3

Start	Nov-08-2006 2:28:00 PM
End	Nov-08-2006 3:28:00 PM
Interval	1m

PI TAG	1SRGAI455	1SRGFI487	1SRGAI446b
PI DESCRIPTOR	SA MAIN CPRSR OUT SO2 A	SA PROD CLR ACID OUT FLOW	SA FINAL TOWER ACID CONC
	Inlet Converter	Product Acid Flow	Acid Concentration
UNITS	AVG. %	TOTAL GAL.	AVG. %
Average	7.386016818	1236.200362	93.49529792
08-Nov-06 14:28:00	7.311319351	14.36829185	93.48178864
08-Nov-06 14:29:00	7.338786125	14.54987717	93.49221802
08-Nov-06 14:30:00	7.375865936	14.82541084	93.49221802
08-Nov-06 14:31:00	7.430799484	15.14448261	93.49221802
08-Nov-06 14:32:00	7.455379486	15.28233719	93.49221802
08-Nov-06 14:33:00	7.42358923	15.33621407	93.49221802
08-Nov-06 14:34:00	7.39179945	15.39009094	93.49221802
08-Nov-06 14:35:00	7.374711037	15.58899403	93.49350739
08-Nov-06 14:36:00	7.384925842	15.86598873	93.49533844
08-Nov-06 14:37:00	7.386791229	16.05274963	93.49717712
08-Nov-06 14:38:00	7.371958256	16.19769287	93.49901581
08-Nov-06 14:39:00	7.357125282	16.34263611	93.50085449
08-Nov-06 14:40:00	7.353678703	16.48758125	93.50268555
08-Nov-06 14:41:00	7.371379852	16.828619	93.50452423
08-Nov-06 14:42:00	7.389080524	17.00793457	93.50636292
08-Nov-06 14:43:00	7.406781197	17.07019234	93.5082016
08-Nov-06 14:44:00	7.424481869	17.19862747	93.51003265
08-Nov-06 14:45:00	7.43140316	17.35773087	93.51187134
08-Nov-06 14:46:00	7.418305874	17.51683426	93.51371002
08-Nov-06 14:47:00	7.405208111	17.67593765	93.51554871
08-Nov-06 14:48:00	7.392110825	17.83503914	93.51737976
08-Nov-06 14:49:00	7.379013062	17.99414253	93.51921844
08-Nov-06 14:50:00	7.365915775	18.15324593	93.52105713
08-Nov-06 14:51:00	7.357047081	18.31234932	93.51696014
08-Nov-06 14:52:00	7.356032848	18.47145271	93.51012421
08-Nov-06 14:53:00	7.355018139	18.73720741	93.50328827
08-Nov-06 14:54:00	7.354003906	19.05238724	93.4964447
08-Nov-06 14:55:00	7.352989197	19.27627754	93.48960876
08-Nov-06 14:56:00	7.351974487	19.45786285	93.4827652
08-Nov-06 14:57:00	7.331125259	19.63944817	93.47592926
08-Nov-06 14:58:00	7.30327034	19.88972282	93.46908569
08-Nov-06 14:59:00	7.33607769	20.17182922	93.46224976
08-Nov-06 15:00:00	7.373157501	20.44595718	93.45541382
08-Nov-06 15:01:00	7.418172359	20.7163887	93.44857025
08-Nov-06 15:02:00	7.450769901	20.98682213	93.44173431
08-Nov-06 15:03:00	7.460307121	21.25725365	93.44180298
08-Nov-06 15:04:00	7.463168144	21.52768517	93.44532013
08-Nov-06 15:05:00	7.453630924	21.79811859	93.44884491
08-Nov-06 15:06:00	7.442625523	22.06856011	93.45236206
08-Nov-06 15:07:00	7.428892136	22.33898354	93.45588684
08-Nov-06 15:08:00	7.415158749	22.63600349	93.45941162
08-Nov-06 15:09:00	7.385670185	22.94534683	93.46292877
08-Nov-06 15:10:00	7.349240303	23.10009003	93.46645355
08-Nov-06 15:11:00	7.354259014	23.35926437	93.4699707
08-Nov-06 15:12:00	7.359277725	23.69389915	93.47349548
08-Nov-06 15:13:00	7.364296913	23.94628334	93.47702026
08-Nov-06 15:14:00	7.369315624	24.16341782	93.48053741
08-Nov-06 15:15:00	7.378256798	24.38055038	93.48406219
08-Nov-06 15:16:00	7.395041943	24.59768486	93.48757935
08-Nov-06 15:17:00	7.40623188	24.99505997	93.49110413
08-Nov-06 15:18:00	7.40623188	24.97980309	93.49908447

Ops Run 3

08-Nov-06 15:19:00	7.40623188	25.29338646	93.50913239
08-Nov-06 15:20:00	7.40623188	25.29894638	93.5191803
08-Nov-06 15:21:00	7.395149708	25.30450439	93.52922821
08-Nov-06 15:22:00	7.363486767	25.31006241	93.53927612
08-Nov-06 15:23:00	7.352074146	25.31562233	93.54932404
08-Nov-06 15:24:00	7.378269196	25.32118034	93.55937195
08-Nov-06 15:25:00	7.404464245	25.32673836	93.55942535
08-Nov-06 15:26:00	7.42162466	25.33229828	93.55448151
08-Nov-06 15:27:00	7.42200613	25.33785629	93.54953766
08-Nov-06 15:28:00	7.407834053	25.34341621	93.54459381

APPENDIX H

VISIBLE EMISSIONS OBSERVATIONS

IGCC

VISIBLE EMISSION OBSERVATION

E-496 R 1085

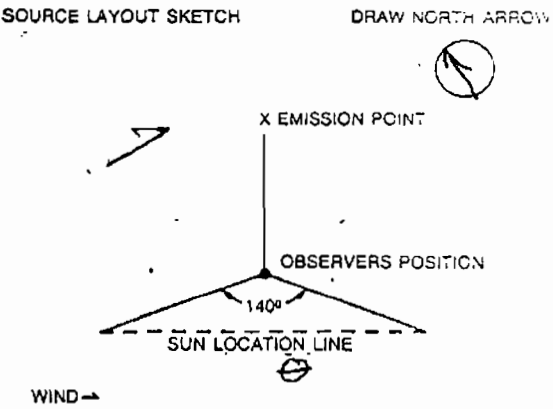
SOURCE NAME <i>Polk Power Station Unit 1</i>		SOURCE LOCATION <i>Polk County, FL</i>		OBSERVATION DATE <i>11/8/2006</i>		START TIME <i>13:15</i>		STOP TIME <i>13:45</i>			
TYPE OF FACILITY <i>Combined Cycle Combustion Turbine - firing ^{syn gas} oil</i>		SEC.				SEC.					
DISTANCE FROM OBSERVER <i>~920'</i>		MIN	0	15	30	45	MIN	0	15	30	45
SKY CONDITIONS/PLUME BACKGROUND <i>scattered / blue & white</i>		1	∅	∅	∅	∅	31				
SOURCE LAYOUT SKETCH DRAW NORTH ARROW 		2	∅	∅	∅	∅	32				
		3	∅	∅	∅	∅	33				
AVERAGE OPACITY <i>∅</i>		4	∅	∅	∅	∅	34				
		5	∅	∅	∅	∅	35				
WIND SPEED (EST.) <i>fresh ~20-25 mph</i>		6	∅	∅	∅	∅	36				
WIND DIRECTION (EST.) <i>WNW</i>		7	∅	∅	∅	∅	37				
OBSERVER'S NAME (PRINT) <i>Ray M Darby</i>		8	∅	∅	∅	∅	38				
OBSERVER'S SIGNATURE <i>Ray M Darby</i>		9	∅	∅	∅	∅	39				
DATE <i>8 NOV 2006</i>		10	∅	∅	∅	∅	40				
COMMENTS <i>SA ~ 11</i>		11	∅	∅	∅	∅	41				
<i>baseline petcoke ~ 48%</i>		12	∅	∅	∅	∅	42				
		13	∅	∅	∅	∅	43				
COPY OF VISIBLE EMISSIONS CERTIFICATION CARD		14	∅	∅	∅	∅	44				
<i>recertified 8/15/2006 ETA Tampa</i>		15	∅	∅	∅	∅	45				
EASTERN TECHNICAL ASSOCIATES		16	∅	∅	∅	∅	46				
RAY MGDARBY		17	∅	∅	∅	∅	47				
met the specifications of Federal Reference Method 2 and qualifies as a visible emissions evaluator. Maximum deviation on white and black smoke did not exceed 7.5% opacity and no single error exceeding 1.5% opacity was incurred during the certification test conducted by Eastern Technical Associates of Raleigh, NC. This certificate is valid for six months from date of issue and expires on the date below.		18	∅	∅	∅	∅	48				
2/14/06	8/15/06	19	∅	∅	∅	∅	49				
DATE OF SCHOOL	EXPIRATION DATE	20	∅	∅	∅	∅	50				
		21	∅	∅	∅	∅	51				
		22	∅	∅	∅	∅	52				
		23	∅	∅	∅	∅	53				
		24	∅	∅	∅	∅	54				
		25	∅	∅	∅	∅	55				
		26	∅	∅	∅	∅	56				
		27	∅	∅	∅	∅	57				
		28	∅	∅	∅	∅	58				
		29	∅	∅	∅	∅	59				
		30	∅	∅	∅	∅	60				

recertified 8/15/2006 ETA Tampa

EASTERN TECHNICAL ASSOCIATES
RAY MGDARBY

met the specifications of Federal Reference Method 2 and qualifies as a visible emissions evaluator. Maximum deviation on white and black smoke did not exceed 7.5% opacity and no single error exceeding 1.5% opacity was incurred during the certification test conducted by Eastern Technical Associates of Raleigh, NC. This certificate is valid for six months from date of issue and expires on the date below.

2/14/06 8/15/06 TMPE04
DATE OF SCHOOL EXPIRATION DATE LAST LECTURE

337141 Michael M. Sampel R.M. Darby
CERT. NUMBER DRAWING MANAGER BEARER

SULFURIC ACID PLANT

APPENDIX I
CHAIN OF CUSTODY



ANALYSIS REQUEST & CHAIN OF CUSTODY

ENVIRONMENTAL SERVICES

5012 CAUSEWAY BLVD., TAMPA, FL, 33619 PHONE: (813) 228-4111

PROJECT REFERENCE ACID PLANT		PROJECT NO.	PROJECT LOCATION (STATE) FLORIDA		REQUIRED ANALYSIS				DUE DATE 11-14-06	
SAMPLER'S PRINTED NAME JORGE A VARELA		SAMPLER'S SIGNATURE <i>[Signature]</i>			EM8					<input type="checkbox"/> EMAIL RESULTS
P.O. NUMBER	CONTRACT NO.		SITE							<input type="checkbox"/> FAX RESULTS
CLIENT NAME		CLIENT PHONE		CLIENT FAX					<input type="checkbox"/> MAIL RESULTS	
CLIENT EMAIL		CLIENT ADDRESS			PRESERVATIVE				NUMBER OF COOLERS SUBMITTED PER SHIPMENT	
SAMPLE ID	SAMPLE DESCRIPTION	SAMPLING		MATRIX	NUMBER OF CONTAINERS SUBMITTED				REMARKS	
		DATE	TIME							
RUN 1	ESKIMO CATCH	11/8/06		A	1					
RUN 2				A	1					
RUN 3				A	1					
BLANK				A	1					
RUN 1	3% H2O2 + DI			A	1					
RUN 2				A	1					
RUN 3				A	1					
BLANK				A	1					
BLANK	FILTER			A	1					

GW - GROUND WATER
 SW - SURFACE WATER
 DW - DRINKING WATER
 WW - WASTE WATER
 C - COAL
 O - OIL
 SO - SOLIDS/SOIL
 SL - SLUDGE
 W - WASTE SAMPLE
 A - AIR

CONTAINERS/SEALS INTACT <input type="checkbox"/> Yes <input type="checkbox"/> No	ON ICE/4°C <input checked="" type="checkbox"/> Yes <input type="checkbox"/> No
---	---

SAMPLE TRANSFERS

PERSON'S NAME:	RECEIVED BY:	DATE	TIME
<i>[Signature]</i>	<i>[Signature]</i>	11/9/06	8:30
FACILITY NAME: CSWY	FACILITY NAME:		
PERSON'S NAME:	PERSON'S NAME:		
FACILITY NAME:	FACILITY NAME:		
PERSON'S NAME:	PERSON'S NAME:		
FACILITY NAME:	FACILITY NAME:		
PERSON'S NAME:	PERSON'S NAME:		
FACILITY NAME:	FACILITY NAME:		

APPENDIX J
PROJECT PARTICIPANTS

TEST PARTICIPANTS

ENVIRONMENTAL SERVICES, AIR SERVICES GROUP

Test Team

Charles Dufeny	Environmental Technician, Test Team Lead
Jorge Varino	Environmental Technician
Raymond A. McDarby	Senior Environmental Technician
David A. Smith	Coordinator, Air Services Group

TRIGON ENGINEERING CONSULTANTS, INC

Test Team

Quentin Best	Team Lead
Jamie Bell	Technician
Larry Reynolds	Technician
Ian DeVivi	Technician

Process Data

Raymond A. McDarby	Senior Environmental Technician
--------------------	---------------------------------

Fuel Analysis

Raymond A. McDarby	Senior Environmental Technician
Bret Nicholas	Senior Environmental Technician

Report Preparation

Raymond A. McDarby	Senior Environmental Technician
--------------------	---------------------------------

Quality Assurance/Quality Control Review

Raymond A. McDarby	Senior Environmental Technician
--------------------	---------------------------------

Test Coordination

David A. Smith	Coordinator, Air Services Group
Michael Perkins	Environmental Coordinator – PPS
Paul Jenkins	Program Manager – Trigon Engineering Consultants, Inc.