

RECEIVED

JUL 03 2003

BUREAU OF AIR REGULATION

**TITLE V PERMIT APPLICATION
FLORIDA POWER & LIGHT COMPANY
RIVIERA PLANT
RIVIERA BEACH, FLORIDA**

**Prepared For:
Florida Power & Light Company
700 Universe Boulevard
Juno Beach, Florida 33408**

**Prepared By:
Golder Associates Inc.
6241 NW 23rd Street, Suite 500
Gainesville, Florida 32653-1500**

**July 2003
0237560**

DISTRIBUTION:

**4 Copies - FDEP Bureau of Air Regulation
1 Copy - Florida Power & Light Company
1 Copy - Florida Power & Light Riviera Plant
1 Copy - Golder Associates Inc.**

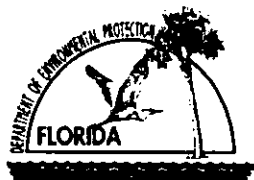

Department of Environmental Protection

Division of Air Resources Management

APPLICATION FOR AIR PERMIT - TITLE V SOURCE

I. APPLICATION INFORMATION

Identification of Facility

1. Facility Owner/Company Name:	Florida Power & Light Company		
2. Site Name:	Riviera Plant		
3. Facility Identification Number:	0990042	[]	Unknown
4. Facility Location: 200 – 300 Broadway Street Address or Other Locator:			
City: Riviera Beach	County: Palm Beach	Zip Code: 33404	
5. Relocatable Facility? [] Yes [X] No	6. Existing Permitted Facility? [X] Yes [] No		

Application Contact

1. Name and Title of Application Contact:	John C. Hampp Sr. Environmental Specialist		
2. Application Contact Mailing Address:			
Organization/Firm: Florida Power & Light Co. Environmental Services Dept.			
Street Address: 700 Universe Blvd.			
City: Juno Beach	State: FL	Zip Code: 33408	
3. Application Contact Telephone Numbers:			
Telephone: (561)- 691-2894	Fax: (561)- 691-7049		

Application Processing Information (DEP Use)

1. Date of Receipt of Application:	
2. Permit Number:	
3. PSD Number (if applicable):	
4. Siting Number (if applicable):	

Purpose of Application

Air Operation Permit Application

This Application for Air Permit is submitted to obtain: (Check one)

- Initial Title V air operation permit for an existing facility which is classified as a Title V source.
- Initial Title V air operation permit for a facility which, upon start up of one or more newly constructed or modified emissions units addressed in this application, would become classified as a Title V source.

Current construction permit number: _____

- Title V air operation permit revision to address one or more newly constructed or modified emissions units addressed in this application.

Current construction permit number: _____

Operation permit number to be revised: _____

- Title V air operation permit revision or administrative correction to address one or more proposed new or modified emissions units and to be processed concurrently with the air construction permit application. (Also check Air Construction Permit Application below.)

Operation permit number to be revised/corrected: _____

- Title V air operation permit revision for reasons other than construction or modification of an emissions unit. Give reason for the revision; e.g., to comply with a new applicable requirement or to request approval of an "Early Reductions" proposal.

Operation permit number to be revised: 0990042-001-AV

Reason for revision: TITLE V PERMIT RENEWAL

Air Construction Permit Application

This Application for Air Permit is submitted to obtain: (Check one)

- Air construction permit to construct or modify one or more emissions units.
- Air construction permit to make federally enforceable an assumed restriction on the potential emissions of one or more existing, permitted emissions units.
- Air construction permit for one or more existing, but unpermitted, emissions units.

Owner/Authorized Representative or Responsible Official

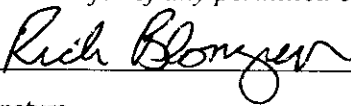
1. Name and Title of Owner/Authorized Representative or Responsible Official: Rick Blomgren - Plant Manager
2. Owner/Authorized Representative or Responsible Official Mailing Address: Organization/Firm: Florida Power & Light Company Riviera Plant Street Address: 200 - 300 Briadway City: Riviera Beach State: FL Zip Code: 33408
3. Owner/Authorized Representative or Responsible Official Telephone Numbers: Telephone: (561) 845-3101 Fax: (561) 845-3155
4. Owner/Authorized Representative or Responsible Official Statement: <i>I, the undersigned, am the owner or authorized representative*(check here [], if so) or the responsible official (check here [], if so) of the Title V source addressed in this application, whichever is applicable. I hereby certify, based on information and belief formed after reasonable inquiry, that the statements made in this application are true, accurate and complete and that, to the best of my knowledge, any estimates of emissions reported in this application are based upon reasonable techniques for calculating emissions. The air pollutant emissions units and air pollution control equipment described in this application will be operated and maintained so as to comply with all applicable standards for control of air pollutant emissions found in the statutes of the State of Florida and rules of the Department of Environmental Protection and revisions thereof. I understand that a permit, if granted by the Department, cannot be transferred without authorization from the Department, and I will promptly notify the Department upon sale or legal transfer of any permitted emissions unit.</i>  Signature _____ Date <u>6/25/2003</u>

* Attach letter of authorization if not currently on file.

Professional Engineer Certification

1. Professional Engineer Name: Kennard F. Kosky Registration Number: 14996
2. Professional Engineer Mailing Address: Organization/Firm: Golder Associates, Inc. Street Address: 6241 NW 23rd Street City: Gainesville State: FL Zip Code: 32653-1500
3. Professional Engineer Telephone Numbers: Telephone: (352) 336- 5600 Fax: (352) 336-6603

4. Professional Engineer Statement:

I, the undersigned, hereby certify, except as particularly noted herein, that:*

(1) To the best of my knowledge, there is reasonable assurance that the air pollutant emissions unit(s) and the air pollution control equipment described in this Application for Air Permit, when properly operated and maintained, will comply with all applicable standards for control of air pollutant emissions found in the Florida Statutes and rules of the Department of Environmental Protection; and

(2) To the best of my knowledge, any emission estimates reported or relied on in this application are true, accurate, and complete and are either based upon reasonable techniques available for calculating emissions or, for emission estimates of hazardous air pollutants not regulated for an emissions unit addressed in this application, based solely upon the materials, information and calculations submitted with this application.

If the purpose of this application is to obtain a Title V source air operation permit (check here [X], if so), I further certify that each emissions unit described in this Application for Air Permit, when properly operated and maintained, will comply with the applicable requirements identified in this application to which the unit is subject, except those emissions units for which a compliance schedule is submitted with this application.

If the purpose of this application is to obtain an air construction permit for one or more proposed new or modified emissions units (check here [], if so), I further certify that the engineering features of each such emissions unit described in this application have been designed or examined by me or individuals under my direct supervision and found to be in conformity with sound engineering principles applicable to the control of emissions of the air pollutants characterized in this application.

If the purpose of this application is to obtain an initial air operation permit or operation permit revision for one or more newly constructed or modified emissions units (check here [], if so), I further certify that, with the exception of any changes detailed as part of this application, each such emissions unit has been constructed or modified in substantial accordance with the information given in the corresponding application for air construction permit and with all provisions contained in such permit.

Thomas A. Kirby
Signature

7/2/03
Date

(seal) *[Signature]*

* Attach any exception to certification statement.

Golder Associates, Inc. - Board of Professional Engineers Certificate No. 00001670

Scope of Application

Emissions Unit ID	Description of Emissions Unit	Permit Type	Processing Fee
003	Fossil Fired Steam Generator, Unit #3	AV1B	N/A
004	Fossil Fired Steam Generator, Unit #4	AV1B	N/A
005	Painting and Solvent Cleaning	AV1F	N/A
006	Emergency diesel generator, and mobile equipment and engines	AV1F	N/A

Application Processing Fee

Check one: Attached - Amount: \$ _____ Not Applicable

Construction/Modification Information

1. Description of Proposed Project or Alterations:
2. Projected or Actual Date of Commencement of Construction:
3. Projected Date of Completion of Construction:

Application Comment

Application submittal is for the renewal of the Riviera Title V Air Operating permit. This facility is not subject to Compliance Assurance Monitoring (CAM) provisions (see PRVCAM.doc).

II. FACILITY INFORMATION

A. GENERAL FACILITY INFORMATION

Facility Location and Type

1. Facility UTM Coordinates: Zone: 17 East (km): 594.249 North (km): 2960.632			
2. Facility Latitude/Longitude: Latitude (DD/MM/SS): 27°45' 55" Longitude (DD/MM/SS): 80° 03' 09"			
3. Governmental Facility Code: O	4. Facility Status Code: A	5. Facility Major Group SIC Code: 49	6. Facility SIC(s): 4911
7. Facility Comment (limit to 500 characters): This application is for the Riviera Power Plant which consists of: Two oil and natural gas fired conventional steam electric generating units (Units 3 and 4) driving a single reheat turbine generator; and various unregulated emission units			

Facility Contact

1. Name and Title of Facility Contact: Gary Moncrief, Environmental Specialist
2. Facility Contact Mailing Address: Organization/Firm: Florida Power & Light Riviera Plant Street Address: 200 – 300 Broadway City: Riviera Beach State: FL Zip Code: 33408
3. Facility Contact Telephone Numbers: Telephone: (561) 845-3109 Fax: (561) 845-3155

Facility Regulatory Classifications

Check all that apply:

1. <input type="checkbox"/> Small Business Stationary Source?	<input type="checkbox"/> Unknown
2. <input checked="" type="checkbox"/> Major Source of Pollutants Other than Hazardous Air Pollutants (HAPs)?	
3. <input type="checkbox"/> Synthetic Minor Source of Pollutants Other than HAPs?	
4. <input checked="" type="checkbox"/> Major Source of Hazardous Air Pollutants (HAPs)?	
5. <input type="checkbox"/> Synthetic Minor Source of HAPs?	
6. <input checked="" type="checkbox"/> One or More Emissions Units Subject to NSPS?	
7. <input checked="" type="checkbox"/> One or More Emission Units Subject to NESHAP?	
8. <input type="checkbox"/> Title V Source by EPA Designation?	
9. Facility Regulatory Classifications Comment (limit to 200 characters):	
<p>The facility is located in a former non-attainment area for ozone which is now designated as a maintenance area and the generating units are subject to NO_x-RACT.</p>	

List of Applicable Regulations

All applicable FAC regulations are covered under existing Title V permit and there are no additional requirements.	
See attached Title V Core List.	

B. FACILITY POLLUTANTS

List of Pollutants Emitted

1. Pollutant Emitted	2. Pollutant Classif.	3. Requested Emissions Cap		4. Basis for Emissions Cap	5. Pollutant Comment
		lb/hour	tons/year		
SO2	A				
NOx	A				
CO	A				
PM	A				
PM10	A				
VOC	A				
H133	A				
SAM	A				
H106	A				
H107	A				

C. FACILITY SUPPLEMENTAL INFORMATION

Supplemental Requirements

<p>1. Area Map Showing Facility Location: <input checked="" type="checkbox"/> Attached, Document ID: <u>PRVFS-1.bmp</u> <input type="checkbox"/> Not Applicable <input type="checkbox"/> Waiver Requested</p>
<p>2. Facility Plot Plan: <input checked="" type="checkbox"/> Attached, Document ID: <u>PRVFS-2.bmp</u> <input type="checkbox"/> Not Applicable <input type="checkbox"/> Waiver Requested</p>
<p>3. Process Flow Diagram(s): <input checked="" type="checkbox"/> Attached, Document ID: <u>PRVFS-3.bmp</u> <input type="checkbox"/> Not Applicable <input type="checkbox"/> Waiver Requested</p>
<p>4. Precautions to Prevent Emissions of Unconfined Particulate Matter: <input checked="" type="checkbox"/> Attached, Document ID: <u>PRVFS-4.txt</u> <input type="checkbox"/> Not Applicable <input type="checkbox"/> Waiver Requested</p>
<p>5. Fugitive Emissions Identification: <input checked="" type="checkbox"/> Attached, Document ID: <u>PRVFS-5.txt</u> <input type="checkbox"/> Not Applicable <input type="checkbox"/> Waiver Requested</p>
<p>6. Supplemental Information for Construction Permit Application: <input type="checkbox"/> Attached, Document ID: _____ <input type="checkbox"/> Not Applicable</p>
<p>7. Supplemental Requirements Comment:</p>

Additional Supplemental Requirements for Title V Air Operation Permit Applications

8. List of Proposed Insignificant Activities: <input checked="" type="checkbox"/> Attached, Document ID: <u>PRVFS-8.txt</u> <input checked="" type="checkbox"/> Not Applicable
9. List of Equipment/Activities Regulated under Title VI: <input type="checkbox"/> Attached, Document ID: _____ <input type="checkbox"/> Equipment/Activities On site but Not Required to be Individually Listed <input checked="" type="checkbox"/> Not Applicable
10. Alternative Methods of Operation: <input type="checkbox"/> Attached, Document ID: _____ <input checked="" type="checkbox"/> Not Applicable
11. Alternative Modes of Operation (Emissions Trading): <input type="checkbox"/> Attached, Document ID: _____ <input checked="" type="checkbox"/> Not Applicable
12. Identification of Additional Applicable Requirements: <input type="checkbox"/> Attached, Document ID: _____ <input checked="" type="checkbox"/> Not Applicable
13. Risk Management Plan Verification: <input checked="" type="checkbox"/> Plan previously submitted to Chemical Emergency Preparedness and Prevention Office (CEPPO). Verification of submittal attached (Document ID: _____) or previously submitted to DEP (Date and DEP Office: _____) <input type="checkbox"/> Plan to be submitted to CEPPO (Date required: _____) <input type="checkbox"/> Not Applicable
14. Compliance Report and Plan: <input checked="" type="checkbox"/> Attached, Document ID: <u>PRVFS-14.txt</u> <input type="checkbox"/> Not Applicable
15. Compliance Certification (Hard-copy Required): <input checked="" type="checkbox"/> Attached, Document ID: <u>PRVFS-15.txt</u> <input type="checkbox"/> Not Applicable

III. EMISSIONS UNIT INFORMATION

A separate Emissions Unit Information Section (including subsections A through J as required) must be completed for each emissions unit addressed in this Application for Air Permit. If submitting the application form in hard copy, indicate, in the space provided at the top of each page, the number of this Emissions Unit Information Section and the total number of Emissions Unit Information Sections submitted as part of this application.

**A. GENERAL EMISSIONS UNIT INFORMATION
(All Emissions Units)**

Emissions Unit Description and Status

<p>1. Type of Emissions Unit Addressed in This Section: (Check one)</p> <p><input checked="" type="checkbox"/> This Emissions Unit Information Section addresses, as a single emissions unit, a single process or production unit, or activity, which produces one or more air pollutants and which has at least one definable emission point (stack or vent).</p> <p><input type="checkbox"/> This Emissions Unit Information Section addresses, as a single emissions unit, a group of process or production units and activities which has at least one definable emission point (stack or vent) but may also produce fugitive emissions.</p> <p><input type="checkbox"/> This Emissions Unit Information Section addresses, as a single emissions unit, one or more process or production units and activities which produce fugitive emissions only.</p>			
<p>2. Regulated or Unregulated Emissions Unit? (Check one)</p> <p><input checked="" type="checkbox"/> The emissions unit addressed in this Emissions Unit Information Section is a regulated emissions unit.</p> <p><input type="checkbox"/> The emissions unit addressed in this Emissions Unit Information Section is an unregulated emissions unit.</p>			
<p>3. Description of Emissions Unit Addressed in This Section (limit to 60 characters): Fossil Fuel Fired Steam Generator # 3</p>			
<p>4. Emissions Unit Identification Number: [] No ID</p> <p>ID: 03 [] ID Unknown</p>			
<p>5. Emissions Unit Status Code: A</p>	<p>6. Initial Startup Date: 05/1962</p>	<p>7. Emissions Unit Major Group SIC Code: 49</p>	<p>8. Acid Rain Unit? [Y]</p>
<p>9. Emissions Unit Comment: (Limit to 500 Characters) Emission Unit 03 (Riviera Unit 3) is a nominal 310 MW(electrical) steam generator fired on Natural Gas or using No.2 or No.6 fuel oil and consists of a boiler/steam generator driving a single reheat turbine generator.</p>			

Emissions Unit Control Equipment

1. Control Equipment/Method Description (Limit to 200 characters per device or method):

A = Multiple Cyclone w/o Fly Ash Reinjection

B = Low NOx Burners

C = Staged Combustion

2. Control Device or Method Code(s): **077, 024, 025**

Emissions Unit Details

1. Package Unit:

Manufacturer: **Foster-Wheeler**

Model Number: **N/A**

2. Generator Nameplate Rating:

310

MW

3. Incinerator Information:

Dwell Temperature:

°F

Dwell Time:

seconds

Incinerator Afterburner Temperature:

°F

**B. EMISSIONS UNIT CAPACITY INFORMATION
(Regulated Emissions Units Only)**

Emissions Unit Operating Capacity and Schedule

1. Maximum Heat Input Rate:	3,260	mmBtu/hr
2. Maximum Incineration Rate:	lb/hr	tons/day
3. Maximum Process or Throughput Rate:		
4. Maximum Production Rate:		
5. Requested Maximum Operating Schedule:	hours/day	days/week
	weeks/year	8760 hours/year
6. Operating Capacity/Schedule Comment (limit to 200 characters): Maximum Heat Input Rate based on firing 100% Natural Gas provided as a permitting note for purpose of particulate testing information when applicable. The maximum heat input when firing fuel oil is 3,050 MMBtu/hr.		

**C. EMISSIONS UNIT REGULATIONS
(Regulated Emissions Units Only)**

List of Applicable Federal Regulations

40 CFR 279.72, Analysis and Records	On-Specification Used Oil
40 CFR 72.9 (a), Acid Rain Permits	Permit requirements
40 CFR 72.9 (b), Acid Rain Permits	Monitoring Requirements
40 CFR 72.9 (c)(1), Acid Rain Permits	SO2 Allowance Requirements - Holding
40 CFR 72.9 (c)(2), Acid Rain Permits	SO2 Allowance - Excess Emissions Violations
40 CFR 72.9 (c)(3)(iii), Acid Rain Permits	SO2 Allowance - Phase II Unit applicability
40 CFR 72.9 (c)(4), Acid Rain Permits	SO2 Allowance Tracking System Accounts
40 CFR 72.9 (c)(5), Acid Rain Permits	SO2 Allowance Year of Use Requirement
40 CFR 72.9 (d), Acid Rain Permits	NOx Requirements
40 CFR 72.9 (e), Acid Rain Permits	Excess Emission Requirements & Offsets
40 CFR 72.9 (f), Acid Rain Permits	Recordkeeping and Reporting
40 CFR 72.9 (g), Acid Rain Permits	Liability and Civil Penalty
40 CFR 72.20 (a), Acid Rain Permits	Designated Representative Requirement
40 CFR 72.20 (b), Acid Rain Permits	Designated Representative Legal Binding
40 CFR 72.20 (c), Acid Rain Permits	Designated Representative Certification
40 CFR 72.21, Acid Rain Permits	Submissions by Designated Representative
40 CFR 72.22, Acid Rain Permits	Alternate Designated Representative Requirement
40 CFR 72.23, Acid Rain Permits	Changing Designated Representatives or Owners

**C. EMISSIONS UNIT REGULATIONS
(Regulated Emissions Units Only)**

List of Applicable Federal Regulations

40 CFR 72.24, Acid Rain Permits	Designated Representative Certificate of Representation
40 CFR 72.30 (a), Acid Rain Permits	Acid Rain Permit Duty to Apply
40 CFR 72.30 (b) (2), Acid Rain Permits	Acid Rain Permit Requirements to apply for Phase II
40 CFR 72.30 (c), Acid Rain Permits	Acid Rain Permit Renewal application prior to Permit Expiration
40 CFR 72.30 (d), Acid Rain Permits	Acid Rain Permit Submittal Requirements
40 CFR 72.31, Acid Rain Permits	Acid Rain Permit Information Requirements
40 CFR 72.32, Acid Rain Permits	Permit Application Shield
40 CFR 72.33 (b), Acid Rain Permits	Identification of Dispatch System
40 CFR 72.33 (c), Acid Rain Permits	Dispatch System Requirements
40 CFR 72.33 (d), Acid Rain Permits	Changing Dispatch System Identification
40 CFR 72.40, Acid Rain Permits	Compliance Plan Application Requirements
40 CFR 72.50, Acid Rain Permits	General Permit Requirements
40 CFR 72.51, Acid Rain Permits	Permit Shield
40 CFR 72.90, Acid Rain Permits	Annual Compliance Certification
40 CFR 73.30, SO2 Allowance System	Allowance Tracking System Accounts
40 CFR 73.31, SO2 Allowance System	Establishment of Accounts
40 CFR 73.32, SO2 Allowance System	Allowance Account Contents
40 CFR 73.33, SO2 Allowance System	Authorized Account Representative
40 CFR 73.35 (a), SO2 Allowance System	Compliance and Allowance Transfer Deadline

**C. EMISSIONS UNIT REGULATIONS
(Regulated Emissions Units Only)**

List of Applicable Federal Regulations

40 CFR 73.35 (b), SO2 Allowance System	Allowance Deductions for Compliance
40 CFR 73.35 (c), SO2 Allowance System	Identification of Allowances by Serial Number
40 CFR 73.35 (d), SO2 Allowance System	Deductions for Excess Emissions
40 CFR 75.4, CEMS	Compliance Dates
40 CFR 75.5, CEMS	Prohibitions
40 CFR 75.10 (a) (1), CEMS	Primary Measurement - SO2
40 CFR 75.10 (a) (2), CEMS	Primary Measurement - NOx
40 CFR 75.10 (a) (3) (iii), CEMS	Primary Measurement - CO2 & O2 Monitor
40 CFR 75.10 (b), CEMS	Primary Equipment Performance Requirements
40 CFR 75.10 (c), CEMS	Heat Input Measurement Requirement
40 CFR 75.10 (e), CEMS	Optional Backup Monitor Requirements
40 CFR 75.10 (f), CEMS	Minimum Measurement Capability
40 CFR 75.11 (d), CEMS	SO2 Emission Monitoring Requirements for Gas-Fired Units
40 CFR 75.11 (e), CEMS	SO2 Emissions Monitoring Gas-Fired Units
40 CFR 75.12 (a), CEMS	NOx Monitoring
40 CFR 75.12 (b), CEMS	NOx Monitoring Moisture Correction
40 CFR 75.12 (c), CEMS	NOx Monitoring Determination of NOx Emission Rate - Appendix F
40 CFR 75.13 (b), CEMS	CO2 Emissions Monitoring Appendix G
40 CFR 75.13 (c), CEMS	CO2 Mass Emissions Monitoring Appendix F

**C. EMISSIONS UNIT REGULATIONS
(Regulated Emissions Units Only)**

List of Applicable Federal Regulations

40 CFR 75.14 (c), CEMS	Opacity Monitoring Gas Unit Exemption
40 CFR 75.20 (a), CEMS	Initial Certification & Loss of Certification
40 CFR 75.20 (b), CEMS	Recertification Approval Process
40 CFR 75.20 (c), CEMS	Certification Procedures
40 CFR 75.20 (d), CEMS	Certification and QA/QC for Backup Monitors
40 CFR 75.20 (f), CEMS	Certification of Alternative Monitoring Systems
40 CFR 75.21 (a), CEMS	CEMS QA/QC
40 CFR 75.21 (c), CEMS	Calibration Gasses for CEMS QA/QC
40 CFR 75.21 (d), CEMS	QA/QC RATA Periodic Notification
40 CFR 75.21 (e), CEMS	QA/QC Audit Consequences
40 CFR 75.22 , CEMS	Reference Test Methods
40 CFR 75.24 , CEMS	Out of Control Periods and Bias Adjustment
40 CFR 75.30 (a)(3) , CEMS	NOx Missing Data Substitution Procedures
40 CFR 75.30 (a)(4) , CEMS	SO2 Missing Data Substitution Procedures
40 CFR 75.30 (b) , CEMS	Missing Data Substitution Procedures for Backup Monitors
40 CFR 75.30 (c) , CEMS	Missing Data Substitution using Backup Monitors
40 CFR 75.30 (d) , CEMS	SO2 Missing Data Substitution - Gas Units
40 CFR 75.31 , CEMS	Initial Missing Data Procedures
40 CFR 75.32 , CEMS	Monitoring Data Availability for Missing Data

**C. EMISSIONS UNIT REGULATIONS
(Regulated Emissions Units Only)**

List of Applicable Federal Regulations

40 CFR 75.33 , CEMS	Standard Missing Data Procedures
40 CFR 75.36 , CEMS	Missing Data for Heat Input
40 CFR 75.40 , CEMS	Alternate Monitoring Systems General Demonstration Requirements
40 CFR 75.41 , CEMS	Alternate Monitoring Systems Precision Criteria
40 CFR 75.42 , CEMS	Alternate Monitoring Systems Reliability Criteria
40 CFR 75.43 , CEMS	Alternate Monitoring Systems Accessibility Criteria
40 CFR 75.44 , CEMS	Alternate Monitoring Systems Timeliness Criteria
40 CFR 75.45 , CEMS	Alternate Monitoring Systems Daily QA
40 CFR 75.46 , CEMS	Alternate Monitoring Systems Missing Data Substitution Criteria
40 CFR 75.47 , CEMS	Alternate Monitoring Systems Criteria For a Class of Affected Unit
40 CFR 75.48 , CEMS	Petition for Alternate Monitoring Systems
40 CFR 75.53 , CEMS	Monitoring Plan
40 CFR 75.54 , CEMS	General Recordkeeping Provisions
40 CFR 75.55 (c) , CEMS	Specific Recordkeeping Provisions - Fired units using SO2 Appendix D Gas
40 CFR 75.55 (e) , CEMS	Specific Recordkeeping Provisions -SO2 for Gas Fired units
40 CFR 75.56 , CEMS	Certification, QA/QC record Provisions
40 CFR 75.57 , CEMS	General Recordkeeping Provisions
40 CFR 75.58 (c) , CEMS	Specific Recordkeeping Provisions - Fired units using SO2 Appendix D Gas
40 CFR 75.58 (e) , CEMS	Specific Recordkeeping Provisions -SO2 for Gas Fired units

**C. EMISSIONS UNIT REGULATIONS
(Regulated Emissions Units Only)**

List of Applicable Federal Regulations

40 CFR 75.59 , CEMS	Certification, QA/QC record Provisions
40 CFR 75.60 , CEMS	General Reporting Requirements
40 CFR 75.61 , CEMS	Reporting Requirements Notifications
40 CFR 75.62 , CEMS	Monitoring Plan Reporting Requirements
40 CFR 75.63 , CEMS	Certification Reporting Requirements
40 CFR 75.64 (a) , CEMS	Quarterly Reports Submission
40 CFR 75.64 (b) , CEMS	Quarterly Reports Designated Representative Statement
40 CFR 75.64 (c) , CEMS	Quarterly Reports Compliance Certification
40 CFR 75.64 (d) , CEMS	Quarterly Reports Electronic Submittal
40 CFR 75.66 , CEMS	Petitions to the Administrator (if required)
40 CFR Part 75 - Appendix A-1	Installation and Measurement Locations
40 CFR Part 75 - Appendix A-2	Equipment Specifications
40 CFR Part 75 - Appendix A-3	Performance Specifications
40 CFR Part 75 - Appendix A-4	Data Handling and Acquisition Systems
40 CFR Part 75 - Appendix A-5	Calibration Gasses
40 CFR Part 75 - Appendix A-6	Certification Tests and Procedures
40 CFR Part 75 - Appendix A-7	Calculations
40 CFR Part 75 - Appendix B	QA/QC Procedures
40 CFR Part 75 - Appendix C-1	Missing Data; SO₂ & NO_x for controlled sources

**C. EMISSIONS UNIT REGULATIONS
(Regulated Emissions Units Only)**

List of Applicable Federal Regulations

40 CFR Part 75 - Appendix C-2	Missing Data ; Load Based Procedure; NOx & Flow
40 CFR Part 75 - Appendix D	Optional SO2 Emissions Protocol for Gas Fired Units
40 CFR Part 75 - Appendix F	Conversion Procedures
40 CFR Part 75 - Appendix G-2	Conversion Procedures
40 CFR Part 75 - Appendix G-4	Conversion Procedures
40 CFR Part 75 - Appendix H	Conversion Procedures
40 CFR 77.3 , Excess Emissions	Future SO2 Offset Plans
40 CFR 77.5 (b) , Excess Emissions	Future Deduction of SO2 Allowances for Excess SO2 Emissions
40 CFR 77.6 , Excess Emissions	Future Penalties for Excess Emissions of SO2 and NOx
FAC 62-204.800(12) (State Only)	Acid Rain Program
FAC 62-204.800(13) (State Only)	Allowances
FAC 62-204.800(14) (State Only)	Acid Rain Program Monitoring
FAC 62-204.800(16) (State Only)	Excess Emissions
FAC 62-210.650, Stationary Sources	Circumvention; EU's with control device
FAC 62-210.700 (1), Stationary Sources	Excess Emissions
FAC 62-210.700 (4), Stationary Sources	Excess Emissions & Poor Maintenance
FAC 62-210.700 (6), Stationary Sources	Excess Emissions Notification
FAC 62-210.300 , Acid Rain	Acid Rain Unit Applicability
FAC 62-210.320 (1)(a),(2) , Acid Rain	Acid Rain Unit Application Shield

**C. EMISSIONS UNIT REGULATIONS
(Regulated Emissions Units Only)**

List of Applicable State Regulations

FAC 62-210.330 (1)(a)1., Acid Rain	Acid Rain Unit Compliance Options
FAC 62-210.340, Acid Rain	New and Retired Unit Exemptions
FAC 62-210.350(2);(3);(6), Acid Rain	Acid Rain Unit Certification
FAC 62-210.370, Acid Rain	Acid Rain Unit Revisions & Corrections
FAC 62-210.430, Acid Rain	Compliance Options for Acid Rain Units
FAC 62-296.405(1), Existing FFSG	PM and SO2 Limits
FAC 62-296.570(4)(b)3	NOx RACT
FAC 62-297.310(1), Emiss. Monitoring	Test Runs - Mass Emissions
FAC 62-297.310(2)(b), Emiss. Monitoring	Operating Rate
FAC 62-297.310(3), Emiss. Monitoring	Calculation of Emissions
Table 62-297.310-1 , Emiss. Monitoring	
FAC 62-297.310(7)(a)9 , Emiss. Monitoring	FDEP Notification 15 days prior to tests
FAC 62-297.310(7)(c) , Emiss. Monitoring	Waiver for Compliance Tests for Fuel Sampling

**D. EMISSION POINT (STACK/VENT) INFORMATION
(Regulated Emissions Units Only)**

Emission Point Description and Type

1. Identification of Point on Plot Plan or Flow Diagram? Unit 3 boiler		2. Emission Point Type Code: 1	
3. Descriptions of Emission Points Comprising this Emissions Unit for VE Tracking (limit to 100 characters per point): Unit exhaust through single stack			
4. ID Numbers or Descriptions of Emission Units with this Emission Point in Common:			
5. Discharge Type Code: V	6. Stack Height: 298 feet	7. Exit Diameter: 16 feet	
8. Exit Temperature: 263 °F	9. Actual Volumetric Flow Rate: 1,063,401.3	10. Water Vapor: %	
11. Maximum Dry Standard Flow Rate: dscfm		12. Nonstack Emission Point Height: feet	
13. Emission Point UTM Coordinates: Zone: 17 East (km): 59424 North (km): 2960801			
14. Emission Point Comment (limit to 200 characters): Values for fields 8 and 9 derived from compliance tests (EPA Method 17) at approximately 90% max. heat input. (February, 1994)			

E. SEGMENT (PROCESS/FUEL) INFORMATION
(All Emissions Units)

Segment Description and Rate: Segment 1 of 7

1. Segment Description (Process/Fuel Type) (limit to 500 characters): Unit 3 Firing Natural Gas		
2. Source Classification Code (SCC): 1-01-006-01		3. SCC Units: Million Cubic Feet
4. Maximum Hourly Rate: 3.1	5. Maximum Annual Rate: 27,197.7	6. Estimated Annual Activity Factor:
7. Maximum % Sulfur: 0.0031	8. Maximum % Ash:	9. Million Btu per SCC Unit: 1,050
10. Segment Comment (limit to 200 characters): $\%S = [10\text{gr of S}/1000 \text{ CF gas}] * [1 \text{ lb S}/7000 \text{ gr}] [\text{CF gas}/0.046 \text{ lb gas}] * 100 = 0.0031\%S$		

Segment Description and Rate: Segment 2 of 7

1. Segment Description (Process/Fuel Type) (limit to 500 characters): Unit 3 Firing No. 6 Residual Fuel Oil		
2. Source Classification Code (SCC): 1-01-004-01		3. SCC Units: Thousand Gallons
4. Maximum Hourly Rate: 20.07	5. Maximum Annual Rate: 175,776.3	6. Estimated Annual Activity Factor: %
7. Maximum % Sulfur: 2.5	8. Maximum % Ash: 0.1	9. Million Btu per SCC Unit: 152
10. Segment Comment (limit to 200 characters): This emission unit may burn up to 2.5% sulfur oil .		

E. SEGMENT (PROCESS/FUEL) INFORMATION
(All Emissions Units)

Segment Description and Rate: Segment 3 of 7

1. Segment Description (Process/Fuel Type) (limit to 500 characters): Unit 3 Firing Propane		
2. Source Classification Code (SCC): 1-01-006-01		3. SCC Units: Million Cubic Feet
4. Maximum Hourly Rate: 3.26	5. Maximum Annual Rate: 28,557.6	6. Estimated Annual Activity Factor:
7. Maximum % Sulfur:	8. Maximum % Ash:	9. Million Btu per SCC Unit: 1,000
10. Segment Comment (limit to 200 characters): Unit 3 is currently permitted to burn a mixture of natural gas, No. 6 oil, No. 2 oil, propane, or on-spec. used oil from FPL operations. Propane is primarily used for lighting off the boiler for start-up.		

Segment Description and Rate: Segment 4 of 7

1. Segment Description (Process/Fuel Type) (limit to 500 characters): Unit 3 Firing No. 2 Fuel Oil		
2. Source Classification Code (SCC): 1-01-005-01		3. SCC Units: Thousand Gallons
4. Maximum Hourly Rate: 22.43	5. Maximum Annual Rate: 196,455.9	6. Estimated Annual Activity Factor: %
7. Maximum % Sulfur: 0.5	8. Maximum % Ash: 0.01	9. Million Btu per SCC Unit: 136
10. Segment Comment (limit to 200 characters): Unit 3 is currently permitted to burn a mixture of natural gas, No. 6 oil, No. 2 oil, propane, or on-spec. used oil from FPL operations. No. 2 oil is primarily used for during boiler for start-up.		

**E. SEGMENT (PROCESS/FUEL) INFORMATION
(All Emissions Units)**

Segment Description and Rate: Segment 5 of 7

1. Segment Description (Process/Fuel Type) (limit to 500 characters): Unit 3 Co-Firing On-Specification Used Oil from FPL Operations		
2. Source Classification Code (SCC): 1-01-013-01		3. SCC Units: Thousand Gallons
4. Maximum Hourly Rate: 22.43	5. Maximum Annual Rate: 1,500	6. Estimated Annual Activity Factor:
7. Maximum % Sulfur: 2.5	8. Maximum % Ash:	9. Million Btu per SCC Unit:
10. Segment Comment (limit to 200 characters): The maximum annual rate of on-specification used oil burned in the Riviera boiler Unit 3 is based on limit for both units (Condition A.37.b of current Title V permit).		

Segment Description and Rate: Segment 6 of 7

1. Segment Description (Process/Fuel Type) (limit to 500 characters): Unit 3 Co-Firing all possible combinations of Natural Gas, No. 6 Residual Oil, No. 2 Fuel Oil, On-Spec. Used Oil, and Propane		
2. Source Classification Code (SCC): 1-01-006-01		3. SCC Units: Million Cubic Ft. and Thousand Gallons
4. Maximum Hourly Rate: 20.07	5. Maximum Annual Rate: 175,776.3	6. Estimated Annual Activity Factor: %
7. Maximum % Sulfur: 2.5	8. Maximum % Ash: 0.1	9. Million Btu per SCC Unit: 152
10. Segment Comment (limit to 200 characters): Unit 3 is permitted to burn a mixture of nat. gas, No.6 oil, No.2 oil, propane , or on-spec. used oil. Permit allows Unit 3 to burn a mixture of the above fuels provided max. SO2 rate is 2.75 lbs/mmBtu.		

**E. SEGMENT (PROCESS/FUEL) INFORMATION
(All Emissions Units)**

Segment Description and Rate: Segment 7 of 7

1. Segment Description (Process/Fuel Type) (limit to 500 characters): Unit 3 Boiler Chemical Cleaning waste evaporation. This process may be undertaken while firing natural gas or residual oil		
2. Source Classification Code (SCC): 1-01-013-01		3. SCC Units: Thousand Gallons
4. Maximum Hourly Rate: 3	5. Maximum Annual Rate: 500	6. Estimated Annual Activity Factor:
7. Maximum % Sulfur:	8. Maximum % Sulfur:	9. Million Btu per SCC Unit:
10. Segment Comment (limit to 200 characters): Items 6 - 9 do not apply. This activity to be undertaken on a periodic basis in accordance with DARM guidance, and EPA waste rules (40 CFR 279.72)		

**F. EMISSIONS UNIT POLLUTANTS
(All Emissions Units)**

1. Pollutant Emitted	2. Primary Control Device Code	3. Secondary Control Device Code	4. Pollutant Regulatory Code
PM	077		EL
SO2			EL
NOx	024, 025		EL
CO			NS
VOC			NS
PM10			NS
H133			NS
SAM			NS
H106			NS
H107			NS

G. EMISSIONS UNIT POLLUTANT DETAIL INFORMATION
(Regulated Emissions Units -
Emissions-Limited and Preconstruction Review Pollutants Only)

Potential/Fugitive Emissions

1. Pollutant Emitted: PM		2. Total Percent Efficiency of Control:	
3. Potential Emissions: 381.25lb/hour		4. Synthetically Limited? [NO]	
		1,669.88 tons/year	
5. Range of Estimated Fugitive Emissions: [] 1 [] 2 [] 3 _____ to _____ tons/year			
6. Emission Factor: 0.125 lb/mmBtu Reference: DEP Rule 62-296.405(1)(b) and Rule 62-210.700(3)		7. Emissions Method Code: 0	
8. Calculation of Emissions (limit to 600 characters): 0.125 lb/mmBtu * 3,050 mmBtu/hr = 381.25 lb/hr (381.25 lb/hr * 8760 hr/yr) / 2000 lb/ton = 1,669.88 tons/yr			
9. Pollutant Potential/Fugitive Emissions Comment (limit to 200 characters): Emission rate based on 3hrs/24hrs at 0.3 lb/mmBtu and 21hrs/24hrs at 0.1 lb/mmBtu which is equivalent to a rate of 0.125 lb/mmBtu			

Allowable Emissions Allowable Emissions 1 of 3

1. Basis for Allowable Emissions Code: Required or assumed by permittee		2. Future Effective Date of Allowable Emissions:	
3. Requested Allowable Emissions and Units: 0.1 lb/mmBtu steady state (ss) 0.3 lb/mmBtu sootblow (sb)		4. Equivalent Allowable Emissions: 305 lb/hour 1,168.9 tons/year (ss) 915 lb/hour 501 tons/year (sb)	
5. Method of Compliance (limit to 60 characters): DEP Rule 62-296.405(1)(e)2			
6. Allowable Emissions Comment (Desc. of Operating Method) (limit to 200 characters): 0.1 lb/mmBtu = reg. Limit for PM [Rule 62-296.340(1)(e)], 0.3 lb/mmBtu = reg. Limit for sootblow based on 3hr/24hr limit [62-210.700(3)]. Emissions based on 100% oil.			

G. EMISSIONS UNIT POLLUTANT DETAIL INFORMATION
(Regulated Emissions Units -
Emissions-Limited and Preconstruction Review Pollutants Only)

Potential/Fugitive Emissions

1. Pollutant Emitted: SO2	2. Total Percent Efficiency of Control:
3. Potential Emissions: 8,387.5lb/hour 36,737.25 tons/year	4. Synthetically Limited? [N]
5. Range of Estimated Fugitive Emissions: [] 1 [] 2 [] 3 _____ to _____ tons/year	
6. Emission Factor: 2.75 lb/mmBtu; Reference: DEP Rule 62-296.405(1)(c)1.j.	7. Emissions Method Code: 0
8. Calculation of Emissions (limit to 600 characters): 3,050 mmBtu/hr * 2.75 lb/mmBtu = 8,387.5 lb/hr (8,387.5 lb/hr * 8760 hr/yr) / 2000 lb/ton = 36,737.25 ton/yr	
9. Pollutant Potential/Fugitive Emissions Comment (limit to 200 characters): This emission unit is limited to firing 2.5% sulfur oil while firing 100% oil and is limited by DEP Rule 62-296.405(1)(c)1.j.	

Allowable Emissions Allowable Emissions 2 of 3

1. Basis for Allowable Emissions Code: Required or assumed by permittee	2. Future Effective Date of Allowable Emissions:
3. Requested Allowable Emissions and Units: 2.75 lb/mmBtu	4. Equivalent Allowable Emissions: 8,387.5 lb/hour 36,737.25 tons/year
5. Method of Compliance (limit to 60 characters): Fuel Specifications and vendor sampling and analysis	
6. Allowable Emissions Comment (Desc. of Operating Method) (limit to 200 characters): Equivalent allowable emissions for liquid fuel firing. This unit is subject to DEP Rule 62-296.405(1)(c)1.j.	

G. EMISSIONS UNIT POLLUTANT DETAIL INFORMATION
(Regulated Emissions Units -
Emissions-Limited and Preconstruction Review Pollutants Only)

Potential/Fugitive Emissions

1. Pollutant Emitted: NOx	2. Total Percent Efficiency of Control:
3. Potential Emissions: 1,891 lb/hour 8,282.6 tons/year	4. Synthetically Limited? [No]
5. Range of Estimated Fugitive Emissions: [] 1 [] 2 [] 3 to tons/year	
6. Emission Factor: 0.50 lb/mmBtu (gas); 0.62 lb/mmBtu (oil) Reference: DEP Rule 62-296.570(4)(a)4 and (4)(b)3	7. Emissions Method Code: 0
8. Calculation of Emissions (limit to 600 characters): 0.62 lb/mmBtu * 3,050 mmBtu/hr = 1,891 lb/hr (oil) (1,891 lb/hr * 8,760 hr/yr) / 2,000 lb/ton = 8,282.6 tons/year (oil) 0.50 lb/mmBtu * 3,260 mmBtu/hr = 1,630 lb/hr (gas) (1,630 lb/hr * 8,760 hr/yr) / 2,000 lb/ton = 7,139.4 tons/year (gas)	
9. Pollutant Potential/Fugitive Emissions Comment (limit to 200 characters): Emission limit calculated for oil and gas combustion.	

Allowable Emissions Allowable Emissions 3 of 3

1. Basis for Allowable Emissions Code: RULE	2. Future Effective Date of Allowable Emissions:
3. Requested Allowable Emissions and Units: 0.5 lb/mmBtu (gas) 0.62 lb/mmBtu (oil)	4. Equivalent Allowable Emissions: gas 1,630 lb/hour 7,139.4 tons/year oil 1,891 lb/hour 8,282.6 tons/year
5. Method of Compliance (limit to 60 characters): CEM Part 75 , 30 day rolling average Rule 62-296.570(4)(a)4	
6. Allowable Emissions Comment (Desc. of Operating Method) (limit to 200 characters): This emission unit utilizes Low NOx burners as well as off-stoichiometric combustion to control emissions of NOx.	

H. VISIBLE EMISSIONS INFORMATION
(Only Regulated Emissions Units Subject to a VE Limitation)

Visible Emissions Limitation: Visible Emissions Limitation 1 of 3

1. Visible Emissions Subtype: VE40	2. Basis for Allowable Opacity: <input checked="" type="checkbox"/> Rule <input type="checkbox"/> Other
3. Requested Allowable Opacity: Normal Conditions: 40 % Exceptional Conditions: % Maximum Period of Excess Opacity Allowed: see comment below min/hour	
4. Method of Compliance: VE Test (EPA Method 9)	
5. Visible Emissions Comment (limit to 200 characters): Visible emissions limited to 40% opacity except for allowable excess emissions	

Visible Emissions Limitation: Visible Emissions Limitation 2 of 3

1. Visible Emissions Subtype: VE60	2. Basis for Allowable Opacity: <input checked="" type="checkbox"/> Rule <input type="checkbox"/> Other
3. Requested Allowable Opacity: Normal Conditions: 100 % Exceptional Conditions: 100 % Maximum Period of Excess Opacity Allowed: 24 min/hour	
4. Method of Compliance: VE Test (EPA Method 9)	
5. Visible Emissions Comment (limit to 200 characters): FDEP Rule 62-210.700(3) allows up to 60% opacity for 3 hours/24 hour period for soot blow and load changes with < 4 six-minute periods of up to 100% opacity.	

Visible Emissions Limitation: Visible Emissions Limitation 3 of 3

2. Visible Emissions Subtype: VE99	2. Basis for Allowable Opacity: <input checked="" type="checkbox"/> Rule <input type="checkbox"/> Other
3. Requested Allowable Opacity: Normal Conditions: 100 % Exceptional Conditions: 100 % Maximum Period of Excess Opacity Allowed: 60 min/hour	
6. Method of Compliance: VE Test (EPA Method 9)	
7. Visible Emissions Comment (limit to 200 characters): FDEP Rule 62-210.700(1) & (2) allows up to 100% opacity for unlimited time during from start-up & shut-down, and 2 hours/24 hour period for malfunctions.	

I. CONTINUOUS MONITOR INFORMATION
(Only Regulated Emissions Units Subject to Continuous Monitoring)

Continuous Monitoring System: Continuous Monitor 1 of 3

1. Parameter Code: EM	2. Pollutant(s): NOx
3. CMS Requirement: <input checked="" type="checkbox"/> Rule <input type="checkbox"/> Other	
4. Monitor Information Manufacturer: : NOx = TECO CO₂ = Milton Roy Model Number: NOx = 42C CO₂ = 3300 Serial Number: NOx = 42C-77128-385 CO₂ = N3H8174T	
5. Installation Date: NOx = 01/23/2003 CO₂ = 041/01/1995	6. Performance Specification Test Date: 2/13/2003
7. Continuous Monitor Comment (limit to 200 characters): NOx Required by 40 CFR 75.10(a)(2);; CO₂ provides % O₂ data to NOx monitor per 40 CFR 75 Appendix E. CO₂ data is calculated using 40 CFR 75 Appendix G equation G-4 .	

Continuous Monitoring System: Continuous Monitor 2 of 3

2. Parameter Code: EM	2. Pollutant(s): SO₂
3. CMS Requirement: <input checked="" type="checkbox"/> Rule <input type="checkbox"/> Other	
4. Monitor Information Manufacturer: : SO₂ Oil Mass Flow = Micromotion Model Number: SO₂ Oil Mass Flow = D300 Serial Number: SO₂ Oil Mass Flow = 141715	
6. Installation Date: 01/01/2000	6. Performance Specification Test Date: 02/13/2003
7. Continuous Monitor Comment (limit to 200 characters): SO₂ Required by 40 CFR 75.10(a)(1); SO₂ calculated according to 40 CFR 75 appendix D	

I. CONTINUOUS MONITOR INFORMATION
(Only Regulated Emissions Units Subject to Continuous Monitoring)

Continuous Monitoring System: Continuous Monitor 3 of 3

3. Parameter Code: EM	2. Pollutant(s): Visible Emissions
3. CMS Requirement: [X] Rule [] Other	
4. Monitor Information: Phoenix Instruments Model Number: OPAC 20/20 Serial Number: OPAC-1074	
7. Installation Date: 03/16/2001	6. Performance Specification Test Date: 01/08/2001
Required by 40 CFR 70.10(a)(4)	

**J. EMISSIONS UNIT SUPPLEMENTAL INFORMATION
(Regulated Emissions Units Only)**

Supplemental Requirements

1. Process Flow Diagram <input checked="" type="checkbox"/> Attached, Document ID: <u>PRVU1-1.bmp</u> <input type="checkbox"/> Not Applicable <input type="checkbox"/> Waiver Requested
2. Fuel Analysis or Specification <input checked="" type="checkbox"/> Attached, Document ID: <u>PRVU1-2.txt</u> <input type="checkbox"/> Not Applicable <input type="checkbox"/> Waiver Requested
3. Detailed Description of Control Equipment <input checked="" type="checkbox"/> Attached, Document ID: <u>PRVU1-3.txt</u> <input type="checkbox"/> Not Applicable <input type="checkbox"/> Waiver Requested
4. Description of Stack Sampling Facilities <input checked="" type="checkbox"/> Attached, Document ID: <u>PRVU1-4.bmp</u> <input type="checkbox"/> Not Applicable <input type="checkbox"/> Waiver Requested
5. Compliance Test Report <input type="checkbox"/> Attached, Document ID: _____ <input checked="" type="checkbox"/> Previously submitted to FDEP Southeast District for Annual Compliance Demonstration <input type="checkbox"/> Not Applicable
6. Procedures for Startup and Shutdown <input checked="" type="checkbox"/> Attached, Document ID <u>PRVU1-6.txt</u> <input type="checkbox"/> Not Applicable <input type="checkbox"/> Waiver Requested
7. Operation and Maintenance Plan <input type="checkbox"/> Attached, Document ID: _____ <input checked="" type="checkbox"/> Not Applicable <input type="checkbox"/> Waiver Requested
8. Supplemental Information for Construction Permit Application <input type="checkbox"/> Attached, Document ID: _____ <input checked="" type="checkbox"/> Not Applicable
9. Other Information Required by Rule or Statute <input type="checkbox"/> Attached, Document ID: _____ <input checked="" type="checkbox"/> Not Applicable
10. Supplemental Requirements Comment:

Additional Supplemental Requirements for Title V Air Operation Permit Applications

11. Alternative Methods of Operation [X] Attached, Document ID: <u>PRVU1-11.txt</u> [] Not Applicable
12. Alternative Modes of Operation (Emissions Trading) [] Attached, Document ID: _____ [X] Not Applicable
13. Identification of Additional Applicable Requirements [X] Attached, Document ID: <u>PRVU1-13.txt</u> [] Not Applicable
14. Compliance Assurance Monitoring Plan [] Attached, Document ID: _____ [X] Not Applicable
15. Acid Rain Part Application (Hard-copy Required) [X] Acid Rain Part - Phase II (Form No. 62-210.900(1)(a)) Attached, Document ID: <u>PRVU1-15.txt</u> [] Repowering Extension Plan (Form No. 62-210.900(1)(a)1.) Attached, Document ID: _____ [] New Unit Exemption (Form No. 62-210.900(1)(a)2.) Attached, Document ID: _____ [] Retired Unit Exemption (Form No. 62-210.900(1)(a)3.) Attached, Document ID: _____ [] Phase II NOx Compliance Plan (Form No. 62-210.900(1)(a)4.) Attached, Document ID: _____ [] Phase NOx Averaging Plan (Form No. 62-210.900(1)(a)5.) Attached, Document ID: _____ [] Not Applicable

III. EMISSIONS UNIT INFORMATION

A separate Emissions Unit Information Section (including subsections A through J as required) must be completed for each emissions unit addressed in this Application for Air Permit. If submitting the application form in hard copy, indicate, in the space provided at the top of each page, the number of this Emissions Unit Information Section and the total number of Emissions Unit Information Sections submitted as part of this application.

**A. GENERAL EMISSIONS UNIT INFORMATION
(All Emissions Units)**

Emissions Unit Description and Status

<p>1. Type of Emissions Unit Addressed in This Section: (Check one)</p> <p><input checked="" type="checkbox"/> This Emissions Unit Information Section addresses, as a single emissions unit, a single process or production unit, or activity, which produces one or more air pollutants and which has at least one definable emission point (stack or vent).</p> <p><input type="checkbox"/> This Emissions Unit Information Section addresses, as a single emissions unit, a group of process or production units and activities which has at least one definable emission point (stack or vent) but may also produce fugitive emissions.</p> <p><input type="checkbox"/> This Emissions Unit Information Section addresses, as a single emissions unit, one or more process or production units and activities which produce fugitive emissions only.</p>			
<p>2. Regulated or Unregulated Emissions Unit? (Check one)</p> <p><input checked="" type="checkbox"/> The emissions unit addressed in this Emissions Unit Information Section is a regulated emissions unit.</p> <p><input type="checkbox"/> The emissions unit addressed in this Emissions Unit Information Section is an unregulated emissions unit.</p>			
<p>4. Description of Emissions Unit Addressed in This Section (limit to 60 characters): Fossil Fuel Fired Steam Generator # 4</p>			
<p>4. Emissions Unit Identification Number: <input type="checkbox"/> No ID</p> <p>ID: 04 <input type="checkbox"/> ID Unknown</p>			
<p>5. Emissions Unit Status Code: A</p>	<p>6. Initial Startup Date: 03/1963</p>	<p>7. Emissions Unit Major Group SIC Code: 49</p>	<p>8. Acid Rain Unit? [Y]</p>
<p>10. Emissions Unit Comment: (Limit to 500 Characters) Emission Unit 04 (Riviera Unit 4) is a nominal 310 MW(electrical) steam generator fired on Natural Gas or using No.2 or No.6 fuel oil and consists of a boiler/steam generator driving a single reheat turbine generator.</p>			

Emissions Unit Control Equipment

2. Control Equipment/Method Description (Limit to 200 characters per device or method):

- A = Multiple Cyclone w/o Fly Ash Reinjection**
- B = Low NOx Burners**
- C = Staged Combustion**

2. Control Device or Method Code(s): **077, 024, 025**

Emissions Unit Details

1. Package Unit:	
Manufacturer: Foster-Wheeler	Model Number: N/A
2. Generator Nameplate Rating:	310 MW
3. Incinerator Information:	
Dwell Temperature:	°F
Dwell Time:	seconds
Incinerator Afterburner Temperature:	°F

**B. EMISSIONS UNIT CAPACITY INFORMATION
(Regulated Emissions Units Only)**

Emissions Unit Operating Capacity and Schedule

1. Maximum Heat Input Rate:	3,260	mmBtu/hr
2. Maximum Incineration Rate:	lb/hr	tons/day
3. Maximum Process or Throughput Rate:		
4. Maximum Production Rate:		
5. Requested Maximum Operating Schedule:		
	hours/day	days/week
	weeks/year	8760 hours/year
7. Operating Capacity/Schedule Comment (limit to 200 characters): Maximum Heat Input Rate based on firing 100% Natural Gas provided as a permitting note for purpose of particulate testing information when applicable. The maximum heat input when firing fuel oil is 3,050 MMBtu/hr.		

**C. EMISSIONS UNIT REGULATIONS
(Regulated Emissions Units Only)**

List of Applicable Federal Regulations

40 CFR 279.72, Analysis and Records	On-Specification Used Oil
40 CFR 72.9 (a), Acid Rain Permits	Permit requirements
40 CFR 72.9 (b), Acid Rain Permits	Monitoring Requirements
40 CFR 72.9 (c)(1), Acid Rain Permits	SO2 Allowance Requirements - Holding
40 CFR 72.9 (c)(2), Acid Rain Permits	SO2 Allowance - Excess Emissions Violations
40 CFR 72.9 (c)(3)(iii), Acid Rain Permits	SO2 Allowance - Phase II Unit applicability
40 CFR 72.9 (c)(4), Acid Rain Permits	SO2 Allowance Tracking System Accounts
40 CFR 72.9 (c)(5), Acid Rain Permits	SO2 Allowance Year of Use Requirement
40 CFR 72.9 (d), Acid Rain Permits	NOx Requirements
40 CFR 72.9 (e), Acid Rain Permits	Excess Emission Requirements & Offsets
40 CFR 72.9 (f), Acid Rain Permits	Recordkeeping and Reporting
40 CFR 72.9 (g), Acid Rain Permits	Liability and Civil Penalty
40 CFR 72.20 (a), Acid Rain Permits	Designated Representative Requirement
40 CFR 72.20 (b), Acid Rain Permits	Designated Representative Legal Binding
40 CFR 72.20 (c), Acid Rain Permits	Designated Representative Certification
40 CFR 72.21, Acid Rain Permits	Submissions by Designated Representative
40 CFR 72.22, Acid Rain Permits	Alternate Designated Representative Requirement
40 CFR 72.23, Acid Rain Permits	Changing Designated Representatives or Owners
40 CFR 72.24, Acid Rain Permits	Designated Representative Certificate of Representation

**C. EMISSIONS UNIT REGULATIONS
(Regulated Emissions Units Only)**

List of Applicable Federal Regulations

40 CFR 72.30 (a), Acid Rain Permits	Acid Rain Permit Duty to Apply
40 CFR 72.30 (b) (2), Acid Rain Permits	Acid Rain Permit Requirements to apply for Phase II
40 CFR 72.30 (c), Acid Rain Permits	Acid Rain Permit Renewal application prior to Permit Expiration
40 CFR 72.30 (d), Acid Rain Permits	Acid Rain Permit Submittal Requirements
40 CFR 72.31, Acid Rain Permits	Acid Rain Permit Information Requirements
40 CFR 72.32, Acid Rain Permits	Permit Application Shield
40 CFR 72.33 (b), Acid Rain Permits	Identification of Dispatch System
40 CFR 72.33 (c), Acid Rain Permits	Dispatch System Requirements
40 CFR 72.33 (d), Acid Rain Permits	Changing Dispatch System Identification
40 CFR 72.40, Acid Rain Permits	Compliance Plan Application Requirements
40 CFR 72.50, Acid Rain Permits	General Permit Requirements
40 CFR 72.51, Acid Rain Permits	Permit Shield
40 CFR 72.90, Acid Rain Permits	Annual Compliance Certification
40 CFR 73.30, SO2 Allowance System	Allowance Tracking System Accounts
40 CFR 73.31, SO2 Allowance System	Establishment of Accounts
40 CFR 73.32, SO2 Allowance System	Allowance Account Contents
40 CFR 73.33, SO2 Allowance System	Authorized Account Representative
40 CFR 73.35 (a), SO2 Allowance System	Compliance and Allowance Transfer Deadline
40 CFR 73.35 (b), SO2 Allowance System	Allowance Deductions for Compliance

**C. EMISSIONS UNIT REGULATIONS
(Regulated Emissions Units Only)**

List of Applicable Federal Regulations

40 CFR 73.35 (c), SO2 Allowance System	Identification of Allowances by Serial Number
40 CFR 73.35 (d), SO2 Allowance System	Deductions for Excess Emissions
40 CFR 75.4, CEMS	Compliance Dates
40 CFR 75.5, CEMS	Prohibitions
40 CFR 75.10 (a) (1), CEMS	Primary Measurement - SO2
40 CFR 75.10 (a) (2), CEMS	Primary Measurement - NOx
40 CFR 75.10 (a) (3) (iii), CEMS	Primary Measurement - CO2 & O2 Monitor
40 CFR 75.10 (b), CEMS	Primary Equipment Performance Requirements
40 CFR 75.10 (c), CEMS	Heat Input Measurement Requirement
40 CFR 75.10 (e), CEMS	Optional Backup Monitor Requirements
40 CFR 75.10 (f), CEMS	Minimum Measurement Capability
40 CFR 75.11 (d), CEMS	SO2 Emission Monitoring Requirements for Gas-Fired Units
40 CFR 75.11 (e), CEMS	SO2 Emissions Monitoring Gas-Fired Units
40 CFR 75.12 (a), CEMS	NOx Monitoring
40 CFR 75.12 (b), CEMS	NOx Monitoring Moisture Correction
40 CFR 75.12 (c), CEMS	NOx Monitoring Determination of NOx Emission Rate - Appendix F
40 CFR 75.13 (b), CEMS	CO2 Emissions Monitoring Appendix G
40 CFR 75.13 (c), CEMS	CO2 Mass Emissions Monitoring Appendix F
40 CFR 75.14 (c), CEMS	Opacity Monitoring Gas Unit Exemption

**C. EMISSIONS UNIT REGULATIONS
(Regulated Emissions Units Only)**

List of Applicable Federal Regulations

40 CFR 75.20 (a), CEMS	Initial Certification & Loss of Certification
40 CFR 75.20 (b), CEMS	Recertification Approval Process
40 CFR 75.20 (c), CEMS	Certification Procedures
40 CFR 75.20 (d), CEMS	Certification and QA/QC for Backup Monitors
40 CFR 75.20 (f), CEMS	Certification of Alternative Monitoring Systems
40 CFR 75.21 (a), CEMS	CEMS QA/QC
40 CFR 75.21 (c), CEMS	Calibration Gasses for CEMS QA/QC
40 CFR 75.21 (d), CEMS	QA/QC RATA Periodic Notification
40 CFR 75.21 (e), CEMS	QA/QC Audit Consequences
40 CFR 75.22 , CEMS	Reference Test Methods
40 CFR 75.24 , CEMS	Out of Control Periods and Bias Adjustment
40 CFR 75.30 (a)(3) , CEMS	NOx Missing Data Substitution Procedures
40 CFR 75.30 (a)(4) , CEMS	SO2 Missing Data Substitution Procedures
40 CFR 75.30 (b) , CEMS	Missing Data Substitution Procedures for Backup Monitors
40 CFR 75.30 (c) , CEMS	Missing Data Substitution using Backup Monitors
40 CFR 75.30 (d) , CEMS	SO2 Missing Data Substitution - Gas Units
40 CFR 75.31 , CEMS	Initial Missing Data Procedures
40 CFR 75.32 , CEMS	Monitoring Data Availability for Missing Data
40 CFR 75.33 , CEMS	Standard Missing Data Procedures

**C. EMISSIONS UNIT REGULATIONS
(Regulated Emissions Units Only)**

List of Applicable Federal Regulations

40 CFR 75.36 , CEMS	Missing Data for Heat Input
40 CFR 75.40 , CEMS	Alternate Monitoring Systems General Demonstration Requirements
40 CFR 75.41 , CEMS	Alternate Monitoring Systems Precision Criteria
40 CFR 75.42 , CEMS	Alternate Monitoring Systems Reliability Criteria
40 CFR 75.43 , CEMS	Alternate Monitoring Systems Accessibility Criteria
40 CFR 75.44 , CEMS	Alternate Monitoring Systems Timeliness Criteria
40 CFR 75.45 , CEMS	Alternate Monitoring Systems Daily QA
40 CFR 75.46 , CEMS	Alternate Monitoring Systems Missing Data Substitution Criteria
40 CFR 75.47 , CEMS	Alternate Monitoring Systems Criteria For a Class of Affected Unit
40 CFR 75.48 , CEMS	Petition for Alternate Monitoring Systems
40 CFR 75.53 , CEMS	Monitoring Plan
40 CFR 75.54 , CEMS	General Recordkeeping Provisions
40 CFR 75.55 (c) , CEMS	Specific Recordkeeping Provisions - Fired units using SO2 Appendix D Gas
40 CFR 75.55 (e) , CEMS	Specific Recordkeeping Provisions -SO2 for Gas Fired units
40 CFR 75.56 , CEMS	Certification, QA/QC record Provisions
40 CFR 75.57 , CEMS	General Recordkeeping Provisions
40 CFR 75.58 (c) , CEMS	Specific Recordkeeping Provisions - Fired units using SO2 Appendix D Gas
40 CFR 75.58 (e) , CEMS	Specific Recordkeeping Provisions -SO2 for Gas Fired units
40 CFR 75.59 , CEMS	Certification, QA/QC record Provisions

**C. EMISSIONS UNIT REGULATIONS
(Regulated Emissions Units Only)**

List of Applicable Federal Regulations

40 CFR 75.60 , CEMS	General Reporting Requirements
40 CFR 75.61 , CEMS	Reporting Requirements Notifications
40 CFR 75.62 , CEMS	Monitoring Plan Reporting Requirements
40 CFR 75.63 , CEMS	Certification Reporting Requirements
40 CFR 75.64 (a) , CEMS	Quarterly Reports Submission
40 CFR 75.64 (b) , CEMS	Quarterly Reports Designated Representative Statement
40 CFR 75.64 (c) , CEMS	Quarterly Reports Compliance Certification
40 CFR 75.64 (d) , CEMS	Quarterly Reports Electronic Submittal
40 CFR 75.66 , CEMS	Petitions to the Administrator (if required)
40 CFR Part 75 - Appendix A-1	Installation and Measurement Locations
40 CFR Part 75 - Appendix A-2	Equipment Specifications
40 CFR Part 75 - Appendix A-3	Performance Specifications
40 CFR Part 75 - Appendix A-4	Data Handling and Acquisition Systems
40 CFR Part 75 - Appendix A-5	Calibration Gasses
40 CFR Part 75 - Appendix A-6	Certification Tests and Procedures
40 CFR Part 75 - Appendix A-7	Calculations
40 CFR Part 75 - Appendix B	QA/QC Procedures
40 CFR Part 75 - Appendix C-1	Missing Data; SO ₂ & NO _x for controlled sources
40 CFR Part 75 - Appendix C-2	Missing Data ; Load Based Procedure; NO _x & Flow

**C. EMISSIONS UNIT REGULATIONS
(Regulated Emissions Units Only)**

List of Applicable Federal Regulations

40 CFR Part 75 - Appendix D	Optional SO2 Emissions Protocol for Gas Fired Units
40 CFR Part 75 - Appendix F	Conversion Procedures
40 CFR Part 75 - Appendix G-2	Conversion Procedures
40 CFR Part 75 - Appendix G-4	Conversion Procedures
40 CFR Part 75 - Appendix H	Conversion Procedures
40 CFR 77.3 , Excess Emissions	Future SO2 Offset Plans
40 CFR 77.5 (b) , Excess Emissions	Future Deduction of SO2 Allowances for Excess SO2 Emissions
40 CFR 77.6 , Excess Emissions	Future Penalties for Excess Emissions of SO2 and NOx
FAC 62-204.800(12) (State Only)	Acid Rain Program
FAC 62-204.800(13) (State Only)	Allowances
FAC 62-204.800(14) (State Only)	Acid Rain Program Monitoring
FAC 62-204.800(16) (State Only)	Excess Emissions
FAC 62-210.650, Stationary Sources	Circumvention; EU's with control device
FAC 62-210.700 (1), Stationary Sources	Excess Emissions
FAC 62-210.700 (4), Stationary Sources	Excess Emissions & Poor Maintenance
FAC 62-210.700 (6), Stationary Sources	Excess Emissions Notification
FAC 62-210.300, Acid Rain	Acid Rain Unit Applicability
FAC 62-210.320 (1)(a),(2), Acid Rain	Acid Rain Unit Application Shield
FAC 62-210.330 (1)(a)1., Acid Rain	Acid Rain Unit Compliance Options

**C. EMISSIONS UNIT REGULATIONS
(Regulated Emissions Units Only)**

List of Applicable State Regulations

FAC 62-210.340 , Acid Rain	New and Retired Unit Exemptions
FAC 62-210.350(2);(3);(6) , Acid Rain	Acid Rain Unit Certification
FAC 62-210.370 , Acid Rain	Acid Rain Unit Revisions & Corrections
FAC 62-210.430, Acid Rain	Compliance Options for Acid Rain Units
FAC 62-296.405(1), Existing FFSG	PM and SO2 Limits
FAC 62-296.570(4)(b)3	NOx RACT
FAC 62-297.310(1), Emiss. Monitoring	Test Runs - Mass Emissions
FAC 62-297.310(2)(b), Emiss. Monitoring	Operating Rate
FAC 62-297.310(3), Emiss. Monitoring	Calculation of Emissions
Table 62-297.310-1, Emiss. Monitoring	
FAC 62-297.310(7)(a)9, Emiss. Monitoring	FDEP Notification 15 days prior to tests
FAC 62-297.310(7)(c), Emiss. Monitoring	Waiver for Compliance Tests for Fuel Sampling

D. EMISSION POINT (STACK/VENT) INFORMATION
(Regulated Emissions Units Only)

Emission Point Description and Type

1. Identification of Point on Plot Plan or Flow Diagram? Unit 4 boiler		4. Emission Point Type Code: 1	
5. Descriptions of Emission Points Comprising this Emissions Unit for VE Tracking (limit to 100 characters per point): Unit exhaust through single stack			
4. ID Numbers or Descriptions of Emission Units with this Emission Point in Common:			
6. Discharge Type Code: V	6. Stack Height: 298 feet	7. Exit Diameter: 16 feet	
8. Exit Temperature: 263 °F	9. Actual Volumetric Flow Rate: 1,063,401.3	10. Water Vapor: %	
11. Maximum Dry Standard Flow Rate: dscfm		12. Nonstack Emission Point Height: feet	
13. Emission Point UTM Coordinates: Zone: 17 East (km): 594.187 North (km): 2960.803			
14. Emission Point Comment (limit to 200 characters): Values for fields 8 and 9 derived from compliance tests (EPA Method 17) at approximately 90% max. heat input. (February, 1994)			

E. SEGMENT (PROCESS/FUEL) INFORMATION
(All Emissions Units)

Segment Description and Rate: Segment 1 of 7

1. Segment Description (Process/Fuel Type) (limit to 500 characters): Unit 4 Firing Natural Gas		
3. Source Classification Code (SCC): 1-01-006-01		3. SCC Units: Million Cubic Feet
4. Maximum Hourly Rate: 3.1	6. Maximum Annual Rate: 27,197.7	6. Estimated Annual Activity Factor:
7. Maximum % Sulfur: 0.0031	8. Maximum % Ash:	10. Million Btu per SCC Unit: 1,050
10. Segment Comment (limit to 200 characters): $\%S = [10\text{gr of S}/1000 \text{ CF gas}] * [1 \text{ lb S}/7000 \text{ gr}] [\text{CF gas}/0.046 \text{ lb gas}] * 100 = 0.0031\%S$		

Segment Description and Rate: Segment 2 of 7

1. Segment Description (Process/Fuel Type) (limit to 500 characters): Unit 4 Firing No. 6 Residual Fuel Oil		
3. Source Classification Code (SCC): 1-01-004-01		3. SCC Units: Thousand Gallons
6. Maximum Hourly Rate: 20.07	7. Maximum Annual Rate: 175,776.3	6. Estimated Annual Activity Factor: %
8. Maximum % Sulfur: 2.5	11. Maximum % Ash: 0.1	12. Million Btu per SCC Unit: 152
13. Segment Comment (limit to 200 characters): This emission unit may burn up to 2.5% sulfur oil .		

**E. SEGMENT (PROCESS/FUEL) INFORMATION
(All Emissions Units)**

Segment Description and Rate: Segment 3 of 7

1. Segment Description (Process/Fuel Type) (limit to 500 characters): Unit 4 Firing Propane		
3. Source Classification Code (SCC): 1-01-006-01		3. SCC Units: Million Cubic Feet
4. Maximum Hourly Rate: 3.26	6. Maximum Annual Rate: 28,557.6	6. Estimated Annual Activity Factor:
7. Maximum % Sulfur:	8. Maximum % Ash:	10. Million Btu per SCC Unit: 1,000
10. Segment Comment (limit to 200 characters): Unit 4 is currently permitted to burn a mixture of natural gas, No. 6 oil, No. 2 oil, propane, or on-spec. used oil from FPL operations. Propane is primarily used for lighting off the boiler for start-up.		

Segment Description and Rate: Segment 4 of 7

1. Segment Description (Process/Fuel Type) (limit to 500 characters): Unit 4 Firing No. 2 Fuel Oil		
3. Source Classification Code (SCC): 1-01-005-01		3. SCC Units: Thousand Gallons
6. Maximum Hourly Rate: 22.43	7. Maximum Annual Rate: 196,455.9	6. Estimated Annual Activity Factor: %
9. Maximum % Sulfur: 0.5	10. 8. Maximum % Ash: 0.01	11. Million Btu per SCC Unit: 136
12. Segment Comment (limit to 200 characters): Unit 4 is currently permitted to burn a mixture of natural gas, No. 6 oil, No. 2 oil, propane, or on-spec. used oil from FPL operations. No. 2 oil is primarily used for during boiler for start-up.		

**E. SEGMENT (PROCESS/FUEL) INFORMATION
(All Emissions Units)**

Segment Description and Rate: Segment 5 of 7

1. Segment Description (Process/Fuel Type) (limit to 500 characters): Unit 4 Co-Firing On-Specification Used Oil from FPL Operations		
4. Source Classification Code (SCC): 1-01-013-01		3. SCC Units: Thousand Gallons
4. Maximum Hourly Rate: 22.43	6. Maximum Annual Rate: 1,500	6. Estimated Annual Activity Factor:
7. Maximum % Sulfur: 2.5	9. Maximum % Ash:	10. Million Btu per SCC Unit:
10. Segment Comment (limit to 200 characters): The maximum annual rate of on-specification used oil burned in the Riviera boiler Unit 4 is based on limit for both units (Condition A.37.b of current Title V permit).		

Segment Description and Rate: Segment 6 of 7

1. Segment Description (Process/Fuel Type) (limit to 500 characters): Unit 4 Co-Firing all possible combinations of Natural Gas, No. 6 Residual Oil, No. 2 Fuel Oil, On-Spec. Used Oil, and Propane		
3. Source Classification Code (SCC): 1-01-006-01		3. SCC Units: Million Cubic Ft. and Thousand Gallons
6. Maximum Hourly Rate: 20.07	7. Maximum Annual Rate: 175,776.3	6. Estimated Annual Activity Factor: %
8. Maximum % Sulfur: 2.5	11. Maximum % Ash: 0.1	12. Million Btu per SCC Unit: 152
13. Segment Comment (limit to 200 characters): Unit 4 is permitted to burn a mixture of nat. gas, No.6 oil, No.2 oil, propane , or on-spec. used oil. Permit allows Unit 4 to burn a mixture of the above fuels provided max. SO2 rate is 2.75 lbs/mmBtu.		

E. SEGMENT (PROCESS/FUEL) INFORMATION
(All Emissions Units)

Segment Description and Rate: Segment 7 of 7

1. Segment Description (Process/Fuel Type) (limit to 500 characters): Unit 4 Boiler Chemical Cleaning waste evaporation. This process may be undertaken while firing natural gas or residual oil		
4. Source Classification Code (SCC): 1-01-013-01		5. SCC Units: Thousand Gallons
6. Maximum Hourly Rate: 3	7. Maximum Annual Rate: 500	6. Estimated Annual Activity Factor:
9. Maximum % Sulfur:	10. Maximum % Sulfur:	9. Million Btu per SCC Unit:
11. Segment Comment (limit to 200 characters): Items 6 - 9 do not apply. This activity to be undertaken on a periodic basis in accordance with DARM guidance, and EPA waste rules (40 CFR 279.72)		

**F. EMISSIONS UNIT POLLUTANTS
(All Emissions Units)**

1. Pollutant Emitted	2. Primary Control Device Code	3. Secondary Control Device Code	4. Pollutant Regulatory Code
PM	077		EL
SO2			EL
NOx	024, 025		EL
CO			NS
VOC			NS
PM10			NS
H133			NS
SAM			NS
H106			NS
H107			NS

G. EMISSIONS UNIT POLLUTANT DETAIL INFORMATION
(Regulated Emissions Units -
Emissions-Limited and Preconstruction Review Pollutants Only)

Potential/Fugitive Emissions

1. Pollutant Emitted: PM		2. Total Percent Efficiency of Control:	
3. Potential Emissions: 381.25lb/hour		4. Synthetically Limited? [NO]	
		1,669.88 tons/year	
5. Range of Estimated Fugitive Emissions: <input type="checkbox"/> 1 <input type="checkbox"/> 2 <input type="checkbox"/> 3 _____ to _____ tons/year			
6. Emission Factor: 0.125 lb/mmBtu Reference: DEP Rule 62-296.405(1)(b) and Rule 62-210.700(3)		10. Emissions Method Code: 0	
11. Calculation of Emissions (limit to 600 characters): 0.125 lb/mmBtu * 3,050 mmBtu/hr = 381.25 lb/hr (381.25 lb/hr * 8760 hr/yr) / 2000 lb/ton = 1,669.88 tons/yr			
12. Pollutant Potential/Fugitive Emissions Comment (limit to 200 characters): Emission rate based on 3hrs/24hrs at 0.3 lb/mmBtu and 21hrs/24hrs at 0.1 lb/mmBtu which is equivalent to a rate of 0.125 lb/mmBtu			

Allowable Emissions Allowable Emissions 1 of 3

1. Basis for Allowable Emissions Code: Required or assumed by permittee		2. Future Effective Date of Allowable Emissions:	
5. Requested Allowable Emissions and Units: 0.2 lb/mmBtu steady state (ss) 0.3 lb/mmBtu sootblow (sb)		4. Equivalent Allowable Emissions: 305 lb/hour 1,168.9 tons/year (ss) 915 lb/hour 501 tons/year (sb)	
5. Method of Compliance (limit to 60 characters): DEP Rule 62-296.405(1)(e)2			
6. Allowable Emissions Comment (Desc. of Operating Method) (limit to 200 characters): 0.1 lb/mmBtu = reg. Limit for PM [Rule 62-296.340(1)(e)], 0.3 lb/mmBtu = reg. Limit for sootblow based on 3hr/24hr limit [62-210.700(3)]. Emissions based on 100% oil.			

**G. EMISSIONS UNIT POLLUTANT DETAIL INFORMATION
(Regulated Emissions Units -
Emissions-Limited and Preconstruction Review Pollutants Only)**

Potential/Fugitive Emissions

1. Pollutant Emitted: SO2		2. Total Percent Efficiency of Control:	
3. Potential Emissions: 8,387.5lb/hour		4. Synthetically Limited? [N] 36,737.25 tons/year	
5. Range of Estimated Fugitive Emissions: [] 1 [] 2 [] 3 _____ to _____ tons/year			
6. Emission Factor: 2.75 lb/mmBtu; Reference: DEP Rule 62-296.405(1)(c)1.j.		10. Emissions Method Code: 0	
11. Calculation of Emissions (limit to 600 characters): 3,050 mmBtu/hr * 2.75 lb/mmBtu = 8,387.5 lb/hr (8,387.5 lb/hr * 8760 hr/yr) / 2000 lb/ton = 36,737.25 ton/yr			
12. Pollutant Potential/Fugitive Emissions Comment (limit to 200 characters): This emission unit is limited to firing 2.5% sulfur oil while firing 100% oil and is limited by DEP Rule 62-296.405(1)(c)1.j.			

Allowable Emissions Allowable Emissions 2 of 3

1. Basis for Allowable Emissions Code: Required or assumed by permittee		2. Future Effective Date of Allowable Emissions:	
4. Requested Allowable Emissions and Units: 2.75 lb/mmBtu		4. Equivalent Allowable Emissions: 8,387.5 lb/hour 36,737.25 tons/year	
5. Method of Compliance (limit to 60 characters): Fuel Specifications and vendor sampling and analysis			
6. Allowable Emissions Comment (Desc. of Operating Method) (limit to 200 characters): Equivalent allowable emissions for liquid fuel firing. This unit is subject to DEP Rule 62-296.405(1)(c)1.j.			

**G. EMISSIONS UNIT POLLUTANT DETAIL INFORMATION
(Regulated Emissions Units -
Emissions-Limited and Preconstruction Review Pollutants Only)**

Potential/Fugitive Emissions

1. Pollutant Emitted: NOx		2. Total Percent Efficiency of Control:	
3. Potential Emissions: 1,891 lb/hour 8,282.6 tons/year		4. Synthetically Limited? [No]	
5. Range of Estimated Fugitive Emissions: [] 1 [] 2 [] 3 to tons/year			
6. Emission Factor: 0.5 lb/mmBtu (gas); 0.62 lb/mmBtu (oil) Reference: DEP Rule 62-296.570(4)(a)4 and (4)(b)3		10. Emissions Method Code: 0	
11. Calculation of Emissions (limit to 600 characters): 0.62 lb/mmBtu * 3,050 mmBtu/hr = 1,891 lb/hr (oil) (1,891 lb/hr * 8,760 hr/yr) / 2,000 lb/ton = 8,282.6 tons/year (oil) 0.5 lb/mmBtu * 3,260 mmBtu/hr = 1,630 lb/hr (gas) (1,630 lb/hr * 8,760 hr/yr) / 2,000 lb/ton = 7,139.4 tons/year (gas)			
12. Pollutant Potential/Fugitive Emissions Comment (limit to 200 characters): Emission limit calculated for oil and gas combustion.			

Allowable Emissions Allowable Emissions 3 of 3

1. Basis for Allowable Emissions Code: RULE		2. Future Effective Date of Allowable Emissions:	
5. Requested Allowable Emissions and Units: 0.5 lb/mmBtu (gas) 0.62 lb/mmBtu (oil)		4. Equivalent Allowable Emissions: gas 1,630 lb/hour 7,139.4 tons/year oil 1,891 lb/hour 8,282.6 tons/year	
5. Method of Compliance (limit to 60 characters): CEM Part 75 , 30 day rolling average Rule 62-296.570(4)(a)4			
6. Allowable Emissions Comment (Desc. of Operating Method) (limit to 200 characters): This emission unit utilizes Low NOx burners as well as off-stoichiometric combustion to control emissions of NOx.			

H. VISIBLE EMISSIONS INFORMATION
(Only Regulated Emissions Units Subject to a VE Limitation)

Visible Emissions Limitation: Visible Emissions Limitation 1 of 3

2. Visible Emissions Subtype: VE40	2. Basis for Allowable Opacity: <input checked="" type="checkbox"/> Rule <input type="checkbox"/> Other
3. Requested Allowable Opacity: Normal Conditions: 40 % Exceptional Conditions: % Maximum Period of Excess Opacity Allowed: see comment below min/hour	
6. Method of Compliance: VE Test (EPA Method 9)	
7. Visible Emissions Comment (limit to 200 characters): Visible emissions limited to 40% opacity except for allowable excess emissions	

Visible Emissions Limitation: Visible Emissions Limitation 2 of 3

3. Visible Emissions Subtype: VE60	2. Basis for Allowable Opacity: <input checked="" type="checkbox"/> Rule <input type="checkbox"/> Other
3. Requested Allowable Opacity: Normal Conditions: 100 % Exceptional Conditions: 100 % Maximum Period of Excess Opacity Allowed: 24 min/hour	
8. Method of Compliance: VE Test (EPA Method 9)	
9. Visible Emissions Comment (limit to 200 characters): FDEP Rule 62-210.700(3) allows up to 60% opacity for 3 hours/24 hour period for soot blow and load changes with < 4 six-minute periods of up to 100% opacity.	

Visible Emissions Limitation: Visible Emissions Limitation 3 of 3

4. Visible Emissions Subtype: VE99	2. Basis for Allowable Opacity: <input checked="" type="checkbox"/> Rule <input type="checkbox"/> Other
3. Requested Allowable Opacity: Normal Conditions: 100 % Exceptional Conditions: 100 % Maximum Period of Excess Opacity Allowed: 60 min/hour	
10. Method of Compliance: VE Test (EPA Method 9)	
11. Visible Emissions Comment (limit to 200 characters): FDEP Rule 62-210.700(1) & (2) allows up to 100% opacity for unlimited time during from start-up & shut-down, and 2 hours/24 hour period for malfunctions.	

I. CONTINUOUS MONITOR INFORMATION
(Only Regulated Emissions Units Subject to Continuous Monitoring)

Continuous Monitoring System: Continuous Monitor 1 of 3

4. Parameter Code: EM	2. Pollutant(s): NOx
3. CMS Requirement:	<input checked="" type="checkbox"/> Rule <input type="checkbox"/> Other
4. Monitor Information Manufacturer: : NOx = TECO CO₂ = Milton Roy Model Number: NOx = 42C CO₂ = 3300 Serial Number: NOx = 42C-77127-385 CO₂ = N3H8174T	
8. Installation Date: NOx = 02/11/2003 CO₂ = 041/01/1995	6. Performance Specification Test Date: 2/11/2003
7. Continuous Monitor Comment (limit to 200 characters): NOx Required by 40 CFR 75.10(a)(2);; CO₂ provides % O₂ data to NOx monitor per 40 CFR 75 Appendix E. CO₂ data is calculated using 40 CFR 75 Appendix G equation G-4 .	

Continuous Monitoring System: Continuous Monitor 2 of 3

5. Parameter Code: EM	2. Pollutant(s): SO₂
3. CMS Requirement:	<input checked="" type="checkbox"/> Rule <input type="checkbox"/> Other
4. Monitor Information Manufacturer: : SO₂ Oil Mass Flow = Micromotion Model Number: SO₂ Oil Mass Flow = D300 Serial Number: SO₂ Oil Mass Flow = 139441	
9. Installation Date: 01/01/2000	6. Performance Specification Test Date: 02/11/2003
7. Continuous Monitor Comment (limit to 200 characters): SO₂ Required by 40 CFR 75.10(a)(1); SO₂ calculated according to 40 CFR 75 appendix D	

I. CONTINUOUS MONITOR INFORMATION
(Only Regulated Emissions Units Subject to Continuous Monitoring)

Continuous Monitoring System: Continuous Monitor 3 of 3

6. Parameter Code: EM	2. Pollutant(s): Visible Emissions
3. CMS Requirement: <input checked="" type="checkbox"/> Rule <input type="checkbox"/> Other	
4. Monitor Information: Phoenix Instruments Model Number: OPAC 20/20 Serial Number: OPAC-1075	
10. Installation Date: 03/26/2001	6. Performance Specification Test Date: 04/12/2001
Required by 40 CFR 70.10(a)(4)	

**J. EMISSIONS UNIT SUPPLEMENTAL INFORMATION
(Regulated Emissions Units Only)**

Supplemental Requirements

1. Process Flow Diagram <input checked="" type="checkbox"/> Attached, Document ID: <u>PRVU2-1.bmp</u> <input type="checkbox"/> Not Applicable <input type="checkbox"/> Waiver Requested
2. Fuel Analysis or Specification <input checked="" type="checkbox"/> Attached, Document ID: <u>PRVU1-2.txt</u> <input type="checkbox"/> Not Applicable <input type="checkbox"/> Waiver Requested
3. Detailed Description of Control Equipment <input checked="" type="checkbox"/> Attached, Document ID: <u>PRVU1-3.txt</u> <input type="checkbox"/> Not Applicable <input type="checkbox"/> Waiver Requested
4. Description of Stack Sampling Facilities <input checked="" type="checkbox"/> Attached, Document ID: <u>PRVU1-4.bmp</u> <input type="checkbox"/> Not Applicable <input type="checkbox"/> Waiver Requested
5. Compliance Test Report <input type="checkbox"/> Attached, Document ID: _____ <input checked="" type="checkbox"/> Previously submitted <u>to FDEP Southeast District for Annual Compliance Demonstration</u> <input type="checkbox"/> Not Applicable
6. Procedures for Startup and Shutdown <input checked="" type="checkbox"/> Attached, Document ID <u>PRVU1-6.txt</u> <input type="checkbox"/> Not Applicable <input type="checkbox"/> Waiver Requested
7. Operation and Maintenance Plan <input type="checkbox"/> Attached, Document ID: _____ <input checked="" type="checkbox"/> Not Applicable <input type="checkbox"/> Waiver Requested
8. Supplemental Information for Construction Permit Application <input type="checkbox"/> Attached, Document ID: _____ <input checked="" type="checkbox"/> Not Applicable
9. Other Information Required by Rule or Statute <input type="checkbox"/> Attached, Document ID: _____ <input checked="" type="checkbox"/> Not Applicable
10. Supplemental Requirements Comment:

Additional Supplemental Requirements for Title V Air Operation Permit Applications

11. Alternative Methods of Operation [X] Attached, Document ID: <u>PRVU1-11.txt</u> [] Not Applicable
12. Alternative Modes of Operation (Emissions Trading) [] Attached, Document ID: _____ [X] Not Applicable
13. Identification of Additional Applicable Requirements [X] Attached, Document ID: <u>PRVU1-13.txt</u> [] Not Applicable
14. Compliance Assurance Monitoring Plan [] Attached, Document ID: _____ [X] Not Applicable
15. Acid Rain Part Application (Hard-copy Required) [X] Acid Rain Part - Phase II (Form No. 62-210.900(1)(a)) Attached, Document ID: <u>PRVU1-15</u> [] Repowering Extension Plan (Form No. 62-210.900(1)(a)1.) Attached, Document ID: _____ [] New Unit Exemption (Form No. 62-210.900(1)(a)2.) Attached, Document ID: _____ [] Retired Unit Exemption (Form No. 62-210.900(1)(a)3.) Attached, Document ID: _____ [] Phase II NOx Compliance Plan (Form No. 62-210.900(1)(a)4.) Attached, Document ID: _____ [] Phase NOx Averaging Plan (Form No. 62-210.900(1)(a)5.) Attached, Document ID: _____ [] Not Applicable

Emissions Unit Information Section : Unregulated Emission Units

III. EMISSIONS UNIT INFORMATION

A separate Emissions Unit Information Section (including subsections A through J as required) must be completed for each emissions unit addressed in this Application for Air Permit. If submitting the application form in hard copy, indicate, in the space provided at the top of each page, the number of this Emissions Unit Information Section and the total number of Emissions Unit Information Sections submitted as part of this application.

**A. GENERAL EMISSIONS UNIT INFORMATION
(All Emissions Units)**

Emissions Unit Description and Status

<p>1. Type of Emissions Unit Addressed in This Section: (Check one)</p> <p><input type="checkbox"/> This Emissions Unit Information Section addresses, as a single emissions unit, a single process or production unit, or activity, which produces one or more air pollutants and which has at least one definable emission point (stack or vent).</p> <p><input checked="" type="checkbox"/> This Emissions Unit Information Section addresses, as a single emissions unit, a group of process or production units and activities which has at least one definable emission point (stack or vent) but may also produce fugitive emissions.</p> <p><input type="checkbox"/> This Emissions Unit Information Section addresses, as a single emissions unit, one or more process or production units and activities which produce fugitive emissions only.</p>			
<p>2. Regulated or Unregulated Emissions Unit? (Check one)</p> <p><input type="checkbox"/> The emissions unit addressed in this Emissions Unit Information Section is a regulated emissions unit.</p> <p><input checked="" type="checkbox"/> The emissions unit addressed in this Emissions Unit Information Section is an unregulated emissions unit.</p>			
<p>3. Description of Emissions Unit Addressed in This Section (limit to 60 characters): Unregulated Emission Units</p>			
<p>4. Emissions Unit Identification Number: <input type="checkbox"/> No ID</p> <p>ID: xxx <input checked="" type="checkbox"/> ID Unknown</p>			
<p>5. Emissions Unit Status Code: A</p>	<p>6. Initial Startup Date:</p>	<p>7. Emissions Unit Major Group SIC Code: 49</p>	<p>8. Acid Rain Unit? [N]</p>
<p>9. Emissions Unit Comment: (Limit to 500 Characters)</p> <p>Emission unit comprises all unregulated sources at the Riviera facility including the emergency diesel generator. Attachment PRV-FW presents a list of all sources included in this emission unit.</p>			

Emissions Unit Information Section : Unregulated Emission Units

Emissions Unit Control Equipment

1. Control Equipment/Method Description (Limit to 200 characters per device or method):

2. Control Device or Method Code(s):

Emissions Unit Details

1. Package Unit: Detroit Diesel		
Manufacturer:	Model Number: 7124-0300 & 7124-9300	
2. Generator Nameplate Rating:	0.5	MW
3. Incinerator Information:		
Dwell Temperature:		°F
Dwell Time:		seconds
Incinerator Afterburner Temperature:		°F

Emissions Unit Information Section : Unregulated Emission Units

**B. EMISSIONS UNIT CAPACITY INFORMATION
(Regulated Emissions Units Only)**

Emissions Unit Operating Capacity and Schedule

1. Maximum Heat Input Rate:	7.34 mmBtu/hr	
2. Maximum Incineration Rate:	lb/hr	tons/day
3. Maximum Process or Throughput Rate:		
4. Maximum Production Rate:		
5. Requested Maximum Operating Schedule:	hours/day	days/week
	weeks/year	8760 hours/year
6. Operating Capacity/Schedule Comment (limit to 200 characters): Information provided is for the emergency diesel generator which will be limited to 400 operating hours/year. Various other sources within this emission unit may operate up to 8760 hours/year.		

Emissions Unit Information Section : Unregulated Emission Units

C. EMISSIONS UNIT REGULATIONS
(Regulated Emissions Units Only)

List of Applicable State Regulations

F.A.C. 62-210.300(3)(a)20.	F.A.C. 62-210.700(1)
F.A.C. 62-210.700(4)	F.A.C. 62-210.700(5)
F.A.C. 62-210.700(6)	F.A.C. 62-297.310(2)(a)
F.A.C. 62-297.310(2)(b)	F.A.C. 62-297.310(4)(a)2
F.A.C. 62-297.310(5)	F.A.C. 62-297.310(7)(a)9
F.A.C. 62-297.310(8)	

Emissions Unit Information Section : Unregulated Emission Units

**D. EMISSION POINT (STACK/VENT) INFORMATION
(Regulated Emissions Units Only)**

Emission Point Description and Type

1. Identification of Point on Plot Plan or Flow Diagram? Unregulated Emission Units		2. Emission Point Type Code: 3	
3. Descriptions of Emission Points Comprising this Emissions Unit for VE Tracking (limit to 100 characters per point): Unit exhaust through single stack			
4. ID Numbers or Descriptions of Emission Units with this Emission Point in Common:			
5. Discharge Type Code: H	6. Stack Height: 17 feet	7. Exit Diameter: 0.5 feet	
8. Exit Temperature: 870 °F	9. Actual Volumetric Flow Rate: 2,800 acfm	10. Water Vapor: %	
11. Maximum Dry Standard Flow Rate: dscfm		12. Nonstack Emission Point Height: feet	
13. Emission Point UTM Coordinates: Zone: 17 East (km): 2594147 North (km): 2960792			
14. Emission Point Comment (limit to 200 characters): Values for emergency diesel generator. Note that there are 2 diesel engines and 2 exhaust stacks			

Emissions Unit Information Section : Unregulated Emission Units

**E. SEGMENT (PROCESS/FUEL) INFORMATION
(All Emissions Units)**

Segment Description and Rate: Segment 1 of 5

1. Segment Description (Process/Fuel Type) (limit to 500 characters): Diesel fuel burned in mobile emergency diesel generator.		
2. Source Classification Code (SCC): 2-01-001-02		3. SCC Units: Thousands Gallons Burned
4. Maximum Hourly Rate: 0.054	5. Maximum Annual Rate: 473	6. Estimated Annual Activity Factor:
7. Maximum % Sulfur: 0.5	8. Maximum % Ash:	9. Million Btu per SCC Unit: 136
10. Segment Comment (limit to 200 characters): Maximum annual rate based on 400 hours of operation per year.		

Segment Description and Rate: Segment 2 of 5

1. Segment Description (Process/Fuel Type) (limit to 500 characters): Above Ground Oil Storage Tank #A – Working and Breathing loss		
3. Source Classification Code (SCC): 4-03-010-21		3. SCC Units: Thousands of Gal. transferred or handled
4. Maximum Hourly Rate:	6. Maximum Annual Rate: 351577556	6. Estimated Annual Activity Factor:
7. Maximum % Sulfur: 2.5	8. Maximum % Ash:	10. Million Btu per SCC Unit: 152
10. Segment Comment (limit to 200 characters): (From initial Title V Application) Working loss = 64.25 lbs VOC / year (per EPA Tanks Program) Breathing loss = 14.17 lbs VOC / year (per EPA Tanks Program) Total estimated losses = 0.04 TPY, using estimated activity factor given above		

Emissions Unit Information Section : Unregulated Emission Units

Segment Description and Rate: Segment 3 of 5

1. Segment Description (Process/Fuel Type) (limit to 500 characters): Above Ground Oil Storage Tank #B – Working and Breathing loss		
4. Source Classification Code (SCC): 4-03-010-21		3. SCC Units: Thousands of Gal. transferred or handled
4. Maximum Hourly Rate:	7. Maximum Annual Rate: 351577556	6. Estimated Annual Activity Factor:
7. Maximum % Sulfur: 2.5	8. Maximum % Ash:	11. Million Btu per SCC Unit: 152
10. Segment Comment (limit to 200 characters): (From initial Title V Application) Working loss = 64.25 lbs VOC / year (per EPA Tanks Program) Breathing loss = 14.17 lbs VOC / year (per EPA Tanks Program) Total estimated losses = 0.04 TPY, using estimated activity factor given above		

Segment Description and Rate: Segment 4 of 5

1. Segment Description (Process/Fuel Type) (limit to 500 characters): Above Ground Oil Storage Tank #C – Working and Breathing loss		
5. Source Classification Code (SCC): 4-03-010-21		3. SCC Units: Thousands of Gal. transferred or handled
4. Maximum Hourly Rate:	8. Maximum Annual Rate: 351560644	6. Estimated Annual Activity Factor:
7. Maximum % Sulfur: 2.5	8. Maximum % Ash:	12. Million Btu per SCC Unit: 152
10. Segment Comment (limit to 200 characters): (From initial Title V Application) Working loss = 123.36 lbs VOC / year (per EPA Tanks Program) Breathing loss = 37.22 lbs VOC / year (per EPA Tanks Program) Total estimated losses = 0.08 TPY, using estimated activity factor given above		

Emissions Unit Information Section : Unregulated Emission Units

Segment Description and Rate: Segment 5 of 5

1. Segment Description (Process/Fuel Type) (limit to 500 characters): Above Ground Oil Storage Tank #D – Working and Breathing loss		
6. Source Classification Code (SCC): 4-03-010-21		3. SCC Units: Thousands of Gal. transferred or handled
4. Maximum Hourly Rate:	9. Maximum Annual Rate: 35198376	6. Estimated Annual Activity Factor:
7. Maximum % Sulfur: 2.5	8. Maximum % Ash:	13. Million Btu per SCC Unit: 152
10. Segment Comment (limit to 200 characters): (From initial Title V Application) Working loss = 174.40 lbs VOC / year (per EPA Tanks Program) Breathing loss = 66.18 lbs VOC / year (per EPA Tanks Program) Total estimated losses = 0.12 TPY, using estimated activity factor given above		

Emissions Unit Information Section : Unregulated Emission Units

**F. EMISSIONS UNIT POLLUTANTS
(All Emissions Units)**

1. Pollutant Emitted	2. Primary Control Device Code	3. Secondary Control Device Code	4. Pollutant Regulatory Code
NOx			NS

Emissions Unit Information Section : Unregulated Emission Units

H. VISIBLE EMISSIONS INFORMATION
(Only Regulated Emissions Units Subject to a VE Limitation)

Visible Emissions Limitation: Visible Emissions Limitation 1 of 2

1. Visible Emissions Subtype: VE20	2. Basis for Allowable Opacity: <input checked="" type="checkbox"/> Rule <input type="checkbox"/> Other
3. Requested Allowable Opacity: Normal Conditions: 20 % Exceptional Conditions: % Maximum Period of Excess Opacity Allowed: min/hour	
5. Method of Compliance: EPA Method 9	
6. Visible Emissions Comment (limit to 200 characters): Information provided is for the emergency diesel generator . The equipment in this EU may be subject to the general VE std. if they emit PM. Rule 62-210.700(1) allows 2hrs/24hrs of excess emissions for startup, shutdown & malfunction.	

Emissions Unit Information Section : Unregulated Emission Units

**I. CONTINUOUS MONITOR INFORMATION
(Only Regulated Emissions Units Subject to Continuous Monitoring)**

Continuous Monitoring System: Continuous Monitor 1 of 1

1. Parameter Code:	2. Pollutant(s):
3. CMS Requirement:	<input type="checkbox"/> Rule <input type="checkbox"/> Other
4. Monitor Information Manufacturer: : Model Number: Serial Number:	
5. Installation Date:	6. Performance Specification Test Date:
7. Continuous Monitor Comment (limit to 200 characters): Emission monitors are not required for unregulated emission units.	

Emissions Unit Information Section : Unregulated Emission Units

J. EMISSIONS UNIT SUPPLEMENTAL INFORMATION
(Regulated Emissions Units Only)

Supplemental Requirements

1. Process Flow Diagram <input type="checkbox"/> Attached, Document ID: <u>PRVU3-1.bmp</u> <input type="checkbox"/> Not Applicable <input type="checkbox"/> Waiver Requested
2. Fuel Analysis or Specification <input type="checkbox"/> Attached, Document ID: <u>PRVU3-2.bmp</u> <input type="checkbox"/> Not Applicable <input type="checkbox"/> Waiver Requested
3. Detailed Description of Control Equipment <input type="checkbox"/> Attached, Document ID: _____ <input checked="" type="checkbox"/> Not Applicable <input type="checkbox"/> Waiver Requested
4. Description of Stack Sampling Facilities <input type="checkbox"/> Attached, Document ID: _____ <input checked="" type="checkbox"/> Not Applicable <input type="checkbox"/> Waiver Requested
5. Compliance Test Report <input type="checkbox"/> Attached, Document ID: _____ <input type="checkbox"/> Previously submitted, Date: _____ <input checked="" type="checkbox"/> Not Applicable
6. Procedures for Startup and Shutdown <input type="checkbox"/> Attached, Document ID: <u>PRVU3-6.bmp</u> <input checked="" type="checkbox"/> Not Applicable <input type="checkbox"/> Waiver Requested
7. Operation and Maintenance Plan <input type="checkbox"/> Attached, Document ID: _____ <input checked="" type="checkbox"/> Not Applicable <input type="checkbox"/> Waiver Requested
8. Supplemental Information for Construction Permit Application <input type="checkbox"/> Attached, Document ID: _____ <input checked="" type="checkbox"/> Not Applicable
9. Other Information Required by Rule or Statute <input type="checkbox"/> Attached, Document ID: _____ <input checked="" type="checkbox"/> Not Applicable
10. Supplemental Requirements Comment:

Emissions Unit Information Section : Unregulated Emission Units

Additional Supplemental Requirements for Title V Air Operation Permit Applications

11. Alternative Methods of Operation <input type="checkbox"/> Attached, Document ID: _____ <input checked="" type="checkbox"/> Not Applicable <input type="checkbox"/> Waiver Requested
12. Alternative Modes of Operation (Emissions Trading) <input type="checkbox"/> Attached, Document ID: _____ <input checked="" type="checkbox"/> Not Applicable
13. Identification of Additional Applicable Requirements <input type="checkbox"/> Attached, Document ID: _____ <input checked="" type="checkbox"/> Not Applicable <input type="checkbox"/> Waiver Requested
14. Compliance Assurance Monitoring Plan <input type="checkbox"/> Attached, Document ID: _____ <input checked="" type="checkbox"/> Not Applicable
15. Acid Rain Part Application (Hard-copy Required) <input type="checkbox"/> Acid Rain Part - Phase II (Form No. 62-210.900(1)(a)) Attached, Document ID: _____ <input type="checkbox"/> Repowering Extension Plan (Form No. 62-210.900(1)(a)1.) Attached, Document ID: _____ <input type="checkbox"/> New Unit Exemption (Form No. 62-210.900(1)(a)2.) Attached, Document ID: _____ <input type="checkbox"/> Retired Unit Exemption (Form No. 62-210.900(1)(a)3.) Attached, Document ID: _____ <input type="checkbox"/> Phase II NOx Compliance Plan (Form No. 62-210.900(1)(a)4.) Attached, Document ID: _____ <input type="checkbox"/> Phase NOx Averaging Plan (Form No. 62-210.900(1)(a)5.) Attached, Document ID: _____ <input checked="" type="checkbox"/> Not Applicable

ATTACHMENTS

FPL RIVIERA PLANT

Attachment PRVCAM.doc

Justification for the mechanical Dust Collectors installed within FPL's Fossil Steam Boilers to be excluded from the CAM rule

Based on the January 8, 1998, U.S. Environmental Protection Agency (EPA) letter on Compliance Assurance Monitoring Rule Implementation Question and Answers, the mechanical Dust Collectors installed within FPL's Fossil Steam Boilers are excluded because:

- The mechanical Dust Collector is inherent process equipment contained entirely within the flue gas ductwork.
- The mechanical Dust Collector is a passive method of particle separation from the flue gas stream.
- The mechanical Dust Collector is a device to recover unburned carbon and ash from the flue gas stream.
- The mechanical Dust Collector has no moving parts, no control inputs, nor any controllable parameters.

Based on the characteristics above, the justification to exclude the mechanical Dust Collectors from the CAM rule is appropriate.

Title V Core List **Effective: 03/01/02**

[**Note:** The Title V Core List is meant to simplify the completion of the "List of Applicable Regulations" for DEP Form No. 62-210.900(1), Application for Air Permit - Long Form. The Title V Core List is a list of rules to which all Title V Sources are presumptively subject. The Title V Core List may be referenced in its entirety, or with specific exceptions. The Department may periodically update the Title V Core List.]

Federal: (description)

40 CFR 61, Subpart M: NESHAP for Asbestos.

40 CFR 82: Protection of Stratospheric Ozone.

40 CFR 82, Subpart B: Servicing of Motor Vehicle Air Conditioners (MVAC).

40 CFR 82, Subpart F: Recycling and Emissions Reduction.

State: (description)

CHAPTER 62-4, F.A.C.: PERMITS, effective 06-01-01

62-4.030, F.A.C.: General Prohibition.

62-4.040, F.A.C.: Exemptions.

62-4.050, F.A.C.: Procedure to Obtain Permits; Application

62-4.060, F.A.C.: Consultation.

62-4.070, F.A.C.: Standards for Issuing or Denying Permits; Issuance; Denial.

62-4.080, F.A.C.: Modification of Permit Conditions.

62-4.090, F.A.C.: Renewals.

62-4.100, F.A.C.: Suspension and Revocation.

62-4.110, F.A.C.: Financial Responsibility.

62-4.120, F.A.C.: Transfer of Permits.

62-4.130, F.A.C.: Plant Operation - Problems.

62-4.150, F.A.C.: Review

62-4.160, F.A.C.: Permit Conditions.

62-4.210, F.A.C.: Construction Permits.

62-4.220, F.A.C.: Operation Permit for New Sources.

**CHAPTER 62-210, F.A.C.: STATIONARY SOURCES - GENERAL REQUIREMENTS,
effective 06-21-01**

62-210.300, F.A.C.: Permits Required.

62-210.300(1), F.A.C.: Air Construction Permits.

62-210.300(2), F.A.C.: Air Operation Permits.

62-210.300(3), F.A.C.: Exemptions.

62-210.300(5), F.A.C.: Notification of Startup.

62-210.300(6), F.A.C.: Emissions Unit Reclassification.

62-210.300(7), F.A.C.: Transfer of Air Permits.

Title V Core List **Effective: 03/01/02**

62-210.350, F.A.C.: Public Notice and Comment.
62-210.350(1), F.A.C.: Public Notice of Proposed Agency Action.
62-210.350(2), F.A.C.: Additional Public Notice Requirements for Emissions Units Subject to Prevention of Significant Deterioration or Nonattainment-Area Preconstruction Review.
62-210.350(3), F.A.C.: Additional Public Notice Requirements for Sources Subject to Operation Permits for Title V Sources.

62-210.360, F.A.C.: Administrative Permit Corrections.
62-210.370(3), F.A.C.: Annual Operating Report for Air Pollutant Emitting Facility.
62-210.400, F.A.C.: Emission Estimates.
62-210.650, F.A.C.: Circumvention.
62-210.700, F.A.C.: Excess Emissions

62-210.900, F.A.C.: Forms and Instructions.
62-210.900(1), F.A.C.: Application for Air Permit - Title V Source, Form and Instructions.
62-210.900(5), F.A.C.: Annual Operating Report for Air Pollutant Emitting Facility, Form and Instructions.
62-210.900(7), F.A.C.: Application for Transfer of Air Permit - Title V and Non-Title V Source.

CHAPTER 62-212, F.A.C.: STATIONARY SOURCES- PRECONSTRUCTION REVIEW,
effective 08-17-00

CHAPTER 62-213, F.A.C.: OPERATION PERMITS FOR MAJOR SOURCES OF AIR POLLUTION,
effective 04-16-01

62-213.205, F.A.C.: Annual Emissions Fee.
62-213.400, F.A.C.: Permits and Permit Revisions Required.
62-213.410, F.A.C.: Changes Without Permit Revision.
62-213.412, F.A.C.: Immediate Implementation Pending Revision Process.
62-213.415, F.A.C.: Trading of Emissions Within a Source.
62-213.420, F.A.C.: Permit Applications.
62-213.430, F.A.C.: Permit Issuance, Renewal, and Revision.
62-213.440, F.A.C.: Permit Content.
62-213.450, F.A.C.: Permit Review by EPA and Affected States
62-213.460, F.A.C.: Permit Shield.

62-213.900, F.A.C.: Forms and Instructions.
62-213.900(1), F.A.C.: Major Air Pollution Source Annual Emissions Fee Form.
62-213.900(7), F.A.C.: Statement of Compliance Form

Title V Core List Effective: 03/01/02

CHAPTER 62-296, F.A.C.: STATIONARY SOURCES - EMISSION STANDARDS, effective 03-02-99

62-296.320(2), F.A.C.: Objectionable Odor Prohibited.
62-296.320(4)(c), F.A.C.: Unconfined Emissions of Particulate Matter

**CHAPTER 62-297, F.A.C.: STATIONARY SOURCES - EMISSIONS MONITORING,
effective 03-02-99**

62-297.310, F.A.C.: General Test Requirements.
62-297.330, F.A.C.: Applicable Test Procedures.
62-297.340, F.A.C.: Frequency of Compliance Tests.
62-297.345, F.A.C.: Stack Sampling Facilities Provided by the Owner of an Emissions Unit.
62-297.350, F.A.C.: Determination of Process Variables.
62-297.570, F.A.C.: Test Report.
62-297.620, F.A.C.: Exceptions and Approval of Alternate Procedures and Requirements.

Miscellaneous:





CHAPTER 28-106, F.A.C.: Decisions Determining Substantial Interests
CHAPTER 62-110, F.A.C.: Exception to the Uniform Rules of Procedure, effective 07-01-98
CHAPTER 62-256, F.A.C.: Open Burning and Frost Protection Fires, effective 11-30-94
CHAPTER 62-257, F.A.C.: Asbestos Notification and Fee, effective 02-09-99
**CHAPTER 62-281, F.A.C.: Motor Vehicle Air Conditioning Refrigerant Recovery and
Recycling, effective 09-10-96**

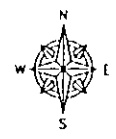

Riviera Plant Area Map

Palm Beach County



-  Riviera Plant
-  Water
-  Residential
-  Major Roads
-  Railroads

No expressed or implied warranties including, but not limited to the implied warranties of MERCHANTABILITY OF FITNESS FOR A PARTICULAR PURPOSE are made. The materials contained herein are provided 'as is' and may contain inaccuracies and user is warned to utilize the material's accuracy independently and assumes the risk of any and all loss.

Source: Landuse data provided by South Florida Water Management District (1993)

REVISION INFORMATION	TECHNICAL APPROVAL
NO.	DATE
DESCRIPTION	BY

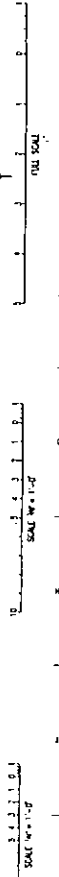
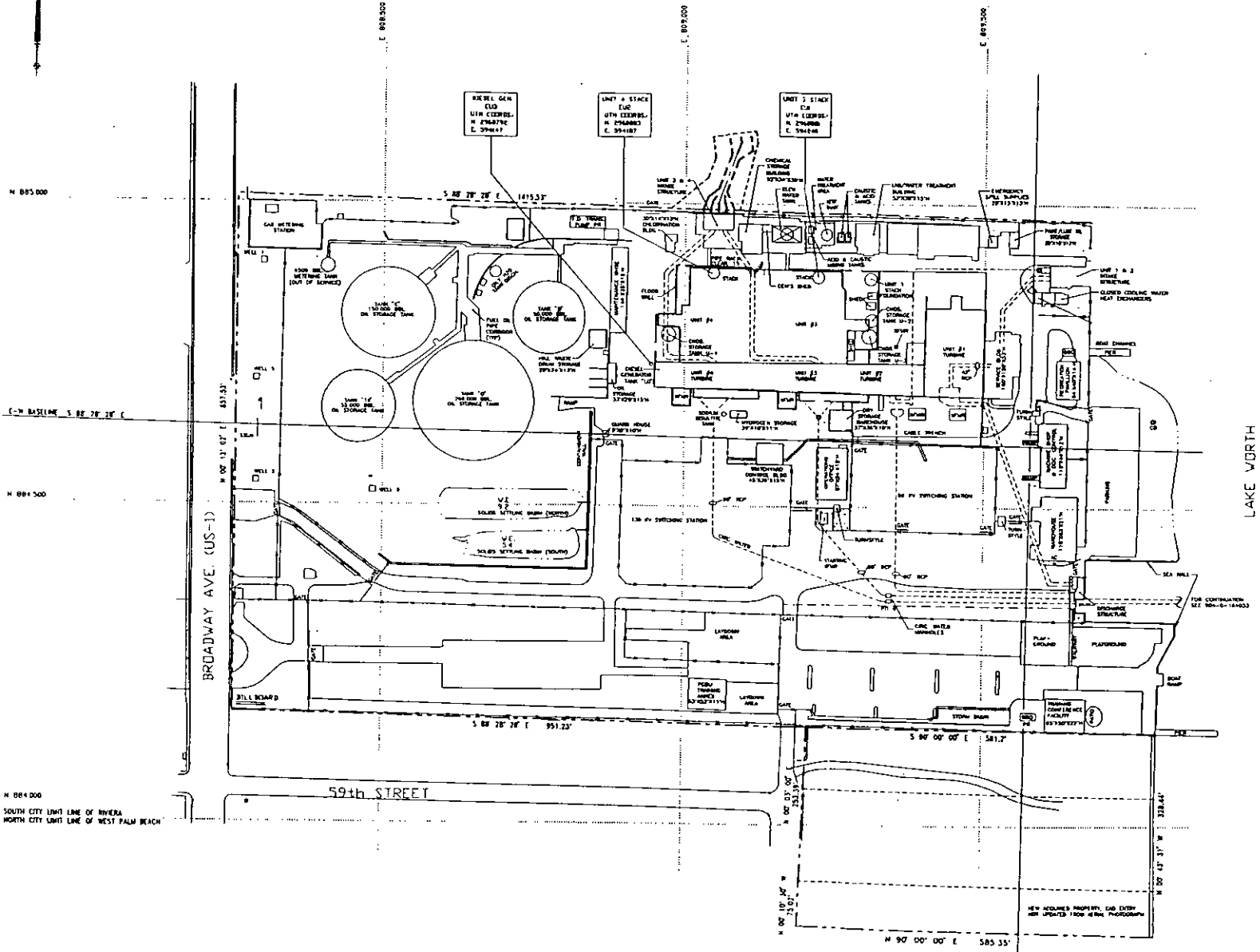
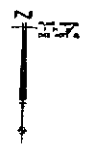

N 884 000
SOUTH CITY LIMIT LINE OF RIVIERA
NORTH CITY LIMIT LINE OF WEST PALM BEACH

LAKE WORTH



PRJ	YY	REVISION	PLOT/UNIT	RIVIERA PLANT-UNIT 3 & 4
DATE		DATE FOR ISSUE		
ISSUED BY		ISSUED BY		
FACILITY PLOT PLAN ATTACHMENT FS-2 TITLE V				
PRYS-M0002-YY			SHEET 1 OF 1	

DESIGNED BY: [Name] DRAWN BY: [Name] CHECKED BY: [Name] DATE: [Date]

WALKDOWN INFORMATION			TECHNICAL ACCEPTANCE		
ORG	BY	DATE	ORG	BY	DATE
AS-BUILT INFORMATION			ENGINEERING ORGANIZATION		
ORG	BY	DATE	ORG	BY	DATE

SCALE 3/8" = 1'-0"

SCALE 1/4" = 1'-0"

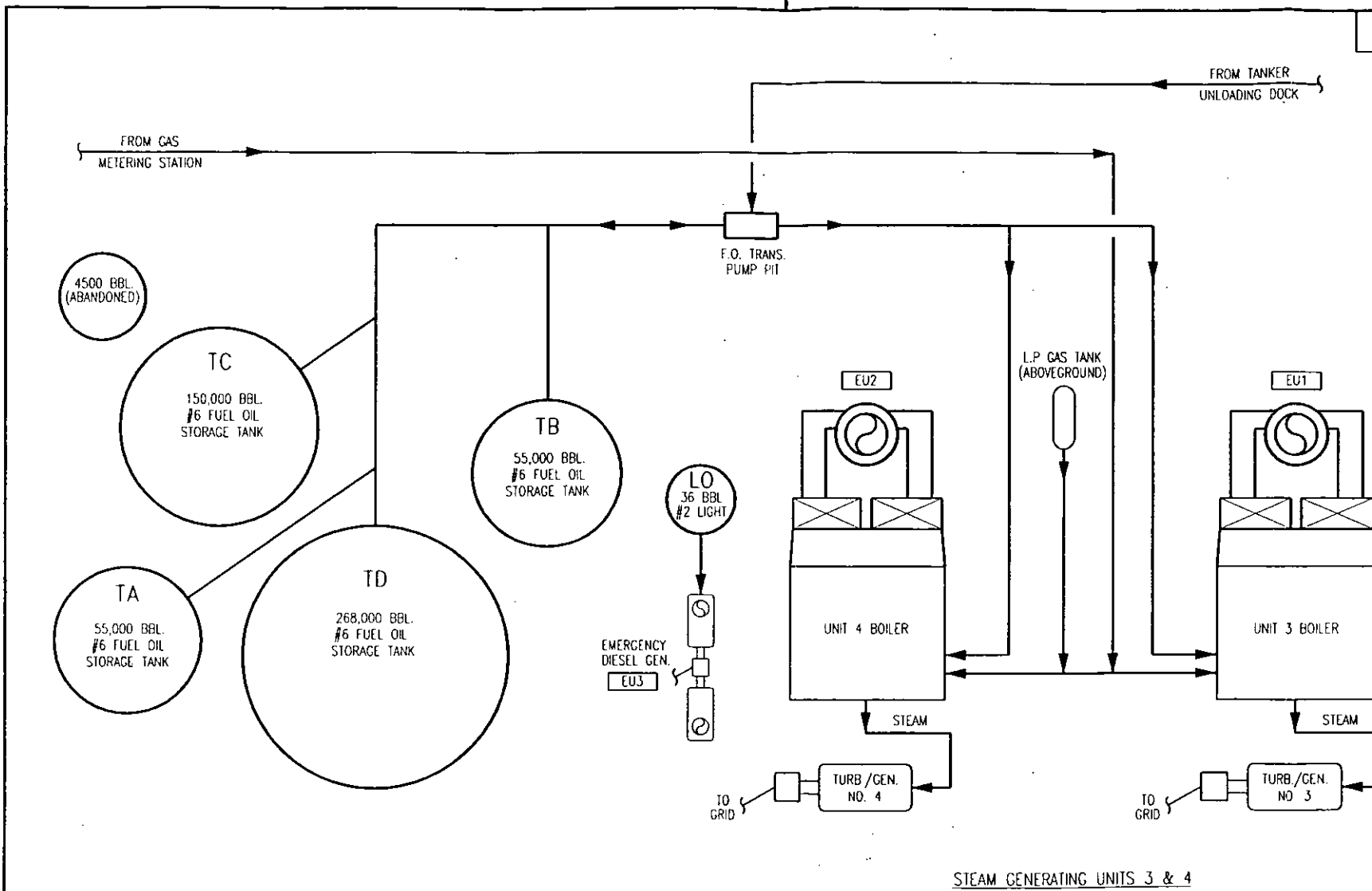

- NOTES:
- ACRONYMS:
 EU - EMISSION UNIT
 FO - FUEL OIL
 LP - LIQUID PROPANE
 - EMISSION UNITS ARE IDENTIFIED WITH A RECTANGULAR BOX:
 EMISSION UNIT NUMBER

TANK LEGEND:
 T - STORAGE TANK (TA, B, C & D)
 LO - LIGHT OIL TANK

	SYSTEM	YY	DISCIPLINE	M	PLANT/UNIT	RIVIERA PLANT-UNIT 3 & 4	
	SCALE	N/A	CAD FILE NAME	RV002855	TITLE	FACILITY SOURCE FLOW DIAGRAM	
	DRAWING SIZE	B(11"X17")	FPL ARCHIVE NAME	RV002855	TITLE	ATTACHMENT NO. FS-3 TITLE V	
	DRAWING NUMBER	PRV3-M0105-YY			SHEET	1 OF 1	REV

0	7/25/95	ISSUED FOR TITLE V PERMIT	PWB	PWB	CSP	CSP	ETS
REV	DATE	REVISION DESCRIPTION	BY	CH	COR	APR	ORG

Attachment PRVFS-4.txt

Precautions to Prevent Emissions of Unconfined Particulate Matter

The facility has negligible amounts of unconfined particulate matter as a result of operation of the facility. Potential examples of particulate matter include:

- Fugitive dust from unpaved roads
- Sandblasting abrasive material from plant maintenance activities
- Fugitive particulates from the use of bagged chemical products (soda ash, di-, tri- and monosodium phosphate, and other chemicals as needed)

Several precautions were taken to prevent emissions of particulate matter at the facility including:

- Paving of roads, parking areas, and equipment yards
- Landscaping and planting vegetation

Operational measures are undertaken at the facility, which also minimize particulate emissions, in accordance with 62-296-310 F.A.C.:

- Use of thick poly flaps over the doorways to prevent any sandblasting material from leaving the sandblast facility. The facility also constructs temporary sandblasting enclosures when necessary, in order to perform sandblasting on fixed plant equipment
- Maintenance of paved roads as needed
- Regular mowing of grass and care of vegetation
- Limiting access to plant property by unnecessary vehicles
- Bagged chemical products are stored in weather tight buildings until they are used. Spills of any powdered chemical products are cleaned up as soon as practicable
- Vehicles are restricted to slow speeds on the plant site

Attachment PRVFS-5.txt

Fugitive Emission Identification

Criteria and Precursor Air Pollutants

Fugitive particulate emissions are addressed in Attachment PRVFS_4.txt. FPL is not aware of fugitive particulate emissions of Sulfur Dioxide, Nitrogen Oxides or Carbon Monoxide that would exceed the reporting thresholds defined in the permit application instructions.

Fugitive HAP's Emissions

FPL is not aware of fugitive emissions of HAP pollutants that would exceed the reporting thresholds defined in the permit application instructions.

Attachment PRVFS-8.txt

List of Exempt Emissions Units and/or Activities

The facilities, emissions units, or pollutant-emitting activities listed in Rule 62-210.300(3)(a), F.A.C., Full Exemptions, are exempt from the permitting requirements of Chapters 62-210 and The facilities, emissions units, or pollutant-emitting activities listed in Rule 62-210.300(3)(a), 62-4, F.A.C.; provided, however, that exempt emissions units shall be subject to any applicable emission limiting standards and the emissions from exempt emissions units or activities shall be considered in determining whether a facility containing such emissions units or activities would be subject to any applicable requirements. Emissions units and pollutant-emitting activities exempt from permitting under Rule 62-210.300(3)(a), F.A.C., are also exempt from the permitting requirements of Chapter 62-213, F.A.C., provided such emissions units and activities also meet the exemption criteria of Rule 62-213.430(6)(b), F.A.C. The below listed emissions units and/or activities are hereby exempt pursuant to Rule 62-213.430(6), F.A.C.

1	Natural Gas Metering Area Relief Valves
2	Hydrazine Mixing Tank
3	Fuel Oil storage tanks and related systems
4	Lube Oil tanks, vents, and related systems
5	Oil/Water Separation Basin and related equipment
6	Hazardous Waste Building
7	Paint/Lube Buildings
8	Miscellaneous mobile vehicle operation
9	Evaporation of Boiler Chemical Cleaning Waste

See also Attachment PRV_FW.

Attachment PRV-14.txt

**Riviera Plant
Compliance Report and Plan**

This facility and emissions units identified in this application are in compliance with the Applicable Requirements identified in Sections II. B. and III. D. of the application form and attachments referenced in Section III. L. 12 (if included). Compliance is certified as of the date of this application is submitted to the Florida Department of Environmental Protection as required in Rule 62-213.420(1)(a) F.A.C.



Department of Environmental Protection

Division of Air Resource Management

STATEMENT OF COMPLIANCE - TITLE V SOURCE

REASON FOR SUBMISSION (Check one to indicate why this statement of compliance is being submitted)

<input checked="" type="checkbox"/> Annual Requirement (Partial)	<input type="checkbox"/> Transfer of Permit	<input type="checkbox"/> Permanent Facility Shutdown
------------------------------------------------------------------	---------------------------------------------	------------------------------------------------------

REPORTING PERIOD*	REPORT DEADLINE**
January 1, through March, 16 of 2003 (year)	July 1, 2003

*The statement of compliance must cover all conditions that were in effect during the indicated reporting period, including any conditions that were added, deleted, or changed through permit revision.

**See Rule 62-213.440(3)(a)2., F.A.C.

Facility Owner/Company Name: FLORIDA POWER & LIGHT COMPANY

Site Name: RIVIERA PLANT Facility ID No. 0990042 County: PALM BEACH

COMPLIANCE STATEMENT (Check only one of the following three options)

A. This facility was in compliance with all terms and conditions of the Title V Air Operation Permit and, if applicable, the Acid Rain Part, and there were no reportable incidents of deviations from applicable requirements associated with a malfunction or breakdown of process, fuel burning or emission control equipment, or monitoring systems during the reporting period identified above.

B. This facility was in compliance with all terms and conditions of the Title V Air Operation Permit and, if applicable, the Acid Rain Part; however, there were one or more reportable incidents of deviations from applicable requirements associated with malfunctions or breakdowns of process, fuel burning or emission control equipment, or monitoring systems during the reporting period identified above, which were reported to the Department. For each incident of deviation, the following information is included:

1. Date of report previously submitted identifying the incident of deviation.*
2. Description of the incident.*

* SEE ATTACHMENTS

C. This facility was in compliance with all terms and conditions of the Title V Air Operation Permit and, if applicable, the Acid Rain Part, EXCEPT those identified in the pages attached to this report and any reportable incidents of deviations from applicable requirements associated with malfunctions or breakdowns of process, fuel burning or emission control equipment, or monitoring systems during the reporting period identified above, which were reported to the Department. For each item of noncompliance, the following information is included:

1. Emissions unit identification number.
2. Specific permit condition number (note whether the permit condition has been added, deleted, or changed during certification period).
3. Description of the requirement of the permit condition.
4. Basis for the determination of noncompliance (for monitored parameters, indicate whether monitoring was continuous, i.e., recorded at least every 15 minutes, or intermittent).
5. Beginning and ending dates of periods of noncompliance.
6. Identification of the probable cause of noncompliance and description of corrective action or preventative measures implemented.
7. Dates of any reports previously submitted identifying this incident of noncompliance.

For each incident of deviation, as described in paragraph B. above, the following information is included:

1. Date of report previously submitted identifying the incident of deviation.
2. Description of the incident.

STATEMENT OF COMPLIANCE - TITLE V SOURCE

RESPONSIBLE OFFICIAL CERTIFICATION

I, the undersigned, am a responsible official (Title V air permit application or responsible official notification form on file with the Department) of the Title V source for which this document is being submitted. With respect to all matters other than Acid Rain program requirements, I hereby certify, based on the information and belief formed after reasonable inquiry, that the statements made and data contained in this document are true, accurate, and complete.

Jeff Smith
(Signature of Title V Source Responsible Official)

3/17/03
(Date)

Name: Jeff Smith

Title: Production Manager

DESIGNATED REPRESENTATIVE CERTIFICATION (only applicable to Acid Rain source)

I, the undersigned, am authorized to make this submission on behalf of the owners and operators of the Acid Rain source or Acid Rain units for which the submission is made. I certify under penalty of law that I have personally examined, and am familiar with, the statements and information submitted in this document and all its attachments. Based on my inquiry of those individuals with primary responsibility for obtaining the information, I certify that the statements and information are to the best of my knowledge and belief true, accurate, and complete. I am aware that there are significant penalties for submitting false statements and information or omitting required statements and information, including the possibility of fine or imprisonment.

Nancy M. Kierspe
(Signature of Acid Rain Source Designated Representative)

4-7-03
(Date)

Name: Nancy M. Kierspe

Title: Designated Representative

{Note: Attachments, if required, are created by a responsible official or designated representative, as appropriate, and should consist of the information specified and any supporting records. A additional information may also be attached by a responsible official or designated representative when elaboration is required for clarity. This report is to be submitted to both the compliance authority (DEP district or local air program) and the U.S. Environmental Protection Agency(EPA) (U.S. EPA Region 4, Air and EPCRA Enforcement Branch, 61 Forsyth Street, Atlanta GA 30303).}



FAX

Florida Power & Light
700 Universe Blvd
Juno Beach, FL 33408

Power Generation – Technical Services

TO: Mr. Ajaya Satyal

Fax #: 561-804-9405

FROM: Sheila M. Wilkinson
GPA/JB
(561) 694 -3703

Fax (561) 694 - 3647

DATE: March 10, 2003

SUBJECT: FPL Riviera Plant Excursion Report due to malfunction

Number of Pages: 1 (including this cover)

Mr. Satyal:

As requested in your call this morning, following are the details of the opacity excursion event at the Florida Power & Light (FPL) Riviera Plant.

This morning at 6:07 AM, the Riviera Plant experienced a malfunction that resulted in a six-minute average of a 77% opacity excursion. A portion of the stack breaching turning vane broke off and fell in a manner that damaged the Induced Draft Fan isolation dampers. In turn, the airflow was affected causing the opacity to increase to a six-minute average of 77%. The dampers and fan were taken out of service, Unit load has been restricted to 100Gross Megawatts to prevent further opacity excursions and the unit will be taken offline this evening for repairs.

If you require any more information, please do not hesitate to call me. My cell-phone number, should you need to reach me immediately, is 561-373-7042.

Thank you,

Sheila M. Wilkinson

WALKDOWN INFORMATION		TECHNICAL ACCEPTANCE	
ORG	BY	ORG	BY
AS-BUILT INFORMATION	DATE	ENGINEERING ORGANIZATION	DATE

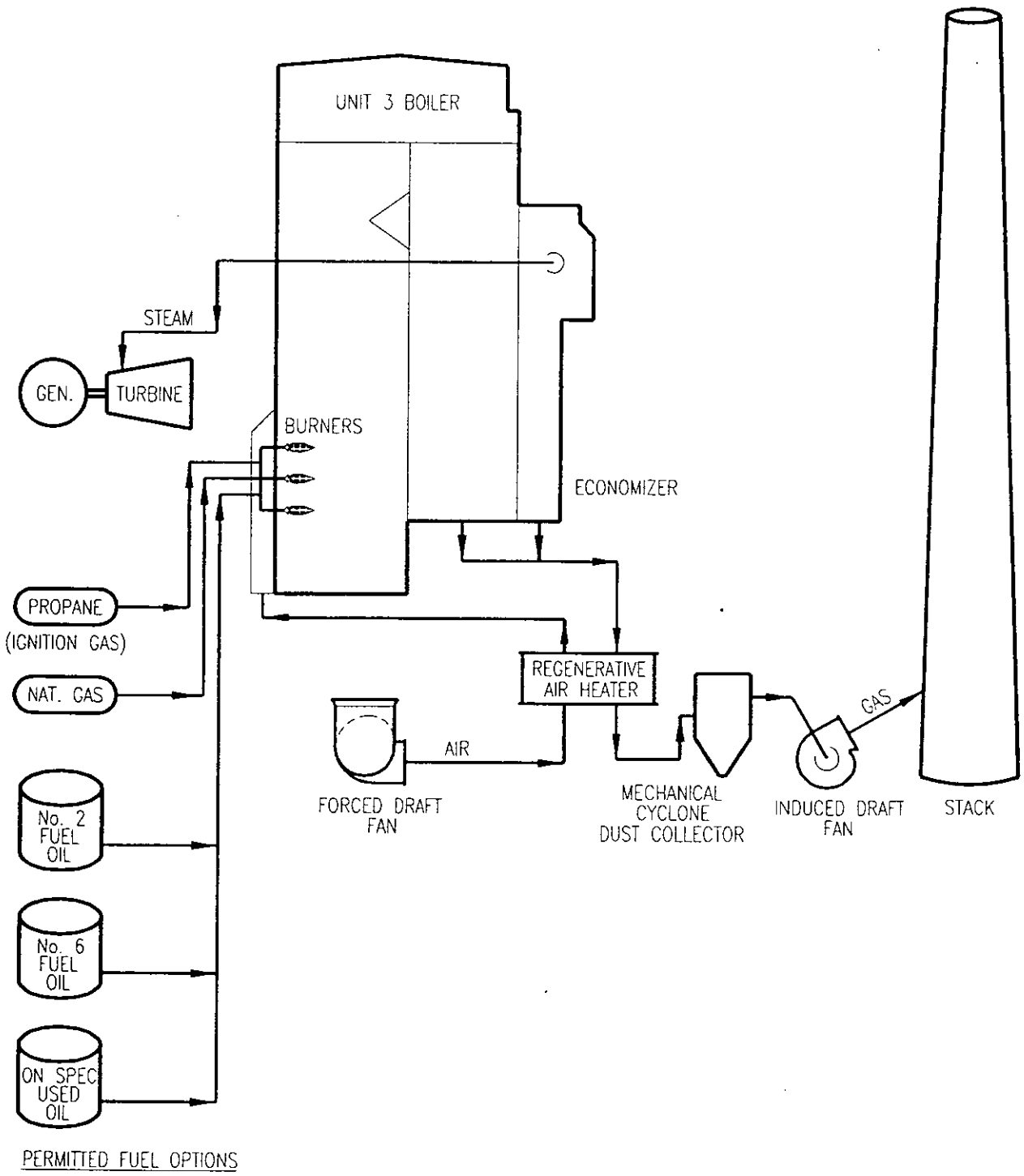

BAR CODE

0	7/24/95	ISSUED FOR TITLE V PERMIT	PWB	PWB	CSP	CSP	ETS
REV	DATE	REVISION DESCRIPTION	BY	CH	COR	APR	DRG

	SYSTEM	YY	DISCIPLINE	M	PLANT/UNIT	RIVIERA PLANT
	SCALE	N/A	CAD FILE NAME	RV002856	TITLE	EMISSION UNIT PROCESS FLOW DIAGRAM STEAM GENERATOR/BOILER ATTACHMENT NO. EU1
	DRAWING SIZE	A (8.5X11)	FPL ARCHIVE NAME	RV002856		

DRAWING NUMBER	PRV3-M0106-YY	SHEET	1 OF 1	REV	0
----------------	---------------	-------	--------	-----	---

Attachment PRVU1-2.txt**Fuel Analyses**
Natural Gas Analysis (typical)²

<u>Parameter</u>	<u>Typical value</u>	<u>Max value</u>
Specific gravity(@ 60° F)	0.887	none
Heat content (Btu/cu ft)	950 - 1124	none
% sulfur (grains/CCF)	0.43 ¹	1 grain / ccf
% nitrogen (by volume)	0.8	none
% ash	negligible	none

*Note: The values listed are "typical" values based upon information supplied to FPL by Florida Gas Transmission (FGT). However, analytical results from grab samples of fuel taken at any given point in time may vary from those listed.

(1) Data from laboratory analysis

(2) The values are "typical" based upon the following:

- Information gathered by FPL through laboratory analysis, and
- FPL's fuel purchasing specifications. It should be noted that the analytical results obtained from grab samples taken at any given time may vary from those listed.

No. 6 Oil Analysis (typical)⁴

<u>Parameter</u>	<u>Typical value</u>	<u>Specifications</u>
API gravity (@ 60° F)	6 - 12	none
Heat content(MMBtu/bbl)	6,310 - 6420	6,340 ¹
% Sulfur	2.0 - 2.4	2.5 max ³
% Nitrogen	0.2 - 0.5 ²	none
% Ash	0.06 - 0.09 ²	0.10 max ¹

Footnotes:

(1) Data taken from FPL fuel specifications.

(2) Data taken from laboratory analysis.

(3) Maximum permitted from current air operation permit.

(4) The values are "typical" based upon the following:

- Information gathered by FPL through laboratory analysis, and
- FPL's fuel purchasing specifications. It should be noted that the analytical results obtained from grab samples taken at any given time may vary from those listed.

No. 2 Distillate oil (typical)³

<u>Parameter</u>	<u>Typical value</u>	<u>Specifications</u>
API gravity (@ 60 F)	35.0 ²	30 - 40 ¹
Heat content (MMBtu/bbl)	5,700 - 5,800 ²	none
% sulfur	0.3 - 0.5 ¹	0.5 maximum ¹
% nitrogen	no specification	none
% ash	<0.01 ²	0.01 ¹

Footnotes:

(1) Data taken from FPL fuel specifications.

(2) Data taken from laboratory analysis.

(3) The values are "typical" based upon the following:

- Information gathered by FPL through laboratory analysis and purchase specs.

Attachment PRVU1-2.txt

Fuel Analyses
Propane Analysis (typical)²

<u>Parameter</u>	<u>Typical value</u>	<u>Max value</u>
Specific gravity(@ 60° F)	0.51	none
Heat content (Btu/cu ft)	600 - 1000	none
% sulfur (grains/CCF)	<0.01	none
% nitrogen (by volume)	no specification	none
% ash	no specification	none

*Note: The values listed are "typical" values based upon analytical results from grab samples of fuel taken at any given point in time may vary from those listed.

(1) Data from laboratory analysis

(2) The values are "typical" based upon the following:

- Information gathered by FPL through laboratory analysis, and
- FPL's fuel purchasing specifications. It should be noted that the analytical results obtained from grab samples taken at any given time may vary from those listed.

Non-Specification Used Oil (typical)⁴

<u>Parameter</u>	<u>Typical value</u>	<u>Specifications</u>
API gravity (@ 60° F)	30.0 ¹	none
Heat content(MMBtu/bbl)	6,000 ¹	none
% Sulfur	0.3 ¹	none
% Nitrogen	negligible	none
% Ash	0.01 ¹	0.01

Footnotes:

(1) The values are "typical" based upon the following:

- Information gathered by FPL through laboratory analysis, and
- FPL's fuel purchasing specifications. It should be noted that the analytical results obtained from grab samples taken at any given time may vary from those listed.

Attachment PRVU1-3.txt

Detailed Description of Control Equipment

- A. Cyclone Separator** - This steam generator (boiler) is supplied with two 543-C10 Research Cottrell series 14" tubular mechanical dust collectors with side inlet and universal outlet. Each dust collector consists of 543 tubes and four dust collection hoppers. The dust collector has the following efficiency at 2.55 inches of water @ peak load:

<u>Particle Range</u> (micron)	<u>Mean Diameter</u> (micron)	<u>Estimated Efficiency</u> (percent)
0 - 5	2.5	30.3
5 - 10	7.5	66.2
10 - 20	15	88.6
20 - 45	32.5	99.1
45 +	45	99.5

- B. Low NOx Burners** - Because of Ozone nonattainment problems in southern Florida, the Riviera Plant installed Low NOx Burners on the two boilers. The burners have achieved NOx reductions of approximately 31% on natural gas and 33% on residual oil from their original burners.

FLORIDA POWER & LIGHT CO.
 STACK SAMPLING FACILITIES
 RIVIERA

PRVU1_4.bmp

FOSSIL FUEL STEAM GENERATORS
 UNITS 3 & 4

STACK SPECIFICATIONS

- SAMPLING DIAMETER: 218 1/4 in.
- SAMPLING AREA: 255.1 sq. ft.
- SAMPLING PORT DEPTH: 50 1/2 in.
- No. OF PORTS: 4
- No. OF POINTS PER TRAVERSE: 6
- TOTAL No. OF POINTS : 24
- SAMPLING TIME PER POINT: 2.5 min.
- TOTAL SAMPLING TIME: 60.0 min.
- NOTE: DRAWING IS NOT TO SCALE

STACK DIAGRAM

PARTICULATE SAMPLING
 PROBE DIAGRAM

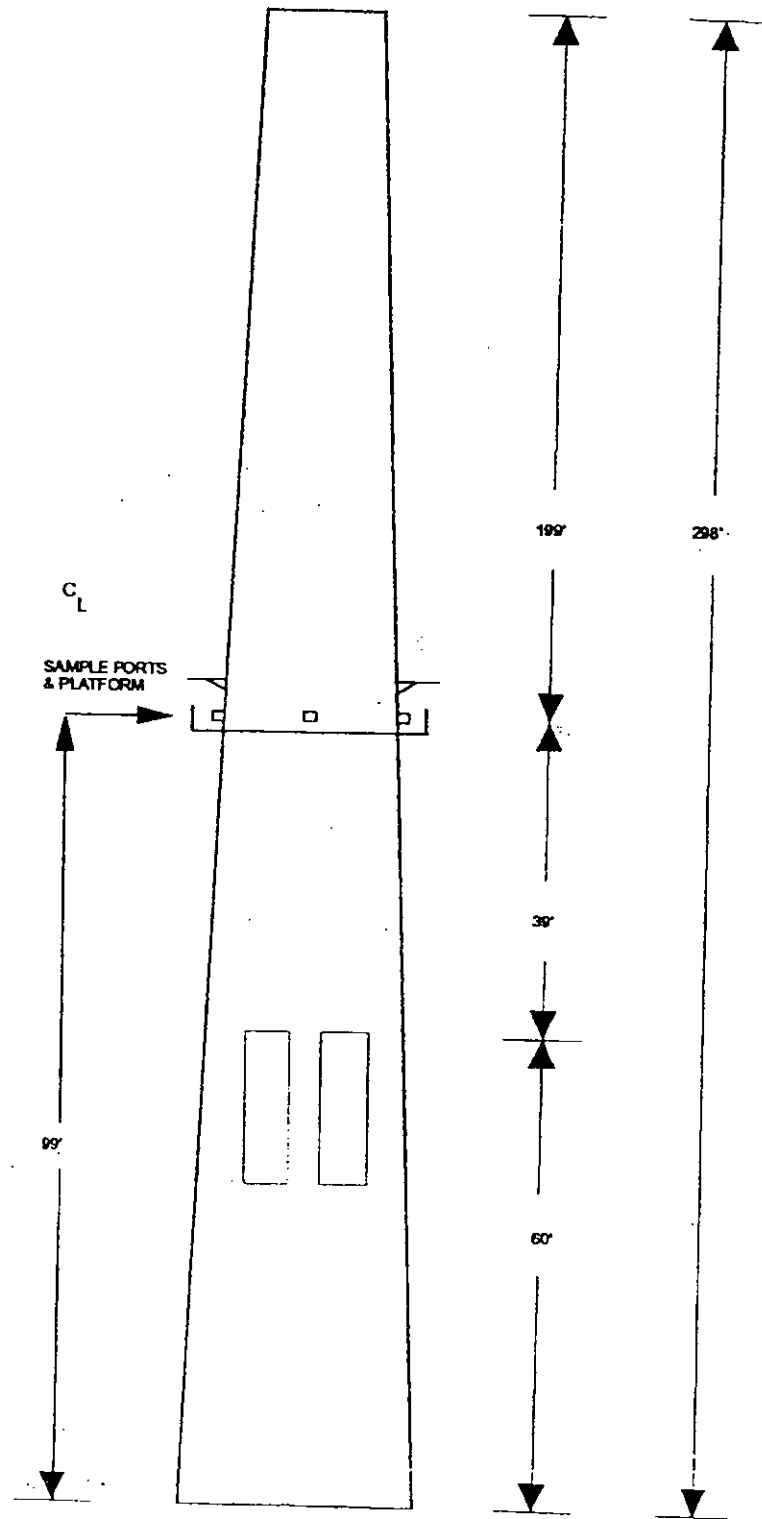
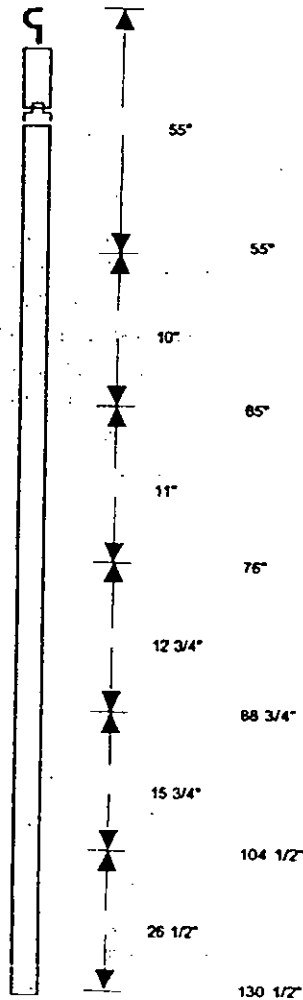

Access to the sampling ports is provided by a ladder. Channel iron with a trolley system is above each port for probe support. AC power is available on the platform and at the base of the stack.

Attachment PRVU1-6.txt

Startup & Shutdown Procedures - Minimizing Excess Emissions

Startup of the fossil-fuel boiler begins when fuel (either natural gas or oil) is introduced into one or more burners within the boiler and lighted (commencement of combustion). Startup is complete and steady-state operation begins when the combustion process has stabilized and the megawatt load on the unit is stable.

Shutdown of the fossil-fuel boilers begins when unit megawatt load is decreased to below 10% of maximum and continues until the final burner gun is removed from service and the final Induced-draft or Forced-draft fan is removed from service.

Excess emissions may be detected during all modes of boiler operation by any one of several continuous emissions monitors. Continuous emission monitors are currently in place for NO_x, SO₂ and opacity. An audible and visual alarm is activated whenever permitted values for any of the above parameters are approached.

Countermeasures which may be taken in the event of excess emissions include, but are not limited to:

- proper excess air adjustments
- recognizing and removal of faulty burners
- fuel oil temperature adjustments
- proper and timely operation of boiler cleaning devices
- removal of the unit from system-dispatch mode
- reduction of unit megawatt load
- stopping and restarting of boiler cleaning devices
- lowering load rate
- pressure rate changes

Best Operational Practices to prevent excess emissions, and knowledge of the appropriate countermeasures to take if an excess emissions condition exists, are taught during routine operator training.

Attachment PRVU1-11txt

Alternative Methods of Operation

Operation at Various Capacities and Heat Input Rates

The Riviera Unit 3 and Unit 4 boilers may be operated up to 8760 hours per year at heat input rates from zero to 3050 MMBtu per hour on No.#6 oil, and from zero to 3260 MMBtu per hour on natural gas. When a blend of fuel oil and natural gas are burned, the heat input is prorated based upon the percent heat input of each fuel.

Different Fuel Types

The unit may be fired with a variable combination of No. 6 residual fuel oil, natural gas, or No. 2 fuel oil. Current emissions limitations are as follows:

<u>Pollutant</u>	<u>Emission Limit</u>
Particulate matter: steady-state	0.1 lb/MMBtu
Particulate matter: soot blowing	0.3 lb/MMBtu
Sulfur dioxide	2.75 lb/MMBtu
Nitrogen oxides	0.62 lb/MMBtu Oil (30-day rolling average) 0.50 lb/MMBtu Oil (30-day rolling average)

Soot Blowing

The unit may blow soot for up to 24 hours per day, so long as excess emissions are limited to 60% opacity for 3 hours in 24 hours with four 6-minute periods of up to 100% opacity.

Utilization of Additives

Additives such as Magnesium hydroxide $Mg(OH)_2$ are added to the boiler periodically at various loads. When magnesium hydroxide is used, it is injected into the boiler via the I.K. soot blower lances and through manual hand lances on a batch basis, rather than continuously. The dosage rate is based on the quantity of fuel burned and the amount of ash in the fuel. FPL reserves the right to use other additives if they are suitable.

Evaporation of Spent Boiler Chemical Cleaning Chemicals

On a periodic basis, as part of routine maintenance, the inside of the steam generator tubes (boiler tubes) at Riviera Unit 3 and Unit 4 are cleaned using a series of chemical solutions that remove deposited scale which adversely affects the efficiency and reliability of the generating units.

The solutions and rinsewaters are collected in large mobile tanks ("frac tanks") pursuant to guidance issued by the Department. Upon completion of the cleaning process and prior to disposal of the spent cleaning solution and rinses, representative sampling of the liquids collected in the "frac tanks" is conducted as per 40 CFR 261, Appendix I, to determine the hazardous waste status of the accumulated wastewater, using Toxicity Characteristic Leaching Procedure (TCLP) analysis. If the wastewater is determined to be hazardous, it will be managed as such in accordance with 40 CFR 262.34, 40 CFR 265 Subpart I, and 40 CFR 268 with respect to generators accumulating and treating waste in containers and tanks. An appropriate waste analysis plan will be developed to determine and document the pre- and post-treatment characteristics of the wastewater. Hazardous waste may also be transported to an approved hazardous waste facility for the appropriate disposal.

If the spent cleaning solution and rinses are determined to be non-hazardous, they are then disposed of by evaporation in the unit's boiler. Introduction into the boiler will occur at a rate that will not cause an exceedance of the opacity limit of the unit in which evaporation is occurring (in this case, 40 percent opacity).

Attachment PRVU1-13.txt

Identification of Additional Applicable Requirements

Applicable Requirements as defined in Rule 62-210.200(29) not identified in Section D of this emission unit section are included in this attachment of the application. Any air operation permit issued by the Department (or local program designee) and included in this attachment is provided for information purposes. The specific conditions of the operating permit are not Applicable Requirements as defined in Rule 62-210.200(29) unless implementing a specific Applicable Requirement of the Department's rules (e.g. emission limitations and consent orders).

0990042-001-AV Permit contains the following conditions:

1. Two items were identified as action to be undertaken by FPL in order to satisfy RACT requirements: (1) the boiler fuel firing rate shall not exceed 3,050 mmBtu/hr during fuel oil firing (start up) or 3,260 mmBtu/hr during gas firing; and (2) each boiler can operate continuously (8,760 hours per year). *FPL uses fuel sampling and analysis to monitor the heat input rate to the boiler.*
2. Installation of a continuous monitoring system for NOx emission. *This system has been installed.*
3. During start-up the boiler shall be fired either with No.6 residual oil with 0.5 percent maximum sulfur content or no.2 fuel oil with 0.5 percent sulfur content or 100 percent natural gas. *FPL fires the fuels as specified, and maintains records to demonstrate this.*
4. The maximum allowable emissions from each boiler shall not exceed the following emission limitations.

MAXIMUM ALLOWABLE EMISSION LIMITS			
Pollutant	Fuel	lb/mmBtu	Test Method
Particulate Matter (<i>Steady state</i>)	Oil	0.1	EPA Method 5 or 17
(<i>Soot blowing</i>)	Oil	0.3 <i>max. 3 hrs</i>	EPA Method 5 or 17
NOx RACT	Oil	0.62 or 1891 lbs/hr	CEM
	Gas	0.50 or 1630 lbs/hr	CEM
SO2	Oil	2.75	Monthly fuel analysis

For compliance with each of these emission limits, FPL uses annual stack tests and the monthly fuel analysis as specified. Records are maintained to demonstrate compliance.

5. To determine compliance with the oil firing heat input limitation, the Permittee shall maintain daily records of fuel oil consumption for each boiler and monthly records of heating value for such fuel. All records shall be maintained for a minimum of three years after the date of each record and shall be made available to representatives of DER upon request. *FPL has these records available.*

6. Any change in the method of operation, fuels or equipment shall be submitted for approval to FDEP's Bureau of Air Regulation. *FPL has not undertaken any such changes, but if changes are contemplated, will notify the department as specified.*

Attachment PRVU2-11.txt

Alternative Methods of Operation

Operation at Various Capacities and Heat Input Rates

The Riviera Unit 3 and Unit 4 boilers may be operated up to 8760 hours per year at heat input rates from zero to 3,050 MMBtu per hour on No. 6 oil, and from zero to 3,260 MMBtu per hour on natural gas. When a blend of fuel oil and natural gas are burned, the heat input is prorated based upon the percent heat input of each fuel.

Different Fuel Types

The unit may be fired with a variable combination of No. 6 residual fuel oil, natural gas, or No. 2 fuel oil. Current emissions limitations are as follows:

<u>Pollutant</u>	<u>Emission Limit</u>
Particulate matter: steady-state	0.1 lb/MMBtu
Particulate matter: soot blowing	0.3 lb/MMBtu
Sulfur dioxide	2.75 lb/MMBtu
Nitrogen oxides	0.62 lb/MMBtu Oil (30-day rolling average)
	0.50 lb/MMBtu Oil (30-day rolling average)

Soot Blowing

The unit may blow soot for up to 24 hours per day, so long as excess emissions are limited to 60% opacity for 3 hours in 24 hours with four 6-minute periods of up to 100% opacity.

Utilization of Additives

Additives such as Magnesium hydroxide $Mg(OH)_2$ are added to the boiler periodically at various loads. When magnesium hydroxide is used, it is injected into the boiler via the I.K. soot blower lances and through manual hand lances on a batch basis, rather than continuously. The dosage rate is based on the quantity of fuel burned and the amount of ash in the fuel. FPL reserves the right to use other additives if they are suitable.

Evaporation of Spent Boiler Chemical Cleaning Chemicals

On a periodic basis, as part of routine maintenance, the inside of the steam generator tubes (boiler tubes) at Riviera Unit 3 and Unit 4 are cleaned using a series of chemical solutions that remove deposited scale which adversely affects the efficiency and reliability of the generating units.

The solutions and rinsewaters are collected in large mobile tanks ("frac tanks") pursuant to guidance issued by the Department. Upon completion of the cleaning process and prior to disposal of the spent cleaning solution and rinses, representative sampling of the liquids collected in the "frac tanks" is conducted as per 40 CFR 261, Appendix I, to determine the hazardous waste status of the accumulated wastewater, using Toxicity Characteristic Leaching Procedure (TCLP) analysis. If the wastewater is determined to be hazardous, it will be managed as such in accordance with 40 CFR 262.34, 40 CFR 265 Subpart I, and 40 CFR 268 with respect to generators accumulating and treating waste in containers and tanks. An appropriate waste analysis plan will be developed to determine and document the pre- and post-treatment characteristics of the wastewater. Hazardous waste may also be transported to an approved hazardous waste facility for the appropriate disposal.

If the spent cleaning solution and rinses are determined to be non-hazardous, they are then disposed of by evaporation in the unit's boiler. Introduction into the boiler will occur at a rate that will not cause an exceedance of the opacity limit of the unit in which evaporation is occurring (in this case, 40-percent opacity).

Attachment PRVU2-13.txt

Identification of Additional Applicable Requirements

Applicable Requirements as defined in Rule 62-210.200(29) not identified in Section D of this emission unit section are included in this attachment of the application. Any air operation permit issued by the Department (or local program designee) and included in this attachment is provided for information purposes. The specific conditions of the operating permit are not Applicable Requirements as defined in Rule 62-210.200(29) unless implementing a specific Applicable Requirement of the Department's rules (e.g. emission limitations and consent orders).

0990042-001-AV Permit contains the following conditions:

1. Two items were identified as action to be undertaken by FPL in order to satisfy RACT requirements: (1) the boiler fuel firing rate shall not exceed 3,050 mmBtu/hr during fuel oil firing (start up) or 3,260 mmBtu/hr during gas firing, and (2) each boiler can operate continuously (8,760 hours per year). *FPL uses fuel sampling and analysis to monitor the heat input rate to the boiler.*
2. Installation of a continuous monitoring system for NOx emission. *This system has been installed.*
3. During start-up the boiler shall be fired either with no.6 residual oil with 0.5 percent maximum sulfur content or no.2 fuel oil with 0.5 percent sulfur content or 100 percent natural gas. *FPL fires the fuels as specified, and maintains records to demonstrate this.*
4. The maximum allowable emissions from each boiler shall not exceed the following emission limitations.

MAXIMUM ALLOWABLE EMISSION LIMITS			
Pollutant	Fuel	lb/mmBtu	Test Method
Particulate Matter (<i>Steady state</i>)	Oil	0.1	EPA Method 5 or 17
	(<i>Soot blowing</i>)	Oil	0.3 max. 3 hrs .
NOx RACT	Oil	0.62 or 1891lbs/hr	CEM
	Gas	0.50 or 1630 lbs/hr	CEM
SO2	Oil	2.75	Monthly fuel analysis

For compliance with each of these emission limits, FPL uses annual stack tests, and the monthly fuel analysis as specified. Records are maintained to demonstrate compliance.

5. To determine compliance with the oil firing heat input limitation, the Permittee shall maintain daily records of fuel oil consumption for each boiler and monthly records of heating value for such fuel. All records shall be maintained for a minimum of three years after the date of each record and shall be made available to representatives of FDEP upon request. *FPL has these records available.*

6. Any change in the method of operation, fuels or equipment shall be submitted for approval to FDEP's Bureau of Air Regulation. *FPL has not undertaken any such changes, but if changes are contemplated, will notify the Department as specified.*

Attachment PRVU1-15
Acid Rain Part Application

Phase II Acid Rain Part Application

For more information, see instructions and refer to 40 CFR 72.30 and 72.31 and Chapter 62-214, F.A.C.

This submission is: New Revised

STEP 1

Identify the source by plant name, State, and ORIS code from NADB

Plant Name RIVIERA Plant	State FL	ORIS Code 619
---------------------------------	-----------------	----------------------

STEP 2 Enter the unit ID# for each affected unit and indicate whether a unit is being repowered and the repowering plan being renewed by entering "yes" or "no" at column c. For new units, enter the requested information in columns d and e.

Compliance Plan				
a	b	c	d	e
Unit ID#	Unit will hold allowances in accordance with 40 CFR 72.9(c)(1)	Repowering Plan	New Units Commence Operation Date	New Units Monitor Certification Deadline
	Yes			
PRV3	Yes	NO	N/A	N/A
PRV4	Yes	NO	N/A	N/A
	Yes			
	Yes			
	Yes			
	Yes			
	Yes			
	Yes			
	Yes			
	Yes			
	Yes			
	Yes			
	Yes			

STEP 3

Check the box if the response in column c of Step 2 is "Yes" for any unit

For each unit that is being repowered, the Repowering Extension Plan form is included.

Plant Name (from Step 1)
RIVIERA Plant

STEP 4
 Read the standard requirements and certification, enter the name of the designated representative, and sign and date

Standard Requirements

Acid Rain Part Requirements.

- (1) The designated representative of each Acid Rain source and each Acid Rain unit at the source shall:
 - (i) Submit a complete Acid Rain part application (including a compliance plan) under 40 CFR part 72 and Rules 62-214.320 and 330, F.A.C., in accordance with the deadlines specified in Rule 62-214.320, F.A.C.; and
 - (ii) Submit in a timely manner any supplemental information that the Department determines is necessary in order to review an Acid Rain part application and issue or deny an Acid Rain part;
- (2) The owners and operators of each Acid Rain source and each Acid Rain unit at the source shall:
 - (i) Operate the unit in compliance with a complete Acid Rain part application or a superseding Acid Rain part issued by the Department; and
 - (ii) Have an Acid Rain Part.

Monitoring Requirements.

- (1) The owners and operators and, to the extent applicable, designated representative of each Acid Rain source and each Acid Rain unit at the source shall comply with the monitoring requirements as provided in 40 CFR part 75, and Rule 62-214.420, F.A.C.
- (2) The emissions measurements recorded and reported in accordance with 40 CFR part 75 shall be used to determine compliance by the unit with the Acid Rain emissions limitations and emissions reduction requirements for sulfur dioxide and nitrogen oxides under the Acid Rain Program.
- (3) The requirements of 40 CFR part 75 shall not affect the responsibility of the owners and operators to monitor emissions of other pollutants or other emissions characteristics at the unit under other applicable requirements of the Act and other provisions of the operating permit for the source.

Sulfur Dioxide Requirements.

- (1) The owners and operators of each source and each Acid Rain unit at the source shall:
 - (i) Hold allowances, as of the allowance transfer deadline, in the unit's compliance subaccount (after deductions under 40 CFR 73.34(c)) not less than the total annual emissions of sulfur dioxide for the previous calendar year from the unit; and
 - (ii) Comply with the applicable Acid Rain emissions limitations for sulfur dioxide.
- (2) Each ton of sulfur dioxide emitted in excess of the Acid Rain emissions limitations for sulfur dioxide shall constitute a separate violation of the Act.
- (3) An Acid Rain unit shall be subject to the requirements under paragraph (1) of the sulfur dioxide requirements as follows:
 - (i) Starting January 1, 2000, an Acid Rain unit under 40 CFR 72.6(a)(2); or
 - (ii) Starting on the later of January 1, 2000 or the deadline for monitor certification under 40 CFR part 75, an Acid Rain unit under 40 CFR 72.6(a)(3).
- (4) Allowances shall be held in, deducted from, or transferred among Allowance Tracking System accounts in accordance with the Acid Rain Program.
- (5) An allowance shall not be deducted in order to comply with the requirements under paragraph (1)(i) of the sulfur dioxide requirements prior to the calendar year for which the allowance was allocated.
- (6) An allowance allocated by the Administrator under the Acid Rain Program is a limited authorization to emit sulfur dioxide in accordance with the Acid Rain Program. No provision of the Acid Rain Program, the Acid Rain part application, the Acid Rain part, or an exemption under 40 CFR 72.7, 72.8, or 72.14 and no provision of law shall be construed to limit the authority of the United States to terminate or limit such authorization.
- (7) An allowance allocated by the Administrator under the Acid Rain Program does not constitute a property right.

Nitrogen Oxides Requirements. The owners and operators of the source and each Acid Rain unit at the source shall comply with the applicable Acid Rain emissions limitation for nitrogen oxides.

Excess Emissions Requirements.

- (1) The designated representative of an Acid Rain unit that has excess emissions in any calendar year shall submit a proposed offset plan, as required under 40 CFR part 77
- (2) The owners and operators of an Acid Rain unit that has excess emissions in any calendar year shall:
 - (i) Pay without demand the penalty required, and pay upon demand the interest on that penalty, as required by 40 CFR part 77; and
 - (ii) Comply with the terms of an approved offset plan, as required by 40 CFR part 77.

Recordkeeping and Reporting Requirements.

- (1) Unless otherwise provided, the owners and operators of the source and each Acid Rain unit at the source shall keep on site at the source each of the following documents for a period of 5 years from the date the document is created. This period may be extended for cause, at any time prior to the end of 5 years, in writing by the EPA or the Department:
 - (i) The certificate of representation for the designated representative for the source and each Acid Rain unit at the source and all documents that demonstrate the truth of the statements in the certificate of representation, in accordance with Rule 62-214.350, F.A.C.; provided that the certificate and documents shall be retained on site at the source beyond such 5-year period until such documents are superseded because of the submission of a new certificate of representation changing the designated representative;
 - (ii) All emissions monitoring information, in accordance with 40 CFR part 75, provided that to the extent that 40 CFR part 75 provides for a 3-year period for recordkeeping, the 3-year period shall apply;
 - (iii) Copies of all reports, compliance certifications, and other submissions and all records made or required under the Acid Rain Program; and

Plant Name (from Step 1)
RIVIERA Plant

Recordkeeping and Reporting Requirements (cont)

(iv) Copies of all documents used to complete an Acid Rain part application and any other submission under the Acid Rain Program or to demonstrate compliance with the requirements of the Acid Rain Program.

(2) The designated representative of an Acid Rain source and each Acid Rain unit at the source shall submit the reports and compliance certifications required under the Acid Rain Program, including those under 40 CFR part 72 subpart I and 40 CFR part 75.

Liability.

(1) Any person who knowingly violates any requirement or prohibition of the Acid Rain Program, a complete Acid Rain part application, an Acid Rain part, or an exemption under 40 CFR 72.7, 72.8 or 72.14, including any requirement for the payment of any penalty owed to the United States, shall be subject to enforcement pursuant to section 113(c) of the Act.

(2) Any person who knowingly makes a false, material statement in any record, submission, or report under the Acid Rain Program shall be subject to criminal enforcement pursuant to section 113(c) of the Act and 18 U.S.C. 1001.

(3) No permit revision shall excuse any violation of the requirements of the Acid Rain Program that occurs prior to the date that the revision takes effect.

(4) Each Acid Rain source and each Acid Rain unit shall meet the requirements of the Acid Rain Program.

(5) Any provision of the Acid Rain Program that applies to an Acid Rain source (including a provision applicable to the designated representative of an Acid Rain source) shall also apply to the owners and operators of such source and of the Acid Rain units at the source.

(6) Any provision of the Acid Rain Program that applies to an Acid Rain unit (including a provision applicable to the designated representative of an Acid Rain unit) shall also apply to the owners and operators of such unit. Except as provided under 40 CFR 72.44 (Phase II repowering extension plans) and 40 CFR 76.11 (NO_x averaging plans), and except with regard to the requirements applicable to units with a common stack under 40 CFR part 75 (including 40 CFR 75.16, 75.17, and 75.18), the owners and operators and the designated representative of one Acid Rain unit shall not be liable for any violation by any other Acid Rain unit of which they are not owners or operators or the designated representative and that is located at a source of which they are not owners or operators or the designated representative.

(7) Each violation of a provision of 40 CFR parts 72, 73, 75, 76, 77, and 78 by an Acid Rain source or Acid Rain unit, or by an owner or operator or designated representative of such source or unit, shall be a separate violation of the Act.

Effect on Other Authorities. No provision of the Acid Rain Program, an Acid Rain part application, an Acid Rain part, or an exemption under 40 CFR 72.7, 72.8, or 72.14 shall be construed as:

(1) Except as expressly provided in title IV of the Act, exempting or excluding the owners and operators and, to the extent applicable, the designated representative of an Acid Rain source or Acid Rain unit from compliance with any other provision of the Act, including the provisions of title I of the Act relating to applicable National Ambient Air Quality Standards or State Implementation Plans;

(2) Limiting the number of allowances a unit can hold; *provided*, that the number of allowances held by the unit shall not affect the source's obligation to comply with any other provisions of the Act;

(3) Requiring a change of any kind in any State law regulating electric utility rates and charges, affecting any State law regarding such State regulation, or limiting such State regulation, including any prudence review requirements under such State law;

(4) Modifying the Federal Power Act or affecting the authority of the Federal Energy Regulatory Commission under the Federal Power Act; or,

(5) Interfering with or impairing any program for competitive bidding for power supply in a State in which such program is established.

Certification

I am authorized to make this submission on behalf of the owners and operators of the Acid Rain source or Acid Rain units for which the submission is made. I certify under penalty of law that I have personally examined, and am familiar with, the statements and information submitted in this document and all its attachments. Based on my inquiry of those individuals with primary responsibility for obtaining the information, I certify that the statements and information are to the best of my knowledge and belief true, accurate, and complete. I am aware that there are significant penalties for submitting false statements and information or omitting required statements and information, including the possibility of fine or imprisonment.

Name: Nancy Kierspe	
Signature <i>Nancy Kierspe</i>	Date 4-7-03

WALKDOWN INFORMATION		TECHNICAL ACCEPTANCE	
ORG	BY	ORG	BY
AS-BUILT INFORMATION	DATE	ENGINEERING ORGANIZATION	DATE

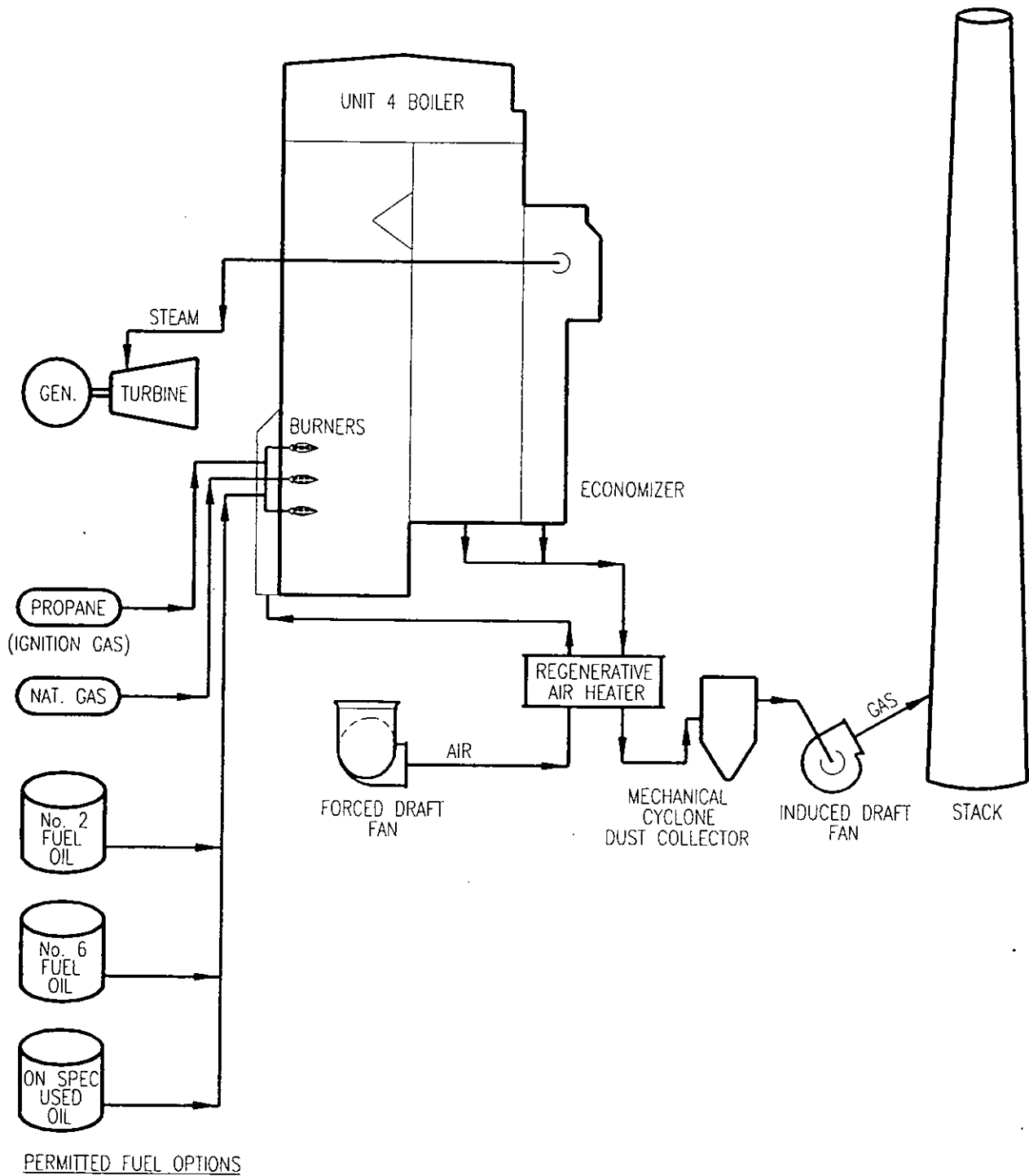

BAR CODE

	SYSTEM	YY	DISCIPLINE	M	PLANT/UNIT	RIVIERA PLANT
	SCALE	N/A	CAD FILE NAME	RV002857	TITLE	EMISSION UNIT PROCESS FLOW DIAGRAM STEAM GENERATOR/BOILER ATTACHMENT NO. EU2
	DRAWING SIZE	A (8.5X11)	FPL ARCHIVE NAME	RV002857		
0 7/24/95 ISSUED FOR TITLE V PERMIT REV DATE REVISION DESCRIPTION		PWB PWB CSP CSP ETS BY CH COR APR ORG			DRAWING NUMBER PRV3-M0107-YY	
					SHEET	1 OF 1
					REV	0

WALKDOWN INFORMATION			TECHNICAL ACCEPTANCE		
ORG	BY	DATE	ORG	BY	DATE
AS-BUILT INFORMATION	ENGINEERING ORGANIZATION		ENGINEERING ORGANIZATION		

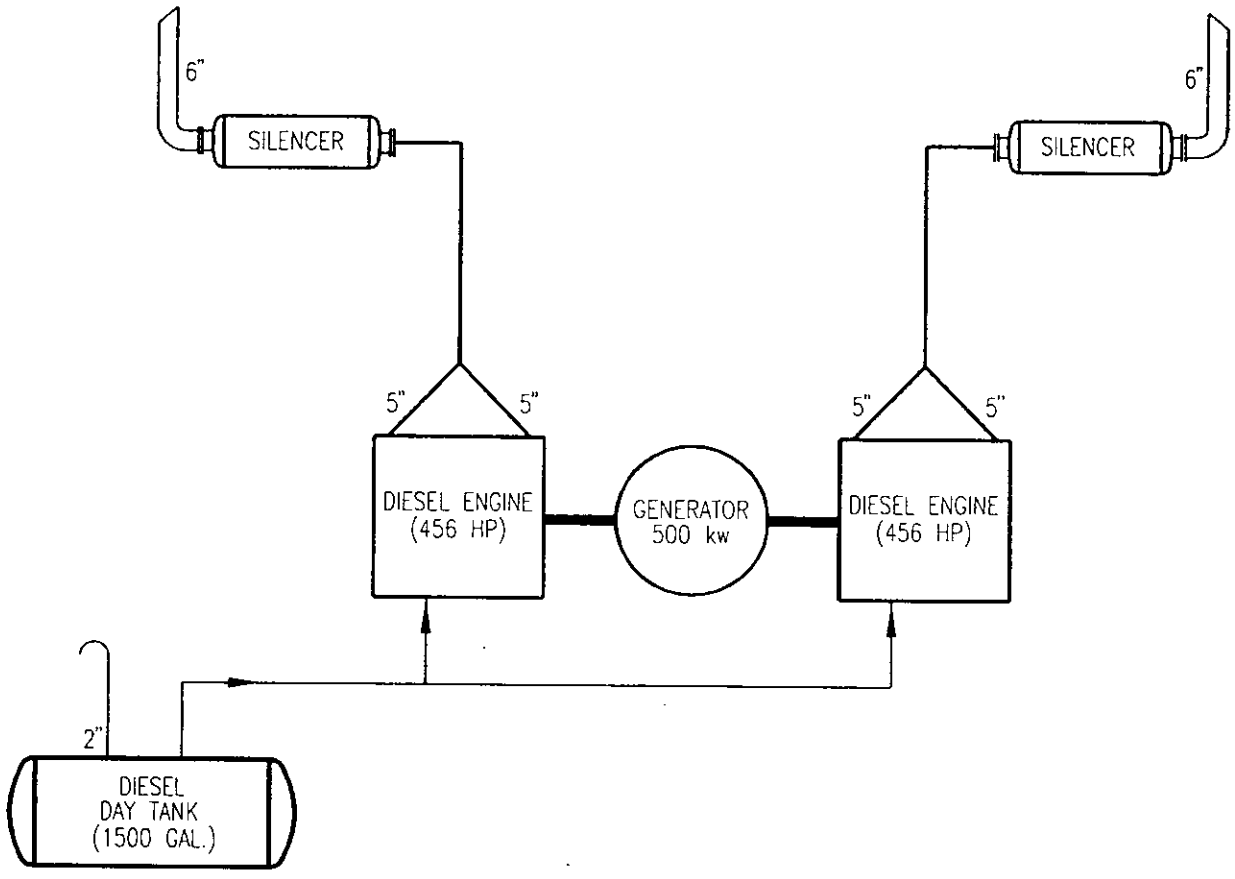

BAR CODE

REV	DATE	REVISION DESCRIPTION	BY	CH	COR	APR	ORG
0	7/24/95	ISSUED FOR TITLE V PERMIT	PWB	PWB	CSP	CSP	ETS

	SYSTEM	YY	DISCIPLINE	M	PLANT/UNIT	RIVIERA PLANT
	SCALE	N/A	CAD FILE NAME	RV002858	TITLE	EMISSION UNIT FLOW DIAGRAM EMERGENCY DIESEL GENERATOR
	DRAWING SIZE	A (8.5X11)	FPL ARCHIVE NAME	RV002858		ATTACHMENT NO. EU3

DRAWING NUMBER	PRV3-M0108-YY	SHEET	1 OF 1	REV	0
----------------	---------------	-------	--------	-----	---

Attachment PRVU3-2.txt

Fuel Analysis

Light Distillate oil (typical)*

<u>Parameter</u>	<u>Typical value</u>	<u>Max value</u>
API gravity @ 60 F	41.2 ¹	51 ¹
Relative density	285 lb / bbl ²	not applicable
Heat content	19,130 Btu / lb	not applicable
% sulfur	0.5	not applicable
% nitrogen	9 mg / kg	not applicable
% ash	negligible	0.001 ¹

*Note: The values listed are "typical" values based upon:

1. Information FPL gathered by laboratory analysis, and
2. FPL's fuel purchasing specifications. However, analytical results from grab samples of fuel taken at any given point in time may vary from those listed.

Footnotes:

¹ Data taken from the FPL fuel purchasing specification.

² Data from laboratory analysis.

Attachment PRVU3-6.txt

Procedures for Startup / Shutdown

The emergency diesel generator is the main backup power supply component for the fossil steam boiler generating units. The function of the emergency diesel generator is to supply electric power to key power plant equipment during emergency loss-of-power situations. This equipment is typically test-run on a monthly basis to ensure that it will function properly when needed in an emergency.

Startup for the emergency diesel generator begins with actuating a switch which sends an electric signal to a starter motor on the diesel engine which "turns over" the diesel engine until ignition of the diesel fuel commences.

Shutdown is performed when the normal electric power supply to plant equipment is restored. Shutdown is performed by shutting off the diesel fuel supply to the emergency diesel generator.

Best Operating Practices include proper maintenance of the diesel engine on the generating unit, and monitoring the visible emissions from the emergency diesel generator to ensure that the opacity limitation is not exceeded. All efforts to minimize both the level and duration of excess emissions are undertaken.

ATTACHMENT PRV – FW

**LIST OF UNREGULATED TRIVIAL AND
DE MINIMIS EMISSION UNITS**

Following are several pages of unregulated trivial and *de minimis* emission units and activities at the facility. The trivial activities identified in this application are provided for information only and are identified as examples of, but not limited to, the trivial activities identified by the Division of Air Resources Management's (DARM) guidance. It is understood that such activities do not have to be included with the Title V Application. The trivial activities identified herein are consistent, in terms of emissions and types, with those activities listed in the DARM guidance.

Pursuant to Rule 62-210.300(3)(b)1., notice is herein provided that the emission units listed below are not subject to a permit issued by the Department of Environmental Protection and are exempt from permitting. These units would not have triggered review under Rules 62-212.400 or 62-212.500 or any new source performance standard listed in Rule 62-204.800, F.A.C.

ATTACHMENT PRV – FW

UNITS 3 & 4 BOILER/STEAM GENERATOR POWER BLOCKS

Steam Systems

Steam Drum Relief Valves w/Silencers

Steam Drum - 1½" Maintenance Valves

Super Heater Inlet Header - 1 ½" Maintenance Valves

Main Steam Relief Valves w/Silencers

Economizer Inlet Header - 1" Maintenance Vents

Desuperheater - 4" Relief Valve w/Silencer & Exhaust Hood

Extraction Heaters Relief Valves

Extraction Heaters Maintenance Vents

Continuous Blowdown Flash Tank Relief Valve

Blowdown Flash Pipe - 14 Vent w/Silencer & Exhaust Hood

Steam Seal Regulator Relief Valves

Hogging Ejector 8" Vent w/Silencer & Exhaust Hood

Priming Ejector 8" Vent w/Silencer & Exhaust Hood

After Condenser Maintenance Vent

Priming Ejector Relief Valve

Main Steam at Stop Valves - 1½" Maintenance Vents

Boiler Feed, Condensate & Heater Drains

Extraction Heater - ¾" Feedwater Maintenance Vents

Extraction Heaters - ¾" Feedwater Relief Valves

Feedwater at Boiler Feed Pumps - ¾" Safety Valves

Condensate Collecting Cooler - ¾" Vent

Flash Tank - 3" Relief Valve

Vent Condenser - ¾" Maintenance Vent

Condensate Storage Tank - Continuous Vent

ATTACHMENT PRV – FW

Boiler Feed, Condensate & Heater Drains (continued)

Gland Steam Condenser 8" Continuous Vent

Gland Steam Condenser 1" Relief Valve

After Condenser Maintenance Vent

Intercondenser Maintenance Vent

Hydrazine Pumps Relief Valve

Phosphate Pumps Relief Valves

Cooling Water

Cooling Water Surge Tank - 3 Continuous Vent

Turbine Lube Oil Coolers - Maintenance Vent

Evaporator Relief Valve

Evaporator Continuous Vent

Fuel Oil

268,000 BBL Storage Tank 12" Vent

150,000 BBL Storage Tank Vent

55,000 BBL Storage Tank Vent

55,000 BBL Storage Tank Vent

4,500 BBL Metering Tank Vent

Diesel Generator Fuel Tank (1500 Gal) 2" Vents

Fuel Oil Additive Tanks (3700 Gal & 1700 Gal)

Burner Booster Pumps - Maintenance Vents

Oil Recovery Blow Back Tank - Relief Valve

Oil Recovery Blow Back Tank - 1" Maintenance Vent

Service Air at Blow Back Tank - Maintenance Vent

ATTACHMENT PRV – FW

Lube Oil

Generator Loop Seal Tank - 4" Continuous Vent w / Exhaust Head

Oil Mist Eliminator - 4" Vapor Extractor

Lube Oil Coolers Maintenance Vent

Lube Oil Reservoir Filter Vent

Gas burner header vent valve

Lube Oil Filter-Filter Vent

Lube Oil Filter Water Ejector

Gas Supply

Vent Valve

Ignition Gas Propane Tank (500 Gal)

C.E.M. Equipment

Monitoring Gases

Lime Slurry, Caustic Wash & Instrument Air

Lime Slurry Mixing Tank (2000 Gal)

Lime Slurry Service tank

Caustic Wash Storage Tank - (3000 Gal.)- 2" Vent

Caustic Wash Mixing Tank (1690 Gal)

Instrument Air Tanks - Relief Valves

Air Compressors Relief Valves

Separator Relief Valves

Water Treatment Equipment (abandoned in place)

Caustic Service Tank - (4900 Gal) -2" Vent

Sodium Bisulfite Storage Tank (5000 Gal)-4" Vent

Carbon Purifier- ½" Vent

Sand Filter- ½" Vent

Waste Neutralizing T.E.T.F. (34,000 Gal Tank)- 8" Vent

ATTACHMENT PRV – FW

Water Treatment (continued)

Elevated Water Storage Tank Vent

Waste Neutralizing Cement Basin (10,771 Gal)

City Water Basin (94,764 Gal)

Demineralizer Recovery Basin (8025 Gal)

Soda Ash Service Tank (3165 Gal)

Soda Ash Mixing Tank (1690 Gal)

Waste Water & Basins

Oily Waste Water Sumps & Separator

Solids Settling Basins

Miscellaneous Buildings Kitchen Exhaust

Training & Conference Facility

Service Bldg.

Miscellaneous Buildings H.V.A.C. (Cooling/Heating)

P.G.B.U. Training Bldg.

Conference Facility

Stores Warehouse

Doc. Control Bldg.

Water Treatment Lab

Hightower Storage Bldg.

Maintenance Warehouse Office

Switchyard Control Bldg.

Dry Storage Warehouse

Operations/Overhaul Bldg.

Service Bldg.

ATTACHMENT PRV – FW

Miscellaneous Buildings Vent/Exhaust Systems

Conference Facility

Stores Warehouse

Doc. Control Bldg.

Paint/Lube Oil Bldg.

Emergency Spill Bldg.

Miscellaneous Buildings Vent/Exhaust Systems (Continued)

Lab/Water Treat. Bldg.

Chem. Storage Bldg.

Chlorination Bldg.

F.O. Pump Pit Enclosure

Maint. Warehouse Office

Lube Oil Storage Bldg.

Hazardous Waste Drum Storage Bldg.

Switchyard Control Bldg.

Operations/Overhaul Bldg.

Service Bldg.

Control Bldg. - Relay & Battery Rooms

Miscellaneous Buildings Sanitary Vents/Stacks

Conference facility

Stores Warehouse

Doc. Control Bldg.

Recreation Pavilion

Operations/Overhaul Bldg.

Service Building

Control Building

P.G.B.U. Training Annex

ATTACHMENT PRV – FW

Miscellaneous Activities

Home heating and comfort heating with a gross maximum heat output of less than one million BTU/hr.

Internal combustion engines in boats, aircraft and vehicles used for transportation of passengers or freight

Vacuum pumps used in laboratory operations

Various equipment used for steam cleaning

Belt or drum sanders having a total sanding surface of five square feet or less and other equipment used exclusively on wood or plastics or their products having a density of 20 pounds per cubic foot or more.

Equipment used exclusively for space heating, other than boilers

Laboratory equipment used exclusively for chemical or physical analysis

Bulk Gas

Storage Cylinders

Miscellaneous Activities

Plant Grounds Maintenance

Routine Maintenance/Repair Activities

Non-Halogenated Solvent Cleaning Operations

Use of spray cans and solvents for routine maintenance activities

Internal Combustion Engines Which Drive Compressors, Generators, Water Pumps or other Auxiliary Equipment

Transformers, Switches and Switchgear, Processing & Venting

Electrically Heated Equipment Used for Heat Treating, Tracing, Drying, Soaking, Case Hardening or Surface Conditioning

Air Compressors and Centrifuges Used for Compressing Air

Storage of Product in Sealed Containers

Miscellaneous Mobile Vehicle Operation

Cars, Light Trucks, Heavy duty Trucks, Back Hoes, Tractors, Forklifts, Cranes, Etc.

ATTACHMENT PRV – FW

Miscellaneous Mobile Equipment Operation

Compressors, Chain Saws, Small Generators, (<100KW) Welding Machines Electric Saws & Drills, Etc.

Laundry dryers, extractors, or tumblers for fabrics cleaned with only water solutions of bleach or detergents

Fire & Safety Equipment

Surface coating facilities in ozone attainment areas (provided that 6.0 gallons of coatings per day are applied)

Degreasing units using heavier-than-air vapors exclusively, except any such unit using or emitting any substance classified as a hazardous air pollutant

Use of solvent and spray cans for maintenance activities