

SENDER: Complete items 1 and 2 when additional services are desired, and complete items 3 and 4.
 Put your address in the "RETURN TO" Space on the reverse side. Failure to do this will prevent this card from being returned to you. The return receipt fee will provide you the name of the person delivered to and the date of delivery. For additional fees the following services are available. Consult postmaster for fees and check boxes for additional service(s) requested.

1. Show to whom delivered, date, and addressee's address. (Extra charge) 2. Restricted Delivery (Extra charge)

3. Article Addressed to: R. H. Henson Mgr.-Plant Eng. United Tech. Corp./Pratt & Whitney SR 710 Beeline Highway West Palm Beach, FL 33410-9600	4. Article Number P 274 007 573
	Type of Service: <input type="checkbox"/> Registered <input type="checkbox"/> Insured <input checked="" type="checkbox"/> Certified <input type="checkbox"/> COD <input type="checkbox"/> Express Mail <input type="checkbox"/> Return Receipt for Merchandise
	Always obtain signature of addressee or agent and <u>DATE DELIVERED</u> .
5. Signature - Address X	8. Addressee's Address (ONLY if requested and fee paid)
6. Signature - Agent X <i>[Signature]</i>	
7. Date of Delivery FEB - 6 1989	

PS Form 3811, Mar. 1988 * U.S.G.P.O. 1988-212-865 DOMESTIC RETURN RECEIPT

P 274 007 573

RECEIPT FOR CERTIFIED MAIL

NO INSURANCE COVERAGE PROVIDED
 NOT FOR INTERNATIONAL MAIL
 (See Reverse)

* U.S.G.P.O. 1985-480-794

R.H. Henson	
Mgr.-Plant Eng.	
United Tech. Corp./Pratt & Whitney	
P.O. State Whitney	
SR 710 Beeline Highway	
West Palm Beach, FL 33410-9600	
Certified Fee	
Special Delivery Fee	
Restricted Delivery Fee	
Return Receipt showing to whom and Date Delivered	
Return Receipt showing to whom. Date, and Address of Delivery	
TOTAL Postage and Fees	\$
Postmark or Date AC 50-155269 mailed: 2/2/89	

PS Form 3800, June 1985

Main File Copy

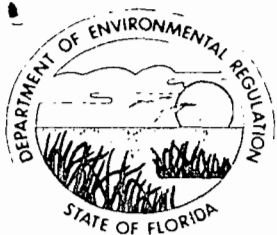

Florida Department of Environmental Regulation

Twin Towers Office Bldg. • 2600 Blair Stone Road • Tallahassee, Florida 32399-2400

Bob Martinez, Governor

Dale Twachtman, Secretary

John Shearer, Assistant Secretary

STATE OF FLORIDA DEPARTMENT OF ENVIRONMENTAL REGULATION NOTICE OF PERMIT

Mr. R. H. Henson
Manager-Plant Engineering
United Technologies Corp./Pratt & Whitney
SR 710 Beeline Highway
West Palm Beach, Florida 33410-9600

February 2, 1989

Enclosed is permit No. AC 50-155269 for United Technologies Corp. to install an open-top vapor degreaser at their facility near West Palm Beach, Florida. This permit is issued pursuant to Section 403, Florida Statutes.

Any party to this permit has the right to seek judicial review of the permit pursuant to Section 120.68, Florida Statutes, by the filing of a Notice of Appeal pursuant to Rule 9.110, Florida Rules of Appellate Procedure, with the Clerk of the Department in the Office of General Counsel, 2600 Blair Stone Road, Tallahassee, Florida 32399-2400; and by filing a copy of the Notice of Appeal accompanied by the applicable filing fees with the appropriate District Court of Appeal. The Notice of Appeal must be filed within 30 days from the date this permit is filed with the Clerk of the Department.

Executed in Tallahassee, Florida.

STATE OF FLORIDA DEPARTMENT
OF ENVIRONMENTAL REGULATION

C. H. Fancy, P.E.
Deputy Chief
Bureau of Air Quality Management

Copy furnished to:

- I. Goldman, SE District
- V. Goldsmith, Pratt & Whitney
- G. Sacco, PBCHD

CERTIFICATE OF SERVICE

The undersigned duly designated deputy clerk hereby certifies that this NOTICE OF INTENT TO ISSUE and all copies were mailed before the close of business on February 2, 1989.

FILING AND ACKNOWLEDGEMENT
FILED, on this date, pursuant to
§120.52(9), Florida Statutes, with
the designated Department Clerk,
receipt of which is hereby
acknowledged.

Richard C. Carter
Clerk

2-2-89
Date

Final Determination

United Technologies Corp.
Pratt & Whitney
Palm Beach County
West Palm Beach, Florida

Open-Top Vapor Degreaser
Permit No. AC 50-155269

Florida Department of Environmental Regulation
Bureau of Air Quality Management
Central Air Permitting

January 27, 1989

Final Determination

The construction permit application has been reviewed by the Department. Public Notice of the Department's Intent to Issue was published in the Palm Beach Post on January 10, 1989. The Technical Evaluation and Preliminary Determination were available for public inspection at the DER's Southeast District office in West Palm Beach and the DER Bureau of Air Quality Management office in Tallahassee.

No comments were received during the public notice period. Therefore, the final action of the Department will be to issue the construction permit as drafted.

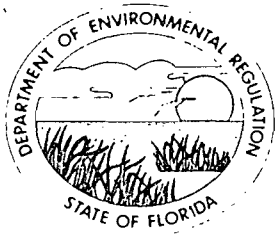

Florida Department of Environmental Regulation

Twin Towers Office Bldg. • 2600 Blair Stone Road • Tallahassee, Florida 32399-2400

Bob Martinez, Governor

Dale Twachtmann, Secretary

John Shearer, Assistant Secretary

PERMITTEE:

United Technologies Corp.,
Pratt & Whitney
SR 710 Beeline Highway
West Palm Beach, FL
33410-9600

Permit Number: AC 50-155269

Expiration Date: August 31, 1989

County: Palm Beach

Latitude/Longitude: 26° 54' 30"N

80° 22' 49"W

Project: Degreaser

This permit is issued under the provisions of Chapter 403, Florida Statutes, and Florida Administrative Code (F.A.C.) Rules 17-2 and 17-4. The above named permittee is hereby authorized to perform the work or operate the facility shown on the application and approved drawing(s), plans, and other documents attached hereto or on file with the Department and made a part hereof and specifically described as follows:

For the installation of a degreaser. This project will be located in West Palm Beach, Palm Beach County, Florida. The UTM coordinates of this site are Zone 17, 561.6 km E and 2976.3 km N.

Construction shall be in accordance with the permit application and plans, documents, and reference material submitted unless otherwise stated in the Preliminary Determination and Technical Evaluation or the General and Specific Conditions herein.

Attachments:

1. Application to Operate/Construct Air Pollution Sources, DER Form 17-1.202(1) received on September 26, 1988.

PERMITTEE:
United Technologies Corp.

Permit Number: AC 50-155269
Expiration Date: August 31, 1989

GENERAL CONDITIONS:

1. The terms, conditions, requirements, limitations, and restrictions set forth herein are "Permit Conditions" and as such are binding upon the permittee and enforceable pursuant to the authority of Sections 403.161, 403.727, or 403.859 through 403.861, Florida Statutes. The permittee is hereby placed on notice that the Department will review this permit periodically and may initiate enforcement action for any violation of the "Permit Conditions" by the permittee, its agents, employees, servants or representatives.

2. This permit is valid only for the specific processes and operations applied for and indicated in the approved drawings or exhibits. Any unauthorized deviation from the approved drawings, exhibits, specifications, or conditions of this permit may constitute grounds for revocation and enforcement action by the Department.

3. As provided in Subsections 403.087(6) and 403.722(5), Florida Statutes, the issuance of this permit does not convey any vested rights or any exclusive privileges. Nor does it authorize any injury to public or private property or any invasion of personal rights, nor any infringement of federal, state or local laws or regulations. This permit does not constitute a waiver of or approval of any other Department permit that may be required for other aspects of the total project which are not addressed in the permit.

4. This permit conveys no title to land or water, does not constitute state recognition or acknowledgement of title, and does not constitute authority for the use of submerged lands unless herein provided and the necessary title or leasehold interests have been obtained from the state. Only the Trustees of the Internal Improvement Trust Fund may express state opinion as to title.

5. This permit does not relieve the permittee from liability for harm or injury to human health or welfare, animal, plant or aquatic life or property and penalties therefore caused by the construction or operation of this permitted source, nor does it allow the permittee to cause pollution in contravention of Florida Statutes and Department rules, unless specifically authorized by an order from the Department.

PERMITTEE:
United Technologies Corp.

Permit Number: AC 50-155269
Expiration Date: August 31, 1989

GENERAL CONDITIONS:

6. The permittee shall at all times properly operate and maintain the facility and systems of treatment and control (and related appurtenances) that are installed or used by the permittee to achieve compliance with the conditions of this permit, as required by Department rules. This provision includes the operation of backup or auxiliary facilities or similar systems when necessary to achieve compliance with the conditions of the permit and when required by Department rules.

7. The permittee, by accepting this permit, specifically agrees to allow authorized Department personnel, upon presentation of credentials or other documents as may be required by law, access to the premises, at reasonable times, where the permitted activity is located or conducted for the purpose of:

- a. Having access to and copying any records that must be kept under the conditions of the permit;
- b. Inspecting the facility, equipment, practices, or operations regulated or required under this permit; and
- c. Sampling or monitoring any substances or parameters at any location reasonably necessary to assure compliance with this permit or Department rules.

Reasonable time may depend on the nature of the concern being investigated.

8. If, for any reason, the permittee does not comply with or will be unable to comply with any condition or limitation specified in this permit, the permittee shall immediately notify and provide the Department with the following information:

- a. A description of and cause of non-compliance; and
- b. The period of non-compliance, including exact dates and times; or, if not corrected, the anticipated time the non-compliance is expected to continue, and steps being taken to reduce, eliminate, and prevent recurrence of the non-compliance.

PERMITTEE:
United Technologies Corp.

Permit Number: AC 50-155269
Expiration Date: August 31, 1989

GENERAL CONDITIONS:

The permittee shall be responsible for any and all damages which may result and may be subject to enforcement action by the Department for penalties or revocation of this permit.

9. In accepting this permit, the permittee understands and agrees that all records, notes, monitoring data and other information relating to the construction or operation of this permitted source, which are submitted to the Department, may be used by the department as evidence in any enforcement case arising under the Florida Statutes or Department rules, except where such use is proscribed by Sections 403.73 and 403.111, Florida Statutes.

10. The permittee agrees to comply with changes in Department rules and Florida Statutes after a reasonable time for compliance, provided however, the permittee does not waive any other rights granted by Florida Statutes or Department rules.

11. This permit is transferable only upon Department approval in accordance with Florida Administrative Code Rules 17-4.12 and 17-30.30, as applicable. The permittee shall be liable for any noncompliance of the permitted activity until the transfer is approved by the Department.

12. This permit is required to be kept at the work site of the permitted activity during the entire period of construction or operation.

13. This permit also constitutes:

- () Determination of Best Available Control Technology (BACT)
- () Determination of Prevention of Significant Deterioration (PSD)
- () Compliance with New Source Performance Standards

14. The permittee shall comply with the following monitoring and record keeping requirements:

- a. Upon request, the permittee shall furnish all records and plans required under Department rules. The retention period for all records will be extended automatically, unless otherwise stipulated by the Department, during the course of any unresolved enforcement action.

PERMITTEE:
United Technologies Corp.

Permit Number: AC 50-155269
Expiration Date: August 31, 1989

GENERAL CONDITIONS:

- b. The permittee shall retain at the facility or other location designated by this permit records of all monitoring information (including all calibration and maintenance records and all original strip chart recordings for continuous monitoring instrumentation), copies of all reports required by this permit, and records of all data used to complete the application for this permit. The time period of retention shall be at least three years from the date of the sample, measurement, report or application unless otherwise specified by Department rule.
- c. Records of monitoring information shall include:
 - the date, exact place, and time of sampling or measurements;
 - the person responsible for performing the sampling or measurements;
 - the date(s) analyses were performed;
 - the person responsible for performing the analyses;
 - the analytical techniques or methods used; and
 - the results of such analyses.

15. When requested by the Department, the permittee shall within a reasonable time furnish any information required by law which is needed to determine compliance with the permit. If the permittee becomes aware that relevant facts were not submitted or were incorrect in the permit application or in any report to the Department, such facts or information shall be submitted or corrected promptly.

SPECIFIC CONDITIONS:

1. The construction and operation of this source shall be in accordance with the capacities and specifications stated in the application.
2. The degreaser shall be allowed to operate for up to 4,000 hours per year.
3. Trichloroethylene emissions (VOC) shall not exceed 1.24 lbs/hr and 2.48 tons per year. Compliance shall be demonstrated by subtracting the amount of recovered waste solvent from the amount of solvent actually consumed during the compliance period.

PERMITTEE:
United Technologies Corp.

Permit Number: AC 50-155269
Expiration Date: August 31, 1989

SPECIFIC CONDITIONS:

4. The degreaser shall comply with all requirements specified in F.A.C. Rule 17-2.650(1)(f)12.c.

5. Compliance shall be demonstrated over a 30 day period after operation begins and the results reported to the Department before this construction permit expires. The Department shall be notified at least 5 days prior to the degreaser being placed in operation.

6. The permittee, for good cause, may request that this construction permit be extended. Such a request shall be submitted to the BAQM prior to 60 days before the expiration of the permit (F.A.C. 17-4.090).

7. An application for an operation permit must be submitted to the DER's Southeast District office at least 90 days prior to the expiration date of this construction permit. To properly apply for an operation permit, the applicant shall submit an application, the appropriate fee, certification that construction was completed, noting any deviations from the conditions in the construction permit, and compliance test reports as required by this permit (F.A.C. 17-4.220).

Issued this 31 day of January
1989

STATE OF FLORIDA DEPARTMENT
OF ENVIRONMENTAL REGULATION

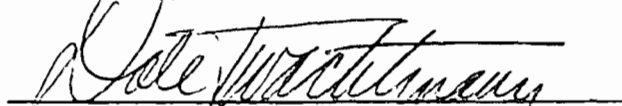
Dale Twachtmann, Secretary



State of Florida
DEPARTMENT OF ENVIRONMENTAL REGULATION

For Routing To Other Than The Addressee	
To: _____	Location: _____
To: _____	Location: _____
To: _____	Location: _____
From: _____	Date: _____

Interoffice Memorandum

TO: Dale Twachtmann

for FROM: Steve Smallwood 

SUBJ: Approval of Construction Permit No. AC 50-155269
United Technologies Corp./Pratt & Whitney

DATE: January 27, 1989

Attached for your approval and signature is a permit prepared by Central Air Permitting for the above mentioned company to install an open-top vapor degreaser.

No comments were received during the public notice period.

Day 90, after which this permit will be issued by default, is February 10, 1989.

I recommend your approval and signature.

SS/JR/s

Attachments

RECEIVED
JAN 30 1989

Office of the Secretary

Check Sheet

Company Name: United Technologies, Pratt & Whitney
Permit Number: AC50-155269
PSD Number: _____
Permit Engineer: _____

Application:

- | | |
|---|--------------------------|
| <input checked="" type="checkbox"/> Initial Application | Cross References: |
| <input type="checkbox"/> Incompleteness Letters | <input type="checkbox"/> |
| <input type="checkbox"/> Responses | <input type="checkbox"/> |
| <input type="checkbox"/> Waiver of Department Action | <input type="checkbox"/> |
| <input type="checkbox"/> Department Response | |
| <input type="checkbox"/> Other | |

Intent:

- Intent to Issue
 - Notice of Intent to Issue
 - Technical Evaluation
 - BACT or LAER Determination
 - Unsigned Permit
- Correspondence with:
- EPA
 - Park Services
 - Other
- Proof of Publication
 - Petitions - (Related to extensions, hearings, etc.)
 - Waiver of Department Action
 - Other

Final

Determination:

- Final Determination
- Signed Permit
- BACT or LAER Determination
- Other

Post Permit Correspondence:

- Extensions/Amendments/Modifications
- Other



Florida Department of Environmental Regulation

Twin Towers Office Bldg. • 2600 Blair Stone Road • Tallahassee, Florida 32399-2400

Bob Martinez, Governor

Dale Twachtmann, Secretary

John Shearer, Assistant Secretary

December 12, 1989

CERTIFIED MAIL - RETURN RECEIPT REQUESTED

Mr. W. J. Dail, Manager
Utilities Operations/Environmental Affairs
United Technologies - Pratt & Whitney
Post Office Box 109600
West Palm Beach, Florida 33410-9600

Dear Mr. Dail:

The Department received your request for an extension of the expiration date for the construction permit referenced below. The request is acceptable and the following shall be changed:

Project: AC 50-155269

From: February 28, 1990

To: August 31, 1990

Attachment to be Incorporated:

Letter from United Technologies dated November 15, 1989, requesting a change in the expiration date.

A copy of this letter must be attached to the above construction permit and shall become a part of this permit.

Sincerely,

Dale Twachtmann
Secretary

DT/plm

cc: I. Goldman, SE District
V. Goldsmith, UTC/P & W
G. Sacco, PBCHD



State of Florida
DEPARTMENT OF ENVIRONMENTAL REGULATION

For Routing To Other Than The Addressee	
To: _____	Location: _____
To: _____	Location: _____
To: _____	Location: _____
From: _____	Date: _____

Interoffice Memorandum

TO: Dale Twachtmann

for FROM: Steve Smallwood *et al*

DATE: December 12, 1989

SUBJ: Amendments to Construction Permit No. AC 50-155269
United Technologies - Pratt & Whitney

Attached for your approval and signature is a letter extending the expiration date for the above referenced construction permit.

The Bureau recommends approval of this amendment.

Attachment

SS/JR/plm

RECEIVED
DEC 12 1989

Office of the Secretary

*Please call
Patty Adams
when signed
8-1344*

RECEIVED Government Products Division

NOV 20 1989

DER - BAQM

November 15, 1989

Mr. C. H. Fancy, P.E.
Deputy Chief
Department of Air Quality Management
Florida Department of Environmental Regulation
2600 Blair Stone Road
Tallahassee, FL 32399-2400

Re: Open Top Vapor Degreaser Construction Permit
AC 50-155269 - Request for Extension

Dear Mr. Fancy:

Due to delays in installing the above referenced degreaser, it is requested that the construction permit be extended an additional six months. This will allow sufficient time for us to complete installation of the degreaser and perform the compliance testing in accordance with specific condition #5 of the permit.

Your help in this matter is greatly appreciated. Should you have any questions, please contact Lisa Hill at (407) 796-5655.

Sincerely,



W. J. Dail
Manager
Utilities Operations/Environmental Affairs

cc: S. Brattebo
C. Debisschop
R. Henson
L. Hill
I. Goldman - DER - WPB
V. Goldsmith
J. Stormer - PBCHD
File - Air Pollution Correspondence

pc (8672e)

cc: J. Reynolds
CAF/ST



Government Products Division
P.O. Box 109600
West Palm Beach, FL 33410-9600

Mr. C. H. Fancy, P.E.
Deputy Chief
Department of Air Quality Management
Florida Department of Environmental Regulation
2600 Blair Stone Road
Tallahassee, Fl. 32399-2400

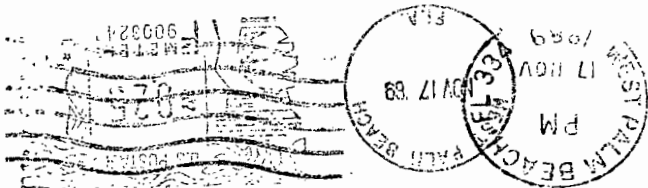

PS Form 3800, June 1985

P 938 762 633

RECEIPT FOR CERTIFIED MAIL

NO INSURANCE COVERAGE PROVIDED
NOT FOR INTERNATIONAL MAIL

(See Reverse)

Sent to	Mr. W. J. Dail, United Tech.
Street and No.	P.O. Box 109600
P.O. State and ZIP Code	W. Palm Beach, FL 33410-9600
Postage	\$
Certified Fee	
Special Delivery Fee	
Restricted Delivery Fee	
Return Receipt showing to whom and Date Delivered	
Return Receipt showing to whom, Date, and Address of Delivery	
TOTAL Postage and Fees	\$
Postmark or Date	Mailed: 7-28-89 Permit: AC 50-155269

SENDER: Complete items 1 and 2 when additional services are desired, and complete items 3 and 4. Put your address in the "RETURN TO" Space on the reverse side. Failure to do this will prevent this card from being returned to you. The return receipt fee will provide you the name of the person delivered to and the date of delivery. For additional fees the following services are available. Consult postmaster for fees and check box(es) for additional service(s) requested.

1. Show to whom delivered, date, and addressee's address. 2. Restricted Delivery (Extra charge)

3. Article Addressed to: Mr. W. J. Dail, Manager Utilities Operations/Env. Affairs United Technologies-Pratt & Whitney P. O. Box 109600 West Palm Beach, FL 33410-9600	4. Article Number P 938 762 633
	Type of Service: <input type="checkbox"/> Registered <input type="checkbox"/> Insured <input checked="" type="checkbox"/> Certified <input type="checkbox"/> COD <input type="checkbox"/> Express Mail <input type="checkbox"/> Return Receipt for Merchandise
	Always obtain signature of addressee or agent and DATE DELIVERED.
5. Signature — Address X	8. Addressee's Address (ONLY if requested and fee paid)
6. Signature — Agent X	
7. Date of Delivery JUL 31 1989	

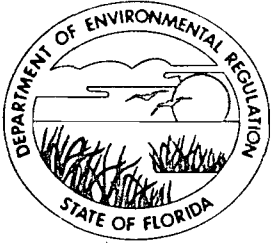

Florida Department of Environmental Regulation

Twin Towers Office Bldg. • 2600 Blair Stone Road • Tallahassee, Florida 32399-2400

Bob Martinez, Governor

Dale Twachtmann, Secretary

John Shearer, Assistant Secretary

July 26, 1989

CERTIFIED MAIL - RETURN RECEIPT REQUESTED

Mr. W. J. Dail, Manager
Utilities Operations/Environmental Affairs
United Technologies-Pratt & Whitney
Post Office Box 109600
West Palm Beach, Florida 33410-9600

Dear Mr. Dail:

The Department received your request for an extension of the expiration date for the construction permit referenced below. The request is acceptable and the following shall be changed:

Project: AC 50-155269

From: August 31, 1989

To: February 28, 1990

Attachment to be Incorporated:

Letter from United Technologies dated June 1, 1989, requesting a change in the expiration date.

This letter must be attached to your construction permit AC 50-155269 and shall become a part of that permit.

Sincerely,

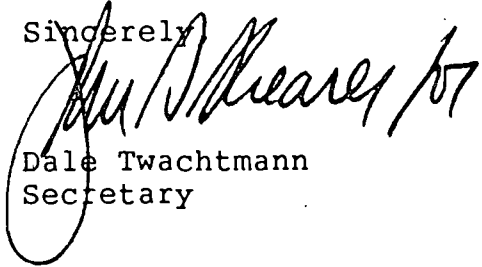
Dale Twachtmann
Secretary

DT/ks

cc: I. Goldman, SE District
V. Goldsmith, UTC/P & W
G. Sacco, PBCHD

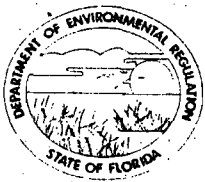

State of Florida
DEPARTMENT OF ENVIRONMENTAL REGULATION

For Routing To Other Than The Addressee	
To: _____	Location: _____
To: _____	Location: _____
To: _____	Location: _____
From: _____	Date: _____

Interoffice Memorandum

TO: Dale Twachtmann
FROM: Steve Smallwood *by [Signature]*
DATE: July 26, 1989
SUBJ: Extension of Permit
United Technologies Corp.

RECEIVED
JUL 26 1989

Office of the Secretary

Attached for your approval and signature is a letter extending the expiration date of United Technologies' permit for their opentop vapor degreaser. The company has experienced difficulties with installation of the degreaser.

I recommend your approval and signature.

SS/JR/s

attachment



Cypress mail
B 95791105
6-1-89
West Palm Beach, FL

file copy
P.O. Box 109600
West Palm Beach, FL 33410-9600
(305) 840-2000

Government Engine Business

June 1, 1989

Mr. C. H. Fancy, P.E.
Deputy Chief
Department of Air Quality Management
Florida Department of Environmental Regulation
2600 Blair Stone Road
Tallahassee, FL 32399-2400

Re: Open Top Vapor Degreaser Construction Permit
AC 50-155269 - Request for Extension

Dear Mr. Fancy:

Due to installation problems, we will be unable to submit an application for an operation permit 90 days prior to the expiration date of the above referenced permit. Therefore, in accordance with specific condition #6 of the permit, we request that the construction permit be extended an additional six (6) months. This will allow sufficient time for us to install the degreaser and perform the compliance testing in accordance with specific condition #5 of the permit.

Your help in this matter is greatly appreciated. Should you have any questions, please contact Lisa Hill at (407) 796-5655.

Sincerely,

W. J. Dail
Manager
Utilities Operations/Environmental Affairs

cc: S. Brattebo
R. Henson
I. Goldman - DER - WPB
J. Stormer - PBCHD

jh (8672e)

Copied: J. Reynolds
CHF/BT



P.O. Box 109600
West Palm Beach, FL 33410-9600
(305) 840-2000

file copy

January 12, 1989

RECEIVED Government Products Division

JAN 17 1989

DER-BAQM

C. H. Fancy, Deputy Chief
Bureau of Air Quality Management
Department of Environmental Regulation
2600 Blair Stone Road
Tallahassee, Florida 32399-2400

Re: Proof of Publication - Notice of Proposed Agency Action -
Rocket Support Degreaser - DEG-5-ERS

Dear Mr. Fancy:

In accordance with your letter of December 13, 1988, the Notice of Proposed Agency Action for the subject matter was published in the legal section of the "Post" on January 10, 1989. As requested, we are enclosing "Proof of Publication" from The Palm Beach Post covering this publication.

Additionally, we would like to request that a change be made to the construction permit. The expiration date of the proposed permit is May 31, 1989, which means we will have to apply for an operating permit by February 28, 1989 (since the application for an operation permit must be submitted at least 90 days prior to the expiration date of the construction permit). If the construction permit is issued at the beginning of February, we will have less than one month to install the degreaser and perform compliance testing (both of which are required prior to applying for an operating permit). Therefore, we request that the expiration date of the permit be extended an additional three months which will allow enough time to install the degreaser and perform the compliance testing.

Should you have any questions, please contact Lisa Hill at (407) 796-5655.

Sincerely,

W. J. Dail, Manager
Utilities Operations/Environmental Affairs

WJD/lh/8322
Enclosure

cc: S. Benyon, DER-WPB
S. Brattebo
R. Henson
J. Stormer - PBCHD

J. Reynolds



P.O. Box 109600
West Palm Beach, Florida 33410-9600

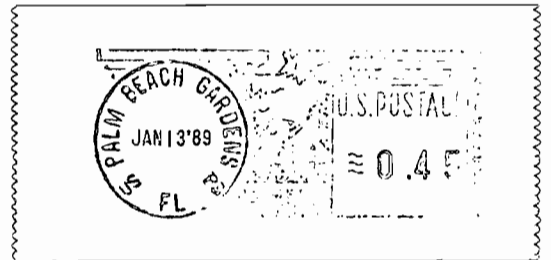

C. H. Fancy, Deputy Chief
Bureau of Air Quality Management
Department of Environmental Regulation
2600 Blair Stone Road
Tallahassee, Florida 32399-2400

THE PALM BEACH POST

Published Daily and Sunday
West Palm Beach, Palm Beach County, Florida

PROOF OF PUBLICATION

STATE OF FLORIDA

COUNTY OF PALM BEACH

Before the undersigned authority personally appeared James J. Hollenbeck who on oath says that she/he is Class. Adv. Mgr. of The Palm Beach Post, a daily and Sunday newspaper published at West Palm Beach in Palm Beach County, Florida; that the attached copy of advertising, being a Notice

in the matter of proposed agency action
in the --- Court, was published in said newspaper in the issues of January 10, 1989

Affiant further says that the said The Post is a newspaper published at West Palm Beach, in said Palm Beach County, Florida, and that the said newspaper has heretofore been continuously published in said Palm Beach County, Florida, daily and Sunday and has been entered as second class mail matter at the post office in West Palm Beach, in said Palm Beach County, Florida, for a period of one year next preceding the first publication of the attached copy of advertisement; and affiant further says that she/he has neither paid nor promised any person, firm or corporation any discount, rebate, commission or refund for the purpose of securing this advertisement for publication in the said newspaper.

Sworn to and subscribed before me this 10 day of January A.D. 1989

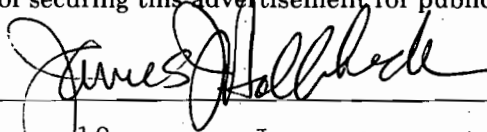

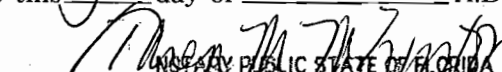
NOTARY PUBLIC STATE OF FLORIDA
MY COMMISSION EXP. NOV. 15, 1992
BONDED THRU GENERAL INS. UND.

NO. 883498
State of Florida
Department of
Environmental Regulation
Notice of Intent
The Department of Environmental Regulation hereby gives notice of its intent to issue a permit to United Technologies Corp., Pratt & Whitney, to install a degreaser at their facility in West Palm Beach, Florida. The Department is issuing this intent to issue for the reasons stated in the Technical Evaluation and Preliminary Determination. Persons whose substantial interests are affected by the above proposed agency action have a right pursuant to Section 120.57, Florida Statutes, to petition for an administrative determination (hearing) on the proposed action. The petition must conform to the requirements of Chapters 17-103 and 28-5, Florida Administrative Code, and must be filed (received) in the Department's Office of General Counsel, 2600 Blair Stone Road, Tallahassee, Florida 32399-2400, within fourteen (14) days of publication of this notice. Failure to file a petition within the fourteen (14) days constitutes a waiver of any right such person has to an administrative determination (hearing) pursuant to Section 120.57, Florida Statutes. If a petition is filed, the administrative hearing process is designed to formulate agency action. Accordingly, the Department's final action may be different from the proposed agency action. Therefore, persons who may not wish to file a petition may wish to intervene in the proceeding. A petition for intervention must be filed pursuant to Rule 28-5.207, Florida Administrative Code, at least five (5) days before the final hearing and be filed with the hearing officer if one has been assigned at the Division of Administrative Hearings, Department of Administration, 2009 Apalachee Parkway, Tallahassee, Florida 32301. If no hearing officer has been assigned, the petition is to be filed with the Department's Office of General Counsel, 2600 Blair Stone Road, Tallahassee, Florida 32399-2400. Failure to petition to intervene within the allowed time frame constitutes a waiver of any right such person has to request a hearing under Section 120.57, Florida Statutes. The application is available for public inspection during normal business hours, 8:00 a.m. to 5:00 p.m., Monday through Friday, except legal holidays.

at:
Dept. of Environmental
Regulation
Bureau of Air Quality
Management
2600 Blair Stone Road
Tallahassee, Florida
32399-2400
Dept. of Environmental
Regulation
Southeast Florida District
1900 S. Congress Avenue,
Suite A
West Palm Beach, Florida
33406
Palm Beach County
Health Dept.
Division of Environmental
Science and Engineering
901 E. Evernia Street
West Palm Beach, Florida
33402
Any person may send written
comments on the proposed
action to Mr. Bill Thomas at
the Department's Tallahassee
address. All comments mailed
within 14 days of the publica-
tion of this notice will be con-
sidered in the Department's fi-
nal determination.
PUB: The Palm Beach Post
January 10, 1989



P.O. Box 109600
West Palm Beach, FL 33410-9600
(305) 840-2000

Government Products Division

January 4, 1989

RECEIVED

Palm Beach Post & Times
Legal Advertising Department
2751 South Dixie Highway
West Palm Beach, Florida 33405

JAN 09 1989

DER-BAQM

Attn: Legal Advertising

Gentlemen:

Please publish the attached notice one time only in the Legal Advertisement Section of the Palm Beach Post on Tuesday, January 10, 1989.

It is requested that you prepare an affidavit of publication for submission to the Florida Department of Environmental Regulation (DER). Please notify Lisa Hill of our office (796-5655) when it is ready for pickup.

Please forward the bill to the following address.

W. J. Dail
Pratt & Whitney
P.O. Box 109600 - Mail Stop 717-03
West Palm Beach, Florida 33410-9600

Sincerely,

A handwritten signature in cursive script that reads "W. J. Dail".

W. J. Dail
Environmental Affairs

pc(0982j)
Attachment

cc: S. Benyon - DER-WPB
S. Brattebo
R. Henson
C. Fancy - DER-Tallahassee

State of Florida
Department of Environmental Regulation
Notice of Intent

The Department of Environmental Regulation hereby gives notice of its intent to issue a permit to United Technologies Corp., Pratt & Whitney, to install a degreaser at their facility in West Palm Beach, Florida. The Department is issuing this Intent to Issue for the reasons stated in the Technical Evaluation and Preliminary Determination.

Persons whose substantial interests are affected by the Department's proposed permitting decision may petition for an administrative determination (hearing) in accordance with Section 120.57, Florida Statutes. The petition must conform to the requirements of Chapters 17-103 and 28-5, Florida Administrative Code, and must be filed (received) in the Department's Office of General Counsel, 2600 Blair Stone Road, Twin Towers Office Building, Tallahassee, Florida 32399-2400, within fourteen (14) days of publication of this notice. Failure to file a petition within this time period constitutes a waiver of any right such person has to request an administrative determination (hearing) under Section 120.57, Florida Statutes.

If a petition is filed, the administrative hearing process is designed to formulate agency action. Accordingly, the Department's final action may be different from the proposed agency action. Therefore, persons who may not wish to file a petition may wish to intervene in the proceeding. A petition for intervention must be filed pursuant to Rule 28-5.207, Florida Administrative Code, at least five (5) days before the final hearing and be filed with the hearing officer if one has been assigned at the Division of Administrative Hearings, Department of Administration, 2009 Apalachee Parkway, Tallahassee, Florida 32301. If no hearing officer has been assigned, the petition is to be filed with the Department's Office of General Counsel, 2600 Blair Stone Road, Tallahassee, Florida 32399-2400. Failure to petition to intervene within the allowed time frame constitutes a waiver of any right such person has to request a hearing under Section 120.57, Florida Statutes.

The application is available for public inspection during normal business hours, 8:00 a.m. to 5:00 p.m., Monday through Friday, except legal holidays, at:

Dept. of Environmental Regulation
Bureau of Air Quality Management
2600 Blair Stone Road
Tallahassee, Florida 32399-2400

Dept. of Environmental Regulation
Southeast Florida District
1900 S. Congress Avenue, Suite A
West Palm Beach, Florida 33406

Palm Beach County Health Dept.
Division of Environmental Science
and Engineering
901 E. Evernia Street
West Palm Beach, Florida 33402

Any person may send written comments on the proposed action to Mr. Bill Thomas at the Department's Tallahassee address. All comments mailed within 14 days of the publication of this notice will be considered in the Department's final determination.

SENDER: Complete items 1 and 2 when additional services are desired, and complete items 3 and 4. Put your address in the "RETURN TO" Space on the reverse side. Failure to do this will prevent this card from being returned to you. The return receipt fee will provide you the name of the person delivered to and the date of delivery. For additional fees the following services are available. Consult postmaster for fees and check box(es) for additional service(s) requested.

1. Show to whom delivered, date, and addressee's address. (Extra charge) 2. Restricted Delivery (Extra charge)

3. Article Addressed to: Mr. R. H. Henson United Technologies Corp. SR 710 Beeline Highway West Palm Beach, FL 33410-9600	4. Article Number P 274 007 530
5. Signature - Address X	Type of Service: <input type="checkbox"/> Registered <input type="checkbox"/> Insured <input checked="" type="checkbox"/> Certified <input type="checkbox"/> COD <input checked="" type="checkbox"/> Express Mail <input type="checkbox"/> Return Receipt for Merchandise
6. Signature - Agent X	Always obtain signature of addressee or agent and <u>DATE DELIVERED</u> .
7. Date of Delivery DEC 13 1988	8. Addressee's Address (ONLY if requested and fee paid)

PS Form 3811, Mar. 1988 * U.S.G.P.O. 1988-212-865 DOMESTIC RETURN RECEIPT

P 274 007 530

RECEIPT FOR CERTIFIED MAIL

NO INSURANCE COVERAGE PROVIDED
NOT FOR INTERNATIONAL MAIL
(See Reverse)

* U.S.G.P.O. 1985-480-794
PS Form 3800, June 1985

Sent to Mr. R. H. Henson, United	
Street and No. Technologies SR 710 Beeline Highway	
P.O., State and ZIP Code West Palm Beach, FL 33410-9600	
Postage	\$
Certified Fee	
Special Delivery Fee	
Restricted Delivery Fee	
Return Receipt showing to whom and Date Delivered	
Return Receipt showing to whom, Date, and Address of Delivery	
TOTAL Postage and Fees	\$
Postmark or Date Mailed: 12-13-88 Permit: AC 50-155269	

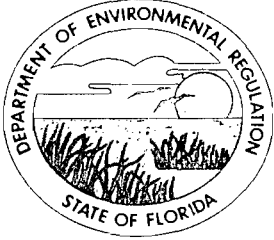

Florida Department of Environmental Regulation

Twin Towers Office Bldg. • 2600 Blair Stone Road • Tallahassee, Florida 32399-2400

Bob Martinez, Governor

Dale Twachtmann, Secretary

John Shearer, Assistant Secretary

December 13, 1988

CERTIFIED MAIL-RETURN RECEIPT REQUESTED

Mr. R. H. Henson
Manager - Plant Engineering
United Technologies Corp./Pratt & Whitney
SR 710 Beeline Highway
West Palm Beach, Florida 33410-9600

Dear Mr. Henson:

Attached is one copy of the Technical Evaluation and Preliminary Determination and proposed permit for installation of a degreaser at your West Palm Beach facility.

Please submit any written comments you wish to have considered concerning the Department's proposed action to Mr. Bill Thomas of the Bureau of Air Quality Management.

Sincerely,

C. H. Fancy, P.E.
Deputy Chief
Bureau of Air Quality
Management

CHF/JR/s

Attachments

cc: I. Goldman, SE District
V. Goldsmith, Pratt & Whitney
G. Sacco, PBCHD

BEFORE THE STATE OF FLORIDA
DEPARTMENT OF ENVIRONMENTAL REGULATION

In the Matter of
Application for Permit by:

United Technologies Corp.,
Pratt & Whitney
SR 710 Beeline Highway
West Palm Beach, Florida 33410-9600

DER File No. AC 50-155269

INTENT TO ISSUE

The Department of Environmental Regulation hereby gives notice of its intent to issue a permit (copy attached) for the proposed project as detailed in the application specified above. The Department is issuing this Intent to Issue for the reasons stated in the attached Technical Evaluation and Preliminary Determination.

The applicant, United Technologies Corp., Pratt & Whitney, applied on September 26, 1988, to the Department of Environmental Regulation for a permit to install a degreaser at their facility in West Palm Beach, Palm Beach County, Florida.

The Department has permitting jurisdiction under Chapter 403, Florida Statutes, and Florida Administrative Code Rules 17-2 and 17-4. The project is not exempt from permitting procedures. The Department has determined that an air construction permit was needed for the proposed work.

Pursuant to Section 403.815, F.S. and DER Rule 17-103.150, F.A.C., you (the applicant) are required to publish at your own expense the enclosed Notice of Proposed Agency Action on permit applications. The notice must be published one time only in a section of a major local newspaper of general circulation in the county in which the project is located and within thirty (30) days from receipt of this intent. Proof of publication must be provided to the Department within seven days of publication of the notice. Failure to publish the notice and provide proof of publication within the allotted time may result in the denial of the permit.

The Department will issue the permit with the attached conditions unless a petition for an administrative proceeding (hearing) is filed pursuant to the provisions of Section 120.57, F.S. A person whose substantial interests are affected by the

Department's proposed permitting decision may petition for an administrative proceeding (hearing) in accordance with Section 120.57, Florida Statutes. Petitions must comply with the requirements of Florida Administrative Code Rules 17-103.155 and 28-5.201 (copy enclosed) and be filed with (received by) the Office of General Counsel of the Department at 2600 Blair Stone Road, Tallahassee, Florida 32399-2400. Petitions filed by the permit applicant must be filed within fourteen (14) days of receipt of this intent. Petitions filed by other persons must be filed within fourteen (14) days of publication of the public notice or within fourteen (14) days of receipt of this intent, whichever first occurs. Failure to file a petition within this time period shall constitute a waiver of any right such person may have to request an administrative determination (hearing) under Section 120.57, Florida Statutes, concerning the subject permit application. Petitions which are not filed in accordance with the above provisions will be dismissed.

Executed in Tallahassee, Florida.

STATE OF FLORIDA DEPARTMENT
OF ENVIRONMENTAL REGULATION

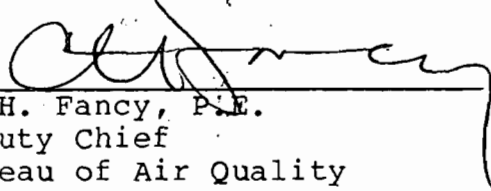

C. H. Fancy, P.E.
Deputy Chief
Bureau of Air Quality
Management

Copies furnished to:

I. Goldman, SE District
V. Goldsmith, Pratt & Whitney
G. Sacco, PBCHD

RULES OF THE ADMINISTRATIVE COMMISSION
MODEL RULES OF PROCEDURE
CHAPTER 28-5
DECISIONS DETERMINING SUBSTANTIAL INTERESTS

28-5.15 Requests for Formal and Informal Proceedings

- (1) Requests for proceedings shall be made by petition to the agency involved. Each petition shall be printed, typewritten or otherwise duplicated in legible form on white paper of standard legal size. Unless printed, the impression shall be on one side of the paper only and lines shall be double spaced and indented.
- (2) All petitions filed under these rules should contain:
 - (a) The name and address of each agency affected and each agency's file or identification number, if known;
 - (b) The name and address of the petitioner or petitioners;
 - (c) All disputed issues of material fact. If there are none, the petition must so indicate;
 - (d) A concise statement of the ultimate facts alleged, and the rules, regulations and constitutional provisions which entitle the petitioner to relief;
 - (e) A statement summarizing any informal action taken to resolve the issues, and the results of that action;
 - (f) A demand for the relief to which the petitioner deems himself entitled; and
 - (g) Such other information which the petitioner contends is material.

CERTIFICATE OF SERVICE

The undersigned duly designated deputy clerk hereby certifies that this NOTICE OF INTENT TO ISSUE and all copies were mailed before the close of business on December 13, 1988.

FILING AND ACKNOWLEDGEMENT
FILED, on this date, pursuant to
§120.52(9), Florida Statutes, with
the designated Department Clerk,
receipt of which is hereby
acknowledged.

Martha Miller December 13, 1988
Clerk Date

State of Florida
Department of Environmental Regulation
Notice of Intent

The Department of Environmental Regulation hereby gives notice of its intent to issue a permit to United Technologies Corp., Pratt & Whitney, to install a degreaser at their facility in West Palm Beach, Florida. The Department is issuing this Intent to Issue for the reasons stated in the Technical Evaluation and Preliminary Determination.

Persons whose substantial interests are affected by the Department's proposed permitting decision may petition for an administrative determination (hearing) in accordance with Section 120.57, Florida Statutes. The petition must conform to the requirements of Chapters 17-103 and 28-5, Florida Administrative Code, and must be filed (received) in the Department's Office of General Counsel, 2600 Blair Stone Road, Twin Towers Office Building, Tallahassee, Florida 32399-2400, within fourteen (14) days of publication of this notice. Failure to file a petition within this time period constitutes a waiver of any right such person has to request an administrative determination (hearing) under Section 120.57, Florida Statutes.

If a petition is filed, the administrative hearing process is designed to formulate agency action. Accordingly, the Department's final action may be different from the proposed agency action. Therefore, persons who may not wish to file a petition may wish to intervene in the proceeding. A petition for intervention must be filed pursuant to Rule 28-5.207, Florida Administrative Code, at least five (5) days before the final hearing and be filed with the hearing officer if one has been assigned at the Division of Administrative Hearings, Department of Administration, 2009 Apalachee Parkway, Tallahassee, Florida 32301. If no hearing officer has been assigned, the petition is to be filed with the Department's Office of General Counsel, 2600 Blair Stone Road, Tallahassee, Florida 32399-2400. Failure to petition to intervene within the allowed time frame constitutes a waiver of any right such person has to request a hearing under Section 120.57, Florida Statutes.

The application is available for public inspection during normal business hours, 8:00 a.m. to 5:00 p.m., Monday through Friday, except legal holidays, at:

Dept. of Environmental Regulation
Bureau of Air Quality Management
2600 Blair Stone Road
Tallahassee, Florida 32399-2400

Dept. of Environmental Regulation
Southeast Florida District
1900 S. Congress Avenue, Suite A
West Palm Beach, Florida 33406

Palm Beach County Health Dept.
Division of Environmental Science
and Engineering
901 E. Evernia Street
West Palm Beach, Florida 33402

Any person may send written comments on the proposed action to Mr. Bill Thomas at the Department's Tallahassee address. All comments mailed within 14 days of the publication of this notice will be considered in the Department's final determination.

Technical Evaluation
and
Preliminary Determination

United Technologies Corp.
Pratt & Whitney
Palm Beach County
West Palm Beach, Florida

Open-Top Vapor Degreaser
Permit No. AC 50-155269

Florida Department of Environmental Regulation
Bureau of Air Quality Management
Central Air Permitting

December 13, 1988

I. Application Information

A. Applicant

United Technologies Corp.
Pratt & Whitney
SR 710 Beeline Highway
West Palm Beach, Florida 33410-9600

B. Request

The Department received an application on September 26, 1988, for a permit to install an open-top vapor degreaser at the applicant's site near West Palm Beach, Florida. The application was deemed complete on October 25, 1988.

C. Location/Classification

The applicant's rocket engine and component testing facility (SIC Code 3764) is located off State Road 710 approximately 20 miles northwest of West Palm Beach. Latitude and longitude are 26°54'30"N and 80°22'49"W, respectively. The UTM coordinates of the site are: Zone 17, 561.6 km E and 2976.3 km N.

II. Project Description/Emissions

The applicant proposes to install an open-top vapor degreaser (Detrex Model VS 800-E, electric-heated, hoist-operated, style S, standard 5 ft. x 3 ft. x 3 ft. vapor zone) using trichloroethylene to clean parts associated with rocket engine and component testing. The degreaser will have a retractable cover and water jacket with vapor level controls to minimize emissions. An exhaust vent system will carry solvent vapors away from operating personnel. The amount of discharged vapors will be insignificant since trichloroethylene vapors are much heavier than air.

The AP-42 emission factor for open-top vapor degreasers using solvents other than trichloroethylene is 10.5 tons/yr, however, this is an average for such degreasers nationwide. The only accurate method of estimating emissions from a degreaser of this type involves subtracting recovered waste solvent from the amount of solvent consumed. The applicant estimates that potential emissions will be 5.43 tons/yr if the unit is operated full-time, but actual emissions will be only 2.48 tons/yr based on operating 4000 hrs/year.

III. Rule Applicability

The construction permit application is subject to review under Chapter 403, Florida Statutes, and Florida Administrative Code (F.A.C.) Rules 17-2 and 17-4. The proposed project is

located in an area classified as nonattainment for ozone and attainment for other designated pollutants. Since the proposed installation is classified as a minor source, it is not subject to the new source review requirements of Rule 17-2.510. Applicable rules are F.A.C. Rule 17-2.520, Sources Not Subject to Prevention of Significant Deterioration or Nonattainment Requirements, and F.A.C. Rule 17-2.650(1)(f)12.c.

IV. Conclusion

Based on the information provided by the applicant, the Department has reasonable assurance that the proposed project, as described in this evaluation, and subject to the conditions proposed herein, will not cause or contribute to a violation of an ambient air quality standard, PSD increment, or any other technical provisions of Chapter 17-2 of the Florida Administrative Code.

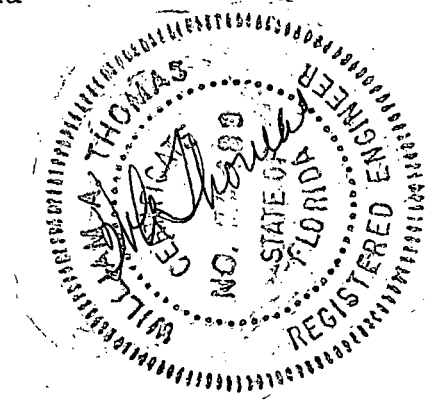



Florida Department of Environmental Regulation

Twin Towers Office Bldg. • 2600 Blair Stone Road • Tallahassee, Florida 32399-2400

Bob Martinez, Governor

Dale Twachtmann, Secretary

John Shearer, Assistant Secretary

PERMITTEE:

United Technologies Corp.,
Pratt & Whitney
SR 710 Beeline Highway
West Palm Beach, FL
33410-9600

Permit Number: AC 50-155269

Expiration Date: May 31, 1989

County: Palm Beach

Latitude/Longitude: 26° 54' 30"N

80° 22' 49"W

Project: Degreaser

This permit is issued under the provisions of Chapter 403, Florida Statutes, and Florida Administrative Code (F.A.C.) Rules 17-2 and 17-4. The above named permittee is hereby authorized to perform the work or operate the facility shown on the application and approved drawing(s), plans, and other documents attached hereto or on file with the Department and made a part hereof and specifically described as follows:

For the installation of a degreaser. This project will be located in West Palm Beach, Palm Beach County, Florida. The UTM coordinates of this site are Zone 17, 561.6 km E and 2976.3 km N.

Construction shall be in accordance with the permit application and plans, documents, and reference material submitted unless otherwise stated in the Preliminary Determination and Technical Evaluation or the General and Specific Conditions herein.

Attachments:

1. Application to Operate/Construct Air Pollution Sources, DER Form 17-1.202(1) received on September 26, 1988.

PERMITTEE: Permit Number: AC 50-155269
United Technologies Corp. Expiration Date: May 31, 1989

GENERAL CONDITIONS:

1. The terms, conditions, requirements, limitations, and restrictions set forth herein are "Permit Conditions" and as such are binding upon the permittee and enforceable pursuant to the authority of Sections 403.161, 403.727, or 403.859 through 403.861, Florida Statutes. The permittee is hereby placed on notice that the Department will review this permit periodically and may initiate enforcement action for any violation of the "Permit Conditions" by the permittee, its agents, employees, servants or representatives.

2. This permit is valid only for the specific processes and operations applied for and indicated in the approved drawings or exhibits. Any unauthorized deviation from the approved drawings, exhibits, specifications, or conditions of this permit may constitute grounds for revocation and enforcement action by the Department.

3. As provided in Subsections 403.087(6) and 403.722(5), Florida Statutes, the issuance of this permit does not convey any vested rights or any exclusive privileges. Nor does it authorize any injury to public or private property or any invasion of personal rights, nor any infringement of federal, state or local laws or regulations. This permit does not constitute a waiver of or approval of any other Department permit that may be required for other aspects of the total project which are not addressed in the permit.

4. This permit conveys no title to land or water, does not constitute state recognition or acknowledgement of title, and does not constitute authority for the use of submerged lands unless herein provided and the necessary title or leasehold interests have been obtained from the state. Only the Trustees of the Internal Improvement Trust Fund may express state opinion as to title.

5. This permit does not relieve the permittee from liability for harm or injury to human health or welfare, animal, plant or aquatic life or property and penalties therefore caused by the construction or operation of this permitted source, nor does it allow the permittee to cause pollution in contravention of Florida Statutes and Department rules, unless specifically authorized by an order from the Department.

PERMITTEE: Permit Number: AC 50-155269
United Technologies Corp. Expiration Date: May 31, 1989

GENERAL CONDITIONS:

6. The permittee shall at all times properly operate and maintain the facility and systems of treatment and control (and related appurtenances) that are installed or used by the permittee to achieve compliance with the conditions of this permit, as required by Department rules. This provision includes the operation of backup or auxiliary facilities or similar systems when necessary to achieve compliance with the conditions of the permit and when required by Department rules.

7. The permittee, by accepting this permit, specifically agrees to allow authorized Department personnel, upon presentation of credentials or other documents as may be required by law, access to the premises, at reasonable times, where the permitted activity is located or conducted for the purpose of:

- a. Having access to and copying any records that must be kept under the conditions of the permit;
- b. Inspecting the facility, equipment, practices, or operations regulated or required under this permit; and
- c. Sampling or monitoring any substances or parameters at any location reasonably necessary to assure compliance with this permit or Department rules.

Reasonable time may depend on the nature of the concern being investigated.

8. If, for any reason, the permittee does not comply with or will be unable to comply with any condition or limitation specified in this permit, the permittee shall immediately notify and provide the Department with the following information:

- a. A description of and cause of non-compliance; and
- b. The period of non-compliance, including exact dates and times; or, if not corrected, the anticipated time the non-compliance is expected to continue, and steps being taken to reduce, eliminate, and prevent recurrence of the non-compliance.

PERMITTEE:
United Technologies Corp.

Permit Number: AC 50-155269
Expiration Date: May 31, 1989

GENERAL CONDITIONS:

The permittee shall be responsible for any and all damages which may result and may be subject to enforcement action by the Department for penalties or revocation of this permit.

9. In accepting this permit, the permittee understands and agrees that all records, notes, monitoring data and other information relating to the construction or operation of this permitted source, which are submitted to the Department, may be used by the department as evidence in any enforcement case arising under the Florida Statutes or Department rules, except where such use is proscribed by Sections 403.73 and 403.111, Florida Statutes.

10. The permittee agrees to comply with changes in Department rules and Florida Statutes after a reasonable time for compliance, provided however, the permittee does not waive any other rights granted by Florida Statutes or Department rules.

11. This permit is transferable only upon Department approval in accordance with Florida Administrative Code Rules 17-4.12 and 17-30.30, as applicable. The permittee shall be liable for any noncompliance of the permitted activity until the transfer is approved by the Department.

12. This permit is required to be kept at the work site of the permitted activity during the entire period of construction or operation.

13. This permit also constitutes:

- () Determination of Best Available Control Technology (BACT)
- () Determination of Prevention of Significant Deterioration (PSD)
- () Compliance with New Source Performance Standards

14. The permittee shall comply with the following monitoring and record keeping requirements:

- a. Upon request, the permittee shall furnish all records and plans required under Department rules. The retention period for all records will be extended automatically, unless otherwise stipulated by the Department, during the course of any unresolved enforcement action.

PERMITTEE:
United Technologies Corp.

Permit Number: AC 50-155269
Expiration Date: May 31, 1989

GENERAL CONDITIONS:

- b. The permittee shall retain at the facility or other location designated by this permit records of all monitoring information (including all calibration and maintenance records and all original strip chart recordings for continuous monitoring instrumentation), copies of all reports required by this permit, and records of all data used to complete the application for this permit. The time period of retention shall be at least three years from the date of the sample, measurement, report or application unless otherwise specified by Department rule.
- c. Records of monitoring information shall include:
 - the date, exact place, and time of sampling or measurements;
 - the person responsible for performing the sampling or measurements;
 - the date(s) analyses were performed;
 - the person responsible for performing the analyses;
 - the analytical techniques or methods used; and
 - the results of such analyses.

15. When requested by the Department, the permittee shall within a reasonable time furnish any information required by law which is needed to determine compliance with the permit. If the permittee becomes aware that relevant facts were not submitted or were incorrect in the permit application or in any report to the Department, such facts or information shall be submitted or corrected promptly.

SPECIFIC CONDITIONS:

- 1. The construction and operation of this source shall be in accordance with the capacities and specifications stated in the application.
- 2. The degreaser shall be allowed to operate for up to 4,000 hours per year.
- 3. Trichloroethylene emissions (VOC) shall not exceed 1.24 lbs/hr and 2.48 tons per year. Compliance shall be demonstrated by subtracting the amount of recovered waste solvent from the amount of solvent actually consumed during the compliance period.

PERMITTEE:
United Technologies Corp.

Permit Number: AC 50-155269
Expiration Date: May 31, 1989

SPECIFIC CONDITIONS:

4. The degreaser shall comply with all requirements specified in F.A.C. Rule 17-2.650(1)(f)12.c.

5. Compliance shall be demonstrated over a 30 day period after operation begins and the results reported to the Department before this construction permit expires. The Department shall be notified at least 5 days prior to the degreaser being placed in operation.

6. The permittee, for good cause, may request that this construction permit be extended. Such a request shall be submitted to the BAQM prior to 60 days before the expiration of the permit (F.A.C. 17-4.090).

7. An application for an operation permit must be submitted to the DER's Southeast District office at least 90 days prior to the expiration date of this construction permit. To properly apply for an operation permit, the applicant shall submit an application, the appropriate fee, certification that construction was completed, noting any deviations from the conditions in the construction permit, and compliance test reports as required by this permit (F.A.C. 17-4.220).

Issued this _____ day of _____,
1988

STATE OF FLORIDA DEPARTMENT
OF ENVIRONMENTAL REGULATION

Dale Twachtmann, Secretary



PM
9-22-88
w. Palm Beach

file copy
P.O. Box 109600
West Palm Beach, FL 33410-9600
(305) 840-2000

RECEIVED
DER - MAIL ROOM

September 20, 1988

1988 SEP 26 AM 9:45

Government Products Division

Mr. Claire H. Fancy
Bureau of Air Quality Management
2600 Blair Stone Road
Tallahassee, Florida 32301-8241

Re: Air Pollution Construction Permit - Rocket Support Degreaser

Dear Mr. Fancy:

Enclosed are four (4) copies of DER Form 17-1.202(1) "Application to Operate/Construct Air Pollution Sources" for the above referenced air permit, along with the required check (No. 285803) for \$100 made payable to the Department of Environmental Regulation.

Your efforts to issue this permit will be greatly appreciated. Should you have any questions, please contact Lisa Hill at (407) 796-5655.

Sincerely,

W. J. Dail, Manager
Utilities Operations/Environmental Affairs

RECEIVED

SEP 26 1988

DER-BAQM

Attachment

cc: J. Henneberger - w/attachment
R. Henson - w/o attachment
Jim Stormer - PBCHD - w/attachment

*copied: John Reynolds
J. Goldman, SE Dist*

(8070e)



Government Products Division
P.O. Box 2691
West Palm Beach, Florida 33402

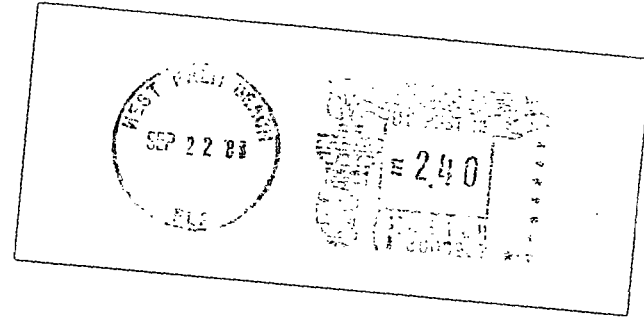

PRIORITY MAIL

Mr. Claire H. Fancy
Bureau of Air Quality Mgmt.
2600 Blair Stone Road
Tallahassee, Florida 32301-8241

bcc:

D. Adamson - w/attachment
C. Debischopp - w/attachment
L. Hill - w/attachment
R. Tierney - w/o attachment
V. Goldsmith - w/attachment
File - Air Pollution

285803
285803

THE CHASE MANHATTAN BANK, N.A.
SYRACUSE, NEW YORK

Government Engine Business
Box 109600, West Palm Beach, Florida 33410-9600
Phone (407) 796-2000

IN FULL SETTLEMENT OF ITEMS LISTED ON ACCOMPANYING STATEMENT

PAY: ONE HUNDRED AND NO/100 DOLLARS *****

DATE 09/08/88

*****100.00

TO THE ORDER OF

FLORIDA DEPARTMENT OF ENVIRONMENTAL REGULATION

Thomas H. Delli

AUTHORIZED SIGNATURE

R. D. Miller

AUTHORIZED COUNTER SIGNATURE

Enclosed are four (4) copies of DER Form 17-1.202(1) "Application to Operate/Construct Air Pollution Sources" for the above referenced air permit, along with the required check (No. 285803) for \$100 made payable to the Department of Environmental Regulation.

Your efforts to issue this permit will be greatly appreciated. Should you have any questions, please contact Lisa Hill at (407) 796-5655.

Sincerely,

W. J. Dail

W. J. Dail, Manager
Utilities Operations/Environmental Affairs

Attachment

- cc: J. Henneberger - w/attachment
- R. Henson - w/o attachment
- Jim Stormer - PBCHD - w/attachment

(8070e)

1031



P.O. Box 109600
West Palm Beach, FL 33410-9600
(305) 840-2000

RECEIVED
DER - MAIL ROOM

0065

September 20, 1988

1988 SEP 26 AM 9:45

Government Products Division

Mr. Claire H. Fancy
Bureau of Air Quality Management
2600 Blair Stone Road
Tallahassee, Florida 32301-8241

Re: Air Pollution Construction Permit - Rocket Support Degreaser

Dear Mr. Fancy:

Enclosed are four (4) copies of DER Form 17-1.202(1) "Application to Operate/Construct Air Pollution Sources" for the above referenced air permit, along with the required check (No. 285803) for \$100 made payable to the Department of Environmental Regulation.

Your efforts to issue this permit will be greatly appreciated. Should you have any questions, please contact Lisa Hill at (407) 796-5655.

Sincerely,

W. J. Dail, Manager
Utilities Operations/Environmental Affairs

Attachment

cc: J. Henneberger - w/attachment
R. Henson - w/o attachment
Jim Stormer - PBCHD - w/attachment

(8070e)

1031

AC 50-155269

STATE OF FLORIDA
DEPARTMENT OF ENVIRONMENTAL REGULATION

TWIN TOWERS OFFICE BUILDING
2600 BLAIR STONE ROAD
TALLAHASSEE, FLORIDA 32301



RECEIVED

SEP 26 1988

BOB GRAHAM
GOVERNOR

VICTORIA J. TSCHINKEL
SECRETARY

DER-BAQM

APPLICATION TO OPERATE/CONSTRUCT AIR POLLUTION SOURCES

SOURCE TYPE: Vapor Degreaser [] New¹ [] Existing¹

APPLICATION TYPE: [] Construction [] Operation [] Modification

COMPANY NAME: United Technologies, Pratt & Whitney COUNTY: Palm Beach

Identify the specific emission point source(s) addressed in this application (i.e. Line

Kiln No. 4 with Venturi Scrubber; Peaking Unit No. 2, Gas Fired) DEG-5-ERS

SOURCE LOCATION: Street SR 710 Beeline Highway 20 miles NW of
City West Palm Beach

UTM: East 17,561.6 KM North 2976.3 KM

Latitude 26 ° 54 ' 30 " N Longitude 80 ° 22 ' 49 " W

APPLICANT NAME AND TITLE: United Technologies Corp. - Pratt & Whitney

APPLICANT ADDRESS: P.O. Box 109600, West Palm Beach, Fl. 33410-9600

SECTION I: STATEMENTS BY APPLICANT AND ENGINEER

A. APPLICANT

United Technologies Corp.

I am the undersigned owner or authorized representative² of Pratt & Whitney

I certify that the statements made in this application for a construction air pollution permit are true, correct and complete to the best of my knowledge and belief. Further, I agree to maintain and operate the pollution control sources and pollution control facilities in such a manner as to comply with the provision of Chapter 403, Florida Statutes, and all the rules and regulations of the department and revisions thereof. I also understand that a permit, if granted by the department, will be non-transferable and I will promptly notify the department upon sale or legal transfer of the permitted establishment.

*Attach letter of authorization

Signed: R H Henson

R. H. Henson, Manager - Plant Engineering
Name and Title (Please Type)

Date: 9/19/88 Telephone No. (407) 796-5461

B. PROFESSIONAL ENGINEER REGISTERED IN FLORIDA (where required by Chapter 471, F.S.)

This is to certify that the engineering features of this pollution control project have been designed/examined by me and found to be in conformity with modern engineering principles applicable to the treatment and disposal of pollutants characterized in the permit application. There is reasonable assurance, in my professional judgment, that

See Florida Administrative Code Rule 17-2.100(57) and (104)

the pollution control facilities, when properly maintained and operated, will discharge an effluent that complies with all applicable statutes of the State of Florida and the rules and regulations of the department. It is also agreed that the undersigned will furnish, if authorized by the owner, the applicant a set of instructions for the proper maintenance and operation of the pollution control facilities and, if applicable, pollution sources.

Signed Van E. Goldsmith
Van E. Goldsmith
Name (Please Type)
United Technologies Corp., Pratt & Whitney
Company Name (Please Type)
M/S 724-10, P.O. Box 109600, West Palm Beach, Fl.
Mailing Address (Please Type) 33410-9600
Florida Registration No. 8620 Date: 9-15-88 Telephone No. (407) 796-1252

SECTION II: GENERAL PROJECT INFORMATION

4. Describe the nature and extent of the project. Refer to pollution control equipment, and expected improvements in source performance as a result of installation. State whether the project will result in full compliance. Attach additional sheet if necessary.

See Attachment A

3. Schedule of project covered in this application (Construction Permit Application Only)
Anticipated date 1 week from
Start of Construction October 1988 Completion of Construction starting date

C. Costs of pollution control system(s): (Note: Show breakdown of estimated costs only for individual components/units of the project serving pollution control purposes. Information on actual costs shall be furnished with the application for operation permit.)

Degreaser cover - \$4,600

D. Indicate any previous DER permits, orders and notices associated with the emission point, including permit issuance and expiration dates.

Permit No. A050-111754 - Test Area Air Pollution Operating Permit

E. Requested permitted equipment operating time: hrs/day 16 ; days/wk 5 ; wks/yr 50 ;
if power plant, hrs/yr _____; if seasonal, describe: _____

F. If this is a new source or major modification, answer the following questions.
(Yes or No)

1. Is this source in a non-attainment area for a particular pollutant? Yes
a. If yes, has "offset" been applied? No
b. If yes, has "Lowest Achievable Emission Rate" been applied? No
c. If yes, list non-attainment pollutants. ozone
2. Does best available control technology (BACT) apply to this source?
If yes, see Section VI. No
3. Does the State "Prevention of Significant Deterioration" (PSD)
requirement apply to this source? If yes, see Sections VI and VII. No
4. Do "Standards of Performance for New Stationary Sources" (NSPS)
apply to this source? No
5. Do "National Emission Standards for Hazardous Air Pollutants"
(NESHAP) apply to this source? No
- H. Do "Reasonably Available Control Technology" (RACT) requirements apply
to this source? No
a. If yes, for what pollutants? _____
b. If yes, in addition to the information required in this form,
any information requested in Rule 17-2.650 must be submitted.

Attach all supportive information related to any answer of "Yes". Attach any justifi-
cation for any answer of "No" that might be considered questionable.

Based on emission calculations (Attachment B), the maximum LB/HR emission
rate is 2.25; therefore, RACT does not apply to this source.

SECTION III: AIR POLLUTION SOURCES & CONTROL DEVICES (Other than Incinerators)

A. Raw Materials and Chemicals Used in your Process, if applicable: N/A

Description	Contaminants		Utilization Rate - lbs/hr	Relate to Flow Diagram
	Type	% Wt		

B. Process Rate, if applicable: (See Section V, Item 1)

1. Total Process Input Rate (lbs/hr): N/A

2. Product Weight (lbs/hr): N/A

C. Airborne Contaminants Emitted: (Information in this table must be submitted for each emission point, use additional sheets as necessary)

Name of Contaminant	Emission ¹		Allowed ² Emission Rate per Rule 17-2	Allowable ³ Emission lbs/hr	Potential ⁴ Emission		Relate to Flow Diagram
	Maximum lbs/hr	Actual T/yr			lbs/yr	T/yr	
*Trichloroethylene	1.24	2.48			10,862.4	5.43	

¹See Section V, Item 2.

²Reference applicable emission standards and units (e.g. Rule 17-2.600(5)(b)2. Table II, E. (1) - 0.1 pounds per million BTU heat input)

³Calculated from operating rate and applicable standard.

⁴Emission, if source operated without control (See Section V, Item 3).

* See attachment B for Emission Calculations

J. Control Devices: (See Section V, Item 4)

Name and Type (Model & Serial No.)	Contaminant	Efficiency	Range of Particles Size Collected (in microns) (If applicable)	Basis for Efficiency (Section V Item 5)
cover (See Attachment D, footnote E)	VOC's	6-18% reduction	N/A	AP-42 Fourth Edition Sept. 1985

E. Fuels N/A

Type (Be Specific)	Consumption*		Maximum Heat Input (MMBTU/hr)
	avg/hr	max./hr	

*Units: Natural Gas--MMCF/hr; Fuel Oils--gallons/hr; Coal, wood, refuse, other--lbs/hr.

Fuel Analysis:

Percent Sulfur: _____ Percent Ash: _____

Density: _____ lbs/gal Typical Percent Nitrogen: _____

Heat Capacity: _____ BTU/lb _____ BTU/gal

Other Fuel Contaminants (which may cause air pollution): _____

F. If applicable, indicate the percent of fuel used for space heating.

Annual Average _____ Maximum _____

G. Indicate liquid or solid wastes generated and method of disposal.

Solid waste - Unit Filter

Liquid waste - Trichloroethylene

Both liquid & solid waste would be collected into containers which are then managed relative to onsite storage and offsite disposal as a hazardous waste.

H. Emission Stack Geometry and Flow Characteristics (Provide data for each stack): N/A

Stack Height: _____ ft. Stack Diameter: _____ ft.

Gas Flow Rate: _____ ACFM _____ DSCFM Gas Exit Temperature: _____ °F.

Water Vapor Content: _____ % Velocity: _____ FPS

SECTION IV: INCINERATOR INFORMATION N/A

Type of Waste	Type 0 (Plastics)	Type I (Rubbish)	Type II (Refuse)	Type III (Garbage)	Type IV (Pathological)	Type V (Liq. & Gas By-prod.)	Type VI (Solid By-prod.)
Actual lb/hr Incinerated							
Uncontrolled (lbs/hr)							

Description of Waste _____

Total Weight Incinerated (lbs/hr) _____ Design Capacity (lbs/hr) _____

Approximate Number of Hours of Operation per day _____ day/wk _____ wks/yr. _____

Manufacturer _____

Date Constructed _____ Model No. _____

	Volume (ft) ³	Heat Release (BTU/hr)	Fuel		Temperature (°F)
			Type	BTU/hr	
Primary Chamber					
Secondary Chamber					

Stack Height: _____ ft. Stack Diameter: _____ Stack Temp. _____

Gas Flow Rate: _____ ACFM _____ DSCFM* Velocity: _____ FPS

*If 50 or more tons per day design capacity, submit the emissions rate in grains per standard cubic foot dry gas corrected to 50% excess air.

Type of pollution control devices: Cyclone Wet Scrubber Afterburner
 Other (specify) _____

Brief description of operating characteristics of control devices: _____

Ultimate disposal of any effluent other than that emitted from the stack (scrubber water, ash, etc.):

NOTE: Items 2, 3, 4, 6, 7, 8, and 10 in Section V must be included where applicable.

SECTION V: SUPPLEMENTAL REQUIREMENTS

Please provide the following supplements where required for this application.

1. Total process input rate and product weight -- show derivation [Rule 17-2.100(127)]
N/A
2. To a construction application, attach basis of emission estimate (e.g., design calculations, design drawings, pertinent manufacturer's test data, etc.) and attach proposed methods (e.g., FR Part 60 Methods 1, 2, 3, 4, 5) to show proof of compliance with applicable standards. To an operation application, attach test results or methods used to show proof of compliance. Information provided when applying for an operation permit from a construction permit shall be indicative of the time at which the test was made. See Attachment B for emission calculations
3. Attach basis of potential discharge (e.g., emission factor, that is, AP42 test). See Attachment C and Attachment D (AP42 Table 4.6-2 & 4.6-3).
4. With construction permit application, include design details for all air pollution control systems (e.g., for baghouse include cloth to air ratio; for scrubber include cross-section sketch, design pressure drop, etc.)
Degreaser drawing with cover (See Attachment E).
5. With construction permit application, attach derivation of control device(s) efficiency. Include test or design data. Items 2, 3 and 5 should be consistent: actual emissions = potential (1-efficiency).
See Attachment D, footnote E
6. An 8 1/2" x 11" flow diagram which will, without revealing trade secrets, identify the individual operations and/or processes. Indicate where raw materials enter, where solid and liquid waste exit, where gaseous emissions and/or airborne particles are evolved and where finished products are obtained.
See Attachment F
7. An 8 1/2" x 11" plot plan showing the location of the establishment, and points of airborne emissions, in relation to the surrounding area, residences and other permanent structures and roadways (Example: Copy of relevant portion of USGS topographic map).
See Attachment G
8. An 8 1/2" x 11" plot plan of facility showing the location of manufacturing processes and outlets for airborne emissions. Relate all flows to the flow diagram.
See Attachment H

9. The appropriate application fee in accordance with Rule 17-4.05. The check should be made payable to the Department of Environmental Regulation.
10. With an application for operation permit, attach a Certificate of Completion of Construction indicating that the source was constructed as shown in the construction permit.

SECTION VI: BEST AVAILABLE CONTROL TECHNOLOGY N/A

A. Are standards of performance for new stationary sources pursuant to 40 C.F.R. Part 60 applicable to the source?

Yes No

Contaminant	Rate or Concentration

B. Has EPA declared the best available control technology for this class of sources (If yes, attach copy)

Yes No

Contaminant	Rate or Concentration

C. What emission levels do you propose as best available control technology?

Contaminant	Rate or Concentration

D. Describe the existing control and treatment technology (if any).

- | | |
|---------------------------|--------------------------|
| 1. Control Device/System: | 2. Operating Principles: |
| 3. Efficiency:* | 4. Capital Costs: |

*Explain method of determining

5. Useful Life:

6. Operating Costs:

7. Energy:

8. Maintenance Cost:

9. Emissions:

Contaminant

Rate or Concentration

Contaminant	Rate or Concentration

10. Stack Parameters

- a. Height: ft.
- b. Diameter: ft.
- c. Flow Rate: ACFM
- d. Temperature: °F.
- e. Velocity: FPS

E. Describe the control and treatment technology available (As many types as applicable, use additional pages if necessary).

1.

- a. Control Device:
- b. Operating Principles:
- c. Efficiency:¹
- d. Capital Cost:
- e. Useful Life:
- f. Operating Cost:
- g. Energy:²
- h. Maintenance Cost:
- i. Availability of construction materials and process chemicals:
- j. Applicability to manufacturing processes:
- k. Ability to construct with control devices, install in available space, and operate within proposed levels:

2.

- a. Control Device:
- b. Operating Principles:
- c. Efficiency:¹
- d. Capital Cost:
- e. Useful Life:
- f. Operating Cost:
- g. Energy:²
- h. Maintenance Cost:
- i. Availability of construction materials and process chemicals:

¹Explain method of determining efficiency.

²Energy to be reported in units of electrical power - KWH design rate.

j. Applicability to manufacturing processes:

k. Ability to construct with control device, install in available space, and operate within proposed levels:

3.

a. Control Device:

b. Operating Principles:

c. Efficiency:¹

d. Capital Cost:

e. Useful Life:

f. Operating Cost:

g. Energy:²

h. Maintenance Cost:

i. Availability of construction materials and process chemicals:

j. Applicability to manufacturing processes:

k. Ability to construct with control device, install in available space, and operate within proposed levels:

4.

a. Control Device:

b. Operating Principles:

c. Efficiency:¹

d. Capital Costs:

e. Useful Life:

f. Operating Cost:

g. Energy:²

h. Maintenance Cost:

i. Availability of construction materials and process chemicals:

j. Applicability to manufacturing processes:

k. Ability to construct with control device, install in available space, and operate within proposed levels:

F. Describe the control technology selected:

1. Control Device:

2. Efficiency:¹

3. Capital Cost:

4. Useful Life:

5. Operating Cost:

6. Energy:²

7. Maintenance Cost:

8. Manufacturer:

9. Other locations where employed on similar processes:

a. (1) Company:

(2) Mailing Address:

(3) City:

(4) State:

¹ Explain method of determining efficiency.

Energy to be reported in units of electrical power - KWH design rate.

(5) Environmental Manager:

(6) Telephone No.:

(7) Emissions:¹

Contaminant

Rate or Concentration

(8) Process Rate:¹

b. (1) Company:

(2) Mailing Address:

(3) City:

(4) State:

(5) Environmental Manager:

(6) Telephone No.:

(7) Emissions:¹

Contaminant

Rate or Concentration

(8) Process Rate:¹

10. Reason for selection and description of systems:

¹Applicant must provide this information when available. Should this information not be available, applicant must state the reason(s) why.

SECTION VII - PREVENTION OF SIGNIFICANT DETERIORATION N/A

A. Company Monitored Data

1. _____ no. sites _____ TSP _____ () SO₂* _____ Wind spd/dir

Period of Monitoring _____ / _____ / _____ to _____ / _____ / _____
month day year month day year

Other data recorded _____

Attach all data or statistical summaries to this application.

Specify bubbler (B) or continuous (C).

2. Instrumentation, Field and Laboratory

- a. Was instrumentation EPA referenced or its equivalent? [] Yes [] No
- b. Was instrumentation calibrated in accordance with Department procedures?
[] Yes [] No [] Unknown

B. Meteorological Data Used for Air Quality Modeling

- 1. _____ Year(s) of data from _____ / _____ / _____ to _____ / _____ / _____
month day year month day year
- 2. Surface data obtained from (location) _____
- 3. Upper air (mixing height) data obtained from (location) _____
- 4. Stability wind rose (STAR) data obtained from (location) _____

C. Computer Models Used

- 1. _____ Modified? If yes, attach description.
- 2. _____ Modified? If yes, attach description.
- 3. _____ Modified? If yes, attach description.
- 4. _____ Modified? If yes, attach description.

Attach copies of all final model runs showing input data, receptor locations, and principle output tables.

D. Applicants Maximum Allowable Emission Data

Pollutant	Emission Rate	
TSP	_____	grams/sec
SO ₂	_____	grams/sec

E. Emission Data Used in Modeling

Attach list of emission sources. Emission data required is source name, description of point source (on NEDS point number), UTM coordinates, stack data, allowable emissions, and normal operating time.

- F. Attach all other information supportive to the PSD review.
- G. Discuss the social and economic impact of the selected technology versus other applicable technologies (i.e., jobs, payroll, production, taxes, energy, etc.). Include assessment of the environmental impact of the sources.
- H. Attach scientific, engineering, and technical material, reports, publications, journals, and other competent relevant information describing the theory and application of the requested best available control technology.

ATTACHMENT A

This construction permit application is for one degreaser which will be installed at the Test Maintenance and Construction Cleaning Area. The degreaser (Detrex Modle VS800-E, Electric-heated, hoist-operated, style S, standard size degreaser 5 ft. x 3 ft. x 3 ft. vapor zone) will use trichloroethylene to clean valves, fittings, manifolds, etc. removed from process piping associated with rocket engine and component testing.

The degreaser will be equipped with a motorized cover to reduce emissions. Other features of the degreaser (for example vapor level control) which help minimize emissions are listed in Attachment I under "operational features".

8056e

Wm Goldsmith PE
8620
9-15-88

ATTACHMENT B

DEGREASER CALCULATIONS - BASED ON AP-42, FOURTH EDITION,
SEPTEMBER 1985, TABLES 4.6-2, 4.6-3

<u>FT2</u>		<u>LB/FT2 X HR</u>	MAX. <u>LB/HR</u>		CONTROL FACTOR (1-EMISSION REDUCTION)	ACTUAL EMISSIONS		POTENTIAL EMISSIONS (ACTUAL EMISSIONS X 8760 HRS/YR)	
						<u>LB/HR</u>	<u>TONS/YR (LB/HR X 4000 HRS/YR)</u>	<u>LB/YR</u>	<u>TONS/YR</u>
15	X	0.15*	= 2.25	X	0.55**	= 1.24	2.48	10,862.4	5.43

* TABLE 4.6-2 - EMISSION FACTOR FOR OPEN TOP VAPOR (ENTIRE UNIT)

** TABLE 4.6-3 - ASSUMED EMISSION REDUCTION OF 45%

(8052e)



ATTACHMENT C

TABLE 4.6-2. SOLVENT LOSS EMISSION FACTORS FOR DEGREASING OPERATIONS
EMISSION FACTOR RATING: C

Type of degreasing	Activity measure	Uncontrolled organic emission factor ^a	
All ^b	Solvent consumed	1,000 kg/Mg	2,000 lb/ton
Cold cleaner			
Entire unit ^c	Units in operation	0.30 Mg/yr/unit	0.33 tons/yr/unit
Waste solvent loss		0.165 Mg/yr/unit	0.18 tons/yr/unit
Solvent carryout		0.075 Mg/yr/unit	0.08 tons/yr/unit
Bath and spray evaporation		0.06 Mg/yr/unit	0.07 tons/yr/unit
Entire unit	Surface area and duty cycle ^d	0.4 kg/hr/m ²	0.08 lb/hr/ft ²
Open top vapor			
Entire unit	Units in operation	9.5 Mg/yr/unit	10.5 tons/yr/unit
Entire unit	Surface area and duty cycle ^e	0.7 kg/hr/m ²	0.15 lb/hr/ft ²
Conveyorized, vapor			
Entire unit	Units in operation	24 Mg/yr/unit	26 tons/yr/unit
Conveyorized, nonboiling			
Entire unit	Units in operation	47 Mg/yr/unit	52 tons/yr/unit

^a100% nonmethane VOC.

^bSolvent consumption data will provide much more accurate emission estimates than any of the other factors presented.

^cEmissions generally would be higher for manufacturing units and lower for maintenance units.

^dReference 4, Appendix C-6. For trichloroethane degreaser.

^eFor trichloroethane degreaser. Does not include waste solvent losses.

NOTE: THIS TABLE WAS TAKEN FROM AP-42, FOURTH EDITION, SEPTEMBER 1985.

ATTACHMENT D

TABLE 4.6-3. PROJECTED EMISSION REDUCTION FACTORS FOR SOLVENT DEGREASING^a

System	Cold cleaner		Vapor degreaser		Conveyorized degreaser	
	A	B	A	B	A	B
Control devices						
Cover or enclosed design	X	X	X	X	X	X
Drainage facility	X	X	X			X
Water cover, refrigerated chiller, carbon adsorption or high freeboard ^b		X		X		X
Solid, fluid spray stream ^c		X		X		
Safety switches and thermostats				X		X
Emission reduction from control devices (%)	13-38	NA ^d	20-40	30-60		40-60
Operating procedures						
Proper use of equipment	X	X	X	X	X	X
Use of high volatility solvent		X				
Waste solvent reclamation	X	X	X	X	X	X
Reduced exhaust ventilation			X	X	X	X
Reduced conveyor or entry speed			X	X	X	X
Emission reduction from operating procedures(%)	15-45	NA ^d	15-35	20-40	20-30	20-30
Total emission reduction(%)	28-83 ^e	55-69 ^f	30-60	45-75	20-30	50-70

^aReference 2. Ranges of emission reduction present poor to excellent compliance. X indicates devices or procedures which will effect the given reductions. Letters A and B indicate different control device circumstances. See Appendix B of Reference 2.

^bOnly one of these major control devices would be used in any degreasing system. System B could employ any of them. Vapor degreaser system B could employ any except water cover. Conveyorized degreaser system B could employ any except water cover and high freeboard.

^cIf agitation by spraying is used, the spray should not be a shower type.

^dBreakout between control equipment and operating procedures is not available.

^eA manual or mechanically assisted cover would contribute 6-18% reduction; draining parts 15 seconds within the degreaser, 7-20%; and storing waste solvent in containers, an additional 15-45%.

^fPercentages represent average compliance.

As with cold cleaning, open top vapor degreasing emissions relate heavily to proper operating methods. Most emissions are due to (6) diffusion and convection, which can be reduced by using an automated cover, by using a manual cover regularly, by spraying below the vapor level, by optimizing work loads or by using a refrigerated freeboard chiller (for which a carbon adsorption unit would be substituted on larger units). Safety switches and thermostats that prevent emissions during malfunctions and abnormal operation also reduce diffusion and convection of the vaporized solvent. Additional sources are (7) solvent carryout, (8) exhaust systems and (9) waste solvent evaporation. Carryout is directly affected by the size and shape of the workload, by racking of parts and by cleaning and drying time. Exhaust emissions can be nearly eliminated by a carbon adsorber that collects the solvent vapors for reuse. Waste solvent evaporation is not so much a problem with

NOTE: THIS TABLE WAS TAKEN FROM AP-42, FOURTH EDITION, SEPTEMBER 1985.

cover your losses!

a smooth-operating
DETREX COVER can
reduce your vapor
degreaser's solvent
emissions up to 52%*

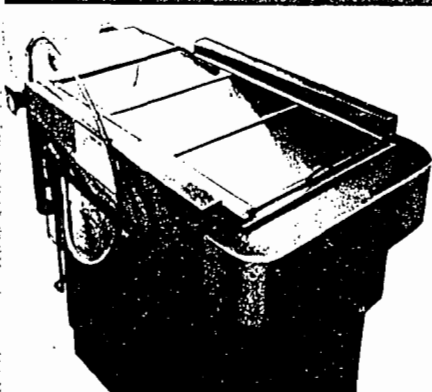

DETREX MANUAL TELESCOPING COVER

Rugged all-metal panels with easy glide side tracks. For smaller degreasers (up to 5' long).

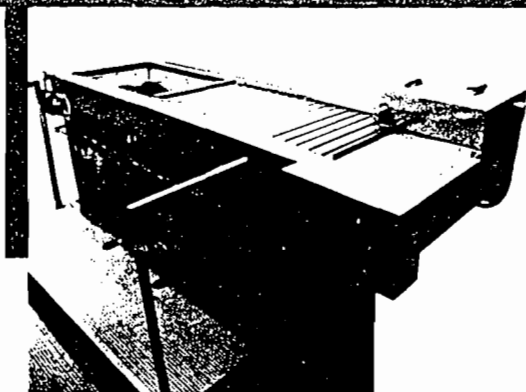

DETREX ALL METAL ROLL-UP COVER

Manual operation is standard on all degreasers 5' through 8' in length. Power option available.

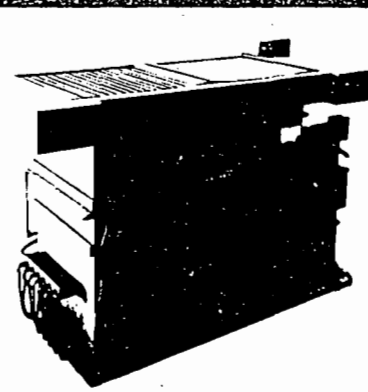

DETREX ALL METAL BI-PARTING ROLL-UP COVER

Has 1/2 HP drive with push-button control. Flexible seal on leading edges allows cover to close over hoist-cable. Standard on degreasers 10' and longer.

THE RULES ARE GETTING TOUGHER

The U.S. Environmental Protection Agency and most state environmental agencies have decreed that "all solvent vapor degreasers must be equipped with a cover that can be opened and closed easily, without disturbing the vapor zone. Degreasers must be kept closed at all times except when actually processing loads."

HOW YOU CAN COMPLY

All new DETREX open top degreasers are equipped with a reliable, smooth-operating cover that opens and closes in seconds. Whether telescoping, single directional roll-up, dual directional (bi-parting) roll-up, manual or push-button (powered), each DETREX cover substantially reduces solvent costs while providing a better working environment.

We can also retrofit most existing degreasers, regardless of their brand, with our rugged efficient covers. Degreasers longer than 8' utilize a powered, push-button controlled cover with 1/2 HP drive, built-in rotary limit switches and adjustable slip clutch.

* EMISSION TEST RESULTS

Extensive solvent emission tests were performed by PEDCO Environmental, Inc. for the U. S. Environmental Protection Agency, Phase 3, contract No. 68-02-2907. With a forced draft of 1.5 mph across the top of the degreaser, emission losses were reduced 52% by using a bi-parting cover. Similar tests performed by DETREX resulted in emission reduction between 38% and 53%, depending on ambient conditions.

For additional information contact:



DETREX CHEMICAL INDUSTRIES, INC.

4000 Towr. Center • Southfield, MI 48075
or Box 501 • Detroit, MI 48232 • Phone (313) 358-5800

0262
8107.2

PRINTED IN U.S.A.

ATTACHMENT F

REV.	CHANGE	BY	DATE	APP.
A	SHOW VENT OPENINGS	ORA	9/20/88	ORA

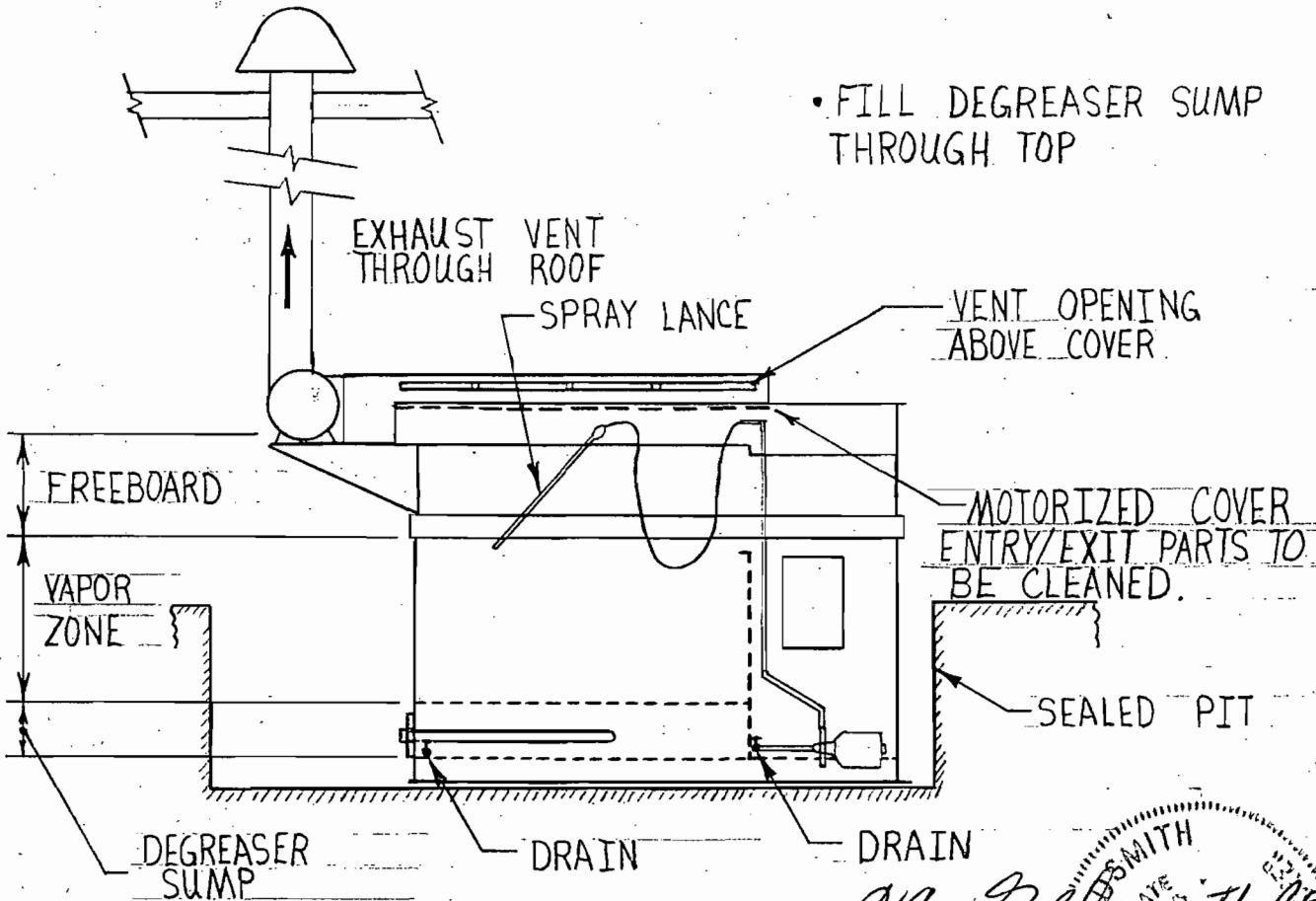

DEGREASER ELEVATION

N.T.S.

Wm. J. Smith
 9-20-88
 W. J. SMITH
 11-11-88
 11-11-88
 11-11-88



LET	ALTERATIONS	BY	APPD	DATE
DRAWN BY D.R. Adamson	DATE 9/9/88	APPROVED BY JK Chaw...	DATE 9/9/88	
CHECKED BY ORA	DATE 9/9/88			

SCALE NTS P.O. # E8157 CHANGE C815733

THERE IS NO SUBSTITUTE FOR QUALITY

T.M. & C. DEGREASER ELEVATION

DRAWING NO.
AX-80759A

SHT 1 OF 1

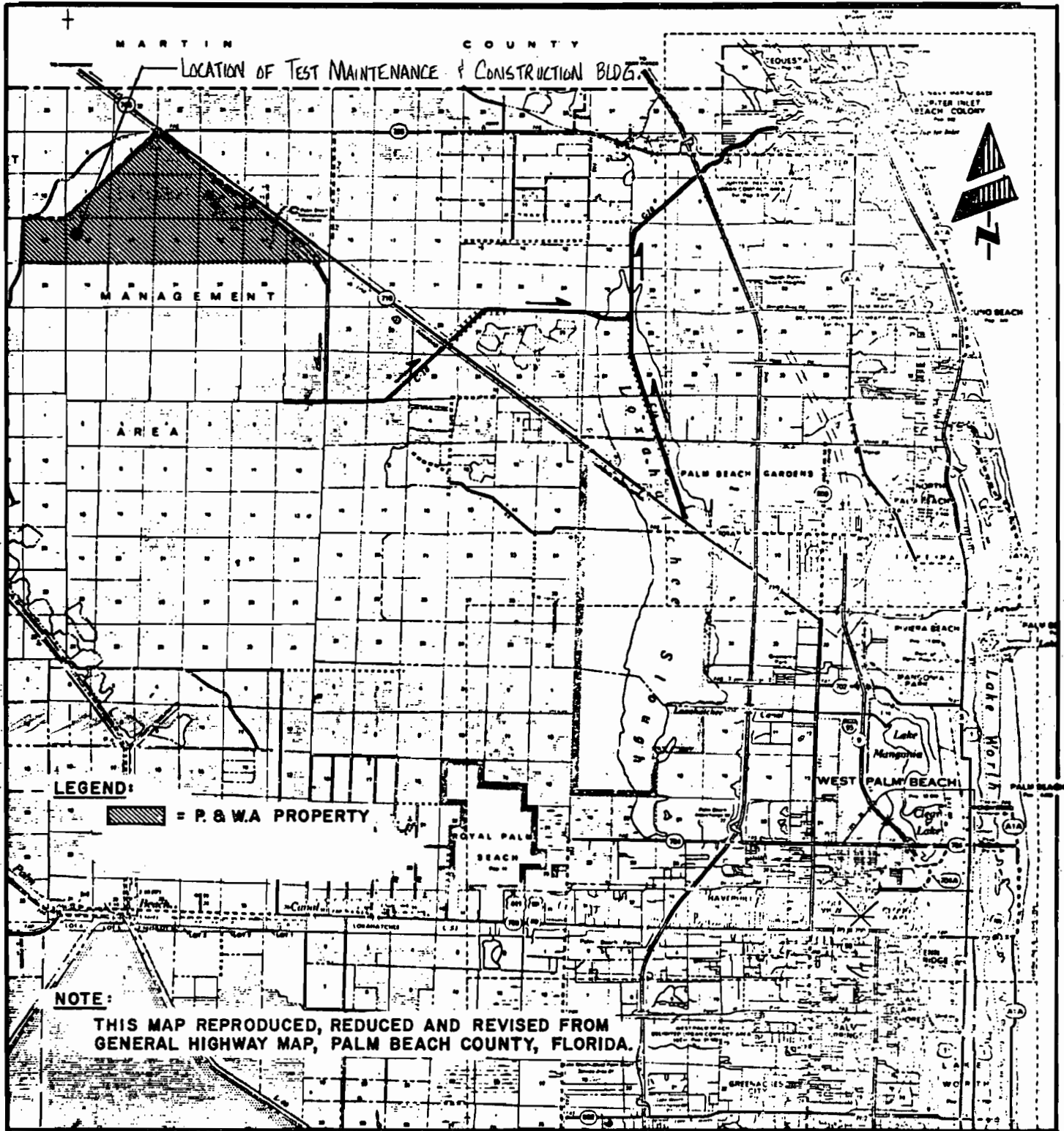

PL-772 A
7/18/81

SITE LOCATION MAP
FOR PRATT & WHITNEY AIRCRAFT PROPERTY
PALM BEACH COUNTY, FLORIDA

0 1 2 3 MILES
SCALE
Alm Frederick PE
No. 8620
REGISTERED ENGINEER
88

ATTACHMENT H



SHOP EXPANSION
SEE ENLARGEMENT
BELOW

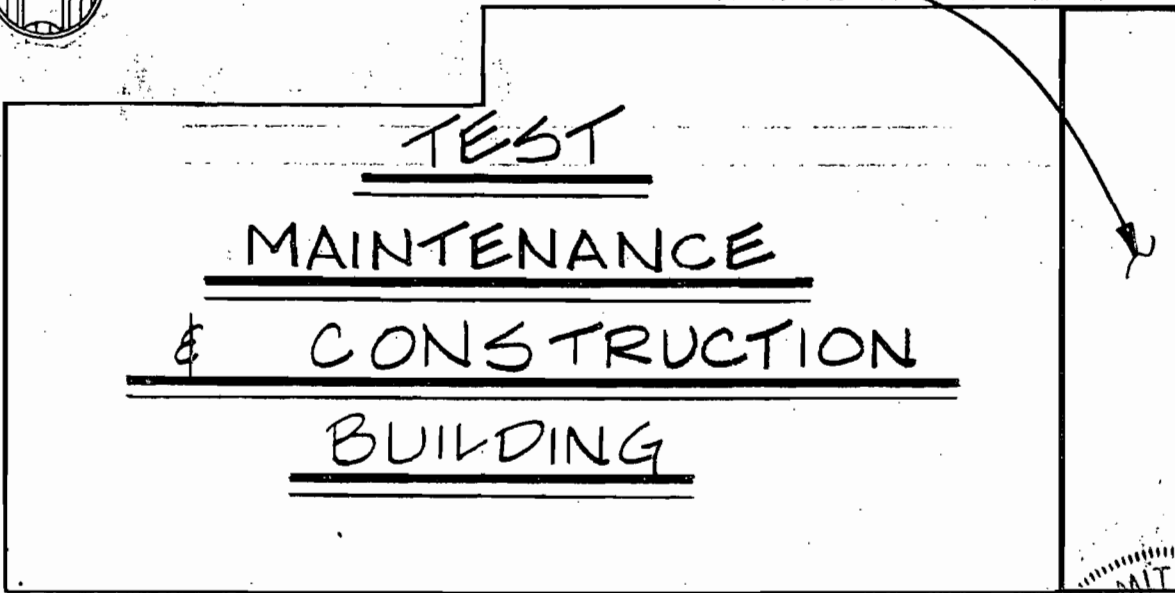

PLAN VIEW

SCALE: 1" = 50'-0"

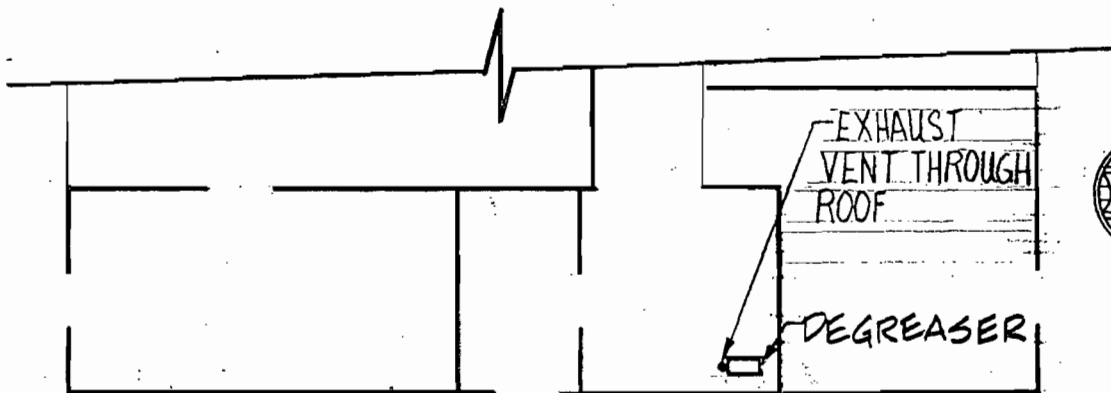
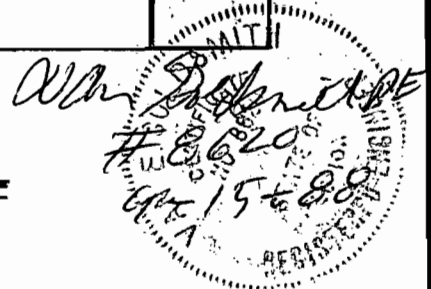

SHOP EXPANSION ENLARGEMENT

SCALE: 1" = 30'-0"



**UNITED
TECHNOLOGIES
PRATT & WHITNEY**

LET	ALTERATIONS	BY	APPD	DATE
DRAWN BY BLOMBERG	DATE 9-1-88	APPROVED BY		DATE
CHECKED BY	DATE			

SCALE NOTED *** EB157 CHANGE C815733

THERE IS NO SUBSTITUTE FOR QUALITY

DEGREASER LOCATION
T. M. & C. BUILDING

DRAWING NO.

AX-80731

SHT

OF

1

Detrex Model VS 800-E, Electric-heated, Hand- or Hoist-operated, Style S, Standard Size Degreaser Features and Specifications

Features included in standard Detrex designs are initial pure vapor cleaning, spray flushing with oil-free solvent distillate, and final pure vapor rinse. Designed to use with trichloroethylene, 1,1,1-trichloroethane or perchloroethylene solvents.

OPERATIONAL FEATURES

1. Water separator of ample capacity
2. Pump switch conveniently located
3. Solvent thermometer
4. Low liquid control/liquid high temperature control
5. Vapor level control
6. Vapor-up thermostat
7. Condenser water upper limit thermostat
8. Water flow switch
9. Spray lance

MAINTENANCE FEATURES

10. Immersion heaters removable for cleaning
11. Solvent spray pump
12. Integral storage tank
13. Bottom of machines sloped for easy drainage

SPECIAL FEATURES

14. Roll-up metal covers (see specifications)
15. Interior sidewall unobstructed
16. Sturdy work rests
17. Low-watt density heaters for longer service
18. Tank-type 304 stainless steel

OPTIONAL EQUIPMENT

01. Water temperature control
02. Exhaust system (not shown)
03. Freeboard chiller (not shown)
- *04. Motorized drive for cover (not shown)

**FOR 230-3-60 OR 440-3-60
ELECTRICAL SERVICE**

DETREX
CHEMICAL INDUSTRIES, INC.

P.O. BOX 501, DETROIT, MI 48232

Telephone: (313) 358-5800

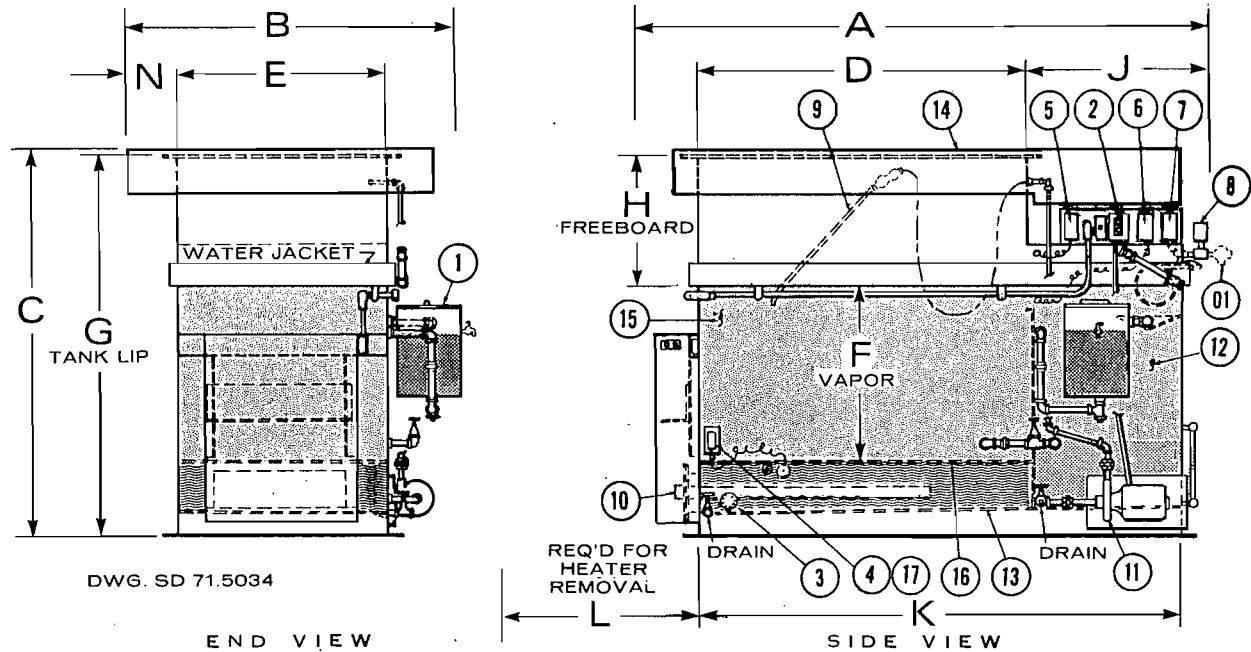

SIZE	OVERALL DIMENSIONS (Approx.)			MAXIMUM WORK CLEARANCE			DIMENSIONS						RATED PROD. lb Steel per hr	HEAT INPUT ELECT. kW	SOLV. CAP. ACITY gal.	WATER at (110°F Outlet)		WEIGHT (Approx.) lb	METAL COVER TYPE
	Length	Width	Height	Length	Width	Vapor Depth	Tank Lip	H	J	K	L	N				50°F RISE	25°F RISE		
																gph	gph		
50 30 30	8'-2"	5'-2"	6'-6"	60"	36"	36"	76"	27"	28"	84"	40"	11"	1500	24	115	110	220	1520	Hand Crank Roll-Up
70 30 30	10'-2"	5'-2"	6'-8"	84"	36"	36"	78"	27"	28"	108"	54"	11"	3000	36	155	180	360	1780	Hand Crank Roll-Up
80 40 40	11'-2"	6'-2"	8'-5"	96"	48"	48"	99"	36"	28"	120"	54"	11"	4000	54	250	275	550	3740	Hand Crank Roll-Up
10 40 40	14'-6"	6'-2"	9'-1"	120"	48"	48"	99"	36"	32"	144"	54"	11"	4000	54	250	245	490	4010	Bi-Parting Motorized Roll-up

*SIZE IDENTIFICATION: Reading from the left, each two digits for Style S machine represent the D, E and F dimensions, respectively, in feet and tenths of a foot. Thus, size 50 30 30 indicates internal working dimensions of 5.0 ft. long by 3.0 ft. wide by 3.0 ft. deep. An exception occurs in the largest size group where the first two digits (i.e. 10) mean ten feet and not one foot.

**Production capability derated by approximately one-third (1/3) when using Perchloroethylene solvent.