

The Department has reasonable assurance that the project will not result in significant net emission increases from the unit that would otherwise require a review under the Rules for the Prevention of Significant Deterioration (PSD) of Paragraph 62-212.400, F.A.C. or 40 CFR 52.21.

The Department will issue the Final Permit, in accordance with the conditions of the Draft Permit, unless a response received in accordance with the following procedures results in a different decision or significant change of terms or conditions. The Department will accept written comments concerning the proposed permit issuance action for a period of 14 days from the date of publication of this Public Notice of Intent to Issue Air Construction Permit. Written comments should be provided to the Department's Bureau of Air Regulation at 2600 Blair Stone Road, Mail Station #5505, Tallahassee, Florida 32399-2400. Any written comments filed shall be made available for public inspection. If comments received result in a significant change in the proposed agency action, the Department shall revise the proposed permit and require, if applicable, another Public Notice.

The Department will issue the permit with the attached conditions unless a timely petition for an administrative hearing is filed pursuant to sections 120.569 and 120.57 F.S., before the deadline for filing a petition. The procedures for petitioning for a hearing are set forth below. Mediation is not available in this proceeding.

A person whose substantial interests are affected by the proposed permitting decision may petition for an administrative proceeding (hearing) under sections 120.569 and 120.57 of the Florida Statutes. The petition must contain the information set forth below and must be filed (received) in the Office of General Counsel of the Department at 3900 Commonwealth Boulevard, Mail Station #35, Tallahassee, Florida, 32399-

and otherwise shall contain the same information as set forth above, as required by Rule 28-106.301

Because the administrative hearing process is designed to formulate final agency action, the filing of a petition means that the Department's final action may be different from the position taken by it in this notice. Persons whose substantial interests will be affected by any such final decision of the Department on the application have the right to petition to become a party to the proceeding, in accordance with the requirements set forth above.

A complete project file is available for public inspection during normal business hours, 8:00 a.m. to 5:00 p.m., Monday through Friday, except legal holidays, at:

Department of  
Environmental Protection  
Bureau of Air Regulation  
111 S. Magnolia Drive,  
Suite 4  
Tallahassee, Florida 32301  
Telephone: 850/488-0114  
Fax: 850/921-9533

Department of  
Environmental Protection  
Central District Office  
3319 Maguire Boulevard,  
Suite 232  
Orlando, Florida 32803-3767  
Telephone: 407/894-7555  
Fax: 407/897-5963

The complete project file includes the technical evaluation and the Draft Permit, and the information submitted by the responsible official, exclusive of confidential records under Section 403.111, F.S. Interested persons may contact the Program Administrator, South Permitting Section at 111 South Magnolia Drive, Suite 4, Tallahassee, Florida 32301, or call 850/488-0114, for additional information. The draft permit and technical evaluation can be accessed at <http://www.dep.state.fl.us/Air/permitting/construction/ouc-station-units.htm>

COR139024

12/9/06

**PUBLIC NOTICE OF INTENT  
TO ISSUE AIR  
CONSTRUCTION PERMIT**

**STATE OF FLORIDA  
DEPARTMENT OF  
ENVIRONMENTAL PROTECTION  
DEP File No. 0950137-011-AC  
OUC Curtis H. Stanton Energy  
Center Units 1 and 2  
Scrubber and Combustion  
Control Improvements  
Orange County**

The Department of Environmental Protection (Department) gives notice of its intent to issue an Air Construction Permit to OUC. The permit authorizes the installation of a dibasic acid (DBA) additive system for the Unit 1 and 2 wet flue gas desulfurization systems, and installation of a neural network-based combustion optimization system on Units 1 and 2 at the OUC Curtis H. Stanton Energy Center located in Orange County. A Best Available Control Technology (BACT) determination was not required. The applicant's name and address are OUC, Post Office Box 3193, Orlando, Florida 32802.

OUC Stanton Units 1 and 2 each consist of a coal fired boiler/steam generator and steam turbine with a 465 MW nominal capacity rating. Each unit is equipped with an electrostatic precipitator (ESP) for control of particulate matter (PM/PM10), and a wet flue gas desulfurization (WFGD) system for sulfur dioxide control. Unit 2 is also equipped with a selective catalytic reduction (SCR) system and low NOx burners for further control of NOx emissions.

The dibasic acid (DBA) addition system will be used to improve the SO2 removal efficiency of the existing WFGD systems on units 1 and 2 and consists of a 12,000 gallon DBA storage tank, 3 metering pumps, associated piping and valve systems, and instrumentation and controls. The DBA is handled as a solution therefore no sources of air emissions are associated with the actual additive system. Emissions of SO2 are expected to decrease as a direct result of the improved efficiency of the WFGD system. Because additional removal of SO2 will require greater limestone use, a minimal increase in particulate emissions from the limestone handling may occur. No other pollutants should be affected by the addition of the DBA addition system.

The neural network based combustion optimization system is a computer software addition to the plant's distributed control system (DCS) that utilizes the relationship between existing boiler control parameters and output performance measures, such as pollutant emissions and thermal efficiency, to optimize boiler operations. The neural network system is designed to enhance the overall performance of the unit and no increases in emissions of any criteria pollutants are expected due to this project.

The projects are part of a continuing program at OUC to reduce emissions of SO2 and NOx for the purpose of complying with the Clean Air Interstate Rule (CAIR).

**Legal Notices**

3000. Petitions filed by the permit applicant or any of the parties listed below must be filed within 14 days of receipt of this notice of intent. Petitions filed by any persons other than those entitled to written notice under section 120.60(3) of the Florida Statutes must be filed within 14 days of publication of the public notice or within fourteen days of receipt of this notice of intent, whichever occurs first. Under section 120.60(3), however, any person who asked the Department for notice of agency action may file a petition within 14 days of receipt of that notice, regardless of the date of publication. A petitioner shall mail a copy of the petition to the applicant at the address indicated above at the time of filing. The failure of any person to file a petition within the appropriate time period shall constitute a waiver of that person's right to request an administrative determination (hearing) under sections 120.569 and 120.57 F.S., or to intervene in this proceeding and participate as a party to it. Any subsequent intervention will be only at the approval of the presiding officer upon the filing of a motion in compliance with Rule 28-106.205 of the Florida Administrative Code.

A petition that disputes the material facts on which the Department's action is based must contain the following information: (a) The name and address of each agency affected and each agency's file or identification number, if known; (b) The name, address, and telephone number of the petitioner, the name, address, and telephone number of the petitioner's representative, if any, which shall be the address for service purposes during the course of the proceeding; and an explanation of how the petitioner's substantial interests will be affected by the agency determination; (c) A statement of how and when petitioner received notice of the agency action or proposed action; (d) A statement of all disputed issues of material fact. If there are none, the petition must so indicate; (e) A concise statement of the ultimate facts alleged, including the specific facts the petitioner contends warrant reversal or modification of the agency's proposed action; (f) A statement of the specific rules or statutes the petitioner contends require reversal or modification of the agency's proposed action; and (g) A statement of the relief sought by the petitioner, stating precisely the action petitioner wishes the agency to take with respect to the agency's proposed action.

A petition that does not dispute the material facts upon which the Department's action is based shall state that no such facts are in dispute.

**BUREAU OF AIR REGULATION  
DEC 18 2006  
RECEIVED**

## Adams, Patty

---

**From:** Harvey, Mary  
**Sent:** Wednesday, November 22, 2006 1:39 PM  
**To:** Mulkey, Cindy; Linero, Alvaro; Adams, Patty  
**Subject:** FW: Orlando Commission - Stanton Energy Center - Permit #0950137-011-AC-DRAFT

---

**From:** Kozlov, Leonard  
**Sent:** Wednesday, November 22, 2006 1:38 PM  
**To:** Harvey, Mary  
**Subject:** Read: Orlando Commission - Stanton Energy Center - Permit #0950137-011-AC-DRAFT

Your message

**To:** 'fhaddad@ouc.com'; 'dstalls@ouc.com'; Kozlov, Leonard; 'lori.cunniff@ocfl.net'; 'Little.James@epamail.epa.gov'; 'newlandt@bv.com'; Halpin, Mike  
**Cc:** Mulkey, Cindy; Linero, Alvaro; Adams, Patty; Gibson, Victoria  
**Subject:** Orlando Commission - Stanton Energy Center - Permit #0950137-011-AC-DRAFT  
**Sent:** 11/22/2006 1:32 PM

was read on 11/22/2006 1:38 PM.

## Adams, Patty

---

**From:** Harvey, Mary  
**Sent:** Wednesday, November 22, 2006 1:38 PM  
**To:** Mulkey, Cindy; Linero, Alvaro; Adams, Patty  
**Subject:** FW: Orlando Commission - Stanton Energy Center - Permit #0950137-011-AC-DRAFT

---

**From:** Newland, Larry T. (Todd) [<mailto:NewlandLT@bv.com>]  
**Sent:** Wednesday, November 22, 2006 1:36 PM  
**Subject:** Read: Orlando Commission - Stanton Energy Center - Permit #0950137-011-AC-DRAFT

Your message

To: [NewlandLT@bv.com](mailto:NewlandLT@bv.com)  
Subject:

was read on 11/22/2006 1:36 PM.

**Adams, Patty**

---

**From:** Harvey, Mary  
**Sent:** Wednesday, November 22, 2006 1:49 PM  
**To:** Adams, Patty; Mulkey, Cindy  
**Subject:** FW: Orlando Commission - Stanton Energy Center - Permit #0950137-011-AC-DRAFT

---

**From:** Halpin, Mike  
**Sent:** Wednesday, November 22, 2006 1:43 PM  
**To:** Harvey, Mary  
**Subject:** RE: Orlando Commission - Stanton Energy Center - Permit #0950137-011-AC-DRAFT

Thanks, Mary.  
Mike

---

**From:** Harvey, Mary  
**Sent:** Wednesday, November 22, 2006 1:32 PM  
**To:** 'fhaddad@ouc.com'; 'dstalls@ouc.com'; Kozlov, Leonard; 'lori.cunniff@ocfl.net'; 'Little.James@epamail.epa.gov'; 'newlandlt@bv.com'; Halpin, Mike  
**Cc:** Mulkey, Cindy; Linero, Alvaro; Adams, Patty; Gibson, Victoria  
**Subject:** Orlando Commission - Stanton Energy Center - Permit #0950137-011-AC-DRAFT

Dear Sir/Madam:

Please send a "reply" message verifying receipt of the attached document(s); this may be done by selecting "Reply" on the menu bar of your e-mail software and then selecting "Send". We must receive verification of receipt and your reply will preclude subsequent e-mail transmissions to verify receipt of the document(s).

The document(s) may require immediate action within a specified time frame. Please open and review the document(s) as soon as possible.

The document is in Adobe Portable Document Format (pdf). Adobe Acrobat Reader can be downloaded for free at the following internet site: <http://www.adobe.com/products/acrobat/readstep.html>.

The Bureau of Air Regulation is issuing electronic documents for permits, notices and other correspondence in lieu of hard copies through the United States Postal System, to provide greater service to the applicant and the engineering community. Please advise this office of any changes to your e-mail address or that of the Engineer-of-Record.

Thank you,

DEP, Bureau of Air Regulation

## Adams, Patty

---

**From:** Harvey, Mary  
**Sent:** Wednesday, November 22, 2006 1:42 PM  
**To:** Mulkey, Cindy; Linero, Alvaro; Adams, Patty  
**Subject:** FW: Orlando Commission - Stanton Energy Center - Permit #0950137-011-AC-DRAFT

---

**From:** Halpin, Mike  
**Sent:** Wednesday, November 22, 2006 1:41 PM  
**To:** Harvey, Mary  
**Subject:** Read: Orlando Commission - Stanton Energy Center - Permit #0950137-011-AC-DRAFT

Your message

**To:** 'fhaddad@ouc.com'; 'dstalls@ouc.com'; Kozlov, Leonard; 'lori.cunniff@ocfl.net'; 'Little.James@epamail.epa.gov'; 'newlandit@bv.com'; Halpin, Mike  
**Cc:** Mulkey, Cindy; Linero, Alvaro; Adams, Patty; Gibson, Victoria  
**Subject:** Orlando Commission - Stanton Energy Center - Permit #0950137-011-AC-DRAFT  
**Sent:** 11/22/2006 1:32 PM

was read on 11/22/2006 1:41 PM.

## Adams, Patty

---

**From:** Harvey, Mary  
**Sent:** Tuesday, November 28, 2006 9:09 AM  
**To:** Adams, Patty  
**Subject:** FW: Orlando Commission - Stanton Energy Center - Permit #0950137-011-AC-DRAFT

---

**From:** [Lori.Cunniff@ocfl.net](mailto:Lori.Cunniff@ocfl.net) [mailto:[Lori.Cunniff@ocfl.net](mailto:Lori.Cunniff@ocfl.net)]  
**Sent:** Wednesday, November 22, 2006 5:54 PM  
**To:** Harvey, Mary  
**Subject:** Read: Orlando Commission - Stanton Energy Center - Permit #0950137-011-AC-DRAFT

Your message

To: [Lori.Cunniff@ocfl.net](mailto:Lori.Cunniff@ocfl.net)  
Subject:

was read on 11/22/2006 5:54 PM.

# Florida Department of Environmental Protection

## Memorandum

TO: Trina Vielhauer  
THROUGH: Al Linero *AL*  
FROM: Cindy Mulkey *CM*  
DATE: November 20, 2006  
SUBJECT: Orlando Utilities Commission – Stanton Energy Center  
Dibasic Acid additive system and neural network Units 1 & 2  
DEP File No. 0950137-011-AC

Attached is the Intent to Issue package for the installation of a dibasic acid (DBA) additive system for Units 1 and 2 WFGD systems, and a neural network-based combustion optimization system on Units 1 and 2.

The DBA additive system works to improve the removal efficiency of the existing WFGD systems and will accomplish some low cost SO<sub>2</sub> reductions beyond the existing FGD systems that may suffice for CAIR.

The neural network combustion optimization system is a software addition used to enhance the capabilities of the existing plant distributed control system (DCS). By utilizing the relationships between certain performance outputs, such as pollutant emissions and boiler thermal efficiency, the neural network can be used to set controllable parameters in order to “fine-tune” and optimize combustion within the system.

The recent Unit B IGCC project includes a requirement for NO<sub>x</sub> reductions on Units 1 and 2. The installation of the combustion optimization system is the first measure identified by OUC towards meeting the requirements pursuant to the IGCC Unit B construction permit and is consistent with efforts pursuant to CAIR.

The only potential increase in emissions from either of these projects is a slight increase in fugitive particulate emissions associated with increased limestone handling as a result of greater SO<sub>2</sub> removal. Such an increase would not be significant.

We determined that the DBA additive system and the neural network combustion optimization system will not result in any significant increases in any criteria pollutants.

We recommend your approval of the attached Intent to Issue.

AAL/cm

Attachments



Because the administrative hearing process is designed to formulate final agency action, the filing of a petition means that the Department's final action may be different from the position taken by it in this notice. Persons whose substantial interests will be affected by any such final decision of the Department on the application have the right to petition to become a party to the proceeding, in accordance with the requirements set forth above. Mediation is not available in this proceeding.

Executed in Tallahassee, Florida.



Trina L. Vielhauer, Chief  
Bureau of Air Regulation

**CERTIFICATE OF SERVICE**

The undersigned duly designated deputy agency clerk hereby certifies that this Intent to Issue Air Construction Permit (including the Public Notice, Technical Evaluation, and the Draft permit) and all copies were sent electronically (with Received Receipt) before the close of business on 11/22/06 to the persons listed:

Frederick F. Haddad, Jr., OUC: [fhaddad@ouc.com](mailto:fhaddad@ouc.com)

Denise Stalls, OUC: [dstalls@ouc.com](mailto:dstalls@ouc.com)

Len Kozlov, DEP CD: [leonard.kozlov@dep.state.fl.us](mailto:leonard.kozlov@dep.state.fl.us)

Lori Cunniff, Orange County EPD: [lori.cunniff@ocfl.net](mailto:lori.cunniff@ocfl.net)

Jim Little, EPA Region 4: [little.james@epamail.epa.gov](mailto:little.james@epamail.epa.gov)

Larry Todd, Newland, Black & Veatch: [newlandlt@bv.com](mailto:newlandlt@bv.com)

Mike Halpin, DEP Siting: [mike.halpin@dep.state.fl.us](mailto:mike.halpin@dep.state.fl.us)

Clerk Stamp

**FILING AND ACKNOWLEDGMENT**

**FILED**, on this date, pursuant to §120.52, Florida Statutes, with the designated Department Clerk, receipt of which is hereby acknowledged.

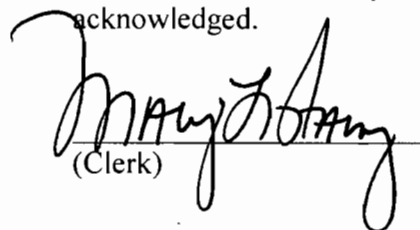
  
(Clerk)

11/22/06  
(Date)



# Department of Environmental Protection

Jeb Bush  
Governor

Twin Towers Office Building  
2600 Blair Stone Road  
Tallahassee, Florida 32399-2400  
Telephone: (850) 488-0114 FAX: (850) 922-6979

Colleen M. Castille  
Secretary

November 22, 2006

*Electronically sent – Received Receipt requested.*

Mr. Frederick F. Haddad, Jr.  
Vice President, Power Resources Business Unit  
Orlando Utilities Commission  
500 South Orange Avenue  
Post Office Box 3193  
Orlando, Florida 32802

Re: DEP File No. 0950137-011-AC  
Curtis H. Stanton Energy Center  
Dibasic Acid Additive and Neural Network Systems Installation

Dear Mr. Haddad:

Enclosed is one copy of the Draft Air Construction Permit to install a dibasic acid additive system for the wet flue gas desulfurization systems on Units 1 and 2, and to install a neural network-based combustion optimization system on Units 1 and 2 at the Curtis H. Stanton Energy Center in Orange County. The Department's Intent to Issue Air Construction Permit, the Technical Evaluation, and the "Public Notice of Intent to Issue Air Construction Permit" are also included.

The "Public Notice" must be published one time only as soon as possible in a newspaper of general circulation in the area affected, pursuant to the requirements of Chapter 50, Florida Statutes. Proof of publication, such as a newspaper affidavit, must be provided to the Department's Bureau of Air Regulation office within seven days of publication. Failure to publish the notice and provide proof of publication within the allotted time may result in denial of the permit.

Please submit any written comments you wish to have considered concerning the Department's proposed action to A.A. Linero, Program Administrator, at the letterhead address. If you have any questions regarding this matter, please contact Cindy Mulkey at (850)921-8968 or Mr. Linero at (850)921-9523.

Sincerely,

Trina Vielhauer, Chief  
Bureau of Air Regulation

TLV/aal/cm

Enclosures

In the Matter of an  
Application for Permit by:

Orlando Utilities Commission  
Post Office Box 3193  
Orlando, Florida 32802

*Authorized Representative:*

Mr. Frederick F. Haddad, Jr., Vice President

DEP File No. 0950137-011-AC  
Curtis H. Stanton Energy Center  
Dibasic Acid Additive System  
Neural Network System  
Stanton Units 1 and 2  
Orange County, Florida

### **INTENT TO ISSUE AIR CONSTRUCTION PERMIT**

The Department of Environmental Protection (Department) gives notice of its intent to issue an air construction permit, copy of Draft Permit attached, for the proposed project as detailed in their application and the attached Technical Evaluation for the reasons stated below.

The applicant, Orlando Utilities Commission, applied on September 5, 2006 to the Department for a permit to install a dibasic acid additive system for the Unit 1 and 2 desulfurization systems, and a neural network-based combustion optimization system on Units 1 and 2 at the existing Curtis H. Stanton Energy Center east of Orlando in Orange County.

The Department has permitting jurisdiction under the provisions of Chapter 403, Florida Statutes (F.S.), Florida Administrative Code (F.A.C.) Chapters 62-4, 62-210, and 62-212. The above actions are not exempt from permitting procedures. The Department has determined that an Air Construction Permit is required.

The Department intends to issue this air construction permit based on the belief that reasonable assurances have been provided to indicate that operation of these emissions units will not adversely impact air quality, and the emissions units will comply with all appropriate provisions of Chapters 62-4, 62-204, 62-210, 62-212, 62-296 and 62-297, F.A.C.

Pursuant to Section 403.815, F.S., and Rule 62-110.106(7)(a)1., F.A.C., you (the applicant) are required to publish at your own expense the enclosed Public Notice of Intent to Issue Permit. The notice shall be published one time only in the legal advertisement section of a newspaper of general circulation in the area affected. Rule 62-110.106(7)(b), F.A.C., requires that the applicant cause the notice to be published as soon as possible after notification by the Department of its intended action. For the purpose of these rules, "publication in a newspaper of general circulation in the area affected" means publication in a newspaper meeting the requirements of Sections 50.011 and 50.031, F.S., in the county where the activity is to take place. If you are uncertain that a newspaper meets these requirements, please contact the Department at the address or telephone number listed below. The applicant shall provide proof of publication to the Department's Bureau of Air Regulation, at 2600 Blair Stone Road, Mail Station #5505, Tallahassee, Florida 32399-2400 (Telephone: 850/488-0114; Fax 850/ 921-9533). You must provide proof of publication within seven days of publication, pursuant to Rule 62-110.106(5), F.A.C. No permitting action for which published notice is required shall be granted until proof of publication of notice is made by furnishing a uniform affidavit in substantially the form prescribed in section 50.051, F.S. to the office of the Department issuing the permit. Failure to publish the notice and provide proof of publication may result in the denial of the permit pursuant to Rules 62-110.106(9) & (11), F.A.C.

The Department will issue the final permit with the attached conditions unless a response received in accordance with the following procedures results in a different decision or significant change of terms or conditions.

The Department will accept written comments concerning the proposed permit issuance action for a period of 14 (fourteen) days from the date of publication of the enclosed Public Notice of Intent to Issue Permit. Written comments should be provided to the Department's Bureau of Air Regulation at 2600 Blair Stone Road, Mail Station #5505, Tallahassee, FL 32399-2400. Any written comments filed shall be made available for public inspection. If comments received result in a significant change in the proposed agency action, the Department shall revise the proposed permit and require, if applicable, another Public Notice.

The Department will issue the permit with the attached conditions unless a timely petition for an administrative hearing is filed pursuant to sections 120.569 and 120.57 F.S., before the deadline for filing a petition. The procedures for petitioning for a hearing are set forth below.

A person whose substantial interests are affected by the proposed permitting decision may petition for an administrative proceeding (hearing) under sections 120.569 and 120.57 of the Florida Statutes. The petition must contain the information set forth below and must be filed (received) in the Office of General Counsel of the Department at 3900 Commonwealth Boulevard, Mail Station #35, Tallahassee, Florida, 32399-3000. Petitions filed by the permit applicant or any of the parties listed below must be filed within fourteen days of receipt of this notice of intent. Petitions filed by any persons other than those entitled to written notice under section 120.60(3) of the Florida Statutes must be filed within fourteen days of publication of the public notice or within fourteen days of receipt of this notice of intent, whichever occurs first. Under section 120.60(3), however, any person who asked the Department for notice of agency action may file a petition within fourteen days of receipt of that notice, regardless of the date of publication. A petitioner shall mail a copy of the petition to the applicant at the address indicated above at the time of filing. The failure of any person to file a petition within the appropriate time period shall constitute a waiver of that person's right to request an administrative determination (hearing) under sections 120.569 and 120.57 F.S., or to intervene in this proceeding and participate as a party to it. Any subsequent intervention will be only at the approval of the presiding officer upon the filing of a motion in compliance with Rule 28-106.205 of the Florida Administrative Code.

A petition that disputes the material facts on which the Department's action is based must contain the following information: (a) The name and address of each agency affected and each agency's file or identification number, if known; (b) The name, address, and telephone number of the petitioner, the name, address, and telephone number of the petitioner's representative, if any, which shall be the address for service purposes during the course of the proceeding; and an explanation of how the petitioner's substantial interests will be affected by the agency determination; (c) A statement of how and when petitioner received notice of the agency action or proposed action; (d) A statement of all disputed issues of material fact. If there are none, the petition must so indicate; (e) A concise statement of the ultimate facts alleged, including the specific facts the petitioner contends warrant reversal or modification of the agency's proposed action; (f) A statement of the specific rules or statutes the petitioner contends require reversal or modification of the agency's proposed action; and (g) A statement of the relief sought by the petitioner, stating precisely the action petitioner wishes the agency to take with respect to the agency's proposed action.

A petition that does not dispute the material facts upon which the Department's action is based shall state that no such facts are in dispute and otherwise shall contain the same information as set forth above, as required by Rule 28-106.301.

**PUBLIC NOTICE OF INTENT TO ISSUE AIR CONSTRUCTION PERMIT**

STATE OF FLORIDA  
DEPARTMENT OF ENVIRONMENTAL PROTECTION

DEP File No. 0950137-011-AC

OUC Curtis H. Stanton Energy Center Units 1 and 2  
Scrubber and Combustion Control Improvements

Orange County

The Department of Environmental Protection (Department) gives notice of its intent to issue an Air Construction Permit to OUC. The permit authorizes the installation of a dibasic acid (DBA) additive system for the Unit 1 and 2 wet flue gas desulfurization systems, and installation of a neural network-based combustion optimization system on Units 1 and 2 at the OUC Curtis H. Stanton Energy Center located in Orange County. A Best Available Control Technology (BACT) determination was not required. The applicant's name and address are OUC, Post Office Box 3193, Orlando, Florida 32802.

OUC Stanton Units 1 and 2 each consist of a coal fired boiler/steam generator and steam turbine with a 468 MW nominal capacity rating. Each unit is equipped with an electrostatic precipitator (ESP) for control of particulate matter (PM/PM<sub>10</sub>), a wet flue gas desulfurization (WFGD) system for sulfur dioxide control, and low NO<sub>x</sub> burners for nitrogen oxides (NO<sub>x</sub>) control. Unit 2 is also equipped with a selective catalytic reduction (SCR) system for further control of NO<sub>x</sub> emissions.

The dibasic acid (DBA) addition system will be used to improve the SO<sub>2</sub> removal efficiency of the existing WFGD systems on units 1 and 2 and consists of a 12,000 gallon DBA storage tank, 3 metering pumps, associated piping and valve systems, and instrumentation and controls. The DBA is handled as a solution therefore no sources of air emissions are associated with the actual additive system. Emissions of SO<sub>2</sub> are expected to decrease as a direct result of the improved efficiency of the WFGD system. Because additional removal of SO<sub>2</sub> will require greater limestone use, a minimal increase in particulate emissions from the limestone handling may occur. No other pollutants should be affected by the addition of the DBA addition system.

The neural network based combustion optimization system is a computer software addition to the plant's distributed control system (DCS) that utilizes the relationship between existing boiler control parameters and output performance measures, such as pollutant emissions and thermal efficiency, to optimize boiler operations. The neural network system is designed to enhance the overall performance of the unit and no increases in emissions of any criteria pollutants are expected due to this project.

The projects are part of a continuing program at OUC to reduce emissions of SO<sub>2</sub> and NO<sub>x</sub> for the purpose of complying with the Clean Air Interstate Rule (CAIR).

The Department has reasonable assurance that the project will not result in significant net emission increases from the unit that would otherwise require a review under the Rules for the Prevention of Significant Deterioration (PSD) at Paragraph 62-212.400, F.A.C. or 40 CFR 52.21.

The Department will issue the Final Permit, in accordance with the conditions of the Draft Permit, unless a response received in accordance with the following procedures results in a different decision or significant change of terms or conditions.

The Department will accept written comments concerning the proposed permit issuance action for a period of 14 days from the date of publication of this Public Notice of Intent to Issue Air Construction Permit. Written comments should be provided to the Department's Bureau of Air Regulation at 2600 Blair Stone Road, Mail Station #5505, Tallahassee, Florida 32399-2400. Any written comments filed shall be made available for public inspection. If comments received result in a significant change in the proposed agency action, the Department shall revise the proposed permit and require, if applicable, another Public Notice.

The Department will issue the permit with the attached conditions unless a timely petition for an administrative hearing is filed pursuant to sections 120.569 and 120.57 F.S., before the deadline for filing a petition. The procedures for petitioning for a hearing are set forth below. Mediation is not available in this proceeding.

A person whose substantial interests are affected by the proposed permitting decision may petition for an administrative proceeding (hearing) under sections 120.569 and 120.57 of the Florida Statutes. The petition must contain the information set forth below and must be filed (received) in the Office of General Counsel of the Department at 3900 Commonwealth Boulevard, Mail Station #35, Tallahassee, Florida, 32399-3000. Petitions filed by the permit applicant or any of the parties listed below must be filed within 14 days of receipt of this notice of intent. Petitions filed by any persons other than those entitled to written notice under section 120.60(3) of the Florida Statutes must be filed within 14 days of publication of the public notice or within fourteen days of receipt of this notice of intent, whichever occurs first. Under section 120.60(3), however, any person who asked the Department for notice of agency action may file a petition within 14 days of receipt of that notice, regardless of the date of publication. A petitioner shall mail a copy of the petition to the applicant at the address indicated above at the time of filing. The failure of any person to file a petition within the appropriate time period shall constitute a waiver of that person's right to request an administrative determination (hearing) under sections 120.569 and 120.57 F.S., or to intervene in this proceeding and participate as a party to it. Any subsequent intervention will be only at the approval of the presiding officer upon the filing of a motion in compliance with Rule 28-106.205 of the Florida Administrative Code.

A petition that disputes the material facts on which the Department's action is based must contain the following information: (a) The name and address of each agency affected and each agency's file or identification number, if known; (b) The name, address, and telephone number of the petitioner, the name, address, and telephone number of the petitioner's representative, if any, which shall be the address for service purposes during the course of the proceeding; and an explanation of how the petitioner's substantial interests will be affected by the agency determination; (c) A statement of how and when petitioner received notice of the agency action or proposed action; (d) A statement of all disputed issues of material fact. If there are none, the petition must so indicate; (e) A concise statement of the ultimate facts alleged, including the specific facts the petitioner contends warrant reversal or modification of the agency's proposed action; (f) A statement of the specific rules or statutes the petitioner contends require reversal or modification of the agency's proposed action; and (g) A statement of the relief sought by the petitioner, stating precisely the action petitioner wishes the agency to take with respect to the agency's proposed action.

A petition that does not dispute the material facts upon which the Department's action is based shall state that no such facts are in dispute and otherwise shall contain the same information as set forth above, as required by Rule 28-106.301

Because the administrative hearing process is designed to formulate final agency action, the filing of a petition means that the Department's final action may be different from the position taken by it in this notice. Persons whose substantial interests will be affected by any such final decision of the Department on the application have the right to petition to become a party to the proceeding, in accordance with the requirements set forth above.

A complete project file is available for public inspection during normal business hours, 8:00 a.m. to 5:00 p.m., Monday through Friday, except legal holidays, at:

Department of Environmental Protection  
Bureau of Air Regulation  
111 S. Magnolia Drive, Suite 4  
Tallahassee, Florida 32301  
Telephone: 850/488-0114  
Fax: 850/921-9533

Department of Environmental Protection  
Central District Office  
3319 Maguire Boulevard, Suite 232  
Orlando, Florida 32803-3767  
Telephone: 407/894-7555  
Fax: 407/897-5963

The complete project file includes the technical evaluation and the Draft Permit, and the information submitted by the responsible official, exclusive of confidential records under Section 403.111, F.S. Interested persons may contact the Program Administrator, South Permitting Section at 111 South Magnolia Drive, Suite 4, Tallahassee, Florida 32301, or call 850/488-0114, for additional information. The draft permit and technical evaluation can be accessed at [http://www.dep.state.fl.us/Air/permitting/construction/ouc-stanton\\_units.htm](http://www.dep.state.fl.us/Air/permitting/construction/ouc-stanton_units.htm)

**TECHNICAL EVALUATION  
AND  
PRELIMINARY DETERMINATION**

Orlando Utilities Commission  
Curtis H. Stanton Energy Center Units 1 & 2

Dibasic Acid Additive and Neural Network Systems Installation

Orange County

DEP File No. 0950137-011-AC



Florida Department of Environmental Protection  
Division of Air Resource Management  
Bureau of Air Regulation  
Permitting South

November 22, 2006

**I. APPLICATION INFORMATION**

**A. APPLICANT NAME AND ADDRESS**

OUC  
 Post Office Box 3193  
 Orlando, Florida 32802

**Authorized Representative:**

Frederick F. Haddad, Jr.  
 V.P. Power Resources

**B. PROCESSING SCHEDULE**

- Application for Air Construction Permit received on September 5, 2006; and
- Department’s Intent to Issue and Public Notice Package dated November 22, 2006.

**C. FACILITY LOCATION AND DESCRIPTION**

The OUC Curtis H. Stanton Energy Center is located in Orange County, Southeast of Orlando and North of Highway 528 at 5100 South Alafaya Trail. The site is located 144 km southeast from the Chassahowitzka National Wildlife Area; the nearest Federal Prevention of Significant Deterioration (PSD) Class I Area. The UTM coordinates for this site are 483.6 km East and 3151.1 North. The location of the OUC Stanton Energy Center is shown in Figure 1.

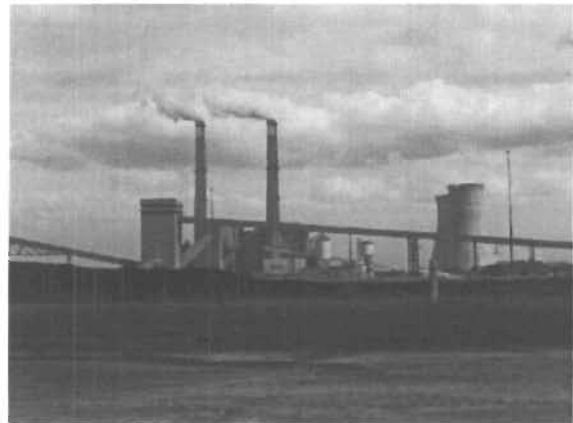
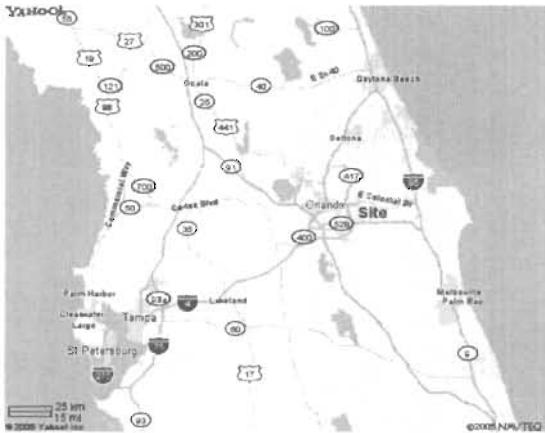

**Figure 1. Project Location near Orlando and OUC Stanton Units 1 and 2.**

The OUC Stanton Energy Center presently consists of two fossil fuel-fired steam electrical generating units and a combined cycle unit. Fossil fuel-fired steam electric generating Units 1 and 2 (468 MW each) began operation in 1987 and 1996 while Combined Cycle Unit A (640 MW) began operation in 2003. A draft PSD permit was recently issued for the construction of a nominal 285 MW integrated gasification combined cycle unit (Unit B) planned to be operational by 2012.

**Table 1. Oleander Power Project SIC Codes**

| STANDARD INDUSTRIAL CLASSIFICATION CODES (SIC) |      |                                      |
|--|------|--------------------------------------|
| Industry Group No.                             | 49   | Electric, Gas, and Sanitary Services |
| Industry No.                                   | 4911 | Electric Services                    |



#### D. REGULATORY CATEGORIES

*Title I, Part C, Clean Air Act (CAA):* The facility is located in an area that is designated as “attainment”, “maintenance”, or “unclassifiable” for each pollutant subject to a National Ambient Air Quality Standard. It is classified as a “fossil fuel-fired steam electric plant of more than 250 million BTU per hour of heat input”, which is one of the 28 Prevention of Significant Deterioration (PSD) Major Facility Categories with the lower PSD applicability threshold of 100 tons per year. Potential emissions of at least one regulated pollutant exceed 100 tons per year, therefore the facility is classified as a “major stationary source” of air pollution with respect to Rule 62-212.400 F.A.C., Prevention of Significant Deterioration of Air Quality.

*Title I, Section 111, CAA:* Units 1 and 2 are subject to Subpart Da (Standards of Performance for Electric Utility Steam Generating Units for Which Construction is Commenced After September 18, 1978) of the New Source Performance Standards in 40 CFR 60.

*Title I, Section 112, CAA:* The facility is a “Major Source” of hazardous air pollutants (HAPs).

*Title IV, CAA:* The facility operates units subject to the Acid Rain provisions of the Clean Air Act.

*Title V, CAA:* The facility is a Title V or “Major Source of Air Pollution” in accordance with Chapter 62-213, F.A.C. because the potential emissions of at least one regulated pollutant exceed 100 tons per year. Regulated pollutants include pollutants such as carbon monoxide (CO), nitrogen oxides (NO<sub>x</sub>), particulate matter (PM/PM<sub>10</sub>), sulfur dioxide (SO<sub>2</sub>), and volatile organic compounds (VOC).

*Siting:* The facility was originally certified pursuant to the power plant siting provisions of Chapter 62-17, F.A.C.

## II. PROJECT DESCRIPTION

The applicant proposes to install a dibasic acid (DBA) additive system on the existing wet scrubber flue gas desulfurization (WFGD) systems for Units 1 and 2, and a neural network-based combustion optimization system on Units 1 and 2.

A recent project at the OUC Stanton facility is the addition of an integrated gasification combined cycle unit (Unit B). The Unit B project includes a requirement for NO<sub>x</sub> reductions on the existing coal fired boilers (Units 1 and 2). Specific control strategies were not defined for the required NO<sub>x</sub> emissions reductions but are understood to include a series of measures to be undertaken over a period of time prior to the startup of Unit B. The overall program will address both the reductions related to Unit B and others related to the Clean Air Interstate Rule (CAIR).

The installation of the combustion optimization system is the first measure identified by OUC towards meeting the requirements pursuant to the IGCC Unit B permit (PSD-FL-373) and is consistent with efforts pursuant to CAIR. The neural network system will help to determine initial low cost, Low NO<sub>x</sub> operational strategies while the DBA project will accomplish some further low cost SO<sub>2</sub> reductions beyond the existing WFGD systems that may suffice for CAIR.

### A. DIBASIC ACID ADDITIVE SYSTEM

#### Limestone Scrubbing for Sulfur Dioxide Control

Stanton Units 1 and 2 utilize wet flue gas desulfurization (wet FGD) limestone-based scrubbers to control SO<sub>2</sub> emissions. The following figure is a simplified flow diagram of a design from the early 1990s that reasonably represents the scrubbing principles used at OUC Stanton Units 1 and 2. The point of DBA injection has been added for reference.

Limestone is ground and mixed with water in a reagent preparation area. The resultant slurry is pumped to the absorber and sprayed into the flue-gas stream. The slurry droplets absorb SO<sub>2</sub> from the flue gas and fall to the base of the absorber, where they are collected in a reaction tank.

The reactions in the absorber and tank can be represented by the following simplified description:

**Equation 1.** Sulfur dioxide and water react to form sulfurous acid.

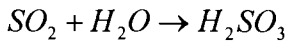

**Equation 2.** Sulfurous acid reacts with limestone to form calcium sulfite, carbon dioxide and water.

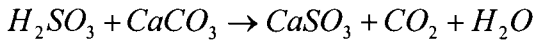

**Equation 3.** Calcium sulfite may (or may not) be further oxidized to form gypsum.

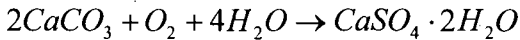

The final reaction to make gypsum is not practiced at OUC Stanton. Instead, fly ash removed prior to scrubbing is blended with scrubber calcium sulfite sludge and hydrated lime to solidify the material. It is then deposited in special retention areas on site, and covered with soil and vegetation.

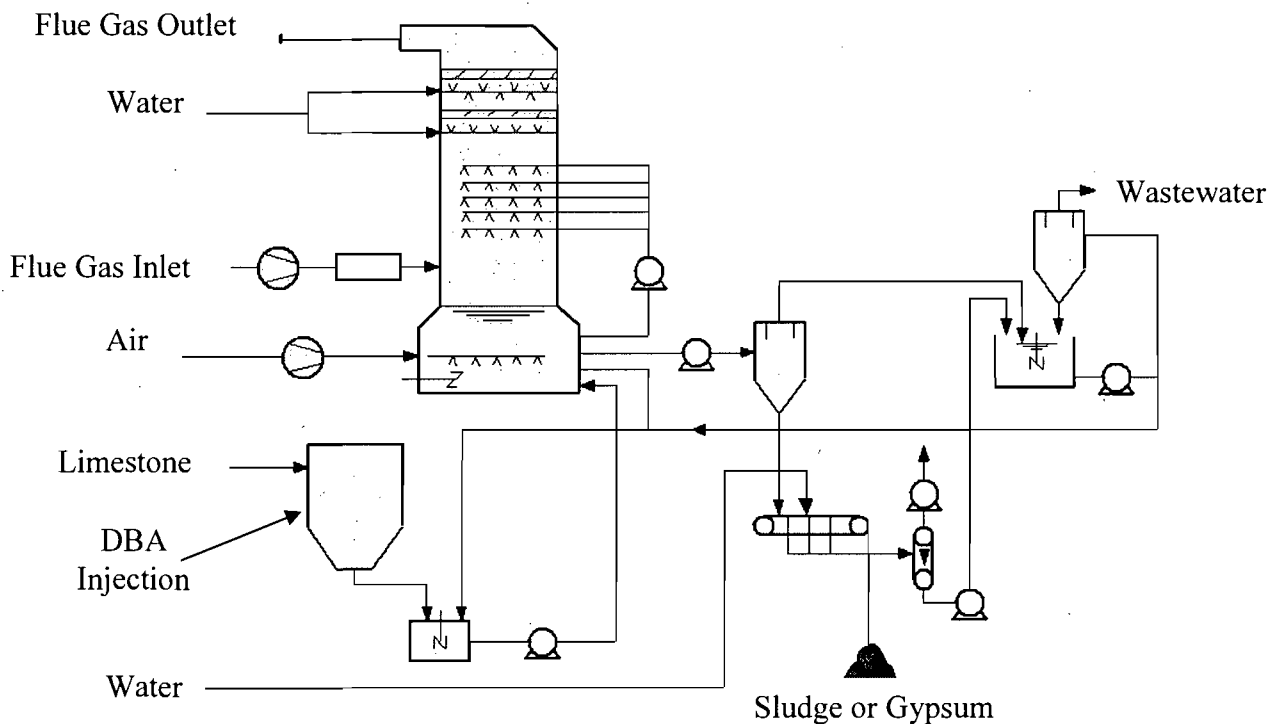

**Figure 2.** Flow diagram of a recent type of wet limestone scrubber system (Soud and Takeshita, 1994).

The rate and extent of the reactions are affected by several factors. The most important ones are the dissolution rate of the limestone and gas phase mass transfer. Absorption of  $SO_2$  requires intimate contact between the slurry droplets containing the limestone and the exhaust gas containing the  $SO_2$ .

The driving force for the acid-base reactions is the alkalinity of the slurry. Typically the term pH is used wherein a low value ( $\ll 7$ ) represents acidic conditions and a high value ( $\gg 7$ ) expresses an alkaline environment. Operation at a greater pH allows for increased  $SO_2$  removal and more efficient limestone utilization. On the other hand, higher pH reduces the dissolution rate of limestone making it less available for the reactions. At OUC, fresh limestone reagent is added to the reaction tank as a slurry to maintain the design pH, typically 4.5 to 5.5.

Physical characteristics that directly affect SO<sub>2</sub> removal efficiency and cost include reaction tank capacity, absorber size, number of trays or sprays, liquid to gas ratio (L/G), etc. SO<sub>2</sub> removal efficiency on the order of 90-95 percent (%) is typically achieved for such scrubber designs. Greater removal efficiencies are sometimes realized by over-design.

#### **Use of Buffering Chemicals to Enhance Scrubber Efficiency**

In cases where there are design limitations, especially for existing installations, scrubber performance can be enhanced by use of chemicals that buffer the slurry in a manner that yields the desired limestone utilization rate while not suppressing its dissolution. Thus absorption of SO<sub>2</sub> can be increased to some degree without making a significant capital investment. Among these chemicals is a class of organic acids that perform this function effectively and economically. Among the chemicals is di-basic acid (DBA). DBA is a mixture of dicarboxylic acids, namely glutaric, succinic and adipic acids.

DBA additive provides greater control over the pH in the upper and lower loop of the WFGD process. DBA was tested at Tampa Electric Company (TEC) Unit 4 with the assistance of the Department of Energy (DOE) and the Electric Power Research Institute (EPRI) with Radian as the contractor. According to Radian's 1995 report the baseline Unit 4 scrubber efficiency was estimated at 93.3%. By maintaining the upper loop at DBA concentrations of 125, 250, and 500 parts per million, control efficiencies of 95.5, 97.5 and 99.2% were achieved (other factors remaining equal).

According to the same report, the cost effectiveness of additional SO<sub>2</sub> removal by DBA was less than \$100 per ton removed. A reasonable goal for a scrubber achieving 90-95% removal efficiency is to convert it to one that operates in the 95-98% range. For example, the emissions at 96.5% efficiency are half of the emissions at 93% efficiency. This improvement can represent thousands of tons of SO<sub>2</sub> removed per year.

Although DBA is an effective method to improve SO<sub>2</sub> removal efficiency, it requires "tight" operational controls to maintain the desired pH settings. Sophisticated systems are available that can use the stack continuous emissions monitoring systems (CEMS) to optimize process controls and avoid excessive suppression of pH and swings in the limestone feed rate, particularly when burning coal with highly variable sulfur content.

#### **Components of the DBA System**

The DBA system consists of the following components:

- Three skid-mounted DBA metering pumps with associated valves and equipment;
- DBA storage tank;
- DBA addition piping and valves from storage tank to pump skid and from pump skid to the existing scrubber additive storage tanks; and
- Instrumentation and controls.

A general arrangement and preliminary piping and instrumentation diagram of the proposed DBA injection equipment are included in Figure 3 on the following page. The applicant provided the following details of the DBA system and its proposed operation. For reference, while maximum DBA utilization is expected to be on the order of 18 gallons per minute per unit, limestone use is on the order of hundreds of gallons per minute per unit.

TECHNICAL EVALUATION AND PRELIMINARY DETERMINATION

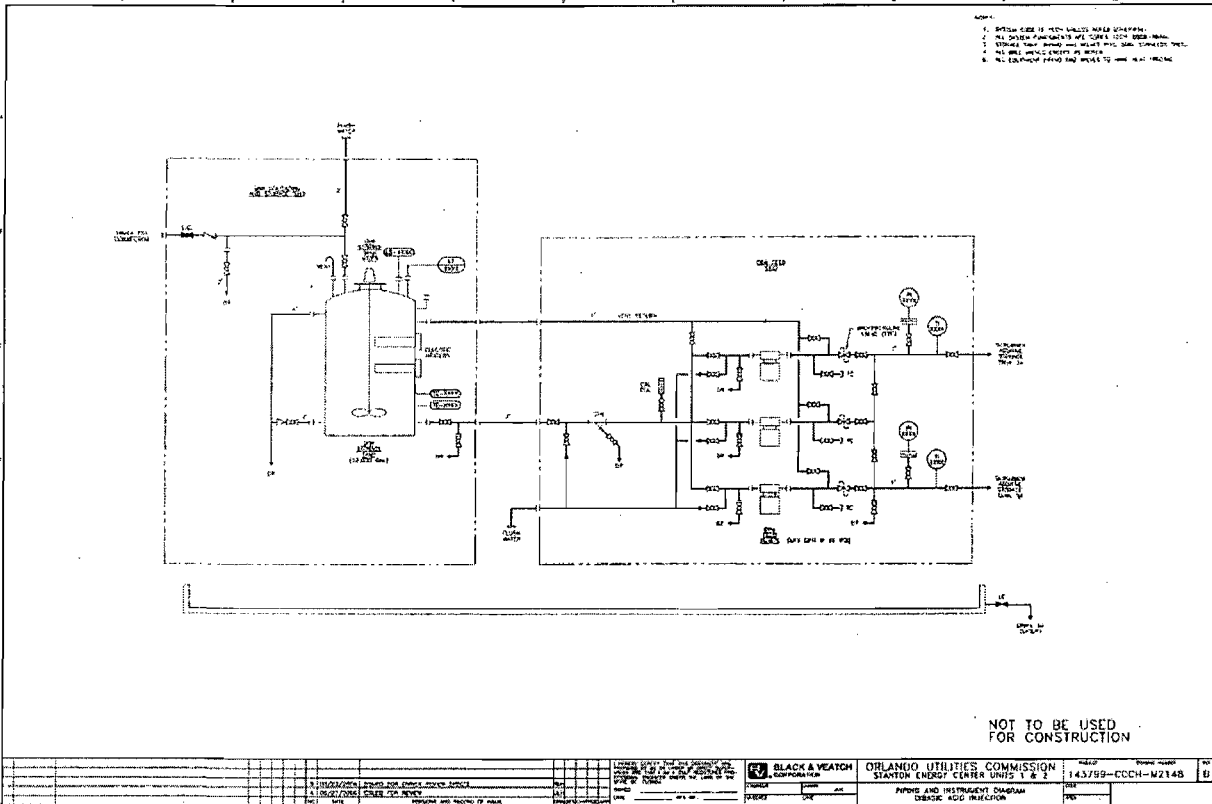
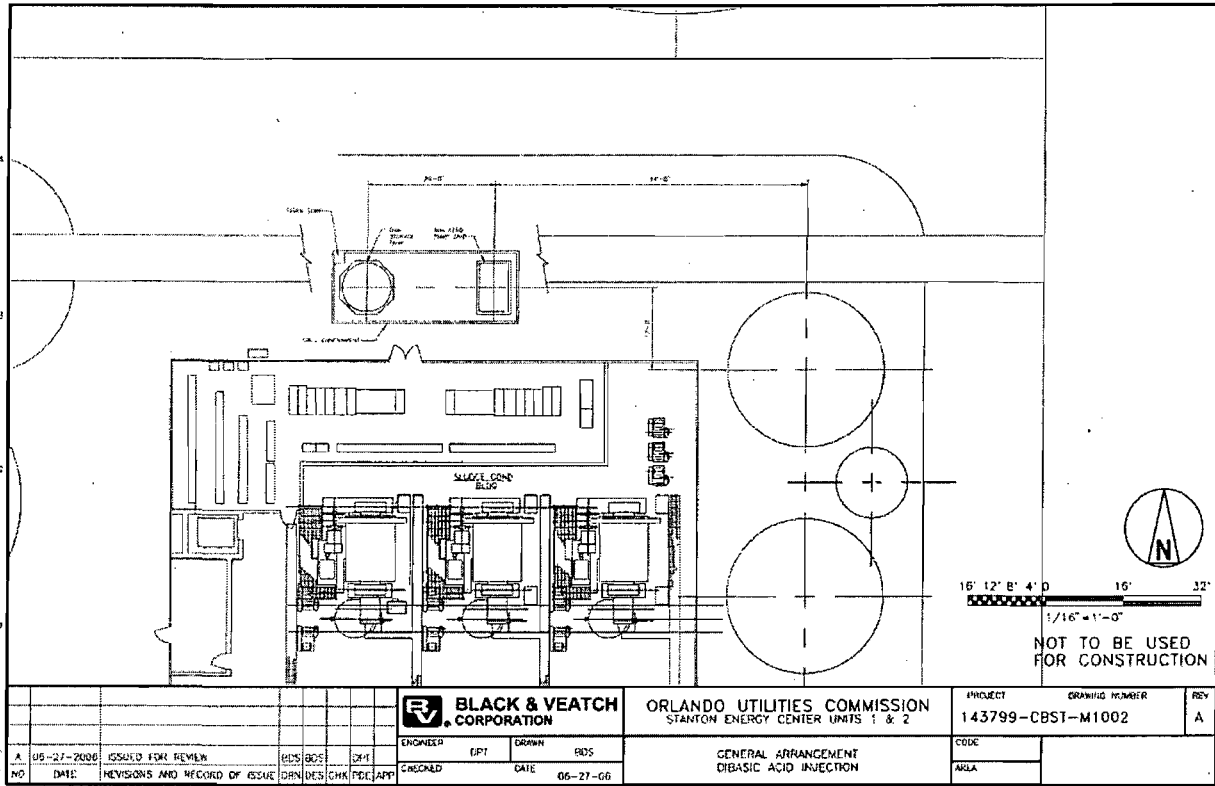
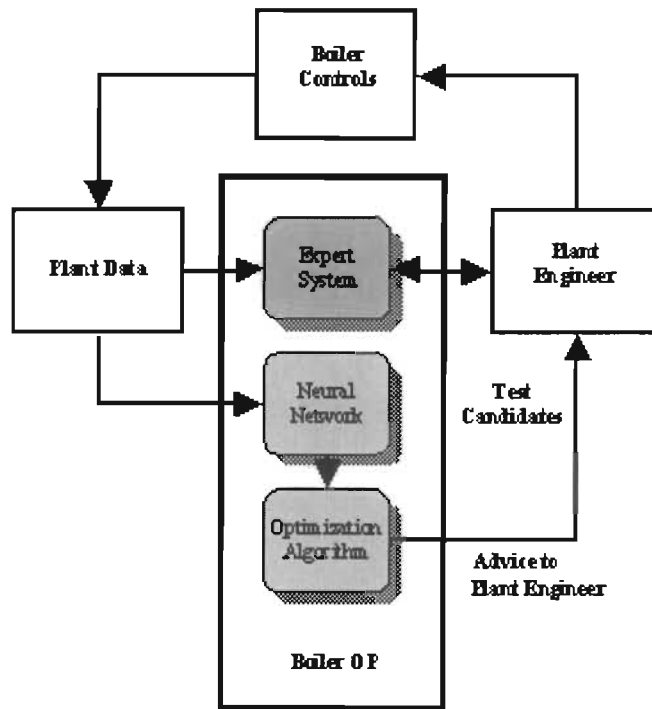

Figure 3. OUC Proposed DBA Injection Equipment.

**B. NEURAL NETWORK SYSTEM**

As described in the DOE Assessment of the Big Bend Power Station Neural Network-Sootblower Optimization Project (DOE, 2006), there are many forms of neural networks. Most commonly, “a neural network (computer code that models a system’s responses) consists of three layers: an input layer, a hidden layer, and an output layer. The input layer receives signals from the monitored variables and transmits them to the hidden layer, which contains interconnected neurons for pattern recognition. After processing, signals are sent to the output layer, which outputs recommended settings for control variables. Thus, a neural network is, in effect, a sophisticated curve fitting tool.”

Basically, a neural network is used to recognize patterns in input data, and recommend parameter settings that are most likely to result in the desired output. These patterns must be “learned” by the system and “training” often involves loading the system with historical data, and on-site operation at various operating scenarios in order to load the system with a range of variable parameters. The specific system planned for OUC Units 1 and 2 has not been selected. An example of a neural network combustion optimization system used to help operators achieve NO<sub>x</sub> and boiler performance goals by optimizing overall performance is shown in Figure 4.



**Figure 4.** Boiler OPT<sup>TM</sup> Low NO<sub>x</sub> Optimizer. (Lehigh University’s Energy Research Center)

The system at OUC will essentially be a computer software addition to the plant’s distributed control system (DCS) that will utilize the relationship between existing boiler control parameters and output performance measures, such as pollutant emissions and thermal efficiency, to optimize boiler operations.

According to the applicant, the following are anticipated benefits of using the neural network-based combustion optimization system:

- Enhancement of the ability of the existing DCS and boiler control system to fine-tune boiler operations that affect boiler emissions and thermal performance.
- Ability to be configured to manage and optimize the sometimes competing objectives of reduced reagent consumption (if an SCR is in place).

TECHNICAL EVALUATION AND PRELIMINARY DETERMINATION

- Self-evaluation and “learning” capabilities, so the system can be left in supervisory control of a plant indefinitely resulting in sustainable benefits.
- Quick adaptation to physical changes in the boiler combustion zone, such as low NO<sub>x</sub> burners and overfire air, as well as backend emissions control hardware changes, such as SCR and WFGD retrofits.

III. CONCLUSIONS

The Department expects actual emissions of NO<sub>x</sub> and SO<sub>2</sub> to decrease as a result of the DBA and Neural Network projects.

Minimal increases of fugitive emissions may occur due to the increased utilization of limestone made possible by the DBA project.

There are no specific limits for fugitive emissions associated with the limestone storage and handling facilities, however there are control strategies in place as required by the current Title V permit to minimize fugitive emissions from these and other activities. Emissions associated with limestone use are calculated for the Annual Operating Report using an emission factor of 0.0031 lb/ton of material processed. Any actual increases in fugitive particulate matter due to this project are expected to be negligible and will not cause a significant net emissions increase requiring PSD review and a BACT determination.

Because there are no expected increases of any regulated pollutant, the project is not a modification as described in 62-210.200 (Definitions) and therefore not subject to PSD review. However, a permit is still required in accordance with paragraph 62-210.300 that states:

*“Unless exempted from permitting pursuant to paragraph 62-210.300(3)(a) or (b), F.A.C., or Rule 62-4.040, F.A.C., or unless specifically authorized by provision of Rule 62-210.300(4), F.A.C., or Rule 62-213.300, F.A.C., the owner or operator of any facility or emissions unit which emits or can reasonably be expected to emit any air pollutant shall obtain an appropriate permit from the Department prior to beginning construction, reconstruction pursuant to 40 CFR 60.15 or 63.2, modification, or the addition of pollution control equipment; ..... etc.”*

The Department will issue a permit authorizing the installation of the two described systems. The combustion optimization system is the beginning of the NO<sub>x</sub> reduction strategy planned for Units 1 and 2 required as part of the Unit B IGCC project. Therefore, the specific NO<sub>x</sub> emissions limits and monitoring conditions applicable to Units 1 and 2 contained in the Unit B construction permit (PSD-FL-373) will be incorporated into the current permitting action.

The Department’s determination is strictly limited to this specific case and should not be used as a precedent for other cases, or lead to unintended consequences construed from the language contained in this determination. Ultimately, it is the Department that interprets its own regulations and opinions.

Handwritten notes: "ps is a modification = out for PSD review" and "DE" with a bracket pointing to the PSD review paragraph.

**PERMITTEE:**

Orlando Utilities Commission  
500 South Orange Avenue  
Orlando, Florida 32802

*Authorized Representative:*

Frederick Haddad, Jr.  
V.P., Power Resources Business Unit

DEP File No. 0950137-011-AC  
Curtis H. Stanton Energy Center  
Dibasic Acid Additive System  
Neural Network Systems  
Stanton Units 1 and 2  
Orange County, Florida

**PROJECT AND LOCATION**

This permit authorizes the addition of a dibasic acid additive delivery system to the existing wet flue gas desulfurization systems, and a neural network-based combustion optimization system to Units 1 and 2 at the Curtis H. Stanton Energy Center. The facility is located at 5100 Alafaya Trail, Orlando, Orange County.

**STATEMENT OF BASIS**

This permit is issued under the provisions of Chapter 403 of the Florida Statutes (F.S.), and Chapters 62-4, 62-204, 62-210, 62-212, 62-296, and 62-297 of the Florida Administrative Code (F.A.C.). The permittee is authorized to perform the proposed work in accordance with the conditions of this permit and as described in the application, approved drawings, plans, and other documents on file with the Department of Environmental Protection (Department). This permit supplements all other air construction and operation permits for the affected emissions units and does not alter any requirements from such previously issued air permits.

The attached Appendices are made a part of this permit:

Appendix GC Construction Permit General Conditions

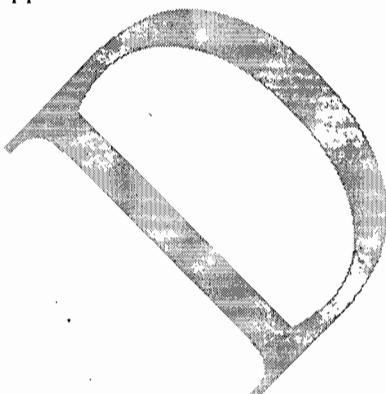

(DRAFT)

---

Joseph Kahn, Director  
Division of Air Resource Management

## SECTION I. GENERAL INFORMATION

### FACILITY DESCRIPTION

The existing facility consists of two 468 MW fossil fuel fired steam electric generating stations (Units 1 and 2), and one 640 MW combined cycle unit. There are storage and handling facilities for solid fuels, fly ash, limestone, gypsum, slag, and bottom ash. A draft PSD permit was recently issued for the construction of a nominal 285 MW integrated gasification combined cycle unit (Unit B) planned to be operational by 2012.

### PROJECT DESCRIPTION

The projects under this permit include installation of a dibasic acid (DBA) additive system on the existing wet scrubber flue gas desulfurization (WFGD) systems for Units 1 and 2, and a neural network-based combustion optimization system on Units 1 and 2.

The DBA system includes: three metering pumps; one DBA storage tank; associated piping, valves, and components; and instrumentation and controls. This project will accomplish further SO<sub>2</sub> reductions beyond the existing systems that may suffice for reductions pursuant to the Clean Air Interstate Rule.

Installation of the neural network-based combustion optimization system is the first measure identified by OUC towards meeting the requirements pursuant to the IGCC Unit B permit (PSD-FL-373) and is consistent with efforts pursuant to CAIR. The system will run on its own dedicated server pc, and will communicate directly with the plant distributed control system.

### EMISSIONS UNITS

This permit addresses the following emissions units:

| EU ID | Emissions Unit Description                       |
|-------|--|
| 001   | Fossil Fuel Fired Steam Electric Generator No. 1 |
| 002   | Fossil Fuel Fired Steam Electric Generator No. 2 |

### REGULATORY CLASSIFICATION

*Title I, Part C, Clean Air Act (CAA):* The facility is a PSD-major facility pursuant to Rule 62-212, F.A.C.

*Title I, Section 111, CAA:* Units 1 and 2 are subject to the New Source Performance Standards of 40 CFR 60, Subpart Da (Standards of Performance for Electric Utility Steam Generating Units for Which Construction is Commenced After September 18, 1978).

*Title I, Section 112, CAA:* The facility is a "Major Source" of hazardous air pollutants (HAPs).

*Title IV, CAA:* The facility operates units subject to the Acid Rain provisions of the Clean Air Act.

*Title V, CAA:* The facility is a Title V or "Major Source of air pollution" in accordance with Chapter 62-213, F.A.C.

*CAIR:* As an electric generating unit, Units 1 and 2 may be subject to the Clean Air Interstate Rule pending finalization of DEP rules.

*Siting:* The facility was originally certified pursuant to the power plant siting provisions of Chapter 62-17, F.A.C.



## SECTION I. GENERAL INFORMATION

---

### PERMITTING AUTHORITY

All documents related to applications for permits to construct, operate or modify an emissions unit shall be submitted to the Bureau of Air Regulation of the Florida Department of Environmental Protection (DEP) at 2600 Blair Stone Road (MS #5505), Tallahassee, Florida 32399-2400. Copies of all such documents shall also be submitted to the Compliance Authority.

### COMPLIANCE AUTHORITY

All documents related to compliance activities such as reports, tests, and notifications shall be submitted to the Department of Environmental Protection Central District Office at 3319 Maguire Boulevard, Suite 232, Orlando Florida 32803-3767.

### RELEVANT DOCUMENTS

The documents listed below are not a part of this permit; however, this information is specifically related to the permitting action and is on file with the Department.

- Application for installation of DBA and neural network systems received September 7, 2006.
- Department's Technical Evaluation and Preliminary Determination issued November 22, 2006.
- Department's Final Determination issued concurrently with this Final Permit.

## SECTION II. ADMINISTRATIVE REQUIREMENTS

1. General Conditions: The permittee shall operate under the attached General Conditions listed in Appendix GC of this permit. General Conditions are binding and enforceable pursuant to Chapter 403 of the Florida Statutes. [Rule 62-4.160, F.A.C.]
2. Applicable Regulations, Forms and Application Procedures: Unless otherwise indicated in this permit, the construction and operation of the subject emissions unit shall be in accordance with the capacities and specifications stated in the application. The facility is subject to all applicable provisions of: Chapter 403 of the Florida Statutes (F.S.); Chapters 62-4, 62-204, 62-210, 62-212, 62-213, 62-296, and 62-297 of the Florida Administrative Code (F.A.C.); and the Title 40, Parts 51, 52, 60, and 63 of the Code of Federal Regulations (CFR), adopted by reference in Rule 62-204.800, F.A.C. The permittee shall use the applicable forms listed in Rule 62-210.900, F.A.C. and follow the application procedures in Chapter 62-4, F.A.C. Issuance of this permit does not relieve the permittee from compliance with any applicable federal, state, or local permitting or regulations. [Rules 62-204.800, 62-210.300 and 62-210.900, F.A.C.]
3. Construction and Expiration: Authorization to construct shall expire if construction is not commenced within 18 months after receipt of the permit, if construction is discontinued for a period of 18 months or more, or if construction is not completed within a reasonable time. The Department may extend the 18-month period upon a satisfactory showing that an extension is justified. [Rules 62-4.070(4), 62-4.080, 62-210.300(1), F.A.C.]
4. New or Additional Conditions: For good cause shown and after notice and an administrative hearing, if requested, the Department may require the permittee to conform to new or additional conditions. The Department shall allow the permittee a reasonable time to conform to the new or additional conditions, and on application of the permittee, the Department may grant additional time. [Rule 62-4.080, F.A.C.]
5. Source Obligation.
  - a. At such time that a particular source or modification becomes a major stationary source or major modification (as these terms were defined at the time the source obtained the enforceable limitation) solely by virtue of a relaxation in any enforceable limitation which was established after August 7, 1980, on the capacity of the source or modification otherwise to emit a pollutant, such as a restriction on hours of operation, then the requirements of subsections 62-212.400(4) through (12), F.A.C., shall apply to the source or modification as though construction had not yet commenced on the source or modification.
  - b. At such time that a particular source or modification becomes a major stationary source or major modification (as these terms were defined at the time the source obtained the enforceable limitation) solely by exceeding its projected actual emissions, then the requirements of subsections 62-212.400(4) through (12), F.A.C., shall apply to the source or modification as though construction had not yet commenced on the source or modification.[Rule 62-212.400(12), F.A.C.]
6. Modifications: No emissions unit or facility subject to this permit shall be constructed or modified without obtaining an air construction permit from the Department. Such permit shall be obtained prior to beginning construction or modification. [Chapters 62-210 and 62-212, F.A.C.]
7. Title V Permit: This permit authorizes construction or modification of the permitted emissions units and initial operation to determine compliance with Department rules. A Title V operation permit is required for regular operation of the permitted emissions units. The permittee shall apply for a Title V operation permit at least 90 days prior to expiration of this permit, but no later than 180 days after commencing operation. To apply for a Title V operation permit, the applicant shall submit the appropriate application form, compliance test results, and such additional information as the Department may by law require. The application shall be submitted to the Compliance Authority. [Rules 62-4.030, 62-4.050, 62-4.220 and Chapter 62-213, F.A.C.]

**SECTION III - EMISSIONS UNITS SPECIFIC CONDITIONS**  
**Units 1 and 2 Fossil Fuel Fired Steam Generators (EU 001 and 002)**

This section of the permit addresses the following existing emissions units.

**Emissions Unit 001 and 002**

Fossil Fuel Fired Steam Generators 1 and 2 are wall-fired, dry bottom boilers, firing pulverized coal as the primary fuel and No. 6 fuel oil for purposes of startup and flame stabilization. Each unit has a maximum heat input rate of 4,286 mmBtu per hour with a nominal generating capacity of 468 MW. Each unit is equipped with an electrostatic precipitator (ESP) for control of particulate matter (PM/PM<sub>10</sub>), a WFGD system for sulfur dioxide (SO<sub>2</sub>) control, and low NO<sub>x</sub> burners for nitrogen oxides (NO<sub>x</sub>) control. Unit 2 is also equipped with a selective catalytic reduction (SCR) system for further control of NO<sub>x</sub> emissions. The following parameters are continuously monitored on both units: NO<sub>x</sub>, opacity, SO<sub>2</sub>, CO<sub>2</sub>, and stack gas flow rate.

**ADMINISTRATIVE REQUIREMENTS**

1. Relation to Other Permits: The conditions of this permit are in addition to those of any other air construction or operation permits for these units. [Rule 62-4.030, 62-4.210, and 62-210.300(1)(b), F.A.C.]

**EQUIPMENT AND CONTROL TECHNOLOGY**

2. Dibasic Acid Additive System: The permittee is authorized to install and maintain a dibasic acid (DBA) additive system associated with the existing WFGD systems on Units 1 and 2 for the purpose of improving SO<sub>2</sub> removal efficiencies and enhancing overall scrubber performance. The additive system consists of the following components:

- Three skid-mounted DBA metering pumps with associated valves and equipment;
- DBA storage tank;
- DBA addition piping and valves from storage tank to pump skid and from pump skid to the existing scrubber additive storage tanks; and
- Instrumentation and controls.

[Applicant Request, and Rule 62-210.300 (Permits Required), F.A.C.]

3. Neural Network Combustion Optimization System: The permittee is authorized to install and maintain a neural network-based combustion optimization system to interface with the existing plant distributed control system for the purpose of optimizing boiler operations.

[Applicant Request, and Rule 62-210.300 (Permits Required), F.A.C.]

**EMISSIONS REQUIREMENTS**

4. NO<sub>x</sub> Emissions Cap: Units 1 and 2 will meet the following NO<sub>x</sub> emissions limits.
  - a. Existing Units 1 and 2: The combined NO<sub>x</sub> emissions from existing coal fired boiler-steam electric generating Stanton Unit 1 and Stanton Unit 2 shall not exceed 8,300 tons per year on a 12-month rolling total. Total NO<sub>x</sub> emissions shall be based on data collected from the Unit 1 and Unit 2 NO<sub>x</sub> CEMS. Compliance shall be determined after each calendar month by calculating the total emissions from that calendar month and the last 11 calendar months beginning the first month of first fire of IGCC Unit B and thereafter.
  - b. If the combined NO<sub>x</sub> emissions from Units 1 and 2 exceed 8,300 tons during any 12-month period, and/or the total NO<sub>x</sub> emissions from Unit B exceeds 1,006 tons during any 12-month period, Unit B shall be subject to PSD preconstruction review at that time, and a determination of BACT for NO<sub>x</sub> shall be made.

### SECTION III - EMISSIONS UNITS SPECIFIC CONDITIONS

#### Units 1 and 2 Fossil Fuel Fired Steam Generators (EU 001 and 002)

- c. For purposes of meeting the NO<sub>x</sub> emissions caps, annual emission of NO<sub>x</sub> from existing Units 1 and 2, and Unit B shall be calculated with no allowable data exclusions. All valid hours of data (including startup and shutdown) must be included in the rolling 12-month totals. Also, the data substitution procedures of Part 75 for missing data shall not be used in these calculations.

[62-210.200 (net emissions increase), 62-210.370 (emissions computation), and 62-212.400(12) (Source Obligation), F.A.C.]

*{Permitting Note: IGCC Unit B did not trigger PSD for NO<sub>x</sub> due to a NO<sub>x</sub> emissions cap taken on existing coal fired boiler steam electric generating Unit 1 and Unit 2. The above conditions establish the requirements for meeting the NO<sub>x</sub> emissions limitations for purposes of avoiding PSD preconstruction review by Unit B. These requirements in no way supersede any federal requirement of the applicable NSPS or NESHAP provisions.}*

#### REPORTING AND NOTIFICATION REQUIREMENTS

5. **Notification:** Within one week of beginning construction of the DBA additive system, the permittee shall notify the Compliance Authority that the project has commenced and provide a general schedule of construction activities. Within one week following the end of construction, the permittee shall notify the Compliance Authority that the project was completed. Within one week of completing installation of the neural network-based combustion optimization system, the permittee shall notify the Compliance Authority that the project was completed. [Rule 62-4.210, F.A.C.]
6. **SIP Quarterly Report:** In addition to, and included in, the SIP quarterly excess emissions report required for Unit B the permittee shall submit a report to the Compliance Authority summarizing the previous three 12-month totals of NO<sub>x</sub> emissions from Units 1 and 2. The quarterly report is due within 30 days following the end of each calendar-quarter. [Rule 62-4.070, F.A.C.]

## Appendix GC - Construction Permit General Conditions

---

The permittee shall comply with the following general conditions from Rule 62-4.160, F.A.C.

1. The terms, conditions, requirements, limitations, and restrictions set forth in this permit are "Permit Conditions" and are binding and enforceable pursuant to Sections 403.161, 403.727, or 403.859 through 403.861, Florida Statutes. The permittee is placed on notice that the Department will review this permit periodically and may initiate enforcement action for any violation of these conditions.
2. This permit is valid only for the specific processes and operations applied for and indicated in the approved drawings or exhibits. Any unauthorized deviation from the approved drawings, exhibits, specifications, or conditions of this permit may constitute grounds for revocation and enforcement action by the Department.
3. As provided in Subsections 403.087(6) and 403.722(5), Florida Statutes, the issuance of this permit does not convey and vested rights or any exclusive privileges. Neither does it authorize any injury to public or private property or any invasion of personal rights, nor any infringement of federal, state or local laws or regulations. This permit is not a waiver or approval of any other Department permit that may be required for other aspects of the total project which are not addressed in the permit.
4. This permit conveys no title to land or water, does not constitute State recognition or acknowledgment of title, and does not constitute authority for the use of submerged lands unless herein provided and the necessary title or leasehold interests have been obtained from the State. Only the Trustees of the Internal Improvement Trust Fund may express State opinion as to title.
5. This permit does not relieve the permittee from liability for harm or injury to human health or welfare, animal, or plant life, or property caused by the construction or operation of this permitted source, or from penalties therefore; nor does it allow the permittee to cause pollution in contravention of Florida Statutes and Department rules, unless specifically authorized by an order from the Department.
6. The permittee shall properly operate and maintain the facility and systems of treatment and control (and related appurtenances) that are installed or used by the permittee to achieve compliance with the conditions of this permit, as required by Department rules. This provision includes the operation of backup or auxiliary facilities or similar systems when necessary to achieve compliance with the conditions of the permit and when required by Department rules.
7. The permittee, by accepting this permit, specifically agrees to allow authorized Department personnel, upon presentation of credentials or other documents as may be required by law and at a reasonable time, access to the premises, where the permitted activity is located or conducted to:
  - a. Have access to and copy and records that must be kept under the conditions of the permit;
  - b. Inspect the facility, equipment, practices, or operations regulated or required under this permit, and,
  - c. Sample or monitor any substances or parameters at any location reasonably necessary to assure compliance with this permit or Department rules.

Reasonable time may depend on the nature of the concern being investigated.

8. If, for any reason, the permittee does not comply with or will be unable to comply with any condition or limitation specified in this permit, the permittee shall immediately provide the Department with the following information:
  - a. A description of and cause of non-compliance; and
  - b. The period of noncompliance, including dates and times; or, if not corrected, the anticipated time the non-compliance is expected to continue, and steps being taken to reduce, eliminate, and prevent recurrence of the non-compliance.

The permittee shall be responsible for any and all damages which may result and may be subject to enforcement action by the Department for penalties or for revocation of this permit.

9. In accepting this permit, the permittee understands and agrees that all records, notes, monitoring data and other information relating to the construction or operation of this permitted source which are submitted to the Department may be used by the Department as evidence in any enforcement case involving the permitted source arising under the Florida Statutes or Department rules, except where such use is prescribed by Sections 403.73 and 403.111, Florida Statutes. Such evidence shall only be used to the extent it is consistent with the Florida Rules of Civil Procedure and appropriate evidentiary rules.

## Appendix GC - Construction Permit General Conditions

---

10. The permittee agrees to comply with changes in Department rules and Florida Statutes after a reasonable time for compliance, provided, however, the permittee does not waive any other rights granted by Florida Statutes or Department rules.
11. This permit is transferable only upon Department approval in accordance with Florida Administrative Code Rules 62-4.120 and 62-730.300, F.A.C., as applicable. The permittee shall be liable for any non-compliance of the permitted activity until the transfer is approved by the Department.
12. This permit or a copy thereof shall be kept at the work site of the permitted activity.
13. This permit also constitutes:
  - a. Determination of Best Available Control Technology (Not Applicable);
  - b. Determination of Prevention of Significant Deterioration (Not Applicable);
  - c. Compliance with National Emission Standards for Hazardous Air Pollutants (Not Applicable); and
  - d. Compliance with New Source Performance Standards (Not Applicable).
14. The permittee shall comply with the following:
  - a. Upon request, the permittee shall furnish all records and plans required under Department rules. During enforcement actions, the retention period for all records will be extended automatically unless otherwise stipulated by the Department.
  - b. The permittee shall hold at the facility or other location designated by this permit records of all monitoring information (including all calibration and maintenance records and all original strip chart recordings for continuous monitoring instrumentation) required by the permit, copies of all reports required by this permit, and records of all data used to complete the application or this permit. These materials shall be retained at least three years from the date of the sample, measurement, report, or application unless otherwise specified by Department rule.
  - c. Records of monitoring information shall include:
    - 1) The date, exact place, and time of sampling or measurements;
    - 2) The person responsible for performing the sampling or measurements;
    - 3) The dates analyses were performed;
    - 4) The person responsible for performing the analyses;
    - 5) The analytical techniques or methods used; and
    - 6) The results of such analyses.

When requested by the Department, the permittee shall within a reasonable time furnish any information required by law which is needed to determine compliance with the permit. If the permittee becomes aware that relevant facts were not submitted or were incorrect in the permit application or in any report to the Department, such facts or information shall be corrected promptly

PUBLIC NOTICE OF INTENT  
TO ISSUE AIR  
CONSTRUCTION PERMIT

STATE OF FLORIDA  
DEPARTMENT OF  
ENVIRONMENTAL PROTECTION  
DEP File No. 0950137-01-AC  
OUC Curtis H. Stanton Energy  
Center Units 1 and 2  
Scrubber and Combustion  
Control Improvements  
Orange County

The Department of Environmental Protection (Department) gives notice of its intent to issue an Air Construction Permit to OUC. The permit authorizes the installation of a dibasic acid (DBA) additive system for the Unit 1 and 2 wet flue gas desulfurization systems, and installation of a neural network-based combustion optimization system on Units 1 and 2 of the OUC Curtis H. Stanton Energy Center located in Orange County. A Best Available Control Technology (BACT) determination was not required. The applicant's name and address are OUC, Post Office Box 3193, Orlando, Florida 32802.

OUC Stanton Units 1 and 2 each consist of a coal fired boiler/steam generator and steam turbine with a 465 MW nominal capacity rating. Each unit is equipped with an electrostatic precipitator (ESP) for control of particulate matter (PM/PM10), and a wet flue gas desulfurization (WFGD) system for sulfur dioxide control. Unit 2 is also equipped with a selective catalytic reduction (SCR) system and low NOx burners for further control of NOx emissions.

The dibasic acid (DBA) addition system will be used to improve the SO2 removal efficiency of the existing WFGD systems on units 1 and 2 and consists of a 12,000 gallon DBA storage tank, 3 metering pumps, associated piping and valve systems, and instrumentation and controls. The DBA is handled as a solution therefore no sources of air emissions are associated with the actual additive system. Emissions of SO2 are expected to decrease as a direct result of the improved efficiency of the WFGD system. Because additional removal of SO2 will require greater limestone use, a minimal increase in particulate emissions from the limestone handling may occur. No other pollutants should be affected by the addition of the DBA addition system.

The neural network based combustion optimization system is a computer software addition to the plant's distributed control system (DCS) that utilizes the relationship between existing boiler control parameters and output performance measures, such as pollutant emissions and thermal efficiency, to optimize boiler operations. The neural network system is designed to enhance the overall performance of the unit and no increases in emissions of any criteria pollutants are expected due to this project.

The projects are part of a continuing program at OUC to reduce emissions of SO2 and NOx for the purpose of complying with the Clean Air Interstate Rule (CAIR).

 Legal Notices

3000. Petitions filed by the permit applicant or any of the parties listed below must be filed within 14 days of receipt of this notice of intent. Petitions filed by any persons other than those entitled to written notice under section 120.60(3) of the Florida Statutes must be filed within 14 days of publication of the public notice or within fourteen days of receipt of this notice of intent, whichever occurs first. Under section 120.60(3), however, any person who asked the Department for notice of agency action may file a petition within 14 days of receipt of that notice, regardless of the date of publication. A petitioner shall mail a copy of the petition to the applicant at the address indicated above at the time of filing. The failure of any person to file a petition within the appropriate time period shall constitute a waiver of that person's right to request an administrative determination (hearing) under sections 120.569 and 120.57 F.S., or to intervene in this proceeding and participate as a party to it. Any subsequent intervention will be only at the approval of the presiding officer upon the filing of a motion in compliance with Rule 28-106.205 of the Florida Administrative Code.

A petition that disputes the material facts on which the Department's action is based must contain the following information: (a) The name and address of each agency affected and each agency's file or identification number, if known; (b) The name, address, and telephone number of the petitioner, the name, address, and telephone number of the petitioner's representative, if any, which shall be the address for service purposes during the course of the proceeding; and an explanation of how the petitioner's substantial interests will be affected by the agency determination; (c) A statement of how and when petitioner received notice of the agency action or proposed action; (d) A statement of all disputed issues of material fact. If there are none, the petition must so indicate; (e) A concise statement of the ultimate facts alleged, including the specific facts the petitioner contends warrant reversal or modification of the agency's proposed action; (f) A statement of the specific rules or statutes the petitioner contends require reversal or modification of the agency's proposed action; and (g) A statement of the relief sought by the petitioner, stating precisely the action petitioner wishes the agency to take with respect to the agency's proposed action.

A petition that does not dispute the material facts upon which the Department's action is based shall state that

BUREAU OF AIR REGULATION  
DEC 18 2006  
RECEIVED

The Department has reasonable assurance that the project will not result in significant net emission increases from the unit that would otherwise require a review under the Rules for the Prevention of Significant Deterioration (PSD) at Paragraph 62-212.400, F.A.C. or 40 CFR 52.21.

The Department will issue the Final Permit, in accordance with the conditions of the Draft Permit, unless a response received in accordance with the following procedures results in a different decision or significant change of terms or conditions. The Department will accept written comments concerning the proposed permit issuance action for a period of 14 days from the date of publication of this Public Notice of Intent to issue Air Construction Permit. Written comments should be provided to the Department's Bureau of Air Regulation at 2600 Blair Stone Road, Mail Station #5505, Tallahassee, Florida 32399-2400. Any written comments filed shall be made available for public inspection. If comments received result in a significant change in the proposed agency action, the Department shall revise the proposed permit and require, if applicable, another Public Notice.

The Department will issue the permit with the attached conditions unless a timely petition for an administrative hearing is filed pursuant to sections 120.569 and 120.57 F.S. before the deadline for filing a petition. The procedures for petitioning for a hearing are set forth below. Mediation is not available in this proceeding.

A person whose substantial interests are affected by the proposed permitting decision may petition for an administrative proceeding (hearing) under sections 120.569 and 120.57 of the Florida Statutes. The petition must contain the information set forth below and must be filed (received) in the Office of General Counsel of the Department at 3900 Commonwealth Boulevard, Mail Station #35, Tallahassee, Florida 32399

and otherwise shall contain the same information as set forth above, as required by Rule 28-106.301.

Because the administrative hearing process is designed to formulate final agency action, the filing of a petition means that the Department's final action may be different from the position taken by it in this notice. Persons whose substantial interests will be affected by any such final decision of the Department on the application have the right to petition to become a party to the proceeding, in accordance with the requirements set forth above.

A complete project file is available for public inspection during normal business hours, 8:00 a.m. to 5:00 p.m., Monday through Friday, except legal holidays, at:

Department of Environmental Protection  
Bureau of Air Regulation  
111 S. Magnolia Drive  
Suite 4  
Tallahassee, Florida 32301  
Telephone: 850/488-0114  
Fax: 850/921-9533

Department of Environmental Protection  
Central District Office  
3319 Maguire Boulevard  
Suite 232  
Orlando, Florida 32803-3767  
Telephone: 407/894-7535  
Fax: 407/897-5963

The complete project file includes the technical evaluation and the Draft Permit, and the information submitted by the responsible official, exclusive of confidential records under Section 403.111, F.S. Interested persons may contact the Program Administrator, South Permitting Section at 111 South Magnolia Drive, Suite 4, Tallahassee, Florida 32301, or call 850/488-0114, for additional information. The draft permit and technical evaluation can be accessed at <http://www.dep.state.fl.us/air/permitting/construction/ouc-station-unit.htm>  
COR139024 12/9/06

## ORLANDO UTILITIES COMMISSION

To: Mr. Linero

Date: Dec. 14, 2006

Attached document being sent to you  
by Louis Brown - Environmental Affairs.

Happy Holidays!!

Thanks,



The Reliable One®

**Rosario Caraccioli**

Administrative Assistant  
Environmental Affairs



**Adams, Patty**

---

**From:** Harvey, Mary  
**Sent:** Wednesday, January 10, 2007 4:42 PM  
**To:** 'fhaddad@ouc.com'; 'dstalls@ouc.com'; Kozlov, Leonard; 'lori.cunniff@ocfl.net'; 'little.james@epa.gov'; 'newlandt@bv.com'; Halpin, Mike  
**Cc:** Mulkey, Cindy; Adams, Patty; Gibson, Victoria  
**Subject:** Orlando Utilities Commission - Stanton Energy Center - Facility Permit #0950137-001-AC-FINAL  
**Attachments:** 0950137.011.AC.F\_pdf.zip

Dear Sir/Madam:

Please send a "reply" message verifying receipt of the attached document(s); this may be done by selecting "Reply" on the menu bar of your e-mail software and then selecting "Send". We must receive verification of receipt and your reply will preclude subsequent e-mail transmissions to verify receipt of the document(s).

The document(s) may require immediate action within a specified time frame. Please open and review the document(s) as soon as possible.

The document is in Adobe Portable Document Format (pdf). Adobe Acrobat Reader can be downloaded for free at the following internet site: <http://www.adobe.com/products/acrobat/readstep.html>.

The Bureau of Air Regulation is issuing electronic documents for permits, notices and other correspondence in lieu of hard copies through the United States Postal System, to provide greater service to the applicant and the engineering community. Please advise this office of any changes to your e-mail address or that of the Engineer-of-Record.

Thank you,

DEP, Bureau of Air Regulation

## Adams, Patty

---

**From:** Harvey, Mary  
**Sent:** Wednesday, January 10, 2007 4:45 PM  
**To:** Adams, Patty; Mulkey, Cindy  
**Subject:** FW: Orlando Utilities Commission - Stanton Energy Center - Facility Permit #0950137-001-AC-FINAL

---

**From:** Halpin, Mike  
**Sent:** Wednesday, January 10, 2007 4:44 PM  
**To:** Harvey, Mary  
**Subject:** Read: Orlando Utilities Commission - Stanton Energy Center - Facility Permit #0950137-001-AC-FINAL

Your message

**To:** 'fhaddad@ouc.com'; 'dstalls@ouc.com'; Kozlov, Leonard; 'lori.cunniff@ocfl.net'; 'little.james@epa.gov'; 'newlandlt@bv.com'; Halpin, Mike  
**Cc:** Mulkey, Cindy; Adams, Patty; Gibson, Victoria  
**Subject:** Orlando Utilities Commission - Stanton Energy Center - Facility Permit #0950137-001-AC-FINAL  
**Sent:** 1/10/2007 4:42 PM

was read on 1/10/2007 4:44 PM.

**Adams, Patty**

---

**From:** Harvey, Mary  
**Sent:** Thursday, January 11, 2007 9:53 AM  
**To:** Adams, Patty  
**Subject:** FW: Orlando Utilities Commission - Stanton Energy Center - Facility Permit #0950137-001-AC-FINAL

---

**From:** Newland, Larry T. (Todd) [<mailto:NewlandLT@bv.com>]  
**Sent:** Thursday, January 11, 2007 2:19 AM  
**Subject:** Read: Orlando Utilities Commission - Stanton Energy Center - Facility Permit #0950137-001-AC-FINAL

Your message

To: [NewlandLT@bv.com](mailto:NewlandLT@bv.com)  
Subject:

was read on 1/11/2007 2:19 AM.

**Adams, Patty**

---

**From:** Harvey, Mary  
**Sent:** Thursday, January 11, 2007 10:28 AM  
**To:** 'little.james@epa.gov'  
**Cc:** Mulkey, Cindy; Adams, Patty  
**Subject:** FW: Orlando Utilities Commission - Stanton Energy Center - Facility Permit #0950137-001-AC-FINAL  
**Attachments:** Signed Documents for Facility #0950137-011-AC-FINAL.pdf; 011FinalDeter - Permit #0950137-011-AC-FINAL.PDF; 011FPermit - Permit #0950137-001-AC-FINAL.PDF

Jim, I hope you are able to get these files this time.

Thanks,  
Mary

---

**From:** Harvey, Mary  
**Sent:** Wednesday, January 10, 2007 4:42 PM  
**To:** 'fhaddad@ouc.com'; 'dstalls@ouc.com'; Kozlov, Leonard; 'lori.cunniff@ocfl.net'; 'little.james@epa.gov'; 'newlandlt@bv.com'; Halpin, Mike  
**Cc:** Mulkey, Cindy; Adams, Patty; Gibson, Victoria  
**Subject:** Orlando Utilities Commission - Stanton Energy Center - Facility Permit #0950137-001-AC-FINAL

Dear Sir/Madam:

Please send a "reply" message verifying receipt of the attached document(s); this may be done by selecting "Reply" on the menu bar of your e-mail software and then selecting "Send". We must receive verification of receipt and your reply will preclude subsequent e-mail transmissions to verify receipt of the document(s).

The document(s) may require immediate action within a specified time frame. Please open and review the document(s) as soon as possible.

The document is in Adobe Portable Document Format (pdf). Adobe Acrobat Reader can be downloaded for free at the following internet site: <http://www.adobe.com/products/acrobat/readstep.html>.

The Bureau of Air Regulation is issuing electronic documents for permits, notices and other correspondence in lieu of hard copies through the United States Postal System, to provide greater service to the applicant and the engineering community. Please advise this office of any changes to your e-mail address or that of the Engineer-of-Record.

Thank you,

DEP, Bureau of Air Regulation

**Adams, Patty**

---

**From:** Harvey, Mary  
**Sent:** Thursday, January 11, 2007 11:29 AM  
**To:** Adams, Patty; Mulkey, Cindy  
**Subject:** FW: FW: Orlando Utilities Commission - Stanton Energy Center - Facility Permit # 0950137-001-AC-FINAL

-----Original Message-----

From: Little.James@epamail.epa.gov [mailto:Little.James@epamail.epa.gov]  
Sent: Thursday, January 11, 2007 11:04 AM  
To: Harvey, Mary  
Subject: Re: FW: Orlando Utilities Commission - Stanton Energy Center - Facility Permit # 0950137-001-AC-FINAL

Got 'em. Thanks.

Jim

"Harvey, Mary"  
<Mary.Harvey@dep  
.state.fl.us>

01/11/2007 10:27  
AM

James Little/R4/USEPA/US@EPA

To

cc

"Mulkey, Cindy"  
<Cindy.Mulkey@dep.state.fl.us>,  
"Adams, Patty"  
<Patty.Adams@dep.state.fl.us>

Subject

FW: Orlando Utilities Commission  
- Stanton Energy Center -  
Facility Permit  
#0950137-001-AC-FINAL

Jim, I hope you are able to get these files this time.

Thanks,  
Mary

From: Harvey, Mary  
Sent: Wednesday, January 10, 2007 4:42 PM  
To: 'fhaddad@ouc.com'; 'dstalls@ouc.com'; Kozlov, Leonard; 'lori.cunniff@ocfl.net'; 'little.james@epa.gov'; 'newlandlt@bv.com'; Halpin, Mike  
Cc: Mulkey, Cindy; Adams, Patty; Gibson, Victoria  
Subject: Orlando Utilities Commission - Stanton Energy Center - Facility Permit # 0950137-001-AC-FINAL

Florida Department of  
Environmental Protection

Memorandum

TO: Joseph Kahn, Director, DARM  
Through: Trina L. Vielhauer, Chief, BAR   
From: A.A. Linero, P.E., PA/Cindy Mulkey South Permitting Section  
DATE: January 8, 2007  
SUBJECT: Orlando Utilities Commission – Stanton Energy Center  
Dibasic Acid additive system and neural network Units 1 & 2  
DEP File No. 0950137-011-AC

Attached is the final permit package for the installation of a dibasic acid (DBA) additive system for Units 1 and 2 WFGD systems, and a neural network-based combustion optimization system on Units 1 and 2.

The recent Unit B IGCC project includes a requirement for NO<sub>x</sub> reductions on Units 1 and 2. The installation of the combustion optimization system is the first measure identified by OUC towards meeting the requirements pursuant to the IGCC Unit B construction permit and is consistent with efforts pursuant to CAIR.

The only potential increase in emissions from either of these projects is a slight increase in fugitive particulate emissions associated with increased limestone handling as a result of greater SO<sub>2</sub> removal. Such an increase would not be significant.

We determined that the DBA additive system and the neural network combustion optimization system will not result in any significant increases in any criteria pollutants.

Comments were received from Orange County during the 30-day comment period and have been addressed in the attached Final Determination to Issue a Construction Permit.

We recommend your approval of the attached Final Notice and Permit.

AAL/cm

Attachments

FINAL DETERMINATION  
ORLANDO UTILITIES COMMISSION  
CURTIS H. STANTON ENERGY CENTER  
DEP FILE NO. 0950137-011-AC

On November 22, 2006 the Florida Department of Environmental Protection (Department) distributed an "Intent to Issue Air Construction Permit" for the installation of a dibasic acid additive system for the Unit 1 and 2 desulfurization systems, and installation of a neural network-based combustion optimization system on Units 1 and 2 at the existing Curtis H. Stanton Energy Center east of Orlando in Orange County.

The package included the Department's Draft Air Construction Permit, the Intent to Issue Air Construction Permit, the Technical Evaluation and Preliminary Determination, and the Public Notice of Intent to Issue Air Construction Permit. The Department sent copies of the package to various persons and agencies. Orlando Utilities Commission (OUC) published the Public Notice in *The Orlando Sentinel* on December 9, 2006 and provided to the Department the required proof of publication.

The Department has reasonable assurance that the project will not result in significant net emission increases from the units that would otherwise require a review under the Rules for the Prevention of Significant Deterioration (PSD) at Paragraph 62-212.400, F.A.C. or 40 CFR 52.21.

No requests for administrative hearings were received on the Notice of Intent to Issue.

Written comments were received during the 30-day public comment period from the Orange County Environmental Protection Division (EPD) on December 15, 2006. No comments were received from other agencies or the public regarding the Draft Air Construction Permit. EPD's comments are listed below followed by the Department's responses.

***EPD Comments***

- "This project adds NO<sub>x</sub> control equipment to existing coal-fired boilers, which Orlando utilities Commission (OUC) committed to do when applying for a permit for Unit B. This equipment is required for OUC to net out of PSD permitting requirements for NO<sub>x</sub> for Unit B. The NO<sub>x</sub> control equipment will also be required for OUC to meet the low NO<sub>x</sub> emissions limits of the Clean Air Interstate Rule (CAIR), which becomes effective before Unit B is built. The neural network-based combustion optimization system NO<sub>x</sub> control equipment proposed for this project was not one of the options listed for consideration in the OUC letter of May 10, 2006 requesting to net out of PSD. That letter implied that Unit 1 would likely be upgraded with NO<sub>x</sub> controls similar to Unit 2, though no final decisions had been made."
- "This permit and technical evaluation are written as if Units 1 and 2 were identical. As you know, Units 1 and 2 differ significantly in NO<sub>x</sub> control systems and NO<sub>x</sub> and sulfur dioxide (SO<sub>2</sub>) emission rates for the two units differ by a factor of more than 2. EPD believes that Unit 1 should be upgraded to the same configuration as Unit 2 as quickly as possible, to improve the county's air quality and meet CAIR's 2009 effective date for NO<sub>x</sub>. This would likely require an expensive SCR system, other modifications such as a low-NO<sub>x</sub> burner with an improved control system, and upgrades to the existing flue gas desulfurization system. However, these changes would result in significant reductions in NO<sub>x</sub> and SO<sub>2</sub> emissions rates likely to meet CAIR requirements. The changes proposed appear likely to yield relatively small improvements in Unit 1 emissions, not the significant improvements needed by 2009."

***Department Response***

The Unit B project to which EPD refers is the recently permitted integrated gasification combined cycle unit (Stanton Unit B). The Unit B IGCC project does include a NO<sub>x</sub> emissions cap on the existing coal fired boilers (Units 1 and 2) that ensures a net emissions increase for the Unit B project of less than the significant emission rate, thereby allowing the IGCC project to "net out" of PSD requirements for NO<sub>x</sub>.

The installation of the combustion optimization system is the first specific measure identified by OUC towards meeting the requirements pursuant to the IGCC Unit B permit (incorporated into this permitting action). The neural network system will help to determine initial low cost, low NO<sub>x</sub> operational strategies while the dibasic acid project will accomplish some further low cost SO<sub>2</sub> reductions beyond the existing WFGD systems.

In order to meet the new emissions cap on Units 1 and 2, OUC will be applying additional NO<sub>x</sub> control strategies on these units. As stated in the Department's Technical Evaluation for this project, the other specific control strategies are not yet detailed for the required NO<sub>x</sub> emissions reductions, but are understood to include a series of measures to be undertaken over a period of time prior to the startup of Unit B.

The OUC letter of May 10, 2006 referred to by EPD included the basis for OUC's netting analysis and requested specific permit limits for Units 1 and 2. Also included, were brief descriptions of the types of NO<sub>x</sub> reduction technologies being considered by OUC for Stanton Units 1 and 2. The OUC letter can be viewed at the following website: <http://www.dep.state.fl.us/Air/permitting/construction/oucsouthern.htm>.

The inclusion of the requirements to meet the lower NO<sub>x</sub> emissions limits on Units 1 and 2 (NO<sub>x</sub> emissions cap) in this permit, as recommended by EPA, was not meant to imply that this project is the single requirement necessary to meet the lower NO<sub>x</sub> limits. OUC has a number of options available to them and the Department expects to see additional applications for related projects in the near future.

EPD refers to the "significant" difference in existing NO<sub>x</sub> control equipment on Units 1 and 2. Unit 2 is equipped with low NO<sub>x</sub> burners and a selective catalytic reduction (SCR) system, while Unit 1 is currently equipped with neither of these control options. The draft permit indicated the presence of low NO<sub>x</sub> burners on both units. The unit description of the final permit has been changed accordingly.

No other changes to the permit are necessary as a result of these comments. The final decision by the Department is to issue the permit as drafted.





# Florida Department of Environmental Protection

Bob Martinez Center  
2600 Blairstone Road  
Tallahassee, Florida 32399-2400

Charlie Crist  
Governor

Jeff Kottkamp  
Lt. Governor

Michael W. Sole  
Secretary - Designee

## PERMITTEE:

Orlando Utilities Commission  
500 South Orange Avenue  
Orlando, Florida 32802

### *Authorized Representative:*

Frederick Haddad, Jr.  
V.P., Power Resources Business Unit

DEP File No. 0950137-011-AC  
Curtis H. Stanton Energy Center  
Dibasic Acid Additive System  
Neural Network Systems  
Stanton Units 1 and 2  
Orange County, Florida

## PROJECT AND LOCATION

This permit authorizes the addition of a dibasic acid additive delivery system to the existing wet flue gas desulfurization systems, and a neural network-based combustion optimization system to Units 1 and 2 at the Curtis H. Stanton Energy Center. The facility is located at 5100 Alafaya Trail, Orlando, Orange County.

## STATEMENT OF BASIS

This permit is issued under the provisions of Chapter 403 of the Florida Statutes (F.S.), and Chapters 62-4, 62-204, 62-210, 62-212, 62-296, and 62-297 of the Florida Administrative Code (F.A.C.). The permittee is authorized to perform the proposed work in accordance with the conditions of this permit and as described in the application, approved drawings, plans, and other documents on file with the Department of Environmental Protection (Department). This permit supplements all other air construction and operation permits for the affected emissions units and does not alter any requirements from such previously issued air permits.

The attached Appendices are made a part of this permit:

Appendix GC Construction Permit General Conditions

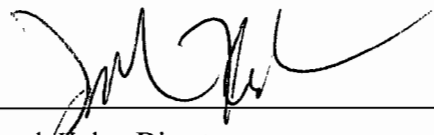
  
\_\_\_\_\_  
Joseph Kahn, Director  
Division of Air Resource Management

STATE OF FLORIDA  
DEPARTMENT OF ENVIRONMENTAL PROTECTION  
**NOTICE OF PERMIT**

In the Matter of an  
Application for Permit by:

Frederick F. Haddad, Jr., V.P. Power Resources  
Orlando Utilities Commission  
500 South Orange Avenue  
Post Office Box 3193  
Orlando, Florida 32802

Curtis H. Stanton Energy Center  
DEP File No. 0950137-011-AC  
Units 1 and 2 Dibasic Acid Additive and  
Neural Network Systems Installation  
Orange County

---

Enclosed is the Final Permit (No. 0950137-011-AC) for the installation of a dibasic acid additive system for the wet flue gas desulfurization systems on Units 1 and 2, and for the installation of a neural network-based combustion optimization system on Units 1 and 2 at the Curtis H. Stanton Energy Center. The facility is located southeast of Orlando, in Orange County. This permit is issued pursuant to Chapter 403, Florida Statutes.

Any party to this order (permit) has the right to seek judicial review of the permit pursuant to Section 120.68, F.S., by the filing of a Notice of Appeal pursuant to Rule 9.110, Florida Rules of Appellate Procedure, with the Clerk of the Department in the Legal Office; and by filing a copy of the Notice of Appeal accompanied by the applicable filing fees with the appropriate District Court of Appeal. The Notice of Appeal must be filed within 30 days from the date this Notice is filed with the Clerk of the Department.

Executed in Tallahassee, Florida.



Trina L. Vielhauer, Chief  
Bureau of Air Regulation

**CERTIFICATE OF SERVICE**

The undersigned duly designated deputy agency clerk hereby certifies that this Notice of Final Permit (including the Final Permit) and all copies were sent electronically (with Received Receipt) before the close of business on 1/10/07 to the person(s) listed:

Frederick F. Haddad, Jr., OUC: [fhaddad@ouc.com](mailto:fhaddad@ouc.com)

Denise Stalls, OUC: [dstalls@ouc.com](mailto:dstalls@ouc.com)

Len Kozlov, DEP CD: [leonard.kozlov@dep.state.fl.us](mailto:leonard.kozlov@dep.state.fl.us)

Lori Cunniff, Orange County EPD: [lori.cunniff@ocfl.net](mailto:lori.cunniff@ocfl.net)

Jim Little, EPA Region 4: [little.james@epamail.epa.gov](mailto:little.james@epamail.epa.gov)

Larry Todd, Newland, Black & Veatch: [newlandlt@bv.com](mailto:newlandlt@bv.com)

Mike Halpin, DEP Siting: [mike.halpin@dep.state.fl.us](mailto:mike.halpin@dep.state.fl.us)

**Clerk Stamp**

**FILING AND ACKNOWLEDGMENT FILED**, on this date, pursuant to §120.52, Florida Statutes, with the designated Department Clerk, receipt of which is hereby acknowledged.

  
(Clerk)

1/10/07  
(Date)

## SECTION I. GENERAL INFORMATION

### FACILITY DESCRIPTION

The existing facility consists of two 468 MW fossil fuel fired steam electric generating stations (Units 1 and 2), and one 640 MW combined cycle unit. There are storage and handling facilities for solid fuels, fly ash, limestone, gypsum, slag, and bottom ash. A draft PSD permit was recently issued for the construction of a nominal 285 MW integrated gasification combined cycle unit (Unit B) planned to be operational by 2012.

### PROJECT DESCRIPTION

The projects under this permit include installation of a dibasic acid (DBA) additive system on the existing wet scrubber flue gas desulfurization (WFGD) systems for Units 1 and 2, and a neural network-based combustion optimization system on Units 1 and 2.

The DBA system includes: three metering pumps; one DBA storage tank; associated piping, valves, and components; and instrumentation and controls. This project will accomplish further SO<sub>2</sub> reductions beyond the existing systems that may suffice for reductions pursuant to the Clean Air Interstate Rule.

Installation of the neural network-based combustion optimization system is the first measure identified by OUC towards meeting the requirements pursuant to the IGCC Unit B permit (PSD-FL-373) and is consistent with efforts pursuant to CAIR. The system will run on its own dedicated server pc, and will communicate directly with the plant distributed control system.

### EMISSIONS UNITS

This permit addresses the following emissions units:

| <b>EU ID</b> | <b>Emissions Unit Description</b>                |
|--------------|--|
| 001          | Fossil Fuel Fired Steam Electric Generator No. 1 |
| 002          | Fossil Fuel Fired Steam Electric Generator No. 2 |

### REGULATORY CLASSIFICATION

*Title I, Part C, Clean Air Act (CAA):* The facility is a PSD-major facility pursuant to Rule 62-212, F.A.C.

*Title I, Section 111, CAA:* Units 1 and 2 are subject to the New Source Performance Standards of 40 CFR 60, Subpart Da (Standards of Performance for Electric Utility Steam Generating Units for Which Construction is Commenced After September 18, 1978).

*Title I, Section 112, CAA:* The facility is a "Major Source" of hazardous air pollutants (HAPs).

*Title IV, CAA:* The facility operates units subject to the Acid Rain provisions of the Clean Air Act.

*Title V, CAA:* The facility is a Title V or "Major Source of air pollution" in accordance with Chapter 62-213, F.A.C.

*CAIR:* As an electric generating unit, Units 1 and 2 may be subject to the Clean Air Interstate Rule pending finalization of DEP rules.

*Siting:* The facility was originally certified pursuant to the power plant siting provisions of Chapter 62-17, F.A.C.

## SECTION I. GENERAL INFORMATION

---

### PERMITTING AUTHORITY

All documents related to applications for permits to construct, operate or modify an emissions unit shall be submitted to the Bureau of Air Regulation of the Florida Department of Environmental Protection (DEP) at 2600 Blair Stone Road (MS #5505), Tallahassee, Florida 32399-2400. Copies of all such documents shall also be submitted to the Compliance Authority.

### COMPLIANCE AUTHORITY

All documents related to compliance activities such as reports, tests, and notifications shall be submitted to the Department of Environmental Protection Central District Office at 3319 Maguire Boulevard, Suite 232, Orlando Florida 32803-3767.

### RELEVANT DOCUMENTS

The documents listed below are not a part of this permit; however, this information is specifically related to the permitting action and is on file with the Department.

- Application for installation of DBA and neural network systems received September 7, 2006.
- Department's Technical Evaluation and Preliminary Determination issued November 22, 2006.
- Department's Final Determination issued concurrently with this Final Permit.

## SECTION II. ADMINISTRATIVE REQUIREMENTS

---

1. General Conditions: The permittee shall operate under the attached General Conditions listed in Appendix GC of this permit. General Conditions are binding and enforceable pursuant to Chapter 403 of the Florida Statutes. [Rule 62-4.160, F.A.C.]
2. Applicable Regulations, Forms and Application Procedures: Unless otherwise indicated in this permit, the construction and operation of the subject emissions unit shall be in accordance with the capacities and specifications stated in the application. The facility is subject to all applicable provisions of: Chapter 403 of the Florida Statutes (F.S.); Chapters 62-4, 62-204, 62-210, 62-212, 62-213, 62-296, and 62-297 of the Florida Administrative Code (F.A.C.); and the Title 40, Parts 51, 52, 60, and 63 of the Code of Federal Regulations (CFR), adopted by reference in Rule 62-204.800, F.A.C. The permittee shall use the applicable forms listed in Rule 62-210.900, F.A.C. and follow the application procedures in Chapter 62-4, F.A.C. Issuance of this permit does not relieve the permittee from compliance with any applicable federal, state, or local permitting or regulations. [Rules 62-204.800, 62-210.300 and 62-210.900, F.A.C.]
3. Construction and Expiration: Authorization to construct shall expire if construction is not commenced within 18 months after receipt of the permit, if construction is discontinued for a period of 18 months or more, or if construction is not completed within a reasonable time. The Department may extend the 18-month period upon a satisfactory showing that an extension is justified. [Rules 62-4.070(4), 62-4.080, 62-210.300(1), F.A.C.]
4. New or Additional Conditions: For good cause shown and after notice and an administrative hearing, if requested, the Department may require the permittee to conform to new or additional conditions. The Department shall allow the permittee a reasonable time to conform to the new or additional conditions, and on application of the permittee, the Department may grant additional time. [Rule 62-4.080, F.A.C.]
5. Source Obligation.
  - a. At such time that a particular source or modification becomes a major stationary source or major modification (as these terms were defined at the time the source obtained the enforceable limitation) solely by virtue of a relaxation in any enforceable limitation which was established after August 7, 1980, on the capacity of the source or modification otherwise to emit a pollutant, such as a restriction on hours of operation, then the requirements of subsections 62-212.400(4) through (12), F.A.C., shall apply to the source or modification as though construction had not yet commenced on the source or modification.
  - b. At such time that a particular source or modification becomes a major stationary source or major modification (as these terms were defined at the time the source obtained the enforceable limitation) solely by exceeding its projected actual emissions, then the requirements of subsections 62-212.400(4) through (12), F.A.C., shall apply to the source or modification as though construction had not yet commenced on the source or modification.[Rule 62-212.400(12), F.A.C.]
6. Modifications: No emissions unit or facility subject to this permit shall be constructed or modified without obtaining an air construction permit from the Department. Such permit shall be obtained prior to beginning construction or modification. [Chapters 62-210 and 62-212, F.A.C.]
7. Title V Permit: This permit authorizes construction or modification of the permitted emissions units and initial operation to determine compliance with Department rules. A Title V operation permit is required for regular operation of the permitted emissions units. The permittee shall apply for a Title V operation permit at least 90 days prior to expiration of this permit, but no later than 180 days after commencing operation. To apply for a Title V operation permit, the applicant shall submit the appropriate application form, compliance test results, and such additional information as the Department may by law require. The application shall be submitted to the Compliance Authority. [Rules 62-4.030, 62-4.050, 62-4.220 and Chapter 62-213, F.A.C.]

## SECTION III - EMISSIONS UNITS SPECIFIC CONDITIONS

### Units 1 and 2 Fossil Fuel Fired Steam Generators (EU 001 and 002)

This section of the permit addresses the following existing emissions units.

#### Emissions Unit 001 and 002

Fossil Fuel Fired Steam Generators 1 and 2 are wall-fired, dry bottom boilers, firing pulverized coal as the primary fuel and No. 6 fuel oil for purposes of startup and flame stabilization. Each unit has a maximum heat input rate of 4,286 mmBtu per hour with a nominal generating capacity of 468 MW. Each unit is equipped with an electrostatic precipitator (ESP) for control of particulate matter (PM/PM<sub>10</sub>), and a WFGD system for sulfur dioxide (SO<sub>2</sub>) control. Unit 2 is also equipped with low NO<sub>x</sub> burners and a selective catalytic reduction (SCR) system for control of nitrogen oxide (NO<sub>x</sub>) emissions. The following parameters are continuously monitored on both units: NO<sub>x</sub>, opacity, SO<sub>2</sub>, CO<sub>2</sub>, and stack gas flow rate.

#### ADMINISTRATIVE REQUIREMENTS

1. Relation to Other Permits: The conditions of this permit are in addition to those of any other air construction or operation permits for these units. [Rule 62-4.030, 62-4.210, and 62-210.300(1)(b), F.A.C.]

#### EQUIPMENT AND CONTROL TECHNOLOGY

2. Dibasic Acid Additive System: The permittee is authorized to install and maintain a dibasic acid (DBA) additive system associated with the existing WFGD systems on Units 1 and 2 for the purpose of improving SO<sub>2</sub> removal efficiencies and enhancing overall scrubber performance. The additive system consists of the following components:

- Three skid-mounted DBA metering pumps with associated valves and equipment;
- DBA storage tank;
- DBA addition piping and valves from storage tank to pump skid and from pump skid to the existing scrubber additive storage tanks; and
- Instrumentation and controls.

[Applicant Request, and Rule 62-210.300 (Permits Required), F.A.C.]

3. Neural Network Combustion Optimization System: The permittee is authorized to install and maintain a neural network-based combustion optimization system to interface with the existing plant distributed control system for the purpose of optimizing boiler operations.

[Applicant Request, and Rule 62-210.300 (Permits Required), F.A.C.]

#### EMISSIONS REQUIREMENTS

4. NO<sub>x</sub> Emissions Cap: Units 1 and 2 will meet the following NO<sub>x</sub> emissions limits.
  - a. Existing Units 1 and 2: The combined NO<sub>x</sub> emissions from existing coal fired boiler steam electric generating Stanton Unit 1 and Stanton Unit 2 shall not exceed 8,300 tons per year on a 12-month rolling total. Total NO<sub>x</sub> emissions shall be based on data collected from the Unit 1 and Unit 2 NO<sub>x</sub> CEMS. Compliance shall be determined after each calendar month by calculating the total emissions from that calendar month and the last 11 calendar months beginning the first month of first fire of IGCC Unit B and thereafter.
  - b. If the combined NO<sub>x</sub> emissions from Units 1 and 2 exceed 8,300 tons during any 12-month period, and/or the total NO<sub>x</sub> emissions from Unit B exceeds 1,006 tons during any 12-month period, Unit B shall be subject to PSD preconstruction review at that time, and a determination of BACT for NO<sub>x</sub> shall be made.

---

### SECTION III - EMISSIONS UNITS SPECIFIC CONDITIONS

#### Units 1 and 2 Fossil Fuel Fired Steam Generators (EU 001 and 002)

- c. For purposes of meeting the NO<sub>x</sub> emissions caps, annual emission of NO<sub>x</sub> from existing Units 1 and 2, and Unit B shall be calculated with no allowable data exclusions. All valid hours of data (including startup and shutdown) must be included in the rolling 12-month totals. Also, the data substitution procedures of Part 75 for missing data shall not be used in these calculations.

[62-210.200 (net emissions increase), 62-210.370 (emissions computation), and 62-212.400(12) (Source Obligation), F.A.C.]

*{Permitting Note: IGCC Unit B did not trigger PSD for NO<sub>x</sub> due to a NO<sub>x</sub> emissions cap taken on existing coal fired boiler steam electric generating Unit 1 and Unit 2. The above conditions establish the requirements for meeting the NO<sub>x</sub> emissions limitations for purposes of avoiding PSD preconstruction review by Unit B. These requirements in no way supersede any federal requirement of the applicable NSPS or NESHAP provisions.}*

#### REPORTING AND NOTIFICATION REQUIREMENTS

5. Notification: Within one week of beginning construction of the DBA additive system, the permittee shall notify the Compliance Authority that the project has commenced and provide a general schedule of construction activities. Within one week following the end of construction, the permittee shall notify the Compliance Authority that the project was completed. Within one week of completing installation of the neural network-based combustion optimization system, the permittee shall notify the Compliance Authority that the project was completed. [Rule 62-4.210, F.A.C.]
6. SIP Quarterly Report: In addition to, and included in, the SIP quarterly excess emissions report required for Unit B the permittee shall submit a report to the Compliance Authority summarizing the previous three 12-month totals of NO<sub>x</sub> emissions from Units 1 and 2. The quarterly report is due within 30 days following the end of each calendar-quarter. [Rule 62-4.070, F.A.C.]



## Appendix GC - Construction Permit General Conditions

---

The permittee shall comply with the following general conditions from Rule 62-4.160, F.A.C.

1. The terms, conditions, requirements, limitations, and restrictions set forth in this permit are "Permit Conditions" and are binding and enforceable pursuant to Sections 403.161, 403.727, or 403.859 through 403.861, Florida Statutes. The permittee is placed on notice that the Department will review this permit periodically and may initiate enforcement action for any violation of these conditions.
2. This permit is valid only for the specific processes and operations applied for and indicated in the approved drawings or exhibits. Any unauthorized deviation from the approved drawings, exhibits, specifications, or conditions of this permit may constitute grounds for revocation and enforcement action by the Department.
3. As provided in Subsections 403.087(6) and 403.722(5), Florida Statutes, the issuance of this permit does not convey and vested rights or any exclusive privileges. Neither does it authorize any injury to public or private property or any invasion of personal rights, nor any infringement of federal, state or local laws or regulations. This permit is not a waiver or approval of any other Department permit that may be required for other aspects of the total project which are not addressed in the permit.
4. This permit conveys no title to land or water, does not constitute State recognition or acknowledgment of title, and does not constitute authority for the use of submerged lands unless herein provided and the necessary title or leasehold interests have been obtained from the State. Only the Trustees of the Internal Improvement Trust Fund may express State opinion as to title.
5. This permit does not relieve the permittee from liability for harm or injury to human health or welfare, animal, or plant life, or property caused by the construction or operation of this permitted source, or from penalties therefore; nor does it allow the permittee to cause pollution in contravention of Florida Statutes and Department rules, unless specifically authorized by an order from the Department.
6. The permittee shall properly operate and maintain the facility and systems of treatment and control (and related appurtenances) that are installed or used by the permittee to achieve compliance with the conditions of this permit, as required by Department rules. This provision includes the operation of backup or auxiliary facilities or similar systems when necessary to achieve compliance with the conditions of the permit and when required by Department rules.
7. The permittee, by accepting this permit, specifically agrees to allow authorized Department personnel, upon presentation of credentials or other documents as may be required by law and at a reasonable time, access to the premises, where the permitted activity is located or conducted to:
  - a. Have access to and copy and records that must be kept under the conditions of the permit;
  - b. Inspect the facility, equipment, practices, or operations regulated or required under this permit, and,
  - c. Sample or monitor any substances or parameters at any location reasonably necessary to assure compliance with this permit or Department rules.

Reasonable time may depend on the nature of the concern being investigated.

8. If, for any reason, the permittee does not comply with or will be unable to comply with any condition or limitation specified in this permit, the permittee shall immediately provide the Department with the following information:
  - a. A description of and cause of non-compliance; and
  - b. The period of noncompliance, including dates and times; or, if not corrected, the anticipated time the non-compliance is expected to continue, and steps being taken to reduce, eliminate, and prevent recurrence of the non-compliance.

The permittee shall be responsible for any and all damages which may result and may be subject to enforcement action by the Department for penalties or for revocation of this permit.

9. In accepting this permit, the permittee understands and agrees that all records, notes, monitoring data and other information relating to the construction or operation of this permitted source which are submitted to the Department may be used by the Department as evidence in any enforcement case involving the permitted source arising under the Florida Statutes or Department rules, except where such use is prescribed by Sections 403.73 and 403.111, Florida Statutes. Such evidence shall only be used to the extent it is consistent with the Florida Rules of Civil Procedure and appropriate evidentiary rules.

## Appendix GC - Construction Permit General Conditions

---

10. The permittee agrees to comply with changes in Department rules and Florida Statutes after a reasonable time for compliance, provided, however, the permittee does not waive any other rights granted by Florida Statutes or Department rules.
11. This permit is transferable only upon Department approval in accordance with Florida Administrative Code Rules 62-4.120 and 62-730.300, F.A.C., as applicable. The permittee shall be liable for any non-compliance of the permitted activity until the transfer is approved by the Department.
12. This permit or a copy thereof shall be kept at the work site of the permitted activity.
13. This permit also constitutes:
  - a. Determination of Best Available Control Technology (Not Applicable);
  - b. Determination of Prevention of Significant Deterioration (Not Applicable);
  - c. Compliance with National Emission Standards for Hazardous Air Pollutants (Not Applicable); and
  - d. Compliance with New Source Performance Standards (Not Applicable).
14. The permittee shall comply with the following:
  - a. Upon request, the permittee shall furnish all records and plans required under Department rules. During enforcement actions, the retention period for all records will be extended automatically unless otherwise stipulated by the Department.
  - b. The permittee shall hold at the facility or other location designated by this permit records of all monitoring information (including all calibration and maintenance records and all original strip chart recordings for continuous monitoring instrumentation) required by the permit, copies of all reports required by this permit, and records of all data used to complete the application or this permit. These materials shall be retained at least three years from the date of the sample, measurement, report, or application unless otherwise specified by Department rule.
  - c. Records of monitoring information shall include:
    - 1) The date, exact place, and time of sampling or measurements;
    - 2) The person responsible for performing the sampling or measurements;
    - 3) The dates analyses were performed;
    - 4) The person responsible for performing the analyses;
    - 5) The analytical techniques or methods used; and
    - 6) The results of such analyses.

When requested by the Department, the permittee shall within a reasonable time furnish any information required by law which is needed to determine compliance with the permit. If the permittee becomes aware that relevant facts were not submitted or were incorrect in the permit application or in any report to the Department, such facts or information shall be corrected promptly

OUC

▲ PEEL HERE

PEEL HERE ▲

Please fold or cut in half  
**DO NOT PHOTOCOPY**

Using a photocopy could delay the delivery of your package and will result in additional shipping charge

**SENDER'S RECEIPT**

Waybill #: 17952490754

To (Company):  
U.S. EPA Region 4  
Air Permits Section  
61 Forsyth Street

Atlanta, GA 30303  
UNITED STATES

Attention To: Mr. Gregg M. Worley  
Phone#: 404-562-9141

Sent By: P. Adams  
Phone#: 850-921-9505

Rate Estimate: 5.07  
Protection: Not Required  
Description: PSD-FL-084 modification

Weight (lbs.): Letter  
Dimensions: 0 x 0 x 0

Ship Ref: 37550201000 A7 AP255  
Service Level: Next Day 3:00 (Next  
business day by 3 PM)

Special Svc:

Date Printed: 9/21/2006  
Bill Shipment To: Sender  
Bill To Acct: 778941286

DHL Signature (optional) \_\_\_\_\_ Route \_\_\_\_\_ Date \_\_\_\_\_ Time \_\_\_\_\_

For Tracking, please go to [www.dhl-usa.com](http://www.dhl-usa.com) or call 1-800-225-5345

Thank you for shipping with DHL

Create new shipment 

View pending shipments

Print waybill 





RECEIVED

Orlando Utilities Commission  
Stanton Amendments

SEP 05 2006 B&V Project 143799  
September 1, 2006

BUREAU OF AIR REGULATION

Mr. Al Linero, P.E.  
South Permitting Section  
Bureau of Air Regulation  
Division of Air Resource Management  
Florida Department of Environmental Protection  
2600 Blair Stone Road, MS-5500  
Tallahassee, FL 32399-2400

Subject: Request to Modify PSD Permit PSD-FL-084

Dear Mr. Linero:

Black & Veatch, on behalf of the Orlando Utilities Commission (OUC), requests per this application, the Department modify the Curtis H. Stanton Energy Center PSD Permit (PSD-FL-084) to include two improvement projects at the Stanton site. These are: (1) the addition of a dibasic acid (DBA) additive system for both Stanton Unit 1 and Unit 2 wet flue gas desulfurization (WFGD) systems and, (2) the addition of a neural network-based combustion optimization system on Units 1 and 2. The DBA additive system will improve the scrubber efficiency of the existing Units 1 and 2 WFGD scrubbers. The neural network-based combustion optimization system will optimize boiler operations through a software installation. The proposed changes do not include the addition of any new emission units and are expected to improve scrubber efficiency, and boiler operation. OUC is requesting these changes be incorporated into the facility PSD permit, which can then be incorporated into the facility Site Certification.

As the Department is aware, this is the first of a number of projects that OUC is considering that are focused on reducing air emissions at the Stanton facility. Other projects under consideration include NO<sub>x</sub> reduction options for both Stanton Unit 1 and Unit 2, and additional projects that may provide further SO<sub>2</sub> reductions for both units.

#### **DBA Addition**

Both Stanton Unit 1 and Stanton Unit 2 utilize an existing WFGD limestone based scrubber to control SO<sub>2</sub> emissions. The function of the DBA Injection System is to enhance the SO<sub>2</sub> removal efficiency by limiting the pH drop at the gas-liquid interface in the scrubber module. Dibasic acid is a mixture of dicarboxylic acids; glutaric, succinic and adipic acids. The ability of dibasic acid to increase the performance of FGD systems has been documented by numerous studies and actual application experience. As the pH at the liquid-gas interface drops, the DBA ions in the recycle slurry act as a chemical buffer to quickly combine with hydrogen ions to suppress the normal drop in pH at the liquid-gas interface across the absorber. The higher pH increases SO<sub>2</sub> absorption and improves FGD performance. The DBA System will maintain a concentration of dibasic acid in the recycle slurry by adding dibasic acid to the additive storage tanks.

#### **Technical Description**

The Dibasic Acid Addition System includes the following major components:

- Three 50-percent capacity dibasic acid metering pumps skid mounted with all associated piping, valves and components.
- Dibasic acid storage tank.
- Dibasic acid addition piping and valves from storage tank to pump skid and from pump skid to the existing scrubber additive storage tanks.
- Instrumentation and controls.

OUC  
Stanton

B&V Project 143799  
September 1, 2006

A General Arrangement drawing and preliminary Piping and Instrument Diagram of the proposed Dibasic Acid Injection Equipment are attached as part of this application.

The DBA Addition System receives commercial 50% DBA solution from trucks equipped with an unloading means and fills an approximately 12,000-gallon DBA storage tank. The DBA is then pumped at a controlled rate by the DBA metering pumps from the storage tank into the two existing scrubber additive storage tanks. No other modifications to the scrubber additive preparation system are required.

The DBA Addition System includes three 50-percent dibasic acid feed pumps. Each feed pump is capable of supplying the required volume of dibasic acid to treat one additive storage tank. The third pump will be connected as a spare for either tank. The plant has two scrubber additive storage tanks that supply scrubber additive slurry to both units. The existing additive feed piping and valves are arranged such that either tank can provide additive to either or both Units 1 & 2.

It is estimated that, at design condition, the DBA Addition System will supply approximately 18 gallons per hour (gph) to each scrubber additive storage tank (36 gph total) based on the design conditions for the flue gas desulfurization system. The optimum concentration of DBA in the FGD recycle slurry will be determined by in-service testing but is expected to be between 1000 to 3000 mg/l.

The system tank, feed pumps, piping, and valves will be constructed of stainless steel. The dibasic acid storage tank will have internal heaters and a top mounted mixer to allow proper mixing and heated storage (dibasic acid must be maintained at a temperature of at least 104°F). Flush connections are provided for flushing dibasic acid from pipes after unloading and prior to extended system lay-up.

The dibasic acid storage tank and pump skid will be installed in a concrete containment area, which will have a low-point sump with a normally-closed discharge valve. Paved access to the tank and skid area will be provided from existing site roads.

Control of the DBA feed pumps will be through the plant Distributed Control System (DCS). Since the feed rate required is largely dependent on the loss of DBA in the byproduct produced, the feed to the reagent storage tank will be in proportion to the limestone slurry production rate. The limestone slurry feed rate to the reaction tank is proportional to the byproduct produced and serves to match the DBA feed to the changing conditions of unit load and fuel sulfur content. Adjustments to the DBA injection proportion will be made by plant personnel as required based on periodic sampling of the reaction tank concentration. If required, short term adjustments of the acid concentration in the reaction tank due to process upsets or recycle pump failure can be facilitated through manual feed of DBA directly into the FGD reaction tanks.

#### **Environmental Consequences of Installation and Operation**

OUC anticipates no adverse environmental impacts resulting from the approval and implementation of this system.

The anticipated benefits of using dibasic acid in the flue gas desulfurization system include the following.

- Improved scrubber SO<sub>2</sub> removal efficiency.
- Increased flexibility in fuel selection.
- Improved ability to handle swings in inlet SO<sub>2</sub>.

Liquid dibasic acid will be delivered using commercial trucks to a tank located within a reinforced concrete containment sized for the full tank volume plus an allowance for direct rainfall on the containment. The containment will be furnished with a sump with a normally closed valve. Periodically, operators will drain rainfall water from the containment into the process area wastewater collection system, which routes

OUC  
Stanton

B&V Project 143799  
September 1, 2006

process area drainage into the Recycle Basin. If there is leakage, the containment and sump contents will be scavenged using a temporary sump pump to a truck or temporary tank. The collected dibasic acid will be reused or disposed offsite to a FDEP-approved disposal facility.

Bulk dibasic acid is considered a corrosive liquid and is non-flammable, having a flash point of 450 F. It is a skin and eye irritant. None of the components present in DBA are listed as a potential carcinogen.

A small concentration of dibasic acid will be contained in the residual moisture in the conditioned dewatered flue gas desulfurization by-product that is placed in the on-site combustion waste storage area. This small amount of residual DBA will not impact the properties of the by-product.

Note that the DBA will be handled as a solution and none of the equipment listed above are sources of air emissions. In fact, the only expected impact on air emissions from the operation of this system is a reduction in SO<sub>2</sub> emissions due to the improved efficiency of the scrubber.

The DBA addition systems may result in an increase in limestone usage and scrubber byproduct production due to increased SO<sub>2</sub> removal. While the use of DBA may result in slightly improved calcium utilization, if it is conservatively assumed that there is no improvement in calcium utilization, the percent increase in SO<sub>2</sub> removal associated with DBA use will result in an equivalent percent increase in limestone use and scrubber byproduct production. Emissions associated with limestone use are reported in the Annual operating report (AOR) for the facility using an emission factor of 0.00031 lb/ton of material processed. As such, the increase in PM/PM<sub>10</sub> emissions associated with increased limestone handling would be negligible.

#### **Neural Network**

A neural network-based combustion optimization system is a software addition that can be used to optimize and fine-tune boiler operations. The neural network software models the relationships between various operator controlled parameters that affect boiler emissions and thermal performance, and through links to the plant distributed control system (DCS) and combustion control system logic, automatically adjusts the operator settings as needed to provide the most efficient operation of the units.

The function of the combustion optimization system is to enhance the capability of the existing DCS and boiler controls to manage controllable parameters that affect boiler emissions and thermal performance. Installation of the neural network is not anticipated to result in a physical change to the boiler, in that it simply involves the use of an inductive mathematical model of boiler operations that will be used to assist the existing boiler control system to optimize boiler operations. Also, because the combustion optimization system only works to manage and optimize movement within existing plant operator adjustable parameters, it will not change any of the parameters that the operators currently use to manage and optimize boiler operation; thus, it is not considered a change in the method of operation of the boiler.

#### **Technical Description**

The neural network system supplements, but does not replace, the fundamental control, start-up, ramping and shutdown functions of the plant DCS or boiler control system. The combustion optimization system uses neural network-based inductive models and advanced search optimization methodologies to identify and then 'learn' the complex relationships between the dozens of existing controllable parameters within the boiler and the key performance metrics such as NO<sub>x</sub>, CO, opacity, and boiler thermal efficiency. The combustion optimization system uses this knowledge to calculate the supervisory set points required to improve the mixing of fuel and air within the combustion zone, as well as mill outlet temperatures, feeder biases and other controllable parameters. These set points are down loaded to the DCS in real-time.

OUC  
Stanton

B&V Project 143799  
September 1, 2006

The combustion optimization system runs on a dedicated server pc and communicates directly with the plant DCS, typically through the plant historian, to collect data and download recommended set points. The primary goal of the supervisory service is to fine-tune boiler operations while maintaining process control and safety boiler operating constraints. The combustion optimization system recommendations are transferred to the DCS control logic through a transfer block that selects either the operator's manual bias or the combustion optimization system's automatic bias

Each unit will have between 15 and 40 manipulated variables. Typical variables include:

- Oxygen bias
- Forced draft bias
- Induced draft bias
- Furnace pressure set point
- Overfire air dampers
- Primary air bias
- Mill outlet temperature bias
- Burner primary or secondary air damper bias

The operator enables the supervisory service via customized DCS displays installed with the system implementation. From these displays the operator can turn the system on and off, as well as enable or disable individual controllers. The neural models are configured with minimum and maximum constraints as well as rate of change limits to keep the models from issuing recommendations that infringe on safe and effective boiler operating conditions for key parameters such as CO and opacity. Further, the supervisory set point and bias recommendations downloaded by the combustion optimization system are constrained within the DCS to avoid process disturbances and smoothly ramp any changes. The combustion optimization and DCS are configured to provide bumpless transfer when switching from one mode to the other.

#### **Environmental Consequences of Installation and Operation**

OUC anticipates no adverse environmental impacts resulting from the approval and implementation of the neural network-based combustion optimization system.

The anticipated benefits of using a neural network-based combustion optimization system include the following.

- Enhancement of the ability of the existing DCS and boiler control system to fine-tune boiler operations that affect boiler emissions and thermal performance.
- Ability to be configured to manage and optimize the sometimes competing objectives of reduced stack NO<sub>x</sub>, increased boiler efficiency, reduced loss-on-ignition, reduced opacity and reduced reagent consumption (if an SCR is in place.)
- Self-evaluation and "learning" capabilities, so the system can be left in supervisory control of a plant indefinitely resulting in sustainable benefits.
- Quick adaptation to physical changes in the boiler combustion zone, such as Low NO<sub>x</sub> burners and overfire air, as well as backend emissions control hardware changes, such as SCR and FGD retrofits.

Regardless of the physical configuration of the units, now and in the future, the boiler optimization system will provide supervisory assistance to the DCS and boiler combustion controls to best manage emissions and thermal performance objectives.

OUC  
Stanton

B&V Project 143799  
September 1, 2006

OUC appreciates the opportunity to work with the Department in obtaining the required air quality permit modifications for improved operations at the Curtis H. Stanton Energy Center. Should you have any questions or concerns regarding this submittal, please do not hesitate to contact me at (913) 458-7563 or Denise Stalls of OUC at (407) 737-4236.

Sincerely,

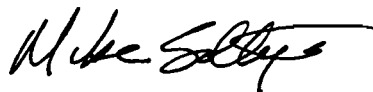

Mike Soltys  
Site Certification Coordinator

Enclosures

cc: Fred Haddad, OUC  
Denise Stalls, OUC  
Buck Oven, FDEP  
Myron Rollins



1 2 3 4 5 6 7

A  
B  
C  
D

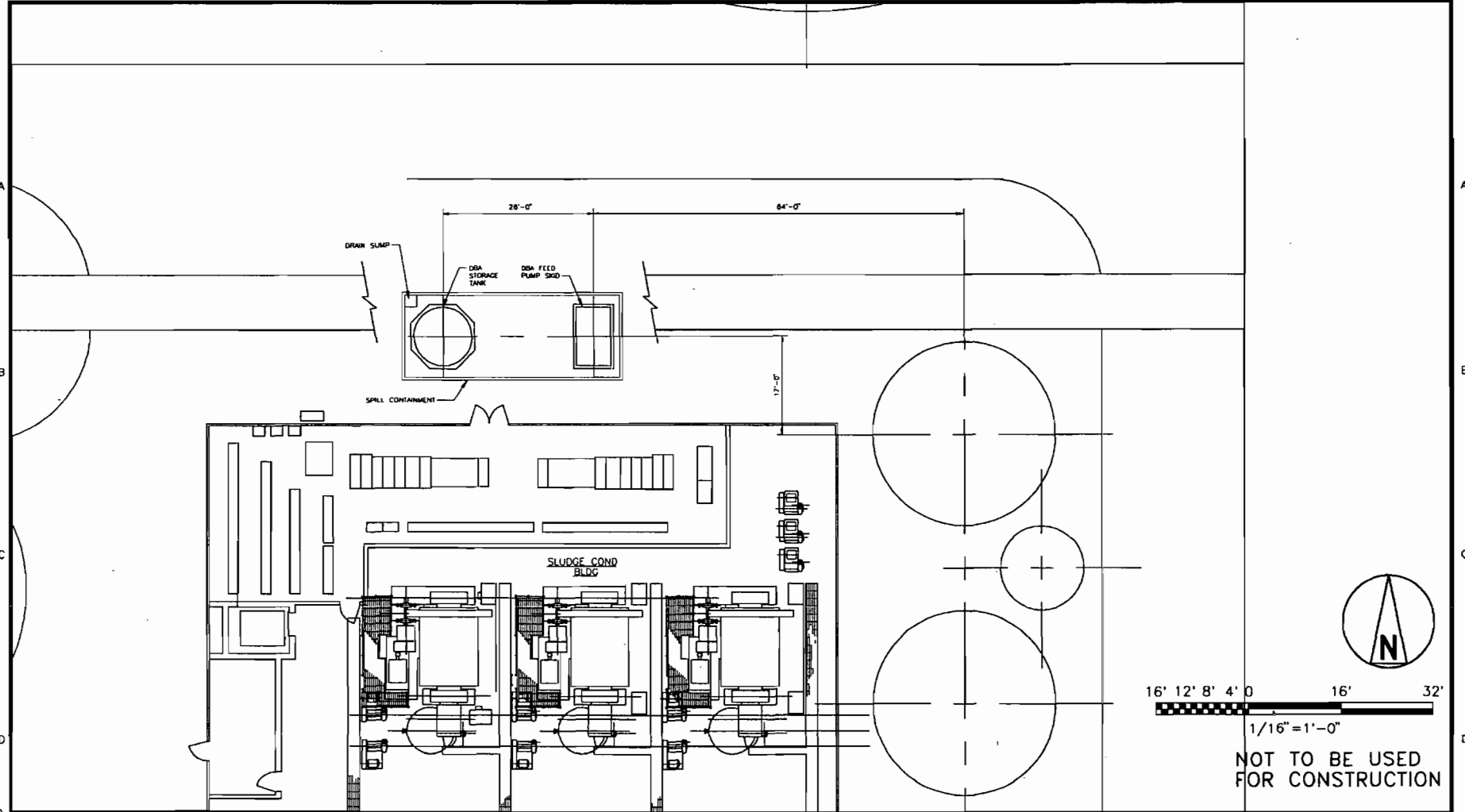

SAV01382 ACAD 15.05  
A1ASLO12 B1 1=1  
06/28/06 09:32:16

| NO | DATE       | REVISIONS AND RECORD OF ISSUE | DRN | DES | CHK | PDE | APP |
|----|------------|-------------------------------|-----|-----|-----|-----|-----|
| A  | 06-27-2006 | ISSUED FOR REVIEW             | BDS | BDS | DPT |     |     |

**BLACK & VEATCH CORPORATION**

|          |      |          |     |
|----------|------|----------|-----|
| ENGINEER | DPT  | DRAWN    | BOS |
| CHECKED  | DATE | 06-27-06 |     |

**ORLANDO UTILITIES COMMISSION**  
STANTON ENERGY CENTER UNITS 1 & 2

GENERAL ARRANGEMENT  
DIBASIC ACID INJECTION

|                   |                |     |
|-------------------|----------------|-----|
| PROJECT           | DRAWING NUMBER | REV |
| 143799-CBST-M1002 |                | A   |
| CODE              |                |     |
| AREA              |                |     |

NOT TO BE USED  
FOR CONSTRUCTION

- NOTES:
1. SYSTEM CODE IS 1CCH UNLESS NOTED OTHERWISE.
  2. ALL SYSTEM COMPONENTS ARE SERIES 1CCH-8000-MIN.
  3. STORAGE TANK, PIPING AND VALVES TYPE 304L STAINLESS STEEL.
  4. ALL BALL VALVES EXCEPT AS NOTED.
  5. ALL EQUIPMENT PIPING AND VALVES TO HAVE HEAT TRACING.

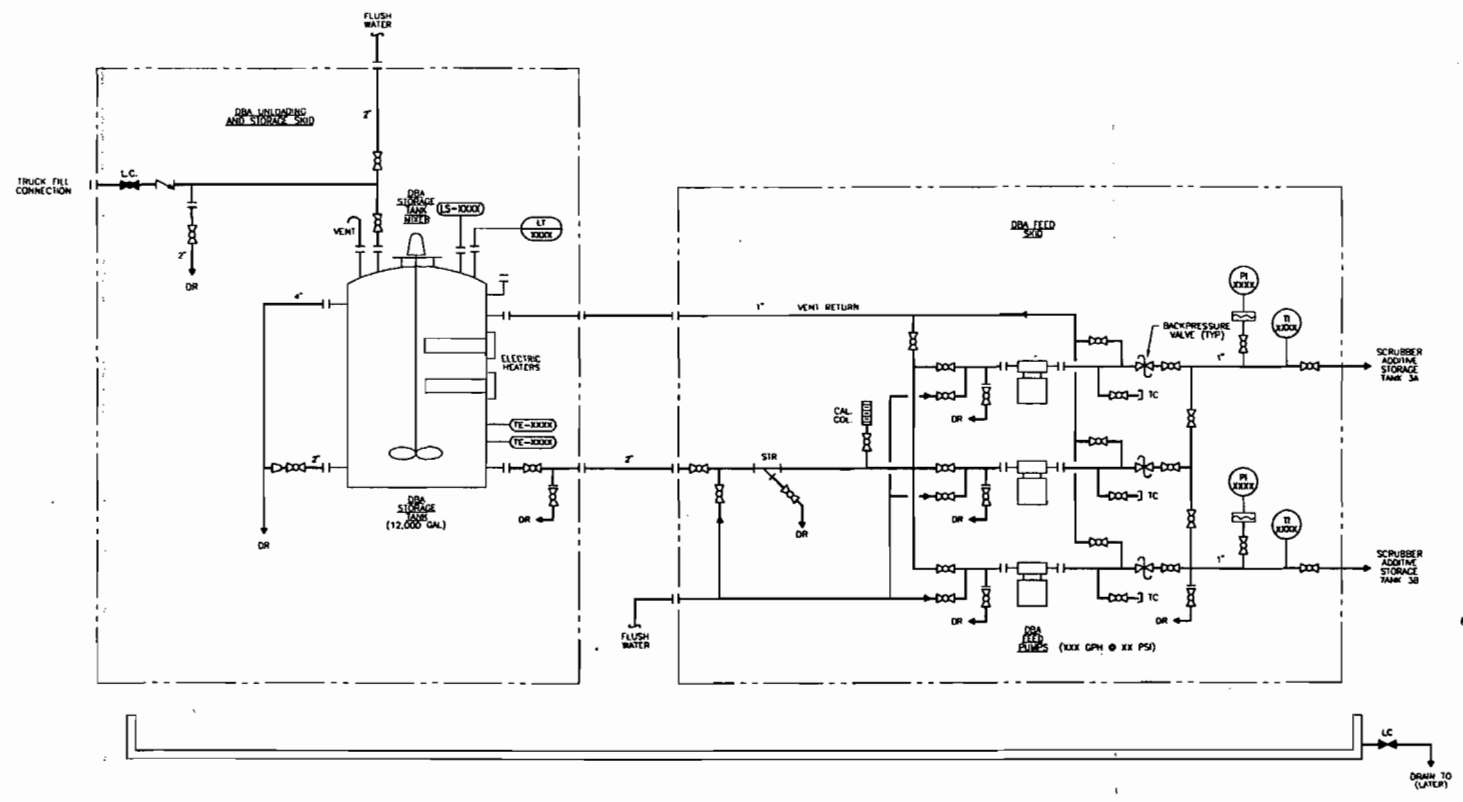

NOT TO BE USED FOR CONSTRUCTION

143799-CCCH-0303-08  
 06/21/08  
 143799-CCCH-0303-08

| NO | DATE       | REVISIONS AND RECORD OF ISSUE  | BY  | CHKD |
|----|------------|--------------------------------|-----|------|
| 1  | 06/23/2008 | ISSUED FOR OWNER REVIEW SPEC'S | JEH |      |
| 2  | 06/27/2008 | ISSUED FOR REVIEW              | JEH |      |
| 3  |            |                                |     |      |
| 4  |            |                                |     |      |
| 5  |            |                                |     |      |
| 6  |            |                                |     |      |
| 7  |            |                                |     |      |
| 8  |            |                                |     |      |
| 9  |            |                                |     |      |
| 10 |            |                                |     |      |

I HEREBY CERTIFY THAT THIS DOCUMENT WAS PREPARED BY ME OR UNDER MY DIRECT SUPERVISION AND THAT I AM A duly LICENSED PROFESSIONAL ENGINEER UNDER THE LAWS OF THE STATE OF FLORIDA.

SIGNED: \_\_\_\_\_ DATE: \_\_\_\_\_ REG. NO.: \_\_\_\_\_

**BLACK & VEATCH**  
CORPORATION

DESIGNED: \_\_\_\_\_ DRAWN: JEH  
CHECKED: \_\_\_\_\_ DATE: \_\_\_\_\_

**ORLANDO UTILITIES COMMISSION**  
STANTON ENERGY CENTER UNITS 1 & 2

PROJECT: 143799-CCCH-M2148  
DRAWING NUMBER: 143799-CCCH-M2148  
REV: B

PIPING AND INSTRUMENT DIAGRAM  
DIBASIC ACID INJECTION

DATE: \_\_\_\_\_  
BY: \_\_\_\_\_



## APPLICATION INFORMATION

### Purpose of Application

This application for air permit is submitted to obtain: (Check one)

#### **Air Construction Permit**

- Air construction permit.
- Air construction permit to establish, revise, or renew a plantwide applicability limit (PAL).
- Air construction permit to establish, revise, or renew a plantwide applicability limit (PAL), and separate air construction permit to authorize construction or modification of one or more emissions units covered by the PAL.

#### **Air Operation Permit**

- Initial Title V air operation permit.
- Title V air operation permit revision.
- Title V air operation permit renewal.
- Initial federally enforceable state air operation permit (FESOP) where professional engineer (PE) certification is required.
- Initial federally enforceable state air operation permit (FESOP) where professional engineer (PE) certification is not required.

#### **Air Construction Permit and Revised/Renewal Title V Air Operation Permit (Concurrent Processing)**

- Air construction permit and Title V permit revision, incorporating the proposed project.
- Air construction permit and Title V permit renewal, incorporating the proposed project.

**Note: By checking one of the above two boxes, you, the applicant, are requesting concurrent processing pursuant to Rule 62-213.405, F.A.C. In such case, you must also check the following box:**

- I hereby request that the department waive the processing time requirements of the air construction permit to accommodate the processing time frames of the Title V air operation permit.

### Application Comment

Air permit approval to install dibasic acid (DBA) additive systems to the wet FGD scrubber systems for Stanton Unit 1 and Unit 2. Air permit approval to install a neural-network based combustion optimization system on Stanton Unit 1 and Unit 2. A detailed description is provided in the letter submittal provided with this application.



**Owner/Authorized Representative Statement**

**Complete if applying for an air construction permit or an initial FESOP.**

|  |
|--|
| 1. Owner/Authorized Representative Name :<br>Frederick F. Haddad, Jr.  |
| 2. Owner/Authorized Representative Mailing Address...<br>Organization/Firm: Orlando Utilities Commission<br>Street Address: P.O. Box 3193<br>City: Orlando State: FL Zip Code: 32802   |
| 3. Owner/Authorized Representative Telephone Numbers...<br>Telephone: (407) 244-8732 ext. Fax: (407) 275-4120  |
| 4. Owner/Authorized Representative Email Address: <u>fhaddad@ouc.com</u>   |
| 5. Owner/Authorized Representative Statement:<br><br><i>I, the undersigned, am the owner or authorized representative of the facility addressed in this air permit application. I hereby certify, based on information and belief formed after reasonable inquiry, that the statements made in this application are true, accurate and complete and that, to the best of my knowledge, any estimates of emissions reported in this application are based upon reasonable techniques for calculating emissions. The air pollutant emissions units and air pollution control equipment described in this application will be operated and maintained so as to comply with all applicable standards for control of air pollutant emissions found in the statutes of the State of Florida and rules of the Department of Environmental Protection and revisions thereof and all other requirements identified in this application to which the facility is subject. I understand that a permit, if granted by the department, cannot be transferred without authorization from the department, and I will promptly notify the department upon sale or legal transfer of the facility or any permitted emissions unit.</i><br><br><br>Signature<br><br>8/30/2006<br>Date |

**Application Responsible Official Certification**

**Complete if applying for an initial/revised/renewal Title V permit or concurrent processing of an air construction permit and a revised/renewal Title V permit. If there are multiple responsible officials, the "application responsible official" need not be the "primary responsible official."**

|   |
|---|
| 1. Application Responsible Official Name:   |
| 2. Application Responsible Official Qualification (Check one or more of the following options, as applicable):<br><input type="checkbox"/> For a corporation, the president, secretary, treasurer, or vice-president of the corporation in charge of a principal business function, or any other person who performs similar policy or decision-making functions for the corporation, or a duly authorized representative of such person if the representative is responsible for the overall operation of one or more manufacturing, production, or operating facilities applying for or subject to a permit under Chapter 62-213, F.A.C.<br><input type="checkbox"/> For a partnership or sole proprietorship, a general partner or the proprietor, respectively.<br><input type="checkbox"/> For a municipality, county, state, federal, or other public agency, either a principal executive officer or ranking elected official.<br><input type="checkbox"/> The designated representative at an Acid Rain source.   |
| 3. Application Responsible Official Mailing Address...<br>Organization/Firm:<br>Street Address:<br>City: State: Zip Code:   |
| 4. Application Responsible Official Telephone Numbers...<br>Telephone: ( ) - ext. Fax: ( ) -  |
| 5. Application Responsible Official Email Address:  |
| 6. Application Responsible Official Certification:<br><i>I, the undersigned, am a responsible official of the Title V source addressed in this air permit application. I hereby certify, based on information and belief formed after reasonable inquiry, that the statements made in this application are true, accurate and complete and that, to the best of my knowledge, any estimates of emissions reported in this application are based upon reasonable techniques for calculating emissions. The air pollutant emissions units and air pollution control equipment described in this application will be operated and maintained so as to comply with all applicable standards for control of air pollutant emissions found in the statutes of the State of Florida and rules of the Department of Environmental Protection and revisions thereof and all other applicable requirements identified in this application to which the Title V source is subject. I understand that a permit, if granted by the department, cannot be transferred without authorization from the department, and I will promptly notify the department upon sale or legal transfer of the facility or any permitted emissions unit. Finally, I certify that the facility and each emissions unit are in compliance with all applicable requirements to which they are subject, except as identified in compliance plan(s) submitted with this application.</i><br><br>_____<br>Signature<br><br>_____<br>Date |

**Professional Engineer Certification**

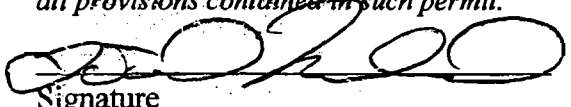
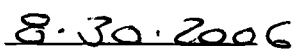
|  |
|--|
| 1. Professional Engineer Name: Larry Todd Newland<br>Registration Number: 64188  |
| 2. Professional Engineer Mailing Address...<br>Organization/Firm: Black & Veatch<br>Street Address: 11000 Regency Parkway, Suite 100<br>City: Cary State: NC Zip Code: 27518   |
| 3. Professional Engineer Telephone Numbers...<br>Telephone: (919) 462-7415 ext. Fax: (919) 468-9212  |
| 4. Professional Engineer Email Address: newlandlt@bv.com   |
| 5. Professional Engineer Statement:<br><i>I, the undersigned, hereby certify, except as particularly noted herein*, that:</i><br><i>(1) To the best of my knowledge, there is reasonable assurance that the air pollutant emissions unit(s) and the air pollution control equipment described in this application for air permit, when properly operated and maintained, will comply with all applicable standards for control of air pollutant emissions found in the Florida Statutes and rules of the Department of Environmental Protection; and</i><br><i>(2) To the best of my knowledge, any emission estimates reported or relied on in this application are true, accurate, and complete and are either based upon reasonable techniques available for calculating emissions or, for emission estimates of hazardous air pollutants not regulated for an emissions unit addressed in this application, based solely upon the materials, information and calculations submitted with this application.</i><br><i>(3) If the purpose of this application is to obtain a Title V air operation permit (check here <input type="checkbox"/> , if so), I further certify that each emissions unit described in this application for air permit, when properly operated and maintained, will comply with the applicable requirements identified in this application to which the unit is subject, except those emissions units for which a compliance plan and schedule is submitted with this application.</i><br><i>(4) If the purpose of this application is to obtain an air construction permit (check here <input checked="" type="checkbox"/> , if so) or concurrently process and obtain an air construction permit and a Title V air operation permit revision or renewal for one or more proposed new or modified emissions units (check here <input type="checkbox"/> , if so), I further certify that the engineering features of each such emissions unit described in this application have been designed or examined by me or individuals under my direct supervision and found to be in conformity with sound engineering principles applicable to the control of emissions of the air pollutants characterized in this application.</i><br><i>(5) If the purpose of this application is to obtain an initial air operation permit or operation permit revision or renewal for one or more newly constructed or modified emissions units (check here <input type="checkbox"/> , if so), I further certify that, with the exception of any changes detailed as part of this application, each such emissions unit has been constructed or modified in substantial accordance with the information given in the corresponding application for air construction permit and with all provisions contained in such permit.</i><br><br><br>Signature<br><br><br>Date<br><br>(seal) |

\* Attach any exception to certification statement.

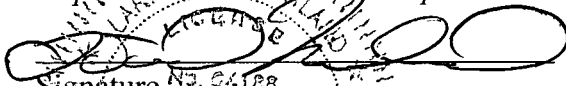
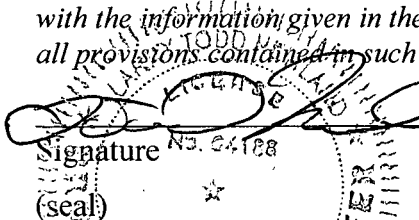

**Professional Engineer Certification**

|  |
|--|
| 1. Professional Engineer Name: Larry Todd Newland<br>Registration Number: 64188  |
| 2. Professional Engineer Mailing Address...<br>Organization/Firm: Black & Veatch<br>Street Address: 11000 Regency Parkway, Suite 100<br>City: Cary State: NC Zip Code: 27518   |
| 3. Professional Engineer Telephone Numbers...<br>Telephone: (919) 462-7415 ext. Fax: (919) 468-9212  |
| 4. Professional Engineer Email Address: newlandlt@bv.com   |
| 5. Professional Engineer Statement:<br><i>I, the undersigned, hereby certify, except as particularly noted herein*, that:</i><br><i>(1) To the best of my knowledge, there is reasonable assurance that the air pollutant emissions unit(s) and the air pollution control equipment described in this application for air permit, when properly operated and maintained, will comply with all applicable standards for control of air pollutant emissions found in the Florida Statutes and rules of the Department of Environmental Protection; and</i><br><i>(2) To the best of my knowledge, any emission estimates reported or relied on in this application are true, accurate, and complete and are either based upon reasonable techniques available for calculating emissions or, for emission estimates of hazardous air pollutants not regulated for an emissions unit addressed in this application, based solely upon the materials, information and calculations submitted with this application.</i><br><i>(3) If the purpose of this application is to obtain a Title V air operation permit (check here <input type="checkbox"/>, if so), I further certify that each emissions unit described in this application for air permit, when properly operated and maintained, will comply with the applicable requirements identified in this application to which the unit is subject, except those emissions units for which a compliance plan and schedule is submitted with this application.</i><br><i>(4) If the purpose of this application is to obtain an air construction permit (check here <input checked="" type="checkbox"/>, if so) or concurrently process and obtain an air construction permit and a Title V air operation permit revision or renewal for one or more proposed new or modified emissions units (check here <input type="checkbox"/>, if so), I further certify that the engineering features of each such emissions unit described in this application have been designed or examined by me or individuals under my direct supervision and found to be in conformity with sound engineering principles applicable to the control of emissions of the air pollutants characterized in this application.</i><br><i>(5) If the purpose of this application is to obtain an initial air operation permit or operation permit revision or renewal for one or more newly constructed or modified emissions units (check here <input type="checkbox"/>, if so), I further certify that, with the exception of any changes detailed as part of this application, each such emissions unit has been constructed or modified in substantial accordance with the information given in the corresponding application for air construction permit and with all provisions contained in such permit.</i><br><br>Signature  No. 64188<br>(seal) <br>Date <u>8.30.2006</u> |

\* Attach any exception to certification statement.



**Owner/Authorized Representative Statement**

**Complete if applying for an air construction permit or an initial FESOP.**

|   |
|---|
| 1. Owner/Authorized Representative Name :<br>Frederick F. Haddad, Jr.   |
| 2. Owner/Authorized Representative Mailing Address...<br>Organization/Firm: Orlando Utilities Commission<br>Street Address: P.O. Box 3193<br>City: Orlando State: FL Zip Code: 32802  |
| 3. Owner/Authorized Representative Telephone Numbers...<br>Telephone: (407) 244-8732 ext. Fax: (407) 275-4120   |
| 4. Owner/Authorized Representative Email Address: <u>fhaddad@ouc.com</u>  |
| 5. Owner/Authorized Representative Statement:<br><br><i>I, the undersigned, am the owner or authorized representative of the facility addressed in this air permit application. I hereby certify, based on information and belief formed after reasonable inquiry, that the statements made in this application are true, accurate and complete and that, to the best of my knowledge, any estimates of emissions reported in this application are based upon reasonable techniques for calculating emissions. The air pollutant emissions units and air pollution control equipment described in this application will be operated and maintained so as to comply with all applicable standards for control of air pollutant emissions found in the statutes of the State of Florida and rules of the Department of Environmental Protection and revisions thereof and all other requirements identified in this application to which the facility is subject. I understand that a permit, if granted by the department, cannot be transferred without authorization from the department, and I will promptly notify the department upon sale or legal transfer of the facility or any permitted emissions unit.</i><br><br><br>Signature<br><br><u>8/30/2006</u><br>Date |

**Application Responsible Official Certification**

**Complete if applying for an initial/revised/renewal Title V permit or concurrent processing of an air construction permit and a revised/renewal Title V permit. If there are multiple responsible officials, the “application responsible official” need not be the “primary responsible official.”**

|   |
|---|
| 1. Application Responsible Official Name:   |
| 2. Application Responsible Official Qualification (Check one or more of the following options, as applicable):<br><input type="checkbox"/> For a corporation, the president, secretary, treasurer, or vice-president of the corporation in charge of a principal business function, or any other person who performs similar policy or decision-making functions for the corporation, or a duly authorized representative of such person if the representative is responsible for the overall operation of one or more manufacturing, production, or operating facilities applying for or subject to a permit under Chapter 62-213, F.A.C.<br><input type="checkbox"/> For a partnership or sole proprietorship, a general partner or the proprietor, respectively.<br><input type="checkbox"/> For a municipality, county, state, federal, or other public agency, either a principal executive officer or ranking elected official.<br><input type="checkbox"/> The designated representative at an Acid Rain source.   |
| 3. Application Responsible Official Mailing Address...<br>Organization/Firm:<br>Street Address:<br>City: State: Zip Code:   |
| 4. Application Responsible Official Telephone Numbers...<br>Telephone: ( ) - ext. Fax: ( ) -  |
| 5. Application Responsible Official Email Address:  |
| 6. Application Responsible Official Certification:<br><i>I, the undersigned, am a responsible official of the Title V source addressed in this air permit application. I hereby certify, based on information and belief formed after reasonable inquiry, that the statements made in this application are true, accurate and complete and that, to the best of my knowledge, any estimates of emissions reported in this application are based upon reasonable techniques for calculating emissions. The air pollutant emissions units and air pollution control equipment described in this application will be operated and maintained so as to comply with all applicable standards for control of air pollutant emissions found in the statutes of the State of Florida and rules of the Department of Environmental Protection and revisions thereof and all other applicable requirements identified in this application to which the Title V source is subject. I understand that a permit, if granted by the department, cannot be transferred without authorization from the department, and I will promptly notify the department upon sale or legal transfer of the facility or any permitted emissions unit. Finally, I certify that the facility and each emissions unit are in compliance with all applicable requirements to which they are subject, except as identified in compliance plan(s) submitted with this application.</i><br><br>_____<br>Signature<br><br>_____<br>Date |



**BLACK & VEATCH**  
building a world of difference™

ENERGY • WATER • INFORMATION • GOVERNMENT

*Send to  
Al Limer  
Tallahassee* OK to  
OUC files

RECEIVED  
NOV 30 2007

Orlando Utilities Commission  
Stanton Energy Center

DEP Central Dist.

B&V Project 143799  
November 29, 2007

RECEIVED  
DEC 07 2007

Ms. Vivian F. Garfein, Director  
Central District Office  
Florida Department of Environmental Protection  
3319 Maguire Blvd, Suite 232  
Orlando, FL 32803-3767

BUREAU OF AIR REGULATION

Subject: OUC Stanton Air Permit No. 0950137-011-AC  
Notification of Construction Completion

Dear Ms. Garfein:

On behalf of the Orlando Utilities Commission (OUC), please be advised that construction of the DBA additive system installed on the Stanton Units 1 and 2 flue gas desulfurization systems was completed on November 27, 2007. This notification satisfies Condition 5 in Section III of air construction permit No. 0950137-011-AC.

OUC appreciates the opportunity to work with the Department in obtaining the required air quality permits and approvals for these improvements at the Stanton Energy Center. Should you have any questions or concerns regarding this submittal, please do not hesitate to contact me at (913) 458-7563 or Louis Brown of OUC at (407) 658-6444.

Sincerely,

Michael Soltys  
Site Certification Coordinator

cc: Louis Brown, OUC