

Florida Department of
Environmental Protection

Memorandum

TO: Howard Rhodes
FROM: Clair Fancy 
SUBJECT: Construction Permit: 0950111-013-AC
Walt Disney World Resort: Disney's Animal Kingdom: Animal Crematory
DATE: March 13, 1998

BAR
3/18/98

The attached construction permit is for a proposed animal crematory, which is to be installed at Walt Disney World Co.'s Walt Disney World Resort, specifically at Disney's Animal Kingdom theme park located in Lake Buena Vista, Orange County, Florida. The animal crematory has a limitation of 800 pounds per four-hour period, is fired with natural gas only, and has a maximum heat input of 3.0 MMBtu/hr. The emissions unit is subject to the provisions of Rules 62-296.401(1) and 62-296.401(6), F.A.C.

There were no comments received regarding the Public Notice. The construction of this emissions unit should not be controversial. Therefore, it is recommended that the attached construction permit be signed as drafted and noticed.

CHF/bm 

Attachment

cc: Scott Sheplak, P.E.

STATE OF FLORIDA
DEPARTMENT OF ENVIRONMENTAL PROTECTION
NOTICE OF PERMIT

In the Matter of an
Application for Permit

Mr. Lee Schmudde
Vice President, Legal
Walt Disney World Co.
P.O. Box 10,000
Lake Buena Vista, Florida 32830-1000

DEP File No. 0950111-013-AC

Walt Disney World Resort
Disney's Animal Kingdom: Animal Crematory

Enclosed is the Construction Permit Number 0950111-013-AC. This permit is issued for a proposed animal crematory, which is to be installed at Walt Disney World Co.'s Walt Disney World Resort, specifically at Disney's Animal Kingdom theme park located in Lake Buena Vista, Orange County, Florida, pursuant to Chapter 403, Florida Statutes (F.S.).

Any party to this order (permit) has the right to seek judicial review of the permit pursuant to Section 120.68, F.S., by the filing of a Notice of Appeal pursuant to Rule 9.110, Florida Rules of Appellate Procedure, with the Clerk of the Department in the Legal Office; and by filing a copy of the Notice of Appeal accompanied by the applicable filing fees with the appropriate District Court of Appeal. The Notice of Appeal must be filed within 30 (thirty) days from the date this Notice is filed with the Clerk of the Department.

Executed in Tallahassee, Florida.

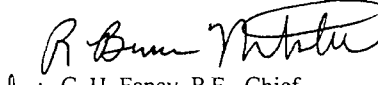
for C. H. Fancy, P.E., Chief
Bureau of Air Regulation

CERTIFICATE OF SERVICE

The undersigned duly designated deputy agency clerk hereby certifies that this NOTICE OF PERMIT (including the final construction permit) was sent by certified mail (*) and copies were mailed by U.S. Mail before the close of business on 3/18/98 to the person(s) listed:

Lee Schmudde, Vice President, Legal *
Len Kozlov, CD
Bob Beaver, P.E., Walt Disney World Co.
Richard Bumar, Contact, Walt Disney World Co.

Clerk Stamp

FILING AND ACKNOWLEDGMENT FILED, on this date, pursuant to §120.52, F.S., with the designated Department Clerk, receipt of which is hereby acknowledged.

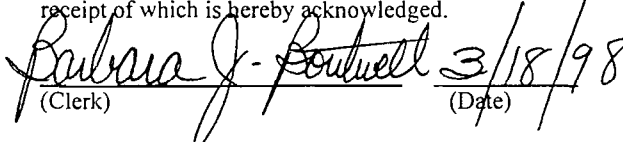
(Clerk) 3/18/98
(Date)

Is your RETURN ADDRESS completed on the reverse side?

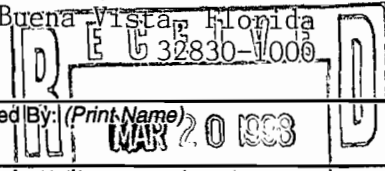
SENDER: ■ Complete items 1 and/or 2 for additional services. ■ Complete items 3, 4a, and 4b. ■ Print your name and address on the reverse of this form so that we can return this card to you. ■ Attach this form to the front of the mailpiece, or on the back if space does not permit. ■ Write "Return Receipt Requested" on the mailpiece below the article number. ■ The Return Receipt will show to whom the article was delivered and the date delivered.		I also wish to receive the following services (for an extra fee): 1. <input type="checkbox"/> Addressee's Address 2. <input type="checkbox"/> Restricted Delivery Consult postmaster for fee.
3. Article Addressed to: Mr. Lee Schmutde Vice President, Legal Walt Disney World Co. P.O. Box 10,000 Lake Buena Vista, Florida 32830-1000	4a. Article Number Z 333 638 477	
5. Received By: (Print Name) 		4b. Service Type <input type="checkbox"/> Registered <input checked="" type="checkbox"/> Certified <input type="checkbox"/> Express Mail <input type="checkbox"/> Insured <input type="checkbox"/> Return Receipt for Merchandise <input type="checkbox"/> COD
6. Signature: (Addressee or Agent) X		7. Date of Delivery 8. Addressee's Address (Only if requested and fee is paid)

Thank you for using Return Receipt Service.

PS Form 3811, December 1994

Domestic Return Receipt

Z 333 638 477

US Postal Service
Receipt for Certified Mail
 No Insurance Coverage Provided.
 Do not use for International Mail (See reverse)

Sent to	
Mr. Lee Schmutde	
Street & Number	
P.O. Box 10,000	
Post Office, State, & ZIP Code	
Lake Buena Vista, FL	
Postage	\$ 32830-1000
Certified Fee	
Special Delivery Fee	
Restricted Delivery Fee	
Return Receipt Showing to Whom & Date Delivered	
Return Receipt Showing to Whom, Date, & Addressee's Address	
TOTAL Postage & Fees	\$
Postmark or Date	
3/18/98	
Walt Disney World	
0950111-013-AC	

PS Form 3800, April 1995

FINAL DETERMINATION

Walt Disney World Co.

Permit No.: 0950111-013-AC

Walt Disney World Resort Complex
Disney's Animal Kingdom
Animal Crematory at the Necropsy Building

An Intent to Issue an air construction permit for a proposed animal crematory, which is to be installed at Walt Disney World Co.'s Walt Disney World Resort, specifically at Disney's Animal Kingdom theme park located in Lake Buena Vista, Orange County, Florida, was distributed on February 18, 1998. The Public Notice of Intent to Issue Air Construction Permit was published in The Orlando Sentinel on February 22, 1998. Comments were not submitted in response to the public notice.

The final action of the Department will be to issue the permit as proposed.

TECHNICAL EVALUATION
AND
PRELIMINARY DETERMINATION

Walt Disney World Co.
Walt Disney World Resort Complex
Facility ID No.: 0950111
Orange County

Animal Crematory

Air Construction Permit No. 0950111-013-AC

Department of Environmental Protection
Division of Air Resources Management
Bureau of Air Regulation
Title V Section

February 17, 1998

TECHNICAL EVALUATION AND PRELIMINARY DETERMINATION

1. APPLICATION INFORMATION

1.1. Applicant Name and Address

Walt Disney World Co.
P.O. Box 10,000
Orlando, Florida 32830-1000

Responsible Official
Mr. Lee Schumde, Vice President, Legal

1.2. Reviewing and Process Schedule

01-20-98: Date of Receipt of Application

2. FACILITY INFORMATION

2.1. Facility Location

Walt Disney World Co. intends to construct an animal crematory at its Walt Disney World Resort, Disney's Animal Kingdom, specifically at the Necropsy Building. Disney's Animal Kingdom is a new theme park within the Walt Disney World Resort complex and will include live animal exhibits, rides, shows, restaurants, merchandise locations, and staff support facilities. The emissions unit is a Crawford Model CB800 Animal Carcass Incinerator, which will be used to dispose of dead animals from both the theme park and from other areas within the Walt Disney World Resort property.

The UTM: coordinates of this facility are Zone 17 ; 449.70 km E ; 3138.00 km N.

2.2. Standard Industrial Classification Code (SIC)

Major Group No.	79	Amusement and Recreational Services
Group No.	799	Miscellaneous Amusement and Recreational Services
Industry No.	7996	Amusement Parks: Theme Parks

2.3. Facility Category

Walt Disney World Resort is classified as a major air pollutant emitting facility. This facility is not on the list of the 28 Major Facility Categories, Table 62-212.400-1. This facility is classified as a Title V - Title IV facility and received its initial Title V - Title IV operation permit on December 31, 1997. Based on the application for this new emissions unit, the animal

TECHNICAL EVALUATION AND PRELIMINARY DETERMINATION

crematory is a minor emissions unit of air pollution and the specific conditions in the draft permit will reflect this.

3. PROJECT DESCRIPTION

3.1. This permit addresses the following emissions unit:

EMISSION UNIT NO.	EMISSION UNIT DESCRIPTION
-xxx	Crawford Model CB800 Animal Crematory

The applicant requested an air construction permit to install an animal crematory to incinerate animal carcasses (including primates). The emissions unit has a design capacity to process an 800 pound load every four hours. The emissions unit will be fired on natural gas with a maximum heat input of 3.0 MMBtu/hr. The emissions unit will be permitted to operate 8760 hrs/yr. The emissions unit will have a primary and secondary chamber. The secondary chamber has a calculated residence time and temperature of 1.14 seconds @ 1800 °F, respectively (rule requires minimums of 1.0 second @ 1800 °F).

4. RULE APPLICABILITY

The proposed project is subject to preconstruction review requirements under the provisions of Chapter 403, Florida Statutes, and Florida Administrative Code (F.A.C.) Chapters 62-4, 62-204, 62-210, 62-212, 62-296, and 62-297.

In accordance with Rule 62-204.340(4)(a)1., F.A.C., this facility is located in an area (Orange County) designated as maintenance for the pollutant ozone. The proposed project is subject to review under Rule 62-212.300(3), F.A.C., General - Permitting Requirements, and Rule 62-212.400(2)(d)1., F.A.C., Prevention of Significant Deterioration (PSD) - New Minor Facilities. The potential emissions are less than the significant emission rates established in Chapter 62-212, Table 212.400-2, F.A.C., for all pollutants.

The emissions unit affected by this permit shall be in compliance with all applicable provisions of the Florida Administrative Code and, specifically, the following Chapters and Rules:

Chapter 62-4	Permits
Rule 62-204.220	Ambient Air Quality Protection
Rule 62-204.240	Ambient Air Quality Standards
Rule 62-204.260	Prevention of Significant Deterioration Increments
Rule 62-204.340	Designation of Attainment, Nonattainment, and Maintenance Areas
Rule 62-210.300	Permits Required
Rule 62-210.350	Public Notice and Comments

TECHNICAL EVALUATION AND PRELIMINARY DETERMINATION

Rule 62-210.370	Reports
Rule 62-210.650	Circumvention
Rule 62-210.700(1), (4) & (6)	Excess Emissions
Rule 62-210.900	Forms and Instructions
Rule 62-212.300(3)	General Preconstruction Review Requirements
Rule 62-212.400(2)(d)1.	Prevention of Significant Deterioration
Rule 62-213	Operation Permits for Major Sources of Air Pollution
Rule 62-296.320(2)	General Pollutant Emission Limiting Standards - Objectionable Odors
Rule 62-296.320((4)(c)	General Pollutant Emission Limiting Standards - Unconfined Emissions of Particulate Matter
Rule 62-296.401(1)	Stationary Sources - Emission Standards, Incinerators (<50 TPD charging rate)
Rule 62-296.401(6)	Stationary Sources - Emission Standards, Incinerators - Animal Crematories
Rule 62-297.310	General Test Requirements
Rule 62-297.401	Compliance Test Methods

5. SOURCE IMPACT ANALYSIS

5.1. Emission Limitations

The proposed emissions unit has the potential to emit particulate matter, visible emissions, sulfur dioxide, nitrogen oxides, volatile organic compounds, and carbon monoxide. The permitted pollutant allowable emissions and the compliance procedures for this emissions unit are contained in the draft permit and the following table:

Pollutant	Standard	Test Method
Visible Emissions	No visible emissions (5% opacity)	DEP Method 9
Particulate Matter	≤ 0.080 gr/dscf, corrected to 7% O ₂	EPA Methods 3 and 5
Carbon Monoxide	≤ 100 ppmvd, corrected to 7% O ₂ on an hourly average basis	EPA Methods 3 and 10

Note:

1. The equivalent emissions of the regulated pollutants are:

Particulate Matter (PM/PM10):	0.24 lb/hr	1.04 TPY
Carbon Monoxide:	0.04 lb/hr	0.16 TPY
2. The potential emissions of the non-regulated pollutants are:

Nitrogen Oxides:	0.30 lb/hr	1.31 TPY
Sulfur Dioxide:	0.002 lb/hr	0.01 TPY
Volatile Organic Compounds:	0.02 lb/hr	0.08 TPY

[Rules 62-296.401(1), 62-296.401(6) and 62-297.401, F.A.C.; and, application received 01/20/98]

TECHNICAL EVALUATION AND PRELIMINARY DETERMINATION

5.2. Control Technology Review

There are no controls associated with the proposed emissions unit. However, the design and operational criteria should be adequate to meet the rule requirements and standards.

5.3. Air Quality

Based on the level of potential emissions, this proposed activity should not cause a violation of any air quality standard or increment.

6. CONCLUSION

Based on the foregoing technical evaluation of the application submitted by Walt Disney World Co., the Department has made a preliminary determination that the proposed project will be in compliance with all applicable state and federal air pollution regulations. The General and Specific Conditions are provided in the attached draft permit conditions of approval.

Permit Engineer: Bruce Mitchell

Reviewed and Approved by Scott Sheplak, P.E.

Walt Disney World Co.
Walt Disney World Resort Complex
Disney's Animal Kingdom
Facility ID No.: 0950111
Orange County

Animal Crematory at the Necropsy Building
Air Construction Permit
Permit No.: 0950111-013-AC

Permitting Authority:

State of Florida
Department of Environmental Protection
Division of Air Resources Management
Bureau of Air Regulation
Title V Section

Mail Station #5505
2600 Blair Stone Road
Tallahassee, Florida 32399-2400

Telephone: 850/488-1344
Fax: 850/922-6979

Compliance Authority:

State of Florida
Department of Environmental Protection
Central District Office
3319 Maguire Boulevard, Suite 232
Orlando, Florida 32803-3767
Telephone: 407/894-7555
Fax: 407/897-2966

Air Construction Permit
Permit No.: 0950111-013-AC

Table of Contents

<u>Section</u>	<u>Page Number</u>
Placard Page	1
I. Facility Information	2
A. Facility Description.	
B. Summary of Emissions Unit ID No(s). and Brief Description(s).	
C. Relevant Documents.	
II. Facility-wide Conditions	2 - 3
III. Emissions Unit Specific Conditions	3 - 11



Department of Environmental Protection

Lawton Chiles
Governor

Twin Towers Office Building
2600 Blair Stone Road
Tallahassee, Florida 32399-2400

Virginia B. Wetherell
Secretary

Permittee:
Walt Disney World Co.
P.O. Box 10,000
Orlando, Florida 32830-1000

Construction Permit No.: 0950111-013-AC
Facility ID No.: 0950111
SIC Nos.: 79, 7996
Expiration Date: December 31, 1999
Project: Air Construction Permit for an
Animal Crematory

This permit is for the construction/installation of an animal crematory at Disney's Animal Kingdom theme park, specifically at the Necropsy Building, to dispose of dead animals from both the theme park and from other areas within the Walt Disney World Resort property. The proposed incinerator has a capacity to process 800 pounds per 4-hour period and is a Crawford Model CB800 Animal Carcass Incinerator. The emissions unit will be fired with natural gas.

The resort is located at 1375 Buena Vista Drive, Orange and Osceola Counties. UTM Coordinates: Zone 17, 449.70 km East and 3138.00 km North; Latitude: 28° 22' 24" North and Longitude: 81° 32' 46" West.

This air construction permit is issued under the provisions of Chapter 403, Florida Statutes (F.S.), and Florida Administrative Code (F.A.C.) Chapters 62-4, 62-210, 62-212, 62-296 and 62-297. The above named permittee is hereby authorized to perform the work or construct/install the facility shown on the application and approved drawing(s), plans, and other documents, attached hereto or on file with the Department of Environmental Protection (Department), in accordance with the terms and conditions of this permit.

Referenced attachments made a part of this permit:

APPENDIX TV-1, TITLE V CONDITIONS (version dated 12/02/97)
APPENDIX SS-1, STACK SAMPLING FACILITIES (dated 10/07/96)
TABLE 297.310-1, CALIBRATION SCHEDULE (dated 10/07/96)

Howard L. Rhodes, Director
Division of Air Resources
Management

HLR/sms/bm

"Protect, Conserve and Manage Florida's Environment and Natural Resources"

Section I. Facility Information.

Subsection A. Facility Description.

The facility is a complex of hotels, theme parks and support facilities, and a utility. The various air pollution sources are boilers, a combined cycle combustion turbine with a natural gas-fired heat recovery steam generator, paint spray booths and associated operations, external combustion oil heaters and hot water heaters.

Based on the initial Title V permit application received June 12, 1996, this facility is a major source of hazardous air pollutants (HAPs).

Subsection B. Summary of Emissions Unit ID No(s). and Brief Description(s).

-xxx Crawford Model CB800 Animal Carcass Incinerator

Please reference the Permit No., Facility ID No., and appropriate Emissions Unit(s) ID No(s) on all correspondence, test report submittals, applications, etc.

Subsection C. Relevant Documents.

The document(s) listed below are not a part of this permit; however, they are specifically related to this permitting action.

These documents are provided to the permittee for information purposes only:
Appendix A-1, Abbreviations, Acronyms, Citations, and Identification Numbers

These documents are on file with the permitting authority:
Construction Permit Application received January 20, 1998.
Mr. C. H. Fancy's letter dated February 11, 1998.
Technical Evaluation and Preliminary Determination issued February 18, 1998.

Section II. Facility-wide Conditions.

The following conditions apply facility-wide:

1. APPENDIX TV-1, TITLE V CONDITIONS, is a part of this permit.
{Permitting note: APPENDIX TV-1, TITLE V CONDITIONS, is distributed to the permittee only. Other persons requesting copies of these conditions shall be provided a copy when requested or otherwise appropriate.}
2. General Pollutant Emission Limiting Standards. Objectionable Odor Prohibited. No person shall cause, suffer, allow, or permit the discharge of air pollutants which cause or contribute to an objectionable odor.
[Rules 62-296.320(2) and 62-296.401(1)(b), F.A.C.]

3. General Pollutant Emission Limiting Standards. Volatile Organic Compounds (VOC) Emissions or Organic Solvents (OS) Emissions. The permittee shall allow no person to store, pump, handle, process, load, unload or use in any process or installation, volatile organic compounds or organic solvents without applying known and existing vapor emission control devices or systems deemed necessary and ordered by the Department.
[Rule 62-296.320(1)(a), F.A.C.]

4. Reasonable precautions to prevent emissions of unconfined particulate matter at this facility during operations include: chemical or water application to unpaved roads, unpaved yard areas, and storage piles; paving and maintenance of roads, parking areas and plant grounds; landscaping and planting of vegetation; confining abrasive blasting where possible; and other techniques, as necessary. Also, for the solid waste disposal area, wetting agents shall be applied.
[Rule 62-296.320(4)(c)2., F.A.C]

5. When appropriate, any recording, monitoring, or reporting requirements that are time-specific shall be in accordance with the effective date of the permit, which defines day one.
[Rule 62-213.440, F.A.C.]

6. The permittee shall submit all compliance related notifications and reports required of this permit to the Department's Central District office at the following address:

Department of Environmental Protection
Central District Office
3319 Maguire Boulevard, Suite 232
Orlando, Florida 32803-3767
Telephone: 407/894-7555
Fax: 407/897-2966

III. Specific Emission Limiting and Performance Standards.

General.

A. The following Specific Conditions are applicable to the animal crematory, Crawford Model CD800 Animal Carcass Incinerator, located at Disney's Animal Kingdom, specifically at the Necropsy Building:

Essential Potential to Emit (PTE) Parameters.

1. Permitted Capacity.

- a. The emissions unit's processing capacity shall not exceed 800 lbs per four-hour period (equivalent to 200 lbs/hr); and,
- b. The emissions unit's maximum heat input shall not exceed 3.0 MMBtu/hr while firing only natural gas.

[Rules 62-4.070, 62-4.160(2), 62-296.401(1), and 62-297.310(2)(b), F.A.C.]

2. Emissions Unit Operating Rate Limitation After Testing. See specific condition 28.

[Rule 62-297.310(2), F.A.C.]

3. Hours of operation. The emissions unit is allowed to operate continuously, i.e., 8760 hours per year.

[Rule 62-21.200, Definitions - Potential to Emit (PTE), F.A.C.]

4. Methods of Operation - Fuels. The only fuel authorized to be burned is natural gas.

[Rules 62-4.160(2) and 62-210.200 (PTE), F.A.C.]

Emission Limitations and Standards.

5. Visible emissions. No visible emissions (5 percent opacity) except that visible emissions not exceeding 20 percent opacity are allowed for up to three minutes in any one-hour period.

[Rule 62-296.401(1)(a), F.A.C.]

6. Particulate matter. Particulate matter emissions shall not exceed 0.080 grains per dry standard cubic foot of flue gas, corrected to 7% O₂.

[Rule 62-296.401(6)(a), F.A.C.]

7. Carbon monoxide. Carbon monoxide (CO) emissions shall not exceed 100 parts per million by volume (ppmv), dry basis, corrected to 7% O₂ on an hourly average basis.

[Rule 62-296.401(6)(b), F.A.C.]

8. Operation Residence Time and Temperature(s). The design of the secondary chamber combustion zone shall be such that it has a minimum residence time of 1.0 seconds at 1800 degrees Fahrenheit (°F). The actual operating temperature of the secondary chamber combustion zone shall be no less than 1600 °F throughout the combustion process in the primary chamber. Cremation in the primary chamber shall not begin unless the secondary chamber combustion zone temperature is equal to or greater than 1600 °F.

[Rule 62-296.401(6)(c), F.A.C.]

Excess Emissions

9. Excess emissions resulting from startup, shutdown or malfunction of any emissions unit shall be permitted provided that best operational practices to minimize emissions are adhered to and the duration of excess emissions shall be minimized but in no case exceed two hours in any 24-hour period unless specifically authorized by the Department for longer duration.

[Rule 62-210.700(1), F.A.C.]

10. Excess emissions which are caused entirely or in part by poor maintenance, poor operation, or any other equipment or process failure which may reasonably be prevented during startup, shutdown or malfunction shall be prohibited.

[Rule 62-210.700(4), F.A.C.]

Operations.

11. This emissions unit is permitted to incinerate only dead animals and, if applicable, the bedding and the remains associated with the animals placed in leak-proof containers. Containers may contain up to 0.5 percent by weight chlorinated plastics. Plastic bags used for the incineration of animals shall be nonchlorinated and no less than 3 mils thick. If containers are incinerated, documentation from the manufacturers certifying that they are composed of 0.5 percent or less by weight chlorinated plastics must be kept on-file at the site for the duration of their use and for at least five years after their use. This documentation must also be submitted with any application for renewal air operation permit.

[Rules 62-213.440 and 296.401(6)(e), F.A.C.]

12. This emissions unit is not permitted to cremate dead animals which were used for medical or commercial experimentation. No other material, including biomedical waste* as defined in Rule 62-210.200, F.A.C., shall be incinerated.

[Rule 62-296.401(6)(f), F.A.C.]

* "Biomedical Waste": Any solid waste or liquid waste which may present a threat of infection to humans, including nonliquid tissue, body parts, blood, blood products, and body fluids from humans and other primates; laboratory and veterinary wastes which contain human disease-causing agents; and, discarded sharps. The following are also included:

(a) Used absorbent materials saturated with blood, blood products, body fluids, or excretions or secretions contaminated with visible blood; and, absorbent materials saturated with blood or blood products that have dried.

(b) Non-absorbent, disposable devices that have been contaminated with blood, body fluids, or secretions or excretions visibly contaminated with blood, but have not been treated by a method listed in Section 381.0098, F.S., or a method approved pursuant to Rule 64E-16, F.A.C.

[Rule 62-210.200, F.A.C.]

Training.

13. Operators of the incinerator shall be trained by the equipment manufacturer's representatives or an equivalent state-approved organization. The content of the training program shall be submitted to the Department of Environmental Protection, Bureau of Air Regulation for approval.

[Rule 62-296.401(6)(g), F.A.C.]

14. The content of the training program shall be submitted to the Department for approval through the permitting process and shall meet, at a minimum, the criteria applicable to cremation set forth in the EPA Medical Waste Incinerator Operator Training Program Course Handbook, EPA 453/B-93-018, and Instructor's Guide, EPA 453/B-93-019.

[Rule 62-296.401(6)(g)1., F.A.C.]

15. A copy of the training certificate for each operator having satisfactorily completed the Department-approved training program must be submitted to the Department within 15 days of training. The owner of any new crematory units shall submit copies of the operator certificates within 15 days after completion of the initial compliance test pursuant to the unit's construction permit.

[Rule 62-296.401(6)(g)2., F.A.C.]

16. An operator's certificate must be kept on file at the facility for the duration of the operator's employment and for an additional five years after termination of employment.
[Rules 62-213.440 and 62-296.401(6)(g)3., F.A.C.]

Monitoring of Operations.

17. Determination of Process Variables.

(a) Required Equipment. The owner or operator of an emissions unit for which compliance tests are required shall install, operate, and maintain equipment or instruments necessary to determine process variables, such as process weight input or heat input, when such data are needed in conjunction with emissions data to determine the compliance of the emissions unit with applicable emission limiting standards.

(b) Accuracy of Equipment. Equipment or instruments used to directly or indirectly determine process variables, including devices such as belt scales, weight hoppers, flow meters, and tank scales, shall be calibrated and adjusted to indicate the true value of the parameter being measured with sufficient accuracy to allow the applicable process variable to be determined within 10% of its true value.

[Rule 62-297.310(5), F.A.C.]

Test Methods and Procedures.

18. The incinerator must be tested in its normal operating mode. In order for the permittee to be allowed to incinerate bedding, bags, or containers, these items shall be incinerated in normal amounts along with the animal remains during the compliance test burns. An incinerator which burns only animal remains during the compliance tests shall be permitted to incinerate only animal remains until a test determines compliance while incinerating bedding, bags, or containers along with the animal remains.

[Rule 62-4.070(3), F.A.C.]

19. Visible Emissions. The permittee shall have an initial and formal compliance test for visible emissions conducted during each federal fiscal year (October 1 - September 30).

[Rules 62-296.401(6)(j)1. and 62-297.310(7)(a)4.a., F.A.C.]

20. Visible Emissions. Compliance with the visible emissions limitation shall be determined by using DEP Method 9, incorporated in Chapter 62-297, F.A.C.

[Rules 62-296.401(6)(h)1. and 62-297.401(9)(c), F.A.C.]

21. Visible Emissions. The required minimum period of observation for an opacity compliance test shall be sixty (60) minutes. The opacity test observation period shall begin when incineration begins in the primary chamber.

[Rule 62-297.310(4)(a)2., F.A.C.]

22. Particulate Matter, Carbon Monoxide, and Oxygen. The permittee shall have an initial compliance test for particulate matter, carbon monoxide, and oxygen; after that, a compliance test shall be conducted prior to renewing the operation permit.

[Rules 62-296.401(6)(j)2. and 62-297.310(7)(a)3., F.A.C.]

23. Particulate Matter. Compliance with the particulate matter emission limitation shall be determined by using EPA Method 5, incorporated and adopted by reference in Chapter 62-297, F.A.C. The minimum sample volume shall be 30 dry standard cubic feet.
[Rule 62-296.401(6)(h)4.,F.A.C.]

24. Carbon Monoxide. Compliance with the carbon monoxide emission limitation shall be determined by using EPA Method 10, incorporated and adopted by reference in Chapter 62-297, F.A.C.
[Rule 62-296.401(6)(h)2.,F.A.C.]

25. Oxygen. The oxygen concentration shall be determined by using EPA Method 3, incorporated and adopted by reference in Chapter 62-297, F.A.C.
[Rule 62-296.401(6)(h)3.,F.A.C.]

26. Test procedures shall meet all applicable requirements of Chapter 62-297, F.A.C.
[Rule 62-296.401(6)(h)5.,F.A.C.]

27. Required Number of Test Runs. For mass emission limitations, a compliance test shall consist of three complete and separate determinations of the total air pollutant emission rate through the test section of the stack or duct and three complete and separate determinations of any applicable process variables corresponding to the three distinct time periods during which the stack emission rate was measured provided, however, that three complete and separate determinations shall not be required if the process variables are not subject to variation during a compliance test, or if three determinations are not necessary in order to calculate the unit's emission rate. The three required test runs shall be completed within one consecutive five day period. In the event that a sample is lost or one of the three runs must be discontinued because of circumstances beyond the control of the owner or operator, and a valid third run cannot be obtained within the five day period allowed for the test, the Secretary or his or her designee may accept the results of the two complete runs as proof of compliance, provided that the arithmetic mean of the results of the two complete runs is at least 20 percent below the allowable emission limiting standards.
[Rule 62-297.310(1), F.A.C.]

28. Operating Rate During Testing. Testing of emissions shall be conducted with each emissions unit operation at permitted capacity, which is defined as 90 to 100 percent of the maximum operation rate allowed by the permit. If it is impracticable to test at permitted capacity, an emissions unit may be tested at less than the minimum permitted capacity; in this case, subsequent emissions unit operation is limited to 110 percent of the test load until a new test is conducted. Once the emissions unit is so limited, operation at higher capacities is allowed for no more than 15 consecutive days for the purpose of additional compliance testing to regain the authority to operate at the permitted capacity.
[Rules 62-297.310(2) & (2)(a), F.A.C.]

29. Calculation of Emission Rate. The indicated emission rate or concentration shall be the arithmetic average of the emission rate or concentration determined by each of the separate test runs unless otherwise specified in a particular test method or applicable rule.
[Rule 62-297.310(3), F.A.C.]

30. Applicable Test Procedures.

(a) Required Sampling Time.

1. Unless otherwise specified in the applicable rule, the required sampling time for each test run shall be no less than one hour and no greater than four hours, and the sampling time at each sampling point shall be of equal intervals of at least two minutes.
2. Opacity Compliance Tests. When either EPA Method 9 or DEP Method 9 is specified as the applicable opacity test method, the required minimum period of observation for a compliance test shall be sixty (60) minutes for emissions units which emit or have the potential to emit 100 tons per year or more of particulate matter, and thirty (30) minutes for emissions units which have potential emissions less than 100 tons per year of particulate matter and are not subject to a multiple-valued opacity standard. The opacity test observation period shall include the period during which the highest opacity emissions can reasonably be expected to occur. Exceptions to these requirements are as follows:
 - c. The minimum observation period for opacity tests conducted by employees or agents of the Department to verify the day-to-day continuing compliance of a unit or activity with an applicable opacity standard shall be twelve minutes.

(b) Minimum Sample Volume. Unless otherwise specified in the applicable rule, the minimum sample volume per run shall be 25 dry standard cubic feet.

(d) Calibration of Sampling Equipment. Calibration of the sampling train equipment shall be conducted in accordance with the schedule shown in Table 297.310-1 (attached).

[Rule 62-297.310(4), F.A.C.]

31. Required Stack Sampling Facilities. When a mass emissions stack test is required, the permittee shall comply with the requirements contained in Appendix SS-1, Stack Sampling Facilities, attached to this permit.

[Rule 62-297.310(6), F.A.C.]

32. Frequency of Compliance Tests. The following provisions apply only to those emissions units that are subject to an emissions limiting standard for which compliance testing is required.

(a) General Compliance Testing.

3. The owner or operator of an emissions unit that is subject to any emission limiting standard shall conduct a compliance test that demonstrates compliance with the applicable emission limiting standard prior to obtaining a renewed operation permit. Emissions units that are required to conduct an annual compliance test may submit the most recent annual compliance test to satisfy the requirements of this provision. In renewing an air operation permit pursuant to Rule 62-210.300(2)(a)3.b., c., or d., F.A.C., the Department shall not require submission of emission compliance test results for any emissions unit that, during the year prior to renewal:
 - a. Did not operate; or,
 - b. In the case of a fuel burning emissions unit, burned liquid fuel for a total of no more than 400 hours.

4. During each federal fiscal year (October 1 - September 30), unless otherwise specified by rule, order, or permit, the owner or operator of each emissions unit shall have a formal compliance test conducted for:
 - a. Visible emissions, if there is an applicable standard;
 - b. Each of the following pollutants, if there is an applicable standard, and if the emissions unit emits or has the potential to 100 tons per year or more of any other regulated air pollutant
 9. The owner or operator shall notify the Department, at least 15 days prior to the date on which each formal compliance test is to begin, of the date, time, and place of each such test, and the test contact person who will be responsible for coordinating and having such test conducted for the owner or operator.
- (b) Special Compliance Tests. When the Department, after investigation, has good reason (such as complaints, increased visible emissions or questionable maintenance of control equipment) to believe that any applicable emission standard contained in a Department rule or in a permit issued pursuant to those rules is being violated, it may require the owner or operator of the emissions unit to conduct compliance tests which identify the nature and quantity of pollutant emissions from the emissions unit and to provide a report on the results of said tests to the Department.
- (c) Waiver of Compliance Test Requirements. If the owner or operator of an emissions unit that is subject to a compliance test requirement demonstrates to the Department, pursuant to the procedure established in Rule 62-297.620, F.A.C., that the compliance of the emissions unit with an applicable weight emission limiting standard can be adequately determined by means other than the designated test procedure, such as specifying a surrogate standard of no visible emissions for particulate matter sources equipped with a bag house or specifying a fuel analysis for sulfur dioxide emissions, the Department shall waive the compliance test requirements for such emissions units and order that the alternate means of determining compliance be used, provided, however, the provisions of Rule 62-297.310(7)(b), F.A.C., shall apply.

[Rule 62-297.310(7), F.A.C.; and, SIP approved]

33. Compliance Demonstration. Compliance with the carbon monoxide and particulate emission standards may be demonstrated by submission of a test report for an identical (same make, model, and permitted capacity) crematory unit operating in compliance with a valid Department air permit and tested pursuant to that permit. The test data in the test report must be less than five years old and may or may not be obtained from the unit that is being permitted.

[Rule 62-296.401(6)(k), F.A.C.]

Continuous Emissions Monitoring Requirements.

34. Continuous Emissions Monitoring Requirements. The permittee shall install, operate, and maintain on the animal crematory continuous monitors to record temperature at the point or beyond where 1.0 second gas retention time is obtained in the secondary combustion zone in accordance with the manufacturer's instructions. A complete file of all measurements, including continuous monitoring system, monitoring device, and performance testing measurements; all continuous monitoring system performance evaluations; all continuous monitoring system or monitoring device calibration checks; and adjustments, preventive maintenance, and corrective maintenance performed on these systems or devices, shall be recorded in a permanent legible form available for

inspection. Combustion temperature monitoring documentation shall include operator name, operator indication of when cremation in the primary chamber begins, date, time, and temperature markings. The file shall be retained for at least five years following the recording of such measurements, reports, and records.

[Rules 62-213.440 and 62-296.401(6)(l), F.A.C.]

Reports and Recordkeeping.

35. In the case of excess emissions resulting from malfunctions, each owner or operator shall notify the Department in accordance with Rule 62-4.130, F.A.C. A full written report on the malfunctions shall be submitted in a quarterly report, if requested by the Department.

[Rule 62-210.700(6), F.A.C.]

36. Test Reports.

- (a) The owner or operator of an emissions unit for which a compliance test is required shall file a report with the Department on the results of each such test.
- (b) The required test report shall be filed with the Department as soon as practical but no later than 45 days after the last sampling run of each test is completed.
- (c) The test report shall provide sufficient detail on the emissions unit tested and the test procedures used to allow the Department to determine if the test was properly conducted and the test results properly computed. As a minimum, the test report, other than for an EPA Method 9 test, shall provide the following information:
 1. The type, location, and designation of the emissions unit tested.
 2. The facility at which the emissions unit is located.
 3. The owner or operator of the emissions unit.
 4. The normal type and amount of fuels used and materials processed, and the types and amounts of fuels used and material processed during each test run.
 5. The means, raw data and computations used to determine the amount of fuels used and materials processed, if necessary to determine compliance with an applicable emission limiting standard.
 6. The type of air pollution control devices installed on the emissions unit, their general condition, their normal operating parameters (pressure drops, total operating current and GPM scrubber water), and their operating parameters during each test run.
 7. A sketch of the duct within 8 stack diameters upstream and 2 stack diameters downstream of the sampling ports, including the distance to any upstream and downstream bends or other flow disturbances.
 8. The date, starting time and duration of each sampling run.
 9. The test procedures used, including any alternative procedures authorized pursuant to Rule 62-297.620, F.A.C. Where optional procedures are authorized in this chapter, indicate which option was used.
 10. The number of points sampled and configuration and location of the sampling plane.
 11. For each sampling point for each run, the dry gas meter reading, velocity head, pressure drop across the stack, temperatures, average meter temperatures and sample time per point.
 12. The type, manufacturer and configuration of the sampling equipment used.
 13. Data related to the required calibration of the test equipment.
 14. Data on the identification, processing and weights of all filters used.

15. Data on the types and amounts of any chemical solutions used.
16. Data on the amount of pollutant collected from each sampling probe, the filters, and the impingers, are reported separately for the compliance test.
17. The names of individuals who furnished the process variable data, conducted the test, analyzed the samples and prepared the report.
18. All measured and calculated data required to be determined by each applicable test procedure for each run.
19. The detailed calculations for one run that relate the collected data to the calculated emission rate.
20. The applicable emission standard, and the resulting maximum allowable emission rate for the emissions unit, plus the test result in the same form and unit of measure.
21. A certification that, to the knowledge of the owner or his authorized agent, all data submitted are true and correct. When a compliance test is conducted for the Department or its agent, the person who conducts the test shall provide the certification with respect to the test procedures used. The owner or his authorized agent shall certify that all data required and provided to the person conducting the test are true and correct to his knowledge.

[Rule 62-297.310(8), F.A.C.]

APPENDIX TV-1, TITLE V CONDITIONS (version dated 12/02/97)

[Note: This attachment includes "canned conditions" developed from the "Title V Core List."]

{Permitting note: APPENDIX TV-1, TITLE V CONDITIONS, is distributed to the permittee only. Other persons requesting copies of these conditions shall be provided one copy when requested or otherwise appropriate.}

Chapter 62-4, F.A.C.

1. **Not federally enforceable. General Prohibition.** Any stationary installation which will reasonably be expected to be a source of pollution shall not be operated, maintained, or modified without the appropriate and valid permits issued by the Department, unless the source is exempted by Department rule. The Department may issue a permit only after it receives reasonable assurance that the installation will not cause pollution in violation of any of the provisions of Chapter 403, F.S., or the rules promulgated thereunder. A permitted installation may only be operated, maintained, constructed, expanded or modified in a manner that is consistent with the terms of the permit.

[Rule 62-4.030, Florida Administrative Code (F.A.C.); Section 403.087, Florida Statute (F.S.)]

2. **Not federally enforceable. Procedure to Obtain Permits: Application.**

(1) Any person desiring to obtain a permit from the Department shall apply on forms prescribed by the Department and shall submit such additional information as the Department by law may require.

(2) All applications and supporting documents shall be filed in quadruplicate with the Department.

(3) To ensure protection of public health, safety, and welfare, any construction, modification, or operation of an installation which may be a source of pollution shall be in accordance with sound professional engineering practices pursuant to Chapter 471, F.S. All applications for a Department permit shall be certified by a professional engineer registered in the State of Florida except when the application is for renewal of an air pollution operation permit at a minor facility as defined in Rule 62-210.200, F.A.C., or where professional engineering is not required by Chapter 471, F.S. Where required by Chapter 471 or 492, F.S., applicable portions of permit applications and supporting documents which are submitted to the Department for public record shall be signed and sealed by the professional(s) who prepared or approved them.

(4) Processing fees for air construction permits shall be in accordance with Rule 62-4.050(4), F.A.C.

(5)(a) To be considered by the Department, each application must be accompanied by the proper processing fee. The fee shall be paid by check, payable to the Department of Environmental Protection. The fee is non-refundable except as provided in Section 120.60, F.S., and in this section.

(c) Upon receipt of the proper application fee, the permit processing time requirements of Sections 120.60(2) and 403.0876, F.S., shall begin.

(d) If the applicant does not submit the required fee within ten days of receipt of written notification, the Department shall either return the unprocessed application or arrange with the applicant for the pick up of the application.

(e) If an applicant submits an application fee in excess of the required fee, the permit processing time requirements of Sections 120.60(2) and 403.0876, F.S., shall begin upon receipt, and the Department shall refund to the applicant the amount received in excess of the required fee.

(6) Any substantial modification to a complete application shall require an additional processing fee determined pursuant to the schedule set forth in Rule 62-4.050, F.A.C., and shall restart the time requirements of Sections 120.60 and 403.0876, F.S. For purposes of this Subsection, the term "substantial modification" shall mean a modification which is reasonably expected to lead to substantially different environmental impacts which require a detailed review.

(7) Modifications to existing permits proposed by the permittee which require substantial changes in the existing permit or require substantial evaluation by the Department of potential impacts of the proposed modifications shall require the same fee as a new application.

[Rule 62-4.050, F.A.C.]

3. **Standards for Issuing or Denying Permits.** Except as provided at Rule 62-213.460, F.A.C., the issuance of a permit does not relieve any person from complying with the requirements of Chapter 403, F.S., or Department rules.

[Rule 62-4.070(7), F.A.C.]

4. Modification of Permit Conditions.

(1) For good cause and after notice and an administrative hearing, if requested, the Department may require the permittee to conform to new or additional conditions. The Department shall allow the permittee a reasonable time to conform to the new or additional conditions and on application of the permittee the Department may grant additional time. For the purpose of this section, good cause shall include, but not be limited to, any of the following:

- (a) A showing that an improvement in effluent or emission quality or quantity can be accomplished because of technological advances without unreasonable hardship.
- (b) A showing that a higher degree of treatment is necessary to effect the intent and purpose of Chapter 403, F.S.
- (c) A showing of any change in the environment or surrounding conditions that requires a modification to conform to applicable air or water quality standards.
- (e) Adoption or revision of Florida Statutes, rules, or standards which require the modification of a permit condition for compliance.

(2) A permittee may request a modification of a permit by applying to the Department.

(3) A permittee may request that a permit be extended as a modification of the permit. Such a request must be submitted to the Department in writing before the expiration of the permit. Upon timely submittal of a request for extension, unless the permit automatically expires by statute or rule, the permit will remain in effect until final agency action is taken on the request. For construction permits, an extension shall be granted if the applicant can demonstrate reasonable assurances that, upon completion, the extended permit will comply with the standards and conditions required by applicable regulation. For all other permits, an extension shall be granted if the applicant can demonstrate reasonable assurances that the extended permit will comply with the standards and conditions applicable to the original permit. A permit for which the permit application fee was prorated in accordance with Rule 62-4.050(4)(1), F.A.C., shall not be extended. In no event shall a permit be extended or remain in effect longer than the time limits established by statute or rule.

[Rule 62-4.080, F.A.C.]

5. Renewals. Prior to one hundred eighty (180) days before the expiration of a permit issued pursuant to Chapter 62-213, F.A.C., the permittee shall apply for a renewal of a permit using forms incorporated by reference in the specific rule chapter for that kind of permit. A renewal application shall be timely and sufficient. If the application is submitted prior to 180 days before expiration of the permit, it will be considered timely and sufficient. If the renewal application is submitted at a later date, it will not be considered timely and sufficient unless it is submitted and made complete prior to the expiration of the operation permit. When the application for renewal is timely and sufficient, the existing permit shall remain in effect until the renewal application has been finally acted upon by the Department or, if there is court review of the Department's final agency action, until a later date is required by Section 120.60, F.S., provided that, for renewal of a permit issued pursuant to Chapter 62-213, F.A.C., the applicant complies with the requirements of Rules 62-213.420(1)(b)3. and 4., F.A.C.

[Rule 62-4.090(1), F.A.C.]

6. Suspension and Revocation.

(1) Permits shall be effective until suspended, revoked, surrendered, or expired and shall be subject to the provisions of Chapter 403, F.S., and rules of the Department.

(2) Failure to comply with pollution control laws and rules shall be grounds for suspension or revocation.

(3) A permit issued pursuant to Chapter 62-4, F.A.C., shall not become a vested property right in the permittee. The Department may revoke any permit issued by it if it finds that the permit holder or the permit holder's agent:

- (a) Submitted false or inaccurate information in application or operational reports.
- (b) Has violated law, Department orders, rules or permit conditions.
- (c) Has failed to submit operational reports or other information required by Department rules.
- (d) Has refused lawful inspection under Section 403.091, F.S.

[Rule 62-4.100, F.A.C.]

7. Not federally enforceable. Financial Responsibility. The Department may require an applicant to submit proof of financial responsibility and may require the applicant to post an appropriate bond to guarantee compliance with the law and Department rules.

[Rule 62-4.110, F.A.C.]

8. Transfer of Permits.

(1) Within 30 days after the sale or legal transfer of a permitted facility, an "Application for Transfer of Permit" (DEP Form 62-1.201(1)) must be submitted to the Department. This form must be completed with the notarized signatures of both the permittee and the proposed new permittee.

(2) The Department shall approve the transfer of a permit unless it determines that the proposed new permittee cannot provide reasonable assurances that conditions of the permit will be met. The determination shall be limited solely to the ability of the new permittee to comply with the conditions of the existing permit, and it shall not concern the adequacy of these permit conditions. If the Department proposes to deny the transfer, it shall provide both the permittee and the proposed new permittee a written objection to such transfer together with notice of a right to request a Chapter 120, F.S., proceeding on such determination.

(3) Within 30 days of receiving a properly completed Application for Transfer of Permit form, the Department shall issue a final determination. The Department may toll the time for making a determination on the transfer by notifying both the permittee and the proposed new permittee that additional information is required to adequately review the transfer request. Such notification shall be served within 30 days of receipt of an Application for Transfer of Permit form, completed pursuant to Rule 62-4.120(1), F.A.C. If the Department fails to take action to approve or deny the transfer within 30 days of receipt of the completed Application for Transfer of Permit form, or within 30 days of receipt of the last item of timely requested additional information, the transfer shall be deemed approved.

(4) The permittee is encouraged to apply for a permit transfer prior to the sale or legal transfer of a permitted facility. However, the transfer shall not be effective prior to the sale or legal transfer.

(5) Until this transfer is approved by the Department, the permittee and any other person constructing, operating, or maintaining the permitted facility shall be liable for compliance with the terms of the permit. The permittee transferring the permit shall remain liable for corrective actions that may be required as a result of any violations occurring prior to the sale or legal transfer of the facility.

[Rule 62-4.120, F.A.C.]

9. Plant Operation-Problems. If the permittee is temporarily unable to comply with any of the conditions of the permit due to breakdown of equipment or destruction by hazard of fire, wind or by other cause, the permittee shall immediately notify the Department. Notification shall include pertinent information as to the cause of the problem, and what steps are being taken to correct the problem and to prevent its recurrence, and where applicable, the owner's intent toward reconstruction of destroyed facilities. Such notification does not release the permittee from any liability for failure to comply with Department rules.

[Rule 62-4.130, F.A.C.]

10. For purposes of notification to the Department pursuant to Rule 62-4.130, F.A.C., Plant Operation-Problems, "immediately" shall mean the same day, if during a workday (i.e., 8:00 a.m. - 5:00 p.m.), or the first business day after the incident, excluding weekends and holidays.

[40 CFR 70.6(a)(3)(iii)(B)]

11. Not federally enforceable. Review. Failure to request a hearing within 14 days of receipt of notice of proposed or final agency action on a permit application or as otherwise required in Chapter 62-103, F.A.C., shall be deemed a waiver of the right to an administrative hearing.

[Rule 62-4.150, F.A.C.]

12. Permit Conditions. All permits issued by the Department shall include the following general conditions:

(1) The terms, conditions, requirements, limitations and restrictions set forth in this permit, are "permit conditions" and are binding and enforceable pursuant to Sections 403.141, 403.727, or 403.859 through 403.861, F.S. The permittee is placed on notice that the Department will review this permit periodically and may initiate enforcement action for any violation of these conditions.

(2) This permit is valid only for the specific processes and operations applied for and indicated in the approved drawings or exhibits. Any unauthorized deviation from the approved drawings, exhibits, specifications, or conditions of this permit may constitute grounds for revocation and enforcement action by the Department.

(3) As provided in subsections 403.087(6) and 403.722(5), F.S., the issuance of this permit does not convey any vested rights or any exclusive privileges. Neither does it authorize any injury to public or private property or any invasion of personal rights, nor any infringement of federal, state, or local laws or regulations. This permit is not a waiver of or approval of any other Department permit that may be required for other aspects of the total project which are not addressed in this permit.

- (4) This permit conveys no title to land or water, does not constitute State recognition or acknowledgment of title, and does not constitute authority for the use of submerged lands unless herein provided and the necessary title or leasehold interests have been obtained from the State. Only the Trustees of the Internal Improvement Trust Fund may express State opinion as to title.
- (5) This permit does not relieve the permittee from liability for harm or injury to human health or welfare, animal, or plant life, or property caused by the construction or operation of this permitted source, or from penalties therefore; nor does it allow the permittee to cause pollution in contravention of F.S. and Department rules, unless specifically authorized by an order from the Department.
- (6) The permittee shall properly operate and maintain the facility and systems of treatment and control (and related appurtenances) that are installed and used by the permittee to achieve compliance with the conditions of this permit, as required by Department rules. This provision includes the operation of backup or auxiliary facilities or similar systems when necessary to achieve compliance with the conditions of the permit and when required by Department rules.
- (7) The permittee, by accepting this permit, specifically agrees to allow authorized Department personnel, upon presentation of credentials or other documents as may be required by law and at reasonable times, access to the premises where the permitted activity is located or conducted to:
- (a) Have access to and copy any records that must be kept under conditions of the permit;
 - (b) Inspect the facility, equipment, practices, or operations regulated or required under this permit; and,
 - (c) Sample or monitor any substances or parameters at any location reasonable necessary to assure compliance with this permit or Department rules. Reasonable time may depend on the nature of the concern being investigated.
- (8) If, for any reason, the permittee does not comply with or will be unable to comply with any condition or limitation specified in this permit, the permittee shall immediately provide the Department with the following information:
- (a) A description of and cause of noncompliance; and,
 - (b) The period of noncompliance, including dates and times; or, if not corrected, the anticipated time the noncompliance is expected to continue, and steps being taken to reduce, eliminate, and prevent recurrence of the noncompliance. The permittee shall be responsible for any and all damages which may result and may be subject to enforcement action by the Department for penalties or for revocation of this permit.
- (9) In accepting this permit, the permittee understands and agrees that all records, notes, monitoring data and other information relating to the construction or operation of this permitted source which are submitted to the Department may be used by the Department as evidence in any enforcement case involving the permitted source arising under the F.S. or Department rules, except where such use is prescribed by Sections 403.111 and 403.73, F.S. Such evidence shall only be used to the extent it is consistent with the Florida Rules of Civil Procedure and appropriate evidentiary rules.
- (10) The permittee agrees to comply with changes in Department rules and F.S. after a reasonable time for compliance; provided, however, the permittee does not waive any other rights granted by F.S. or Department rules.
- (11) This permit is transferable only upon Department approval in accordance with Rule 62-4.120, F.A.C., as applicable. The permittee shall be liable for any non-compliance of the permitted activity until the transfer is approved by the Department.
- (12) This permit or a copy thereof shall be kept at the work site of the permitted activity.
- (14) The permittee shall comply with the following:
- (a) Upon request, the permittee shall furnish all records and plans required under Department rules. During enforcement actions, the retention period for all records will be extended automatically unless otherwise stipulated by the Department.
 - (b) The permittee shall hold at the facility or other location designated by this permit records of all monitoring information (including all calibration and maintenance records and all original strip chart recordings for continuous monitoring instrumentation) required by the permit, copies of all reports required by this permit, and records of all data used to complete the application for this permit. These materials shall be retained at least five (5) years from the date of the sample, measurement, report, or application unless otherwise specified by Department rule.
 - (c) Records of monitoring information shall include:
 - 1. the date, exact place, and time of sampling or measurements;
 - 2. the person responsible for performing the sampling or measurements;
 - 3. the dates analyses were performed;
 - 4. the person responsible for performing the analyses;
 - 5. the analytical techniques or methods used; and,
 - 6. the results of such analyses.
- (15) When requested by the Department, the permittee shall within a reasonable time furnish any information required by law which is needed to determine compliance with the permit. If the permittee becomes aware the relevant facts were not submitted or were incorrect in the permit application or in any report to the Department, such facts or information shall be corrected promptly.

[Rules 62-4.160 and 62-213.440(1)(b), F.A.C.]

13. Construction Permits.

(1) No person shall construct any installation or facility which will reasonably be expected to be a source of air or water pollution without first applying for and receiving a construction permit from the Department unless exempted by statute or Department rule. In addition to the requirements of Chapter 62-4, F.A.C., applicants for a Department Construction Permit shall submit the following as applicable:

- (a) A completed application on forms furnished by the Department.
- (b) An engineering report covering:
 - 1. plant description and operations,
 - 2. types and quantities of all waste material to be generated whether liquid, gaseous or solid,
 - 3. proposed waste control facilities,
 - 4. the treatment objectives,
 - 5. the design criteria on which the control facilities are based, and,
 - 6. other information deemed relevant.

Design criteria submitted pursuant to Rule 62-4.210(1)(b)5., F.A.C., shall be based on the results of laboratory and pilot-plant scale studies whenever such studies are warranted. The design efficiencies of the proposed waste treatment facilities and the quantities and types of pollutants in the treated effluents or emissions shall be indicated. Work of this nature shall be subject to the requirements of Chapter 471, F.S. Where confidential records are involved, certain information may be kept confidential pursuant to Section 403.111, F.S.

(c) The owners' written guarantee to meet the design criteria as accepted by the Department and to abide by Chapter 403, F.S. and the rules of the Department as to the quantities and types of materials to be discharge^d from the installation. The owner may be required to post an appropriate bond or other equivalent evidence of financial responsibility to guarantee compliance with such conditions in instances where the owner's financial resources are inadequate or proposed control facilities are experimental in nature.

- (2) The construction permit may contain conditions and an expiration date as determined by the Secretary or the Secretary's designee.
- (3) When the Department issues a permit to construct, the permittee shall be allowed a period of time, specified in the permit, to construct, and to operate and test to determine compliance with Chapter 403, F.S., and the rules of the Department and, where applicable, to apply for and receive an operation permit. The Department may require tests and evaluations of the treatment facilities by the permittee at his/her expense.

[Rule 62-4.210, F.A.C.]

14. Not federally enforceable. Operation Permit for New Sources. To properly apply for an operation permit for new sources, the applicant shall submit certification that construction was completed noting any deviations from the conditions in the construction permit and test results where appropriate.

[Rule 62-4.220, F.A.C.]

Chapter 62-103, F.A.C.

15. Public Notice, Public Participation, and Proposed Agency Action. The permittee shall comply with all of the requirements for public notice, public participation, and proposed agency action pursuant to Rule 62-103.150 and Rule 62-210.350, F.A.C.

[Rules 62-103.150, 62-210.350 and 62-213.430(1)(b), F.A.C.]

16. Administrative Hearing. The permittee shall comply with all of the requirements for a petition for administrative hearing or waiver of right to administrative proceeding pursuant to Rule 61-103.155, F.A.C.

[Rule 62-103.155, F.A.C.]

Chapter 62-204, F.A.C.

17. Asbestos. This permit does not authorize any demolition or renovation of the facility or its parts or components which involves asbestos removal. This permit does not constitute a waiver of any of the requirements of Chapter 62-257, F.A.C., and 40 CFR Part 61, Subpart M, National Emission Standard for Asbestos, adopted and incorporated by reference in Rule 62-204.800, F.A.C. Compliance with Chapter 62-257, F.A.C., and 40 CFR 61, Subpart M, Section 61.145, is required for any asbestos demolition or renovation at the source.

[40 CFR 61; Rule 62-204.800, F.A.C.; and, Chapter 62-257, F.A.C.]

Chapter 62-210, F.A.C.

18. Permits Required. The owner or operator of any emissions unit which emits or can reasonably be expected to emit any air pollutant shall obtain an appropriate permit from the Department prior to beginning construction, modification, or initial or continued operation of the emissions unit unless exempted pursuant to Department rule or statute. All emissions limitations, controls, and other requirements imposed by such permits shall be at least as stringent as any applicable limitations and requirements contained in or enforceable under the State Implementation Plan (SIP) or that are otherwise federally enforceable. Except as provided at Rule 62-213.460, F.A.C., issuance of a permit does not relieve the owner or operator of an emissions unit from complying with any applicable requirements, any emission limiting standards or other requirements of the air pollution rules of the Department or any other such requirements under federal, state, or local law.

(1) Air Construction Permits. An air construction permit shall be obtained by the owner or operator of any proposed new or modified facility or emissions unit prior to the beginning of construction or modification, in accordance with all applicable provisions of Chapters 62-210, 62-212 and 62-4, F.A.C. The construction permit shall be issued for a period of time sufficient to allow construction or modification of the facility or emissions unit and operation while the new or modified facility or emissions unit is conducting tests or otherwise demonstrating initial compliance with the conditions of the construction permit.

(2) Air Operation Permits. Upon expiration of the air operation permit for any existing facility or emissions unit, subsequent to construction or modification and demonstration of initial compliance with the conditions of the construction permit for any new or modified facility or emissions unit, or as otherwise provided in Chapter 62-210 or Chapter 62-213, the owner or operator of such facility or emissions unit shall obtain a renewal air operation permit, an initial air operation permit, or an administrative correction or revision of an existing air operation permit, whichever is appropriate, in accordance with all applicable provisions of Chapter 62-210, Chapter 62-213, and Chapter 62-4, F.A.C.

(a) Minimum Requirements for All Air Operation Permits. At a minimum, a permit issued pursuant to this subsection shall:

1. Specify the manner, nature, volume and frequency of the emissions permitted, and the applicable emission limiting standards or performance standards, if any;
2. Require proper operation and maintenance of any pollution control equipment by qualified personnel, where applicable in accordance with the provisions of any operation and maintenance plan required by the air pollution rules of the Department.
3. Contain an effective date stated in the permit which shall not be earlier than the date final action is taken on the application and be issued for a period, beginning on the effective date, as provided below.

a. The operation permit for an emissions unit which is in compliance with all applicable rules and in operational condition, and which the owner or operator intends to continue operating, shall be issued or renewed for a five-year period, except that, for Title V sources subject to Rule 62-213.420(1)(a)1., F.A.C., operation permits shall be extended until 60 days after the due date for submittal of the facility's Title V permit application as specified in Rule 62-213.420(1)(a)1., F.A.C.

b. Except as provided in Rule 62-210.300(2)(a)3.d., F.A.C., the operation permit for an emissions unit which has been shut down for six months or more prior to the expiration date of the current operation permit, shall be renewed for a period not to exceed five years from the date of shutdown, even if the emissions unit is not maintained in operational condition, provided:

- (i) the owner or operator of the emissions unit demonstrates to the Department that the emissions unit may need to be reactivated and used, or that it is the owner's or operator's intent to apply to the Department for a permit to construct a new emissions unit at the facility before the end of the extension period; and
- (ii) the owner or operator of the emissions unit agrees to and is legally prohibited from providing the allowable emission permitted by the renewed permit as an emissions offset to any other person under Rule 62-212.500, F.A.C.; and
- (iii) the emissions unit was operating in compliance with all applicable rules as of the time the source was shut down.

c. Except as provided in Rule 62-210.300(2)(a)3.d., F.A.C., the operation permit for an emissions unit which has been shut down for five years or more prior to the expiration date of the current operation permit shall be renewed for a maximum period not to exceed ten years from the date of shutdown, even if the emissions unit is not maintained in operational condition, provided the conditions given in Rule 62-210.300(2)(a)3.b., F.A.C., are met and the owner or operator demonstrates to the Department that failure to renew the permit would constitute a hardship, which may include economic hardship.

d. The operation permit for an electric utility generating unit on cold standby or long-term reserve shutdown shall be renewed for a five-year period, and additional five-year periods, even if the unit is not maintained in operational condition, provided the conditions given in Rules 62-210.300(2)(a)3.b.(i) through (iii), F.A.C., are met.

4. In the case of an emissions unit permitted pursuant to Rules 62-210.300(2)(a)3.b., c., and d., F.A.C., include reasonable notification and compliance testing requirements for reactivation of such emissions unit and provide that the owner or operator demonstrate to the Department prior to reactivation that such reactivation would not constitute reconstruction pursuant to Rule 62-204.800(7), F.A.C.

[Rules 62-210.300(1) & (2), F.A.C.]

19. Not federally enforceable. Notification of Startup. The owner or operator of any emissions unit or facility which has a valid air operation permit and which has been shut down more than one (1) year, shall notify the Department in writing of the intent to start up such emissions unit or facility, a minimum of sixty (60) days prior to the intended startup date.

(a) The notification shall include the planned startup date, anticipated emission rates or pollutants released, changes to processes or control devices which will result in changes to emission rates, and any other conditions which may differ from the valid outstanding operation permit.

(b) If, due to an emergency, a startup date is not known 60 days prior thereto, the owner shall notify the Department as soon as possible after the date of such startup is ascertained.

[Rule 62-210.300(5), F.A.C.]

20. Emissions Unit Reclassification.

(a) Any emissions unit whose operation permit has been revoked as provided for in Chapter 62-4, F.A.C., shall be deemed permanently shut down for purposes of Rule 62-212.500, F.A.C. Any emissions unit whose permit to operate has expired without timely renewal or transfer may be deemed permanently shut down, provided, however, that no such emissions unit shall be deemed permanently shut down if, within 20 days after receipt of written notice from the Department, the emissions unit owner or operator demonstrates that the permit expiration resulted from inadvertent failure to comply with the requirements of Rule 62-4.090, F.A.C., and that the owner or operator intends to continue the emissions unit in operation, and either submits an application for an air operation permit or complies with permit transfer requirements, if applicable.

(b) If the owner or operator of an emissions unit which is so permanently shut down, applies to the Department for a permit to reactivate or operate such emissions unit, the emissions unit will be reviewed and permitted as a new emissions unit.

[Rule 62-210.300(6), F.A.C.]

21. Public Notice and Comment.

(1) Public Notice of Proposed Agency Action.

(a) Notwithstanding any discretionary public notice requirements contained in Rule 62-103.150(2)(a), F.A.C., a notice of proposed agency action on permit application, where the proposed agency action is to issue the permit, shall be published by any applicant for:

1. An air construction permit;
2. An air operation permit, permit renewal or permit revision subject to Rule 62-210.300(2)(b), F.A.C., (i.e., a FESOP), except as provided in Rule 62-210.300(2)(b)1.b., F.A.C.; or
3. An air operation permit, permit renewal, or permit revision subject to Chapter 62-213, F.A.C., except those permit revisions meeting the requirements of Rule 62-213.412(1), F.A.C.

(b) The notice required by Rule 62-210.350(1)(a), F.A.C., shall be published in accordance with all otherwise applicable provisions of Rule 62-103.150, F.A.C.

(2) Additional Public Notice Requirements for Emissions Units Subject to Prevention of Significant Deterioration or Nonattainment-Area Preconstruction Review.

(a) Before taking final agency action on a construction permit application for any proposed new or modified facility or emissions unit subject to the preconstruction review requirements of Rule 62-212.400 or 62-212.500, F.A.C., the Department shall comply with all applicable provisions of Rule 62-103.150, F.A.C., and provide an opportunity for public comment which shall include as a minimum the following:

1. A complete file available for public inspection in at least one location in the district affected which includes the information submitted by the owner or operator, exclusive of confidential records under Section 403.111, F.S., and the Department's analysis of the effect of the proposed construction or modification on ambient air quality, including the Department's preliminary determination of whether the permit should be approved or disapproved;
2. A 30-day period for submittal of public comments; and,

3. A notice, by advertisement in a newspaper of general circulation in the county affected, specifying the nature and location of the proposed facility or emissions unit, whether BACT or LAER has been determined, the degree of PSD increment consumption expected, if applicable, and the location of the information specified in paragraph 1. above; and notifying the public of the opportunity for submitting comments and requesting a public hearing.
 - (b) The notice provided for in Rule 62-210.350(2)(a)3., F.A.C., shall be prepared by the Department and published by the applicant in accordance with all applicable provisions of Rule 62-103.150, F.A.C., except that the applicant shall cause the notice to be published no later than thirty (30) days prior to final agency action.
 - (c) A copy of the notice provided for in Rule 62-210.350(2)(a)3., F.A.C., shall also be sent by the Department to the Regional Office of the U. S. Environmental Protection Agency and to all other state and local officials or agencies having cognizance over the location of such new or modified facility or emissions unit, including local air pollution control agencies, chief executives of city or county government, regional land use planning agencies, and any other state, Federal Land Manager, or Indian Governing Body whose lands may be affected by emissions from the new or modified facility or emissions unit.
 - (d) A copy of the notice provided for in Rule 62-210.350(2)(a)3., F.A.C., shall be displayed in the appropriate district, branch and local program offices.
 - (e) An opportunity for public hearing shall be provided in accordance with Chapter 120, F.S., and Rule 62-103.150, F.A.C.
 - (f) Any public comments received shall be made available for public inspection in the location where the information specified in Rule 62-210.350(2)(a)1., F.A.C., is available and shall be considered by the Department in making a final determination to approve or deny the permit.
 - (g) The final determination shall be made available for public inspection at the same location where the information specified in Rule 62-210.350(2)(a)1., F.A.C., was made available.
 - (h) For a proposed new or modified emissions unit which would be located within 100 kilometers of any Federal Class I area or whose emissions may affect any Federal Class I area, and which would be subject to the preconstruction review requirements of Rule 62-212.400, F.A.C., or Rule 62-212.500, F.A.C.:
 1. The Department shall mail or transmit to the Administrator a copy of the initial application for an air construction permit and notice of every action related to the consideration of the permit application.
 2. The Department shall mail or transmit to the Federal Land Manager of each affected Class I area a copy of any written notice of intent to apply for an air construction permit; the initial application for an air construction permit, including all required analyses and demonstrations; any subsequently submitted information related to the application; the preliminary determination and notice of proposed agency action on the permit application; and any petition for an administrative hearing regarding the application or the Department's proposed action. Each such document shall be mailed or transmitted to the Federal Land Manager within fourteen (14) days after its receipt by the Department.
- (3) Additional Public Notice Requirements for Facilities Subject to Operation Permits for Title V Sources.
- (a) Before taking final agency action to issue a new, renewed, or revised air operation permit subject to Chapter 62-213, F.A.C., the Department shall comply with all applicable provisions of Rule 62-103.150, F.A.C., and provide an opportunity for public comment which shall include as a minimum the following:
 1. A complete file available for public inspection in at least one location in the district affected which includes the information submitted by the owner or operator, exclusive of confidential records under Section 403.111, F.S.; and,
 2. A 30-day period for submittal of public comments.
 - (b) The notice provided for in Rule 62-210.350(3)(a), F.A.C., shall be prepared by the Department and published by the applicant in accordance with all applicable provisions of Rule 62-103.150, F.A.C., except that the applicant shall cause the notice to be published no later than thirty (30) days prior to final agency action.
 - (c) The notice shall identify:
 1. The facility;
 2. The name and address of the office at which processing of the permit occurs;
 3. The activity or activities involved in the permit action;
 4. The emissions change involved in any permit revision;
 5. The name, address, and telephone number of a Department representative from whom interested persons may obtain additional information, including copies of the permit draft, the application, and all relevant supporting materials, including any permit application, compliance plan, permit, monitoring report, and compliance statement required pursuant to Chapter 62-213, F.A.C. (except for information entitled to confidential treatment pursuant to Section 403.111, F.S.), and all other materials available to the Department that are relevant to the permit decision;
 6. A brief description of the comment procedures required by Rules 62-103.150 and 62-210.350(3), F.A.C.;
 7. The time and place of any hearing that may be held, including a statement of procedure to request a hearing (unless a hearing has already been scheduled); and,

APPENDIX TV-1, TITLE V CONDITIONS (version dated 12/02/97) (continued)

8. The procedures by which persons may petition the Administrator to object to the issuance of the proposed permit after expiration of the Administrator's 45-day review period.

[Rule 62-210.350, F.A.C.]

22. Administrative Permit Corrections.

(1) A facility owner shall notify the Department by letter of minor corrections to information contained in a permit. Such notifications shall include:

- (a) Typographical errors noted in the permit;
- (b) Name, address or phone number change from that in the permit;
- (c) Any other similar minor administrative change at the source; and,
- (d) A change requiring more frequent monitoring or reporting by the permittee.
- (e) Changes listed at 40 CFR 72.83(a)(1), (2), (6), (9) and (10), hereby adopted and incorporated by reference, to Title V sources subject to emissions limitations or reductions pursuant to 42 USC ss. 7651-7651o;
- (f) Changes listed at 40 CFR 72.83(a)(11), hereby adopted and incorporated by reference, to Title V sources subject to emissions limitations or reductions pursuant to 42 USC ss. 7651-7651o, provided the notification is accompanied by a copy of any EPA determination concerning the similarity of the change to those listed at Rule 17-210.360(1)(e).

(2) Upon receipt of such notifications the Department shall within 60 days correct the permit and provide a corrected copy to the owner.

(3) For facilities subject to Chapter 62-213, F.A.C., a copy shall be provided to EPA and any approved local air program in the county where the facility or any part of the facility is located.

(4) The Department shall incorporate requirements resulting from issuance of new or revised construction permits into existing operation permits issued pursuant to Chapter 62-213, F.A.C., if the construction permit revisions incorporate requirements of federally enforceable preconstruction review and if the applicant requests at the time of application that all of the requirements of Rule 62-213.430(1), F.A.C., be complied with in conjunction with the processing of the construction permit application.

[Rule 62-210.360, F.A.C.]

23. Reports.

(3) Annual Operating Report for Air Pollutant Emitting Facility.

(a) The Annual Operating Report for Air Pollutant Emitting Facility (DEP Form No. 62-210.900(5)) shall be completed each year.

(c) The annual operating report shall be submitted to the appropriate Department District or Department approved local air pollution control program office by March 1 of the following year unless otherwise indicated by permit condition or Department request.

[Rule 62-210.370(3), F.A.C.]

24. Circumvention. No person shall circumvent any air pollution control device, or allow the emission of air pollutants without the applicable air pollution control device operating properly.

[Rule 62-210.650, F.A.C.]

25. Forms and Instructions. The forms used by the Department in the stationary source control program are adopted and incorporated by reference in this section. The forms are listed by rule number, which is also the form number, with the subject, title and effective date. Copies of forms may be obtained by writing to the Department of Environmental Protection, Division of Air Resources Management, 2600 Blair Stone Road, Tallahassee, Florida 32399-2400.

(1) Application for Air Permit - Long Form, Form and Instructions.

- (a) Acid Rain Part (Phase II), Form and Instructions.
 - 1. Repowering Extension Plan, Form and Instructions.
 - 2. New Unit Exemption, Form and Instructions.
 - 3. Retired Unit Exemption, Form and Instructions.

(b) Reserved.

(5) Annual Operating Report (AOR) for Air Pollutant Emitting Facility, Form and Instructions.

[Rule 62-210.900, F.A.C.]

Chapter 62-213, F.A.C.

26. Annual Emissions Fee. Each Title V source permitted to operate in Florida must pay between January 15 and March 1 of each year, upon written notice from the Department, an annual emissions fee in accordance with Rule 62-213.205, F.A.C., and the appropriate form and associated instructions.

[Rules 62-213.205 and 62-213.900(1), F.A.C.]

27. Annual Emissions Fee. Failure to pay timely any required annual emissions fee, penalty, or interest constitutes grounds for permit revocation pursuant to Rule 62-4.100, F.A.C.

[Rule 62-213.205(1)(g), F.A.C.]

28. Annual Emissions Fee. Any documentation of actual hours of operation, actual material or heat input, actual production amount, or actual emissions used to calculate the annual emissions fee shall be retained by the owner for a minimum of five (5) years and shall be made available to the Department upon request.

[Rule 62-213.205(1)(j), F.A.C.]

29. Annual Emissions Fee. DEP Form 62-213.900(1), F.A.C., "Major Air Pollution Source Annual Emissions Fee Form", must be completed by the permittee and submitted with the annual emissions fee.

[Rule 62-213.205(4), F.A.C.]

30. Air Operation Permit Fees. After December 31, 1992, no permit application processing fee, renewal fee, modification fee or amendment fee is required for an operation permit for a Title V source.

[Rule 62-213.205(5), F.A.C.]

31. Permits and Permit Revisions Required. All Title V sources are subject to the permit requirements of Chapter 62-213, F.A.C.

[Rule 62-213.400, F.A.C.]

32. No Title V source may operate except in compliance with Chapter 62-213, F.A.C.

[Rule 62-213.400(1), F.A.C.]

33. Changes Without Permit Revision. Title V sources having a valid permit issued pursuant to Chapter 62-213, F.A.C., may make the following changes without permit revision, provided that sources shall maintain source logs or records to verify periods of operation in each alternative method of operation:

(1) Permitted sources may change among those alternative methods of operation allowed by the source's permit as provided by the terms of the permit;

(2) Permitted sources may implement the terms or conditions of a new or revised construction permit if;

(a) The application for construction permit complied with the requirements of Rule 62-213.420(3) and (4), F.A.C.;

(b) The terms or conditions were subject to federally enforceable preconstruction review pursuant to Chapter 62-212, F.A.C.; and,

(c) The new or revised construction permit was issued after the Department and the applicant complied with all the requirements of Rule 62-213.430(1), F.A.C.;

(3) A permitted source may implement operating changes after the source submits any forms required by any applicable requirement and provides the Department and EPA with at least 7 days written notice prior to implementation. The source and the Department shall attach each notice to the relevant permit;

(a) The written notice shall include the date on which the change will occur, and a description of the change within the permitted source, the pollutants emitted and any change in emissions, and any term or condition becoming applicable or no longer applicable as a result of the change;

(b) The permit shield described in Rule 62-213.460, F.A.C., shall not apply to such changes;

(4) Permitted sources may implement changes involving modes of operation only in accordance with Rule 62-213.415, F.A.C.

[Rule 62-213.410, F.A.C.]

34. Immediate Implementation Pending Revision Process.

(1) Those permitted Title V sources making any change that constitutes a modification pursuant to paragraph (a) of the definition of modification at Rule 62-210.200, F.A.C., but which would not constitute a modification pursuant to paragraph (b) of the same definition, may implement such change prior to final issuance of a permit revision in accordance with Rule 62-213.412, F.A.C., provided the change:

- (a) Does not violate any applicable requirement;
- (b) Does not contravene any permit term or condition for monitoring, testing, recordkeeping or reporting, or any compliance certification requirement;
- (c) Does not require or change a case-by-case determination of an emission limitation or other standard, or a source-specific determination of ambient impacts, or a visibility or increment analysis under the provisions of Chapter 62-212 or 62-296, F.A.C.;
- (d) Does not seek to establish or change a permit term or condition for which there is no corresponding underlying applicable requirement and that the source has assumed to avoid an applicable requirement to which the source would otherwise be subject including any federally enforceable emissions cap or federally enforceable alternative emissions limit.

(2) A Title V source may immediately implement such changes after they have been incorporated into the terms and conditions of a new or revised construction permit issued pursuant to Chapter 62-212, F.A.C., and after the source provides to EPA, the Department, each affected state and any approved local air program having geographic jurisdiction over the source, a copy of the source's application for operation permit revision. The Title V source may conform its application for construction permit to include all information required by Rule 62-213.420, F.A.C., in lieu of submitting separate application forms.

(3) The Department shall process the application for operation permit revision in accordance with the provisions of Chapter 62-213, F.A.C., except that the Department shall issue a draft permit revision or a determination to deny the revision within 60 days of receipt of a complete application for operation permit revision or, if the Title V source has submitted a construction permit application conforming to the requirements of Rule 62-213.420, F.A.C., the Department shall issue a draft permit or a determination to deny the revision at the same time the Department issues its determination on issuance or denial of the construction permit application. The Department shall not take final action until all the requirements of Rule 62-213.430(1)(a), (c), (d), and (e), F.A.C., have been complied with.

(4) Pending final action on the operation permit revision application, the source shall implement the changes in accordance with the terms and conditions of the source's new or revised construction permit.

(5) The permit shield described in Rule 62-213.460, F.A.C., shall not apply to such changes until after the Department takes final action to issue the operation permit revision.

(6) If the Department denies the source's application for operation permit revision, the source shall cease implementation of the proposed changes.

[Rule 62-213.412, F.A.C.]

35. Permit Applications.

(1) Duty to Apply. For each Title V source, the owner or operator shall submit a timely and complete permit application in compliance with the requirements of Rules 62-213.420, 62-4050(1) & (2), and 62-210.900, F.A.C.

(a) Timely Application.

3. For purposes of permit renewal, a timely application is one that is submitted in accordance with Rule 62-4.090, F.A.C.

(b) Complete Application.

1. Any applicant for a Title V permit, permit revision or permit renewal must submit an application on DEP Form No. 62-210.900(1), which must include all the information specified by Rule 62-213.420(3), F.A.C., except that an application for permit revision must contain only that information related to the proposed change. The applicant shall include information concerning fugitive emissions and stack emissions in the application. Each application for permit, permit revision or permit renewal shall be certified by a responsible official in accordance with Rule 62-213.420(4), F.A.C.

2. For those applicants submitting initial permit applications pursuant to Rule 62-213.420(1)(a)1., F.A.C., a complete application shall be an application that substantially addresses all the information required by the application form number 62-210.900(1), and such applications shall be deemed complete within sixty days of receipt of a signed and certified application unless the Department notifies the applicant of incompleteness within that time. For all other applicants, the applications shall be deemed complete sixty days after receipt, unless the Department, within sixty days after receipt of a signed application for permit, permit revision or permit renewal, requests additional documentation or information needed to process the application. An applicant making timely and complete application for permit, or timely application for permit renewal as described by Rule 62-4.090(1), F.A.C., shall continue to operate the source

under the authority and provisions of any existing valid permit or Florida Electrical Power Plant Siting Certification, provided the applicant complies with all the provisions of Rules 62-213.420(1)(b)3. and 4. F.A.C. Failure of the Department to request additional information within sixty days of receipt of a properly signed application shall not impair the Department's ability to request additional information pursuant to Rules 62-213.420(1)(b)3. and 4., F.A.C.

3. For those permit applications submitted pursuant to the provisions of Rule 62-213.420(1)(a)1., F.A.C., the Department shall notify the applicant if the Department becomes aware at any time during processing of the application that the application contains incorrect or incomplete information. The applicant shall submit the corrected or supplementary information to the Department within ninety days unless the applicant has requested and been granted additional time to submit the information. Failure of an applicant to submit corrected or supplementary information requested by the Department within ninety days or such additional time as requested and granted shall render the application incomplete.

4. For all applications other than those addressed at Rule 62-213.420(1)(b)3., F.A.C., should the Department become aware, during processing of any application that the application contains incorrect information, or should the Department become aware, as a result of comment from an affected State, an approved local air program, EPA, or the public that additional information is needed to evaluate the application, the Department shall notify the applicant within 30 days. When an applicant becomes aware that an application contains incorrect or incomplete information, the applicant shall submit the corrected or supplementary information to the Department. If the Department notifies an applicant that corrected or supplementary information is necessary to process the permit, and requests a response, the applicant shall provide the information to the Department within ninety days of the Department request unless the applicant has requested and been granted additional time to submit the information or, the applicant shall, within ninety days, submit a written request that the Department process the application without the information. Failure of an applicant to submit corrected or supplementary information requested by the Department within ninety days, or such additional time as requested and granted, or to demand in writing within ninety days that the application be processed without the information shall render the application incomplete. Nothing in this section shall limit any other remedies available to the Department.

[Rules 62-213.420(1)(a)3. and 62-213.420(1)(b)1., 2., 3. & 4., F.A.C.]

36. Confidential Information. Whenever an applicant submits information under a claim of confidentiality pursuant to Section 403.111, F.S., the applicant shall also submit a copy of all such information and claim directly to EPA.

[Rule 62-213.420(2), F.A.C.]

37. Standard Application Form and Required Information. Applications shall be submitted under Chapter 62-213, F.A.C., on forms provided by the Department and adopted by reference in Rule 62-210.900(1), F.A.C. The information as described in Rule 62-210.900(1), F.A.C., shall be included for the Title V source and each emissions unit. An application must include information sufficient to determine all applicable requirements for the Title V source and each emissions unit and to evaluate a fee amount pursuant to Rule 62-213.205, F.A.C.

[Rule 62-213.420(3), F.A.C.]

38. Certification by Responsible Official (RO). In addition to the professional engineering certification required for applications by Rule 62-4.050(3), F.A.C., any application form, report, compliance statement, compliance plan and compliance schedule submitted pursuant to Chapter 62-213, F.A.C., shall contain a certification signed by a responsible official that, based on information and belief formed after reasonable inquiry, the statements and information in the document are true, accurate, and complete.

[Rule 62-213.420(4), F.A.C.]

39. a. Permit Renewal and Expiration. Permits being renewed are subject to the same requirements that apply to permit issuance at the time of application for renewal. Permit renewal applications shall contain that information identified in Rules 62-210.900(1) and 62-213.420(3), F.A.C. Unless a Title V source submits a timely application for permit renewal in accordance with the requirements of Rule 62-4.090(1), F.A.C., the existing permit shall expire and the source's right to operate shall terminate.

b. Permit Revision Procedures. Permit revisions shall meet all requirements of Chapter 62-213, F.A.C., including those for content of applications, public participation, review by approved local programs and affected states, and review by EPA, as they apply to permit issuance and renewal, except that permit revisions for those activities implemented pursuant to Rule 62-213.412, F.A.C., need not meet the requirements of Rule 62-213.430(1)(b), F.A.C. The Department shall require permit revision in accordance with the provisions of Rule 62-4.080, F.A.C., and 40 CFR 70.7(f), whenever any source becomes

subject to any condition listed at 40 CFR 70.7(f)(1), hereby adopted and incorporated by reference. The below requirements from 40 CFR 70.7(f) are adopted and incorporated by reference in Rule 62-213.430(4), F.A.C.:

o 40 CFR 70.7(f): Reopening for Cause.

(1) This section contains provisions from 40 CFR 70.7(f) that specify the conditions under which a Title V permit shall be reopened prior to the expiration of the permit. A Title V permit shall be reopened and revised under any of the following circumstances:

- (i) Additional applicable requirements under the Act become applicable to a major Part 70 source with a remaining permit term of 3 or more years. Such a reopening shall be completed not later than 18 months after promulgation of the applicable requirement. No such reopening is required if the effective date of the requirement is later than the date on which the permit is due to expire, unless the original permit or any of its terms and conditions has been extended pursuant to 40 CFR 70.4(b)(10)(i) or (ii).
- (ii) Additional requirements (including excess emissions requirements) become applicable to an affected source under the acid rain program. Upon approved by the Administrator, excess emissions offset plans shall be deemed to be incorporated into the permit.
- (iii) The permitting authority or EPA determines that the permit contains a material mistake or that inaccurate statements were made in establishing the emissions standards or other terms or conditions of the permit.
- (iv) The Administrator or the permitting authority determines that the permit must be revised or revoked to assure compliance with the applicable requirements.

(2) Proceedings to reopen and issue a permit shall follow the same procedures as apply to initial permit issuance and shall affect only those parts of the permit for which cause to reopen exists. Such reopening shall be made as expeditiously as practicable.

(3) Reopenings under 40 CFR 70.7(f)(1) shall not be initiated before a notice of such intent is provided to the Part 70 source by the permitting authority at least 30 days in advance of the date that the permit is to be reopened, except that the permitting authority may provide a shorter time period in the case of an emergency.

[Rules 62-213.430(3) & (4), F.A.C.; and, 40 CFR 70.7(f)]

40. Insignificant Emissions Units or Pollutant-Emitting Activities.

(a) All requests for determination of insignificant emissions units or activities made pursuant to Rule 62-213.420(3)(c), F.A.C., shall be processed in conjunction with the permit, permit renewal or permit revision application submitted pursuant to Chapter 62-213, F.A.C. Insignificant emissions units or activities shall be approved by the Department consistent with the provisions of Rule 62-4.040(1)(b), F.A.C. Emissions units or activities which are added to a Title V source after issuance of a permit under Chapter 62-213, F.A.C., shall be incorporated into the permit at its next renewal, provided such emissions units or activities have been exempted from the requirement to obtain an air construction permit and also qualify as insignificant pursuant to Rule 62-213.430(6), F.A.C.

(b) An emissions unit or activity shall be considered insignificant if:

- 1. Such unit or activity would be subject to no unit-specific applicable requirement;
- 2. Such unit or activity, in combination with other units or activities proposed as insignificant, would not cause the facility to exceed any major source threshold(s) as defined in Rule 62-213.420(3)(c)1., F.A.C., unless it is acknowledged in the permit application that such units or activities would cause the facility to exceed such threshold(s); and
- 3. Such unit or activity would not emit or have the potential to emit:
 - a. 500 pounds per year or more of lead and lead compounds expressed as lead;
 - b. 1,000 pounds per year or more of any hazardous air pollutant;
 - c. 2,500 pounds per year or more of total hazardous air pollutants; or
 - d. 5.0 tons per year or more of any other regulated pollutant.

[Rule 62-213.430(6), F.A.C.]

41. Permit Duration. Operation permits for Title V sources may not be extended as provided in Rule 62-4.080(3), F.A.C. if such extension will result in a permit term greater than five (5) years.

[Rule 62-213.440(1)(a), F.A.C.]

42. Monitoring Information. All records of monitoring information shall specify the date, place, and time of sampling or measurement and the operating conditions at the time of sampling or measurement, the date(s) analyses were performed, the company or entity that performed the analyses, the analytical techniques or methods used, and the results of such analyses.

[Rule 62-213.440(1)(b)2.a., F.A.C.]

APPENDIX TV-1, TITLE V CONDITIONS (version dated 12/02/97) (continued)

43. Retention of Records. Retention of records of all monitoring data and support information shall be for a period of at least 5 years from the date of the monitoring sample, measurement, report, or application. Support information includes all calibration and maintenance records and all original strip-chart recordings for continuous monitoring instrumentation, and copies of all reports required by the permit.

[Rule 62-213.440(1)(b)2.b., F.A.C.]

44. Monitoring Reports. The permittee shall submit reports of any required monitoring at least every six (6) months. All instances of deviations from permit requirements must be clearly identified in such reports.

[Rule 62-213.440(1)(b)3.a., F.A.C.]

45. Deviation from Permit Requirements Reports. The permittee shall report in accordance with the requirements of Rules 62-210.700(6) and 62-4.130, F.A.C., any deviations from permit requirements, including those attributable to upset conditions as defined in the permit. Reports shall include the probable cause of such deviations, and any corrective actions or preventive measures taken.

[Rule 62-213.440(1)(b)3.b., F.A.C.]

46. Reports. All reports shall be accompanied by a certification by a responsible official, pursuant to Rule 62-213.420(4), F.A.C.

[Rule 62-213.440(1)(b)3.c., F.A.C.]

47. If any portion of the final permit is invalidated, the remainder of the permit shall remain in effect.

[Rule 62-213.440(1)(d)1., F.A.C.]

48. It shall not be a defense for a permittee in an enforcement action that maintaining compliance with any permit condition would necessitate halting of or reduction of the source activity.

[Rule 62-213.440(1)(d)3., F.A.C.]

49. A Title V source shall comply with all the terms and conditions of the existing permit until the Department has taken final action on any permit renewal or any requested permit revision, except as provided at Rule 62-213.412(2), F.A.C.

[Rule 62-213.440(1)(d)4., F.A.C.]

50. A situation arising from sudden and unforeseeable events beyond the control of the source which causes an exceedance of a technology-based emissions limitation because of unavoidable increases in emissions attributable to the situation and which requires immediate corrective action to restore normal operation, shall be an affirmative defense to an enforcement action in accordance with the provisions and requirements of 40 CFR 70.6(g)(2) and (3), hereby adopted and incorporated by reference.

[Rule 62-213.440(1)(d)5., F.A.C.]

51. Confidentiality Claims. Any permittee may claim confidentiality of any data or other information by complying with Rule 62-213.420(2), F.A.C.

[Rule 62-213.440(1)(d)6., F.A.C.]

52. Statement of Compliance. The permittee shall submit a statement of compliance with all terms and conditions of the permit. Such statement shall be submitted to the Department and EPA annually, or more frequently if specified by Rule 62-213.440(2), F.A.C., or by any other applicable requirement. The statement of compliance shall include the identity of each term or condition of the permit for which each unit has remained in compliance during the period covered by the statement. The statement shall include identification of all methods used to demonstrate compliance and identification of each term or condition of the permit for which any unit has not remained in compliance during the period covered by the statement. For each term or condition for which the source has not remained in compliance during the period covered by the statement, the statement shall also identify each unit not in compliance and each term and condition with which the unit was not in compliance and state the inclusive dates that the source was not in compliance, the actions taken to achieve compliance and the method used to demonstrate compliance. Such statement shall be accompanied by a certification by a responsible official, in accordance with Rule 62-213.420(4), F.A.C.

[Rule 62-213.440(3), F.A.C.]

APPENDIX TV-1, TITLE V CONDITIONS (version dated 12/02/97) (continued)

53. Permit Shield. Except as provided in Chapter 62-213, F.A.C., compliance with the terms and conditions of a permit issued pursuant to Chapter 62-213, F.A.C., shall be deemed compliance with any applicable requirements in effect as of the date of permit issuance, provided that the source included such applicable requirements in the permit application. Nothing in Rule 62-213.460, F.A.C., or in any permit shall alter or affect the ability of EPA or the Department to deal with an emergency, the liability of an owner or operator of a source for any violation of applicable requirements prior to or at the time of permit issuance, or the requirements of the Federal Acid Rain Program.
[Rule 62-213.460, F.A.C.]

54. Forms and Instructions. The forms used by the Department in the Title V source operation program are adopted and incorporated by reference in Rule 62-213.900, F.A.C. The form is listed by rule number, which is also the form number, and with the subject, title, and effective date. Copies of forms may be obtained by writing to the Department of Environmental Protection, Division of Air Resources Management, 2600 Blair Stone Road, Tallahassee, Florida 32399-2400, or by contacting the appropriate permitting authority.

(1) Major Air Pollution Source Annual Emissions Fee (AEF) Form.
[Rule 62-213.900(1), F.A.C.]

Chapter 62-256, F.A.C.

55. Not federally enforceable. Open Burning. This permit does not authorize any open burning nor does it constitute any waiver of the requirements of Chapter 62-256, F.A.C. Source shall comply with Chapter 62-256, F.A.C., for any open burning at the source.

[Chapter 62-256, F.A.C.]

Chapter 62-281, F.A.C.

56. Refrigerant Requirements. Any facility having refrigeration equipment, including air conditioning equipment, which uses a Class I or II substance (listed at 40 CFR 82, Subpart A, Appendices A and B), and any facility which maintains, services, or repairs motor vehicles using a Class I or Class II substance as refrigerant must comply with all requirements of 40 CFR 82, Subparts B and F, and with Rule 62-281.100, F.A.C. Those requirements include the following restrictions:

- (1) Any facility having any refrigeration equipment normally containing 50 (fifty) pounds of refrigerant, or more, must keep servicing records documenting the date and type of all service and the quantity of any refrigerant added pursuant to 40 CFR 82.166;
 - (2) No person repairing or servicing a motor vehicle may perform any service on a motor vehicle air conditioner (MVAC) involving the refrigerant for such air conditioner unless the person has been properly trained and certified as provided at 40 CFR 82.34 and 40 CFR 82.40, and properly uses equipment approved pursuant to 40 CFR 82.36 and 40 CFR 82.38, and complies with 40 CFR 82.42;
 - (3) No person may sell or distribute, or offer for sale or distribution, any substance listed as a Class I or Class II substance at 40 CFR 82, Subpart A, Appendices A and B, except in compliance with Rule 62-281.100, F.A.C., and 40 CFR 82.34(b), 40 CFR 82.42, and/or 40 CFR 82.166;
 - (4) No person maintaining, servicing, repairing, or disposing of appliances may knowingly vent or otherwise release into the atmosphere any Class I or Class II substance used as a refrigerant in such equipment and no other person may open appliances (except MVACs as defined at 40 CFR 82.152) for service, maintenance or repair unless the person has been properly trained and certified pursuant to 40 CFR 82.161 and unless the person uses equipment certified for that type of appliance pursuant to 40 CFR 82.158 and unless the person observes the practices set forth at 40 CFR 82.156 and 40 CFR 82.166;
 - (5) No person may dispose of appliances (except small appliances, as defined at 40 CFR 82.152) without using equipment certified for that type of appliance pursuant to 40 CFR 82.158 and without observing the practices set forth at 40 CFR 82.156 and 40 CFR 82.166;
 - (6) No person may recover refrigerant from small appliances, MVACs and MVAC-like appliances (as defined at 40 CFR 82.152), except in compliance with the requirements of 40 CFR 82, Subpart F.
- [40 CFR 82; and, Chapter 62-281, F.A.C. (Chapter 62-281, F.A.C., is not federally enforceable)]

Chapter 62-296. F.A.C.

57. Not federally enforceable until SIP approved. Industrial, Commercial, and Municipal Open Burning Prohibited. Open burning in connection with industrial, commercial, or municipal operations is prohibited, except when:

- (a) Open burning is determined by the Department to be the only feasible method of operation and is authorized by an air permit issued pursuant to Chapter 62-210 or 62-213, F.A.C.; or
- (b) An emergency exists which requires immediate action to protect human health and safety; or
- (c) A county or municipality would use a portable air curtain incinerator to burn yard trash generated by a hurricane, tornado, fire or other disaster and the air curtain incinerator would otherwise be operated in accordance with the permitting exemption criteria of Rule 62-210.300(3), F.A.C.

[Rule 62-296.320(3), F.A.C.]

58. Unconfined Emissions of Particulate Matter.

(4)(c)1. No person shall cause, let, permit, suffer or allow the emissions of unconfined particulate matter from any emissions unit whatsoever, including, but not limited to, vehicular movement, transportation of materials, construction, alteration, demolition or wrecking, or industrially related activities such as loading, unloading, storing or handling, without taking reasonable precautions to prevent such emission.

3. Reasonable precautions may include, but shall not be limited to the following:

- a. Paving and maintenance of roads, parking areas and yards.
- b. Application of water or chemicals to control emissions from such activities as demolition of buildings, grading roads, construction, and land clearing.
- c. Application of asphalt, water, oil, chemicals or other dust suppressants to unpaved roads, yards, open stock piles and similar emissions units.
- d. Removal of particulate matter from roads and other paved areas under the control of the owner or operator of the emissions unit to prevent reentrainment, and from buildings or work areas to prevent particulate from becoming airborne.
- e. Landscaping or planting of vegetation.
- f. Use of hoods, fans, filters, and similar equipment to contain, capture and/or vent particulate matter.
- g. Confining abrasive blasting where possible.
- h. Enclosure or covering of conveyor systems.

4. In determining what constitutes reasonable precautions for a particular facility, the Department shall consider the cost of the control technique or work practice, the environmental impacts of the technique or practice, and the degree of reduction of emissions expected from a particular technique or practice.

[Rules 62-296.320(4)(c)1., 3., & 4. F.A.C.]

[electronic file name: tv-1.doc]

APPENDIX SS-1, STACK SAMPLING FACILITIES (version dated 10/07/96)

Stack Sampling Facilities Provided by the Owner of an Emissions Unit. This section describes the minimum requirements for stack sampling facilities that are necessary to sample point emissions units. Sampling facilities include sampling ports, work platforms, access to work platforms, electrical power, and sampling equipment support. Emissions units must provide these facilities at their expense. All stack sampling facilities must meet any Occupational Safety and Health Administration (OSHA) Safety and Health Standards described in 29 CFR Part 1910, Subparts D and E.

(a) Permanent Test Facilities. The owner or operator of an emissions unit for which a compliance test, other than a visible emissions test, is required on at least an annual basis, shall install and maintain permanent stack sampling facilities.

(b) Temporary Test Facilities. The owner or operator of an emissions unit that is not required to conduct a compliance test on at least an annual basis may use permanent or temporary stack sampling facilities. If the owner chooses to use temporary sampling facilities on an emissions unit, and the Department elects to test the unit, such temporary facilities shall be installed on the emissions unit within 5 days of a request by the Department and remain on the emissions unit until the test is completed.

(c) Sampling Ports.

1. All sampling ports shall have a minimum inside diameter of 3 inches.

2. The ports shall be capable of being sealed when not in use.

3. The sampling ports shall be located in the stack at least 2 stack diameters or equivalent diameters downstream and at least 0.5 stack diameter or equivalent diameter upstream from any fan, bend, constriction or other flow disturbance.

4. For emissions units for which a complete application to construct has been filed prior to December 1, 1980, at least two sampling ports, 90 degrees apart, shall be installed at each sampling location on all circular stacks that have an outside diameter of 15 feet or less. For stacks with a larger diameter, four sampling ports, each 90 degrees apart, shall be installed. For emissions units for which a complete application to construct is filed on or after December 1, 1980, at least two sampling ports, 90 degrees apart, shall be installed at each sampling location on all circular stacks that have an outside diameter of 10 feet or less. For stacks with larger diameters, four sampling ports, each 90 degrees apart, shall be installed. On horizontal circular ducts, the ports shall be located so that the probe can enter the stack vertically, horizontally or at a 45 degree angle.

5. On rectangular ducts, the cross sectional area shall be divided into the number of equal areas in accordance with EPA Method 1. Sampling ports shall be provided which allow access to each sampling point. The ports shall be located so that the probe can be inserted perpendicular to the gas flow.

(d) Work Platforms.

1. Minimum size of the working platform shall be 24 square feet in area. Platforms shall be at least 3 feet wide.

2. On circular stacks with 2 sampling ports, the platform shall extend at least 110 degrees around the stack.

3. On circular stacks with more than two sampling ports, the work platform shall extend 360 degrees around the stack.

4. All platforms shall be equipped with an adequate safety rail (ropes are not acceptable), toeboard, and hinged floor-opening cover if ladder access is used to reach the platform. The safety rail directly in line with the sampling ports shall be removable so that no obstruction exists in an area 14 inches below each sample port and 6 inches on either side of the sampling port.

(e) Access to Work Platform.

APPENDIX SS-1, STACK SAMPLING FACILITIES (version dated 10/07/96)
(continued)

1. Ladders to the work platform exceeding 15 feet in length shall have safety cages or fall arresters with a minimum of 3 compatible safety belts available for use by sampling personnel.

2. Walkways over free-fall areas shall be equipped with safety rails and toeboards.

(f) Electrical Power.

1. A minimum of two 120-volt AC, 20-amp outlets shall be provided at the sampling platform within 20 feet of each sampling port.

2. If extension cords are used to provide the electrical power, they shall be kept on the plant's property and be available immediately upon request by sampling personnel.

(g) Sampling Equipment Support.

1. A three-quarter inch eyebolt and an angle bracket shall be attached directly above each port on vertical stacks and above each row of sampling ports on the sides of horizontal ducts.

a. The bracket shall be a standard 3 inch x 3 inch x one-quarter inch equal-legs bracket which is 1 and one-half inches wide. A hole that is one-half inch in diameter shall be drilled through the exact center of the horizontal portion of the bracket. The horizontal portion of the bracket shall be located 14 inches above the centerline of the sampling port.

b. A three-eighth inch bolt which protrudes 2 inches from the stack may be substituted for the required bracket. The bolt shall be located 15 and one-half inches above the centerline of the sampling port.

c. The three-quarter inch eyebolt shall be capable of supporting a 500 pound working load. For stacks that are less than 12 feet in diameter, the eyebolt shall be located 48 inches above the horizontal portion of the angle bracket. For stacks that are greater than or equal to 12 feet in diameter, the eyebolt shall be located 60 inches above the horizontal portion of the angle bracket. If the eyebolt is more than 120 inches above the platform, a length of chain shall be attached to it to bring the free end of the chain to within safe reach from the platform.

2. A complete monorail or dualrail arrangement may be substituted for the eyebolt and bracket.

3. When the sample ports are located in the top of a horizontal duct, a frame shall be provided above the port to allow the sample probe to be secured during the test.

[Rule 62-297.310(6), F.A.C.]

TABLE 297.310-1 CALIBRATION SCHEDULE
(version dated 10/07/96)

[Note: This table is referenced in Rule 62-297.310, F.A.C.]

ITEM	MINIMUM CALIBRATION FREQUENCY	REFERENCE INSTRUMENT	TOLERANCE
Liquid in glass thermometer	Annually	ASTM Hg in glass ref. thermometer or equivalent, or thermometric points	+/-2%
Bimetallic thermometer	Quarterly	Calib. liq. in glass thermometer	5 degrees F
Thermocouple	Annually	ASTM Hg in glass ref. thermometer, NBS calibrated reference and potentiometer	5 degrees F
Barometer	Monthly	Hg barometer or NOAA station	+/-1% scale
Pitot Tube	When required or when damaged	By construction or measurements in wind tunnel D greater than 16" and standard pitot tube	See EPA Method 2, Fig. 2-2 & 2-3
Probe Nozzles	Before each test or when nicked, dented, or corroded	Micrometer	+/-0.001" mean of at least three readings Max. deviation between readings .004"
Dry Gas Meter and Orifice Meter	1. Full Scale: When received, When 5% change observed, Annually 2. One Point: Semiannually 3. Check after each test series	Spirometer or calibrated wet test or dry gas test meter	2%
		Comparison check	5%

FAX TRANSMITTAL- 407-827-2774

To:	Bruce Mitchell	Fax # :	850-922-6979
From:	Rich Bumar	Date:	3/11/98
Total # of pages (including this page):		6	
If you do not receive all of these pages, call:		827-4524	

THIS IS A RUSH
 PER OUR DISCUSSION
 PLEASE CALL TO DISCUSS
 I WILL CALL TO DISCUSS

REGARDING THE ATTACHED
 PLEASE COPY TO ALL LISTED
 PLEASE ACKNOWLEDGE RECEIPT
 FOR YOUR RERVIEW AND COMMENT

MESSAGE:

Bruce,

I spoke with Scott Sheplak this morning and he said that the attached documents should be sufficient for proof of publication for the Animal Kingdom incinerator permit. The first three pages are a copy of the letter I sent you on 2/25. The last two pages are a copy of the affidavit the *Orlando Sentinel* faxed me yesterday (3/10). Please let me know if there is any other information I need to send you to get the permit finalized.

Thanks,

Rich

-----END OF MESSAGE-----

BEST AVAILABLE COPY



Walt Disney World Co.

February 25, 1998

Mr. Bruce Mitchell
Florida Department of
Environmental Protection
111 South Magnolia, Suite 4
Tallahassee, Florida 32301

RE: Public notice of intent to issue permit
Permit number 0950111-013-AC
Disney's Animal Kingdom: Animal Crematory

Dear Mr. Mitchell:

Enclosed is the proof of publication of the public notice for the above referenced air construction permit, which appeared in the February 22, 1998 edition of The Orlando Sentinel. If you have any questions or need any further information, please call me at 407-827-4524.

Sincerely,

Rich Bumar
Environmental Control Representative
Environmental Control Department

Enclosure

MAY 10 1998

RE-CEIVED

FOR JURY

PROPERTY

STATE OF FLORIDA
 DEPARTMENT OF ENVIRONMENTAL PROTECTION
 NOTICE OF INTENT TO ISSUE PERMIT

The Department of Environmental Protection gives notice of its intent to issue an air construction permit to Walt Disney World Company, Walt Disney World Resort to install an animal crematory at Disney's Animal Kingdom theme park, specifically at the Necropsy Building, to dispose of dead animals from both the theme park and from other areas within the Walt Disney World Resort property. The proposed incinerator has a capacity to process 800 pounds per 4-hour period and is a Crawford Model CB800 Animal Carcass Incinerator. The emissions unit will be fired with natural gas. The resort is located in Lake Buena Vista, Orange County, Florida. It was determined that new source review pursuant to Prevention of Significant Deterioration (PSD) is not applicable and a Best Available Control Technology determination was not required pursuant to Rule 62-212.400, Florida Administrative Code (F.A.C.). The applicant's name and address are: Walt Disney World Co., P.O. Box 10,000, Lake Buena Vista, Florida 32830-1000.

The Department will issue the final permit, in accordance with the conditions of the permit unless a response received in accordance with the following procedures results in a different decision or significant change of terms or conditions.

The Department will accept written comments concerning the proposed draft permit issuance action for a period of fourteen (14) days from the date of publication of this Notice. Written comments should be provided to the Department's Bureau of Air Regulation, 2500 Blair Stone Road, Mail Station #505, Tallahassee, FL 32399-2400. Any written comments filed shall be made available for public inspection. If written comments received result in a significant change in the draft Permit, the Department shall issue a Revised draft Permit, and require, if applicable, another Public Notice.

The Department will issue final Permit with the conditions of the draft Permit unless a timely petition for an administrative hearing is filed pursuant to Sections 120.569 and 120.57, Florida Statute (F.S.). The procedures for petitioning for a hearing are set forth below. Mediation is not available for this action.

A person whose substantial interests are affected by the proposed agency action may petition for an administrative hearing in accordance with sections 120.569 and 120.57 F.S. The petition must contain the information set forth below and must be filed (received) in the Department's Office of General Counsel at 3800 Commonwealth Boulevard, Mail Station 36, Tallahassee, Florida 32309-3900. Petitions must be filed within fourteen days of publication of the public notice or within fourteen (14) days of publication of the public notice or within fourteen (14) days of receipt of this notice of intent, whichever occurs first. A petitioner must mail a copy of the petition to the applicant at the address indicated above, at the time of filing. The failure of any person to file a petition (or a request for mediation, as discussed below) within the applicable time period shall constitute a waiver of that person's right to request an administrative determination (hearing) under sections 120.569 and 120.57 F.S., or to intervene in this proceeding and participate as a party to it. Any subsequent intervention will be only at the approval of the presiding officer upon the filing of a motion in compliance with rule 28-5.207 of the Florida Administrative Code.

A petition must contain the following information:

(a) The name, address, and telephone number of each petitioner, the applicant's name and address, the Permit File Number, and the county in which the project is proposed.

(b) A statement of how and when each petitioner received

ATTORNEY GENERAL'S OFFICE

MAR-11-98 WED 10:27 AM 00

whichever occurs first. A petitioner must mail a copy of the petition to the applicant at the address indicated above, at the time of filing. The failure of any person to file a petition (or a request for mediation, as discussed below) within the applicable time period shall constitute a waiver of that person's right to request an administrative determination (hearing) under sections 120.569 and 120.57 F.S., or to intervene in this proceeding and participate as a party to it. Any subsequent intervention will be only at the approval of the presiding officer upon the filing of a motion in compliance with rule 28-5.207 of the Florida Administrative Code.

A petition must contain the following information:

(a) The name, address, and telephone number of each petitioner, the applicant's name and address, the Permit File Number, and the county in which the project is proposed;

(b) A statement of how and when each petitioner received

n
On
Or
C
th
in
fo
th
str
no
mc
dr

The Orlando Sentinel, Sunday, February 22, 1998

D-3

ANNOUNCEMENTS

notice of the Department's action or proposed action;

(c) A statement of how each petitioner's substantial interests are affected by the Department's action or proposed action;

(d) A statement of the material facts disputed by the petitioner, if any;

(e) A statement of the facts that the petitioner contends warrant reversal or modification of the Department's action or proposed action;

(f) A statement identifying the rules or statutes that the petitioner contends require reversal or modification of the Department's action or proposed action; and

(g) A statement of the relief sought by the petitioner, stating precisely the action that the petitioner wants the Department to take with respect to the action or proposed action addressed in this notice.

Because the administrative hearing process is designed to formulate final agency action, the filing of a petition means that the Department's final action may be different from the position taken by it in this notice of intent. Persons whose substantial interests will be affected by any such final decision of the Department on the application have the right to petition to become a party to the proceeding, in accordance with the requirements set forth above.

A complete project file is available for public inspection during normal business hours, 8:00 a.m. to 5:00 p.m., Monday through Friday, except legal holidays, at:

Department of Environmental Protection
Bureau of Air Regulations
111 S. Magnolia Drive, Suite 4
Tallahassee, FL 32301
Telephone: 850/477-1844
Fax: 850/922-8978

Department of Environment
Protection
Central District
3318 Magnolia Boulevard
Suite 222
Orlando, FL 32803-3707
Telephone: 407/894-7555
Fax: 407/897-2966

The complete project file includes the application submitted by the responsible official under the seal of a professional engineer registered in the State of Florida, the Technical Evaluation and Preliminary Determination, and the draft Permit. Interested persons may contact Mr. Scott Sheplak, P.E., Administrator, Title V Section, at 111 South Magnolia Drive, Suite 4, Tallahassee, Florida 32301, or call 850/921-9532, for additional information. Feb. 22, 1998
COR1981897

1
2
3
4
5
6
7
8
9
10
11
12
13
14
15
16
17
18
19
20
21
22
23
24
25
26
27
28
29
30
31
32
33
34
35
36
37
38
39
40
41
42
43
44
45
46
47
48
49
50
51
52
53
54
55
56
57
58
59
60
61
62
63
64
65
66
67
68
69
70
71
72
73
74
75
76
77
78
79
80
81
82
83
84
85
86
87
88
89
90
91
92
93
94
95
96
97
98
99
100

BEST AVAILABLE COPY

The Orlando Sentinel

Published Daily

State of Florida } S.S.
COUNTY OF ORANGE }

Before the undersigned authority personally appeared Denise Little who on oath says that he/she is the Legal Advertising Representative of The Orlando Sentinel, a daily newspaper published at Orlando in Orange County, Florida; that the attached copy of advertisement, being a Notice of Intent in the matter of Animal Crematory in the Orange Court, was published in said newspaper in the issue of 2/22/98.

Affiant further says that the said Orlando Sentinel is a newspaper published at Orlando in said Orange County, Florida, and that the said newspaper has heretofore been continuously published in said Orange County, Florida, each Week Day and has been entered as second-class mail matter at the post office in Orange County, Florida, for a period of one year next preceding the first publication of the attached copy of advertisement; and affiant further says that he/she has neither paid nor promised any person, firm or corporation any discount, rebate, commission or refund for the purpose of securing this advertisement for publication in the said newspaper.

The foregoing instrument was acknowledged before me this 18 day of March, 19 98, by Denise Little who is personally known to me and who did take an oath.

(SEAL)



M. DENNIS LEE, Notary Public, No. 20515, State of Florida.

NOTICE OF INTENT TO ISSUE PERMIT The Department of Environmental Protection gives notice of its intent to issue a draft permit to West Disney World Company, Walt Disney World Resort, to install an animal crematory at Disney's Animal Kingdom Theme Park, specifically at the Necrology Building, to dispose of dead animals from both the theme park and from other areas within the Walt Disney World Resort property. The proposed technology has a capacity to process 800 pounds per 2-hour period and is a Crawford Model 08100 Animal Cremation System. The permit application will be held for public review and comment in the lobby of the Lake Buena Vista, Orange County, Florida, it was determined that such access is available to the general public. The Department of Environmental Protection (DEP) is not responsible for a final permit decision. Technology determination was not required pursuant to Rule 12C-1.000, Florida Administrative Code. The applicant's name and address are: West Disney World Co., P.O. Box 10,000, Lake Buena Vista, Florida 32816-1000. The Department will issue the final permit in accordance with the conditions of the permit unless a response received in accordance with the following procedure results in a different decision or a different change of terms or conditions. The Department will accept written comments concerning the proposed draft permit within 15 days from the date of publication of this notice. Written comments should be provided to the Department's Bureau of Air Regulation, 2000 Gray Stone Road, Mail Station 25200, Tallahassee, FL 32309-2400. Any written comments filed shall be made available for public inspection, and written comments received result in a significant change in the draft permit, the Department shall issue a Revised Draft Permit, and re-open, if applicable, another Public Notice. The Department will issue final permits in accordance with the conditions of the draft permit unless a final petition for an administrative hearing is filed pursuant to sections 120.302 and 120.301, Florida Statute (F.S.). The procedures for petitioning for a hearing are set forth below. Methods are not available for the action. A person who is dissatisfied with the decision shall file a petition for an administrative hearing in accordance with sections 120.302 and 120.301, F.S. The petition must contain the information set forth below and must be filed (received) in the Department's Office of General Counsel at 3900 Commonwealth Boulevard, Mail Station 26, Tallahassee, Florida 32303-0026. Petitioners must also attach to their copy of the petition of the public notice or within fourteen (14) days of receipt of the notice of intent, whichever occurs first. A petitioner must mail a copy of the petition to the applicant at the address specified above, if the time of filing. The failure of any person to file a petition for a request for mediation, as discussed below within the applicable time period shall constitute a waiver of that person's right to request an administrative determination (hearing) under sections 120.340 and 120.307, F.S., or to intervene in the proceedings and participate as a party to it. Any subsequent intervention will be stayed at the approval of the presiding officer upon the filing of a motion. It complies with rule 20-3.007 of the Florida Administrative Code. A petition must contain the following information: (a) The name, address, and telephone number of each petitioner, the petitioner's name and address, the permit file number, and the county in which the petition is prepared; (b) A statement of how and when such petition received notice of the Department's action or proposed action; (c) A statement of how each petitioner's substantial interests are affected by the Department's action or proposed action; (d) A statement of the material facts supported by the petitioner; (e) A statement of the facts that the petitioner contends warrant reversal or modification of the Department's action or proposed action; (f) A statement identifying the issue or issues that the petitioner contends require reversal or modification of the Department's action or proposed action; (g) A statement of the relief sought by the petitioner, stating precisely the action that the petitioner wants the Department to take with respect to the action or proposed action described.

BEST AVAILABLE COPY

7) A statement regarding the
view or action that the peti-
tioner contends require reversal
or modification of the Depart-
ment's action or proposed ac-
tion.

8) A statement of the relief
sought by the petitioner, stating
precisely the action that the pe-
titioner wants the Department to
take with respect to the action
or proposed action addressed
in this case.

Because the administrative
hearing process is designed to
simulate final agency action,
the filing of a petition means
that the Department's final ac-
tion may be different from the
position taken by it in this regard
of intent. Parties whose sub-
stantial interests will be affected
by any such new decision of the
Department on the application
have the right to bring to be-
fore a party to the proceeding,
in accordance with the require-
ments set forth above.

A complete project file is avail-
able for the public inspection
during normal business hours,
8:00 a.m. to 5:00 p.m., Monday
through Friday, except legal hol-
idays, at
Department of Environmental
Protection
Bureau of Air Regulation
111 S. Magnolia Drive, Suite 4
Tallahassee, FL 32301
Telephone: 904/771-1319
Fax: 904/224-6070

Department of Environment
Protection
Central District
2310 McGuire Boulevard
Suite 137
Orlando, FL 32803-3707
Telephone: 407/894-7035
Fax: 407/897-2616

The complete project file in-
cludes the application submitted
by the responsible agency, under
the seal of a professional engi-
neer registered in the State of
Florida, the Technical Evaluation
and Summary Determination,
and the Draft Permit. Interested
parties may contact Mr. Scott
Jenski, P. E., Administrative,
Policy Section, at 111 South Mag-
nolia Drive, Suite 4, Tallahassee,
Florida 32301, or call 904/224-
6070, for additional information.
COR189:007 Feb. 22, 1998

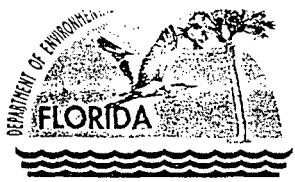

BEST AVAILABLE COPY
Department of
Environmental Protection

Lawton Chiles
Governor

Twin Towers Office Building
2600 Blair Stone Road
Tallahassee, Florida 32399-2400

Virginia B. Wetherell
Secretary

February 11, 1998

Grove Scientific
Attention: Luis Lorens
6140 Edgewater Drive
Suite F
Orlando, Florida 32810-4810

Dear Mr. Lorens:

This letter is to approve your request of February 4, 1998 to include the training program outline for the Crawford Model CB800 Animal Carcass Incinerator as a part of the Grove Scientific incinerator operator training program presently approved by the Department. Personnel authorized to train operators on the Crawford Model CB800 as part of the Grove Scientific approved program are Bruno Ferraro and Luis Lorens of Grove Scientific and Steve Atkinson, Brad Boyett and Duane James of Crawford Equipment and Engineering. This request is made as part of the technical evaluation and preliminary determination of the permit application for Walt Disney World Co.'s intent to construct an animal crematory at it's Walt Disney World Resort Disney's Animal Kingdom for disposal of dead animals from the Disney property.

The training program is approved to provide a basic understanding of the principles of the combustion process, provide instruction on proper operating practices and procedures, and increase awareness of the regulatory requirements and safety concerns. The training program shall be a minimum of 8 hours of instruction. The program shall include hands-on training (on an actual model of equipment that trainees are certified to operate) including start-up and shut-down of the equipment, operation of any pollution control equipment, and preventative maintenance actions. In addition, the trainees are to be advised of recordkeeping procedures and applicable rules pertaining to the incinerator operation as stated in Chapters 62-296 and 62-297, Florida Administrative Code.

A certificate of training shall be signed, dated and issued by the instructor providing the training for each operator that successfully completes the training course listing the model of equipment specific to the training program provided. A copy of the training certificate for each operator having satisfactorily completed the training

"Protect, Conserve and Manage Florida's Environment and Natural Resources"

Printed on recycled paper.

Mr. Luis Lorens
February 11, 1998
Page Two

program must be submitted to the Department within 15 days of completion of the training.

As a condition of the approval of the training program, adequate notification shall be provided to this office prior to the commencement of any training session conducted. The notification is to include the location of training, the date and time of training, and the name of the instructor conducting the training. Please be advised that the Department may audit training sessions, as deemed necessary.

Should you have any questions or need additional information, please contact Dennis Tober at 850/921-9518.

Sincerely,



C.H. Eancy, P.E.
Chief
Bureau of Air Regulation

CHF/h

cc: Jim Pennington
Dennis Tober
✓ Bruce Mitchell



WALT DISNEY World Co.

March 17, 1998

Mr. Bruce Mitchell
Florida Department of
Environmental Protection
2600 Blair Stone Road
Tallahassee, Florida 32399-2400

RE: Re-sending of public notice of intent to issue permit
Permit number 0950111-013-AC
Disney's Animal Kingdom: Animal Crematory

Dear Mr. Mitchell:

Enclosed is the letter that I sent to you on February 25, 1998 for the proof of publication for the above referenced air construction permit. Apparently, the post office does not like the South Magnolia address, so I will send all future correspondence to your Blair Stone Road address. I apologize for any inconvenience that may have occurred due to this addressing error. If you have any questions or need any further information, please call me at 407-827-4524.

Sincerely,

Rich Bumar
Environmental Control Representative
Environmental Control Department

Enclosure

BEST AVAILABLE COPY

Is your RETURN ADDRESS completed on the reverse side?

SENDER:

- Complete items 1 and/or 2 for additional services.
- Complete items 3, 4a, and 4b.
- Print your name and address on the reverse of this form so that we can return this card to you.
- Attach this form to the front of the mailpiece, or on the back if space does not permit.
- Write "Return Receipt Requested" on the mailpiece below the article number.
- The Return Receipt will show to whom the article was delivered and the date delivered.

I also wish to receive the following services (for an extra fee):

1. Addressee's Address
2. Restricted Delivery

Consult postmaster for fee.

3. Article Addressed to:

Mr Bruce Mitchell
FDEP
111 South Magnolia, suite 4
Tallahassee, FL 32301

4a. Article Number

2232644211

4b. Service Type

- | | |
|---|------------------------------------|
| <input type="checkbox"/> Registered | <input type="checkbox"/> Certified |
| <input type="checkbox"/> Express Mail | <input type="checkbox"/> Insured |
| <input type="checkbox"/> Return Receipt for Merchandise | <input type="checkbox"/> COD |

7. Date of Delivery

5. Received By: (Print Name)

8. Addressee's Address (Only if requested and fee is paid)

6. Signature: (Addressee or Agent)

X

PS Form 3811, December 1994

Domestic Return Receipt

Thank you for using Return Receipt Service.



© Disney

WALT DISNEY World Co.

Env. Cont.

P.O. Box 10,000
Lake Buena Vista, Florida 32830-1000

Fold at line over top of envelope to the right of the return address

CERTIFIED

2 232 644 211

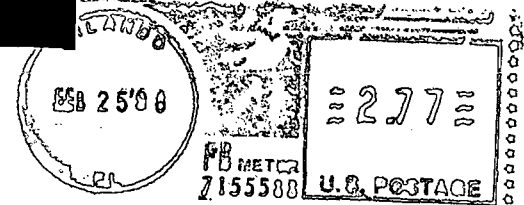

MAIL

Mr. Bruce Mitchell
Florida Department of
Environmental Protection
111 South Magnolia, Suite 4
Tallahassee, Florida 32301

RECEIVED

MAR 23 1998

BUREAU OF
AIR REGULATION

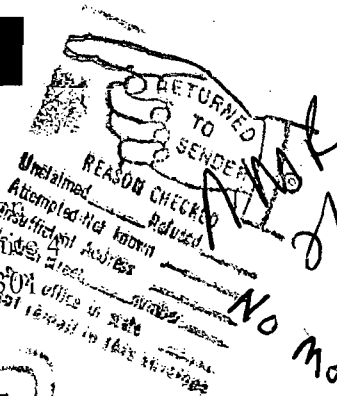
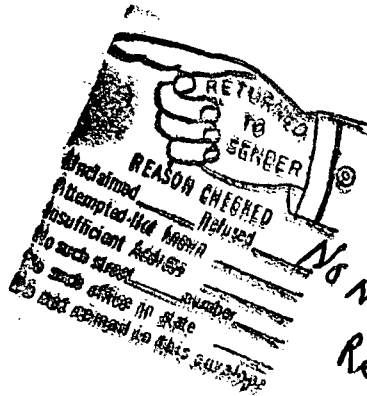

**RETURN RECEIPT
REQUESTED**

32301-29567

STATE OF FLORIDA
DEPARTMENT OF ENVIRONMENTAL PROTECTION
NOTICE OF INTENT TO ISSUE PERMIT

The Department of Environmental Protection gives notice of its intent to issue an air construction permit to Walt Disney World Company, Walt Disney World Resort to install an animal crematory at Disney's Animal Kingdom theme park, specifically at the Necropsy Building, to dispose of dead animals from both the theme park and from other areas within the Walt Disney World Resort property. The proposed incinerator has a capacity to process 800 pounds per 4-hour period and is a Crawford Model CB800 Animal Carcass Incinerator. The emissions unit will be fired with natural gas. The resort is located in Lake Buena Vista, Orange County, Florida. It was determined that new source review pursuant to Prevention of Significant Deterioration (PSD) is not applicable and a Best Available Control Technology determination was not required pursuant to Rule 62-212.400, Florida Administrative Code (F.A.C.). The applicant's name and address are: Walt Disney World Co., P.O. Box 10,000, Lake Buena Vista, Florida 32830-1000.

The Department will issue the Final permit, in accordance with the conditions of the Permit unless a response received in accordance with the following procedures results in a different decision or significant change of terms or conditions.

The Department will accept written comments concerning the proposed draft Permit issuance action for a period of fourteen (14) days from the date of publication of this Notice. Written comments should be provided to the Department's Bureau of Air Regulation, 2600 Blair Stone Road, Mail Station #5505, Tallahassee, FL 32399-2400. Any written comments filed shall be made available for public inspection. If written comments received result in a significant change in the draft Permit, the Department shall issue a Revised draft Permit, and require, if applicable, another Public Notice.

The Department will issue final Permit with the conditions of the draft Permit unless a timely petition for an administrative hearing is filed pursuant to Sections 120.569 and 120.57, Florida Statute (F.S.). The procedures for petitioning for a hearing are set forth below. Mediation is not available for this action.

A person whose substantial interests are affected by the proposed agency action may petition for an administrative hearing in accordance with sections 120.569 and 120.57 F.S. The petition must contain the information set forth below and must be filed (received) in the Department's Office of General Counsel at 3900 Commonwealth Boulevard, Mail Station 35, Tallahassee, Florida 32399-3000. Petitions must be filed within fourteen days of publication of the public notice or within fourteen (14) days of publication of the public notice or receipt of this notice of intent, whichever occurs first. A petitioner must mail a copy of the petition to the applicant at the address indicated above, at the time of filing. The failure of any person to file a petition (or a request for mediation, as discussed below) within the applicable time period shall constitute a waiver of that person's right to request an administrative determination (hearing) under sections 120.569 and 120.57 F.S., or to intervene in this proceeding and participate as a party to it. Any subsequent intervention will be only at the approval of the presiding officer upon the filing of a motion in compliance with rule 28-5.207 of the Florida Administrative Code.

A petition must contain the following information:

(a) The name, address, and telephone number of each petitioner, the applicant's name and address, the Permit File Number, and the county in which the project is proposed;

(b) A statement of how and when each petitioner received

NOTICE OF INTENT TO ISSUE PERMIT
 STATE OF FLORIDA
 DEPARTMENT OF ENVIRONMENTAL PROTECTION
 BUREAU OF AIR REGULATIONS
 2600 BLAIR STONE ROAD
 MAIL STATION #5505
 TALLAHASSEE, FLORIDA 32399-2400
 TELEPHONE: 904/487-1344
 FAX: 904/487-6979

D-4 The Orlando Sentinel, Sunday, February 22, 1998

notice of the Department's action or proposed action;

(c) A statement of how each petitioner's substantial interests are affected by the Department's action or proposed action;

(d) A statement of the material facts disputed by the petitioner, if any;

(e) A statement of the facts that the petitioner contends warrant reversal or modification of the Department's action or proposed action;

(f) A statement identifying the rules or statutes that the petitioner contends require reversal or modification of the Department's action or proposed action; and

(g) A statement of the relief sought by the petitioner, stating precisely the action that the petitioner wants the Department to take with respect to the action or proposed action addressed in this notice.

Because the administrative hearing process is designed to formulate final agency action, the filing of a petition means that the Department's final action may be different from the position taken by it in this notice of intent. Persons whose substantial interests will be affected by any such final decision of the Department on the application have the right to petition to become a party to the proceeding, in accordance with the requirements set forth above.

A complete project file is available for the public inspection during normal business hours, 8:00 a.m. to 5:00 p.m., Monday through Friday, except legal holidays, at:

Department of Environmental Protection
 Bureau of Air Regulations
 111 S. Magnolia Drive, Suite 4
 Tallahassee, FL 32301
 Telephone: 850/477-1344
 Fax: 850/922-6979

Department of Environment Protection
 Central District
 3319 Maguire Boulevard
 Suite 232
 Orlando, FL 32803-3767
 Telephone: 407/894-7555
 Fax: 407/897-2968

The complete project file includes the application submitted by the responsible official under the seal of a professional engineer registered in the State of Florida, the Technical Evaluation and Preliminary Determination, and the draft Permit. Interested persons may contact Mr. Scott Sheplak, P.E., Administrator, Title V Section, at 111 South Magnolia Drive, Suite 4, Tallahassee, Florida 32301, or call 850/921-9532, for additional information.
 COR1981937 Feb. 22, 1998



WALT DISNEY World Co.

February 25, 1998

Mr. Bruce Mitchell
Florida Department of
Environmental Protection
111 South Magnolia, Suite 4
Tallahassee, Florida 32301

RE: Public notice of intent to issue permit
Permit number 0950111-013-AC
Disney's Animal Kingdom: Animal Crematory

Dear Mr. Mitchell:

Enclosed is the proof of publication of the public notice for the above referenced air construction permit, which appeared in the February 22, 1998 edition of The Orlando Sentinel. If you have any questions or need any further information, please call me at 407-827-4524.

Sincerely,

Rich Bumar
Environmental Control Representative
Environmental Control Department

Enclosure



Department of Environmental Protection

Lawton Chiles
Governor

Twin Towers Office Building
2600 Blair Stone Road
Tallahassee, Florida 32399-2400

Virginia B. Wetherell
Secretary

February 17, 1998

CERTIFIED MAIL - RETURN RECEIPT REQUESTED

Mr. Lee Schmudde
Vice President, Legal
Walt Disney World Co.
P.O. Box 10,000
Lake Buena Vista, Florida 32830-1000

Re: Draft Air Construction Permit
Walt Disney World Resort: Disney's Animal Kingdom: Animal Crematory
Permit No. 0950111-013-AC

Dear Mr. Schmudde:

Enclosed is one copy of the draft Air Construction Permit for the proposed animal crematory to be installed at Walt Disney World Co.'s Walt Disney World Resort, specifically at Disney's Animal Kingdom theme park located in Lake Buena Vista, Orange County, Florida. The Department's Intent to Issue Permit, the "PUBLIC NOTICE OF INTENT TO ISSUE PERMIT", the Technical Evaluation and Preliminary Determination, and the draft Permit are also included.

The "PUBLIC NOTICE OF INTENT TO ISSUE PERMIT" must be published as soon as possible upon receipt of this letter. Proof of publication, i.e., newspaper affidavit, must be provided to the Department's Bureau of Air Regulation office within 7 (seven) days of publication. Failure to publish the notice and provide proof of publication within the allotted time may result in the denial of the permit.

Please submit any written comments you wish to have considered concerning the Department's proposed action to Scott M. Sheplak, P.E., Administrator, Title V Section, at the above letterhead address. If you have any other questions, please contact Mr. Bruce Mitchell at 850/921-9506 or Mr. Sheplak at 850/921-9532.

Sincerely,

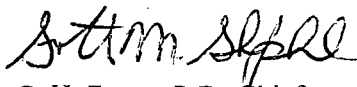
for 
C. H. Fancy, P.E., Chief,
Bureau of Air Regulation

CHF/bm

Enclosures

2/18/98 cc: Bruce Mitchell
Feeding Site

"Protect, Conserve and Manage Florida's Environment and Natural Resources"

PS Form 3800, April 1995

Sent to		Mr. Bob Beaver, P.E.
Street & Number		P.O. Box 10,000
Post Office, State, & ZIP Code		Lake Buena Vista, FL 32830
Postage	\$	1000
Certified Fee		
Special Delivery Fee		
Restricted Delivery Fee		
Return Receipt Showing to Whom & Date Delivered		
Return Receipt Showing to Whom, Date, & Addressee's Address		
TOTAL Postage & Fees	\$	
Postmark or Date	2/18/98	
Facility ID#0950111-013-AC		

US Postal Service
Receipt for Certified Mail
 No Insurance Coverage Provided.
 Do not use for International Mail (See reverse)

P 263 584 681

is your RETURN ADDRESS completed on the reverse side?

SENDER:

- Complete items 1 and/or 2 for additional services.
- Complete items 3, 4a, and 4b.
- Print your name and address on the reverse of this form so that we can return this card to you.
- Attach this form to the front of the mailpiece, or on the back if space does not permit.
- Write "Return Receipt Requested" on the mailpiece below the article number.
- The Return Receipt will show to whom the article was delivered and the date delivered.

I also wish to receive the following services (for an extra fee):

- Addressee's Address
- Restricted Delivery

Consult postmaster for fee.

3. Article Addressed to:
 Mr. Bob Beaver, P.E.
 Walt Disney World Co.
 P.O. Box 10,000
 Lake Buena Vista, Florida

4a. Article Number
 P 263 584 681

4b. Service Type
 Registered Certified
 Express Mail Insured
 Return Receipt for Merchandise COD

7. Date of Delivery

8. Addressee's Address (Only if requested and fee is paid)

5. Received By: (Print Name) **FEB 20 1998**

6. Signature: (Addressee or Agent)
X

PS Form 3811, December 1994

Domestic Return Receipt

Thank you for using Return Receipt Service.

PS Form 3800, April 1995

Sent to		Mr. Richard Bumar
Street & Number		P.O. Box 10,000
Post Office, State, & ZIP Code		Lake Buena Vista, Florida
Postage	\$	32830-1000
Certified Fee		
Special Delivery Fee		
Restricted Delivery Fee		
Return Receipt Showing to Whom & Date Delivered		
Return Receipt Showing to Whom, Date, & Addressee's Address		
TOTAL Postage & Fees	\$	
Postmark or Date	2/18/98	
Facility ID#0950111-013-AC		

US Postal Service
Receipt for Certified Mail
 No Insurance Coverage Provided.
 Do not use for International Mail (See reverse)

P 263 584 682

is your RETURN ADDRESS completed on the reverse side?

SENDER:

- Complete items 1 and/or 2 for additional services.
- Complete items 3, 4a, and 4b.
- Print your name and address on the reverse of this form so that we can return this card to you.
- Attach this form to the front of the mailpiece, or on the back if space does not permit.
- Write "Return Receipt Requested" on the mailpiece below the article number.
- The Return Receipt will show to whom the article was delivered and the date delivered.

I also wish to receive the following services (for an extra fee):

- Addressee's Address
- Restricted Delivery

Consult postmaster for fee.

3. Article Addressed to:
 Mr. Richard Bumar
 Walt Disney World Co.
 P.O. Box 10,000
 Lake Buena Vista, Florida

4a. Article Number
 P 263 584 682

4b. Service Type
 Registered Certified
 Express Mail Insured
 Return Receipt for Merchandise COD

7. Date of Delivery

8. Addressee's Address (Only if requested and fee is paid)

5. Received By: (Print Name) **FEB 20 1998**

6. Signature: (Addressee or Agent)
X

PS Form 3811, December 1994

Domestic Return Receipt

Thank you for using Return Receipt Service.

PS Form 3800, April 1995

US Postal Service Receipt for Certified Mail No Insurance Coverage Provided. Do not use for International Mail (See reverse)	
Sent to	Mr. Lee Schmudde
Street & Number	P.O. Box 10,000
Post Office, State, & ZIP Code	Lake Buena Vista, FL 32830
Postage	\$ 1000
Certified Fee	
Special Delivery Fee	
Restricted Delivery Fee	
Return Receipt Showing to Whom & Date Delivered	
Return Receipt Showing to Whom, Date, & Addressee's Address	
TOTAL Postage & Fees	\$
Postmark or Date	2/18/98
Facility ID#0950111-013-AC	

P 263 584 679

is your RETURN ADDRESS completed on the reverse side?

SENDER: ■ Complete items 1 and/or 2 for additional services. ■ Complete items 3, 4a, and 4b. ■ Print your name and address on the reverse of this form so that we can return this card to you. ■ Attach this form to the front of the mailpiece, or on the back if space does not permit. ■ Write "Return Receipt Requested" on the mailpiece below the article number. ■ The Return Receipt will show to whom the article was delivered and the date delivered.		I also wish to receive the following services (for an extra fee): 1. <input type="checkbox"/> Addressee's Address 2. <input type="checkbox"/> Restricted Delivery Consult postmaster for fee.
3. Article Addressed to: Mr. Lee Schmudde Vice President, Legal Walt Disney World Co. P.O. Box 10,000 Lake Buena Vista, Florida 32830-1000	4a. Article Number P 263 584 679	4b. Service Type <input type="checkbox"/> Registered <input checked="" type="checkbox"/> Certified <input type="checkbox"/> Express Mail <input type="checkbox"/> Insured <input type="checkbox"/> Return Receipt for Merchandise <input type="checkbox"/> COD
5. Received By: (Print Name) [Stamp: BR 32830-1000 FEB 20 1998]	7. Date of Delivery FEB 20 1998	
6. Signature: (Addressee or Agent) X	8. Addressee's Address (Only if requested and fee is paid)	

PS Form 3811, December 1994

Thank you for using Return Receipt Service.

PS Form 3800, April 1995

US Postal Service Receipt for Certified Mail No Insurance Coverage Provided. Do not use for International Mail (See reverse)	
Sent to	Mr. Len Kozlov
Street & Number	3319 Maguire Boulevard #232
Post Office, State, & ZIP Code	Orlando, Florida 32803-3767
Postage	\$
Certified Fee	
Special Delivery Fee	
Restricted Delivery Fee	
Return Receipt Showing to Whom & Date Delivered	
Return Receipt Showing to Whom, Date, & Addressee's Address	
TOTAL Postage & Fees	\$
Postmark or Date	2/18/98
Facility ID#0950111-013-AC	

P 263 584 680

is your RETURN ADDRESS completed on the reverse side?

SENDER: ■ Complete items 1 and/or 2 for additional services. ■ Complete items 3, 4a, and 4b. ■ Print your name and address on the reverse of this form so that we can return this card to you. ■ Attach this form to the front of the mailpiece, or on the back if space does not permit. ■ Write "Return Receipt Requested" on the mailpiece below the article number. ■ The Return Receipt will show to whom the article was delivered and the date delivered.		I also wish to receive the following services (for an extra fee): 1. <input type="checkbox"/> Addressee's Address 2. <input type="checkbox"/> Restricted Delivery Consult postmaster for fee.
3. Article Addressed to: Mr. Len Kozlov Central District Office 3319 Maguire Boulevard Suite 232 Orlando, Florida 32803-3767	4a. Article Number P 263 584 680	4b. Service Type <input type="checkbox"/> Registered <input checked="" type="checkbox"/> Certified <input type="checkbox"/> Express Mail <input type="checkbox"/> Insured <input type="checkbox"/> Return Receipt for Merchandise <input type="checkbox"/> COD
5. Received By: (Print Name) [Stamp: BR 32803-3767 FEB 20 1998]	7. Date of Delivery 2-28-98	
6. Signature: (Addressee or Agent) X A. Rodriguez	8. Addressee's Address (Only if requested and fee is paid)	

PS Form 3811, December 1994

Thank you for using Return Receipt Service.



Department of Environmental Protection

Lawton Chiles
Governor

Twin Towers Office Building
2600 Blair Stone Road
Tallahassee, Florida 32399-2400

Virginia B. Wetherell
Secretary

P.E. Certification Statement

Permittee:
Walt Disney World Company
Walt Disney World Resort Complex

DRAFT Permit No.: 0950111-013-AC
Facility ID No.: 0950111

Project type: Air Construction Permit

I HEREBY CERTIFY that the engineering features described in the above referenced application and subject to the proposed permit conditions provide reasonable assurance of compliance with applicable provisions of Chapter 403, Florida Statutes, and Florida Administrative Code, Chapters 62-4, and 62-204 through 62-297. However, I have not evaluated and I do not certify aspects of the proposal outside of my area of expertise (including but not limited to the electrical, mechanical, structural, hydrological, and geological features).

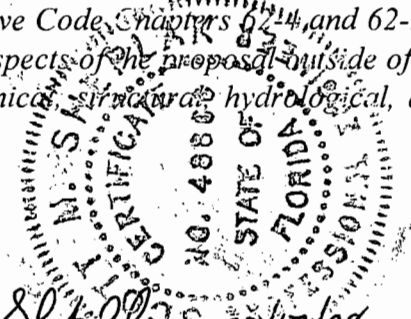
Scott M. Sheplak 02/17/98
Scott M. Sheplak, P.E. date
Registration Number: 0048866

Permitting Authority:
Department of Environmental Protection
Bureau of Air Regulation
111 South Magnolia Drive, Suite 4
Tallahassee, Florida 32301
Telephone: 850/488-1344
Fax: 850/922-6979

TECHNICAL EVALUATION
AND
PRELIMINARY DETERMINATION

Walt Disney World Co.
Walt Disney World Resort Complex
Facility ID No.: 0950111
Orange County

Animal Crematory

Air Construction Permit No. 0950111-013-AC

Department of Environmental Protection
Division of Air Resources Management
Bureau of Air Regulation
Title V Section

February 17, 1998

TECHNICAL EVALUATION AND PRELIMINARY DETERMINATION

1. APPLICATION INFORMATION

1.1. Applicant Name and Address

Walt Disney World Co.
P.O. Box 10,000
Orlando, Florida 32830-1000

Responsible Official
Mr. Lee Schmutde, Vice President, Legal

1.2. Reviewing and Process Schedule

01-20-98: Date of Receipt of Application

2. FACILITY INFORMATION

2.1. Facility Location

Walt Disney World Co. intends to construct an animal crematory at its Walt Disney World Resort, Disney's Animal Kingdom, specifically at the Necropsy Building. Disney's Animal Kingdom is a new theme park within the Walt Disney World Resort complex and will include live animal exhibits, rides, shows, restaurants, merchandise locations, and staff support facilities. The emissions unit is a Crawford Model CB800 Animal Carcass Incinerator, which will be used to dispose of dead animals from both the theme park and from other areas within the Walt Disney World Resort property.

The UTM: coordinates of this facility are Zone 17 ; 449.70 km E ; 3138.00 km N.

2.2. Standard Industrial Classification Code (SIC)

Major Group No.	79	Amusement and Recreational Services
Group No.	799	Miscellaneous Amusement and Recreational Services
Industry No.	7996	Amusement Parks: Theme Parks

2.3. Facility Category

Walt Disney World Resort is classified as a major air pollutant emitting facility. This facility is not on the list of the 28 Major Facility Categories, Table 62-212.400-1. This facility is classified as a Title V - Title IV facility and received its initial Title V - Title IV operation permit on December 31, 1997. Based on the application for this new emissions unit, the animal

TECHNICAL EVALUATION AND PRELIMINARY DETERMINATION

crematory is a minor emissions unit of air pollution and the specific conditions in the draft permit will reflect this.

3. PROJECT DESCRIPTION

3.1. This permit addresses the following emissions unit:

EMISSION UNIT NO.	EMISSION UNIT DESCRIPTION
-xxx	Crawford Model CB800 Animal Crematory

The applicant requested an air construction permit to install an animal crematory to incinerate animal carcasses (including primates). The emissions unit has a design capacity to process an 800 pound load every four hours. The emissions unit will be fired on natural gas with a maximum heat input of 3.0 MMBtu/hr. The emissions unit will be permitted to operate 8760 hrs/yr. The emissions unit will have a primary and secondary chamber. The secondary chamber has a calculated residence time and temperature of 1.14 seconds @ 1800 °F, respectively (rule requires minimums of 1.0 second @ 1800 °F).

4. RULE APPLICABILITY

The proposed project is subject to preconstruction review requirements under the provisions of Chapter 403, Florida Statutes, and Florida Administrative Code (F.A.C.) Chapters 62-4, 62-204, 62-210, 62-212, 62-296, and 62-297.

In accordance with Rule 62-204.340(4)(a)1., F.A.C., this facility is located in an area (Orange County) designated as maintenance for the pollutant ozone. The proposed project is subject to review under Rule 62-212.300(3), F.A.C., General - Permitting Requirements, and Rule 62-212.400(2)(d)1., F.A.C., Prevention of Significant Deterioration (PSD) - New Minor Facilities. The potential emissions are less than the significant emission rates established in Chapter 62-212, Table 212.400-2, F.A.C., for all pollutants.

The emissions unit affected by this permit shall be in compliance with all applicable provisions of the Florida Administrative Code and, specifically, the following Chapters and Rules:

Chapter 62-4	Permits
Rule 62-204.220	Ambient Air Quality Protection
Rule 62-204.240	Ambient Air Quality Standards
Rule 62-204.260	Prevention of Significant Deterioration Increments
Rule 62-204.340	Designation of Attainment, Nonattainment, and Maintenance Areas
Rule 62-210.300	Permits Required
Rule 62-210.350	Public Notice and Comments

TECHNICAL EVALUATION AND PRELIMINARY DETERMINATION

Rule 62-210.370	Reports
Rule 62-210.650	Circumvention
Rule 62-210.700(1), (4) & (6)	Excess Emissions
Rule 62-210.900	Forms and Instructions
Rule 62-212.300(3)	General Preconstruction Review Requirements
Rule 62-212.400(2)(d)1.	Prevention of Significant Deterioration
Rule 62-213	Operation Permits for Major Sources of Air Pollution
Rule 62-296.320(2)	General Pollutant Emission Limiting Standards - Objectionable Odors
Rule 62-296.320((4)(c)	General Pollutant Emission Limiting Standards - Unconfined Emissions of Particulate Matter
Rule 62-296.401(1)	Stationary Sources - Emission Standards, Incinerators (<50 TPD charging rate)
Rule 62-296.401(6)	Stationary Sources - Emission Standards, Incinerators - Animal Crematories
Rule 62-297.310	General Test Requirements
Rule 62-297.401	Compliance Test Methods

5. SOURCE IMPACT ANALYSIS

5.1. Emission Limitations

The proposed emissions unit has the potential to emit particulate matter, visible emissions, sulfur dioxide, nitrogen oxides, volatile organic compounds, and carbon monoxide. The permitted pollutant allowable emissions and the compliance procedures for this emissions unit are contained in the draft permit and the following table:

Pollutant	Standard	Test Method
Visible Emissions	No visible emissions (5% opacity)	DEP Method 9
Particulate Matter	≤ 0.080 gr/dscf, corrected to 7% O ₂	EPA Methods 3 and 5
Carbon Monoxide	≤ 100 ppmvd, corrected to 7% O ₂ on an hourly average basis	EPA Methods 3 and 10

Note:

- The equivalent emissions of the regulated pollutants are:

Particulate Matter (PM/PM10):	0.24 lb/hr	1.04 TPY
Carbon Monoxide:	0.04 lb/hr	0.16 TPY
- The potential emissions of the non-regulated pollutants are:

Nitrogen Oxides:	0.30 lb/hr	1.31 TPY
Sulfur Dioxide:	0.002 lb/hr	0.01 TPY
Volatile Organic Compounds:	0.02 lb/hr	0.08 TPY

[Rules 62-296.401(1), 62-296.401(6) and 62-297.401, F.A.C.; and, application received 01/20/98]

TECHNICAL EVALUATION AND PRELIMINARY DETERMINATION

5.2. Control Technology Review

There are no controls associated with the proposed emissions unit. However, the design and operational criteria should be adequate to meet the rule requirements and standards.

5.3. Air Quality

Based on the level of potential emissions, this proposed activity should not cause a violation of any air quality standard or increment.

6. CONCLUSION

Based on the foregoing technical evaluation of the application submitted by Walt Disney World Co., the Department has made a preliminary determination that the proposed project will be in compliance with all applicable state and federal air pollution regulations. The General and Specific Conditions are provided in the attached draft permit conditions of approval.

Permit Engineer: Bruce Mitchell

Reviewed and Approved by Scott Sheplak, P.E.

In the Matter of an
Application for Permit by:

Walt Disney World Co.
P.O. Box 10,000
Lake Buena Vista, Florida 32830-1000

Draft Permit No. 0950111-013-AC
Walt Disney World Resort
Disney's Animal Kingdom: Animal Crematory
Orange County

INTENT TO ISSUE AIR CONSTRUCTION PERMIT

The Department of Environmental Protection (Department) gives notice of its intent to issue an air construction permit (copy of the draft permit attached) for the proposed project, detailed in the application specified above, for the reasons stated below.

The applicant, Walt Disney World Co., applied on January 20, 1998, to the Department for an air construction permit. The construction permit will allow the installation of an animal crematory (incinerator) to dispose of dead animals from both the theme park and from other areas of the Walt Disney World Resort property. The proposed incinerator has a capacity to process 800 pounds per 4-hour period and is a Crawford Model CB800 Animal Carcass Incinerator. The emissions unit will be fired with natural gas.

The Department has permitting jurisdiction under the provisions of Chapter 403, Florida Statutes (F.S.), and Florida Administrative Code (F.A.C.) Chapters 62-4, 62-210, and 62-212. The above actions are not exempt from permitting procedures. The Department has determined that a construction permit is required for the proposed work requested by the applicant.

The Department intends to issue this construction permit based on the belief that reasonable assurances have been provided to indicate that operation of this emissions unit will not adversely impact air quality, and the emissions unit will be in compliance with all appropriate provisions of Chapters 62-4, 62-204, 62-210, 62-212, 62-296, and 62-297, F.A.C.

Pursuant to Section 403.815, F.S., and Rule 62-103.150, F.A.C., you (the applicant) are required to publish at your own expense the enclosed "Public Notice of Intent to Issue Permit". The notice shall be published one time only as soon as possible upon receipt in the legal advertisement section of a newspaper of general circulation in the area affected. For the purpose of these rules, "publication in a newspaper of general circulation in the area affected" means publication in a newspaper meeting the requirements of Sections 50.011 and 50.031, F.S., in the county where the activity is to take place. Where there is more than one newspaper of general circulation in the county, the newspaper used must be one with significant circulation in the area that may be affected by the permit. If you are uncertain that a newspaper meets these requirements, please contact the Department at the address or telephone number listed below. The applicant shall provide proof of publication to the Department's Bureau of Air Regulation, at 2600 Blair Stone Road, Mail Station #5505, Tallahassee, Florida 32399-2400 (Telephone: 850/488-1344; Fax 850/922-6979) within 7 (seven) days of publication. Failure to publish the notice and provide proof of publication within the allotted time may result in the denial of the permit pursuant to Rule 62-103.150 (6), F.A.C.

The Department will issue the final Air Construction Permit in accordance with the conditions of the enclosed draft Air Construction Permit unless a response received in accordance with the following procedures results in a different decision or significant change of terms or conditions.

The Department will accept written comments concerning the proposed draft Air Construction Permit issuance action for a period of 14 (fourteen) days from the date of publication of "PUBLIC NOTICE OF INTENT TO ISSUE PERMIT." Written comments should be provided to the Department's Bureau of Air Regulation, 2600 Blair Stone Road, Mail Station #5505, Tallahassee, Florida 32399-2400. Any written comments filed shall be made available for public inspection. If written comments received result in a

significant change in this draft Air Construction Permit, the Department shall issue a Revised draft Air Construction Permit and require, if applicable, another Public Notice.

The Department will issue the permit with the attached conditions unless a timely petition for an administrative hearing is filed pursuant to Sections 120.569 and 120.57, F.S. Mediation is not available for this action.

A person whose substantial interests are affected by the Department's proposed permitting decision may petition for an administrative hearing in accordance with Sections 120.569 and 120.57, F.S. The petition must contain the information set forth below and must be filed (received) in the Office of General Counsel of the Department, 3900 Commonwealth Boulevard, Mail Station #35, Tallahassee, Florida 32399-3000, telephone: 850/488-9730, fax: 850/487-4938. Petitions must be filed within fourteen days of publication of the public notice or within fourteen days of receipt of this notice of intent, whichever occurs first. A petitioner must mail a copy of the petition to the applicant at the address indicated above, at the time of filing. The failure of any person to file a petition within the appropriate time period shall constitute a waiver of that person's right to request an administrative determination (hearing) under Sections 120.569 and 120.57, F.S., or to intervene in this proceeding and participate as a party to it. Any subsequent intervention will be only at the approval of the presiding officer upon the filing of a motion in compliance with Rule 28-5.207, F.A.C.

A petition must contain the following information: (a) The name, address, and telephone number of each petitioner, the applicant's name and address, the Permit File Number and the county in which the project is proposed; (b) A statement of how and when each petitioner received notice of the Department's action or proposed action; (c) A statement of how each petitioner's substantial interests are affected by the Department's action or proposed action; (d) A statement of the material facts disputed by petitioner, if any; (e) A statement of the facts that the petitioner contends warrant reversal or modification of the Department's action or proposed action; (f) A statement identifying the rules or statutes that the petitioner contends require reversal or modification of the Department's action or proposed action; and, (g) A statement of the relief sought by the petitioner, stating precisely the action that the petitioner wants the Department to take with respect to the action or proposed action addressed in this notice of intent.

Because the administrative hearing process is designed to formulate final agency action, the filing of a petition means that the Department's final action may be different from the position taken by it in this notice of intent. Persons whose substantial interests will be affected by any such final decision of the Department on the application have the right to petition to become a party to the proceeding, in accordance with the requirements set forth above.

In addition to the above, a person subject to regulation has a right to apply for a variance from or waiver of the requirements of particular rules, on certain conditions, under Section 120.542, F.S. The relief provided by this state statute applies only to state rules, not statutes, and not to any federal regulatory requirements. Applying for a variance or waiver does not substitute or extend the time for filing a petition for an administrative hearing or exercising any other right that a person may have in relation to the action proposed in this notice of intent.

The application for a variance or waiver is made by filing a petition with the Office of General Counsel of the Department, 3900 Commonwealth Boulevard, Mail Station #35, Tallahassee, Florida 32399-3000. The petition must specify the following information: (a) The name, address, and telephone number of the petitioner; (b) The name, address, and telephone number of the attorney or qualified representative of the petitioner, if any; (c) Each rule or portion of a rule from which a variance or waiver is requested; (d) The citation to the statute underlying (implemented by) the rule identified in (c) above; (e) The type of action requested; (f) The specific facts that would justify a variance or waiver for the petitioner; (g) The reason why

Intent to Issue Draft Permit No. 0950111-013-AC
Walt Disney World Co.
Page 3 of 3

the variance or waiver would serve the purposes of the underlying statute (implemented by the rule); and, (h) A statement whether the variance or waiver is permanent or temporary and, if temporary, a statement of the dates showing the duration of the variance or waiver requested.

The Department will grant a variance or waiver when the petition demonstrates both that the application of the rule would create a substantial hardship or violate principles of fairness, as each of those terms is defined in Section 120.542(2), F.S., and that the purpose of the underlying statute will be or has been achieved by other means by the petitioner.

Persons subject to regulation pursuant to any federally delegated or approved air program should be aware that Florida is specifically not authorized to issue variances or waivers from any requirements of any such federally delegated or approved program. The requirements of the program remain fully enforceable by the Administrator of the EPA and by any person under the Clean Air Act unless and until the Administrator separately approves any variance or waiver in accordance with the procedures of the federal program.

Executed in Tallahassee, Florida.

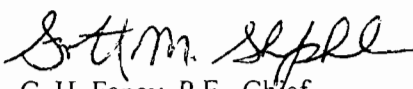
for 
C. H. Fancy, P.E., Chief
Bureau of Air Regulation

CERTIFICATE OF SERVICE

The undersigned duly designated deputy agency clerk hereby certifies that this INTENT TO ISSUE PERMIT (including the PUBLIC NOTICE and the draft permit) was sent by certified mail (*) and copies were mailed by U.S. Mail before the close of business on 2/18/98 to the person(s) listed:

Len Kozlov, CD
Bob Beaver, P.E., Walt Disney World Co.
Richard Bumar, Contact, Walt Disney World Co.

Clerk Stamp

FILING AND ACKNOWLEDGMENT FILED, on this date, pursuant to Section 120.52, F.S., with the designated Department Clerk, receipt of which is hereby acknowledged.

(Clerk) 2/18/98
(Date)

PUBLIC NOTICE OF INTENT TO ISSUE PERMIT

STATE OF FLORIDA
DEPARTMENT OF ENVIRONMENTAL PROTECTION

Draft Permit No. 0950111-013-AC
Walt Disney World Co.: Walt Disney World Resort
Disney's Animal Kingdom
Orange County

The Department of Environmental Protection (Department) gives notice of its intent to issue an air construction permit to Walt Disney World Co., Walt Disney World Resort to install an animal crematory at Disney's Animal Kingdom theme park, specifically at the Necropsy Building, to dispose of dead animals from both the theme park and from other areas within the Walt Disney World Resort property. The proposed incinerator has a capacity to process 800 pounds per 4-hour period and is a Crawford Model CB800 Animal Carcass Incinerator. The emissions unit will be fired with natural gas. The resort is located in Lake Buena Vista, Orange County, Florida. It was determined that new source review pursuant to Prevention of Significant Deterioration (PSD) is not applicable and a Best Available Control Technology determination was not required pursuant to Rule 62-212.400, Florida Administrative Code (F.A.C.). The applicant's name and address are: Walt Disney World Co., P.O. Box 10,000, Lake Buena Vista, Florida 32830-1000.

The Department will issue the final Permit, in accordance with the conditions of the draft Permit unless a response received in accordance with the following procedures results in a different decision or significant change of terms or conditions.

The Department will accept written comments concerning the proposed draft Permit issuance action for a period of fourteen (14) from the date of publication of this Notice. Written comments should be provided to the Department's Bureau of Air Regulation, 2600 Blair Stone Road, Mail Station #5505, Tallahassee, Florida 32399-2400. Any written comments filed shall be made available for public inspection. If written comments received result in a significant change in this draft Permit, the Department shall issue a Revised draft Permit and require, if applicable, another Public Notice.

The Department will issue final Permit with the conditions of the draft Permit unless a timely petition for an administrative hearing is filed pursuant to Sections 120.569 and 120.57, Florida Statutes (F.S.). The procedures for petitioning for a hearing are set forth below. Mediation is not available for this action.

A person whose substantial interests are affected by the Department's proposed permitting decision may petition for an administrative hearing in accordance with Sections 120.569 and 120.57, F.S. The petition must contain the information set forth below and must be filed (received) in the Office of General Counsel of the Department, 3900 Commonwealth Boulevard, Mail Station #35, Tallahassee, Florida 32399-3000, telephone: 850/488-9370, fax: 850/487-4938. Petitions must be filed within fourteen (14) days of publication of the public notice or within fourteen (14) days of receipt of this notice of intent, whichever occurs first. A petitioner must mail a copy of the petition to the applicant at the address indicated above, at the time of filing. The failure of any person to file a petition within the appropriate time period shall constitute a waiver of that person's right to

request an administrative determination (hearing) under Sections 120.569 and 120.57, F.S., or to intervene in this proceeding and participate as a party to it. Any subsequent intervention will be only at the approval of the presiding officer upon the filing of a motion in compliance with Rule 28-5.207, F.A.C.

A petition must contain the following information: (a) The name, address, and telephone number of each petitioner, the applicant's name and address, the Permit File Number and the county in which the project is proposed; (b) A statement of how and when each petitioner received notice of the Department's action or proposed action; (c) A statement of how each petitioner's substantial interests are affected by the Department's action or proposed action; (d) A statement of the material facts disputed by petitioner, if any; (e) A statement of the facts that the petitioner contends warrant reversal or modification of the Department's action or proposed action; (f) A statement identifying the rules or statutes that the petitioner contends require reversal or modification of the Department's action or proposed action; and, (g) A statement of the relief sought by the petitioner, stating precisely the action that the petitioner wants the Department to take with respect to the Department's action or proposed action addressed in this notice of intent.

Because the administrative hearing process is designed to formulate final agency action, the filing of a petition means that the Department's final action may be different from the position taken by it in this notice of intent. Persons whose substantial interests will be affected by any such final decision of the Department on the application have the right to petition to become a party to the proceeding, in accordance with the requirements set forth above.

A complete project file is available for public inspection during normal business hours, 8:00 a.m. to 5:00 p.m., Monday through Friday, except legal holidays, at:

Department of Environmental Protection
Bureau of Air Regulation
111 S. Magnolia Drive, Suite 4
Tallahassee, Florida, 32301
Telephone: 850/488-1344
Fax: 850/922-6979

Department of Environmental Protection
Central District
3319 Maguire Boulevard, Suite 232
Orlando, Florida 32803-3767
Telephone: 407/894-7555
Fax: 407/897-2966

The complete project file includes the application submitted by the responsible official under the seal of a professional engineer registered in the State of Florida, the Technical Evaluation and Preliminary Determination, and the draft Permit. Interested persons may contact Mr. Scott Sheplak, P.E., Administrator, Title V Section, at 111 South Magnolia Drive, Suite 4, Tallahassee, Florida 32301, or call 850/921-9532, for additional information.

Walt Disney World Co.
Walt Disney World Resort Complex
Disney's Animal Kingdom
Facility ID No.: 0950111
Orange County

Animal Crematory at the Necropsy Building
Air Construction Permit
Permit No.: 0950111-013-AC

Permitting Authority:

State of Florida
Department of Environmental Protection
Division of Air Resources Management
Bureau of Air Regulation
Title V Section

Mail Station #5505
2600 Blair Stone Road
Tallahassee, Florida 32399-2400

Telephone: 850/488-1344
Fax: 850/922-6979

Compliance Authority:

State of Florida
Department of Environmental Protection
Central District Office
3319 Maguire Boulevard, Suite 232
Orlando, Florida 32803-3767
Telephone: 407/894-7555
Fax: 407/897-2966

Air Construction Permit
Permit No.: 0950111-013-AC

Table of Contents

Section	Page Number
Placard Page	1
I. Facility Information	2
A. Facility Description.	
B. Summary of Emissions Unit ID No(s). and Brief Description(s).	
C. Relevant Documents.	
II. Facility-wide Conditions	2 - 3
III. Emissions Unit Specific Conditions	3 - 11



Department of Environmental Protection

Lawton Chiles
Governor

Twin Towers Office Building
2600 Blair Stone Road
Tallahassee, Florida 32399-2400

Virginia B. Wetherell
Secretary

Permittee:

Walt Disney World Co.
P.O. Box 10,000
Orlando, Florida 32830-1000

Construction Permit No.: 0950111-013-AC

Facility ID No.: 0950111

SIC Nos.: 79, 7996

Expiration Date: December 31, 1999

Project: Air Construction Permit for an
Animal Crematory

This permit is for the construction/installation of an animal crematory at Disney's Animal Kingdom theme park, specifically at the Necropsy Building, to dispose of dead animals from both the theme park and from other areas within the Walt Disney World Resort property. The proposed incinerator has a capacity to process 800 pounds per 4-hour period and is a Crawford Model CB800 Animal Carcass Incinerator. The emissions unit will be fired with natural gas. The resort is located at 1375 Buena Vista Drive, Orange and Osceola Counties. UTM Coordinates: Zone 17, 449.70 km East and 3138.00 km North; Latitude: 28° 22' 24" North and Longitude: 81° 32' 46" West.

This air construction permit is issued under the provisions of Chapter 403, Florida Statutes (F.S.), and Florida Administrative Code (F.A.C.) Chapters 62-4, 62-210, 62-212, 62-296 and 62-297. The above named permittee is hereby authorized to perform the work or construct/install the facility shown on the application and approved drawing(s), plans, and other documents, attached hereto or on file with the Department of Environmental Protection (Department), in accordance with the terms and conditions of this permit.

Referenced attachments made a part of this permit:

APPENDIX TV-1, TITLE V CONDITIONS (version dated 12/02/97)
APPENDIX SS-1, STACK SAMPLING FACILITIES (dated 10/07/96)
TABLE 297.310-1, CALIBRATION SCHEDULE (dated 10/07/96)

Howard L. Rhodes, Director
Division of Air Resources
Management

HLR/sms/bm

"Protect, Conserve and Manage Florida's Environment and Natural Resources"

Section I. Facility Information.

Subsection A. Facility Description.

The facility is a complex of hotels, theme parks and support facilities, and a utility. The various air pollution sources are boilers, a combined cycle combustion turbine with a natural gas-fired heat recovery steam generator, paint spray booths and associated operations, external combustion oil heaters and hot water heaters.

Based on the initial Title V permit application received June 12, 1996, this facility is a major source of hazardous air pollutants (HAPs).

Subsection B. Summary of Emissions Unit ID No(s). and Brief Description(s).

-xxx Crawford Model CB800 Animal Carcass Incinerator

Please reference the Permit No., Facility ID No., and appropriate Emissions Unit(s) ID No(s). on all correspondence, test report submittals, applications, etc.

Subsection C. Relevant Documents.

The document(s) listed below are not a part of this permit; however, they are specifically related to this permitting action.

These documents are provided to the permittee for information purposes only:
Appendix A-1, Abbreviations, Acronyms, Citations, and Identification Numbers

These documents are on file with the permitting authority:
Construction Permit Application received January 20, 1998

Section II. Facility-wide Conditions.

The following conditions apply facility-wide:

1. APPENDIX TV-1, TITLE V CONDITIONS, is a part of this permit.
{Permitting note: APPENDIX TV-1, TITLE V CONDITIONS, is distributed to the permittee only. Other persons requesting copies of these conditions shall be provided a copy when requested or otherwise appropriate.}
2. General Pollutant Emission Limiting Standards. Objectionable Odor Prohibited. No person shall cause, suffer, allow, or permit the discharge of air pollutants which cause or contribute to an objectionable odor.
[Rules 62-296.320(2) and 62-296.401(1)(b), F.A.C.]

3. General Pollutant Emission Limiting Standards. Volatile Organic Compounds (VOC) Emissions or Organic Solvents (OS) Emissions. The permittee shall allow no person to store, pump, handle, process, load, unload or use in any process or installation, volatile organic compounds or organic solvents without applying known and existing vapor emission control devices or systems deemed necessary and ordered by the Department.

[Rule 62-296.320(1)(a), F.A.C.]

4. Reasonable precautions to prevent emissions of unconfined particulate matter at this facility during operations include: chemical or water application to unpaved roads, unpaved yard areas, and storage piles; paving and maintenance of roads, parking areas and plant grounds; landscaping and planting of vegetation; confining abrasive blasting where possible; and other techniques, as necessary. Also, for the solid waste disposal area, wetting agents shall be applied.

[Rule 62-296.320(4)(c)2., F.A.C]

5. When appropriate, any recording, monitoring, or reporting requirements that are time-specific shall be in accordance with the effective date of the permit, which defines day one.

[Rule 62-213.440, F.A.C.]

6. The permittee shall submit all compliance related notifications and reports required of this permit to the Department's Central District office at the following address:

Department of Environmental Protection
Central District Office
3319 Maguire Boulevard, Suite 232
Orlando, Florida 32803-3767
Telephone: 407/894-7555
Fax: 407/897-2966

III. Specific Emission Limiting and Performance Standards.

General.

A. The following Specific Conditions are applicable to the animal crematory, Crawford Model CD800 Animal Carcass Incinerator, located at Disney's Animal Kingdom, specifically at the Necropsy Building:

Essential Potential to Emit (PTE) Parameters.

1. Permitted Capacity.

- a. The emissions unit's processing capacity shall not exceed 800 lbs per four-hour period (equivalent to 200 lbs/hr); and,
- b. The emissions unit's maximum heat input shall not exceed 3.0 MMBtu/hr while firing only natural gas.

* [Rules 62-4.070, 62-4.160(2), 62-296.401(1), and 62-297.310(2)(b), F.A.C.]

2. Emissions Unit Operating Rate Limitation After Testing. See specific condition 28.

[Rule 62-297.310(2), F.A.C.]

3. Hours of operation. The emissions unit is allowed to operate continuously, i.e., 8760 hours per year.

[Rule 62-21.200, Definitions - Potential to Emit (PTE), F.A.C.]

4. Methods of Operation - Fuels. The only fuel authorized to be burned is natural gas.

[Rules 62-4.160(2) and 62-210.200 (PTE), F.A.C.]

Emission Limitations and Standards.

5. Visible emissions. No visible emissions (5 percent opacity) except that visible emissions not exceeding 20 percent opacity are allowed for up to three minutes in any one-hour period.

[Rule 62-296.401(1)(a), F.A.C.]

6. Particulate matter. Particulate matter emissions shall not exceed 0.080 grains per dry standard cubic foot of flue gas, corrected to 7% O₂.

[Rule 62-296.401(6)(a), F.A.C.]

7. Carbon monoxide. Carbon monoxide (CO) emissions shall not exceed 100 parts per million by volume (ppmv), dry basis, corrected to 7% O₂ on an hourly average basis.

[Rule 62-296.401(6)(b), F.A.C.]

8. Operation Residence Time and Temperature(s). The design of the secondary chamber combustion zone shall be such that it has a minimum residence time of 1.0 seconds at 1800 degrees Fahrenheit (°F). The actual operating temperature of the secondary chamber combustion zone shall be no less than 1600 °F throughout the combustion process in the primary chamber. Cremation in the primary chamber shall not begin unless the secondary chamber combustion zone temperature is equal to or greater than 1600 °F.

[Rule 62-296.401(6)(c), F.A.C.]

Excess Emissions

9. Excess emissions resulting from startup, shutdown or malfunction of any emissions unit shall be permitted provided that best operational practices to minimize emissions are adhered to and the duration of excess emissions shall be minimized but in no case exceed two hours in any 24-hour period unless specifically authorized by the Department for longer duration.

[Rule 62-210.700(1), F.A.C.]

10. Excess emissions which are caused entirely or in part by poor maintenance, poor operation, or any other equipment or process failure which may reasonably be prevented during startup, shutdown or malfunction shall be prohibited.

[Rule 62-210.700(4), F.A.C.]

Operations.

11. This emissions unit is permitted to incinerate only dead animals and, if applicable, the bedding and the remains associated with the animals placed in leak-proof containers. Containers may contain up to 0.5 percent by weight chlorinated plastics. Plastic bags used for the incineration of animals shall be nonchlorinated and no less than 3 mils thick. If containers are incinerated, documentation from the manufacturers certifying that they are composed of 0.5 percent or less by weight chlorinated plastics must be kept on-file at the site for the duration of their use and for at least five years after their use. This documentation must also be submitted with any application for renewal air operation permit.

[Rules 62-213.440 and 296.401(6)(e), F.A.C.]

12. This emissions unit is not permitted to cremate dead animals which were used for medical or commercial experimentation. No other material, including biomedical waste* as defined in Rule 62-210.200, F.A.C., shall be incinerated.

[Rule 62-296.401(6)(f), F.A.C.]

* "**Biomedical Waste**": Any solid waste or liquid waste which may present a threat of infection to humans, including nonliquid tissue, body parts, blood, blood products, and body fluids from humans and other primates; laboratory and veterinary wastes which contain human disease-causing agents; and, discarded sharps. The following are also included:

(a) Used absorbent materials saturated with blood, blood products, body fluids, or excretions or secretions contaminated with visible blood; and, absorbent materials saturated with blood or blood products that have dried.

(b) Non-absorbent, disposable devices that have been contaminated with blood, body fluids, or secretions or excretions visibly contaminated with blood, but have not been treated by a method listed in Section 381.0098, F.S., or a method approved pursuant to Rule 64E-16, F.A.C.

[Rule 62-210.200, F.A.C.]

Training.

13. Operators of the incinerator shall be trained by the equipment manufacturer's representatives or an equivalent state-approved organization. The content of the training program shall be submitted to the Department of Environmental Protection, Bureau of Air Regulation for approval.

[Rule 62-296.401(6)(g), F.A.C.]

14. The content of the training program shall be submitted to the Department for approval through the permitting process and shall meet, at a minimum, the criteria applicable to cremation set forth in the EPA Medical Waste Incinerator Operator Training Program Course Handbook, EPA 453/B-93-018, and Instructor's Guide, EPA 453/B-93-019.

[Rule 62-296.401(6)(g)1., F.A.C.]

15. A copy of the training certificate for each operator having satisfactorily completed the Department-approved training program must be submitted to the Department within 15 days of training. The owner of any new crematory units shall submit copies of the operator certificates within 15 days after completion of the initial compliance test pursuant to the unit's construction permit.

[Rule 62-296.401(6)(g)2., F.A.C.]

16. An operator's certificate must be kept on file at the facility for the duration of the operator's employment and for an additional five years after termination of employment.

[Rules 62-213.440 and 62-296.401(6)(g)3.,F.A.C.]

Monitoring of Operations.

17. Determination of Process Variables.

(a) Required Equipment. The owner or operator of an emissions unit for which compliance tests are required shall install, operate, and maintain equipment or instruments necessary to determine process variables, such as process weight input or heat input, when such data are needed in conjunction with emissions data to determine the compliance of the emissions unit with applicable emission limiting standards.

(b) Accuracy of Equipment. Equipment or instruments used to directly or indirectly determine process variables, including devices such as belt scales, weight hoppers, flow meters, and tank scales, shall be calibrated and adjusted to indicate the true value of the parameter being measured with sufficient accuracy to allow the applicable process variable to be determined within 10% of its true value.

[Rule 62-297.310(5), F.A.C.]

Test Methods and Procedures.

18. The incinerator must be tested in its normal operating mode. In order for the permittee to be allowed to incinerate bedding, bags, or containers, these items shall be incinerated in normal amounts along with the animal remains during the compliance test burns. An incinerator which burns only animal remains during the compliance tests shall be permitted to incinerate only animal remains until a test determines compliance while incinerating bedding, bags, or containers along with the animal remains.

[Rule 62-4.070(3), F.A.C.]

19. Visible Emissions. The permittee shall have an initial and formal compliance test for visible emissions conducted during each federal fiscal year (October 1 - September 30).

[Rules 62-296.401(6)(j)1. and 62-297.310(7)(a)4.a.,F.A.C.]

20. Visible Emissions. Compliance with the visible emissions limitation shall be determined by using DEP Method 9, incorporated in Chapter 62-297, F.A.C.

[Rules 62-296.401(6)(h)1. and 62-297.401(9)(c),F.A.C.]

21. Visible Emissions. The required minimum period of observation for an opacity compliance test shall be sixty (60) minutes. The opacity test observation period shall begin when incineration begins in the primary chamber.

[Rule 62-297.310(4)(a)2.,F.A.C.]

22. Particulate Matter, Carbon Monoxide, and Oxygen. The permittee shall have an initial compliance test for particulate matter, carbon monoxide, and oxygen; after that, a compliance test shall be conducted prior to renewing the operation permit.

[Rules 62-296.401(6)(j)2. and 62-297.310(7)(a)3.,F.A.C.]

23. Particulate Matter. Compliance with the particulate matter emission limitation shall be determined by using EPA Method 5, incorporated and adopted by reference in Chapter 62-297, F.A.C. The minimum sample volume shall be 30 dry standard cubic feet.
[Rule 62-296.401(6)(h)4.,F.A.C.]

24. Carbon Monoxide. Compliance with the carbon monoxide emission limitation shall be determined by using EPA Method 10, incorporated and adopted by reference in Chapter 62-297, F.A.C.
[Rule 62-296.401(6)(h)2.,F.A.C.]

25. Oxygen. The oxygen concentration shall be determined by using EPA Method 3, incorporated and adopted by reference in Chapter 62-297, F.A.C.
[Rule 62-296.401(6)(h)3.,F.A.C.]

26. Test procedures shall meet all applicable requirements of Chapter 62-297, F.A.C.
[Rule 62-296.401(6)(h)5.,F.A.C.]

27. Required Number of Test Runs. For mass emission limitations, a compliance test shall consist of three complete and separate determinations of the total air pollutant emission rate through the test section of the stack or duct and three complete and separate determinations of any applicable process variables corresponding to the three distinct time periods during which the stack emission rate was measured provided, however, that three complete and separate determinations shall not be required if the process variables are not subject to variation during a compliance test, or if three determinations are not necessary in order to calculate the unit's emission rate. The three required test runs shall be completed within one consecutive five day period. In the event that a sample is lost or one of the three runs must be discontinued because of circumstances beyond the control of the owner or operator, and a valid third run cannot be obtained within the five day period allowed for the test, the Secretary or his or her designee may accept the results of the two complete runs as proof of compliance, provided that the arithmetic mean of the results of the two complete runs is at least 20 percent below the allowable emission limiting standards.
[Rule 62-297.310(1), F.A.C.]

28. Operating Rate During Testing. Testing of emissions shall be conducted with each emissions unit operation at permitted capacity, which is defined as 90 to 100 percent of the maximum operation rate allowed by the permit. If it is impracticable to test at permitted capacity, an emissions unit may be tested at less than the minimum permitted capacity; in this case, subsequent emissions unit operation is limited to 110 percent of the test load until a new test is conducted. Once the emissions unit is so limited, operation at higher capacities is allowed for no more than 15 consecutive days for the purpose of additional compliance testing to regain the authority to operate at the permitted capacity.
[Rules 62-297.310(2) & (2)(a), F.A.C.]

29. Calculation of Emission Rate. The indicated emission rate or concentration shall be the arithmetic average of the emission rate or concentration determined by each of the separate test runs unless otherwise specified in a particular test method or applicable rule.
[Rule 62-297.310(3), F.A.C.]

30. Applicable Test Procedures.

(a) Required Sampling Time.

1. Unless otherwise specified in the applicable rule, the required sampling time for each test run shall be no less than one hour and no greater than four hours, and the sampling time at each sampling point shall be of equal intervals of at least two minutes.
2. Opacity Compliance Tests. When either EPA Method 9 or DEP Method 9 is specified as the applicable opacity test method, the required minimum period of observation for a compliance test shall be sixty (60) minutes for emissions units which emit or have the potential to emit 100 tons per year or more of particulate matter, and thirty (30) minutes for emissions units which have potential emissions less than 100 tons per year of particulate matter and are not subject to a multiple-valued opacity standard. The opacity test observation period shall include the period during which the highest opacity emissions can reasonably be expected to occur. Exceptions to these requirements are as follows:
 - c. The minimum observation period for opacity tests conducted by employees or agents of the Department to verify the day-to-day continuing compliance of a unit or activity with an applicable opacity standard shall be twelve minutes.

(b) Minimum Sample Volume. Unless otherwise specified in the applicable rule, the minimum sample volume per run shall be 25 dry standard cubic feet.

(d) Calibration of Sampling Equipment. Calibration of the sampling train equipment shall be conducted in accordance with the schedule shown in Table 297.310-1 (attached).

[Rule 62-297.310(4), F.A.C.]

31. Required Stack Sampling Facilities. When a mass emissions stack test is required, the permittee shall comply with the requirements contained in Appendix SS-1, Stack Sampling Facilities, attached to this permit.

[Rule 62-297.310(6), F.A.C.]

32. Frequency of Compliance Tests. The following provisions apply only to those emissions units that are subject to an emissions limiting standard for which compliance testing is required.

(a) General Compliance Testing.

3. The owner or operator of an emissions unit that is subject to any emission limiting standard shall conduct a compliance test that demonstrates compliance with the applicable emission limiting standard prior to obtaining a renewed operation permit. Emissions units that are required to conduct an annual compliance test may submit the most recent annual compliance test to satisfy the requirements of this provision. In renewing an air operation permit pursuant to Rule 62-210.300(2)(a)3.b., c., or d., F.A.C., the Department shall not require submission of emission compliance test results for any emissions unit that, during the year prior to renewal:
 - a. Did not operate; or,
 - b. In the case of a fuel burning emissions unit, burned liquid fuel for a total of no more than 400 hours.

4. During each federal fiscal year (October 1 - September 30), unless otherwise specified by rule, order, or permit, the owner or operator of each emissions unit shall have a formal compliance test conducted for:
 - a. Visible emissions, if there is an applicable standard;
 - b. Each of the following pollutants, if there is an applicable standard, and if the emissions unit emits or has the potential to 100 tons per year or more of any other regulated air pollutant
 9. The owner or operator shall notify the Department, at least 15 days prior to the date on which each formal compliance test is to begin, of the date, time, and place of each such test, and the test contact person who will be responsible for coordinating and having such test conducted for the owner or operator.
- (b) Special Compliance Tests. When the Department, after investigation, has good reason (such as complaints, increased visible emissions or questionable maintenance of control equipment) to believe that any applicable emission standard contained in a Department rule or in a permit issued pursuant to those rules is being violated, it may require the owner or operator of the emissions unit to conduct compliance tests which identify the nature and quantity of pollutant emissions from the emissions unit and to provide a report on the results of said tests to the Department.
- (c) Waiver of Compliance Test Requirements. If the owner or operator of an emissions unit that is subject to a compliance test requirement demonstrates to the Department, pursuant to the procedure established in Rule 62-297.620, F.A.C., that the compliance of the emissions unit with an applicable weight emission limiting standard can be adequately determined by means other than the designated test procedure, such as specifying a surrogate standard of no visible emissions for particulate matter sources equipped with a bag house or specifying a fuel analysis for sulfur dioxide emissions, the Department shall waive the compliance test requirements for such emissions units and order that the alternate means of determining compliance be used, provided, however, the provisions of Rule 62-297.310(7)(b), F.A.C., shall apply.

[Rule 62-297.310(7), F.A.C.; and, SIP approved]

33. Compliance Demonstration. Compliance with the carbon monoxide and particulate emission standards may be demonstrated by submission of a test report for an identical (same make, model, and permitted capacity) crematory unit operating in compliance with a valid Department air permit and tested pursuant to that permit. The test data in the test report must be less than five years old and may or may not be obtained from the unit that is being permitted.

[Rule 62-296.401(6)(k), F.A.C.]

Continuous Emissions Monitoring Requirements.

34. Continuous Emissions Monitoring Requirements. The permittee shall install, operate, and maintain on the animal crematory continuous monitors to record temperature at the point or beyond where 1.0 second gas retention time is obtained in the secondary combustion zone in accordance with the manufacturer's instructions. A complete file of all measurements, including continuous monitoring system, monitoring device, and performance testing measurements; all continuous monitoring system performance evaluations; all continuous monitoring system or monitoring device calibration checks; and adjustments, preventive maintenance, and corrective maintenance performed on these systems or devices, shall be recorded in a permanent legible form available for

inspection. Combustion temperature monitoring documentation shall include operator name, operator indication of when cremation in the primary chamber begins, date, time, and temperature markings. The file shall be retained for at least five years following the recording of such measurements, reports, and records.

[Rules 62-213.440 and 62-296.401(6)(l), F.A.C.]

Reports and Recordkeeping.

35. In the case of excess emissions resulting from malfunctions, each owner or operator shall notify the Department in accordance with Rule 62-4.130, F.A.C. A full written report on the malfunctions shall be submitted in a quarterly report, if requested by the Department.

[Rule 62-210.700(6), F.A.C.]

36. Test Reports.

- (a) The owner or operator of an emissions unit for which a compliance test is required shall file a report with the Department on the results of each such test.
- (b) The required test report shall be filed with the Department as soon as practical but no later than 45 days after the last sampling run of each test is completed.
- (c) The test report shall provide sufficient detail on the emissions unit tested and the test procedures used to allow the Department to determine if the test was properly conducted and the test results properly computed. As a minimum, the test report, other than for an EPA Method 9 test, shall provide the following information:
 1. The type, location, and designation of the emissions unit tested.
 2. The facility at which the emissions unit is located.
 3. The owner or operator of the emissions unit.
 4. The normal type and amount of fuels used and materials processed, and the types and amounts of fuels used and material processed during each test run.
 5. The means, raw data and computations used to determine the amount of fuels used and materials processed, if necessary to determine compliance with an applicable emission limiting standard.
 6. The type of air pollution control devices installed on the emissions unit, their general condition, their normal operating parameters (pressure drops, total operating current and GPM scrubber water), and their operating parameters during each test run.
 7. A sketch of the duct within 8 stack diameters upstream and 2 stack diameters downstream of the sampling ports, including the distance to any upstream and downstream bends or other flow disturbances.
 8. The date, starting time and duration of each sampling run.
 9. The test procedures used, including any alternative procedures authorized pursuant to Rule 62-297.620, F.A.C. Where optional procedures are authorized in this chapter, indicate which option was used.
 10. The number of points sampled and configuration and location of the sampling plane.
 11. For each sampling point for each run, the dry gas meter reading, velocity head, pressure drop across the stack, temperatures, average meter temperatures and sample time per point.
 12. The type, manufacturer and configuration of the sampling equipment used.
 13. Data related to the required calibration of the test equipment.
 14. Data on the identification, processing and weights of all filters used.

15. Data on the types and amounts of any chemical solutions used.
16. Data on the amount of pollutant collected from each sampling probe, the filters, and the impingers, are reported separately for the compliance test.
17. The names of individuals who furnished the process variable data, conducted the test, analyzed the samples and prepared the report.
18. All measured and calculated data required to be determined by each applicable test procedure for each run.
19. The detailed calculations for one run that relate the collected data to the calculated emission rate.
20. The applicable emission standard, and the resulting maximum allowable emission rate for the emissions unit, plus the test result in the same form and unit of measure.
21. A certification that, to the knowledge of the owner or his authorized agent, all data submitted are true and correct. When a compliance test is conducted for the Department or its agent, the person who conducts the test shall provide the certification with respect to the test procedures used. The owner or his authorized agent shall certify that all data required and provided to the person conducting the test are true and correct to his knowledge.

[Rule 62-297.310(8), F.A.C.]



WALT DISNEY World Co.

RECEIVED

JAN 20 1998

BUREAU OF
AIR REGULATION

January 19, 1998

Mr. Clair Fancy
Chief, Bureau of Air Regulation
Florida Department of Environmental Protection
2600 Blair Stone Road
Tallahassee, Florida 32399-2400

RE: Construction Permit Application
Disney's Animal Kingdom Theme Park
CB800 Incinerator

Dear Mr. Fancy:

Enclosed are three copies of the air construction permit application and three ELSA submission diskettes for the above referenced emissions unit. The fourth copy has been sent to Mr. Len Kozlov at the Central District office to facilitate the review of the application. No fee is included, since this application is for a minor Title V modification, in accordance with 62-4.050(4)(a)2, F.A.C.

Since this application will be the first construction permit that I have applied for with your office (previous air construction permit applications were processed by the Central District), I have discussed this permit application with Mr. Bruce Mitchell prior to its completion. He provided me with assistance to ensure the completeness of the application.

It is requested that this permitting action is kept separate from the Walt Disney World Title V permit at this time. We will apply to incorporate the emissions unit into the Title V permit through a separate permitting action at a later date, after construction and stack testing have been completed.

If you have any questions or need any further information, please call me at 407-827-2748.

Sincerely,

Rich Bumar
Environmental Control Representative
Environmental Control Department

Enclosure

P.O. Box 10,000 / Lake Buena Vista, Florida 32830-1000

Part of the Magic of The WALT DISNEY Company



Clair Fancy
Page 2
January 19, 1998

cc: Bob Beaver (w/o enclosure)
Bruce Mitchell
Lee Schmudde (w/o enclosure)

**AIR CONSTRUCTION PERMIT
APPLICATION**

RECEIVED

JAN 20 1998

BUREAU OF
AIR REGULATION

**WALT DISNEY WORLD CO.
FACILITY ID NUMBER 0950111**

**DISNEY'S ANIMAL KINGDOM
MODEL CB800 INCINERATOR**

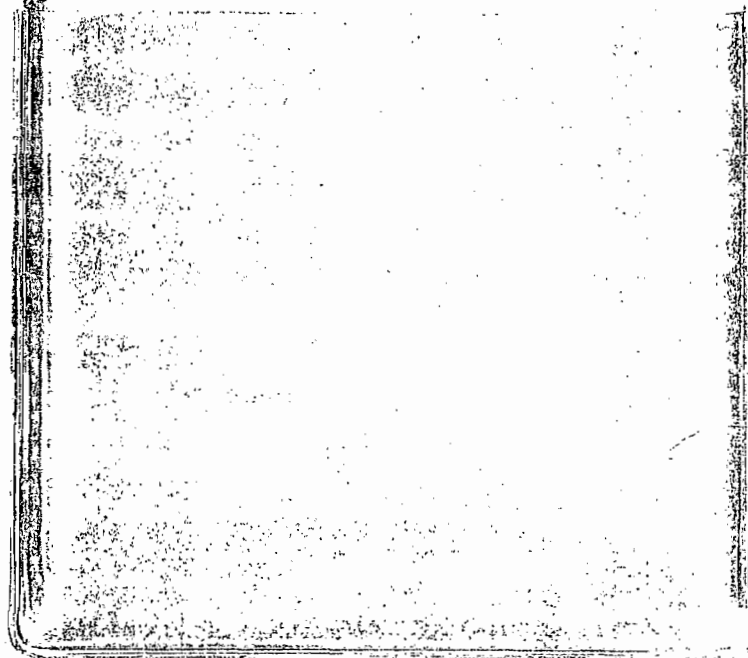

TABLE OF CONTENTS

TABLE OF CONTENTS

I.	APPLICATION INFORMATION	
	FACILITY IDENTIFICATION	I. PART 1
	AUTHORIZED REPRESENTATIVE	I. PART 2
	SCOPE OF APPLICATION	I. PART 3
	PURPOSE OF APPLICATION	I. PART 4
	APPLICATION PROCESSING FEE	I. PART 5
	PROFESSIONAL ENGINEER CERTIFICATION	I. PART 5-6
	APPLICATION CONTACT	I. PART 7
II.	FACILITY INFORMATION	
	FACILITY NAME, LOCATION, AND TYPE	II. PART 1
	FACILITY CONTACT	II. PART 1
	FACILITY REGULATORY CLASSIFICATIONS	II. PART 2
	FACILITY REGULATIONS	II. PART 3
	FACILITY POLLUTANT INFORMATION	II. PART 4
	FACILITY SUPPLEMENTAL INFORMATION	II. PART 5
III.	EMISSIONS UNIT INFORMATION SECTIONS 1-8	
	TYPE	III. PART 1
	DESCRIPTION AND STATUS	III. PART 2
	CONTROL EQUIPMENT	III. PART 3
	DETAIL INFORMATION	III. PART 4
	OPERATING CAPACITY	III. PART 4
	OPERATING SCHEDULE	III. PART 4
	RULE APPLICABILITY ANALYSIS	III. PART 6a
	LIST OF APPLICABLE REGULATIONS	III. PART 6bpp. 1-2
	EMISSION POINT DESCRIPTION AND TYPE	III. PART 7
	SEGMENT DESCRIPTION AND RATE	III. PART 8
	EMISSIONS UNIT POLLUTANTS.....	III. PART 9a
	POLLUTANT POTENTIAL/ESTIMATED EMISSIONS ...	III. PART 9bpp. 1-5
	ALLOWABLE EMISSIONS	III. PART 9cpp. 1-5
	VISIBLE EMISSIONS INFORMATION.....	III. PART 10
	CONTINUOUS MONITOR INFORMATION	III. PART 11
	PSD TRACKING INFORMATION	III. PART 12pp. 1-2
	SUPPLEMENTAL INFORMATION.....	III. PART 13pp. 1-2

SUPPLEMENTAL INFORMATION

AREA MAP SHOWING FACILITY LOCATION	ATTACHMENT A
FACILITY PLOT PLAN.....	ATTACHMENT B
PROCESS FLOW DIAGRAM	ATTACHMENT C
MODEL CB800 INCINERATOR SPECIFICATIONS	ATTACHMENT D
EMISSIONS CALCULATIONS AND AP-42 FACTORS	ATTACHMENT E

APPLICATION INFORMATION

**Department of
Environmental Protection**

**DIVISION OF AIR RESOURCES MANAGEMENT
APPLICATION FOR AIR PERMIT - LONG FORM**

I. APPLICATION INFORMATION

Identification of Facility Addressed in This Application

1. Facility Owner/Company Name : Walt Disney World Co.	
2. Site Name : Walt Disney World Resort	
3. Facility Identification Number : 0950111	<input type="checkbox"/> Unknown
4. Facility Location : This site is located in the Walt Disney World Resort at Disney's Animal Kingdom (DAK) Theme Park. Street Address or Other Locator : P.O. Box 10,000 City : Lake Buena Vista County : Orange Zip Code : 32830-1000	
5. Relocatable Facility? <input type="checkbox"/> Yes <input checked="" type="checkbox"/> No	6. Existing Permitted Facility? <input checked="" type="checkbox"/> Yes <input type="checkbox"/> No

I. Part 1 - 1

Owner/Authorized Representative or Responsible Official

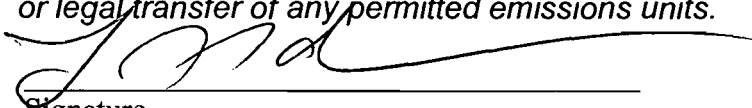
1. Name and Title of Owner/Authorized Representative or Responsible Official : Name : Lee Schmudde Title : Vice President, Legal
2. Owner or Authorized Representative or Responsible Official Mailing Address : Organization/Firm : Walt Disney World Co. Street Address : P.O. Box 10,000 City : Lake Buena Vista State : FL Zip Code : 32830-1000
3. Owner/Authorized Representative or Responsible Official Telephone Numbers : Telephone : (407)828-3701 Fax : (407)828-3239
4. Owner/Authorized Representative or Responsible Official Statement : <i>I, the undersigned, am the owner or authorized representative* of the non-Title V source addressed in this Application for Air Permit or the responsible official, as defined in Rule 62-210.200, F.A.C., of the Title V source addressed in this application, whichever is applicable. I hereby certify, based on information and belief formed after reasonable inquiry, that the statements made in this application are true, accurate and complete and that, to the best of my knowledge, any estimates of emissions reported in this application are based upon reasonable techniques for calculating emissions. The air pollutant emissions units and air pollution control equipment described in this application will be operated and maintained so as to comply with all applicable standards for control of air pollutant emissions found in the statutes of the State of Florida and rules of the Department of Environmental Protection and revisions thereof. I understand that a permit, if granted by the Department, cannot be transferred without authorization from the Department, and I will promptly notify the Department upon sale or legal transfer of any permitted emissions units.</i>  Signature 1-16-98 Date

* Attach letter of authorization if not currently on file.

Scope of Application

Emissions Unit ID	Description of Emissions Unit	Permit Type
No Id	Necropsy Building- Crawford Model CB800 Animal Crematory	AC1F

Purpose of Application and Category

Category I : All Air Operation Permit Applications Subject to Processing Under Chapter 62-213, F.A.C.

This Application for Air Permit is submitted to obtain :

] Initial air operation permit under Chapter 62-213, F.A.C., for an existing facility which is classified as a Title V source.

] Initial air operation permit under Chapter 62-213, F.A.C., for a facility which, upon start up of one or more newly constructed or modified emissions units addressed in this application, would become classified as a Title V source.

Current construction permit number :

] Air operation permit renewal under Chapter 62-213, F.A.C., for a Title V source.

Operation permit to be renewed :

] Air operation permit revision for a Title V source to address one or more newly constructed or modified emissions units addressed in this application.

Current construction permit number :

Operation permit to be revised :

] Air operation permit revision or administrative correction for a Title V source to address one or more proposed new or modified emissions units and to be processed concurrently with the air construction permit application.

Operation permit to be revised/corrected :

-] Air operation permit revision for a Title V source for reasons other than construction or modification of an emissions unit.

Operation permit to be revised :

Reason for revision :

Category II : All Air Operation Permit Applications Subject to Processing Under Rule 62-210.300(2)(b), F.A.C.

This Application for Air Permit is submitted to obtain :

-] Initial air operation permit under Rule 62-210.300(2)(b), F.A.C., for an existing facility seeking classification as a synthetic non-Title V source.

Current operation/construction permit number(s) :

-] Renewal air operation permit under Rule 62-210.300(2)(b), F.A.C., for a synthetic non-Title V source.

Operation permit to be renewed :

-] Air operation permit revision for a synthetic non-Title V source.

Operation permit to be revised :

Reason for revision :

Category III : All Air Construction Permit Applications for All Facilities and Emissions Units

This Application for Air Permit is submitted to obtain :

-] Air construction permit to construct or modify one or more emissions units within a facility (including any facility classified as a Title V source).

I. Part 4 - 2

Current operation permit number(s), if any :

- Air construction permit to make federally enforceable an assumed restriction on the potential emissions of one or more existing, permitted emissions units.

Current operation permit number(s) :

- Air construction permit for one or more existing, but unpermitted, emissions units.

Application Processing Fee

Check one :

Attached - Amount : _____

Not Applicable.

Construction/Modification Information

1. Description of Proposed Project or Alterations :

Disney's Animal Kingdom is a new theme park within the Walt Disney World Resort complex. The new theme park will include live animal exhibits, rides, shows, restaurants, merchandise locations, and staff support facilities. The proposed air emission source to be installed is a Crawford model CB800 animal carcass incinerator that will be used to dispose of dead animals from both the theme park and from other areas within the Walt Disney World Resort property.

This emissions source is designated DAK-9. The emissions source is fired only with natural gas and has a total maximum heat input rating of 3.0 MMBtu/hr.

The proposed unit will cause an overall increase in annual potential emissions from the Walt Disney World Resort complex as follows:

CO: 0.18 tpy , NOx: 1.31 tpy, PM/PM10: 0.65 tpy, SO2: 0.01 tpy, VOC/TOC: 0.08 tpy

2. Projected or Actual Date of Commencement of Construction : 01-Mar-1998

3. Projected Date of Completion of Construction : 31-Mar-1998

Professional Engineer Certification

1. Professional Engineer Name : Bob Beaver
Registration Number : 32528

2. Professional Engineer Mailing Address :

Organization/Firm : Walt Disney World Co.

Street Address : P.O. Box 10,000

City : Lake Buena Vista

State : FL Zip Code : 32830-1000

3. Professional Engineer Telephone Numbers :

Telephone : (407)828-1584

Fax : (407)934-7297

4. Professional Engineer Statement :

I, the undersigned, hereby certified, except as particularly noted herein, that :*

(1) To the best of my knowledge, there is reasonable assurance that the air pollutant emissions unit(s) and the air pollutant control equipment described in this Application for Air Permit, when properly operated and maintained, will comply with all applicable standards for control of air pollutant emissions found in the Florida Statutes and rules of the Department of Environmental Protection; and

(2) To the best of my knowledge, any emission estimates reported or relied on in this application are true, accurate, and complete and are either based upon reasonable techniques available for calculating emissions or, for emission estimates of hazardous air pollutants not regulated for an emissions unit addressed in this application, based solely upon the materials, information and calculations submitted with this application.

If the purpose of this application is to obtain a Title V source air operation permit (check here [] if so), I further certify that each emissions unit described in this Application for Air Permit, when properly operated and maintained, will comply with the applicable requirements identified in this application to which the unit is subject, except those emissions units for which a compliance schedule is submitted with this application.

If the purpose of this application is to obtain an air construction permit for one or more proposed new or modified emissions units (check here [] if so), I further certify that the engineering features of each such emissions unit described in this application have been designed or examined by me or individuals under my direct supervision and found to be in conformity with sound engineering principles applicable to the control of emissions of the air pollutants characterized in this application.

If the purpose of this application is to obtain an initial air operation permit or operation permit revision for one or more newly constructed or modified emissions units (check here [] if so), I further certify that, with the exception of any changes detailed as part of this application, each such emissions has been constructed or modified in substantial accordance with the information given in the corresponding application for air construction permit and with all provisions contained in such permit.

 A circular seal for a Professional Engineer in the State of Florida. The seal contains the text "STATE OF FLORIDA", "PROFESSIONAL ENGINEER", and "ID BEAR". A signature is written across the seal.
Signature _____

Date 6/16/98

* Attach any exception to certification statement.

I. Part 6 - 1

DEP Form No. 62-210.900(1) - Form

Effective : 3-21-96

Application Contact

1. Name and Title of Application Contact : Name : Richard Bumar, E.I. Title : Environmental Ctrl Represenatative
2. Application Contact Mailing Address : Organization/Firm : Walt Disney World Co. Street Address : P.O. Box 10,000 City : Lake Buena Vista State : FL Zip Code : 32830-1000
3. Application Contact Telephone Numbers : Telephone : (407)827-2748 Fax : (407)827-2774

Application Comment

No fee is submitted , since the proposed emissions unit is a minor source, in accordance with 62-4.050(4)(a)2. F.A.C.

It is requested that this permitting action be kept separate from the Walt Disney World Title V permit at this time. The emissions unit will be incorporated, in a separate permitting action at a future date, after the construction permit has been issued and construction and stack testing have been completed.

As required in 62-296.401(6)(g), the facility operators will be trained by personnel from Crawford Engineering and Equipment, Co., through their department-approved training program.

FACILITY INFORMATION

II. FACILITY INFORMATION

A. GENERAL FACILITY INFORMATION

Facility, Location, and Type

1. Facility UTM Coordinates : Zone : East (km) : North (km) :			
2. Facility Latitude/Longitude : Latitude (DD/MM/SS) : 28 21 59 Longitude (DD/MM/SS) : 81 35 21			
3. Governmental Facility Code : 0	4. Facility Status Code : C	5. Facility Major Group SIC Code : 79	6. Facility SIC(s) :
7. Facility Comment : Facility SIC is 79-96			

Facility Contact

1. Name and Title of Facility Contact : Armando Rodriguez Director of Environmental Affairs	
2. Facility Contact Mailing Address : Organization/Firm : Walt Disney World Co. Street Address : P.O. Box 10,000 City : Lake Buena Vista State : FL Zip Code : 32830-1000	
3. Facility Contact Telephone Numbers : Telephone : (407)827-2730 Fax : (407)827-2774	

Facility Regulatory Classifications

1. Small Business Stationary Source?	N
2. Title V Source?	Y
3. Synthetic Non-Title V Source?	N
4. Major Source of Pollutants Other than Hazardous Air Pollutants (HAPs)?	Y
5. Synthetic Minor Source of Pollutants Other than HAPs?	N
6. Major Source of Hazardous Air Pollutants (HAPs)?	Y
7. Synthetic Minor Source of HAPs?	N
8. One or More Emissions Units Subject to NSPS?	N
9. One or More Emission Units Subject to NESHAP?	Y
10. Title V Source by EPA Designation?	Y
11. Facility Regulatory Classifications Comment :	

B. FACILITY REGULATIONS

Rule Applicability Analysis

--

B. FACILITY REGULATIONS

List of Applicable Regulations

II. Part 3b - 1

DEP Form No. 62-210.900(1) - Form
Effective : 3-21-96

C. FACILITY POLLUTANTS

Facility Pollutant Information

1. Pollutant Emitted	2. Pollutant Classification

D. FACILITY POLLUTANT DETAIL INFORMATION

Pollutant _____

II. Part 4b - 1

Effective : 3-21-96

D. FACILITY SUPPLEMENTAL INFORMATION

Supplemental Requirements for All Applications

1. Area Map Showing Facility Location :	Attachment A
2. Facility Plot Plan :	Attachment B
3. Process Flow Diagram(s) :	Attachment C
4. Precautions to Prevent Emissions of Unconfined Particulate Matter :	NA
5. Fugitive Emissions Identification :	NA
6. Supplemental Information for Construction Permit Application :	NA

Additional Supplemental Requirements for Category I Applications Only

7. List of Proposed Exempt Activities :	NA
8. List of Equipment/Activities Regulated under Title VI :	NA
9. Alternative Methods of Operation :	NA
10. Alternative Modes of Operation (Emissions Trading) :	NA
11. Identification of Additional Applicable Requirements :	NA
12. Compliance Assurance Monitoring Plan :	NA
13. Risk Management Plan Verification :	NA
14. Compliance Report and Plan :	NA
15. Compliance Certification (Hard-copy Required) :	

EMISSIONS UNIT INFORMATION

III. EMISSIONS UNIT INFORMATION

A. TYPE OF EMISSIONS UNIT (Regulated and Unregulated Emissions Units)

Emissions Unit Information Section 1

Necropsy Building- Crawford Model CB800 Animal Crematory

Type of Emissions Unit Addressed in This Section

1. Regulated or Unregulated Emissions Unit? Check one :

- [X] The emissions unit addressed in this Emissions Unit Information Section is a regulated emissions unit.
- [] The emissions unit addressed in this Emissions Unit Information Section is an unregulated emissions unit.

2. Single Process, Group of Processes, or Fugitive Only? Check one :

- [X] This Emissions Unit Information Section addresses, as a single emissions unit, a single process or production unit, or activity, which produces one or more air pollutants and which has at least one definable emission point (stack or vent).
- [] This Emissions Unit Information Section addresses, as a single emissions unit, a group of process or production units and activities which has at least one definable emission point (stack or vent) but may also produce fugitive emissions.
- [] This Emissions Unit Information Section addresses, as a single emissions unit, one or more process or production units and activities which produce fugitive emissions only.

III. Part 1 - 1

Emissions Unit Information Section 1

**B. GENERAL EMISSIONS UNIT INFORMATION
(Regulated and Unregulated Emissions Units)**

Emissions Unit Description and Status

1. Description of Emissions Unit Addressed in This Section : Necropsy Building- Crawford Model CB800 Animal Crematory		
2. Emissions Unit Identification Number : [X] No Corresponding ID [] Unknown		
3. Emissions Unit Status Code : C	4. Acid Rain Unit? [] Yes [X] No	5. Emissions Unit Major Group SIC Code : 79
6. Emissions Unit Comment : This emissions unit is a Crawford Model CB-800 Animal Crematory and will be used to incinerate animal carcasses. The unit has the capacity to process an 800 pound load every four hours. Secondary chamber residence time calculations: Secondary chamber volume (SCV)= 85.15 ft ³ , Air flow rate (Q) = 4500 acfm, residence time = SCV/Q = (85.15 ÷ 4500) x (60 sec/min) = 1.14 sec, which is greater than the required 1 sec. minimum residence time.		

Emissions Unit Information Section 1
Necropsy Building- Crawford Model CB800 Animal Crematory

Emissions Unit Control Equipment 1

1. Description : <i>No control equipment will be installed.</i>
2. Control Device or Method Code :

**D. EMISSIONS UNIT REGULATIONS
(Regulated Emissions Units Only)**

Emissions Unit Information Section 1
Necropsy Building- Crawford Model CB800 Animal Crematory

Rule Applicability Analysis

Rule Applicability Analysis is not required for this permit application.

Emissions Unit Information Section 1
Necropsy Building- Crawford Model CB800 Animal Crematory

List of Applicable Regulations

62-4.030, F.A.C.: Plant can only operate with a permit

62-4.050(1), F.A.C.: Proper application forms must be used

62-4.050(2) F.A.C.: Quadruplicate submittals required

62-4.050(3), F.A.C.: P.E. must certify the application

62-4.050(4)(a)2., F.A.C.: no application fee required

62-4.130, F.A.C.: Notification to DEP if plant has operational problems

62-103.150, F.A.C.: Public notice provisions for applicants

62-210.300, F.A.C.: Stationary source general requirements- units requiring permits

62-210.350(1), F.A.C.: Public notice provisions for permit types

62-210.700, F.A.C.: Excess emissions

62-212.300, F.A.C.: Preconstruction review

62-275, F.A.C.: Air quality areas

62-296.320(2), F.A.C.: Objectionable odor prohibited

62-296.401(6), F.A.C.: Emissions standards for Animal Crematories

III. Part 6b - 1

DEP Form No. 62-210.900(1) - Form
Effective : 3-21-96

Emissions Unit Information Section 1
Necropsy Building- Crawford Model CB800 Animal Crematory

List of Applicable Regulations

62-297.310, F.A.C.: General compliance test requirements

62-297.401(3), F.A.C.: Adopts EPA method 3 for oxygen tests

62-297.401(9), F.A.C.: Adopts EPA method 5 for particulate emissions tests

62-297.401(9), F.A.C.: Adopts EPA method 5 for particulate emissions' tests

62-297.401(10), F.A.C.: Adopts EPA method 10 for carbon monoxide tests

E. EMISSION POINT (STACK/VENT) INFORMATION

Emissions Unit Information Section 1

Necropsy Building- Crawford Model CB800 Animal Crematory

Emission Point Description and Type :

1. Identification of Point on Plot Plan or Flow Diagram :	DAK-9
2. Emission Point Type Code :	1
3. Descriptions of Emission Points Comprising this Emissions Unit for VE Tracking : (limit to 100 characters per point) Not applicable	
4. ID Numbers or Descriptions of Emission Units with this Emission Point in Common : Not applicable	
5. Discharge Type Code :	W
6. Stack Height :	19 feet
7. Exit Diameter :	2.0 feet
8. Exit Temperature :	1800 °F
9. Actual Volumetric Flow Rate :	4500 acfm
10. Percent Water Vapor :	%
11. Maximum Dry Standard Flow Rate :	dscfm
12. Nonstack Emission Point Height :	feet
13. Emission Point UTM Coordinates :	
Zone :	East (km) : North (km) :
14. Emission Point Comment :	
Refer to Attachment D for unit specifications.	

III. Part 7a - 1

F. SEGMENT (PROCESS/FUEL) INFORMATION

Emissions Unit Information Section 1

Necropsy Building- Crawford Model CB800 Animal Crematory

Segment Description and Rate : Segment 1

1. Segment Description (Process/Fuel Type and Associated Operating Method/Mode) : Natural gas fired animal crematory	
2. Source Classification Code (SCC) : 3-15-021-01	
3. SCC Units : tons incinerated	
4. Maximum Hourly Rate : 0.10	5. Maximum Annual Rate : 876.00
6. Estimated Annual Activity Factor : 0.00	
7. Maximum Percent Sulfur :	8. Maximum Percent Ash :
9. Million Btu per SCC Unit :	
10. Segment Comment : Maximum Hourly Rate= 200 pounds incinerated SCC code chosen for the closest description of the proposed activity Tons incinerated is presented as the SCC unit, instead of "bodies", since the sizes of animal carcasses are highly variable.	

III. Part 8 - 1

DEP Form No. 62-210.900(1) - Form

Effective : 3-21-96

G. EMISSIONS UNIT POLLUTANTS
(Regulated and Unregulated Emissions Units)

Emissions Unit Information Section 1

Necropsy Building- Crawford Model CB800 Animal Crematory

1. Pollutant Emitted	2. Primary Control Device Code	3. Secondary Control Device Code	4. Pollutant Regulatory Code
1 - CO			EL
2 - PM10			EL
3 - NOX			
4 - SO2			
5 - VOC			

III. Part 9a - 1

DEP Form No. 62-210.900(1) - Form

Effective : 3-21-96

H. EMISSIONS UNIT POLLUTANT DETAIL INFORMATION
(Regulated Emissions Units Only - Emissions Limited Pollutants Only)

Emissions Unit Information Section 1

Necropsy Building- Crawford Model CB800 Animal Crematory

Pollutant Potential/Estimated Emissions : Pollutant 1

1. Pollutant Emitted : CO			
2. Total Percent Efficiency of Control :	0.00	%	
3. Potential Emissions :	0.04	lb/hour	0.16 tons/year
4. Synthetically Limited? [] Yes [X] No			
5. Range of Estimated Fugitive/Other Emissions: <p align="right">to tons/year</p>			
6. Emissions Factor : Reference : stack test			
7. Emissions Method Code : 1			
8. Calculations of Emissions : See Attachment E for emissions calculations. Emissions factor is provided by manufacturer as 25 ppm, which has been corrected for O2 content. Actual emissions factor = 8.8 ppm, which represents actual expected emissions at actual stack conditions.			
9. Pollutant Potential/Estimated Emissions Comment : Potential hourly emissions= 0.0372 lb/hr Potential annual emissions= 0.16 tons/year Emissions factor = 8.8 ppm			

III. Part 9b - 1

DEP Form No. 62-210.900(1) - Form

Effective : 3-21-96

H. EMISSIONS UNIT POLLUTANT DETAIL INFORMATION
(Regulated Emissions Units Only - Emissions Limited Pollutants Only)

Emissions Unit Information Section 1
 Necropsy Building- Crawford Model CB800 Animal Crematory

Pollutant Potential/Estimated Emissions : Pollutant 2

1. Pollutant Emitted : PM10			
2. Total Percent Efficiency of Control :	0.00	%	
3. Potential Emissions :	0.15	lb/hour	0.65 tons/year
4. Synthetically Limited? <input type="checkbox"/> Yes <input checked="" type="checkbox"/> No			
5. Range of Estimated Fugitive/Other Emissions: <div style="text-align: right;">to tons/year</div>			
6. Emissions Factor : Reference : Stack testing			
7. Emissions Method Code : 1			
8. Calculations of Emissions : See Attachment E for emissions calculations. Emissions factor is provided by manufacturer as .05 gr/DSCF, which has been corrected for O2 content. Actual emissions factor = 0.0176 gr/SCF, which represents actual expected emissions at standard conditions, uncorrected for moisture content.			
9. Pollutant Potential/Estimated Emissions Comment : Potential hourly emissions= 0.1485 lb/hr Potential annual emissions= 0.65 tons/year Assuming all PM emissions are PM10 Emissions factor = .0176 gr/DSCF			

**H. EMISSIONS UNIT POLLUTANT DETAIL INFORMATION
(Regulated Emissions Units Only - Emissions Limited Pollutants Only)**

Emissions Unit Information Section 1

Necropsy Building- Crawford Model CB800 Animal Crematory

Pollutant Potential/Estimated Emissions : Pollutant 3

1. Pollutant Emitted : NOX			
2. Total Percent Efficiency of Control :	0.00	%	
3. Potential Emissions :	0.30	lb/hour	1.31 tons/year
4. Synthetically Limited? <input type="checkbox"/> Yes <input checked="" type="checkbox"/> No			
5. Range of Estimated Fugitive/Other Emissions: <div style="text-align: right;">to tons/year</div>			
6. Emissions Factor : Reference : AP-42, Oct. 1996			
7. Emissions Method Code : 3			
8. Calculations of Emissions : See Attachment E for emissions calculations and AP-42 emissions factor. Emissions factor selected for commercial boilers, .3-10 mmBtu/hr heat input.			
9. Pollutant Potential/Estimated Emissions Comment : Hourly emissions= 0.30 lb/hr Annual emissions= 1.31 tpy Emissions factor = 100 lb/MMft ³ gas burned			

H. EMISSIONS UNIT POLLUTANT DETAIL INFORMATION
(Regulated Emissions Units Only - Emissions Limited Pollutants Only)

Emissions Unit Information Section 1
 Necropsy Building- Crawford Model CB800 Animal Crematory

Pollutant Potential/Estimated Emissions : Pollutant 4

1. Pollutant Emitted : SO2			
2. Total Percent Efficiency of Control :	0.00	%	
3. Potential Emissions :	0.00	lb/hour	0.01 tons/year
4. Synthetically Limited? <input type="checkbox"/> Yes <input checked="" type="checkbox"/> No			
5. Range of Estimated Fugitive/Other Emissions: <div style="text-align: right;">to tons/year</div>			
6. Emissions Factor : Reference : AP-42, Oct. 1996			
7. Emissions Method Code : 3			
8. Calculations of Emissions : See Attachment E for emissions calculations and AP-42 emissions factors. Emissions factor selected for commercial boilers, .3-10 mmBtu/hr heat input.			
9. Pollutant Potential/Estimated Emissions Comment : Hourly emissions = .0018 lb/hr Annual emissions = .0079 tpy Emissions factor = 0.6 lb/MMft ³			

**H. EMISSIONS UNIT POLLUTANT DETAIL INFORMATION
(Regulated Emissions Units Only - Emissions Limited Pollutants Only)**

Emissions Unit Information Section 1

Necropsy Building- Crawford Model CB800 Animal Crematory

Pollutant Potential/Estimated Emissions : Pollutant 5

1. Pollutant Emitted : VOC			
2. Total Percent Efficiency of Control :		0.00	%
3. Potential Emissions :		0.02	lb/hour 0.08 tons/year
4. Synthetically Limited? <input type="checkbox"/> Yes <input checked="" type="checkbox"/> No			
5. Range of Estimated Fugitive/Other Emissions:		to	tons/year
6. Emissions Factor : Reference : AP-42, Oct. 1996			
7. Emissions Method Code : 3			
8. Calculations of Emissions : See Attachment E for emissions calculations and AP-42 emissions factors. Emissions factor selected for commercial boilers, .3-10 mmBtu/hr heat input.			
9. Pollutant Potential/Estimated Emissions Comment : Hourly emissions = .0174 lb/hr Annual emissions = .076 tpy Emisisions factor = 5.8 lb/MMft ³ gas burned			

Emissions Unit Information Section 1
Necropsy Building- Crawford Model CB800 Animal Crematory

Pollutant Information Section 1

Allowable Emissions 1

1. Basis for Allowable Emissions Code :	RULE
2. Future Effective Date of Allowable Emissions :	
3. Requested Allowable Emissions and Units :	100.00 ppm, DSCF 7% O2
4. Equivalent Allowable Emissions :	lb/hour tons/year
5. Method of Compliance :	EPA Method 10
6. Pollutant Allowable Emissions Comment (Desc. of Related Operating Method/Mode) :	Allowable emissions for CO.

Emissions Unit Information Section 1
Necropsy Building- Crawford Model CB800 Animal Crematory

Pollutant Information Section 2

Allowable Emissions 1

1. Basis for Allowable Emissions Code :		RULE	
2. Future Effective Date of Allowable Emissions :			
3. Requested Allowable Emissions and Units :		0.08	gr/DSCF @ 7% O2
4. Equivalent Allowable Emissions :			
	0.24	lb/hour	1.04 tons/year
5. Method of Compliance :			
EPA Method 5			
6. Pollutant Allowable Emissions Comment (Desc. of Related Operating Method/Mode) :			
Allowable emissions for PM/PM10.			

Emissions Unit Information Section 1
Necropsy Building- Crawford Model CB800 Animal Crematory

Pollutant Information Section 3

Allowable Emissions 1

1. Basis for Allowable Emissions Code :	OTHER
2. Future Effective Date of Allowable Emissions :	
3. Requested Allowable Emissions and Units :	1.31 tons/year
4. Equivalent Allowable Emissions :	0.30 lb/hour 1.31 tons/year
5. Method of Compliance :	Materials balance based on fuel usage.
6. Pollutant Allowable Emissions Comment (Desc. of Related Operating Method/Mode) :	Allowable emissions are equal to potential emissions for NOx.

Emissions Unit Information Section 1
Necropsy Building- Crawford Model CB800 Animal Crematory

Pollutant Information Section 5

Allowable Emissions 1

1. Basis for Allowable Emissions Code :	OTHER		
2. Future Effective Date of Allowable Emissions :			
3. Requested Allowable Emissions and Units :	0.02		tons/yr
4. Equivalent Allowable Emissions :	0.01	lb/hour	0.02 tons/year
5. Method of Compliance :	Materials balance based on fuel usage.		
6. Pollutant Allowable Emissions Comment (Desc. of Related Operating Method/Mode) :	Allowable emissions are equal to potential emissions for VOC/TOC. Requested allowable emissions = .022 tpy		

Emissions Unit Information Section 1
Necropsy Building- Crawford Model CB800 Animal Crematory

Pollutant Information Section 4

Allowable Emissions 1

1. Basis for Allowable Emissions Code :	OTHER		
2. Future Effective Date of Allowable Emissions :			
3. Requested Allowable Emissions and Units :	0.01		tons/yr
4. Equivalent Allowable Emissions :	0.00	lb/hour	0.01 tons/year
5. Method of Compliance :	Materials balance based on fuel usage.		
6. Pollutant Allowable Emissions Comment (Desc. of Related Operating Method/Mode) :	Allowable emissions are equal to potential emissions for SO2. Requested allowable emissions = .008 tpy		

I. VISIBLE EMISSIONS INFORMATION
(Regulated Emissions Units Only)

Emissions Unit Information Section 1

Necropsy Building- Crawford Model CB800 Animal Crematory

Visible Emissions Limitation : Visible Emissions Limitation 1

1. Visible Emissions Subtype :	20
2. Basis for Allowable Opacity :	RULE
3. Requested Allowable Opacity :	
	Normal Conditions : 20 %
	Exceptional Conditions : 27 %
	Maximum Period of Excess Opacity Allowed : 6 min/hour
4. Method of Compliance :	
	EPA method 9, 30 minute test
5. Visible Emissions Comment :	

III. Part 10 - 1

DEP Form No. 62-210.900(1) - Form

Effective : 3-21-96

J. CONTINUOUS MONITOR INFORMATION
(Regulated Emissions Units Only)

Emissions Unit Information Section _____

Continuous Monitoring System : Continuous Monitor _____

1. Parameter Code :	2. Pollutant :
3. CMS Requirement :	
4. Monitor Information : Manufacturer : Model Number : Serial Number :	
5. Installation Date :	
6. Performance Specification Test Date :	
7. Continuous Monitor Comment :	

**K. PREVENTION OF SIGNIFICANT DETERIORATION (PSD) INCREMENT
TRACKING INFORMATION**

Emissions Unit Information Section

1

Necropsy Building- Crawford Model CB800 Animal Crematory

PSD Increment Consumption Determination

1. Increment Consuming for Particulate Matter or Sulfur Dioxide?

- The emissions unit is undergoing PSD review as part of this application, or has undergone PSD review previously, for particulate matter or sulfur dioxide. If so, emissions unit consumes increment.
- The facility addressed in this application is classified as an EPA major source pursuant to paragraph (c) of the definition of "major source of air pollution" in Chapter 62-213, F.A.C., and the emissions unit addressed in this section commenced (or will commence) construction after January 6, 1975. If so, baseline emissions are zero, and emissions unit consumes increment.
- The facility addressed in this application is classified as an EPA major source, and the emissions unit began initial operation after January 6, 1975, but before December 27, 1977. If so, baseline emissions are zero, and emissions unit consumes increment.
- For any facility, the emissions unit began (or will begin) initial operation after December 27, 1977. If so, baseline emissions are zero, and emissions unit consumes increment.
- None of the above apply. If so, the baseline emissions of the emissions unit are nonzero. In such case, additional analysis, beyond the scope of this application, is needed to determine whether changes in emissions have occurred (or will occur) after the baseline date that may consume or expand increment.

III. Part 12 - 1

DEP Form No. 62-210.900(1) - Form
Effective : 3-21-96

2. Increment Consuming for Nitrogen Dioxide?

-] The emissions unit addressed in this section is undergoing PSD review as part of this application, or has undergone PSD review previously, for nitrogen dioxide. If so, emissions unit consumes increment.
-] The facility addressed in this application is classified as an EPA major source pursuant to paragraph (c) of the definition of "major source of air pollution" in Chapter 62-213, F.A.C., and the emissions unit addressed in this section commenced (or will commence) construction after February 8, 1988. If so, baseline emissions are zero, and emissions unit consumes increment.
-] The facility addressed in this application is classified as an EPA major source, and the emissions unit began initial operation after February 8, 1988, but before March 28, 1988. If so, baseline emissions are zero, and emissions unit consumes increment.
-] For any facility, the emissions unit began (or will begin) initial operation after March 28, 1988. If so, baseline emissions are zero, and emissions unit consumes increment.
-] None of the above apply. If so, baseline emissions of the emissions unit are nonzero. In such case, additional analysis, beyond the scope of this application, is needed to determine whether changes in emissions have occurred (or will occur) after the baseline date that may consume or expand increment.

3. Increment Consuming/Expanding Code :		
PM : C	SO2 : C	NO2 : C
4. Baseline Emissions :		
PM :	lb/hour	tons/year
SO2 :	lb/hour	tons/year
NO2 :		tons/year
5. PSD Comment :		

L. EMISSIONS UNIT SUPPLEMENTAL INFORMATION

Emissions Unit Information Section 1

Necropsy Building- Crawford Model CB800 Animal Crematory

Supplemental Requirements for All Applications

1. Process Flow Diagram :	Attachment C
2. Fuel Analysis or Specification :	NA
3. Detailed Description of Control Equipment :	NA
4. Description of Stack Sampling Facilities :	NA
5. Compliance Test Report :	NA
6. Procedures for Startup and Shutdown :	NA
7. Operation and Maintenance Plan :	NA
8. Supplemental Information for Construction Permit Application :	Attachment D
9. Other Information Required by Rule or Statue :	EMISSI~1.XLS

Additional Supplemental Requirements for Category I Applications Only

10. Alternative Methods of Operations :	NA
11. Alternative Modes of Operation (Emissions Trading) :	NA

III. Part 13 - 1

DEP Form No. 62-210.900(1) - Form

Effective : 3-21-96

12. Identification of Additional Applicable Requirements :	NA
13. Compliance Assurance Monitoring Plan :	NA
14. Acid Rain Application (Hard-copy Required) :	
NA	Acid Rain Part - Phase II (Form No. 62-210.900(1)(a))
NA	Repowering Extension Plan (Form No. 62-210.900(1)(a)1.)
NA	New Unit Exemption (Form No. 62-210.900(1)(a)2.)
NA	Retired Unit Exemption (Form No. 62-210.900(1)(a)3.)

SUPPLEMENTAL INFORMATION

ATTACHMENT A

AREA MAP SHOWING FACILITY LOCATION

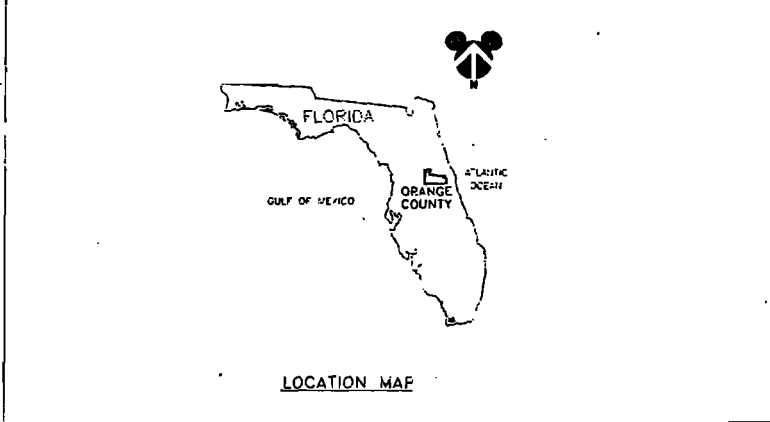
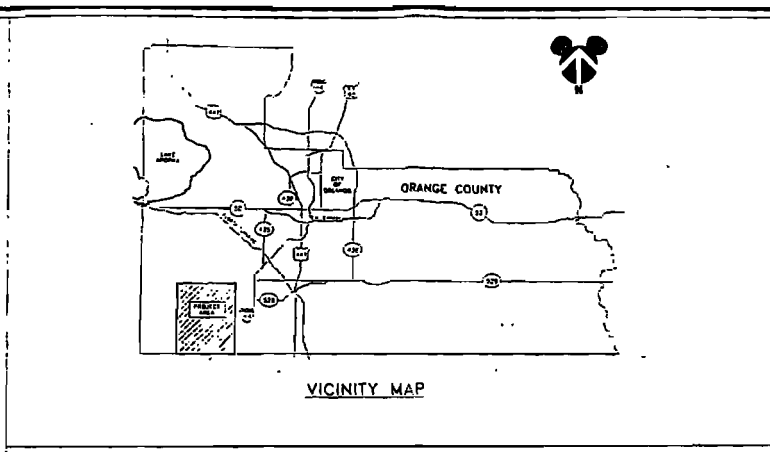
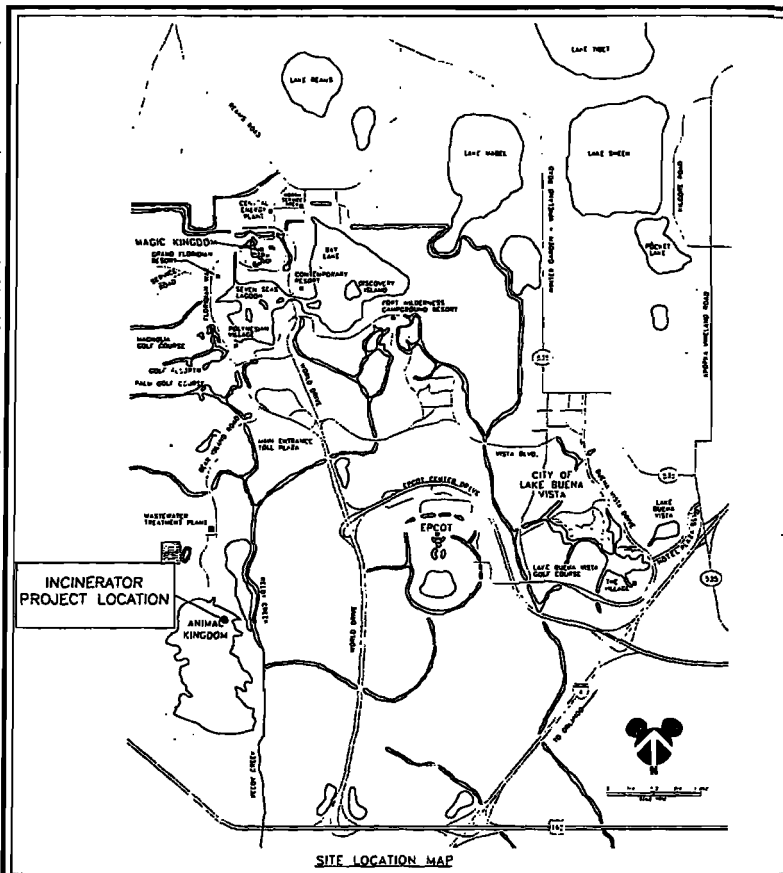

ATTACHMENT A
AREA MAP SHOWING FACILITY LOCATION
ANIMAL KINGDOM - ANIMAL CARCASS ICINERATOR



RICHFILE.CAR

Air- Tallahassee- Bruce Mitchell

921-9506 (850)488-1344

850-922-6979

il: MITCHELL_B@DEP.STATE.FL.US

South Magnolia, Suite 4

ahassee, FL 32301

:850-878-3656

7, Box 1445B

ie Rd.

ahassee, FL 32308

ATTACHMENT B
FACILITY PLOT PLAN

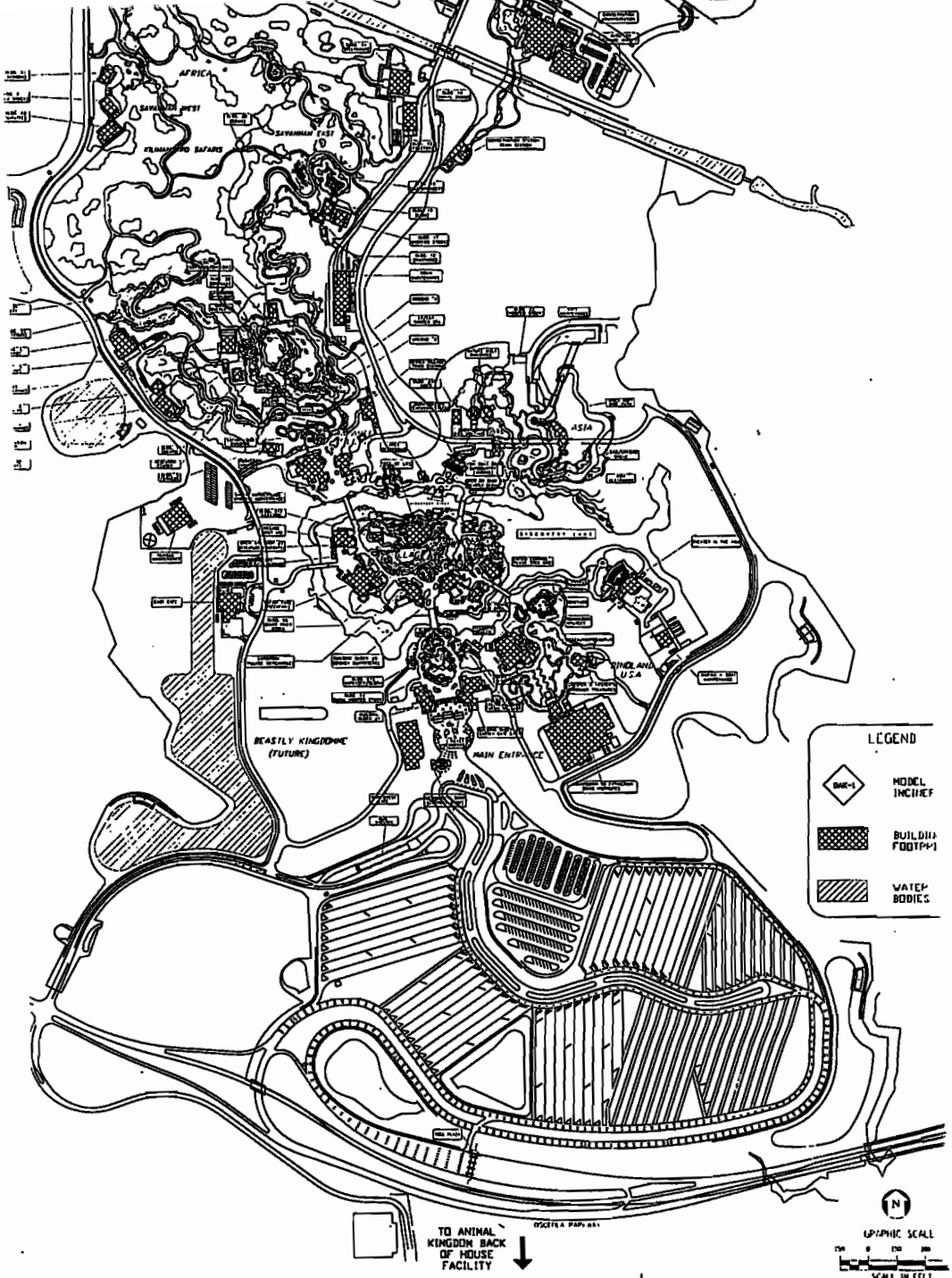

MENT B
 Y PLOT PLAN
 ANIMAL KINGDOM- ANIMAL CARCASS INCINERATOR

ATTACHMENT C
PROCESS FLOW DIAGRAM

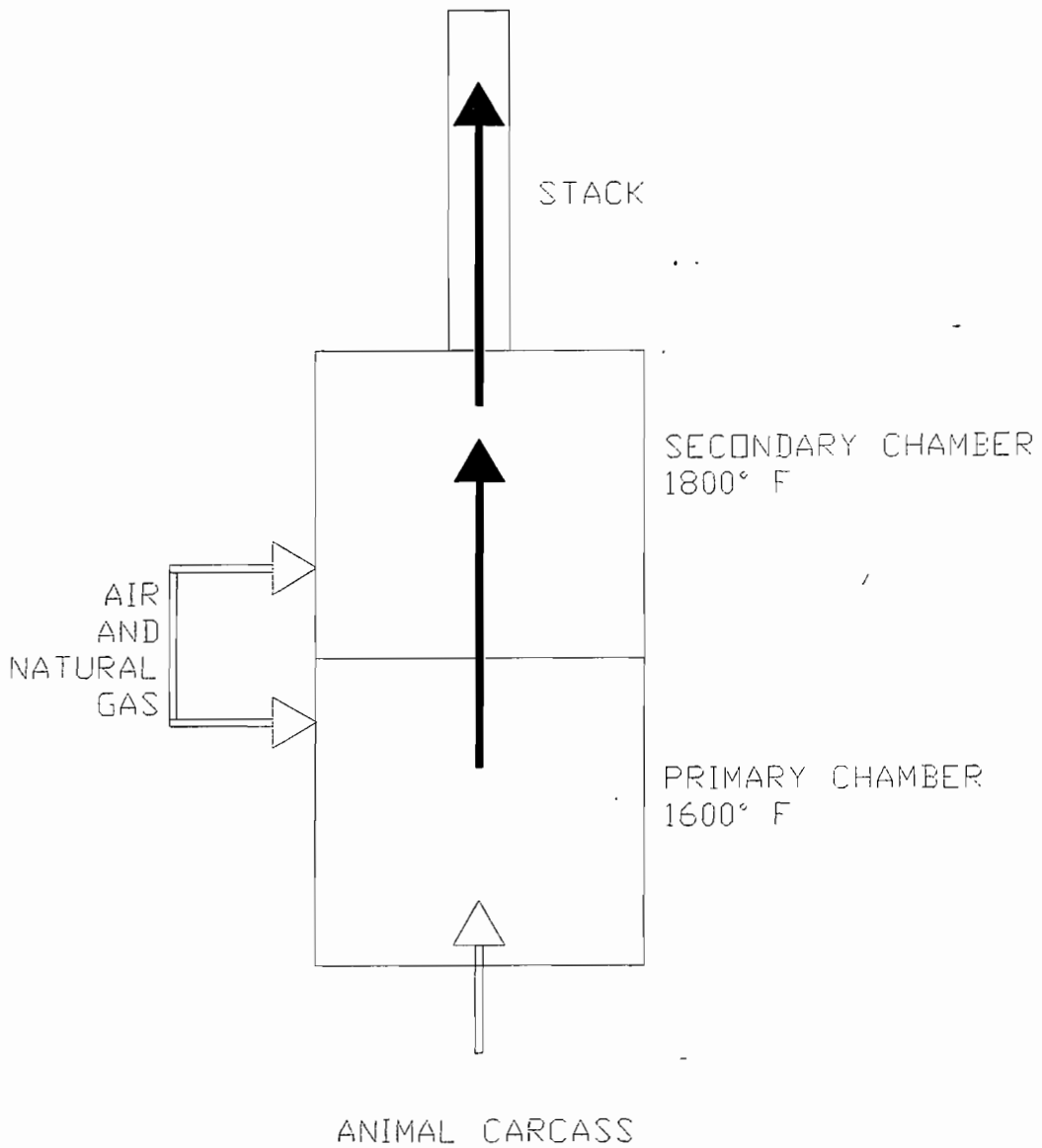

ATTACHMENT C
PROCESS FLOW DIAGRAM
DISNEY'S ANIMAL KINGDOM- ANIMAL
CARCASS INCINERATOR

Walt Disney World Co.

ATTACHMENT D

MODEL CB800 INCINERATOR SPECIFICATIONS

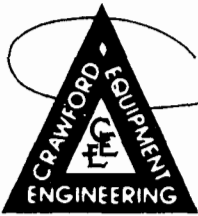

Crawford

EQUIPMENT & ENGINEERING CO.

P. O. BOX 593243 • 436 W. LANDSTREET ROAD • ORLANDO, FLA. 32859 • (407) 851-0993

JIM CRAWFORD
PRESIDENT

October 20, 1997

Mr. Rich Bumar
Walt Disney World
Environmental Affairs
P.O. Box 10000
Lake Buena Vista, FL 32830-1000

Re: Model CB800 Incinerator Permit - Wild Animal Kingdom

Dear Mr. Bumar:

I have been instructed by Mr. Armando Rodriguez to provide you with the enclosed information so that you may complete and submit the required environmental permit application to the state.

In addition to the enclosed product specification, the information presented below will also assist you in the completion of the application.

Primary Chamber Burners:	Quantity 1 1,500,000 BTU/HR Max. 750,000 BTU/HR Average Usage
Secondary Chamber Burners:	Quantity 1 1,500,000 BTU/HR Max. 1,250,000 BTU/HR Average Usage
Flow Rate:	4500 ACFM @ 1800°F
Retention Time:	1 plus seconds @ 1800°F
Expected Emissions:	TSP = .05 gr/DSCF corrected to 7% Oxygen CO = 25 PPM Opacity = .0%

Should you require additional information, please contact Mr. Steve Atkinson at 407-851-0993 ext. 229 or I can be reached at the same number, ext. 228.

Regards,

B. Gamage
Brian D. Gamage
Dir. Sales/Marketing

CRAWFORD

MODEL CB800

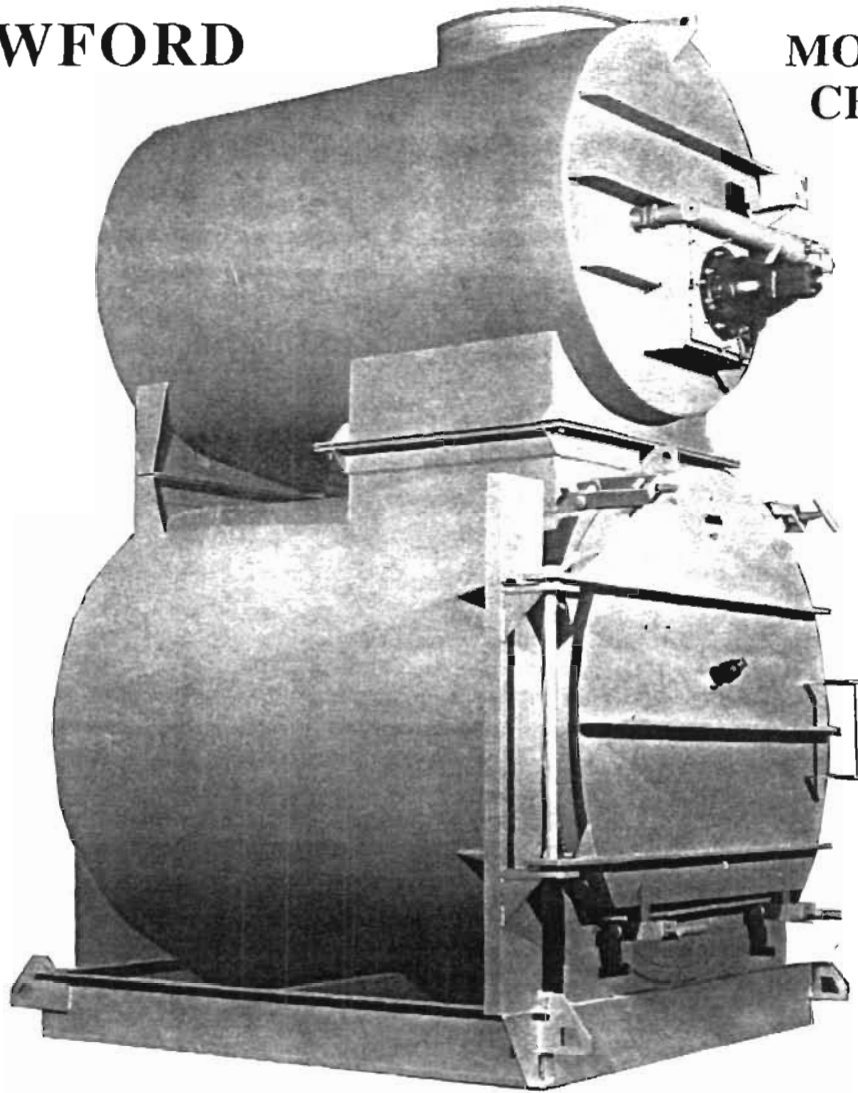

OVERVIEW: The Crawford model CB800 is a "batch" loading incineration system designed to process pathological (animal carcasses) as well as the plastics and various materials found in "redbag" veterinary/medical waste streams, while complying with today's most stringent standards imposed by local, state and federal environmental agencies. Utilizing a unique multiple chamber, negative pressure and controlled excess-air design, the CB800 will accept and completely process a 800 lb. load in a four hour cycle, which allows for multiple burn cycles each day. With over 81 cubic ft. of primary chamber volume the most practical application of the CB800 is to perform communal or mass disposals, however individual or private cremations can also be easily accomplished in this system.

FUEL: Type: Natural or Propane
Pressure: 7" - 9" W.C. 9" - 11" W.C.
Flow: 4,000,000 BTU/HR

ELECTRICAL: One 230/460 V, 30 / 15 AMP, 3Ø (1Ø available)
One 115V, 10 AMP, 1Ø

PLACEMENT: Outside or Inside

DIMENSIONS: 7'6" wide, 9'7" long, 11'6" tall (nominal)

PAD SIZE: 12'0" wide x 18'0" long (recommended)

FEATURES: In excess of 1 second secondary chamber residence time @ 1800°F
Refractory lined, high temperature exhaust stack (rise to 18'6" from floor)
Fully automatic, PLC based controls, Low loading threshold

C:\P15\DWG5\JOURNALS\CB400\31101\400-UNIT.DWG

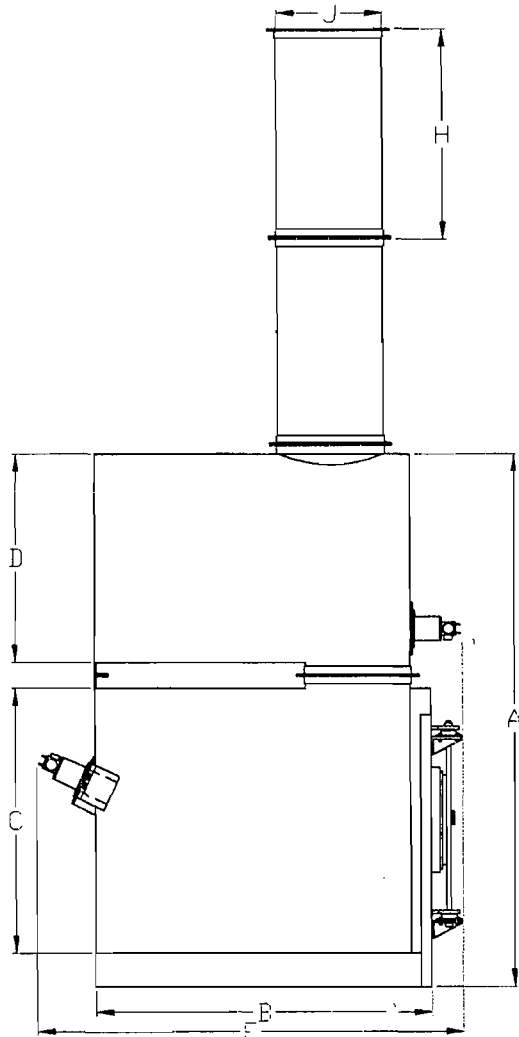

LEFT SIDE VIEW

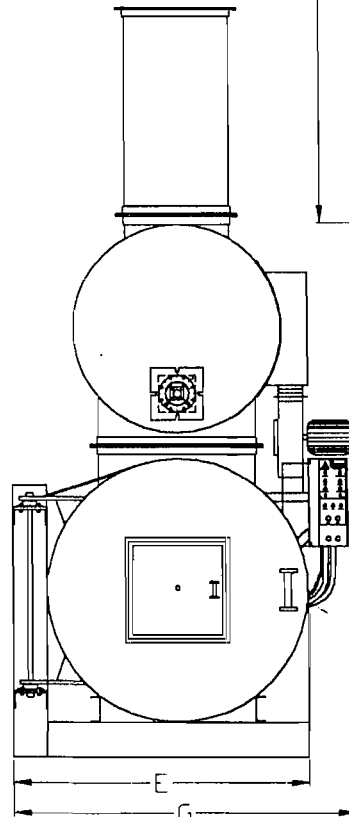

FRONT VIEW

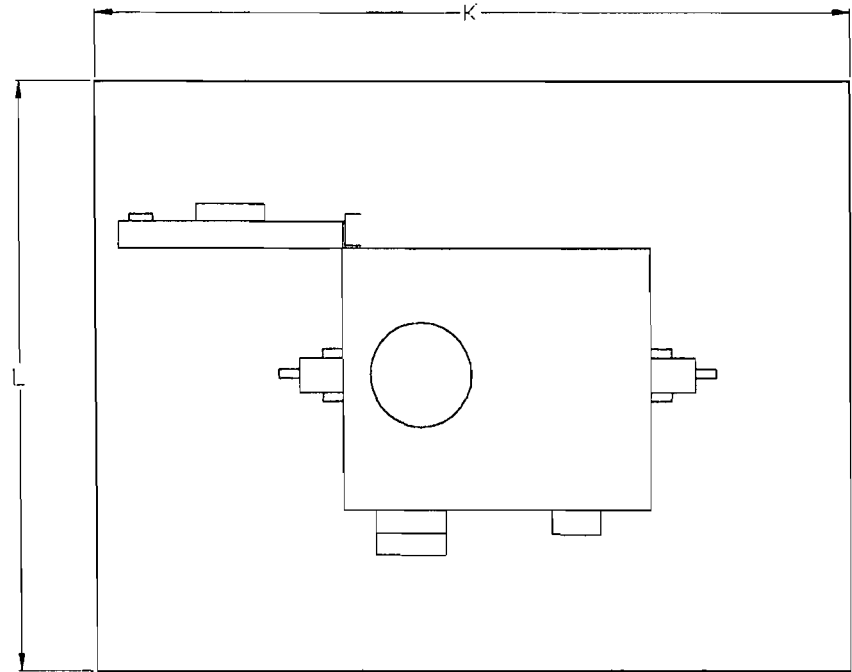

SLAB DIMENSIONS

DIMENSIONS	MODELS			
	CB 200	CB 400	CB 800	CB 1200
A	9'-0"	10'-0"	11'-0"	11'-0"
B	5'-0"	6'-0"	7'-0"	10'-0"
C	4'-0"	5'-0"	5'-0"	5'-0"
D	4'-0"	4'-0"	5'-0"	5'-0"
E	4'-10"	5'-10"	5'-10"	5'-10"
F	8'-0"	9'-0"	10'-0"	13'-0"
G	6'-6"	7'-6"	7'-6"	7'-6"
H	4'-0"	4'-0"	4'-0"	4'-0"
J	2'-0"	2'-0"	2'-0"	2'-0"
K SLAB	15'-0"	17'-0"	18'-0"	21'-0"
L SLAB	12'-6"	13'-6"	13'-6"	13'-6"
CHAMBER VOLUME	32 CF.	69 CF.	82 CF.	122 CF.
UNIT WEIGHT	10,000	14,000	20,000	24,000

EQUIPMENT ENGINEERING
CRAWFORD

DWTM T. JONES	DATE 5-5-97
CHECKED M.S.	DATE 5-5-97

CRAWFORD
EQUIPMENT & ENGINEERING CO.
436 W. LAND STREET ROAD ORLANDO, FL 32855 (407) 851-0993

CRAWFORD CB-SERIES
BATCH BURN INCINERATOR SYSTEM

DWG NAME DIMEN. IN°O.	JOB NAME CB 400	SCALE N.T.S.	DWG. A.C. 1	SHEET 1 OF 1	REV.
--------------------------	--------------------	-----------------	----------------	-----------------	------

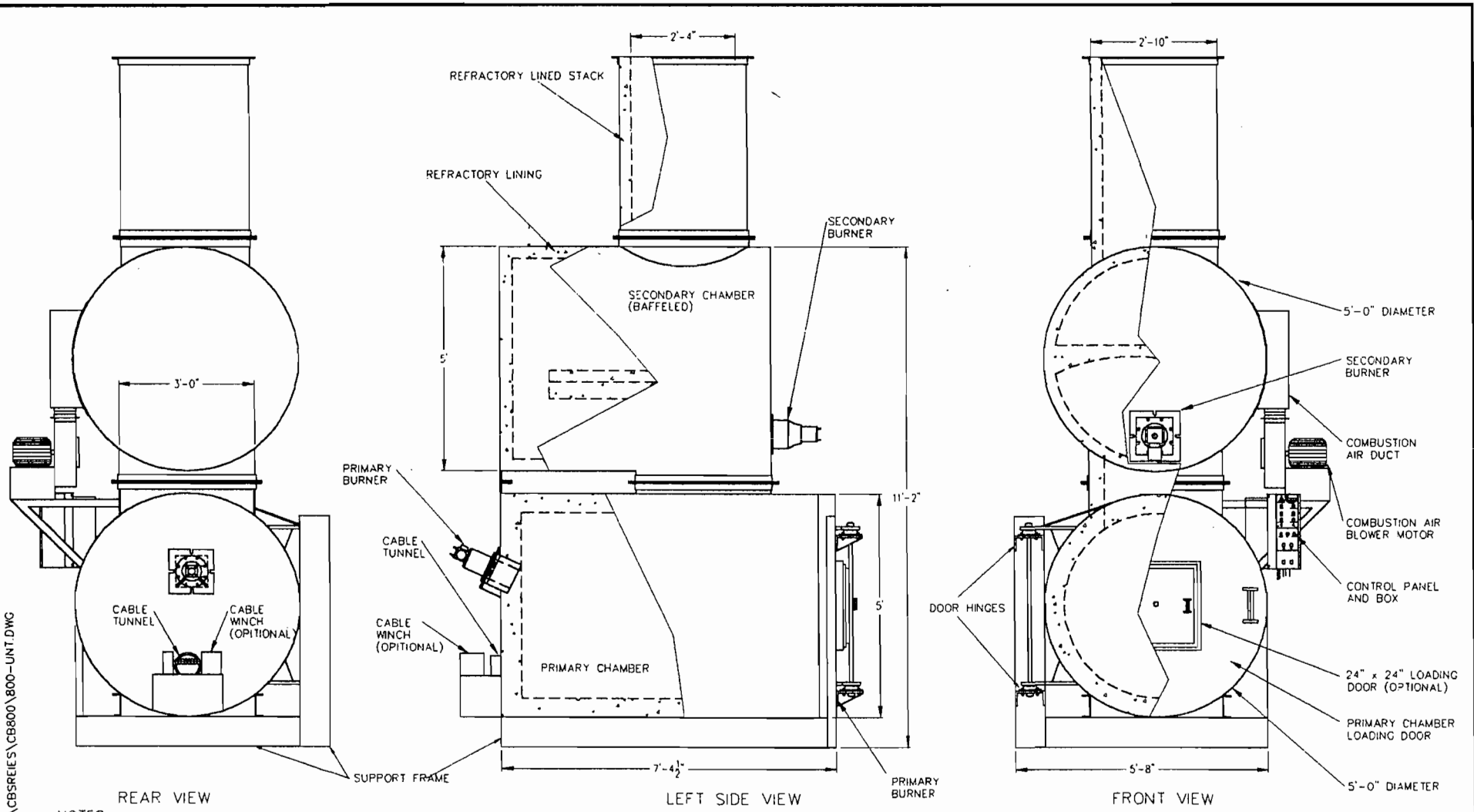

NOTES:
 WEIGHT: APPROX 20,000 LBS
 STACK: TWO (2) 4' SECTIONS @ 900 Lbs. EACH
 UTILITIES: ONE (1) 2" LINE 2.5 MM BTU/HR FLOW
 7"-9" N.G. PRESSURE
 9"-11" L.P. PRESSURE
 ONE (1) 115 V 1Ø OR 3Ø 15 AMPS
 ONE (1) 230/460 V 3Ø/15 AMPS
 PRIMARY CHAMBER: 81.76 CU FT
 SECONDARY CHAMBER: 85.15 CU FT

DIMENSIONS GIVEN DO NOT INCLUDE
 EXTERIOR COMPONENTS (BURNERS, MOTORS, ETC)

	DRTM: T. JONES DATE: 11-25-96	CRAWFORD EQUIPMENT & ENGINEERING CO. <small>401 W. LANSEBERRY ROAD ORLANDO, FL 32803 (407) 851-0282</small>
	CHECKED: M.S. DATE: 11-26-96	
THIS DRAWING IS THE PROPERTY OF CRAWFORD. REPRODUCTIONS ARE FORWARDED SOLELY FOR QUOTATION. MANUFACTURING OF PARTS AND PURCHASES ONLY. RELEASE OF DRAWINGS TO OTHERS DOES NOT ALLOW REPRODUCTION IN ANY MANNER.		
DWG NAME: MULTI VIEW	JOB NAME: CB-800	SCALE: N.T.S. DWG NO: 1 SHEET: 1 OF 2 REV:

C:\P13\DWGS\BURNERS\CB800\800-UNT.DWG

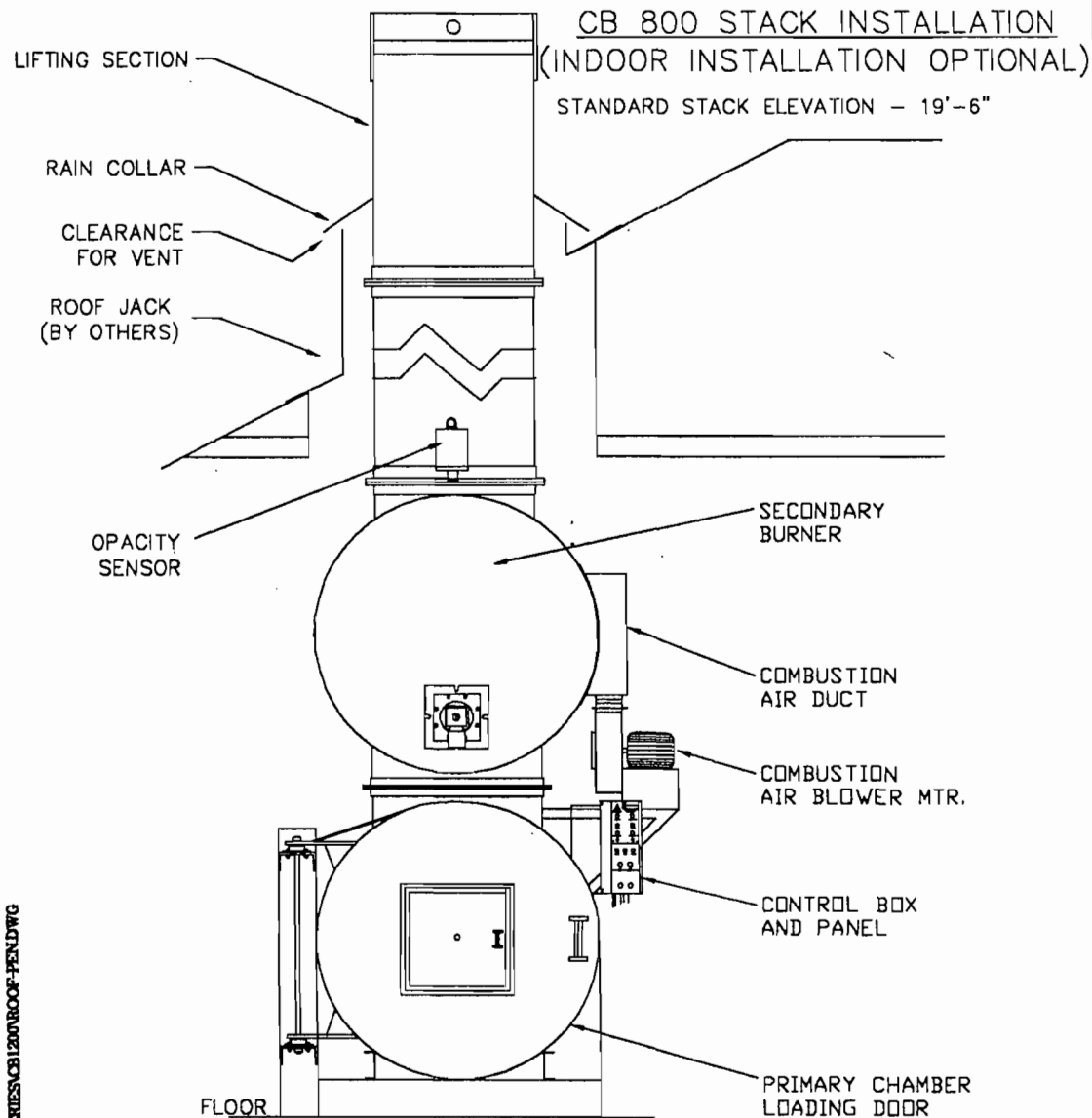

FRONT VIEW

MANUFACTURERS RECOMMENDED
CLEARANCES:

SIDES.....36"
 REAR.....36"
 TOP.....18"
 STACK.....8"

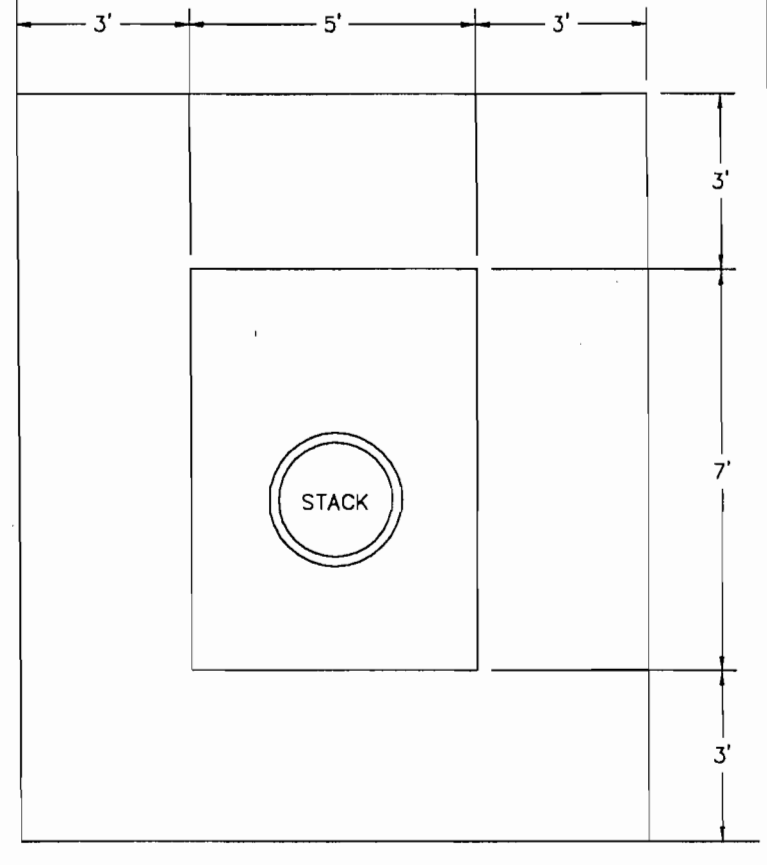

CARLSDORF'S BUSINESS SERVICES CB1200/ROOF-PENL/DWG

SLAB - NONCOMBUSTIBLE - LOAD BEARING TO SUPPORT 20,000 LBS.

CONSULT LOCAL BUILDING CODES AND ORDINANCES FOR ANY RESTRICTIONS WHICH MAY APPLY.

THIS INFORMATION SHALL NOT BE REPRODUCED, COPIED, OR TRANSMITTED TO ANY PARTY WITHOUT THE WRITTEN CONSENT OF CRAWFORD EQUIPMENT & ENGINEERING. ALL DRAWINGS AND ANY INFORMATION CONTAINED HEREIN REMAIN THE PROPERTY OF CRAWFORD EQUIPMENT & ENGINEERING CO., INC.



DEPTM. T. JONES	DATE 11-25-96
CHECKED M.S.	DATE 11-25-96

THIS DRAWING IS THE PROPERTY OF CRAWFORD EQUIPMENT & ENGINEERING. ANY RELEASED LIABILITY FOR OPERATOR, MANUFACTURER OR PURCHASER PURPOSES ONLY. RELEASE OF LIABILITY TO OTHERS DOES NOT ALLOW LICENSED IN ANY WAY.

CRAWFORD
EQUIPMENT & ENGINEERING CO.
426 W. LANSBERRY ROAD ORLANDO, FL 32814 (407) 861-0292

**CRAWFORD MODEL CB-800
BATCH BURN INCINERATOR SYSTEM**

DWG NAME ROOF PENE.	JOB NAME CB 800	SCALE N.T.S.	DWG. NO. 2	SHEET 2 OF 2	REV.
------------------------	--------------------	-----------------	---------------	-----------------	------

ATTACHMENT E
EMISSIONS CALCULATIONS

Attachment E

Input Values

Standard Temperature, C	25 °C
Standard Temperature (T _{std}) =	298 K
Actual Temperature, F	1800 °F
Actual Temperature, K (T):	1255 K
Actual flue gas O ₂ content**	16%
Ambient air O ₂ content	21%

$$7\% \text{ Oxygen content correction factor (OCF)} = \frac{\text{ambient air O}_2 \text{ content} - \text{corrected value (7\%)}}{\text{ambient air O}_2 \text{ content} - \text{measured stack O}_2 \text{ content}}$$

$$7\% \text{ Oxygen content correction factor (OCF)} = \frac{20.9 - 7}{20.9 - 16} = 2.83673$$

This factor is used to determine actual pollutant mass flow rate:

Oxygen content correction factor (OCF)=(20.9-7)/(20.9-16) =	2.837
Flue gas moisture content, by volume** (MC):	8%
actual air flow rate (V) :	4500 acfm
Hours/year	8760 hours
Maximum heat input (HI):	3 MMBtu/hr
Fuel heat value (HV):	1000 Btu/ft ³
Incinerator fuel usage = HI • 1,000,000 ÷ HV :	0.003 MM ft ³ /hr

CO Emissions

$$PV = nRT, \text{ rearranging, } \frac{n}{V} = \frac{P}{RT}, \text{ and, } n = \frac{\text{Mass pollutant, } M}{\text{Molecular weight, } MW}$$

$$\text{substituting, } \frac{M}{V \cdot MW} = \frac{P}{RT}, \text{ so, } \frac{M}{V} = \frac{P \cdot MW}{RT},$$

$$\text{allowing for concentration in ppm, } \frac{M}{V} = \frac{P \cdot MW \cdot \text{ppm}}{RT \cdot 10^6}, \text{ and}$$

$$\text{Pollutant mass flow rate} = M = \frac{P \cdot MW \cdot \text{ppm} \cdot V}{RT \cdot 10^6}$$

molar weight of CO (MW):	28 lb/lb-mol
Ideal gas constant (R):	1.314 atm-ft ³ /lbmol-K
Pressure (P):	1 atm
Reported CO concentration* =	25 ppm, DSCF @ 7% O ₂
Measured pollutant concentration at stack at actual conditions (ppm) = 25*/OCF =	8.8 ppm
Allowable pollutant concentration @ 7% Oxygen , ref 62-296.401(6), F.A.C.:	100 ppm, DSCF @ 7% O ₂
Flow corrected for moisture (MCF) = V • (1-MC) = 4500 • (1-0.08) =	4140 ft ³ /min
Moisture corrected flow to standard temp = MCF • (T _{std} /T) = 4140 • (298/1255) =	983 DSCFM
Allowable pollutant mass flow = P • MW • ppm • V / (R • T • 10 ⁶) = 1 • 28 • 100 • 983 / (1.314 • 298 • 10 ⁶) =	0.00703 lb/min
Allowable pollutant mass flow corrected to measured exhaust oxygen level = .00703 / 2.837 =	0.002 lb/min
Oxygen corrected Allowable pollutant mass flow, in lb/hr = 0.00248 • 60 =	0.149 lb/hr
Annual allowable emissions = 0.149 • 8760 / 2000 =	0.651 tons/yr
Potential pollutant mass flow = P • MW • ppm • V / (R • T • 10 ⁶) = 1 • 28 • 8.8 • 983 / (1.314 • 298 • 10 ⁶) =	0.00062 lb/min
potential pollutant mass flow rate, in lb/hr = .00062 • 60 =	0.0372 lb/hr
Potential annual emissions = 0.0404 lb/hr • 8760 hr/yr • 60 min/hour =	326 lb/yr
Potential annual emissions, in tpy = 354 lb/yr • 1 ton/2000 lb =	0.16 tpy

**Reported by manufacturer

Attachment E

PM/PM10 Emissions

Allowable pollutant concentration @ 7% Oxygen, ref 62-296.401(6), F.A.C.:	0.08 gr/DSCF
Measured pollutant concentration @ 7% Oxygen = .05*/OCF	0.0176 gr/SCF
Flow corrected for moisture (MCF) = V • (1-MC)	4140 ft ³ /min
Moisture corrected flow to standard temp = MCF • (T _{std} /T) =	983 DSCFM
Allowable pollutant mass flow = .08 • 983 ÷ 7000 gr/lb =	0.0112 lb/min
Allowable pollutant mass flow corrected for oxygen = .0112/2.837 =	0.004 lb/min
Oxygen corrected Allowable pollutant mass flow = .004 • 60 =	0.238 lb/hr
Annual allowable emissions = 0.238 • 8760/2000 =	1.041 tons/yr
potential pollutant mass flow rate = .0176 • 983 ÷ 7000gr/lb =	0.0025 lb/min
potential pollutant mass flow rate = .0025 • 60 =	0.1485 lb/hr
Potential annual emissions = 1.485 • 8760 =	1301 lb/yr
Potential annual emissions = 1.485 • 8760/2000 =	0.65 tons/yr

*These values are reported in the cover letter from Crawford Equipment & Engineering Co. and can be found in Attachment D.

NOx Emissions

AP-42 Emissions factor	100 lb /MM ft ³ burned
Hourly emissions = emissions factor • fuel usage =	0.30 lb/hr
Annual emissions = hourly emissions • annual hours ÷ 2000 lb/ton =	1.31 tons/yr

SO2 Emissions

AP-42 Emissions factor	0.6 lb /MM ft ³ burned
Hourly emissions = emissions factor • fuel usage =	0.00180 lb/hr
Annual emissions = hourly emissions • annual hours ÷ 2000 lb/ton =	0.00788 tons/yr

TOC Emissions

AP-42 Emissions factor	5.8 lb /MM ft ³ burned
Hourly emissions = emissions factor • fuel usage =	0.0174 lb/hr
Annual emissions = hourly emissions • annual hours ÷ 2000 lb/ton =	0.076 tons/yr

Table 1.4-1. EMISSION FACTORS FOR SULFUR DIOXIDE (SO₂), NITROGEN OXIDES (NO_x), AND CARBON MONOXIDE (CO) FROM NATURAL GAS COMBUSTION^a

Combustor Type (Size, 10 ⁶ Btu/hr Heat Input) (SCC)	SO ₂ ^b		NO _x ^c		CO ^d		N ₂ O ^e	
	Emission Factor (lb/10 ⁶ ft ³)	EMISSION FACTOR RATING	Emission Factor (lb/10 ⁶ ft ³)	EMISSION FACTOR RATING	Emission Factor (lb/10 ⁶ ft ³)	EMISSION FACTOR RATING	Emission Factor (lb/10 ⁶ ft ³)	EMISSION FACTOR RATING
Utility/large Industrial Boilers (>100) (1-01-006-01, 1-01-006-04)								
Uncontrolled	0.6	A	550 ^f	A	40	A	2.2	C
Controlled - Low NO _x burners	0.6	A	79	D	ND	NA	0.64	E
Controlled - Flue gas recirculation	0.6	A	53	D	ND	NA	NA	NA
Small Industrial Boilers (10 - 100) (1-02-006-02)								
Uncontrolled	0.6	A	140	A	35	A	2.2 ^g	E
Controlled - Low NO _x burners	0.6	A	83	D	61	D	0.64 ^g	E
Controlled - Flue gas recirculation	0.6	A	30	C	34	C	NA	NA
Commercial Boilers (0.3 - <10) (1-03-006-03)								
Uncontrolled	0.6	A	100	B	21	C	2.2 ^g	E
Controlled - Low NO _x burners	0.6	A	17	C	15	C	0.64 ^g	E
Controlled - Flue gas recirculation	0.6	A	36	D	ND	NA	NA	NA
Residential Furnaces (<0.3) (No SCC)								
Uncontrolled	0.6	A	94	B	40	B	NA	NA

^a Units are lb of pollutant/10⁶ cubic feet natural gas fired. To convert from lb/10⁶ ft³ to kg/10⁶ m³, multiply by 16.0. Based on an average natural gas fired higher heating value of 1000 Btu/scf. The emission factors in this table may be converted to other natural gas heating values by multiplying the given emission factor by the ratio of the specified heating value to this average heating value. SCC = Source Classification Code. ND = no data. NA = not applicable.

^b References 13-14. Based on average sulfur content of natural gas, 2000 gr/10⁶ scf.

^c References 12-13,15-19. Expressed as NO₂.

^d References 5,12-13,17-18,20-21.

^e References 6-7.

^f For tangentially fired units, use 275 lb/10⁶ ft³. Note: This number was originally developed for AP-42 based on limited data. No additional data are available to refine this number.

^g No data; based on the factors for utility boilers.

Table 1.4-3. EMISSION FACTORS FOR CARBON DIOXIDE (CO₂) AND TOTAL ORGANIC COMPOUNDS (TOC) FROM NATURAL GAS COMBUSTION^a

Combustor Type (Size, 10 ⁶ Btu/hr Heat Input) (SCC)	CO ₂ ^b		TOC ^c	
	Emission Factor (lb/10 ⁶ ft ³)	EMISSION FACTOR RATING	Emission Factor (lb/10 ⁶ ft ³)	EMISSION FACTOR RATING
Utility/large industrial boilers (>100) (1-01-006-01, 1-01-006-04)	1.2 E+05	B	1.7 ^d	C
Small industrial boilers (10 - 100) (1-02-006-02)	1.2 E+05	B	5.8 ^e	C
Commercial boilers (0.3 - <10) (1-03-006-03)	1.2 E+05	B	5.8	C
Residential furnaces (No SCC)	1.2 E+05	B	11	D

^aAll factors represent uncontrolled emissions. Units are lb of pollutant/10⁶ cubic feet. To convert from lb/10⁶ ft³ to kg/10⁶ m³, multiply by 16.0. Based on an average natural gas higher heating value of 1000 Btu/scf. The emission factors in this table may be converted to other natural gas heating values by multiplying the given factor by the ratio of the specified heating value to this average heating value. SCC = Source Classification Code. ND = no data. NA = not applicable.

^bReferences 8,15,27-29.

^cReferences 5,13,15,30.

^dReference 30: methane comprises 17% of organic compounds.

^eReference 30: methane comprises 52% of organic compounds.

Air Construction Permit
Application:
Walt Disney World Co.-
Disney's Animal Kingdom
CB800 Incinerator

ELSA Submittal Disk #4
Virus Scan 1/20/98
(BGS)

Air Construction Permit
Application:
Walt Disney World Co.-
Disney's Animal Kingdom
CB800 Incinerator

ELSA Submittal Disk #1
Virus Scan 1/20/98
(BGS)

**AIR CONSTRUCTION PERMIT
APPLICATION**

RECEIVED

JAN 20 1998

BUREAU OF
AIR REGULATION

**WALT DISNEY WORLD CO.
FACILITY ID NUMBER 0950111**

**DISNEY'S ANIMAL KINGDOM
MODEL CB800 INCINERATOR**

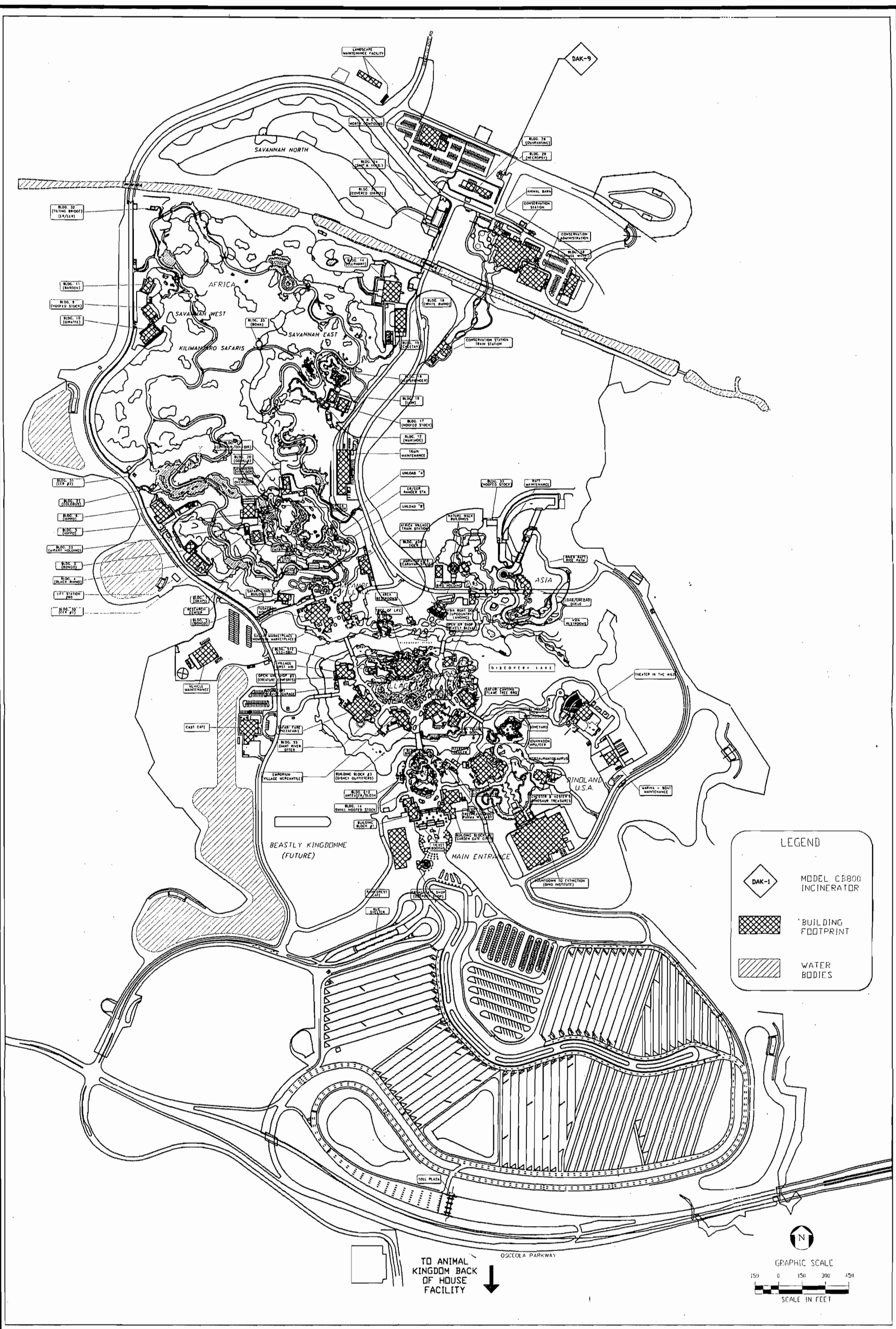

ATTACHMENT B
 FACILITY PLOT PLAN
 DISNEY'S ANIMAL KINGDOM- ANIMAL CARCASS INCINERATOR



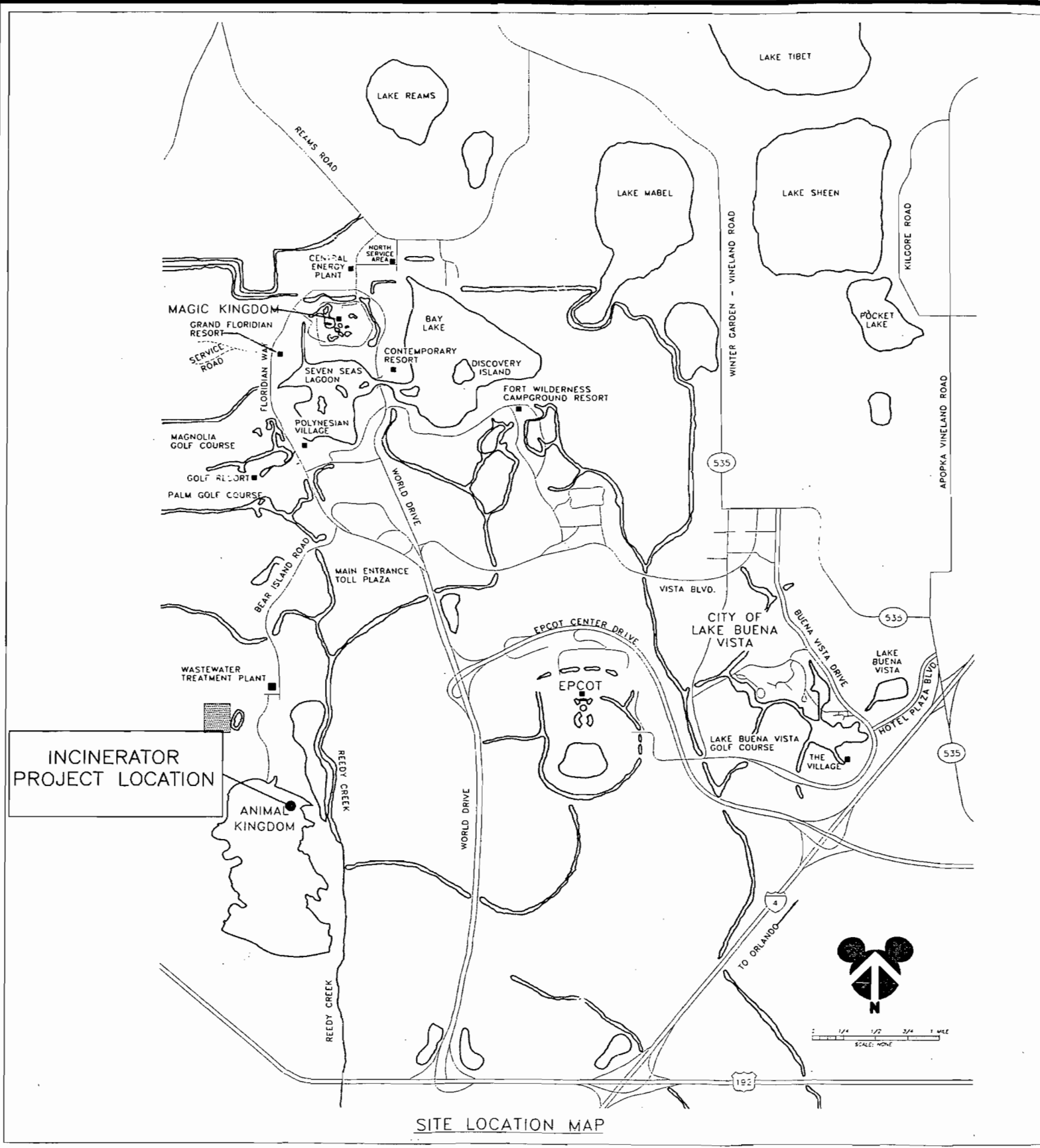

SITE LOCATION MAP

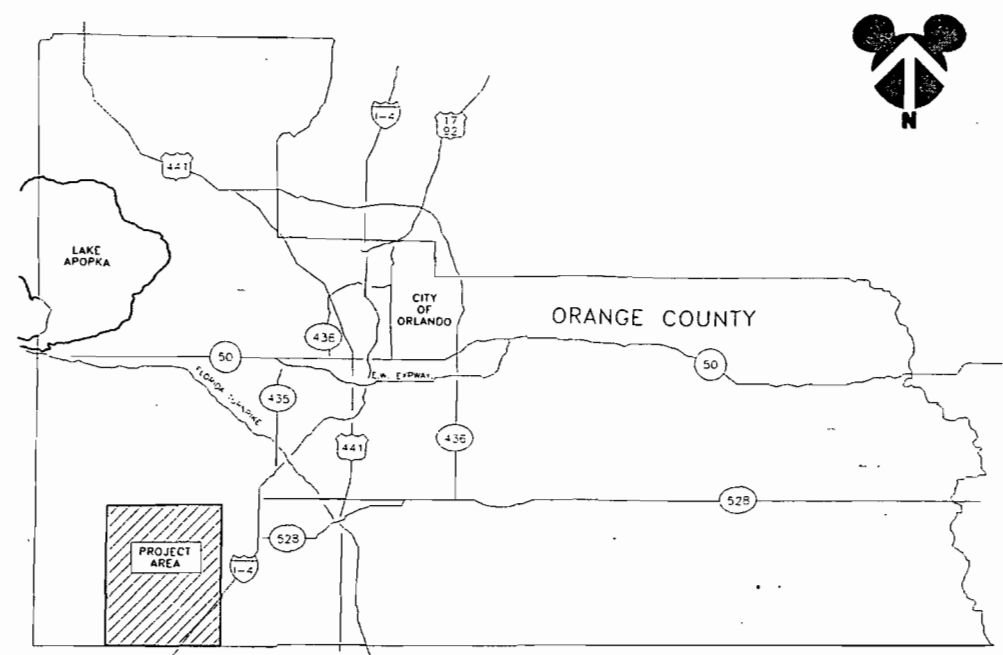

VICINITY MAP

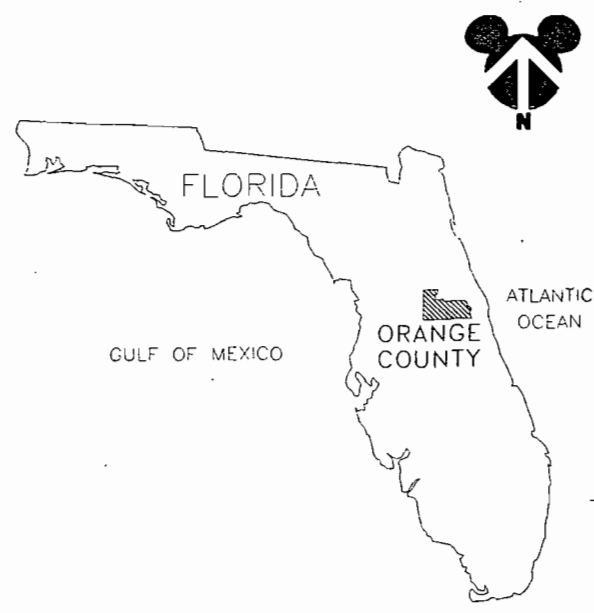

LOCATION MAP

ATTACHMENT A
 AREA MAP SHOWING FACILITY LOCATION
 ANIMAL KINGDOM - ANIMAL CARCASS ICINERATOR

