

WALT DISNEY World Co.



June 3, 1997

Mr. Scott Sheplak
Florida Department of Environmental Protection
Air Permitting and Standards
2600 Blair Stone Rd. MS 5505
Tallahassee, Florida 32399-2400

RE: Title V Operating Permit Modification Application
Boardwalk Resort Paint Spray Booth #1
Magic Kingdom Paint Spray Booth #2

Dear Mr. Sheplak:

Enclosed are one original and three copies of the Title V operating permit application for the for the above referenced emission units. In addition, four diskettes which contain the ELSA electronic submission are included. The application is an amendment to the Title V operating permit application that was submitted for the Walt Disney World Co. in June 1996.

If you have any questions or need any further information, please call me at 827-2748.

Sincerely,

Rich Bumar
Environmental Control Representative
Environmental Control Department

Enclosure

By Certified Mail

RECEIVED

JUN 05 1997

BUREAU OF
AIR REGULATION

TELECOPIER COVER SHEET (827-2774)

TO: <u>Bruce Mitchell</u>	FAX #: <u>850-922-6979</u>
FROM: <u>Rich Bumar</u>	DATE: <u>9/11/97</u>
TOTAL # PAGES: <u>2</u> (INCLUDING THIS PAGE)	

- | | |
|--|--|
| <input type="checkbox"/> THIS IS A RUSH!! | <input checked="" type="checkbox"/> REGARDING THE ATTACHED |
| <input checked="" type="checkbox"/> PER OUR DISCUSSION | <input type="checkbox"/> PLEASE COPY ALL LISTED |
| <input type="checkbox"/> PLEASE CALL ME TO DISCUSS | <input type="checkbox"/> PLEASE ACKNOWLEDGE RECEIPT |
| <input type="checkbox"/> I WILL CALL YOU TO DISCUSS | <input type="checkbox"/> FOR YOUR REVIEW AND COMMENT |

COMMENTS:

Attached is the corrected property map for
Walt Disney World.

IF YOU DO NOT RECEIVE ALL OF THESE PAGES, CALL 407-827-4524

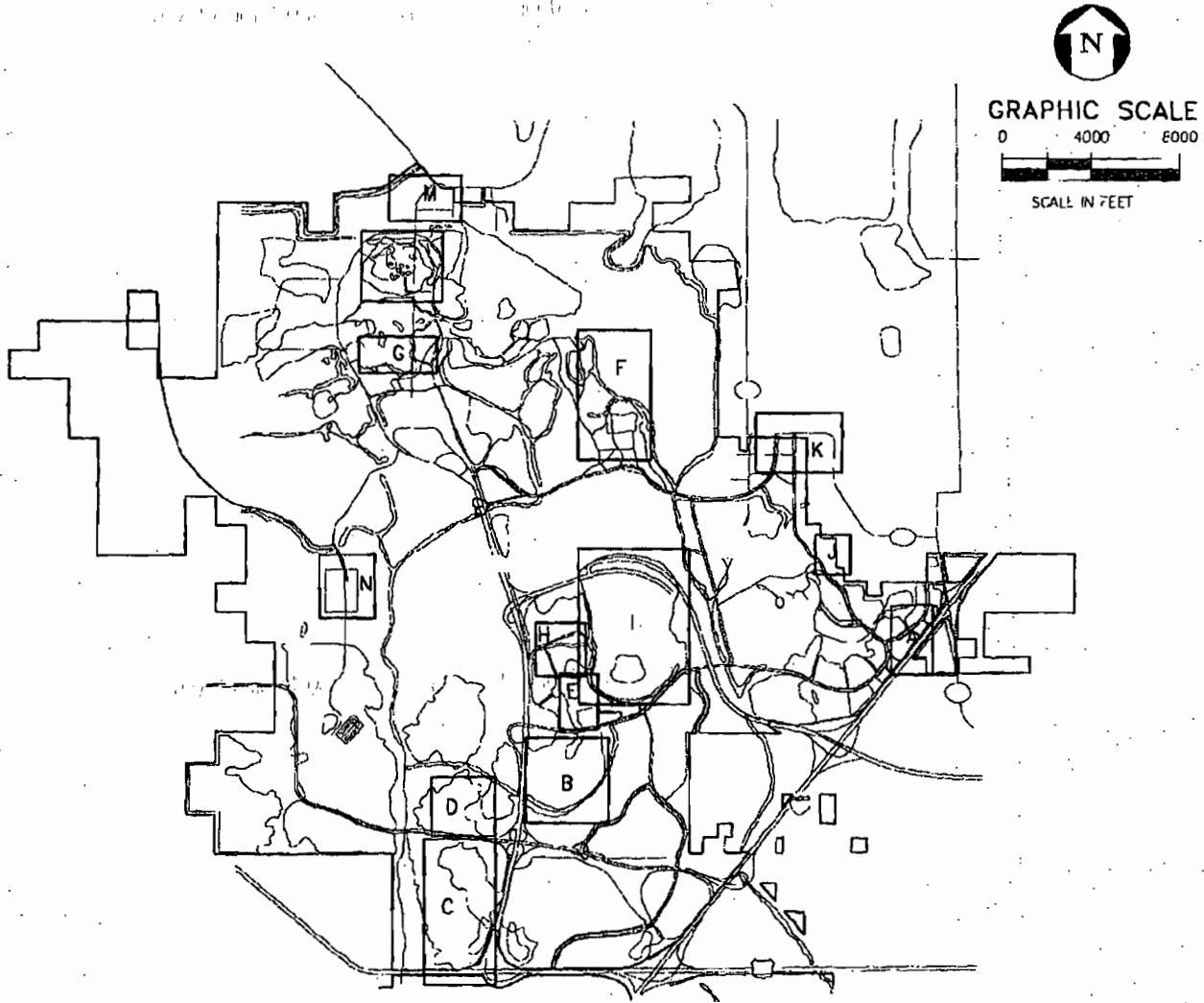

LEGEND

AREA	DESCRIPTION	FIGURE NUMBER
A	DISNEY VILLAGE MARKETPLACE.....	II.D.2.2
B	DISNEY MGM STUDIOS THEME PARK.....	II.D.2.3
C	DISNEY'S ALL-STAR RESORTS.....	II.D.2.4
D	DISNEY'S BLIZZARD BEACH.....	II.D.2.5
E	DISNEY'S BOARDWALK RESORT.....	II.D.2.6
F	DISNEY'S FORT WILDERNESS RESORT AND CAMPGROUND, SOUTH AREA.....	II.D.2.7
G	DISNEY'S POLYNESIAN RESORT.....	II.D.2.8
H	DISNEY'S YACHT AND BEACH CLUB.....	II.D.2.9
I	DISNEY'S POLYNESIAN RESORT.....	II.D.2.10
J	LAKE BUENA VISTA COMMUNITY VILLAGE.....	II.D.2.11
K	ADMINISTRATION AREA.....	II.D.2.12
L	MAGIC KINGDOM.....	II.D.2.13
M	NORTH SERVICE AREA.....	II.D.2.14
N	SOUTH SERVICE AREA.....	II.D.2.15

FIGURE II.D.2.1.

**WALT DISNEY WORLD RESORT COMPLEX
ZONE LOCATION MAP**

Source: WDW Co., 1997. ECT, 1995.



Walt  Disney World®

RESORT COMPLEX

APPLICATION PACKAGE
FOR A TITLE V OPERATING PERMIT

WALT DISNEY WORLD CO.

Lake Buena Vista, Florida

June 1996

Walt  Disney World[®]

RESORT COMPLEX

**APPLICATION PACKAGE
FOR A TITLE V OPERATING PERMIT**

WALT DISNEY WORLD CO.

Lake Buena Vista, Florida

June 1996

TABLES OF CONTENTS

HARDCOPY SUBMITTAL

<u>Section</u>	<u>Tab</u>
Signature Pages	Signatures
Facility Supplemental Information	
Area Map Showing Facility Location	Doc. II.D.1
Facility Plot Plans	Doc. II.D.2
Process Flow Diagrams	Doc. II.D.3
Compliance Certification	Doc. II.D.14
Emission Unit Supplemental Information	
Fuel Analysis or Specification	Doc. III.I.2
Detailed Description of Control Equipment	Doc. III.I.3
Description of Stack Sampling Facilities	Doc. III.I.4
Acid Rain Application	Doc. III.I.14
Appendices	
Current Permits	Appendix C

TABLES OF CONTENTS
(Continued, Page 2 of 2)

ELECTRONIC SUBMITTAL

<u>Section</u>	<u>File Name</u>
Application for Air Permit—Long Form (ELSA) (Note—APP.ZIP contains all of the following supplemental files)	WDW.ZIP
Facility Supplemental Information	
Precautions to Prevent Emissions of Unconfined Particulate Matter	IID4
Fugitive Emissions Identification	IID5
List of Proposed Exempt Activities	IID7
List of Equipment/Activities Regulated Under Title VI	IID8
Alternate Methods of Operation	IID9
Compliance Report and Plan	IID13.ZIP
Emission Unit Supplemental Information	
Procedures for Startup and Shutdown	CTSTART.DOC
Appendix	
Regulatory Applicability Analysis	APPEND_A.ZIP
Emission Rate Summary	APPEND_B.ZIP

Signatures

Owner/Authorized Representative or Responsible Official

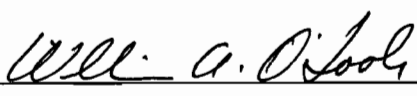
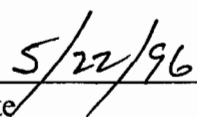
1. Name and Title of Owner/Authorized Representative or Responsible Official: William A. O'Toole Senior Vice President
2. Owner/Authorized Representative or Responsible Official Mailing Address: Organization/Firm: Walt Disney World Co. Street Address: P.O. Box 10,000 City: Lake Buena Vista, State: Florida Zip Code: 32830-1000
3. Owner/Authorized Representative or Responsible Official Telephone Numbers: Telephone: (407) 828-3701 Fax: (407) 828-3239
4. Owner/Authorized Representative or Responsible Official Statement: <i>I, the undersigned, am the owner or authorized representative* of the non-Title V source addressed in this Application for Air Permit or the responsible official, as defined in Rule 62-210.200, F.A.C., of the Title V source addressed in this application, whichever is applicable. I hereby certify, based on information and belief formed after reasonable inquiry, that the statements made in this application are true, accurate and complete and that, to the best of my knowledge, any estimates of emissions reported in this application are based upon reasonable techniques for calculating emissions. The air pollutant emissions units and air pollution control equipment described in this application will be operated and maintained so as to comply with all applicable standards for control of air pollutant emissions found in the statutes of the State of Florida and rules of the Department of Environmental Protection and revisions thereof. I understand that a permit, if granted by the Department, cannot be transferred without authorization from the Department, and I will promptly notify the Department upon sale or legal transfer of any permitted emissions unit.</i>  Signature  Date

* Attach letter of authorization if not currently on file.

Professional Engineer Certification

1. Professional Engineer Name: **Thomas W. Davis**
Registration Number: **36777**

2. Professional Engineer Mailing Address:

Organization/Firm: **Environmental Consulting & Technology, Inc.**
Street Address: **3701 NW 98th Street**
City: **Gainesville** State: **FL** Zip Code: **32606**

3. Professional Engineer Telephone Numbers:

Telephone: **(352) 332-0444** Fax: **(352) 332-6722**

4. Professional Engineer Statement:

I, the undersigned, hereby certify, except as particularly noted herein, that:*

(1) To the best of my knowledge, there is reasonable assurance that the air pollutant emissions unit(s) and the air pollution control equipment described in this Application for Air Permit, when properly operated and maintained, will comply with all applicable standards for control of air pollutant emissions found in the Florida Statutes and rules of the Department of Environmental Protection; and

(2) To the best of my knowledge, any emission estimates reported or relied on in this application are true, accurate, and complete and are either based upon reasonable techniques available for calculating emissions or, for emission estimates of hazardous air pollutants not regulated for an emissions unit addressed in this application, based solely upon the materials, information and calculations submitted with this application.

If the purpose of this application is to obtain a Title V source air operation permit (check here if so), I further certify that each emissions unit described in this Application for Air Permit, when properly operated and maintained, will comply with the applicable requirements identified in this application to which the unit is subject, except those emission units for which a compliance schedule is submitted with this application.

If the purpose of this application is to obtain an air construction permit for one or more proposed new or modified emissions units (check here if so), I further certify that the engineering features of each such emissions unit described in this application have been designed or examined by me or individuals under my direct supervision and found to be in conformity with sound engineering principles applicable to the control of emissions of the air pollutants characterized in this application.

If the purpose of this application is to obtain an initial air operation permit or operation permit revision for one or more newly constructed or modified emissions units (check here if so), I further certify that, with the exception of any changes detailed as part of this application, each such emissions unit has been constructed or modified in substantial accordance with the information given in the corresponding application for air construction permit and with all provisions contained in such permit.



Thomas W. Duwa
Signature

6/7/96
Date

* Attach any exception to certification statement.

DOCUMENT II.D.1

**AREA MAP SHOWING FACILITY LOCATION
(DOCUMENT II.E.1—MARCH 1996 REVISED FORM)**

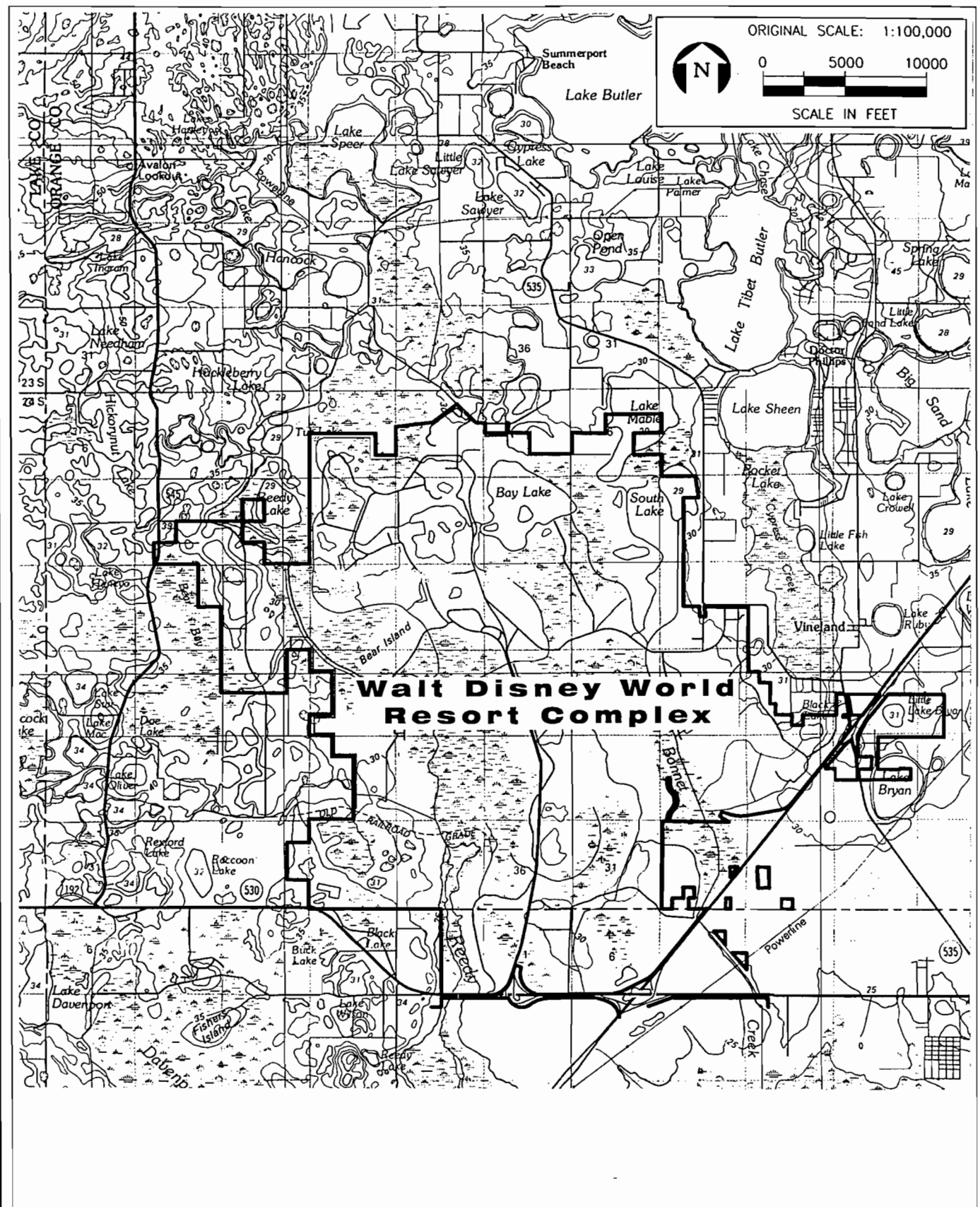

FIGURE I.I.D.1.

WALT DISNEY WORLD RESORT COMPLEX
SITE LOCATION MAP

Source: USGS 30/60 Quad, Kissimmee, FL, 1979.



DOCUMENT II.D.2

**FACILITY PLOT PLANS
(DOCUMENT II.E.2—MARCH 1996 REVISED FORM)**

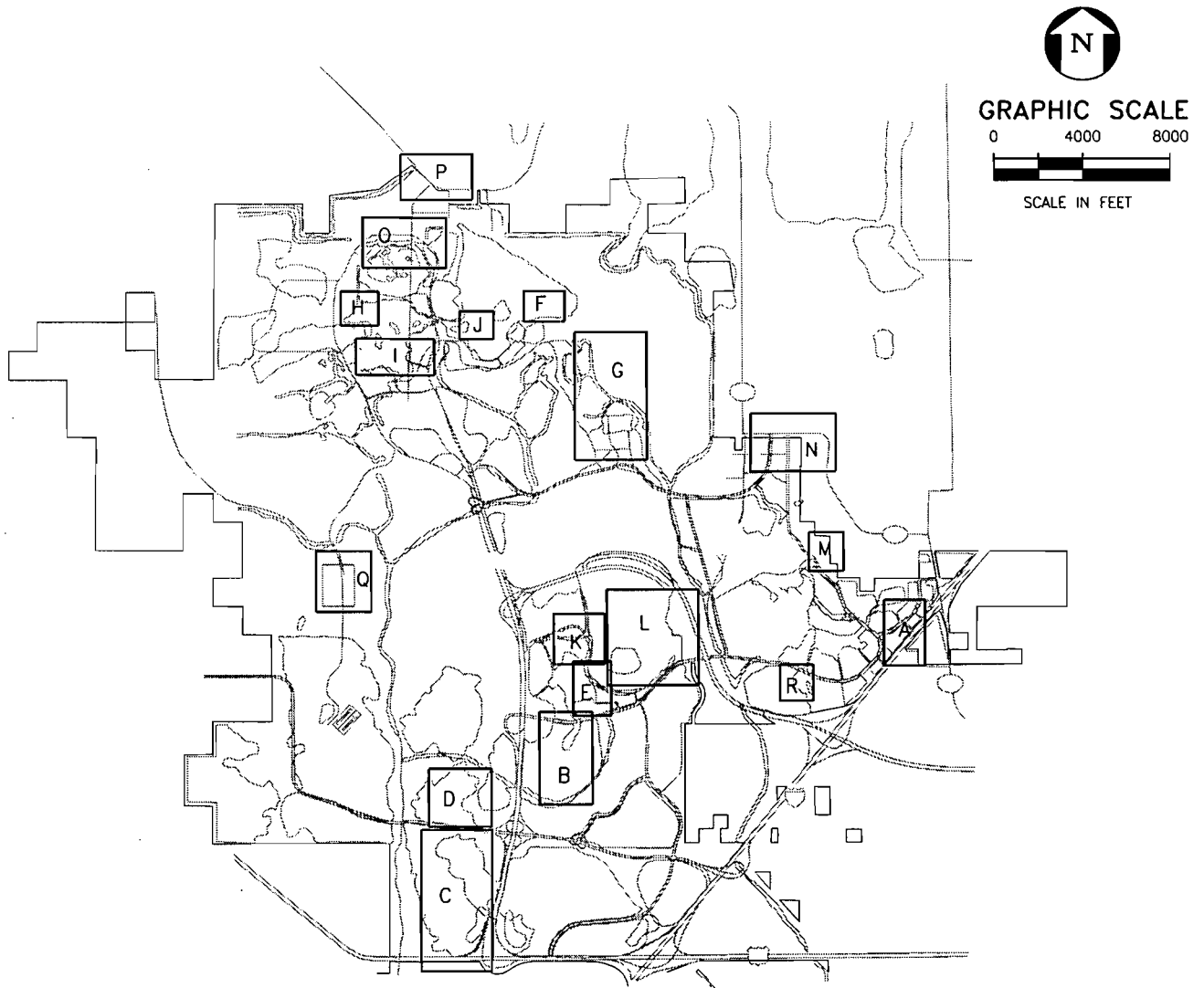

LEGEND

- | | | | |
|---|---|---|------------------------------------|
| A | DISNEY VILLAGE MARKETPLACE | G | DISNEY'S POLYNESIAN RESORT |
| B | DISNEY MGM STUDIOS THEME PARK | H | DISNEY'S YACHT AND BEACH CLUB |
| C | DISNEY'S ALL-STAR RESORTS | I | EPCOT CENTER |
| D | DISNEY'S BLIZZARD BEACH | J | LAKE BUENA VISTA COMMUNITY VILLAGE |
| E | DISNEY'S BOARDWALK RESORT | K | ADMINISTRATION AREA |
| F | DISNEY'S FORT WILDERNESS RESORT
AND CAMPGROUND, SOUTH AREA | L | MAGIC KINGDOM |
| | | ⊙ | NORTH SERVICE AREA |
| | | N | SOUTH SERVICE AREA |

m Lake

FIGURE I1.D.2.1.

WALT DISNEY WORLD RESORT COMPLEX
ZONE LOCATION MAP

Source: WDW Co., 1995. ECT, 1995.



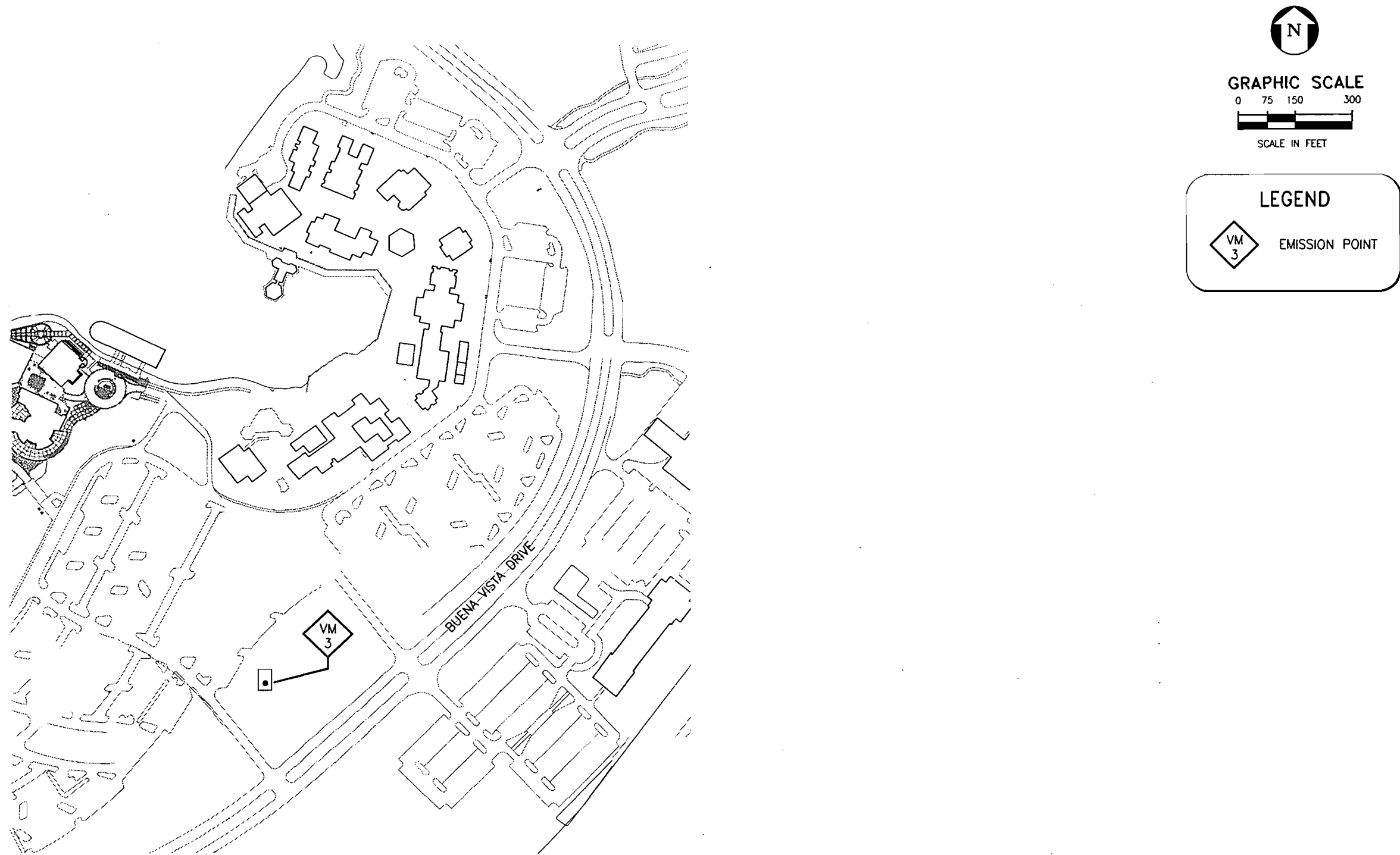

FIGURE I.D.2.2.

WALT DISNEY WORLD RESORT COMPLEX EMISSION SOURCE LOCATION
DISNEY VILLAGE MARKETPLACE

Source: WDW Co., 1995. ECT, 1995.



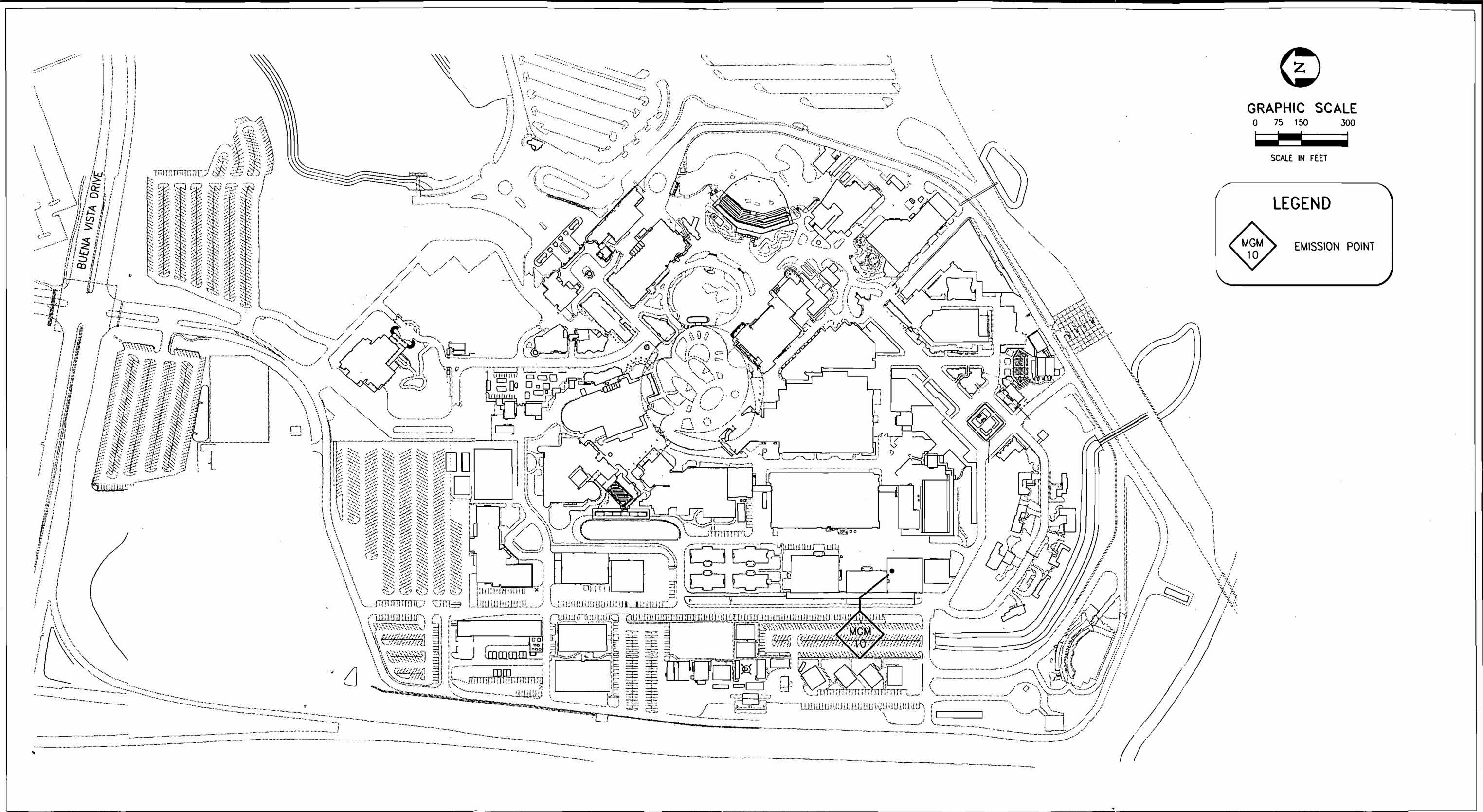
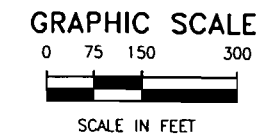
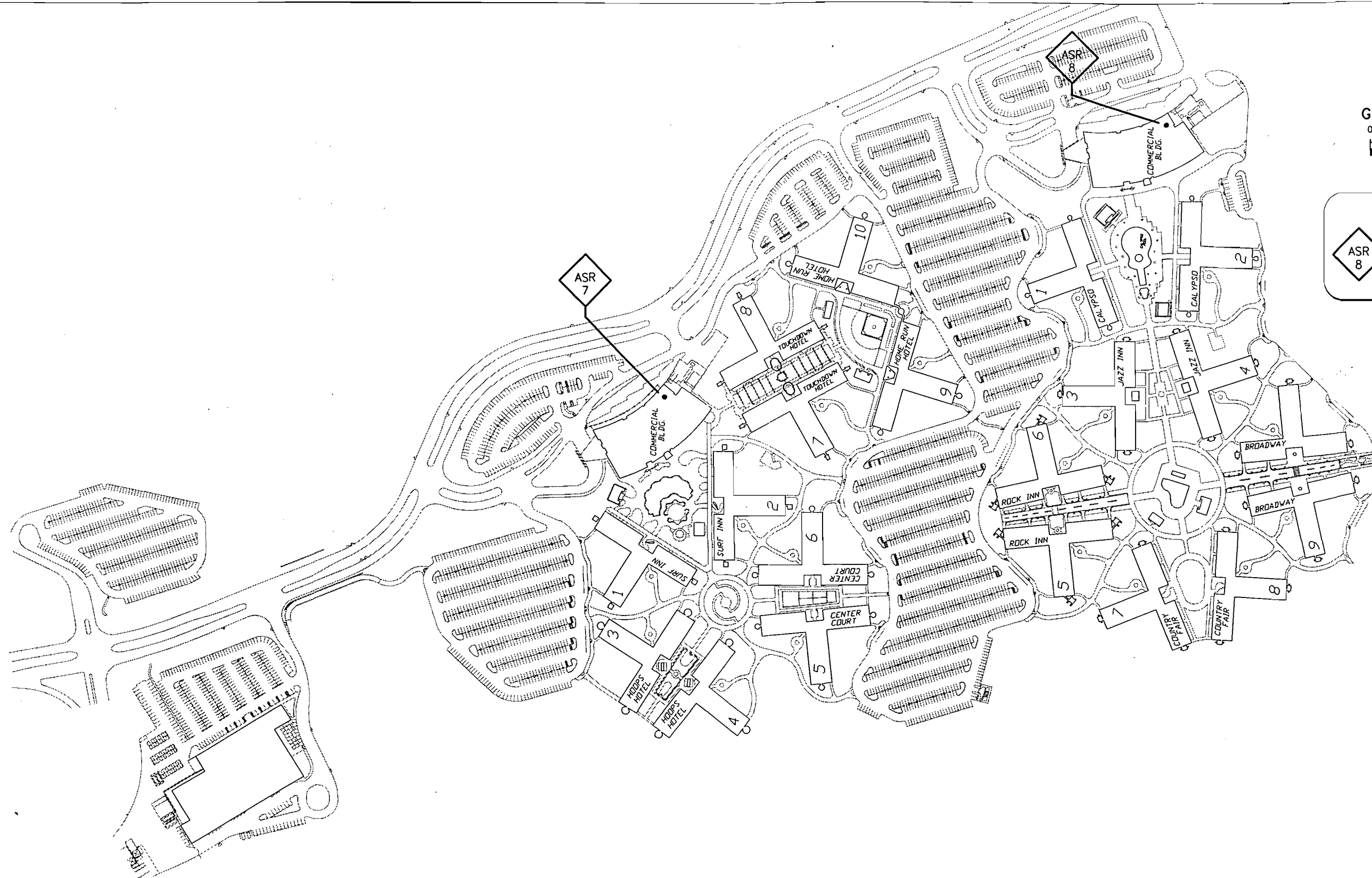

FIGURE I.I.D.2.3.

WALT DISNEY WORLD RESORT COMPLEX EMISSION SOURCE LOCATION
DISNEY-MGM STUDIOS THEME PARK

Source: WDW Co., 1995. ECT, 1995.





LEGEND

ASR 8 EMISSION POINT

FIGURE I.D.2.4.
 WALT DISNEY WORLD RESORT COMPLEX EMISSION SOURCE LOCATION
 DISNEY'S ALL-STAR RESORTS
 Source: WDW Co., 1995. ECT, 1995.



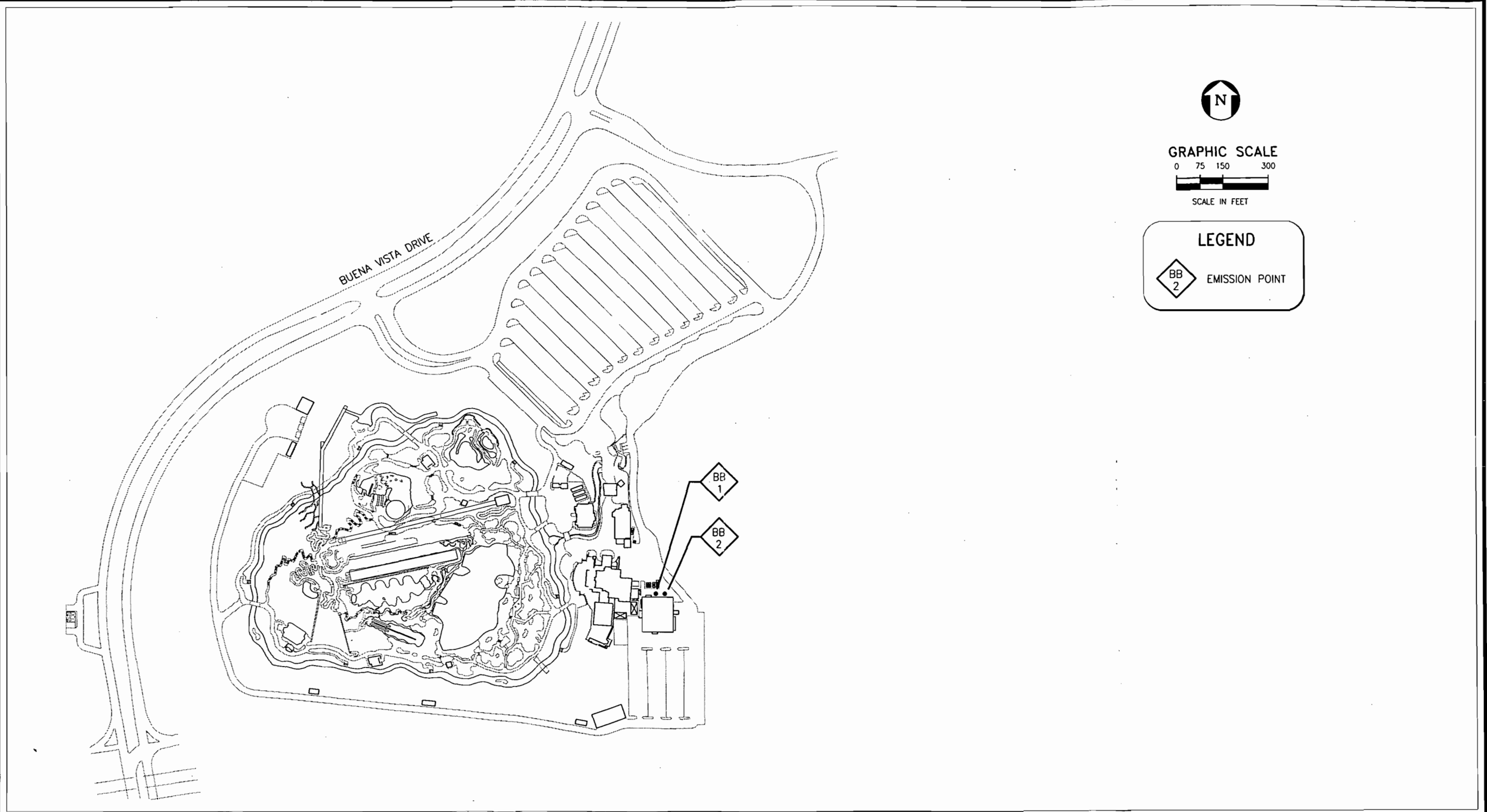

FIGURE II.D.2.5.

WALT DISNEY WORLD RESORT COMPLEX EMISSION SOURCE LOCATION
DISNEY'S BLIZZARD BEACH

Source: WDW Co., 1995. ECT, 1995.



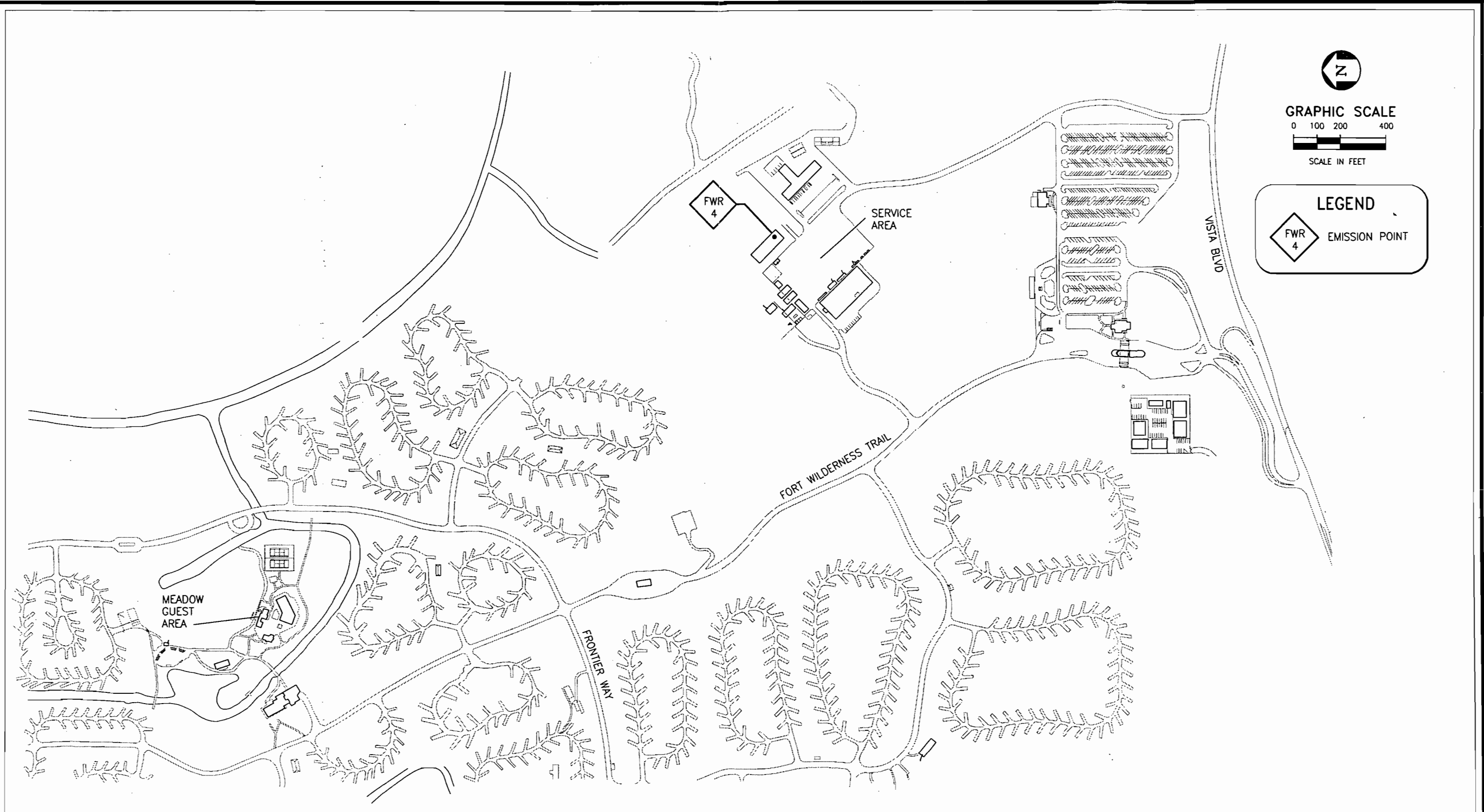

FIGURE II.D.2.7.

WALT DISNEY WORLD RESORT COMPLEX EMISSION SOURCE LOCATION
DISNEY'S FORT WILDERNESS RESORT AND CAMPGROUND, SOUTH AREA

Source: WDW Co., 1995. ECT, 1995.



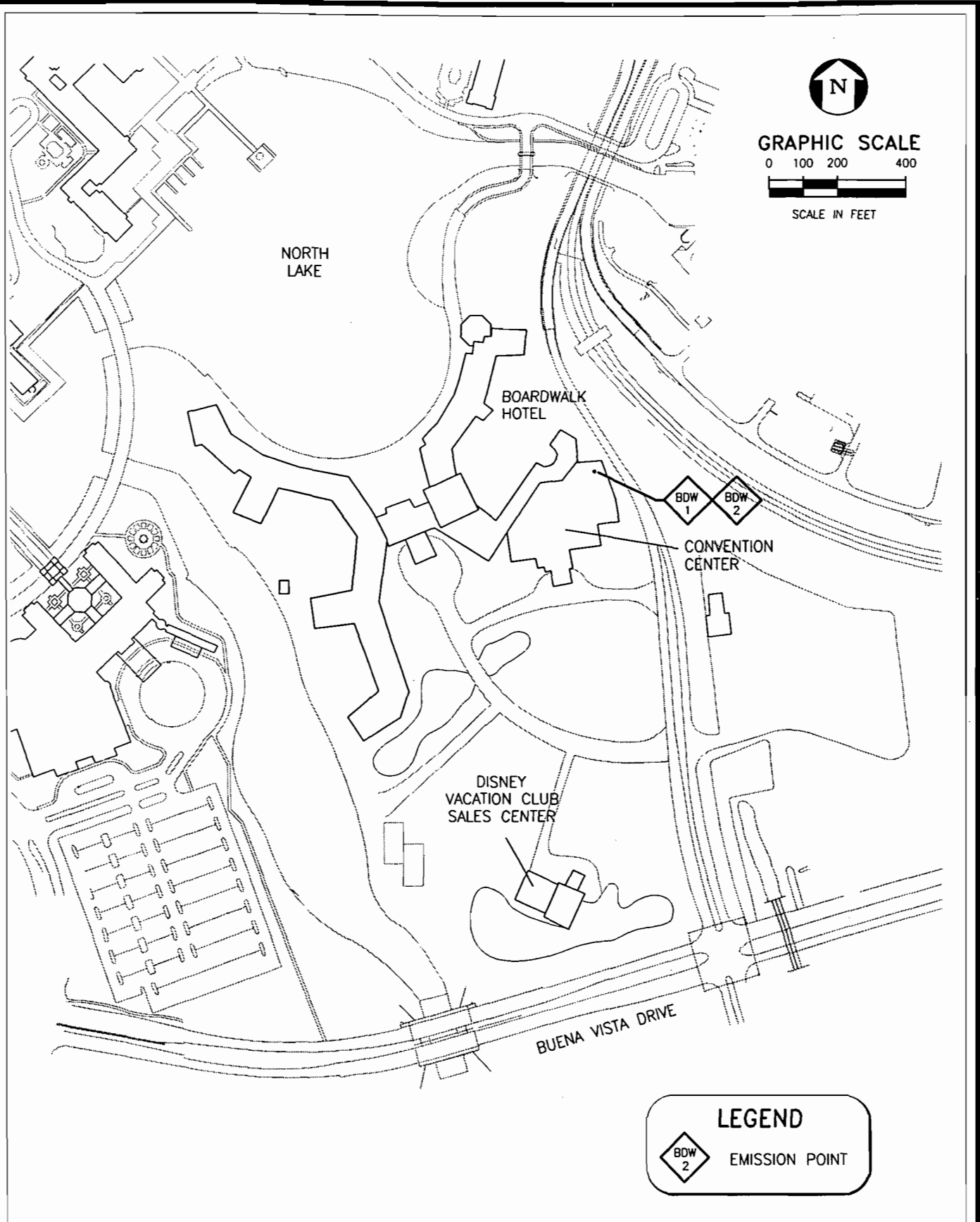

FIGURE II.D.2.6.
WALT DISNEY WORLD RESORT COMPLEX
EMISSION SOURCE LOCATION
DISNEY'S BOARDWALK RESORT

Source: WDW Co., Inc., 1995. ECT, 1995.



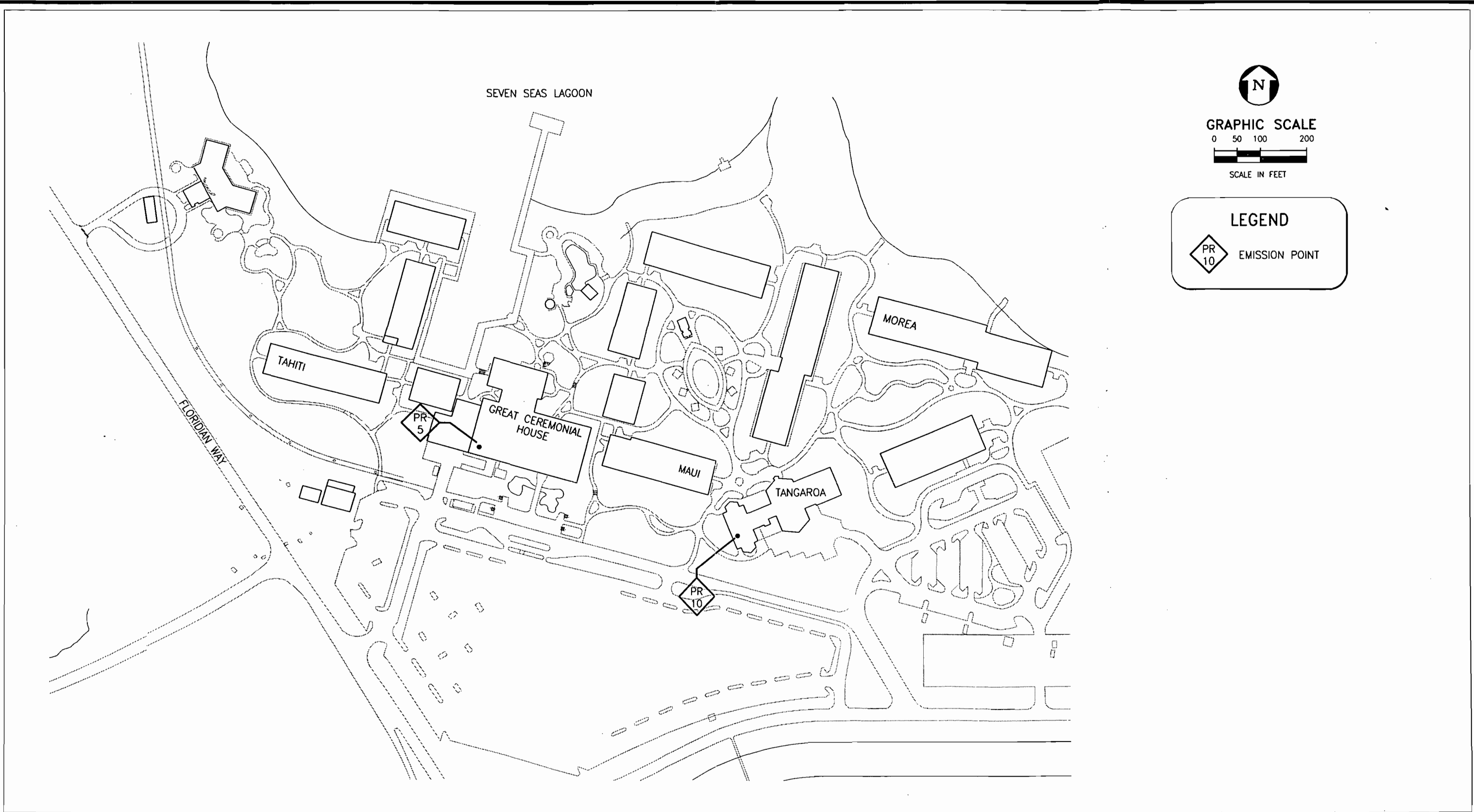

FIGURE I.D.2.8.

WALT DISNEY WORLD RESORT COMPLEX EMISSION SOURCE LOCATION
DISNEY'S POLYNESIAN RESORT

Source: WDW Co., 1995. ECT, 1995.



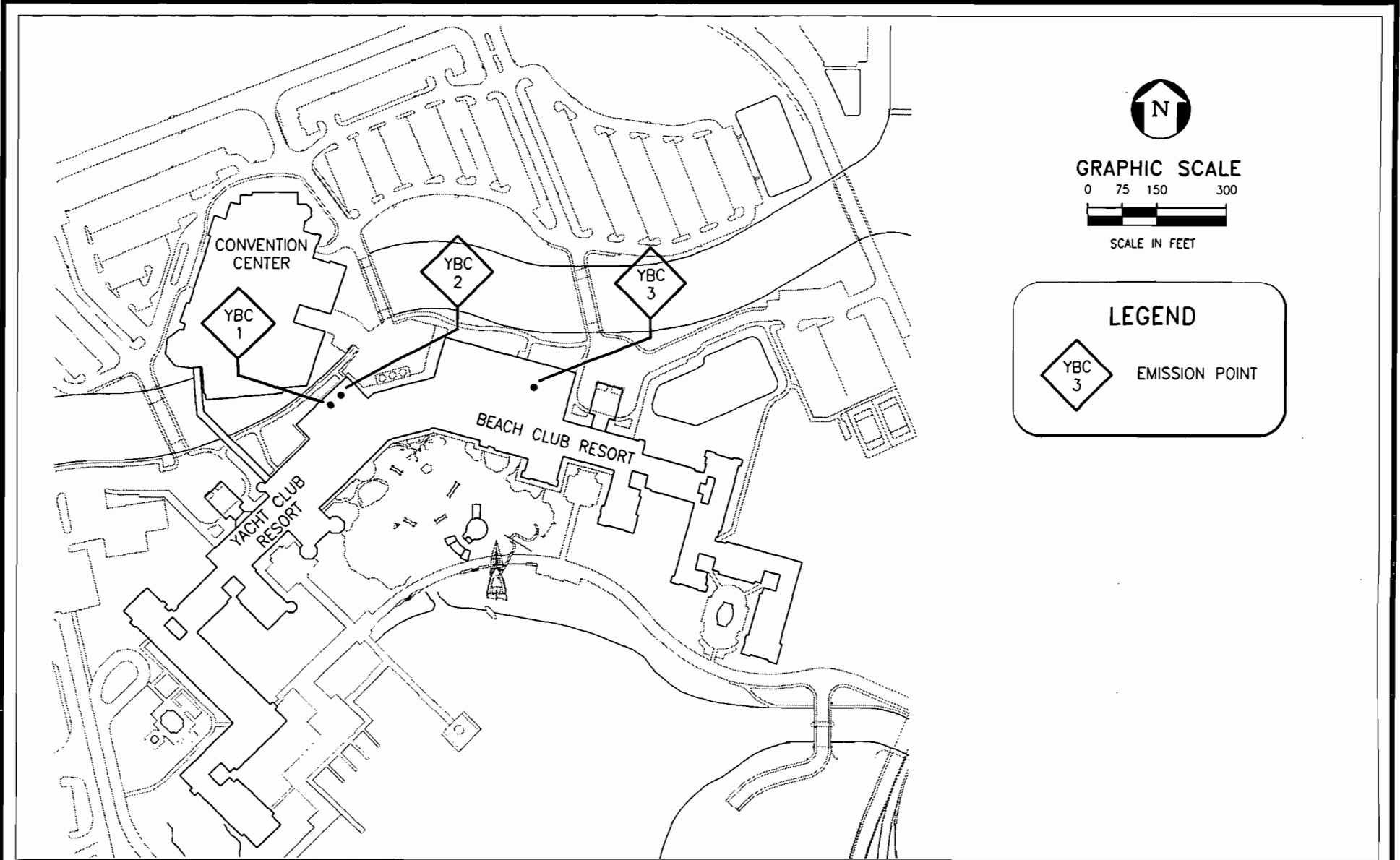

FIGURE II.D.2.9.

WALT DISNEY WORLD RESORT COMPLEX EMISSION SOURCE LOCATION
DISNEY'S YACHT AND BEACH CLUB

Source: WDW Co., 1995. ECT, 1995.



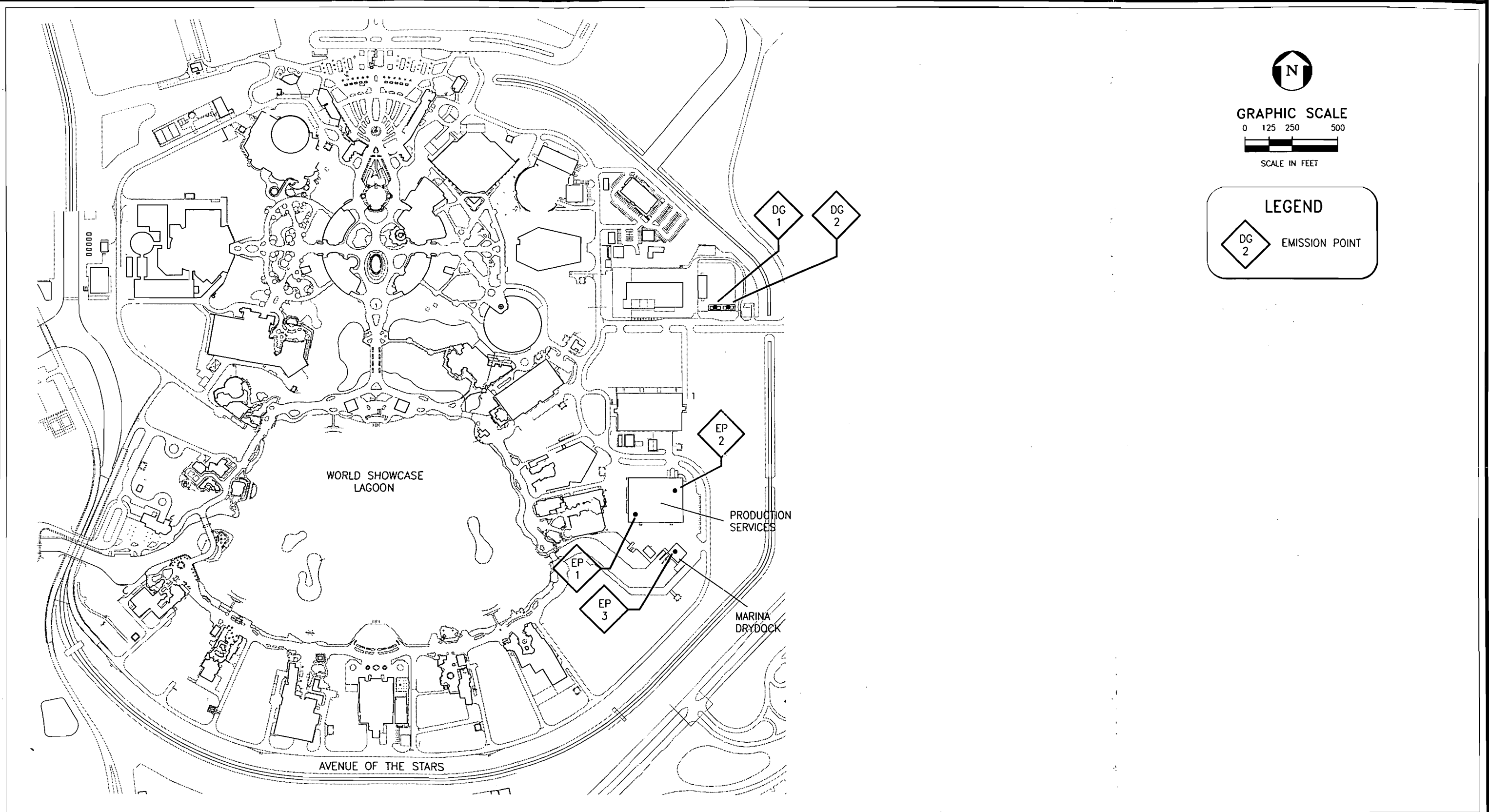

FIGURE I1.D.2.10.
 WALT DISNEY WORLD RESORT COMPLEX EMISSION SOURCE LOCATION
 EPCOT CENTER
 Source: WDW Co., 1995. ECT, 1995.



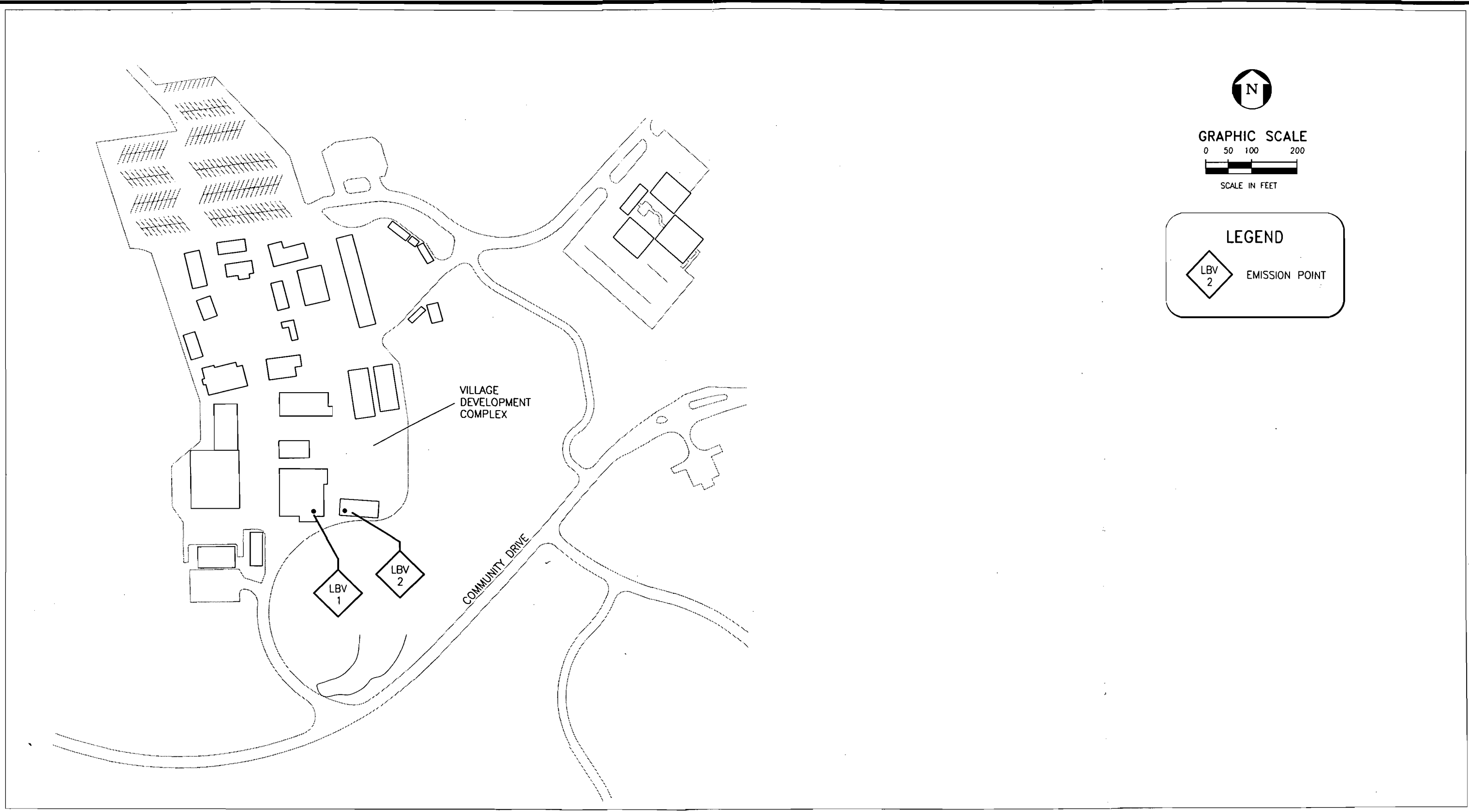

FIGURE II.D.2.11.

WALT DISNEY WORLD RESORT COMPLEX EMISSION SOURCE LOCATION
LAKE BUENA VISTA COMMUNITY VILLAGE

Source: WDW Co., 1995. ECT, 1995.



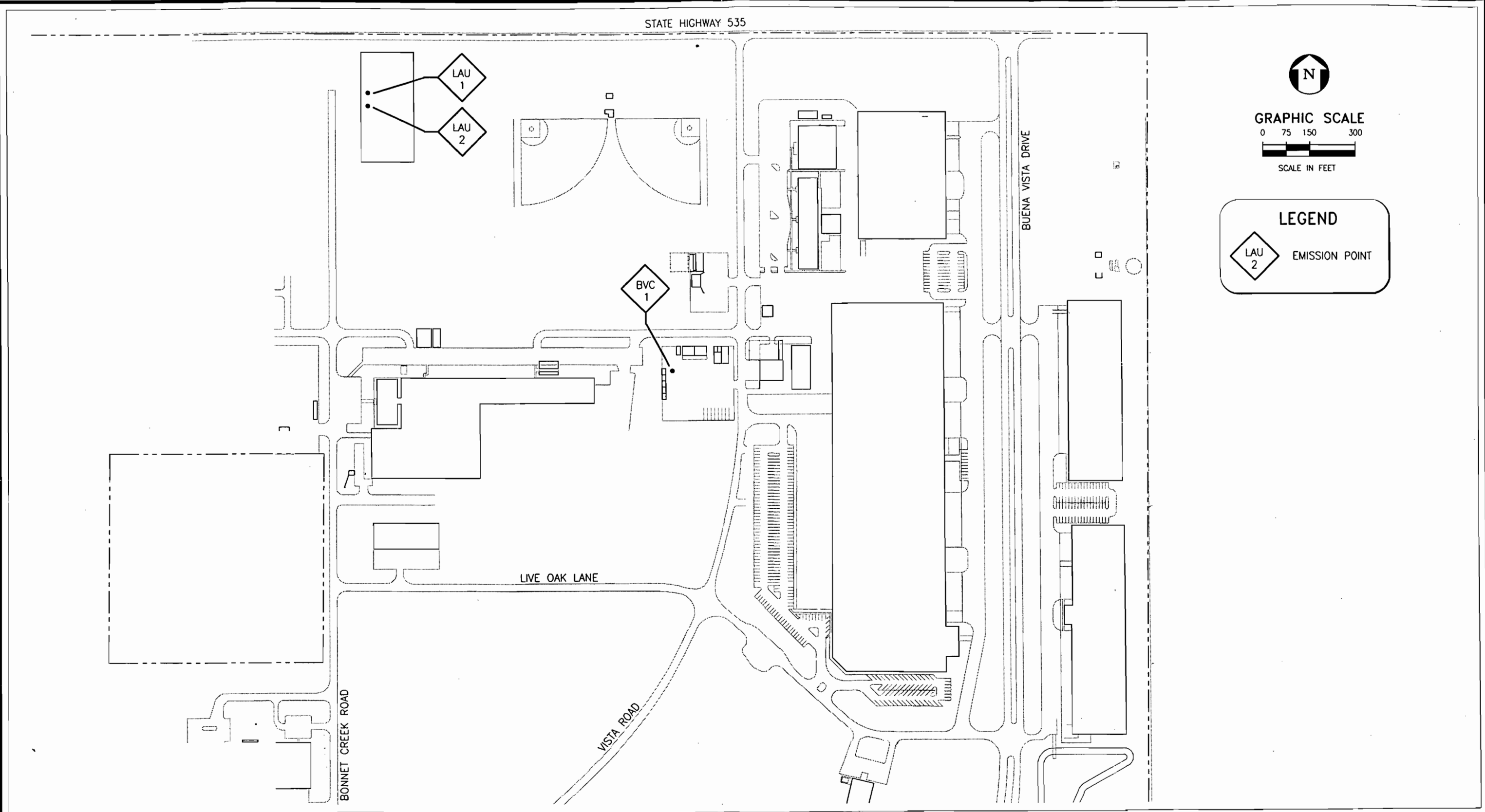
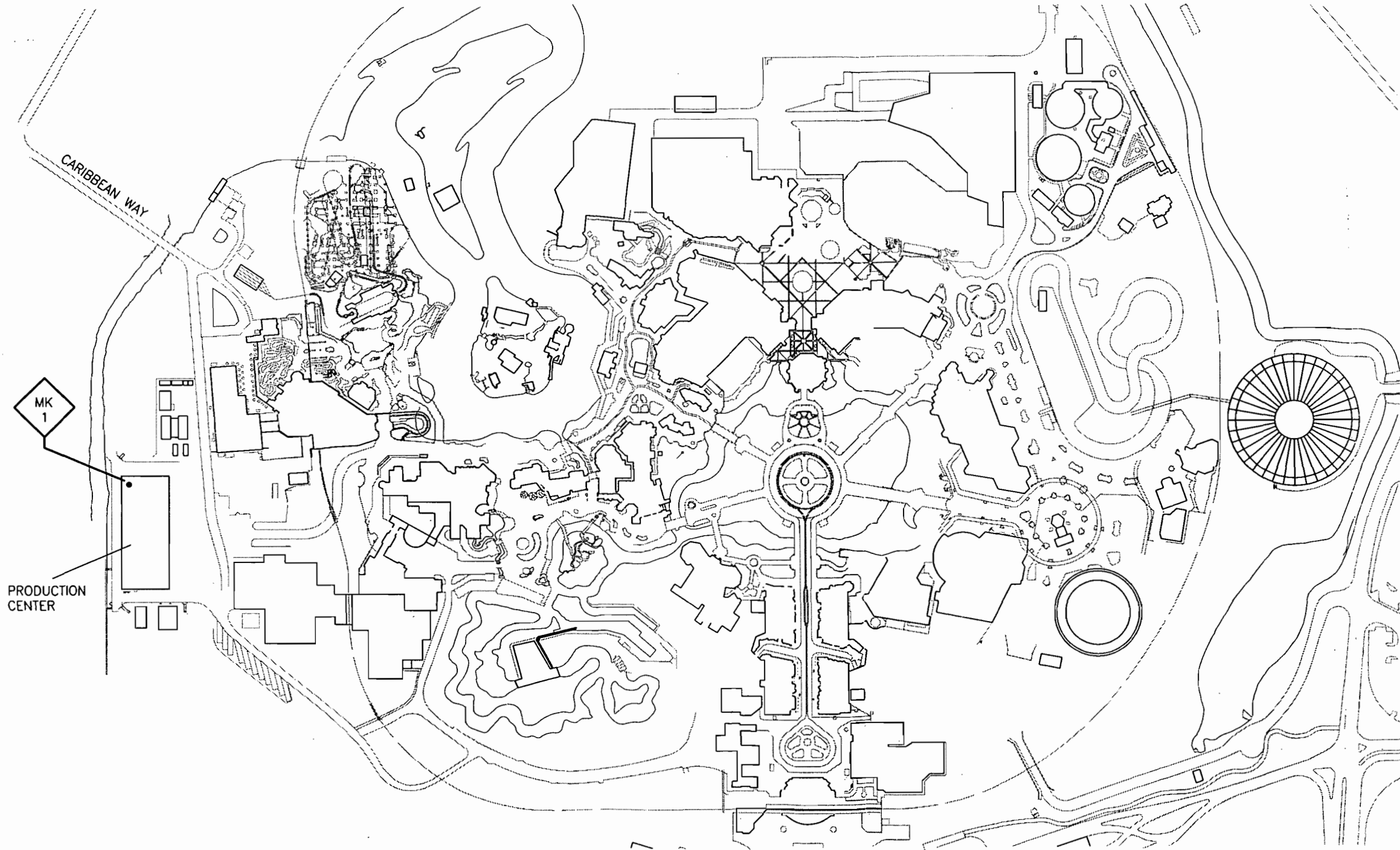

FIGURE II.D.2.12.

WALT DISNEY WORLD RESORT COMPLEX EMISSION SOURCE LOCATION
ADMINISTRATION AREA

Source: WDW Co., 1995. ECT, 1995.





GRAPHIC SCALE

0 75 150 300



SCALE IN FEET

LEGEND



EMISSION POINT

FIGURE II.D.2.13.

WALT DISNEY WORLD RESORT COMPLEX EMISSION SOURCE LOCATION
MAGIC KINGDOM

Source: WDW Co., 1995. ECT, 1995.



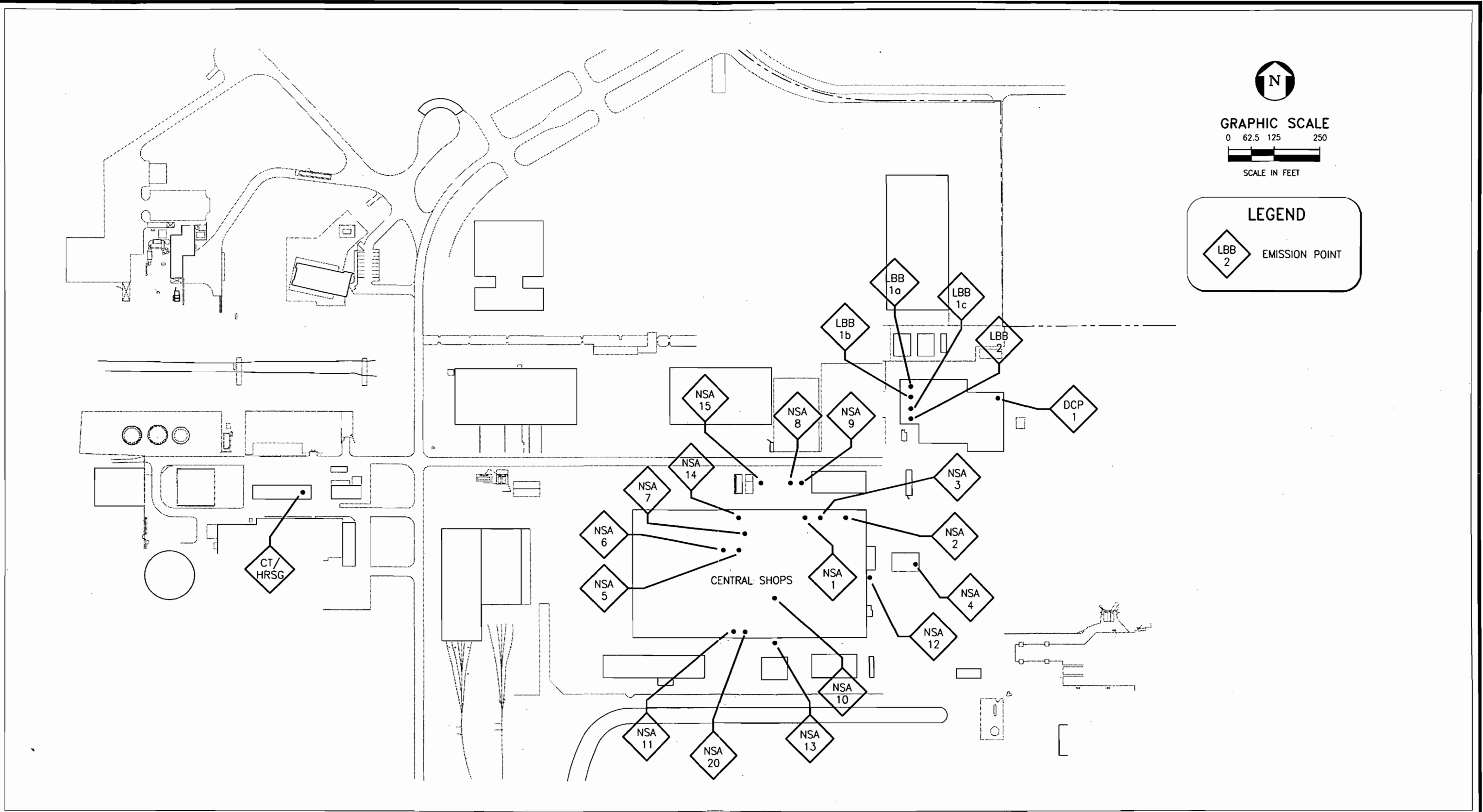

FIGURE II.D.2.14.

WALT DISNEY WORLD RESORT COMPLEX EMISSION SOURCE LOCATION
NORTH SERVICE AREA

Source: WDW Co., 1995. ECT, 1995.



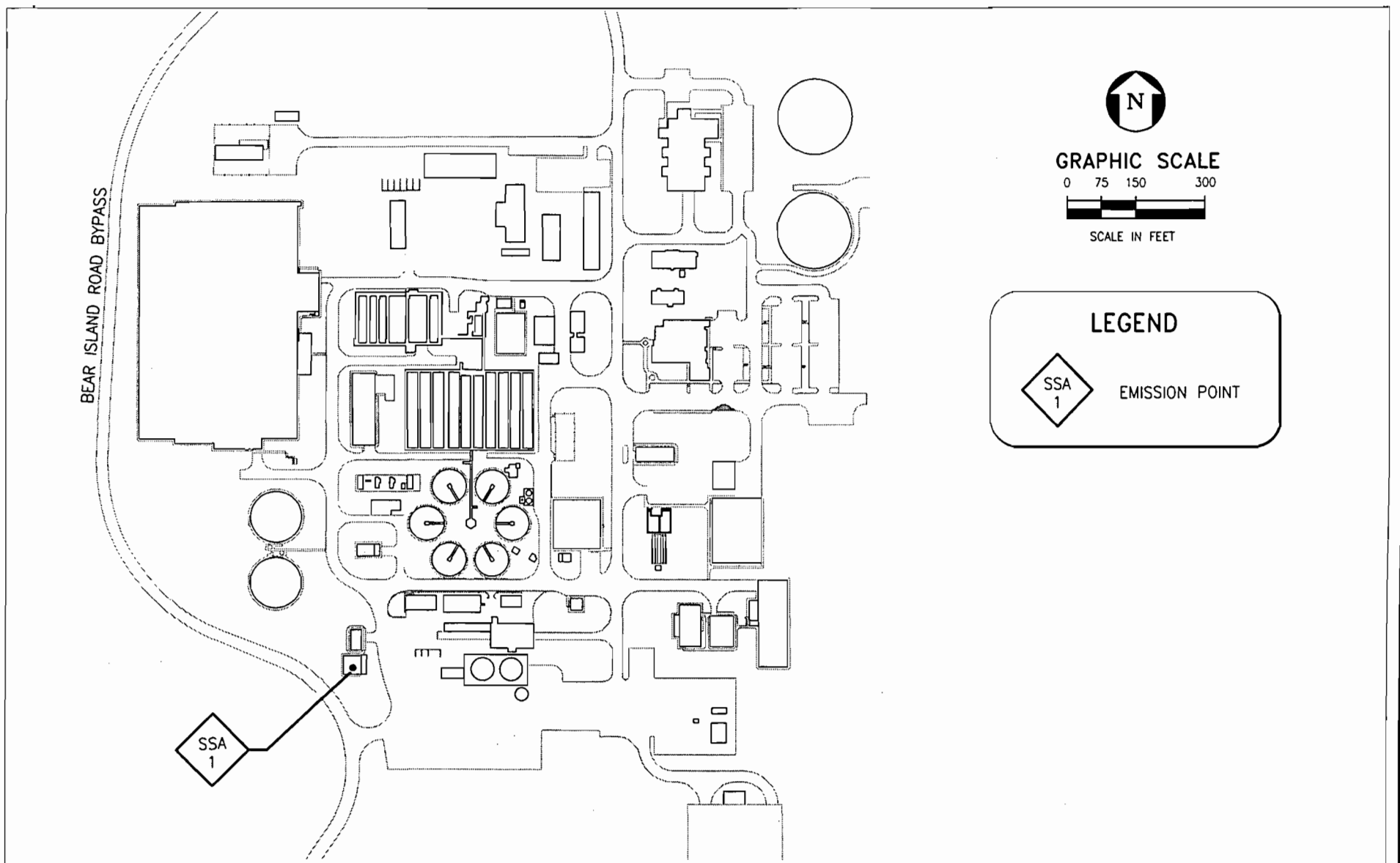

FIGURE II.D.2.15.

WALT DISNEY WORLD RESORT COMPLEX EMISSION SOURCE LOCATION
SOUTH SERVICE AREA

Source: WDW Co., 1995. ECT, 1995.



DOCUMENT II.D.3

**PROCESS FLOW DIAGRAMS
(DOCUMENT II.E.3—MARCH 1996 REVISED FORM)**

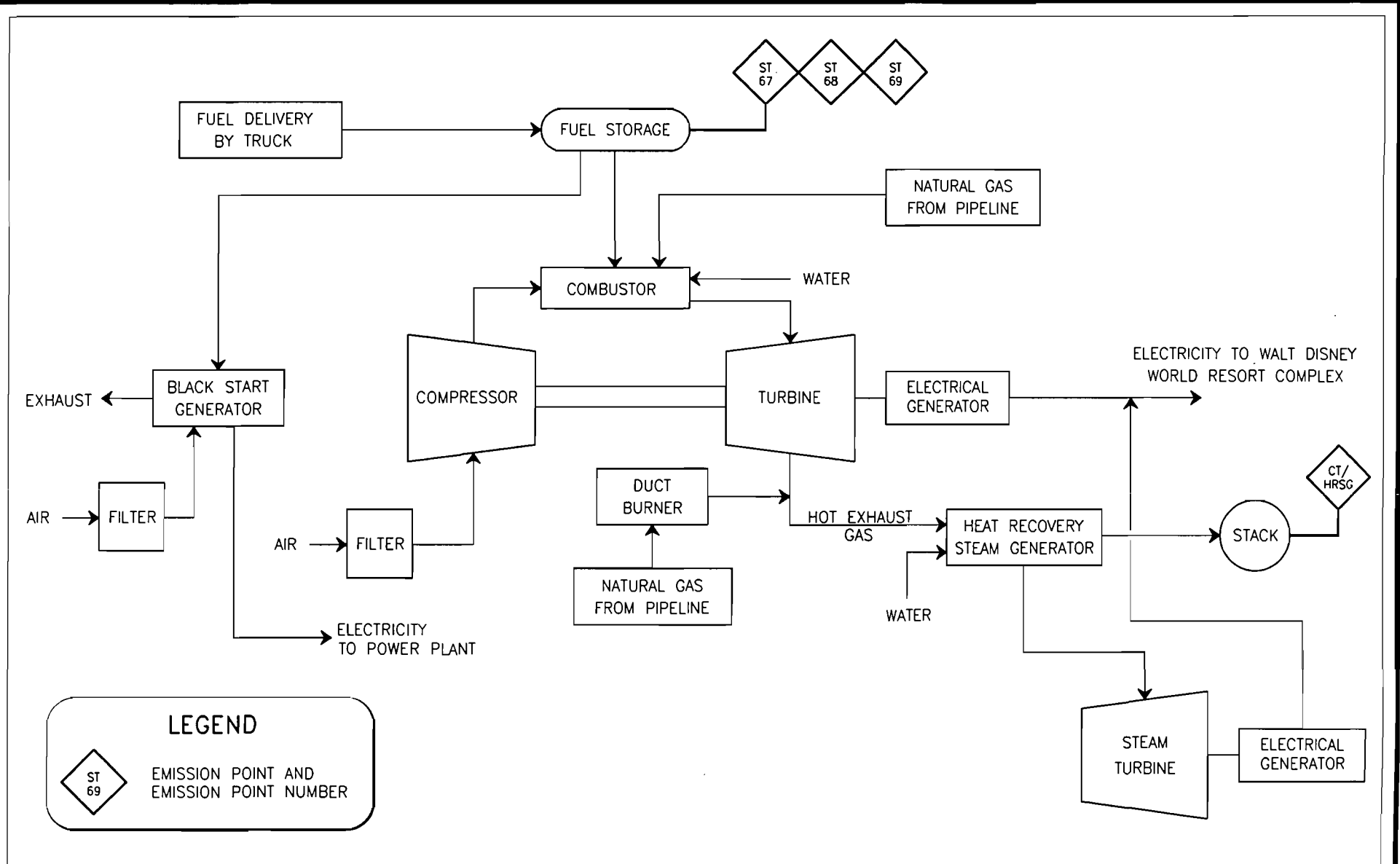

LEGEND



 EMISSION POINT AND EMISSION POINT NUMBER

FIGURE II.D.3.1.
WALT DISNEY WORLD RESORT COMPLEX: PROCESS SCHEMATIC DIAGRAM
NORTH SERVICE AREA COMBUSTION TURBINE
 Source: ECT, 1996.



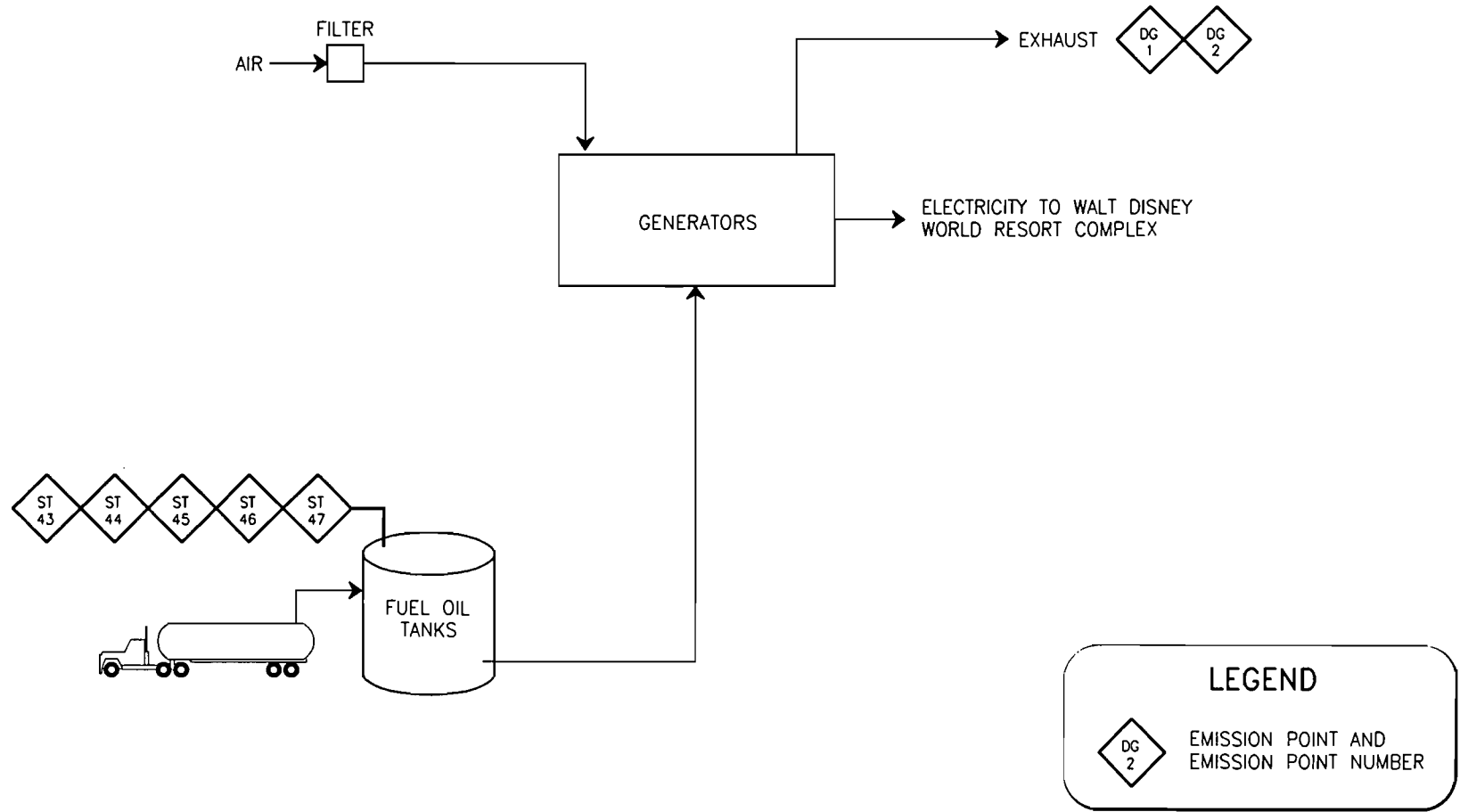

FIGURE II.D.3.2.

WALT DISNEY WORLD RESORT COMPLEX: PROCESS SCHEMATIC DIAGRAM
EPCOT CENTER DIESEL-FIRED ELECTRICAL GENERATORS (TYPICAL)

Source: ECT, 1996.



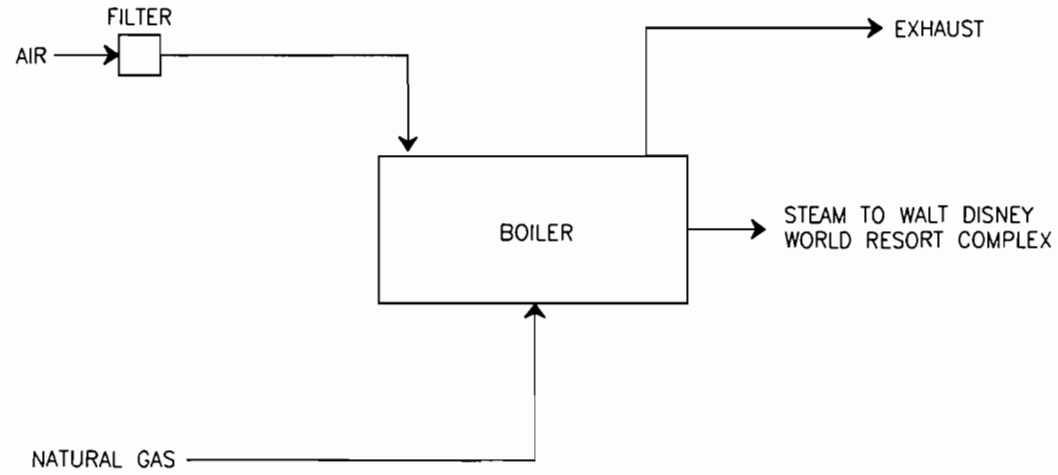

FIGURE II.D.3.3.

WALT DISNEY WORLD RESORT COMPLEX: PROCESS SCHEMATIC DIAGRAM
STEAM BOILER (TYPICAL)

Source: ECT, 1996.



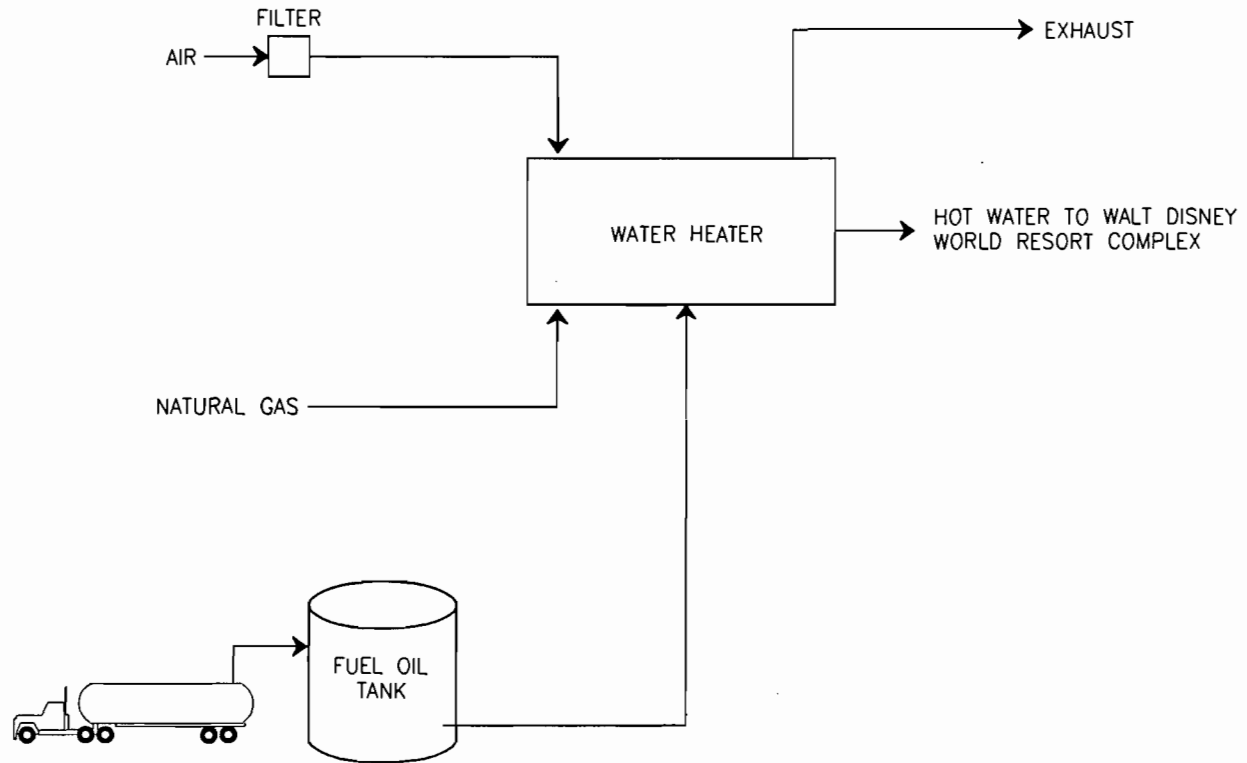

FIGURE I.I.D.3.4.

WALT DISNEY WORLD RESORT COMPLEX: PROCESS SCHEMATIC DIAGRAM
NATURAL GAS AND NO. 2 FUEL OIL-FIRED WATER HEATER (TYPICAL)

Source: ECT, 1996.



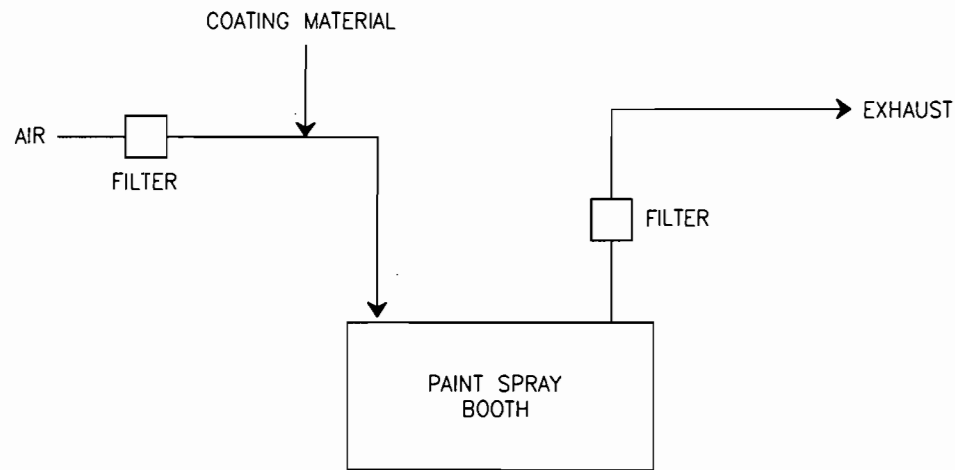
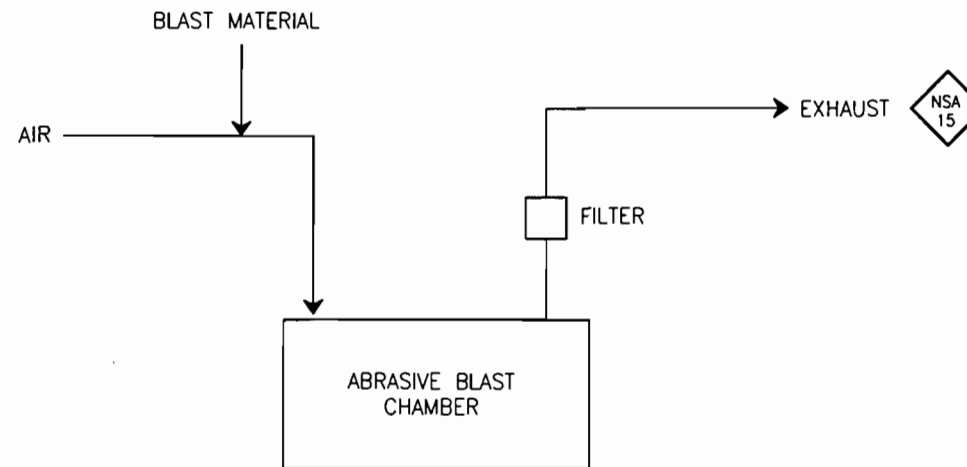

FIGURE II.D.3.5.

WALT DISNEY WORLD RESORT COMPLEX: PROCESS SCHEMATIC DIAGRAM
PAINT SPRAY BOOTH (TYPICAL)

Source: ECT, 1996.





LEGEND

 EMISSION POINT AND EMISSION POINT NUMBER

FIGURE II.D.3.6.

WALT DISNEY WORLD RESORT COMPLEX: PROCESS SCHEMATIC DIAGRAM
ABRASIVE BLAST CHAMBER

Source: ECT, 1996.



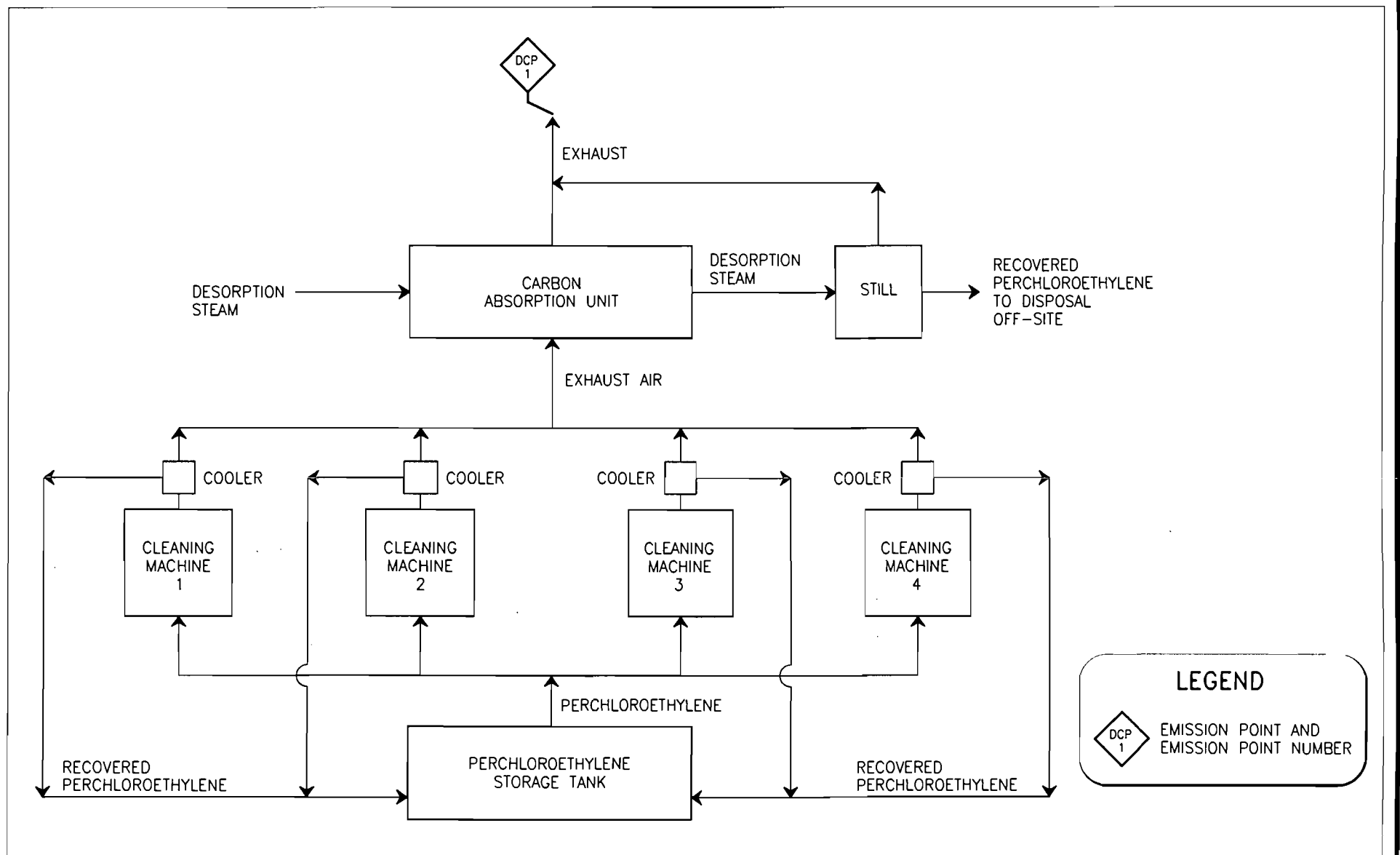

LEGEND

DCP 1 EMISSION POINT AND EMISSION POINT NUMBER

FIGURE II.D.3.7.

WALT DISNEY WORLD RESORT COMPLEX: PROCESS SCHEMATIC DIAGRAM
NORTH SERVICE AREA DRY CLEANING PLANT

Source: ECT, 1996.



DOCUMENT II.D.14

**COMPLIANCE CERTIFICATION
(DOCUMENT II.E.15—MARCH 1996 REVISED FORM)**

COMPLIANCE CERTIFICATION

1. **Proposed Schedule for the Submission of Periodic Compliance Statements Throughout the Permit Term.**

Periodic Compliance Statements are proposed to be submitted on an annual basis, consistent with FDEP Rule 62-213.440(3)(b), F.A.C.

2. **Compliance Certification**

I, the undersigned, am the responsible official as defined in Chapter 62-210.200, F.A.C., of the Title V source for which this report is being submitted. I hereby certify, based on information and belief formed after reasonable inquiry, that the statements made and data contained in this report are true, accurate, and complete.

Wesley A. A. [Signature]
Signature

5/22/96
Date

DOCUMENT III.I.2

**FUEL ANALYSIS OR SPECIFICATION
(DOCUMENT III.L.2--MARCH 1996 REVISED FORM)**



PAGES: 1 DATE: 5-13 FAX #
 TO: Larry Purvis
 FROM: Johnny
 CO.
 LABORATORY TEST RECORD FAX #

OFFICE : SGS - Tampa
 TEL : (813) 247-3984
 SGS FILE # : 423650
 CLIENT : Reedy Creek REF :

FUEL OILS

SAMPLE # : P 08 6 01283
 SAMPLE IDENTIFICATION : # 1 CEP Fuel Tank; 172,398 gallons; # 2 Fuel oil; 5/6/96
 LAB # : 408-9605-1901 DATE TESTED : 5/10/96

CRUDE OIL

PRODUCT : No. 6 No. 2 (DIESEL) GAS OIL CAT FEED MDO

D 1298 GRAVITY, RELATIVE DENSITY 60 F/60 F	D 130 CORROSION, COPPER hr. @ F/C	
D 287 GRAVITY, API @ 60 F	D 611 ANILINE POINT, F	
D 93/92 FLASH POINT, F PMCC/COC	D 323 REID VAPOR PRESSURE, psi	
D 1796/4007 SEDIMENT & WATER, Vol. %	D 189 CONRADSON CARBON RES., WL %	
D 473 SEDIMENT BY EXTRACTION, WL %	D 524 RAMSBOTTOM CARBON RES., WL %	
D 445 VISCOSITY @ F/C	D 4530 MICRO-CARBON RESIDUE, WL %	
D 445 VISCOSITY @ F/C	D 978 CETANE INDEX	
D 445 VISCOSITY @ F/C	CABOT B.M.C.I.	
D 2500 CLOUD POINT, F/C	DISTILLATION	
D 97 POUR POINT, C	<input type="checkbox"/> D 86 F	<input type="checkbox"/> D 1160 @ 760 mmHg F
D 2009/4294 SULFUR, WL % approx 0.0441	I.B.P.	70%
D 482 ASH, WL %	5%	80%
D 240 GROSS BTU/LB/GAL/BBL	10%	90%
D 1500/166 COLOR, ASTM SAYBOLT	20%	95%
D 3228 NITROGEN, WL % < 0.015	30%	END PT.
D 2781A/B COMPATIBILITY, SPOT #	40%	% REC.
MICROCOULOMETER D 3230/UOP 22 CHLORIDES, INORG, ppm/Wt %	50%	% RES
MICROCOULOMETER D 3230/420 WASHED CHLORIDES, ORG, ppm/Wt %	60%	% LOSS
D 3230/UOP 22 SALT, LBS/1000 BBLs.		
IP 30 DOCTOR TEST	TRACE METALS (AAS), ppm Wt.	
IP 143/03279 ASPHALTENES, WL %	<input type="checkbox"/> ORGANIC DILUTION	<input type="checkbox"/> WET ASHING
SMS 2696 SHELL HOT FILTRATION	ALUMINUM	MAGNESIUM
EXISTENT DRY SLUDGE, WL %	ARSENIC	MANGANESE
ACCELERATED DRY SLUDGE, WL %	CALCIUM	MERCURY
D 95/4006 WATER BY DISTILLATION, Vol. %	CADMIUM	NICKEL
D 4377 WATER BY KARL FISHER, Vol. %	CHROMIUM	POTASSIUM
	COBALT	SILICON
	COPPER	SODIUM
	IRON	VANADIUM
	LEAD	

REPORTED TO : L. Harcus BY :
 DATE & TIME : 5/13/96 0921 SUPERVISOR : R. Moore 5/13/96 0917

* SEE ASSOCIATED LABTEST AND BLENDING EVALUATION WORKSHEET.



LABORATORY TEST RECORD

OFFICE : SGS - Tampa

TEL : (813) 247-3984

SGS FILE # : 423621

CLIENT : Reedy Creek REF :

FUEL OILS

SAMPLE # : P 08 6 01059

SAMPLE IDENTIFICATION : CEP # 3 Fuel Tank 110,700 gallons # 2 Fuel Oil

LAB # : 408-9604-2801

DATE TESTED : 4/23/96

CRUDE OIL

PRODUCT : No. 6

No. 2 (DIESEL)

GAS OIL

CAT FEED

MDO

D 1298 GRAVITY, RELATIVE DENSITY 60 F/60 F	D 130 CORROSION, COPPER hr. @ F/C	
D 287 GRAVITY, API @ 60 F	D 611 ANILINE POINT, F	
D 93/92 FLASH POINT, F PMCC / COC	D 323 REID VAPOR PRESSURE, psi	
D 1796/4007 SEDIMENT & WATER, Vol. %	D 189 CONRADSON CARBON RES., Wt. %	
D 473 SEDIMENT BY EXTRACTION, Wt. %	D 524 RAMSBOTTOM CARBON RES., Wt. %	
D 445 VISCOSITY @ F/C	D 4530 MICRO-CARBON RESIDUE, Wt. %	
D 445 VISCOSITY @ F/C	D 976 CETANE INDEX	
D 445 VISCOSITY @ F/C	CABOT B.M.C.I.	
D 2500 CLOUD POINT, F/C	DISTILLATION	
D 97 POUR POINT, C	<input type="checkbox"/> D 85 F	<input type="checkbox"/> D 1160 @ 760 mmHg F
D 1353/4294 SULFUR, Wt. % / ppm ppm 0.0448	I.B.P.	70%
D 482 ASH, Wt. %	5%	80%
D 240 GROSS BTU/LB/GAL/BBL	10%	90%
D 1500/156 COLOR, ASTM SAYBOLT	20%	95%
D 3228 NITROGEN, Wt. % < 0.015	30%	END PT.
D 2781A/B COMPATISILITY, SPOT #	40%	% REC.
MICROCOULOMETER D 3230/UOP 22 / D 828 CHLORIDES, INORG, ppm/Wt. %	50%	% RES.
MICROCOULOMETER D 3230/420 WASHED CHLORIDES, ORG, ppm/Wt. %	60%	% LOSS
D 3230/UOP 22 SALT, LBS/1000 BBL.		
IP 30 DOCTOR TEST	TRACE METALS (AAS), ppm Wt.	
IP 143/D3279 ASPHALTENES, Wt. %	<input type="checkbox"/> ORGANIC DILUTION	<input type="checkbox"/> WET ASHING
SMS 2696 SHELL HOT FILTRATION	ALUMINUM	MAGNESIUM
EXISTENT DRY SLUDGE, Wt. %	ARSENIC	MANGANESE
ACCELERATED DRY SLUDGE, Wt. %	CALCIUM	MERCURY
D 95/4006 WATER BY DISTILLATION, Vol. %	CADMIUM	NICKEL
D 4377 WATER BY KARL FISHER, Vol. %	CHROMIUM	POTASSIUM
	COBALT	SILICON
	COPPER	SODIUM
	IRON	VANADIUM
	LEAD	
REPORTED TO : J. R. ROSS	BY :	
DATE & TIME : 4/24/96 ORSS	SUPERVISOR : R. Moore	4/24/96 ORSS

* SEE ASSOCIATED LABTEST AND BLENDING EVALUATION WORKSHEET.

**SGS****FAX MEMO**
 OFFICE : SGS - Tampa
 TEL : (813) 247-3984
 SGS FILE # : 423601
 CLIENT : Reedy Creek REF :
LABORATORY TEST RECORD**NO 1 F.O. TANK - CEP FUEL OILS**
 SAMPLE # : P 08 6 00885
 SAMPLE IDENTIFICATION : # 1 Fuel Tank; 75,000 gallon # 2 Fuel oil
 LAB # : 408-9604-0501 DATE TESTED : 4/5/96

 CRUDE OIL

 PRODUCT : No. 6 No. 2 (DIESEL) GAS OIL CAT FEED MDO

D 1298 GRAVITY, RELATIVE DENSITY 60 F/60 F	D 130 CORROSION, COPPER hr. @ F/C	
D 287 GRAVITY, API @ 60 F	D 611 ANILINE POINT, F	
D 9302 FLASH POINT, F PMCC/COC	D 323 REID VAPOR PRESSURE, psi	
D 1796/4007 SEDIMENT & WATER, Vol. %	D 189 CONRADSON CARBON RES., Wt. %	
D 473 SEDIMENT BY EXTRACTION, Wt. %	D 524 RAMSBOTTOM CARBON RES., Wt. %	
D 445 VISCOSITY @ F/C	D 4530 MICRO-CARBON RESIDUE, Wt. %	
D 445 VISCOSITY @ F/C	D 978 CETANE INDEX	
D 445 VISCOSITY @ F/C	CABOT B.M.C.I.	
D 2500 CLOUD POINT, F/C	DISTILLATION	
D 97 POUR POINT, C	<input type="checkbox"/> D 86 F	<input type="checkbox"/> D 1160 @ 760 mmHg F
D 4294 SULFUR, Wt. % <i>ppm wt</i> 0.0459	I.B.P. 70%	
D 482 ASH, Wt. %	5%	90%
D 240 GROSS BTU/LB/GAL/BBL	10%	90%
D 1500/156 COLOR, ASTM SAYBOLT	20%	95%
D 3228 NITROGEN, Wt. % < 0.015	30%	END PT.
D 2781/A/B COMPATIBILITY, SPOT #	40%	% REC.
MICROCOULOMETER	50%	% RES.
D 3220/UOP 22 / D108 CHLORIDES, INORG. ppm/Wt. %	60%	% LOSS
MICROCOULOMETER		
D 3220/420 WASHED CHLORIDES, ORG. ppm/Wt. %		
D 3230/UOP 22 SALT, LBS/1000 BBLs.		
IP 30 DOCTOR TEST	TRACE METALS (AAS), ppm Wt.	
IP 143/D3279 ASPHALTENES, Wt. %	<input type="checkbox"/> ORGANIC DILUTION	<input type="checkbox"/> WET ASHING
SMS 2696 SHELL HOT FILTRATION	ALUMINUM	MAGNESIUM
EXISTENT DRY SLUDGE, Wt. %	ARSENIC	MANGANESE
ACCELERATED DRY SLUDGE, Wt. %	CALCIUM	MERCURY
D 95/4006 WATER BY DISTILLATION, Vol. %	CADMIUM	NICKEL
D 4377 WATER BY KARL FISHER, Vol. %	CHROMIUM	POTASSIUM
	COBALT	SILICON
	COPPER	SODIUM
	IRON	VANADIUM
	LEAD	

 REPORTED TO : J. HAYNES BY :
 DATE & TIME : 4/5/96 1100 SUPERVISOR : R. Moore 4/5/96 1100

* SEE ASSOCIATED LABTEST AND BLENDING EVALUATION WORKSHEET.



LABORATORY TEST RECORD

OFFICE : SGS - Tampa
TEL : (813) 247-3984
SGS FILE # : 400625
CLIENT : Reedy Creek REF :

19-1/16/95
CEP TANK #3

FUEL OILS

SAMPLE # : P 08 6 00129
SAMPLE IDENTIFICATION : #3 CEP Fuel Oil Tank 340,689 gallons #2 Fuel Oil
LAB # : 408-9601-2001 DATE TESTED : 1/18/96

CRUDE OIL
No. 2 (DIESEL)
GAS OIL
CAT FEED
MDO

PRODUCT : No. 6 No. 2 (DIESEL) GAS OIL CAT FEED MDO

Table with 2 columns of test parameters and results. Includes items like GRAVITY, FLASH POINT, VISCOSITY, CLOUD POINT, POUR POINT, SULFUR, ASH, GROSS BTU/LB/GAL/BBL, NITROGEN, COMPATIBILITY, CHLORIDES, SALT, DOCTOR TEST, ASPHALTENES, SHELL HOT FILTRATION, WATER BY DISTILLATION, WATER BY KARL FISHER, and TRACE METALS (AAS).

REPORTED TO : J. Haynes BY :
DATE & TIME : 1/18/96 1620 SUPERVISOR : R. Moore 1/18/96 1620

* SEE ASSOCIATED LABTEST AND BLENDING EVALUATION WORKSHEET.



REEDY CREEK
IMPROVEMENT DISTRICT

P.O. BOX 10170 LAKE BUENA VISTA, FLORIDA 32830-0170 TELEPHONE (407) 828-2034

March 1, 1991

Mr. Clair H. Fancy, P.E.
Central Air Permitting
Division of Air Regulation
Florida Department of Environmental Regulation
2600 Blair Stone Road
Tallahassee, FL 32399-2400

Subject: Orange County--AC 48-137740 (AO 48-170280)
Reedy Creek Improvement District
Gas Turbine and Heat Recovery Steam Generator with
Duct Burner

Dear Mr. Fancy:

The purpose of this correspondence is to request a change in the sulfur dioxide emission limit for the above-referenced source when firing natural gas. The construction permit issued for the gas turbine plant has permitted SO₂ limits of 0.2 lb/hr and 0.8 ton per year (TPY) when firing natural gas. The operating permit has included these limits. This maximum SO₂ emission limit (i.e., 0.2 lb/hr) was based on the emission factor contained in the U.S. Environmental Protection Agency (EPA) document AP-42 (Compilation of Air Pollutant Emission Factors). The emission factor is based on an average sulfur content of natural gas of 0.2 grain/100 cubic feet (cf) of natural gas.

Initial compliance determinations using fuel analyses suggested that this limit was appropriate. However, recent fuel analyses provided by Florida Gas Transmission Company (FGT) during our compliance test period indicated a sulfur content of 0.35 gr/100 cf, which numerically exceeds the permitted amount. After further investigation and discussions with FGT, it is apparent that the sulfur content of pipeline natural gas in Florida is higher than the AP-42 emission factor and is somewhat variable. The main source of sulfur in pipeline natural gas is odorants (dimethyl sulfide and mercaptan) placed in the natural gas for safety reasons and small amounts of hydrogen sulfide. An evaluation of 8 months of data provided by FGT indicates an average sulfur content of 0.43 gr/100 cf with a maximum of 0.8 gr/100 cf (see Table 1).

FDER Permit AC48-170280
March 1, 1991
Page 2

Since Reedy Creek Improvement District has no control over the sulfur content in the pipeline natural gas (and neither does any other user), a permit modification is respectfully requested. In order to assure that future compliance determinations do not exceed a revised permit limit, we request an emission limit based on 1.2 gr/100 cf or 1.2 lb SO₂/hr (345x10⁶ Btu/hr x cf/1,024 Btu x 1.2 gr sulfur (S)/100 cf x lb/7,000 gr x 2 lb SO₂/lb S). The annual SO₂ emissions would be calculated as 5.1 TPY for 8,760 hours/yr operation which was authorized in the construction permit. The total SO₂ emissions from both natural gas and oil firing would be 25.1 TPY with this requested permit change. It should be noted that oil firing is limited to no more than 14 days per year. The annual permit limit for SO₂ is less than the Prevention of Significant Deterioration (PSD) significant emission rate of 40 TPY.

Please call if you have any questions or comments.

Sincerely,



Thomas M. Moses
District Administrator

EG/TMM/fjw

cc: Alex Alexander, P.E., FDER Central District
Charles Collins, P.E., FDER Central District
Edward Godwin, P.E., RCES
Kennard F. Kosky, P.E., KBN

TABLE I

90009A1
11/20/90Sulfur Content, Heat Content, and SO₂ Emission Factors for Natural Gas

Date	Sulfur Content (gr/100 cf)	Heat Content (Btu)	SO ₂ Emission Factor (lb/10 ⁶ Btu)	SO ₂ Emission Factor (lb/10 ⁶ cf)
2/6/90	0.30	1,031	0.00083	0.857
2/13/90	0.05	1,028	0.00014	0.143
2/20/90	0.35	1,025	0.00098	1.000
2/27/90	0.45	1,024	0.00126	1.286
3/6/90	0.45	1,025	0.00125	1.286
3/13/90	0.30	1,026	0.00084	0.857
3/20/90	0.35	1,026	0.00097	1.000
3/27/90	0.35	1,025	0.00098	1.000
4/3/90	0.60	1,026	0.00167	1.714
4/10/90	0.25	1,022	0.00070	0.714
4/17/90	0.40	1,026	0.00111	1.143
4/24/90	0.30	1,022	0.00084	0.857
5/1/90	0.40	1,020	0.00112	1.143
5/8/90	0.25	1,034	0.00069	0.714
5/15/90	0.20	1,023	0.00056	0.571
6/5/90	0.45	1,020	0.00126	1.286
6/12/90	0.40	1,018	0.00112	1.143
6/19/90	0.70	1,017	0.00197	2.000
6/26/90	0.45	1,019	0.00126	1.286
7/3/90	0.55	1,022	0.00154	1.571
7/10/90	0.35	1,022	0.00098	1.000
7/17/90	0.45	1,021	0.00126	1.286
7/30/90	0.30	1,021	0.00084	0.857
8/7/90	0.50	1,024	0.00140	1.429
8/14/90	0.45	1,022	0.00126	1.286
8/21/90	0.40	1,022	0.00112	1.143
8/28/90	0.70	1,022	0.00196	2.000
9/4/90	0.55	1,029	0.00153	1.571
9/11/90	0.40	1,025	0.00111	1.143
9/18/90	0.45	1,026	0.00125	1.286
9/25/90	0.40	1,026	0.00111	1.143
10/2/90	0.45	1,029	0.00125	1.286
10/9/90	0.45	1,025	0.00125	1.286
10/16/90	0.70	1,028	0.00195	2.000
10/28/90	0.80	1,024	0.00223	2.286
Average:	0.43	1,024	0.00119	1.216
Maximum:	0.80	1,034	0.00223	2.286
Minimum:	0.05	1,017	0.00014	0.143
Std. Dev.	0.15	4	0.00042	0.427

Source: Florida Gas Transmission Company, 1990.

DOCUMENT III.I.3

**DETAILED DESCRIPTION OF
CONTROL EQUIPMENT**

(DOCUMENT III.L.3--MARCH 1996 REVISED FORM)

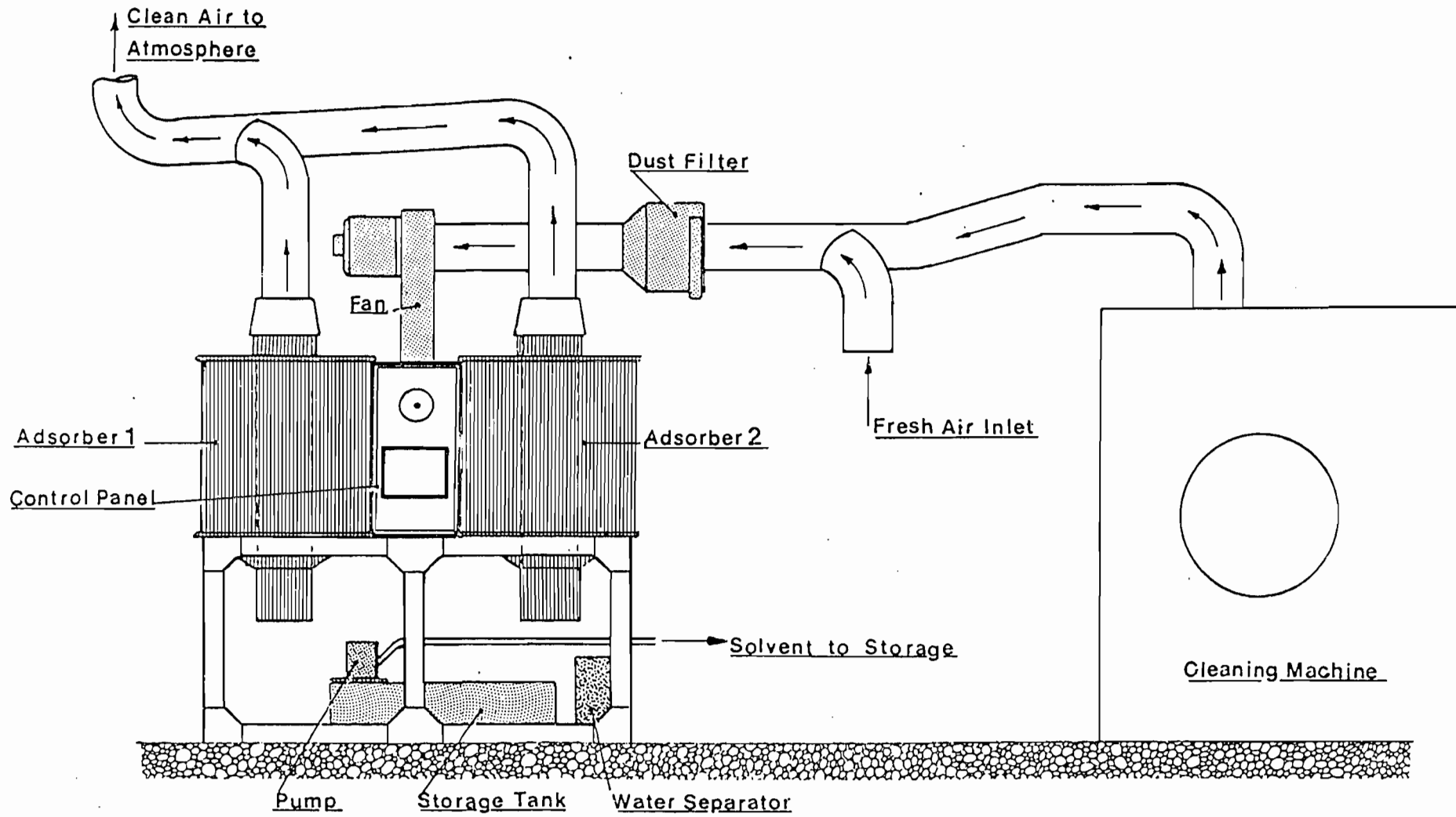

DUCTING CIRCUIT (Schematic)

**PAINT SPRAY BOOTH
(TYPICAL)**

PAINT SPRAY BOOTH SPECIFICATIONS

This is a specification for a special, enclosed paint spray booth with special weather-proofing features.

It will be fabricated by Binks Manufacturing Company in Chicago and shipped knocked-down and crated.

The booth will be constructed of 18 gauge galvanized panels, flanged on all sides with rolled edges for rigidity.

DIMENSIONS

Inside Work Dimensions: 14' wide; 10' high; 15' deep.

Overall (Footprint) Dimensions: 14'-6" wide; 13' high; 19'-2" deep.

Front Entrance Filter Doors: 5' wide; 8'-6" high.

Personnel Door: 2'-6" wide; 6'-9" high.

EXHAUST SYSTEM

The furnished exhaust system will include a 42" diameter, spark-proof fan, belt driven through a vapor-proof drive tube via a 5 HP, open-type, drip proof, ball bearing, 230/460/60, 3-phase motor.

Fan capacity will be 18,450 CFM at 1/2" SP for a calculated velocity through the empty booth of 135 FPM.

The exhaust filter media is made of special non-fire supporting paper. The filters have a Class II UL listing and comply with NFPA Code 33.

The front filter doors and panels beside the front filter doors will be provided with tight-seal air filters for inlet make-up air.

LIGHTING

The booth will be furnished with ten (10) fluorescent light fixtures for 120V service. (Bulbs not included.) Fixtures will have Class I, Div. 2 ratings for hazardous locations. Fixtures will be outside of the booth and illuminate the booth interior through wire-glass panels built into the booth ceiling.

SPECIAL WEATHER PROOFING FEATURES

The booth will be furnished with a separate 22 gauge corrugated roof, mounted just above the booth. Louvered panels will be supplied to close off the gables. Light fixtures will be furnished with louvered enclosures. Removeable louvered cover panels will be furnished for the front filter doors.

EXHAUST STACK

An exhaust stack package will be provided, consisting of:

- 1, 42" diameter x 3' length of exhaust stack with a code-required clean-out-door.
- 1, weather proof motor housing for the exhaust fan motor.
- 1, 42" diameter stack weather head with automatic, gravity dampers.
- Necessary fan connector rings.

ELECTRICAL CONTROLS/SAFETY EQUIPMENT PACKAGE

- 1, 5 HP NEMA 12 magnetic fan motor starter
- 1, Explosion proof push button station
- 2, Explosion proof light switches
- 1, Gun hook energy saving device
- 1, Manometer (Dirty filter indicator)

ITEMS NOT FURNISHED WITH THIS BOOTH

- Fire suppression equipment.
- Compressed air equipment.

**DRY-CLEANING MACHINE
CARBON ABSORPTION UNIT
(TYPICAL)**

COMPONENT IDENTIFICATION

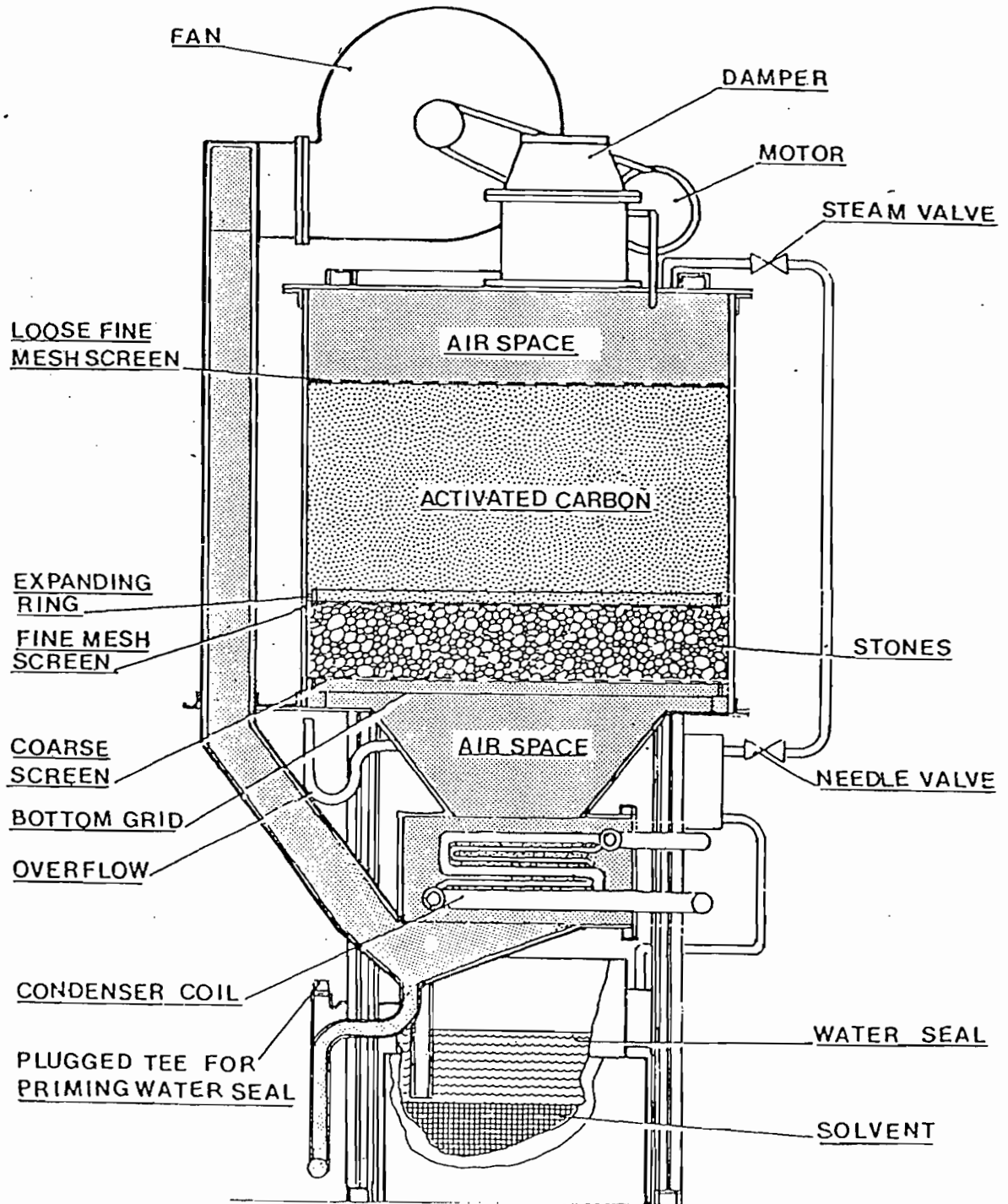

COMPONENT IDENTIFICATION

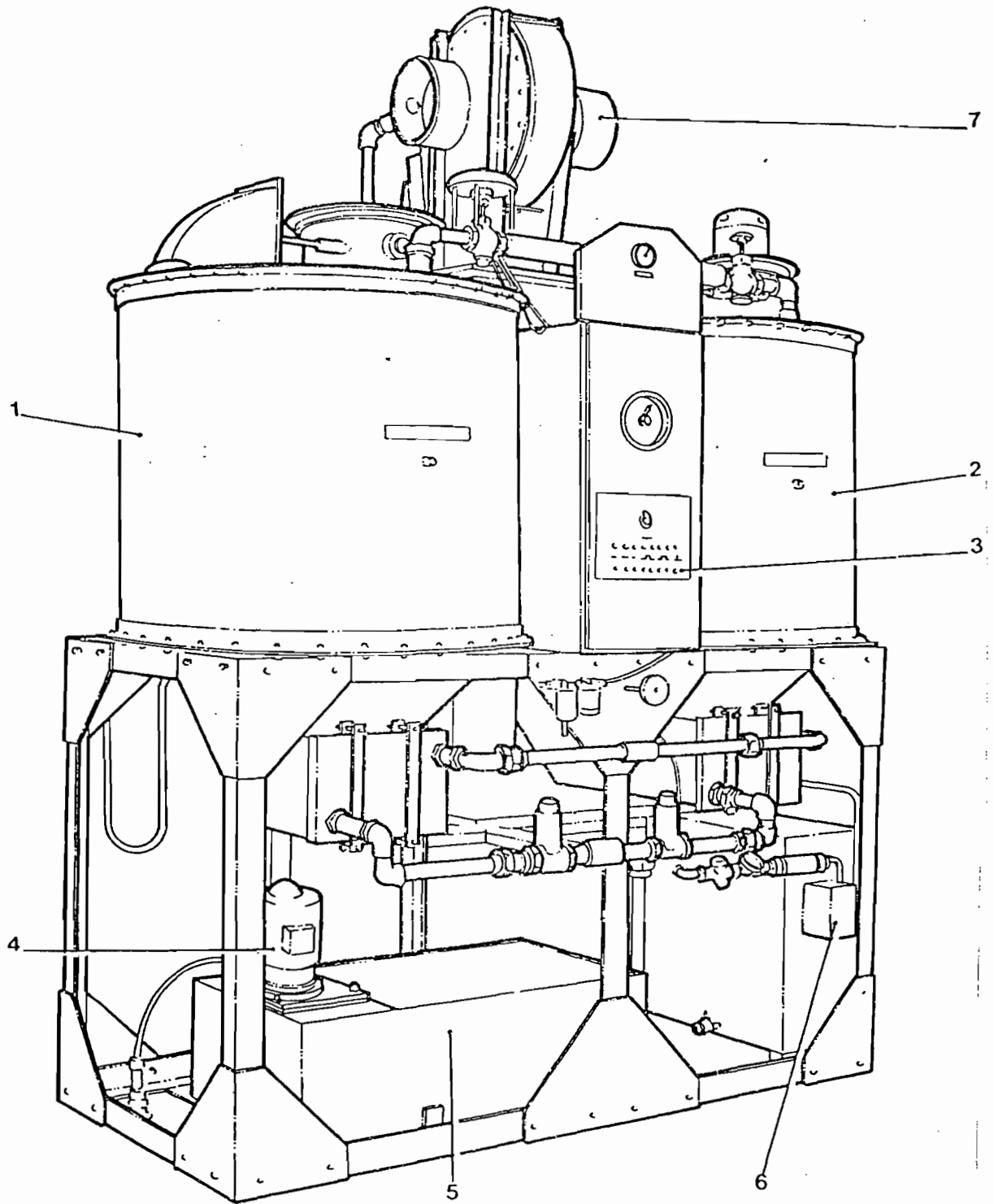

<u>Item</u>	<u>Description</u>
1	Adsorber 1
2	Adsorber 2
3	Control Panel
4	Pump
5	Storage Tank
6	Water Separator
7	Fan

DOCUMENT III.I.4

**DESCRIPTION OF STACK
SAMPLING FACILITIES**

(DOCUMENT III.L.4--MARCH 1996 REVISED FORM)

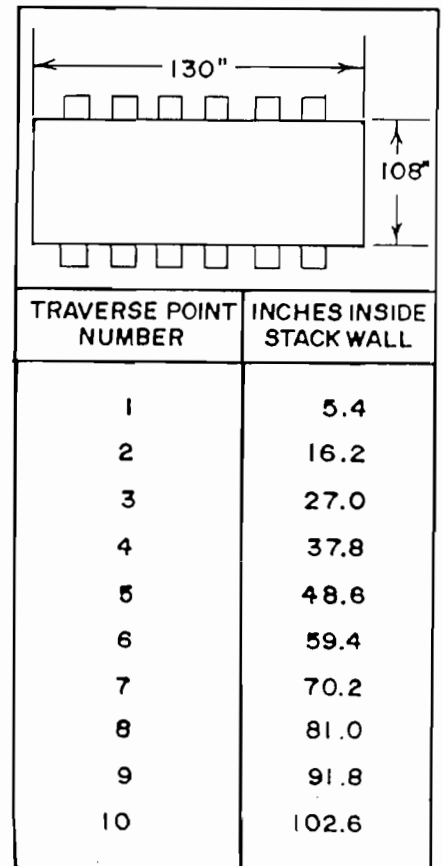
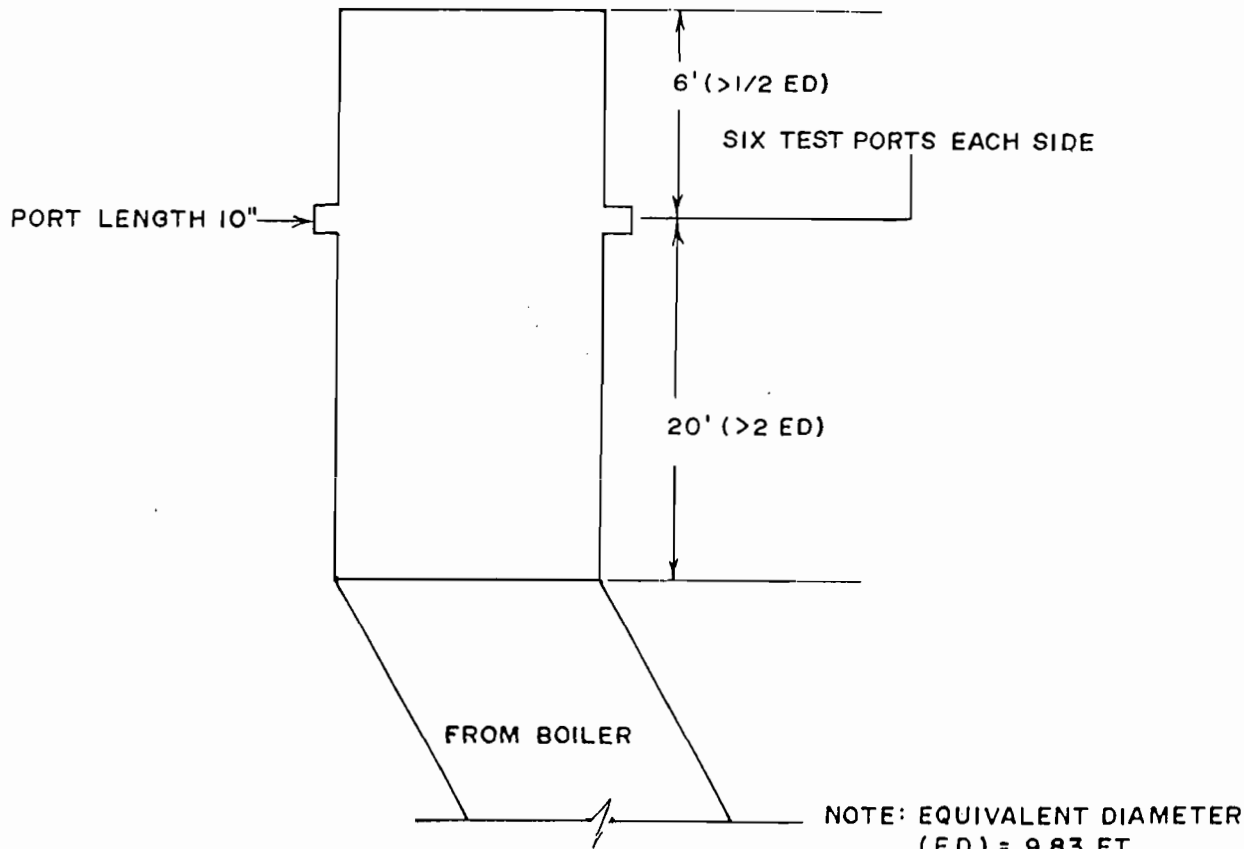

NOTE: NOT TO SCALE

FIGURE 1.
 SAMPLING POINT LOCATION
 COMBINED CYCLE GAS TURBINE EXHAUST
 REEDY CREEK IMPROVEMENT DISTRICT
 LAKE BUENA VISTA, FLORIDA

AIR CONSULTING
 and
 ENGINEERING

DOCUMENT III.I.14

**ACID RAIN APPLICATION
(DOCUMENT III.L.14--MARCH 1996 REVISED FORM)**

Department of Environmental Protection

DIVISION OF AIR RESOURCES MANAGEMENT

AIR PERMIT APPLICATION FORM ACID RAIN PART (PHASE II)

For more information, see instructions, and refer to 40 CFR 72.30 and 72.31

This submission is: New Revised Copy of

STEP 1

Identify the source by plant name, State, and ORIS code from the National Allowance Data Base (NADB).

Plant Name	State	ORIS* Code
REEDY CREEK	FL	7254

*Office of Regulatory Information Systems

STEP 2

Enter boiler ID# from NADB for each unit, and indicate whether a repowering plan is applicable by entering "yes" or "no" at column b. For new units, enter requested information in columns c and d.

a Boiler ID#	b Repowering Plan?	c New Units Commence Operation Date	d New Units Monitor Certification Deadline
CT/HRSG 1	NO	N/A	N/A

STEP 3

If you responded "yes" in column b of Step 2 for any mark the box

For each unit that will be repowered, the Repowering Extension Plan form is included and the Repowering unit, Technology Petition form has been submitted, is included, or will be submitted by June 1, 1996.

Plant Name (from Step 1)
REEDY CREEK

STEP 4

Read the **Standard Requirements and Certification**, enter the name of the designated representative, and sign and date.

Standard Requirements

Permit Requirements.

(1) The designated representative of each Acid Rain source and each Acid Rain unit at the source shall:

(a) Submit a complete Acid Rain part, including a compliance plan, under this part in accordance with the deadlines specified in Rule 62-213.420, F.A.C.; and Rule 62-214.320, F.A.C.

(b) Submit in a timely manner any supplemental information that the State determines is necessary in order to review an Acid Rain part application and issue or deny a Title V permit;

(2) The owners and operators of each Acid Rain source and each Acid Rain unit at the source shall:

(a) Operate the unit in compliance with a complete Acid Rain part application or a superseding Title V permit issued by the Department; and

(b) Have a Title V permit with an Acid Rain part.

Monitoring Requirements.

(1) The owners and operators and, to the extent applicable, designated representative of each Acid Rain source, and each Acid Rain unit at the source shall comply with the monitoring requirements as provided in 40 CFR Parts 75 and 76.

(2) The emissions measurements recorded and reported in accordance with 40 CFR Parts 75 and 76 shall be used to determine compliance by the unit with the Acid Rain emissions limitations and emissions reduction requirements for sulfur dioxide and nitrogen oxides under the Acid Rain Program.

(3) The requirements of 40 CFR Parts 75 and 76 shall not affect the responsibility of the owners and operators to monitor emissions of other pollutants or other emissions characteristics at the unit under other applicable requirements of the Act and other provisions of the operating permit for the source.

Sulfur Dioxide Requirements.

(1) The owners and operators of each Acid Rain source and each Acid Rain unit at the source shall:

(a) Hold allowances, as of the allowance transfer deadline, in the unit's compliance subaccount, after deductions by EPA under 40 CFR 73.34(c), not less than the total annual emissions of sulfur dioxide from the unit for the previous calendar year; and

(b) Comply with the applicable Acid Rain emissions limitations for sulfur dioxide.

(2) Each ton of sulfur dioxide emitted in excess of the Acid Rain emissions limitations for sulfur dioxide shall constitute a separate violation of the Act.

Plant Name (from Step 1)

REEDY CREEK

Sulfur Dioxide Requirements (Continued).

(3) An Acid Rain unit shall be subject to the requirements under Rule 62-214.330(1), F.A.C., and 40 CFR 72.9(c)(1) as follows:

(a) Starting January 1, 2000, an Acid Rain unit under 40 CFR 72.6(a)(2) that is not a substitution or compensating unit; or

(b) Starting on the later of January 1, 2000 or the deadline for monitor certification under 40 CFR Part 75, an Acid Rain Unit under 40 CFR 72.6(a)(3) that is not a substitution or compensating unit.

(4) Allowances shall be held in, deducted from, or transferred among Allowance Tracking System accounts by EPA in accordance with the Acid Rain Program.

(5) An allowance shall not be deducted in order to comply with the requirements under 40 CFR 72.9(c)(1)i prior to the calendar year for which the allowance was allocated.

(6) An allowance allocated by EPA under the Acid Rain Program is a limited authorization to emit sulfur dioxide in accordance with the Acid Rain Program. No provision of the Acid Rain Program, the Title V permit application that includes the Acid Rain Part, the Title V permit that includes the Acid Rain Part, or the written exemption under Rule 62-214.340, F.A.C., and 40 CFR 72.7 and 72.8 and no provision of law shall be construed to limit the authority of the United States to terminate or limit such authorization.

(7) An allowance allocated by EPA under the Acid Rain Program does not constitute a property right.

Nitrogen Oxides Requirements.

The owners and operators of the Acid Rain source and each Acid Rain unit at the source shall comply with the applicable Acid Rain emissions limitation for nitrogen oxides, pursuant to 40 CFR Part 76.

Excess Emissions Requirements.

(1) The designated representative of an Acid Rain unit that has excess emissions in any calendar year shall submit a proposed offset plan, as required under 40 CFR Part 77.

(2) The owners and operator of an Acid Rain unit that has excess emissions in any calendar year shall:

(a) Pay without demand the penalty required, and pay upon demand the interest on that penalty, as required by 40 CFR Part 77; and

(b) Comply with the terms of an approved offset plan, as required by 40 CFR Part 77.

Recordkeeping and Reporting Requirements.

(1) Unless otherwise provided, the owners and operators of the Acid Rain source and each Acid Rain unit at the source shall keep on-site at the source each of the following documents for a period of 5 years from the date the document is created. This period may be extended for cause in writing by EPA, at any time prior to the end of the 5 years.

Plant Name (from Step 1)

REEDY CREEK

Recordkeeping and Reporting Requirements (Continued).

(a) The certificate of representation for the designated representative for the source and each Acid Rain unit at the source and all documents that demonstrate the truth of the statements in the certificate of representation, in accordance with 40 CFR 72.24; provided that the certificate and documents shall be retained on-site at the source beyond such 5-year period until such documents are superseded because of a new certificate of representation changing the designated representative;

(b) All emissions monitoring information, in accordance with 40 CFR Part 75;

(c) Copies of all reports, compliance certifications, and other submissions and all records made or required under the Acid Rain Program; and

(d) Copies of all documents used to complete the Acid Rain Part application, and any other submission under the Acid Rain Part, or to demonstrate compliance with the Acid Rain Program.

(2) The designated representative of an Acid Rain source and each Acid Rain unit at the source shall submit the reports and compliance certifications required under the Acid Rain Program, including those under 40 CFR Part 72 subpart I and 40 CFR Part 75.

Liability.

(1) Any person who knowingly violates any requirement or prohibition of the Acid Rain Program, a complete Acid Rain Part application, a Title V permit with an Acid Rain Part, or a written exemption under Rule 62-214.340, F.A.C., or 40 CFR 72.7 or 72.8, including any requirement for the payment of any penalty owed to the United States, shall be subject to enforcement pursuant to 42 U.S.C. 7413(c).

(2) Any person who knowingly makes a false, material statement in any record, submission, or report under the Acid Rain Program shall be subject to criminal enforcement pursuant to 42 U.S.C. 7413(c) and 18 U.S.C. section 1001.

(3) No permit revision shall excuse any violation of the requirements of the Acid Rain Program that occurs prior to the date that the revision takes effect.

(4) Each Acid Rain source and each Acid Rain unit shall meet the requirements of the Acid Rain Program, including Chapter 62-214, F.A.C.

(5) Any provision of the Acid Rain Program that applies to an Acid Rain source, including a provision applicable to the designated representative of an Acid Rain source, shall also apply to the owners and operators of such source and the Acid Rain units of the source.

(6) Any provision of the Acid Rain Program that applies to an Acid Rain unit, including a provision applicable to the designated representative of an Acid Rain unit, shall also apply to the owners and operators of such unit. Except as provided under 40 CFR 72.44, Phase II repowering extension plans, and 40 CFR Part 76, and except with regard to the requirements applicable to units with a common stack under 40 CFR Part 75, including 40 CFR 75.16, 75.17, and 75.18, the owners and operators and the designated representative of one Acid Rain unit shall not be liable for any violation by any other Acid Rain unit of which they are not owners or operators or the designated representative and that is located at a source of which they are not owners or operators or the designated representative.

Plant Name (from Step 1)
REEDY CREEK

Liability (Continued).

(7) Each violation of a provision of 40 CFR Parts 72, 73, 75, 76, 77, 78, or Chapter 62-214, F.A.C., by an Acid Rain source or Acid Rain unit, or by an owner or operator or designated representative of such source or unit, shall be a separate violation of the Act.

Effect on Other Authorities.

No provision of the Acid Rain Program, an Acid Rain Part application, a Title V permit with Acid Rain Part, or a written exemption under 40 CFR 72.7 or 72.8 shall be construed as:

(1) Except as expressly provided in Title IV of the Act, exempting or excluding the owners and operators and, to the extent applicable, the designated representative of an Acid Rain source or Acid Rain unit from compliance with any other provisions of the Act, including the provisions of Title I of the Act relating to applicable National Ambient Air Quality Standards or State Implementation Plans;

(2) Limiting the number of allowances a unit can hold; **provided**, that the number of allowances held by the unit shall not affect the source's obligation to comply with any other provisions of the Act;

(3) Requiring a change of any kind in any State law regulating electric utility rates and charges, affecting any State law regarding such State regulation, or limiting such State regulation, including any prudence review requirements under such State law;

(4) Modifying the Federal Power Act or affecting the authority of the Federal Energy Regulatory Commission under the Federal Power Act; or,

(5) Interfering with or impairing any program of competitive bidding for power supply in a State in which such program is established.

Certification

I am authorized to make this submission on behalf of the owners and operators of the Acid Rain source or Acid Rain units for which the submission is made. I certify under penalty of law that I have personally examined, and am familiar with, the statements and information submitted in this document and all its attachments. Based on my inquiry of those individuals with primary responsibility for obtaining the information, I certify that the statements and information are to the best of my knowledge and belief true, accurate, and complete. I am aware that there are significant penalties for submitting false statements and information, or omitting required statements and information, including the possibility of fine or imprisonment.

Name	
Signature	Date

APPENDIX C

**CURRENT OPERATING AND CONSTRUCTION
PERMITS FOR THE
WALT DISNEY WORLD RESORT COMPLEX**



Lawton Chiles
Governor

Florida Department of Environmental Protection

Central District
3319 Maguire Boulevard, Suite 232
Orlando, Florida 32803-3767

Virginia B. Wetherell
Secretary

Permittee:

Walt Disney World Company
Post Office Box 10,000
Lake Buena Vista, Florida 32830-1000

Attention: Robert H. Penn, Director of
Environmental Affairs

Permit Number: AC49-236247
Date of Issue:
Expiration Date: November 30, 1998
County: Osceola
Latitude/Longitude:
28°21'00"N/81°34'00"W
Project: All Star Resort Boilers

This permit is issued under the provisions of Chapter(s) 403, Florida Statutes, and Florida Administrative Code Rule(s) 17-2. The above named permittee is hereby authorized to perform the work or operate the facility shown on the application and approved drawing(s), plans, and other documents attached hereto or on file with the department and made a part hereof and specifically described as follows:

The permittee may construct eighty natural gas fired boilers and hot water generators. The location, size, description, and use of each combustion unit is described in Appendix A of the application.

This source is located at 3499 West Buena Vista Drive, Kissimmee, Osceola County, Florida.

General Conditions are attached to be distributed to the permittee only.

PERMITTEE:
Walt Disney World Company

Permit Number: AC49-236247
Expiration Date: November 30, 1998

Attention: Robert H. Penn, Director of
Environmental Affairs

GENERAL CONDITIONS:

16. No objectionable odors will be allowed, as per Rule 17-296.320(2), F.A.C.
17. This permit does not preclude compliance with any applicable local permitting requirements and regulations.

SPECIFIC CONDITIONS

OPERATING CONDITIONS

1. Each combustion unit is permitted to operate continuously.
2. Each combustion unit will be fired with natural gas or propane only.
3. The maximum permitted heat input rate for the eighty combustion units, which are described in Appendix A of the application, is 925,000 MMBtu/year.

EMISSION LIMIT

4. The emission limitation for this combustion unit is set forth in Rule 17-296.406, F.A.C.

COMPLIANCE TESTING

5. Each calendar year on or before March 1, submit for each source, an Annual Operations Report DEP Form 17-210.900(4) for the preceding calendar year.

EXPIRATION DATE

6. The construction shall reasonably conform to the plans and schedule submitted in the application. If the permittee is unable to complete construction on schedule, he must notify the Department in writing 60 days prior to the expiration of the construction permit and submit a new request for an extension of the construction permit. (Rule 17-4.09 Florida Administrative Code).

The permittee must notify the Department in writing of the startup date for any source covered by this permit. This notification must be addressed to the Permitting Section and received no later than 15 days after startup.

An operating permit is required for operation of this facility. To obtain an operating permit, the permittee must demonstrate compliance with the conditions of the construction permit and submit the application fee, along with compliance test results and Certification of Completion of Construction to the Department's Central Florida District office 60 days prior to the expiration date of the construction permit.

PERMITTEE:
Walt Disney World Company

Permit Number: AC49-236247
Expiration Date: November 30, 1998

Attention: Robert H. Penn, Director of
Environmental Affairs

SPECIFIC CONDITIONS
(Continued)

This permit will expire November 30, 1998 or six months after the facility is placed in operation, whichever occurs first.

ISSUED 10-14-93

STATE OF FLORIDA DEPARTMENT
OF ENVIRONMENTAL PROTECTION

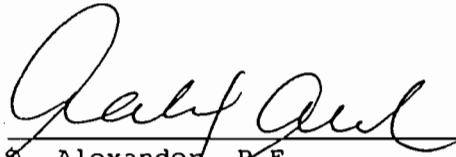
cmc 
R. Alexander, P.E.
District Director
3319 Maguire Boulevard
Suite 232
Orlando, Florida 32803



Department of Environmental Protection

Lawton Chiles
Governor

Central District
3319 Maguire Boulevard, Suite 232
Orlando, Florida 32803-3767

Virginia B. Wetherell
Secretary

Permittee:
Walt Disney World Company
Post Office Box 10,000
Lake Buena Vista, Florida 32830-1000

Attention: Bob Penn, Director,
Environmental Affairs

I.D. Number:
Permit Number: AO49-254323
Date of Issue:
Expiration Date: August 30, 1999
County: Osceola
Latitude/Longitude:
28°21'00"N/81°34'00"W
Project: All Star Resort Paint Booth

This permit is issued under the provisions of Chapter(s) 403, Florida Statutes, and Florida Administrative Code Rule(s) 62-2. The above named permittee is hereby authorized to perform the work or operate the facility shown on the application and approved drawing(s), plans, and other documents attached hereto or on file with the department and made a part hereof and specifically described as follows:

The permittee may operate a paint spray booth to spray miscellaneous parts for building maintenance at the Walt Disney World All Star Resort. The paint booth is a Binks Model PFF-12-8-T-LH equipped with paint arrestors capable of removing more than 95 percent of the particulates of less than 1 micron size.

This source is located at 3499 West Buena Vista Drive, Kissimmee, Osceola County, Florida.

General Conditions are attached to be distributed to the permittee only.

PERMITTEE:

Walt Disney World Company

Attention: Bob Penn, Director,
Environmental Affairs

I.D. Number:

Permit Number: AO49-254323

Expiration Date: August 30, 1999

County: Osceola

SPECIFIC CONDITIONS

OPERATING LIMITS

1. The maximum permitted usage rate is 2 gallons per hour of paint or primer, per the application.
2. This source is permitted to operate 16 hrs/day, 5 days/week, every week, per the application.
3. Each dry filter must be properly operated and maintained (Rule 62-210.300, F.A.C.). No person shall circumvent any pollution control device or allow the emissions of air pollutants without the applicable air pollution control device operating properly (Rule 62-210.650, F.A.C.).
4. The velocity at the paint booth filter face shall not exceed 250 ft/min.
5. Rule 62-296.320(1)(a) F.A.C. states that no person shall store, pump, handle, process, load, unload or use in any process or installation volatile organic compounds or organic solvents without applying known and existing vapor emission control devices or systems deemed necessary and ordered by the department. To comply, procedures to minimize pollutant emissions should include but shall not be limited to the following:
 - a) tightly cover or close all VOC containers when they are not in use,
 - b) tightly cover, where possible, all open troughs, basins, baths, tanks, etc. when they are not in use,
 - c) maintain all piping, valves, fittings, etc. in good operating condition,
 - d) prevent excessive air turbulence across exposed VOC's,
 - e) immediately confine and clean up VOC spills and make sure certain wastes are placed in closed containers for reuse, recycling or proper disposal, and
 - f) maintain a monthly accounting of each VOC based on beginning and ending inventories, deliveries, shipments, etc.

EMISSION LIMITS

6. The visible emissions from the source must comply with Rule 62-296.310, F.A.C. (20% opacity limit).

PERMITTEE:

Walt Disney World Company

Attention: Bob Penn, Director,
Environmental Affairs

I.D. Number:

Permit Number: AO49-254323

Expiration Date: August 30, 1999

County: Osceola

SPECIFIC CONDITIONS:

(Continued)

COMPLIANCE TESTING

7. The source must be tested for visible emissions in accordance with DEP Method 9 for a time period of thirty minutes or the length of the batch/cycle at least 90 days prior to permit expiration date.
8. The Air Resources Compliance Section of this office shall be notified in writing at least fifteen (15) days in advance of the compliance tests (Rule 62-297.340(1)(i), F.A.C.).
9. This plant is required to operate within 90 to 100 percent of permitted capacity during the compliance tests.
10. The required test report shall be filed with this office no later than 45 days after the last sampling run of each test is completed (Rule 62-297.570(2), F.A.C.).
11. Each calendar year on or before March 1, submit for each source, an Annual Operations Report DEP Form 62-210.900(4) for the preceding calendar year.

EXPIRATION DATE

12. An operation permit renewal must be submitted at least 60 days prior to the expiration date of this permit (Rule 62-4.090, F.A.C.).

STATE OF FLORIDA DEPARTMENT
OF ENVIRONMENTAL PROTECTION

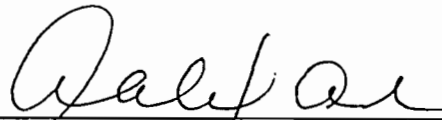

A. Alexander, P.E.
District Director

ISSUED

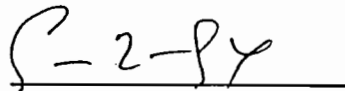

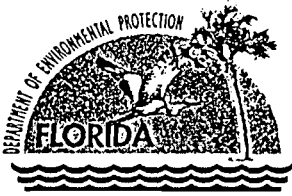

Department of Environmental Protection

Lawton Chiles
Governor

Central District
3319 Maguire Boulevard, Suite 232
Orlando, Florida 32803-3767

Virginia B. Wetherell
Secretary

Permittee:

Walt Disney World Company
Post Office Box 10,000
Lake Buena Vista, Florida 32830-1000

Attention: William A. O'Toole,
Senior Vice President

Permit Number: AC48-264605
Date of Issue: 3/28/95
Expiration Date: February 28, 2000
County: Orange
Latitude/Longitude:
28°22'08"N/81°30'48"W
UTM: 17-449.7 KmE; 3138.0 KmN
Project: Two Boilers and Three Hot
Water Generators (Blizzard
Beach)

This permit is issued under the provisions of Chapter(s) 403, Florida Statutes, and Florida Administrative Code Rule(s) 62-210. The above named permittee is hereby authorized to perform the work or operate the facility shown on the application and approved drawing(s), plans, and other documents attached hereto or on file with the department and made a part hereof and specifically described as follows:

The permittee can construct two steam boilers and three hot water generators, described as follows:

- a) Steam Boiler BB-1 manufactured by Ajax Boiler, Incorporated, Model WG-1375.
- b) Steam Boiler BB-2 manufactured by Ajax Boiler, Incorporated, Model WG-1375.
- c) Hot Water Generator BB-3 manufactured by Ajax Boiler, Incorporated, Model XGF-6500-W.
- d) Hot Water Generator BB-4 manufactured by Ajax Boiler, Incorporated, Model XGF-6500-W.
- e) Hot Water Generator BB-5 manufactured by Ajax Boiler, Incorporated, Model XGF-1500-W.

These emission units are located at the Blizzard Beach Complex at 1375 Buena Vista Drive, Lake Buena Vista, Orange County, Florida.

General Conditions are attached to be distributed to the permittee only.

PERMITTEE:

Walt Disney World Company

Attention: William A. O'Toole,
Senior Vice President

I.D. Number:

Permit Number: AC48-264605

Expiration Date: February 28, 2000

County: Orange

SPECIFIC CONDITIONS:

OPERATING CONDITIONS

1. Each emission unit is permitted to operate continuously, per the application.
2. Each emission unit will be fired with natural gas only, per the application.
3. The maximum permitted heat input rates are as follows, per the application:

a) BB-1	1.38 MMBTU/hour
b) BB-2	1.38 MMBTU/hour
c) BB-3	6.5 MMBTU/hour
d) BB-4	6.5 MMBTU/hour
e) BB-5	1.5 MMBTU/hour

EMISSION LIMITS

4. The visible emissions from the three hot water generators must comply with Rule 62-296.310(2), F.A.C. (limited to less than 20% opacity).
5. The visible emissions limitation from the two steam boilers shall comply with Rule 62-296.406(1), F.A.C. (up to 20% opacity, except for one 2-minute period per hour during which opacity shall not exceed 40%).

BACT Determined by DEP:

6. The amount of particulate and sulfur dioxide emissions from the two steam boilers shall be limited by the firing of natural gas only [Rule 62-296.406(2)&(3), F.A.C.].

COMPLIANCE TESTING

7. Each emission unit must be tested for visible emissions in accordance with DEP Method 9 [Rule 62-297.401, F.A.C.] within thirty days after being placed in operation. The DEP Method 9 test shall consist of a thirty minute visible emissions test for each hot water generator and a sixty minute visible emission test for each steam boiler.
8. At least 15 days prior to the date on which each formal compliance test is due to begin, the permittee shall provide written notification of the test to the Air Compliance Section of this office. The notification must include the following information: the date, time and location of each test; the name and telephone number of the facility's contact person who will be responsible for coordinating the test; and the name, company, and telephone number of the person conducting the test [Rule 62-297.340(1)(i), F.A.C.].

PERMITTEE:

Walt Disney World Company

I.D. Number:

Permit Number: AC48-264605

Attention: William A. O'Toole,
Senior Vice President

Expiration Date: February 28, 2000
County: Orange

SPECIFIC CONDITIONS

(Continued)

9. Testing of emissions shall be conducted with the emissions unit operation at permitted capacity. Permitted capacity is defined as 90 to 100 percent of the maximum operation rate allowed by the permit. If it is impractical to test at permitted capacity, an emissions unit may be tested at less than the minimum permitted capacity; in this case, subsequent emissions unit operation is limited to 110 percent of the test load until a new test is conducted. Once the unit is so limited, operation at higher capacities is allowed for no more than 15 consecutive days for the purpose of additional compliance testing to regain the authority to operate at the permitted capacity [Rule 62-297.310(2), F.A.C.].
10. The type of fuel and the heat input to each emission unit must be entered on the visible emission test report.
11. Reports of the required compliance tests shall be filed with the Air Compliance Section of this office as soon as practical but no later than 45 days after the last test is completed [Rule 62-297.570(2), F.A.C.].
12. A DEP Form No. 62-210.900(5), F.A.C. "Annual Operating Report for Air Pollutant Emitting Facility", including the Emissions Report, shall be completed for each calendar year and submitted to this office on or before March 1 of the following year [Rule 62-210.370(3), F.A.C.].

EXPIRATION DATE

13. The construction shall reasonably conform to the plans and schedule submitted in the application. If the permittee is unable to complete construction on schedule, he must notify the Department in writing 60 days prior to the expiration of the construction permit and submit a new request for an extension of the construction permit (Rule 62-4.09, Florida Administrative Code).

The permittee must notify the Department in writing of the startup date for any source covered by this permit. This notification must be addressed to the Permitting Section and received no later than 15 days after startup.

An operating permit is required for operation of this source. To obtain an operating permit, the permittee must demonstrate compliance with the conditions of the construction permit and submit the application fee, along with compliance test results and Application for Air Permit to the Department's Central Florida District office no later than 60 days prior to the expiration date of the construction permit.

This permit will expire February 28, 2000 or six months after being placed in operation, whichever comes first.

PERMITTEE:
Walt Disney World Company

Attention: William A. O'Toole,
Senior Vice President

I.D. Number:
Permit Number: AC48-264605
Expiration Date: February 28, 2000
County: Orange

SPECIFIC CONDITIONS:
(Continued)

STATE OF FLORIDA DEPARTMENT
OF ENVIRONMENTAL PROTECTION

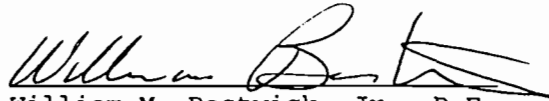
cmc 
William M. Bostwick, Jr., P.E.
Acting District Director

ISSUED 3/28/95

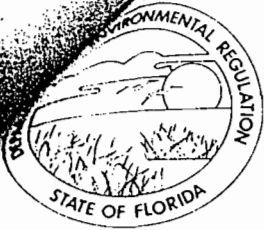

Florida Department of Environmental Regulation

Central District • 3319 Maguire Boulevard, Suite 232 • Orlando, Florida 32803-3767 • 407-894-7555

Bob Martinez, Governor

Dale Twachtmann, Secretary

John Shearer, Assistant Secretary
Alex Alexander, Deputy Assistant Secretary

Permittee:

Walt Disney World Company
Post Office Box 10,000
Lake Buena Vista, Florida 32830

Attention: Neil Gallagher, Vice President
Buena Vista Construction

I. D. Number:

Permit/Certification
Number: A048-169552
Date of Issue:
Expiration Date: 11/15/94
County: Orange
Latitude/Longitude:
28°23'43"N/81°32'08"W
UTM: 17-447.7 KmE; 3140.9 KmN
Project: Buena Vista Construction
Paint Spray Booth (WDW26)

This permit is issued under the provisions of Chapter(s) 403, Florida Statutes, and Florida Administrative Code Rule(s) 17-2. The above named permittee is hereby authorized to perform the work or operate the facility shown on the application and approved drawing(s), plans, and other documents attached hereto or on file with the department and made a part hereof and specifically described as follows:

The permittee can operate Buena Vista Construction Paint Spray Booth (WDW 26) which is a DeVilbiss Model DF equipped with Andreae Paint Arrestors to control Particulate Matter (PM) emissions.

This source is located at 2791 Wedway Drive, Lake Buena Vista, Orange County, Florida.

General Conditions are attached to be distributed to the permittee only.

PERMITTEE:
Walt Disney World Company

Attention: Neil Gallagher, Vice President
Buena Vista Construction

I. D. Number:
Permit/Certification Number:
A048-169552
Date of Issue:
Expiration Date: 11/15/94

SPECIFIC CONDITIONS:

1. No objectionable odors will be allowed, as per Rule 17-2.620(2), F.A.C.
2. There shall be no discharges of liquid effluents or contaminated runoff to surface or ground water without prior approval from this office.
3. All unconfined emissions of particulate matter generated at this site shall be adequately controlled. (Rule 17-2.610(3), F.A.C.) Area must be watered down should unconfined emissions occur.
4. This permit does not preclude compliance with any applicable local permitting requirements and regulations.
5. This source is permitted to operate 4160 hours/year.
6. The permitted materials and utilization rates are as stated in the application except that these rates shall not cause the VOC emission rate to exceed the limit specified by specific condition No. 8.
7. The maximum permitted Volatile Organic Compound (VOC) emission rate is 7.73 tons/year.
8. To comply with RACT Rule 17-2.650(1)(c) F.A.C., the maximum permitted emission rate of VOC is 3 pounds per hour and 15 pounds per day from each source when painting miscellaneous metal parts and products with coatings which exceed the limits of Rule 17-2.650(1)(f)14, F.A.C. Should either of these VOC emission rates be exceeded under the specified circumstances, these sources may be subject to specific VOC emission limiting standards of RACT Rule 17-2.650(1)(f)14.b., F.A.C. and to control technology of RACT Rule 17-2.650(1)(f)14.c., F.A.C. Any exceedances of these rates shall be reported to the department immediately.
9. Rule 17-2.620(1)(a)FAC states that no person shall store, pump, handle, process, load, unload or use in any process or installation volatile organic compounds or organic solvents without applying known and existing vapor emission control devices or systems deemed necessary and ordered by the department. To comply, procedures to minimize pollutant emissions should include but shall not be limited to the following:
 - (a) tightly cover or close all VOC containers when they are not in use,
 - (b) tightly cover, where possible, all open troughs, basins, baths, tanks, etc. when they are not in use,

PERMITTEE:
Walt Disney World Company

Attention: Neil Gallagher, Vice President
Buena Vista Construction

I. D. Number:
Permit/Certification Number:
A048-169552
Date of Issue:
Expiration Date: 11/15/94

SPECIFIC CONDITIONS:

- (c) maintain all piping, valves, fittings, etc. in good operating condition,
 - (d) prevent excessive air turbulence across exposed VOC's,
 - (e) immediately confine and clean up VOC spills and make sure certain wastes are placed in closed containers for reuse, recycling or proper disposal, and
 - (f) maintain a monthly accounting of each VOC based on beginning and ending inventories, deliveries, shipments, etc.
10. The visible emissions for this Paint Spray Booth must comply with Rule 17-2.610(2)F.A.C. and the compliance test must be conducted in accordance with Rule 17-2.700(6)(b)9, (DER Method #9) F.A.C. at least 90 days prior to permit expiration date.
 11. The Paint Spray Booth should be properly operated and maintained (Rule 17-2.210(2) F.A.C.). No person shall circumvent any pollution control device or allow the emissions of air pollutants without the applicable air pollution control device operating properly (Rule 17-2.240 F.A.C.).
 12. Visible emissions are not expected to exceed 5 percent opacity from a properly maintained and operated Paint Spray Booth equipped with Paint Arrestors.
 13. This office (Florida Department of Environmental Regulation, Air Permitting, Orlando) shall be notified at least fifteen (15) days in advance of the compliance tests so that we can witness them (Rule 17-2.700(2)(a)5, F.A.C.).
 14. This plant is required to operate at 100 percent of permitted capacity during the compliance tests.
 15. The required test report shall be filed with the department as soon as practical but no later than 45 days after the last sampling run of each test is completed (Rule 17-2.700(7)(a),(b) and (c), F.A.C).
 16. Hazardous wastes generated in connection with any of the sources at this facility must be disposed of in accordance with Rule 17-30, F.A.C.
 17. Air velocity at the Paint Booth Filter Face shall not exceed 250 ft/min.

Disney World Compar
Attention: Neil Gallagher, Vice President
Buena Vista Construction

I. D. Number:
Permit/Certification Number:
A048-169552
Date of Issue:
Expiration Date: 11/15/94

SPECIFIC CONDITIONS:

- 18. Emissions within ~~the~~ building are not subject to regulation by this department, but ~~for~~ safety and health reasons, OSHA standards should be observed. Hexamethylene Diisocyanate emissions from the building should not cause ambient ~~air~~ concentrations to exceed the Acceptable Ambient Concentration (AAC) ~~at~~ ground level of 0.15 mg/m³, based on 80 hours/week of operation.
- 19. Emissions within ~~the~~ building are not subject to regulation by this department, but ~~for~~ safety and health reasons, OSHA standards should be observed. Toluene emissions from the building should not cause ambient air concentrations ~~to~~ exceed the Acceptable Ambient Concentration (AAC) at ground level of 3.75 mg/m³, based on 80 hour/week of operation.
- 20. Each calendar year ~~on~~ or before March 1, submit for each source, an Annual Operations Report ~~on~~ Form 17-1.202(6) for the preceding calendar year in accordance with Rule 17-4.14, F.A.C.
- 21. An operation permit renewal must be submitted at least 60 days prior to the expiration date ~~of~~ this permit (Rule 17-4.09, F.A.C.).

ISSUED 11-17-88

STATE OF FLORIDA DEPARTMENT
OF ENVIRONMENTAL REGULATION

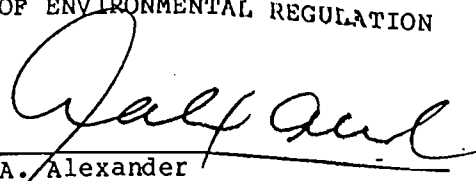
cma

A. Alexander
Deputy Assistant Secretary
3319 Maguire Boulevard
Suite 232
Orlando, Florida 32803
(407) 894-7555

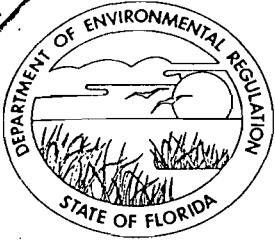

Florida Department of Environmental Regulation

Central District • 3319 Maguire Boulevard, Suite 232 • Orlando, Florida 32803-3767 • 407-894-7555

Bob Martinez, Governor

Dale Twachtmann, Secretary

John Shearer, Assistant Secretary
Alex Alexander, Deputy Assistant Secretary

Permittee:

Walt Disney World Company
Post Office Box 10,000
Lake Buena Vista, Florida 32830

Attention: Cecil W. Robinson
Director Parks Maintenance

I. D. Number:

Permit/Certification
Number: AO48-175837
Date of Issue:
Expiration Date: March 25, 1995
County: Orange
Latitude/Longitude:
28°22'12"N/81°30'44"W
UTM: 17-446.6 KmE; 3138.1 KmN
Project: EPCOT Paint Spray Booth
No. 1 (WDW24) and No. 2
(WDW25)-EPCOT Center

This permit is issued under the provisions of Chapter(s) 403, Florida Statutes, and Florida Administrative Code Rule(s) 17-2. The above named permittee is hereby authorized to perform the work or operate the facility shown on the application and approved drawing(s), plans, and other documents attached hereto or on file with the department and made a part hereof and specifically described as follows:

The permittee can operate EPCOT Paint Spray Booth No.1 (WDW 24) and No. 2 (WDW25) which are Binks Model SSF-531 and Model PBF-6-T respectively. Each booth is equipped with Andraea Paint Arrestors to control Particulate Matter (PM) emissions.

These sources are located at Avenue of the Stars at EPCOT Center, Orange County, Florida.

General Conditions are attached to be distributed to the permittee only.

PERMITTEE:
Walt Disney World Company

Attention: Cecil W. Robinson
Director Parks Maintenance

I. D. Number:
Permit/Certification Number:
AO48-175837
Date of Issue:
Expiration Date: March 25, 1995

GENERAL CONDITIONS:

16. No objectionable odors will be allowed, as per Rule 17-2.620(2), F.A.C.
17. There shall be no discharges of liquid effluents or contaminated runoff to surface or ground water without prior approval from this office.
18. All unconfined emissions of particulate matter generated at this site shall be adequately controlled. (Rule 17-2.610(3), F.A.C.) Area must be watered down should unconfined emissions occur.
19. This permit does not preclude compliance with any applicable local permitting requirements and regulations.

SPECIFIC CONDITIONS:

OPERATING LIMITS

1. Each source is permitted to operate 4160 hours/year.
2. The permitted materials and utilization rates are as stated in the applications.
3. Hazardous wastes generated in connection with any of the sources at this facility must be disposed of in accordance with Rule 17-30, F.A.C.
4. Air velocity at the Paint Booth Filter Face shall not exceed 250 ft/min.
5. Each Paint Spray Booth should be properly operated and maintained (Rule 17-2.210(2) F.A.C.). No person shall circumvent any pollution control device or allow the emissions of air pollutants without the applicable air pollution control device operating properly (Rule 17-2.240 F.A.C.).

EMISSION LIMITS

6. The maximum permitted Volatile Organic Compound (VOC) emission rates are 11.4 tons/year for WDW24 and 0.06 tons/year for WDW25.

PERMITTEE:
Walt Disney World Company

Attention: Cecil W. Robinson
Director Parks Maintenance

I. D. Number:
Permit/Certification Number:
AO48-175837
Date of Issue:
Expiration Date: March 25, 1995

7. Rule 17-2.620(1)(a)FAC states that no person shall store, pump, handle, process, load, unload or use in any process or installation volatile organic compounds or organic solvents without applying known and existing vapor emission control devices or systems deemed necessary and ordered by the department. To comply, procedures to minimize pollutant emissions should include but shall not be limited to the following:
- a) tightly cover or close all VOC containers when they are not in use,
 - b) tightly cover, where possible, all open troughs, basins, baths, tanks, etc. when they are not in use,
 - c) maintain all piping, valves, fittings, etc. in good operating condition,
 - d) prevent excessive air turbulence across exposed VOC's,
 - e) immediately confine and clean up VOC spills and make sure certain wastes are placed in closed containers for reuse, recycling or proper disposal, and
 - f) maintain a monthly accounting of each VOC based on beginning and ending inventories, deliveries, shipments, etc. for each source.
8. The visible emissions for each source must comply with Rule 17-2.610(2) F.A.C. and the compliance test must be conducted in accordance with Rule 17-2.700(6)(b)9, (DER Method #9) F.A.C.
9. Visible emissions are not expected to exceed 5 percent opacity from a properly maintained and operated Paint Spray Booth equipped with Paint Arrestors.
10. Emissions within the building are not subject to regulation by this department, but for safety and health reasons, OSHA standards should be observed. Toluene emissions from the building shall not cause ambient air concentrations to exceed the Acceptable Ambient Concentration (AAC) at ground level of 3.75 mg/m^3 . Proof of compliance with this condition can be demonstrated by the professional engineer's calculations based on actual conditions.

COMPLIANCE TESTING

11. This source must be tested for visible emissions in accordance with DER Method 9 at least ninety (90) days prior to permit expiration date.

PERMITTEE:
Walt Disney World Company

Attention: Cecil W. Robinson
Director Parks Maintenance

I. D. Number:
Permit/Certification Number:
A048-175837
Date of Issue:
Expiration Date: March 25, 1995

12. This office (Florida Department of Environmental Regulation, Air Permitting, Orlando) shall be notified at least fifteen (15) days in advance of the compliance tests so that we can witness them (Rule 17-2.700(2)(a)5, F.A.C.).
13. This plant is required to operate within 90 to 100 percent of permitted capacity during the compliance tests.
14. The required test report shall be filed with the department as soon as practical but no later than 45 days after the last sampling run of each test is completed (Rule 17-2.700(7)(a),(b) and (c), F.A.C.).

REPORTS

15. Each calendar year on or before March 1, submit for each source, an Annual Operations Report DER Form 17-1.202(6) for the preceding calendar year in accordance with Rule 17-4.14, F.A.C.

EXPIRATION DATE

16. An operation permit renewal must be submitted at least 60 days prior to the expiration date of this permit (Rule 17-4.09, F.A.C.).

ISSUED 4-2-90

STATE OF FLORIDA DEPARTMENT
OF ENVIRONMENTAL REGULATION

cmc 

A. Alexander
Deputy Assistant Secretary
3319 Maguire Boulevard
Suite 232
Orlando, Florida 32803
(407) 894-7555

Florida Department of Environmental Regulation

Central District • 3319 Maguire Boulevard, Suite 232 • Orlando, Florida 32803-3767

Lawton Chiles, Governor

Carol M. Browner, Secretary



Walt Disney World
Post Office Box 10,000
Lake Buena Vista, Florida 32830-1000

Attention: Cecil W. Robinson, Director, Parks Maintenance

Orange County - AP
EPCOT Paint Spray Booths
No. 1 (WDW 24) and No. 2 (WDW 25)
Permits No. AC48-151507 and A048-175837
Change of Conditions

Dear Mr. Robinson:

We are in receipt of a request for change of the permit conditions. The conditions are changed as follows:

<u>Condition</u>	<u>From</u>
Permit AC48-151507 Specific Condition No. 7	7. The maximum permitted Volatile Organic Compound (VOC) emission rates are 11.4 tons/year for WDW24 and 0.06 tons/year for WDW25.

To

7. The maximum permitted Volatile Organic Compound (VOC) emission rates total 11.46 tons/year from both sources.

<u>Condition</u>	<u>From</u>
Permit A048-175837 Specific Condition No. 6	6. The maximum permitted Volatile Organic Compound (VOC) emission rates are 11.4 tons/year for WDW24 and 0.06 tons/year for WDW25.

To

6. The maximum permitted Volatile Organic Compound (VOC) emission rates total 11.46 tons/year from both sources.

Walt Disney World
Permits No. A048-151507 and A048-175837
Change of Conditions
Mr. Cecil W. Robinson
Page Two

All other conditions remain the same.

This letter must be attached to your permit and becomes a part of that permit.

Sincerely,

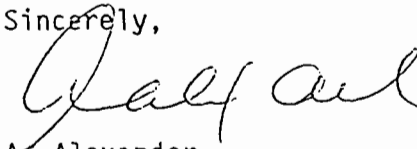
c.m.c. 

A. Alexander
District Director

Date 7-12-81

AB
AA/jtt 

Copies furnished to:

Florida Department of Environmental Regulation

Central District • 3319 Maguire Boulevard, Suite 232 • Orlando, Florida 32803-3767

Lawton Chiles, Governor

Carol M. Browner, Secretary

Permittee:
Walt Disney World
Post Office Box 10,000
Lake Buena Vista, FL 32830-1000

Attention: Robert H. Penn, Director,
Environmental Affairs

I. D. Number:
Permit/Certification
Number: A048-192123
Date of Issue: 5/22/91
Expiration Date: April 25, 1996
County: Orange
Latitude/Longitude:
28°24'05"N/81°35'12"W
UTM: 17-443.5 KmE; 3144.2 KmN
Project: EPCOT Marina Paint Spray
Booth (WDW-33)

This permit is issued under the provisions of Chapter(s) 403, Florida Statutes, and Florida Administrative Code Rule(s) 17-2. The above named permittee is hereby authorized to perform the work or operate the facility shown on the application and approved drawing(s), plans, and other documents attached hereto or on file with the department and made a part hereof and specifically described as follows:

The permittee can operate the EPCOT Marina Paint Spray Booth (WDW-33) equipped with Binks Model 29-893 filters to control particulate emissions. Three exhaust stacks will be connected to a manifold which will be attached to 2 filter banks consisting of a total of 124 filters 2 feet x 2 feet each. The total material usage at this booth will be 300 gallons per year.

This source is located at the EPCOT Marina, part of the Disney complex in Orange County, Florida.

General Conditions are attached to be distributed to the permittee only.

PERMITTEE:
Walt Disney World

Attention: Robert H. Penn, Director
Environmental Affairs

I. D. Number:
Permit/Certification Number:
A048-192123
Date of Issue:
Expiration Date: April 25, 1996

GENERAL CONDITIONS:

- 16. No objectionable odors will be allowed, as per Rule 17-2.620(2), F.A.C.
- 17. This permit does not preclude compliance with any applicable local permitting requirements and regulations.

SPECIFIC CONDITIONS:

OPERATING CONDITIONS

- 1. This source is allowed to operate no more than 3120 hours/year, (12 hours/day, 5 days/week, and 52 weeks year).
- 2. The maximum aggregate total material utilization rate of paint, thinners, and cleanup solvents shall neither exceed 30 gallons per month nor 300 gallons per year.

EMISSION LIMITS

- 3. The maximum allowable emissions shall not exceed:

Pollutant	Emissions		
	lb/hr	lb/month	TPY
PM/PM ₁₀	0.05	14.0	0.08
VOC	----	166.0	0.93

Visible Emissions shall not exceed 20% opacity. Under normal operations, no visible emissions are expected.

- 4. Rule 17-2.620(1)(a)FAC states that no person shall store, pump, handle, process, load, unload or use in any process or installation volatile organic compounds or organic solvents without applying known and existing vapor emission control devices or systems deemed necessary and ordered by the department. To comply, procedures to minimize pollutant emissions should include but shall not be limited to the following:
 - a) tightly cover or close all VOC containers when they are not in use,
 - b) tightly cover, where possible, all open troughs, basins, baths, tanks, etc. when they are not in use,

PERMITTEE:
Walt Disney World

Attention: Robert H. Penn, Director
Environmental Affairs

I. D. Number:
Permit/Certification Number:
A048-192123
Date of Issue:
Expiration Date: April 25, 1996

SPECIFIC CONDITIONS:
(Continued)

- c) maintain all piping, valves, fittings, etc. in good operating condition,
- d) prevent excessive air turbulence across exposed VOC's,
- e) immediately confine and clean up VOC spills and make sure certain wastes are placed in closed containers for reuse, recycling or proper disposal, and
- f) maintain a monthly accounting of each VOC based on beginning and ending inventories, deliveries, shipments, etc.

COMPLIANCE TESTING

- 5. Annual compliance tests to show compliance with the emission limits in Specific Condition 3 shall be conducted in accordance with the July 1, 1988, version of 40 CFR 60, Appendix A, using:
 - a. EPA Method 9 for visible emissions.
 - b. EPA Method 24 for VOC, or manufacturers specifications and material balance (using information from Specific Condition 4.f. on inventory).

Particulate compliance tests using EPA Method 5 may be required by the Department if warranted by VE test results.

- 6. The source shall be tested at yearly intervals from the date of January 29, 1991.
- 7. The monthly emission limit is based on a calendar month (a maximum of 31 days). The annual emission limit is based on 3120 hours/year of operation and 300 gallons of coating, thinners, and cleanup solvent usage. Compliance with the monthly emission limits shall be demonstrated using the monthly material inventory data, while compliance with the annual emission limits shall be demonstrated using a 12-month rolling basis, based on the inventory data.

PERMITTEE:
Walt Disney World

Attention: Robert H. Penn, Director
Environmental Affairs

I. D. Number:
Permit/Certification Number:
A048-192123
Date of Issue:
Expiration Date: April 25, 1996

SPECIFIC CONDITIONS:
(Continued)

8. This office (Florida Department of Environmental Regulation, Air Permitting, Orlando) shall be notified in writing at least fifteen (15) days in advance of the compliance tests so that we can witness them (Rule 17-2.700(2)(a)5, F.A.C.).
9. This plant is required to operate within 90 to 100 percent of permitted capacity during the compliance tests.
10. The required test report shall be filed with the department as soon as practical but no later than 45 days after the last sampling run of each test is completed (Rule 17-2.700(7)(a),(b) and (c), F.A.C.).

EXPIRATION DATE

11. An operation permit renewal must be submitted at least 60 days prior to the expiration date of this permit (Rule 17-4.09, F.A.C.).

ISSUED MAY 22, 1991

STATE OF FLORIDA DEPARTMENT
OF ENVIRONMENTAL REGULATION

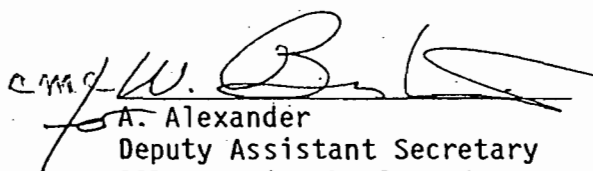
A. Alexander
Deputy Assistant Secretary
3319 Maguire Boulevard
Suite 232
Orlando, Florida 32803



Florida Department of Environmental Regulation

Central District • 3319 Maguire Boulevard, Suite 232 • Orlando, Florida 32803-3767

Lawton Chiles, Governor

Carol M. Browner, Secretary

Permittee:
Reedy Creek Improvement District
Post Office Box 40
Lake Buena Vista, FL 32830

Attention: Thomas M. Moses
District Administrator

I. D. Number:
Permit/Certification
Number: A048-196703
Date of Issue:
Expiration Date: August 25, 1996
County: Orange
Latitude/Longitude:
28°22'30"N/81°32'30"W
UTM: 17-446.5 KmE; 3138.6 KmN
Project: EPCOT Center Diesel
Generator No. 1 and 2

This permit is issued under the provisions of Chapter(s) 403, Florida Statutes, and Florida Administrative Code Rule(s) 17-2. The above named permittee is hereby authorized to perform the work or operate the facility shown on the application and approved drawing(s), plans, and other documents attached hereto or on file with the department and made a part hereof and specifically described as follows:

The permittee can operate EPCOT Center Diesel Generators No. 1 and 2. Each Diesel Generator is a 3,600 horsepower Stewart and Stevenson large bore diesel engine, Model S-20-645-E4B, equipped with a 2.5 megawatt generator, Model TBGZHJ. Each generator provides peak demand reduction and emergency standby power.

These sources are located at 751 Backstage Lane, Walt Disney World, Orange County, Florida.

General Conditions are attached to be distributed to the permittee only.

PERMITTEE:
Reedy Creek Improvement District

Attention: Thomas M. Moses
District Administrator

I. D. Number:
Permit/Certification Number:
A048-196703
Date of Issue:
Expiration Date: August 25, 1996

GENERAL CONDITIONS:

16. No objectionable odors will be allowed, as per Rule 17-2.620(2), F.A.C.
17. This permit does not preclude compliance with any applicable local permitting requirements and regulations.

SPECIFIC CONDITIONS:

OPERATING LIMITS

1. Each source is permitted to operate 1900 hours/year.
2. Each source will be fired with No. 2 Fuel Oil only.
3. Sulfur content of the No. 2 Fuel Oil shall not exceed 0.50 percent. The Number 2 Fuel Oil shall be analyzed each time fuel is transferred to the storage tank from another source using ASTM D219 or another method approved by the Department. The analysis shall be retained and submitted to the Central District upon request.

EMISSION LIMITS

4. Emission rates of each Generator shall not exceed the following:

<u>Pollutant</u>	<u>Max. Allowable Rate (lb/hr)</u>	<u>Actual Emissions (tons/year)</u>
Particulate Matter	10.0	9.5
Sulfur Dioxide	14.5	14.0
Nitrogen Oxides	126.0	119.5
Carbon Monoxide	3.0	2.85
Volatile Organic Compounds	1.0	2.0

5. These sources will be subject to all the provisions of NSPS, Subpart FF, 40 CFR 60, when this subpart is promulgated.
6. Visible emissions shall not exceed 20 percent opacity.

PERMITTEE:
Reedy Creek Improvement District

Attention: Thomas M. Moses
District Administrator

I. D. Number:
Permit/Certification Number:
A048-196703
Date of Issue:
Expiration Date: August 25, 1996

SPECIFIC CONDITIONS:
(Continued)

COMPLIANCE TESTING

7. Each source must be tested concurrently in accordance with EPA Method 20 and DER Method 9, yearly from the date of January 14, 1986. Each source must also be tested concurrently in accordance with EPA Method 5 should the opacity equal or exceed 20 percent.
8. This office (Florida Department of Environmental Regulation, Air Permitting, Orlando) shall be notified in writing at least fifteen (15) days in advance of the compliance tests so that we can witness them (Rule 17-2.700(2)(a)5, F.A.C.).
9. This plant is required to operate within 90 to 100 percent of permitted capacity during the compliance tests.
10. The required test report shall be filed with the department as soon as practical but no later than 45 days after the last sampling run of each test is completed (Rule 17-2.700(7)(a), (b) and (c), F.A.C.).
11. The type of fuel and the heat input to this source must be entered on the visible emission test report.
12. Each calendar year on or before March 1, submit for each source, an Annual Operations Report DER Form 17-1.202(6) for the preceding calendar year.

EXPIRATION DATE

13. An operation permit renewal must be submitted at least 60 days prior to the expiration date of this permit (Rule 17-4.09, F.A.C.).

PERMITTEE:
Reedy Creek Improvement District
Attention: Thomas M. Moses
District Administrator

I. D. Number:
Permit/Certification Number:
A048-196703
Date of Issue:
Expiration Date: August 25, 1996

SPECIFIC CONDITIONS:
(Continued)

ISSUED

9-1-81

STATE OF FLORIDA DEPARTMENT
OF ENVIRONMENTAL REGULATION

cme

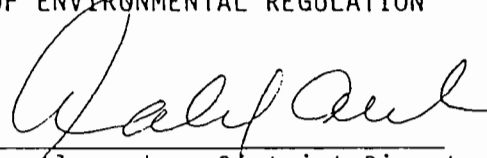

A. Alexander, District Director
3319 Maguire Boulevard, Suite 232
Orlando, Florida 32803



Department of Environmental Protection

Lawton Chiles
Governor

Two Towers Office Building
2600 Blair Stone Road
Tallahassee, Florida 32399-2400

Virginia B. Wetherell
Secretary

June 16, 1995

6/20

CERTIFIED MAIL- RETURN RECEIPT REQUESTED

Mr. Thomas M. Moses
District Administrator
Reedy Creek Improvement District
Post Office Box 10170
Lake Buena Vista, Florida 32830-0170

Dear Mr. Moses:

RE: Reedy Creek Improvement District (RCID)
EPCOT Center Diesel Generators No. 1 and No. 2
Construction Permits AC 48-105243 and AC 48-106650 and
GE Gas Turbine with Heat Recovery Steam Generator,
PSD-FL-123 and AC 48-137740

The Department is in receipt of your letter dated April 17, 1995, requesting a revision of Specific Conditions Nos. 2 and 7 of the above mentioned permits. The Department considered your request and agrees to revise your permits as proposed in your letters.

The revision of Specific Condition No. 2 of each permit is finalized as follows:

SPECIFIC CONDITION No. 2 FOR PERMITS AC 48-105243 and AC 48-106650
EPCOT CENTER DIESEL GENERATOR No. 1 and No. 2

FROM:

Old Specific Condition No.2

Emissions rates shall not exceed:

	Max. Allowable Rate lb/hr	Actual Emissions tons/yr
Particulate Matter	10.0	9.5
Sulfur Dioxide	14.5	14.0
Nitrogen Oxides	126.0	126.0
Carbon Monoxide	1.5	2.8
Volatile Organic Compounds	2.0	2.0

"Protect, Conserve and Manage Florida's Environment and Natural Resources"

Printed on recycled paper.

Mr. Thomas M. Moses
June 16, 1995
Page Two

TO:

New Specific Condition No. 2

Emissions rates shall not exceed:

	Max. Allowable Rate lb/hr	Annual Emissions tons/yr
Particulate Matter	10.0	9.5
Sulfur Dioxide	14.5	14.0
Nitrogen Oxides	126.0	126.0
Carbon Monoxide	2.9	2.8
Volatile Organic Compounds	2.1	2.0

SPECIFIC CONDITION No. 7 FOR PERMITS PSD-FL-123 & AC 48-137740
GE GAS TURBINE WITH HEAT RECOVERY STEAM GENERATOR

RCID COMMENT:

RCID requested to delete reference to Rule 62-252.300, F.A.C.,
since this rule applies to Gasoline Dispensing Facilities.

DEPARTMENT RESPONSE:

The Department acknowledges that Rule 62.252.300, F.A.C. does not
apply to this source. However, this reference will not be deleted
since it is part of the general statement of Rule 62-210.300(3),
F.A.C., Exemptions. For clarification, specific condition No. 7
will be revised as follows:

FROM:

Old Specific Condition No.7

Pursuant to Rule 62-210.300(3)(u) F.A.C., this condition will be
deleted.

It should be noted that pursuant to Rule 62-210.300(3), F.A.C.,
this source, although exempt from permitting requirements of
Chapter 62-210 and Chapter 62-4, F.A.C., is subject to any
applicable emission standard specified in Rule 62-252.300, and
62-296, F.A.C., other than Best Available Control Technology (BACT)
or Lowest Achievable Emission Rate (LAER) requirements.

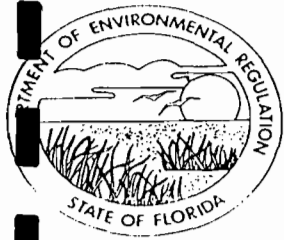

Florida Department of Environmental Regulation

Central District • 3319 Maguire Boulevard, Suite 232 • Orlando, Florida 32803-3767

Lawton Chiles, Governor

Virginia B. Wetherell, Secretary

Permittee:

Reedy Creek Energy Services, Inc.
Post Office Box 10,000
Lake Buena Vista, Florida 32830-1000

Attention: H. Robert Kohl, Director

Permit Number: AO48-224513

Date of Issue:

Expiration Date: April 30, 1998

County: Orange

Latitude/Longitude:

28°22'24"N/81°32'46"W

UTM: 17-446.6 KmE; 3138.5 KmN

Project: Hot Water Generators No. 1,
2, and 3 (EPCOT Center)

This permit is issued under the provisions of Chapter(s) 403, Florida Statutes, and Florida Administrative Code Rule(s) 17-2. The above named permittee is hereby authorized to perform the work or operate the facility shown on the application and approved drawing(s), plans, and other documents attached hereto or on file with the department and made a part hereof and specifically described as follows:

The permittee can operate hot water generators no. 1, 2, and 3 as follows:

- a) Hot Water Generator No. 1 (West) - Cleaver Brooks, Model CB 200X-800, Serial No. L69260
- b) Hot Water Generator No. 2 (Middle) - Cleaver Brooks, Model CB 200X-800, Serial No. L69259
- c) Hot Water Generator No. 3 (East) - Cleaver Brooks, Model CB 200X-800, Serial No. L69258

These sources are located at the EPCOT Central Energy Plant at 751 Backstage Lane, Bay Lake, Orange County, Florida.

General Conditions are attached to be distributed to the permittee only.

PERMITTEE:

Reedy Creek Energy Services, Inc.

Permit Number: A048-224513

Expiration Date: April 30, 1998

Attention: H. Robert Kohl, Director

GENERAL CONDITIONS:

16. No objectionable odors will be allowed, as per Rule 17-296.320(2), F.A.C.
17. This permit does not preclude compliance with any applicable local permitting requirements and regulations.

SPECIFIC CONDITIONS

OPERATING CONDITIONS

1. Each source is permitted to operate continuously.
2. Each source will be fired with natural gas or propane only except that no. 2 fuel oil may be utilized as a back-up fuel.
3. The maximum permitted heat input rate for each source is 27 MMBTU/hr.

EMISSION LIMITS

4. The emission limitation for each source is set forth in Rule 17-296.406(1), F.A.C., (20% opacity) and the compliance test must be conducted in accordance with DER Method #9 (Rule 17-297.420, F.A.C.).

COMPLIANCE TESTING

5. Each source must be tested for visible emissions in accordance with DER Method 9 for one hour at yearly intervals from the date of December 12, 1992. For any other method to be utilized the department must give prior approval.
6. If Fuel Oil must be used in an emergency, the department must be notified immediately and a visible emission test (DER Method #9) must be conducted and the results demonstrating compliance must be submitted to the department within 10 days after the fuel change. The permittee shall request a permit modification if Fuel Oil is to be used longer than 200 hours per year and shall be tested annually using Fuel Oil.
7. The air resources compliance section of this office shall be notified in writing at least fifteen (15) days in advance of the compliance tests (Rule 17-297.340(1)(i), F.A.C.).
8. Each source is required to operate within 90 to 100 percent of maximum permitted capacity during the compliance tests.
9. The type of fuel and the heat input to each source must be entered on the visible emission test report.

PERMITTEE:

Reedy Creek Energy Services, Inc.

Attention: H. Robert Kohl, Director

Permit Number: AO48-224513

Expiration Date: April 30, 1998

SPECIFIC CONDITIONS

(Continued)

10. The required test report shall be filed with this office as soon as practical but no later than 45 days after the last sampling run of each test is completed (Rule 17-297.570(2), F.A.C.).
11. Each calendar year on or before March 1, submit for each source, an Annual Operations Report DER Form 17-210.900(4) for the preceding calendar year.

EXPIRATION DATE

12. An operation permit renewal must be submitted at least 60 days prior to the expiration date of this permit (Rule 17-4.090, F.A.C.).

ISSUED

5/5/93

STATE OF FLORIDA DEPARTMENT
OF ENVIRONMENTAL REGULATION

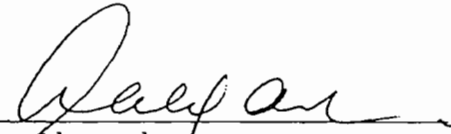
93 

A. Alexander
District Director
3319 Maguire Boulevard
Suite 232
Orlando, Florida 32803



Florida Department of Environmental Regulation

Central District • 3319 Maguire Boulevard, Suite 232 • Orlando, Florida 32803-3767 • 407-894-7555

Bob Martinez, Governor

Dale Twachtman, Secretary

John Shearer, Assistant Secretary
Alex Alexander, Deputy Assistant Secretary

Permittee:
Walt Disney World Company
Post Office Box 10,000
Lake Buena Vista, Florida 32830

Attention: Lauren H. James
Director of Resorts Maintenance

I. D. Number:
Permit/Certification
Number: AO48-169580
Date of Issue:
Expiration Date: 11/20/94
County: Orange
Latitude/Longitude:
28°24'05"N/81°35'12"W
UTM: 17-443.5 KmE; 3144.2 KmN
Project: Golf Course Paint Spray
Booth (WDW29)

This permit is issued under the provisions of Chapter(s) 403, Florida Statutes, and Florida Administrative Code Rule(s) 17-2. The above named permittee is hereby authorized to perform the work or operate the facility shown on the application and approved drawing(s), plans, and other documents attached hereto or on file with the department and made a part hereof and specifically described as follows:

The permittee can operate a Paint Spray Booth, Binks Model SSF-510-30-50-TRB using Andraea type paint arrestors to control particulates in the exhaust.

The source shall be in accordance with the permit application, plans, documents, amendments and drawings, except as otherwise noted in the General and Specific Conditions.

The booth will be located near the Disney Inn, part of the Disney complex in Orange County, Florida.

General Conditions are attached to be distributed to the permittee only.

PERMITTEE:

Walt Disney World Company

Attention: Lauren H. [redacted] Maintenance
 Director of [redacted]

I. D. Number:

Permit/Certification Number:

AO48-169580

Date of Issue:

Expiration Date: 11/20/94

SPECIFIC CONDITIONS:

- The Golf Course ~~Paint~~ Spray Booth shall operate for no more than 4160 hours annually (16 ~~days~~ / 5 days / 52 weeks).
- The maximum material utilization rates are as stated in the application for the specific ~~materials~~ and solvents which are to be used.
- The maximum allowed emissions shall not exceed:

Pollutant	Emissions	
	lbs/hr	TPY
VOC	2.10	4.37
PM/PM ₁₀	0.17	0.12

Visible emissions shall not exceed 20% opacity. Under normal operations, no visible emissions are expected.

Note: The annual emissions account for the intermittent spraying of paint, while the material utilization rates in Specific Condition No. 2 reflect the same basis.

- Rule 17-2.620(1) states that no person shall store, pump, handle, process, load, or use in any process or installation volatile organic compounds in devices or systems deemed necessary and ordered by the department. To comply, procedures to minimize pollutant emissions should include but not be limited to the following:

- tightly cover all VOC containers when they are not in use,
- tightly cover, where possible, all open troughs, basins, baths, tanks, etc. when they are not in use,
- maintain all valves, fittings, etc. in good operating condition,
- prevent excessive air turbulence across exposed VOC's,
- immediately clean up and clean up VOC spills and make sure certain wastes are placed in closed containers for reuse, recycling or proper disposal, and
- maintain a monthly accounting of each VOC based on beginning and ending inventory, deliveries, shipments, etc.

PERMITTEE:
Walt Disney World Company

Attention: Lauren H. James
Director of Resort Maintenance

I. D. Number:
Permit/Certification Number:
A048-169580
Date of Issue:
Expiration Date: 11/20/94

SPECIFIC CONDITIONS:

5. No objectionable odors shall be allowed, in accordance with F.A.C. Rule 17-2.620.
6. Annual compliance tests shall be conducted yearly from the date of August 23, 1989 in accordance with the 1987 version of 40 CFR 60, Appendix A, using:
 - a. EPA Method 9 for visible emissions
 - b. EPA Method 24 for VOC, or manufactures specifications and material balance.
7. A minimum of 15 days prior notification of the compliance tests shall be given to DER's Central Florida District Office. The compliance test results shall be submitted to the district office within 45 days of test completion.
8. Any change in the method of operation, raw materials, equipment or operating hours shall be submitted to DER's Central Florida District Office for approval
9. Each calendar year on or before March 1, submit for each source, an Annual Operations Report DER Form 17-1.202(6) for the preceding calendar year in accordance with Rule 17-4.14, F.A.C.
10. An operation permit renewal must be submitted at least 60 days prior to the expiration date of this permit (Rule 17-4.09, F.A.C.).

ISSUED

12-21-88

STATE OF FLORIDA DEPARTMENT
OF ENVIRONMENTAL REGULATION

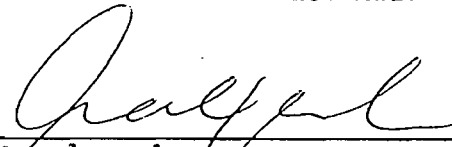
cmc 

A. Alexander
Deputy Assistant Secretary
3319 Maguire Boulevard
Suite 232
Orlando, Florida 32803
(407) 894-7555



Florida Department of Environmental Regulation

Central District • 3319 Maguire Boulevard, Suite 232 • Orlando, Florida 32803-3767

Lawton Chiles, Governor

Virginia B. Wetherell, Secretary

Reedy Creek Improvement District
Post Office Box 10,170
Lake Buena Vista, Florida 32830-1070

Attention: Thomas M. Moses, District Administrator

Orange County - AP
Hot Water Generators No. 1, 2, and 3 (EPCOT Center)
Permit No. A048-224513
Change of Conditions

Dear Mr. Moses:

We are in receipt of your request for a change of the permit conditions. The conditions are changed as follows:

<u>Condition</u>	<u>FROM</u>	<u>TO</u>
Permitee	H. Robert Kohl, Director Reedy Creek Energy Services, Incorporated Post Office Box 10,000 Lake Buena Vista, FL 32830-1000	Thomas M. Moses, District Administrator Reedy Creek Improvement District Post Office Box 10,170 Lake Buena Vista, FL 32830-1070
Specific Condition No. 5	... for one hour at yearly intervals for thirty minutes at yearly intervals ...

All other conditions remain the same.

This letter must be attached to your permit and becomes a part of that permit.

Sincerely,

CAMC 

A. Alexander, P.E.
District Director

Date 6/19/93

AA/jtt 

Copies furnished to:

Florida Department of Environmental Protection



Lawton Chiles
Governor

Central District
3319 Maguire Boulevard, Suite 232
Orlando, Florida 32803-3767

Virginia B. Wetherell
Secretary

Permittee:

Walt Disney World Company
Post Office Box 10,000
Lake Buena Vista, Florida 32830-1000

Attention: Robert Penn, Director,
Environmental Affairs

Permit Number: AO48-241327
Date of Issue:
Expiration Date: December 30, 1998
County: Orange
Latitude/Longitude:
28°24'49"N/81°35'13"W
UTM: 17-442.5 KmE; 3142.8 KmN
Project: Eighteen Hot Water
Generators

This permit is issued under the provisions of Chapter(s) 403, Florida Statutes, and Florida Administrative Code Rule(s) 17-2. The above named permittee is hereby authorized to perform the work or operate the facility shown on the application and approved drawing(s), plans, and other documents attached hereto or on file with the department and made a part hereof and specifically described as follows:

The permittee may operate eighteen hot water generators at the Grand Floridian Hotel. A diesel electric generator (Cummins Model KTTA38-GS-1, 900KW) is utilized as an emergency electrical generator and is permit exempt by Rule 17-210.300(3)(t), F.A.C.

Each Hot Water Generator is described as follows:

	<u>Description</u>	<u>Manufacturer</u>	<u>Maximum Heat Input Rate (MMBTU/hour)</u>
a)	Main Bldg Domestic Hot Water No. 1	Nickelshield, Model 3125N600ATP	2.5
b)	Main Bldg Domestic Hot Water No. 2	Nickelshield, Model 3125N600ATP	2.5
c)	Seafood Restaurant Domestic Hot Water	Nickelshield, Model 3125N600ATP	2.5
d)	Main Bldg Heating Hot Water No. 1	Burnnam, Model 3PW-200-50-LB	8.4
e)	Main Bldg Heating Hot Water No. 2	Burnnam, Model 3PW-200-50-LB	8.4

PERMITTEE:
Walt Disney World Company

Permit Number: AO48-241327
Expiration Date: December 30, 1998

Attention: Robert Penn, Director,
Environmental Affairs

	<u>Description</u>	<u>Manufacturer</u>	<u>Maximum Heat Input Rate (MMBTU/hour)</u>
f)	Lodge Bldg No. 2, Boiler No. 1	Bryan, Model K-300-WT	3.0
g)	Lodge Bldg No. 2, Boiler No. 2	Bryan, Model K-300-WT	3.0
h)	Lodge Bldg No. 3, Boiler No. 1	Bryan, Model CL-210	2.1
i)	Lodge Bldg No. 3, Boiler No. 2	Bryan, Model CL-210	2.1
j)	Lodge Bldg No. 4, Boiler No. 1	Bryan, Model CL-300	3.0
k)	Lodge Bldg No. 4, Boiler No. 2	Bryan, Model CL-300	3.0
l)	Lodge Bldg No. 5, Boiler No. 1	Bryan, Model K-350-WT	3.5
m)	Lodge Bldg No. 5, Boiler No. 2	Bryan, Model K-350-WT	3.5
n)	Lodge Bldg No. 6, Boiler No. 1	Bryan, Model K-350-WT	3.5
o)	Lodge Bldg No. 6, Boiler No. 2	Bryan, Model K-350-WT	3.5
p)	Main Bldg Kitchen Hot Water No. 1	Nickelshield, Model 875N200ATP	0.7
q)	Main Bldg Kitchen Hot Water No. 2	Nickelshield, Model 875N200ATP	0.7
r)	Swimming Pool Hot Water	Ray Pak, Model 2001	2.1

These sources are located at the Grand Floridian Hotel at 4401 Floridian Way, Buena Vista, Orange County, Florida.

General Conditions are attached to be distributed to the permittee only.

PERMITTEE:
Walt Disney World Company

Permit Number: AO48-241327
Expiration Date: December 30, 1998

Attention: Robert Penn, Director,
Environmental Affairs

GENERAL CONDITIONS:

16. No objectionable odors will be allowed, as per Rule 17-296.320(2), F.A.C.
17. This permit does not preclude compliance with any applicable local permitting requirements and regulations.

SPECIFIC CONDITIONS

OPERATING LIMITS

1. Each source is permitted to operate continuously.
2. Each source will be fired with natural gas or propane only.
3. The maximum permitted heat input rates for each source are as listed on permit pages no. 1a and 1b.

EMISSION LIMITS

4. The visible emissions for each source must comply with Rule 17-296.310(2), F.A.C., (20% opacity) and the compliance test must be conducted in accordance with DEP Method 9 (Rule 17-297.420, F.A.C.).

COMPLIANCE TESTING

5. Each source must be tested in accordance with DER Method 9 for 30 minutes at least 90 days prior to permit expiration date. For any other method to be utilized the department must give prior approval.
6. The air compliance section of this office shall be notified in writing at least fifteen (15) days in advance of the compliance tests (Rule 17-297.340(1)(i), F.A.C.).
7. Each source is required to operate within 90 to 100 percent of maximum permitted capacity during the compliance tests.
8. The required test report shall be filed with this office no later than 45 days after the last sampling run of each test is completed (Rule 17-297.570(2), F.A.C.).
9. Each calendar year on or before March 1, submit for each source, an Annual Operations Report DEP Form 17-210.900(4) for the preceding calendar year.

Disney World Company

Permit Number: AO48-241327
Expiration Date: December 30, 1998

Attention: Robert Penn, Director,
Environmental Affairs

SPECIFIC CONDITIONS
(Continued)

EXPIRATION DATE

10. An operation permit renewal must be submitted at least 60 days prior to the expiration date of this permit (Rule 17-4.090, F.A.C.).

ISSUED

119-17

STATE OF FLORIDA DEPARTMENT
OF ENVIRONMENTAL PROTECTION

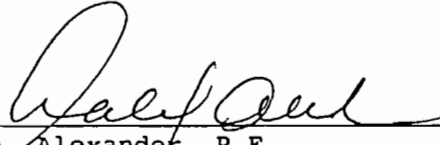

A. Alexander, P.E.
District Director
3319 Maguire Boulevard
Suite 232
Orlando, Florida 32803

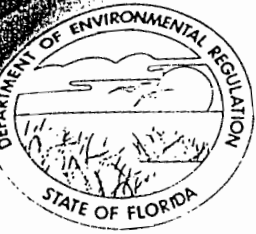

Florida Department of Environmental Regulation

Central District • 3319 Maguire Boulevard, Suite 232 • Orlando, Florida 32803-3767 • 407-894-7555

Bob Martinez, Governor

Dale Twachtman, Secretary

John Shearer, Assistant Secretary
Alex Alexander, Deputy Assistant Secretary

Permittee:

Walt Disney World Company
Post Office Box 10,000
Lake Buena Vista, Florida 32830

Attention: L. H. James
Director Resort Maintenance

I. D. Number:

Permit/Certification
Number: AO48-172541
Date of Issue:
Expiration Date: 12/30/94
County: Orange
Latitude/Longitude:
28°22'57"N/81°31'34"W
UTM: 17-448.3 KmE; 3139.5 KmN
Project: Lake Buena Vista
Community Village Paint Spray
Booths No. 1 (WDW27) and No. 2
(WDW28) - Lake Buena Vista

This permit is issued under the provisions of Chapter(s) 403, Florida Statutes, and Florida Administrative Code Rule(s) 17-2. The above named permittee is hereby authorized to perform the work or operate the facility shown on the application and approved drawing(s), plans, and other documents attached hereto or on file with the department and made a part hereof and specifically described as follows:

The permittee can operate Lake Buena Vista Community Village Paint Spray Booths No. 1 (WDW27) and No. 2 (WDW28) which are Devilbiss Model LF-519 and Binks Model SSF-6-3-1 respectively. Each booth is equipped with Andreae Paint Arrestors to control Particulate Matter (PM) emissions.

These sources are located at 1851 Community Drive at Lake Buena Vista, Orange County, Florida.

General Conditions are attached to be distributed to the permittee only.

PERMITTEE:

Walt Disney World Company

Attention: L. H. James

Director Resort Maintenance

I. D. Number:

Permit/Certification Number:

AO48-172541

Date of Issue:

Expiration Date: 12/30/94

SPECIFIC CONDITIONS:

1. No objectionable odors will be allowed, as per Rule 17-2.620(2), F.A.C.
2. There shall be no discharges of liquid effluents or contaminated runoff to surface or ground water without prior approval from this office.
3. All unconfined emissions of particulate matter generated at this site shall be adequately controlled. (Rule 17-2.610(3), F.A.C.) Area must be watered down should unconfined emissions occur.
4. This permit does not preclude compliance with any applicable local permitting requirements and regulations.
5. This source is permitted to operate 4160 hours/year.
6. The permitted materials and utilization rates are as stated in the applications.
7. The maximum permitted Volatile Organic Compound (VOC) emission rates are 14.8 tons/year (WDW27) and 10.5 tons/year (WDW28).
8. Rule 17-2.620(1)(a)F.A.C. states that no person shall store, pump, handle, process, load, unload or use in any process or installation volatile organic compounds or organic solvents without applying known and existing vapor emission control devices or systems deemed necessary and ordered by the department. To comply, procedures to minimize pollutant emissions should include but shall not be limited to the following:
 - (a) tightly cover or close all VOC containers when they are not in use,
 - (b) tightly cover, where possible, all open troughs, basins, baths, tanks, etc. when they are not in use,
 - (c) maintain all piping, valves, fittings, etc. in good operating condition,
 - (d) prevent excessive air turbulence across exposed VOC's,
 - (e) immediately confine and clean up VOC spills and make sure certain wastes are placed in closed containers for reuse, recycling or proper disposal, and
 - (f) maintain a monthly accounting of each VOC based on beginning and ending inventories, deliveries, shipments, etc.

PERMITTEE:
Walt Disney World Company

Attention: L. H. James
Director Resort Maintenance

I. D. Number:
Permit/Certification Number:
AO48-172541
Date of Issue:
Expiration Date: 12/30/94

SPECIFIC CONDITIONS:

9. The visible emissions for each Paint Spray Booth must comply with Rule 17-2.610(2)F.A.C. and the compliance test must be conducted in accordance with Rule 17-2.700(6)(b)9, (DER Method #9) F.A.C. at least 90 days prior to permit expiration date.
10. Each Paint Spray Booth should be properly operated and maintained (Rule 17-2.210(2) F.A.C.). No person shall circumvent any pollution control device or allow the emissions of air pollutants without the applicable air pollution control device operating properly (Rule 17-2.240 F.A.C.).
11. Visible emissions are not expected to exceed 5 percent opacity from a properly maintained and operated Paint Spray Booth equipped with Paint Arrestors.
12. This office (Florida Department of Environmental Regulation, Air Permitting, Orlando) shall be notified at least fifteen (15) days in advance of the compliance tests so that we can witness them (Rule 17-2.700(2)(a)5, F.A.C.).
13. This plant is required to operate within 90 to 100 percent of permitted capacity during the compliance tests.
14. The required test report shall be filed with the department as soon as practical but no later than 45 days after the last sampling run of each test is completed (Rule 17-2.700(7)(a),(b) and (c), F.A.C.).
15. Hazardous wastes generated in connection with any of the sources at this facility must be disposed of in accordance with Rule 17-30, F.A.C.
16. Air velocity at the Paint Booth Filter Face shall not exceed 250 ft/min.
17. Emissions within the building are not subject to regulation by this department, but for safety and health reasons, OSHA standards should be observed. Hexamethylene Diisocyanate emissions from the building shall not cause ambient air concentrations to exceed the Acceptable Ambient Concentration (AAC) at ground level of 0.15 mg/m^3 , based on 80 hours/week of operation.
18. Emissions within the building are not subject to regulation by this department, but for safety and health reasons, OSHA standards should be observed. Toluene emissions from the building shall not cause ambient air concentrations to exceed the Acceptable Ambient Concentration (AAC) at ground level of 3.75 mg/m^3 , based on 80 hour/week of operation.

PERMITTEE:
Walt Disney World Company

Attention: L. H. James
Director Resort Maintenance

I. D. Number:
Permit/Certification Number:
A048-172541
Date of Issue:
Expiration Date: 12/30/94

SPECIFIC CONDITIONS:

19. Each calendar year on or before March 1, submit for each source, an Annual Operations Report DER Form 17-1.202(6) for the preceding calendar year in accordance with Rule 17-4.14, F.A.C.
20. An operation permit renewal must be submitted at least 60 days prior to the expiration date of this permit (Rule 17-4.09, F.A.C.).

ISSUED 12-18-88

STATE OF FLORIDA DEPARTMENT
OF ENVIRONMENTAL REGULATION

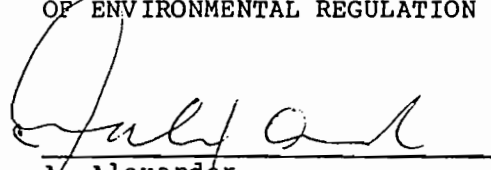
cm 

A. Alexander
Deputy Assistant Secretary
3319 Maguire Boulevard
Suite 232
Orlando, Florida 32803
(407) 894-7555



Florida Department of Environmental Regulation

Central District • 3319 Maguire Boulevard, Suite 232 • Orlando, Florida 32803-3767 • 407-894-7555

Bob Martinez, Governor

Dale Twachtman, Secretary

John Shearer, Assistant Secretary
Alex Alexander, Deputy Assistant Secretary

Permittee:
Walt Disney World Company
Post Office Box 10,000
Lake Buena Vista, Florida 32830-1000

Attention: Edward B. Crowell
Vice President, Facilities Support

I. D. Number:
Permit/Certification
Number: AO48-155895
Date of Issue:
Expiration Date: 11/10/94
County: Orange
Latitude/Longitude:
28°25'36"N/81°34'29"W
UTM: 17-443.65 KmE; 3144.46 KmN
Project: Dry Cleaning Operation,
Units No. 1, 2, 3, and 4

This permit is issued under the provisions of Chapter(s) 403, Florida Statutes, and Florida Administrative Code Rule(s) 17-2. The above named permittee is hereby authorized to perform the work or operate the facility shown on the application and approved drawing(s), plans, and other documents attached hereto or on file with the department and made a part hereof and specifically described as follows:

The permittee can operate Dry Cleaning Units No. 1, 2, 3, and 4. The emissions are controlled by a Spencer dual bed carbon adsorber Model 1500, Serial Number 190 that is approximately 99% efficient. A computer punch card control operation is utilized so that Multimatic Machine #1 would never be operating in the drying cycle at the same time as Multimatic Unit 2 and Unit 3 would never be operating in the drying cycle at the same time as Unit #4.

These sources are located along the East Wall in the Walt Disney World Laundry Building in the north service area at Bay Lake, Orange County, Florida.

General Conditions are attached to be distributed to the permittee only.

PERMITTEE:
Walt Disney World Company

Attention: Edward B. Crowell
Vice President, Facilities Support

I. D. Number:
Permit/Certification Number:
AO48-155895
Date of Issue:
Expiration Date: 11/10/94

SPECIFIC

CONDITIONS:

1. No objectionable odors will be allowed, as per Rule 17-2.620(2), F.A.C.
2. There shall be no discharges of liquid effluents or contaminated runoff to surface or ground water without prior approval from this office.
3. This permit does not preclude compliance with any applicable local permitting requirements and regulations.
4. This source is permitted to operate 3640 hours/year. *60% increase*
5. Each source is subject to the applicable control technology and emission limitations of Rule 17-2.600(12)(a) or (b), F.A.C.
6. To demonstrate compliance with specific condition no. 5, the source must be inspected at yearly intervals from the date of March 1, 1989 and a report submitted to the Department.
7. This office (Florida Department of Environmental Regulation, Air Permitting, Orlando) shall be notified at least fifteen (15) days in advance of the inspections so that we can witness them (Rule 17-2.700(2)(a)5, F.A.C.).
8. This plant is required to operate within 90 to 100 percent of permitted capacity during the compliance tests.
9. The required test report shall be filed with the department as soon as practical but no later than 45 days after the last sampling run of each test is completed (Rule 17-2.700(7)(a),(b) and (c), F.A.C.).
10. Solvent Stills emissions may be tested using the ASTM D 322-80 Method: "Gasoline Diluent in Used Gasoline Engine Oil by Distillation".
11. To prevent saturation of the carbon bed, the carbon adsorption equipment shall be desorbed after drying 700 pounds of dry cleaning material.
12. The carbon bed shall be desorbed with a minimum steam pressure in the range of 2.5 to 10 psi for a minimum of 30 minutes.
13. The carbon bed shall be fan dried for at least 15 minutes after desorption.
14. The rated air flow capacity of the carbon adsorption equipment shall be equal to or greater than the unrestricted exhaust flow rate of all equipment venting to the adsorber.

PERMITTEE:
Walt Disney World Company
Attention: Edward B. Crowell
Vice President, Facilities Support

I. D. Number:
Permit/Certification Number:
AO48-155895
Date of Issue:
Expiration Date: 11/10/94

SPECIFIC

CONDITIONS:

15. No bypass to the atmosphere shall exist during adsorption.
16. Lint filters and screens shall be cleaned periodically to allow free flow of gases.
17. Reclaimer dryer and/or dry-to-dry machine dampers shall be periodically checked for leaks.
18. Records of the weight of materials cleaned before each steam stripping shall be maintained.
19. Perceptible leaks in the following components shall be repaired within 3 working days or, if replacement parts are necessary, a purchase order for those parts must be initiated within 3 working days.

Hose connections, unions, couplings, and valves
Machine door gasket and seating
Filter head gasket and seating
Pumps
Base tanks and storage containers
Water separators
Filter sludge recovery
Distillation unit
Divertor valves
Saturated lint from lint basket
Cartridge filters

20. Each calendar year on or before March 1, submit for each source, an Annual Operations Report DER Form 17-1.202(6) for the preceding calendar year in accordance with Rule 17-4.14, F.A.C.
21. An operation permit renewal must be submitted at least 60 days prior to the expiration date of this permit (Rule 17-4.09, F.A.C.).

ISSUED 11-21-88

STATE OF FLORIDA DEPARTMENT
OF ENVIRONMENTAL REGULATION

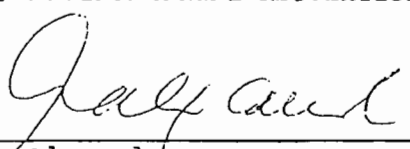
cmc

A. Alexander
Deputy Assistant Secretary
3319 Maguire Boulevard
Suite 232
Orlando, Florida 32803



Florida Department of Environmental Regulation

Central District • 3319 Maguire Boulevard, Suite 232 • Orlando, Florida 32803-3767 • 407-894-7555

Bob Martinez, Governor

Dale Twachtmann, Secretary

John Shearer, Assistant Secretary
Alex Alexander, Deputy Assistant Secretary

Permittee:

Walt Disney World Co.
Post Office Box 10,000
Lake Buena Vista, Florida 32830

Attention: Edward B. Crowell,
Vice President, Facilities Support

I. D. Number:

Permit/Certification

Number: A048-169578

Date of Issue: 11-7-89

Expiration Date: 11/10/94

County: Orange

Latitude/Longitude:

28°24'05"N/81°35'12"W

UTM: 17-443.5 KmE; 3144.2 KmN

Project: Laundry Boilers No. 1,
2, 3, and 4

This permit is issued under the provisions of Chapter(s) 403, Florida Statutes, and Florida Administrative Code Rule(s) 17-2. The above named permittee is hereby authorized to perform the work or operate the facility shown on the application and approved drawing(s), plans, and other documents attached hereto or on file with the department and made a part hereof and specifically described as follows:

The permittee can operate four natural gas-fired boilers to provide steam to an existing laundry facility. Boilers 1, 2, and 3 are York-Shipley Steam Boilers of 300HP, 300HP and 350HP respectively, firing a total of 39,600 CFH of natural gas and exhausting through a common stack. Boiler No. 4 has a capacity of 7,734 CFH.

The source shall be in accordance with the permit application, plans, documents, amendments and drawings, except as otherwise noted in the General and Specific Conditions.

The boilers are located in the North Service Area in the Walt Disney complex, Orange County, Florida.

General Conditions are attached to be distributed to the permittee only.

PERMITTEE:
Walt Disney World Co.

Attention: Edward B. Crowell,
Vice President, Facilities Support

I. D. Number:
Permit/Certification Number:
A048-169578
Date of Issue:
Expiration Date: 11/10/94

SPECIFIC CONDITIONS:

1. Boilers 1, 2, 3, and 4 may operate continuously, 8760 hours per year.
2. Only natural gas shall be fired in the boilers.
3. The maximum heat input to the boilers 1, 2, and 3 shall not exceed a combined total of 39.6 MMBTU/hr. The maximum heat input to boiler No. 4 shall not exceed 7.8 MMBTU/hr.
4. The maximum allowable emissions from all the three boilers combined for inventory purposes are as follows:

<u>Pollutant</u>	<u>Emissions</u>	
	<u>lbs/hr</u>	<u>TPY</u>
PM/PM ₁₀	0.24	1.04
SO ₂	0.03	0.12
NO _x	4.73	20.74
CO	0.94	4.15
VOC	0.25	1.1

5. Visible emissions shall not exceed 5% opacity.
6. Good combustion practices shall be implemented at all times as control measures for the pollutants emitted as products of combustion.
7. Compliance tests shall be conducted annually from the date of March 1, 1989 using EPA Method 9, for visible emissions, in accordance with the 1987 version of 40 CFR 60, Appendix A.
8. A minimum of 15 days prior notification of the compliance tests shall be given to DER's Central District office. The compliance test results shall be submitted to the district office within 45 days of test completion.
9. Any change in the method of operation, fuels, equipment or operating hours shall be submitted to DER's Central District office for approval.
10. Each calendar year on or before March 1, submit for each source, an Annual Operations Report DER Form 17-1.202(6) for the preceding calendar year in accordance with Rule 17-4.14, F.A.C.

COMMITTEE:
Walt Disney World Co.

Attention: Edward B. Crowell,
Vice President, Facilities Support

I. D. Number:
Permit/Certification Number:
A048-169578
Date of Issue:
Expiration Date: 11/10/94

SPECIFIC CONDITIONS:

11. An operation permit renewal must be submitted at least 60 days prior to the expiration date of this permit (Rule 17-4.09, F.A.C.).

ISSUED 11-7-89

STATE OF FLORIDA DEPARTMENT
OF ENVIRONMENTAL REGULATION

Charles M. Collins

for A. Alexander
Deputy Assistant Secretary
3319 Maguire Boulevard
Suite 232
Orlando, Florida 32803



Department of Environmental Protection

Lawton Chiles
Governor

Central District
3319 Maguire Boulevard, Suite 232
Orlando, Florida 32803-3767

Virginia B. Wetherell
Secretary

Permittee:

Walt Disney World Company
Post Office Box 10,000
Lake Buena Vista, Florida 32830-1000

Attention: Bob Penn, Director -
Environmental Affairs

Permit Number: AO48-252008
Date of Issue:
Expiration Date: June 30, 1999
County: Orange
Latitude/Longitude:
28°21'25"N/81°33'42"W
UTM: 17-443.1 KmE; 3137.7 KmN
Project: Nine Hot Water Generators
(Studio Tours)

This permit is issued under the provisions of Chapter(s) 403, Florida Statutes, and Florida Administrative Code Rule(s) 17-2. The above named permittee is hereby authorized to perform the work or operate the facility shown on the application and approved drawing(s), plans, and other documents attached hereto or on file with the department and made a part hereof and specifically described as follows:

The permittee can operate nine hot water generators (studio tours) as follows:

<u>Designation</u>	<u>Manufacturer</u>	<u>Maximum Heat Input Rate (MMBTU/hr)</u>
STB-1	A.O. Smith, Model HWT-1240	1.3
STB-2A	Bryan, Model CL-150	1.6
STB-2B	Lochinvar, Model CWM-1210	1.3
STB-3	Bryan, Model CL-120	1.3
STB-4	Bryan, Model CL-180	1.9
STB-5	Ray Pak, Model WT-1223	1.2
STB-6	Thermosteam, Model FG60	2.5
STB-7	Lochinvar, Model CWM-1210	1.3
STB-8	A.O. Smith, Model HWT-1240	1.3

This source is located at the Studio Tours area at World Drive, Disney Center, Orange County, Florida.

General Conditions are attached to be distributed to the permittee only.

PERMITTEE:
Walt Disney World Company

I.D. Number:
Permit Number: AO48-228914
Expiration Date: May 30, 1998
County: Orange

Attention: Robert H. Penn, Director,
Environmental Affairs

GENERAL CONDITIONS:

16. No objectionable odors will be allowed, as per Rule 17-296.320(2), F.A.C.
17. This permit does not preclude compliance with any applicable local permitting requirements and regulations.

SPECIFIC CONDITIONS

OPERATING LIMITS

1. Each source is permitted to operate continuously, per the application.
2. Each source will be fired with natural gas or propane only, per the application.
3. The maximum permitted heat input rates are as stated on permit page no. 1, per the application.

EMISSION LIMITS

4. The visible emissions from each source must comply with Rule 17-296.310, F.A.C. (20% opacity limit).

COMPLIANCE TESTING

5. The source must be tested for visible emissions for thirty minutes or the length of the batch/cycle with DEP Method 9 at least ninety days prior to the permit expiration date (Rule 17-297.401, F.A.C.).
6. The air compliance section of this office shall be notified in writing at least fifteen (15) days in advance of the compliance tests (Rule 17-297.340(1)(i), F.A.C.).
7. The source is required to operate within 90 to 100 percent of permitted capacity during the compliance test.
8. The type of fuel and the heat input to this source must be entered on the visible emission report.
9. The required test report shall be filed with the department no later than 45 days after the last sampling run of each test is completed (Rule 17-297.570(2), F.A.C.).
10. Each calendar year on or before March 1, submit for each source, an Annual Operations Report DEP Form 17-210.900(4) for the preceding calendar year.

PERMITTEE:
Walt Disney World Company

I.D. Number:
Permit Number: AO48-228914
Expiration Date: May 30, 1998
County: Orange

Attention: Robert H. Penn, Director,
Environmental Affairs

SPECIFIC CONDITIONS
(continued)

EXPIRATION DATE

11. An operation permit renewal must be submitted at least 60 days prior to the expiration date of this permit (Rule 17-4.090, F.A.C.).

ISSUED 7-20-94

STATE OF FLORIDA DEPARTMENT
OF ENVIRONMENTAL PROTECTION

cmc

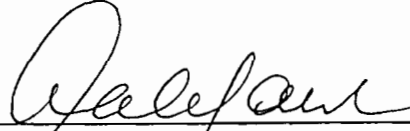
A. Alexander, P.E.
District Director
3319 Maguire Boulevard, Suite 232
Orlando, Florida 32803

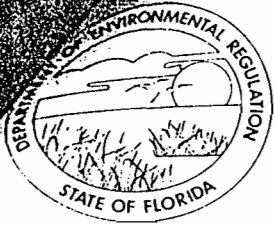

Florida Department of Environmental Regulation

Central District • 3319 Maguire Boulevard, Suite 232 • Orlando, Florida 32803-3767 • 407-894-7555

Bob Martinez, Governor

Dale Twachtmann, Secretary

John Shearer, Assistant Secretary
Alex Alexander, Deputy Assistant Secretary

Permittee:

Walt Disney World Company
Post Office Box 10,000
Lake Buena Vista, Florida 32830

Attention: Bruce Laval, Director
Studio Tours

I. D. Number:

Permit/Certification
Number: AO48-172592
Date of Issue:
Expiration Date: 12/30/94
County: Orange
Latitude/Longitude:
28°21'25"N/81°33'42"W
UTM: 17-443.5 KmE; 3137.7 KmN
Project: Studio Craft Paint
Spray Booth (WDW21)-Studio Tours

This permit is issued under the provisions of Chapter(s) 403, Florida Statutes, and Florida Administrative Code Rule(s) 17-2. The above named permittee is hereby authorized to perform the work or operate the facility shown on the application and approved drawing(s), plans, and other documents attached hereto or on file with the department and made a part hereof and specifically described as follows:

The permittee can operate Studio Craft Paint Spray Booth (WDW 21) which is a Binks Model PFF-8-7-T-LH equipped with Andreae Paint Arrestors to control Particulate Matter (PM) emissions.

This source is located at the Studio Tours Craft Shop at World Drive, Disney Center, Orange County, Florida.

General Conditions are attached to be distributed to the permittee only.

PERMITTEE:
Walt Disney World Company

Attention: Bruce Laval, Director
Studio Tours

I. D. Number:
Permit/Certification Number:
AO48-172592
Date of Issue:
Expiration Date: 12/30/94

SPECIFIC CONDITIONS:

1. No objectionable odors will be allowed, as per Rule 17-2.620(2), F.A.C.
2. There shall be no discharges of liquid effluents or contaminated runoff to surface or ground water without prior approval from this office.
3. All unconfined emissions of particulate matter generated at this site shall be adequately controlled. (Rule 17-2.610(3), F.A.C.) Area must be watered down should unconfined emissions occur.
4. This permit does not preclude compliance with any applicable local permitting requirements and regulations.
5. This source is permitted to operate 4160 hours/year.
6. The permitted materials and utilization rates are as stated in the application.
7. The maximum permitted Volatile Organic Compound (VOC) emission rate is 1.01 tons/year.
8. Rule 17-2.620(1)(a)FAC states that no person shall store, pump, handle, process, load, unload or use in any process or installation volatile organic compounds or organic solvents without applying known and existing vapor emission control devices or systems deemed necessary and ordered by the department. To comply, procedures to minimize pollutant emissions should include but shall not be limited to the following:
 - a) tightly cover or close all VOC containers when they are not in use,
 - b) tightly cover, where possible, all open troughs, basins, baths, tanks, etc. when they are not in use,
 - c) maintain all piping, valves, fittings, etc. in good operating condition,
 - d) prevent excessive air turbulence across exposed VOC's,
 - e) immediately confine and clean up VOC spills and make sure certain wastes are placed in closed containers for reuse, recycling or proper disposal, and
 - f) maintain a monthly accounting of each VOC based on beginning and ending inventories, deliveries, shipments, etc.

I. D. Number:
 Permit/Certification Number:
 AO48-172592
 Date of Issue:
 Expiration Date: 12/30/94

Company
 George Laval, Director
 Audio Tours
 CONDITIONS:

The visible emissions for this Paint Spray Booth must comply with Rule 17-2.610(2)F.A.C. and the compliance test must be conducted in accordance with Rule 17-2.700(6)(b)9, (DER Method #9) F.A.C.

10. The Paint Spray Booth must be properly operated and maintained (Rule 17-2.210(2) F.A.C.). No person shall circumvent any pollution control device or allow the emissions of air pollutants without the applicable air pollution control device operating properly (Rule 17-2.240 F.A.C.).
11. Visible emissions are not expected to exceed 5 percent opacity from a properly maintained and operated Paint Spray Booth equipped with Paint Arrestors.
12. Each source must be tested for visible emissions in accordance with DER Method 9 at least ninety (90) days prior to permit expiration date.
13. This office (Florida Department of Environmental Regulation, Air Permitting, Orlando) shall be notified at least fifteen (15) days in advance of the compliance tests so that we can witness them (Rule 17-2.700(2)(a)5, F.A.C.).
14. This plant is required to operate within 90 to 100 percent of permitted capacity during the compliance tests.
15. The required test report shall be filed with the department as soon as practical but no later than 45 days after the last sampling run of each test is completed (Rule 17-2.700(7)(a),(b) and (c), F.A.C.).
16. Hazardous wastes generated in connection with any of the sources at this facility must be disposed of in accordance with Rule 17-30, F.A.C.
17. Air velocity at the Paint Booth Filter Face shall not exceed 250 ft/min.
18. Emissions within the building are not subject to regulation by this department, but for safety and health reasons, OSHA standards should be observed. Toluene emissions from the building shall not cause ambient air concentrations to exceed the Acceptable Ambient Concentration (AAC) at ground level of 3.75 mg/m³, based on 80 hours/week of operation.
19. Each calendar year on or before March 1, submit for each source, an Annual Operations Report DER Form 17-1.202(6) for the preceding calendar year in accordance with Rule 17-4.14, F.A.C.

PERMITTEE:
Walt Disney World Company

Attention: Bruce Laval, Director
Studio Tours

I. D. Number:
Permit/Certification Number:
A048-172592
Date of Issue:
Expiration Date: 12/30/94

SPECIFIC CONDITIONS:

An operation permit renewal must be submitted at least 60 days prior to the expiration date of this permit (Rule 17-4.09, F.A.C.).

ISSUED 12-18-89

STATE OF FLORIDA DEPARTMENT
OF ENVIRONMENTAL REGULATION

A. Alexander

A. Alexander
Deputy Assistant Secretary
3319 Maguire Boulevard
Suite 232
Orlando, Florida 32803
(407) 894-7555

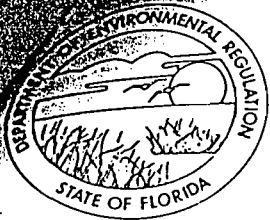

Florida Department of Environmental Regulation

Central District • 3319 Maguire Boulevard, Suite 232 • Orlando, Florida 32803-3767 • 407-894-7555

Bob Martinez, Governor

Dale Twachtmann, Secretary

John Shearer, Assistant Secretary
Alex Alexander, Deputy Assistant Secretary

Permittee:

Walt Disney World Company
Post Office Box 10,000
Lake Buena Vista, Florida 32830

Attention: Henry E. Dains,
Director Furnishings

I. D. Number:

Permit/Certification

Number: AO48-172594

Date of Issue:

Expiration Date: 12/30/94

County: Orange

Latitude/Longitude:

28°25'05"N/81°35'12"W

UTM: 17-442.5 KmE; 3143.5 KmN

Project: Entertainment Support

Paint Spray Booth (WDW23)-Magic
Kingdom

This permit is issued under the provisions of Chapter(s) 403, Florida Statutes, and Florida Administrative Code Rule(s) 17-2. The above named permittee is hereby authorized to perform the work or operate the facility shown on the application and approved drawing(s), plans, and other documents attached hereto or on file with the department and made a part hereof and specifically described as follows:

The permittee can operate Entertainment Support Paint Spray Booth (WDW 23)-Magic Kingdom which is a Binks Model PFA-6-8-T-LH equipped with Andreae Paint Arrestors to control Particulate Matter (PM) emissions.

This source is located at the Magic Kingdom at Carribbean Drive, Bay Lake, Orange County, Florida.

General Conditions are attached to be distributed to the permittee only.

PERMITTEE:
Walt Disney World Company

Attention: Henry E. Dains,
Director Furnishings

I. D. Number:
Permit/Certification Number:
A048-172594
Date of Issue:
Expiration Date: 12/30/94

SPECIFIC CONDITIONS:

1. No objectionable odors will be allowed, as per Rule 17-2.620(2), F.A.C.
2. There shall be no discharges of liquid effluents or contaminated runoff to surface or ground water without prior approval from this office.
3. All unconfined emissions of particulate matter generated at this site shall be adequately controlled. (Rule 17-2.610(3), F.A.C.) Area must be watered down should unconfined emissions occur.
4. This permit does not preclude compliance with any applicable local permitting requirements and regulations.
5. This source is permitted to operate 4160 hours/year.
6. The permitted materials and utilization rates are as stated in the application.
7. The maximum permitted Volatile Organic Compound (VOC) emission rate is 0.52 tons/year.
8. Rule 17-2.620(1)(a)FAC states that no person shall store, pump, handle, process, load, unload or use in any process or installation volatile organic compounds or organic solvents without applying known and existing vapor emission control devices or systems deemed necessary and ordered by the department. To comply, procedures to minimize pollutant emissions should include but shall not be limited to the following:
 - a) tightly cover or close all VOC containers when they are not in use,
 - b) tightly cover, where possible, all open troughs, basins, baths, tanks, etc. when they are not in use,
 - c) maintain all piping, valves, fittings, etc. in good operating condition,
 - d) prevent excessive air turbulence across exposed VOC's,
 - e) immediately confine and clean up VOC spills and make sure certain wastes are placed in closed containers for reuse, recycling or proper disposal, and
 - f) maintain a monthly accounting of each VOC based on beginning and ending inventories, deliveries, shipments, etc.

PERMITTEE:
Walt Disney World Company

Attention: Henry E. Dains,
Director Furnishings

I. D. Number:
Permit/Certification Number:
AO48-172594
Date of Issue:
Expiration Date: 12/30/94

SPECIFIC CONDITIONS:

9. The visible emissions for this Paint Spray Booth must comply with Rule 17-2.610(2)F.A.C. and the compliance test must be conducted in accordance with Rule 17-2.700(6)(b)9, (DER Method #9) F.A.C.
10. The Paint Spray Booth must be properly operated and maintained (Rule 17-2.210(2) F.A.C.). No person shall circumvent any pollution control device or allow the emissions of air pollutants without the applicable air pollution control device operating properly (Rule 17-2.240 F.A.C.).
11. Visible emissions are not expected to exceed 5 percent opacity from a properly maintained and operated Paint Spray Booth equipped with Paint Arrestors.
12. Each source must be tested for visible emissions in accordance with Department of Environmental Regulation Method 9 at least ninety (90) days prior to permit expiration date.
13. This office (Florida Department of Environmental Regulation, Air Permitting, Orlando) shall be notified at least fifteen (15) days in advance of the compliance tests so that we can witness them (Rule 17-2.700(2)(a)5, F.A.C.).
14. This plant is required to operate within 90 to 100 percent of permitted capacity during the compliance tests.
15. The required test report shall be filed with the department as soon as practical but no later than 45 days after the last sampling run of each test is completed (Rule 17-2.700(7)(a),(b) and (c), F.A.C.).
16. Hazardous wastes generated in connection with any of the sources at this facility must be disposed of in accordance with Rule 17-30, F.A.C.
17. Air velocity at the Paint Booth Filter Face shall not exceed 250 ft/min.
18. Emissions within the building are not subject to regulation by this department, but for safety and health reasons, OSHA standards should be observed. Toluene emissions from the building shall not cause ambient air concentrations to exceed the Acceptable Ambient Concentration (AAC) at ground level of 3.75 mg/m³, based on 80 hours/week of operation.
19. Each calendar year on or before March 1, submit for each source, an Annual Operations Report DER Form 17-1.202(6) for the preceding calendar year in accordance with Rule 17-4.14, F.A.C.

PERMITTEE:
Walt Disney World Company

Attention: Henry E. Dains,
Director Furnishings

I. D. Number:
Permit/Certification Number:
AO48-172594
Date of Issue:
Expiration Date: 12/30/94

SPECIFIC CONDITIONS:

20. An operation permit renewal must be submitted at least 60 days prior to the expiration date of this permit (Rule 17-4.09, F.A.C.).

ISSUED 12-18-85

STATE OF FLORIDA DEPARTMENT
OF ENVIRONMENTAL REGULATION

cmc

Alexander
A. Alexander
Deputy Assistant Secretary
3319 Maguire Boulevard
Suite 232
Orlando, Florida 32803
(407) 894-7555

Florida Department of Environmental Protection

Central District
3319 Maguire Boulevard, Suite 232
Orlando, Florida 32803-3767

Virginia B. Wetherell
Secretary

Vista Communities,
Incorporated
P.O. Box 10,000
Orlando, Florida 32830

Attention: Sydney L. Jackowitz, Secretary

Orange County - AP
Magic Kingdom Paint Booth-Ride Show Components
Magic Kingdom Paint Booth-Entertainment
Support (WDW-23)
Permit No. AC48-209586 and AO48-172594
Change of Conditions

Dear Mr. Jackowitz:

We are in receipt of your request for a change of the permit conditions. The conditions are changed as follows:

<u>Condition</u>	<u>FROM</u>	<u>TO</u>
Permittee	Walt Disney World Company and Robert H. Penn, Director	Lake Buena Vista Communities, and Sydney L. Jackowicz, Secretary

All other conditions remain the same.

This letter must be attached to your permit and becomes a part of that permit.

Sincerely,

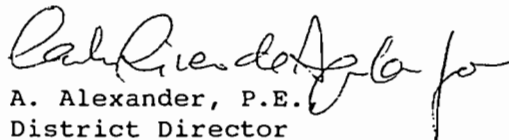
cm 
A. Alexander, P.E.
District Director

Date 8/23/93

az
AA/azt

Copies furnished to:

Robert H. Penn
Dennis Nester

Florida Department of Environmental Regulation

Central District • 3319 Maguire Boulevard, Suite 232 • Orlando, Florida 32803-3767

Lawton Chiles, Governor

Carol M. Browner, Secretary



Permittee:
Walt Disney World
Post Office Box 10,000
Lake Buena Vista, FL 32830-1000

Attention: Bob Penn, Director,
Environmental Affairs

I. D. Number:
Permit/Certification
Number: A048-196805
Date of Issue:
Expiration Date: June 30, 1997
County: Orange
Latitude/Longitude:
28°25'32"N/81°34'36"W
UTM: 17-443.5 KmE; 3144.3 KmN
Project: Six Paint Spray Booths

This permit is issued under the provisions of Chapter(s) 403, Florida Statutes, and Florida Administrative Code Rule(s) 17-2. The above named permittee is hereby authorized to perform the work or operate the facility shown on the application and approved drawing(s), plans, and other documents attached hereto or on file with the department and made a part hereof and specifically described as follows:

The permittee can operate Six Paint Spray Booths which are the following:

1. NSA Paint Spray Booth No. 1 for coating objects such as vehicles, wooden furniture, trash cans, ride components, posts and frames. The booth is equipped with two Binks Model 30-4313 exhaust fans and Binks Model 29-893 paint arrestor type filters.
2. NSA Paint Spray Booth No. 2 for coating objects such as vehicles, wooden furniture, trash cans, ride components, posts and frames. The booth is equipped with two Binks Model 30-4418 exhaust fans and Binks Model 29-893 paint arrestor type filters.
3. NSA Paint Spray Booth No. 3 for coating objects such as vehicles, wooden furniture, trash cans, ride components, posts and frames. The booth is equipped with two Binks Model 30-4418 exhaust fans and Binks Model 29-893 paint arrestor type filters.
4. NSA Staff Shop Booth No. 1 for coating fiberglass objects and molds. The booth is a Binks Model PPF with Model 30-800 fans. The particulate filters have an efficiency of approximately 80% for lacquers and approximately 95% for two part high particulate coating systems.

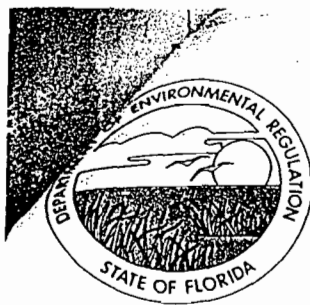

Florida Department of Environmental Regulation

Central District • 3319 Maguire Boulevard, Suite 232 • Orlando, Florida 32803-3767

Lawton Chiles, Governor

Carol M. Browner, Secretary

Permittee:
 Walt Disney World
 Post Office Box 10,000
 Lake Buena Vista, FL 32830-1000

Attention: Bob Penn, Director,
 Environmental Affairs

I. D. Number:
 Permit/Certification
 Number: A048-196805
 Date of Issue:
 Expiration Date: June 30, 1997
 County: Orange
 Latitude/Longitude:
 28°25'32"N/81°34'36"W
 UTM: 17-443.5 KmE; 3144.3 KmN
 Project: Six Paint Spray Booths

5. NSA Staff Shop Booth No. 2 for coating fiberglass objects and molds. This built in spray booth is equipped with a New York Model S48-1 blower and particulate filters with an efficiency of approximately 80% for lacquers and approximately 95% for two part high particulate coating systems.
6. Water Wash Plastisol Booth No. 1 consists of a spray booth and curing oven. The spray booth is a Binks water wash type equipped with a fan and a no pump dyna-precipitator water wash filtering system. The curing oven is equipped with a fan and is fired by natural gas. The booth is used to spray solvated vinyl plastisol on fiberglass objects and molds.

These sources are located at the Walt Disney World Central Facilities Shop Building, Facilities Way, Bay Lake, Orange County, Florida.

General Conditions are attached to be distributed to the permittee only.



PERMITTEE:
Walt Disney World Co.

Attention: Bob Penn, Director,
Environmental Affairs

I. D. Number:
Permit/Certification Number:
A048-196805
Date of Issue:
Expiration Date: June 30, 1997

GENERAL CONDITIONS:

16. No objectionable odors will be allowed, as per Rule 17-2.620(2), F.A.C.
17. All unconfined emissions of particulate matter generated at this site shall be adequately controlled. (Rule 17-2.610(3), F.A.C.) Area must be watered down should unconfined emissions occur.
18. This permit does not preclude compliance with any applicable local permitting requirements and regulations.

SPECIFIC CONDITIONS

OPERATING LIMITS

1. The hours of operation shall not exceed the following:

<u>Source</u>	<u>hours/year</u>
a) NSA Paint Spray Booth No. 1	4,160
b) NSA Paint Spray Booth No. 2	4,160
c) NSA Paint Spray Booth No. 3	4,160
d) NSA Staff Shop Booth No. 1	2,080
e) NSA Staff Shop Booth No. 2	2,080
f) Water Wash Plastisol Booth No. 1	2,080

2. The permitted materials and utilization rates are as stated in the application.
3. Each source must be properly operated and maintained (Rule 17-2.210(2) F.A.C.). No person shall circumvent any pollution control device or allow the emissions of air pollutants without the applicable air pollution control device operating properly (Rule 17-2.240 F.A.C.).

EMISSION LIMITS

4. The visible emissions for this source must comply with Rule 17-2.610(2) F.A.C. (20% opacity limit) and the compliance test must be conducted in accordance with Rule 17-2.700(6)(b)9, (DER Method #9) F.A.C.

PERMITTEE:
Walt Disney World Co.

Attention: Bob Penn, Director,
Environmental Affairs

I. D. Number:
Permit/Certification Number:
A048-196805
Date of Issue:
Expiration Date: June 30, 1997

SPECIFIC CONDITIONS
(Continued)

5. Rule 17-2.620(1)(a) F.A.C. states that no person shall store, pump, handle, process, load, unload or use in any process or installation volatile organic compounds or organic solvents without applying known and existing vapor emission control devices or systems deemed necessary and ordered by the department. To comply, procedures to minimize pollutant emissions should include but shall not be limited to the following:
 - a) tightly cover or close all VOC containers when they are not in use,
 - b) tightly cover, where possible, all open troughs, basins, baths, tanks, etc. when they are not in use,
 - c) maintain all piping, valves, fittings, etc. in good operating condition,
 - d) prevent excessive air turbulence across exposed VOC's,
 - e) immediately confine and clean up VOC spills and make sure certain wastes are placed in closed containers for reuse, recycling or proper disposal, and
 - f) maintain a monthly accounting of each VOC based on beginning and ending inventories, deliveries, shipments, etc.
6. Acrylonitrile emissions from the source shall not cause the 24 hour average ground level ambient air concentrations to exceed the No Threat Level (NTL) of 10.32 micrograms/M³. Proof of compliance with this condition can be demonstrated by the professional engineer's calculations based on actual conditions.

COMPLIANCE TESTING

7. Each source must be tested for visible emissions at yearly intervals from the date of May 5, 1992, in accordance with Rule 17-2.700(6)(b)9, (DER Method #9) F.A.C.
8. This office (Florida Department of Environmental Regulation, Air Permitting, Orlando) shall be notified in writing at least fifteen (15) days in advance of the compliance tests so that we can witness them (Rule 17-2.700(2)(a)5, F.A.C.).

PERMITTEE:
Walt Disney World Co.

Attention: Bob Penn, Director,
Environmental Affairs

I. D. Number:
Permit/Certification Number:
A048-196805
Date of Issue:
Expiration Date: June 30, 1997

SPECIFIC CONDITIONS
(Continued)

9. This plant is required to operate within 90 to 100 percent of permitted capacity during the compliance tests.
10. The required test report shall be filed with the department as soon as practical but no later than 45 days after the last sampling run of each test is completed (Rule 17-2.700(7)(a),(b) and (c), F.A.C).
11. Should any source apply coatings to items which subjects the source to any RACT category pursuant to Rule 17-2.650, F.A.C., a report demonstrating compliance with the applicable RACT limit shall be submitted to the Department within 10 days.
12. Each calendar year on or before March 1, submit for each source, an Annual Operations Report DER Form 17-1.202(6) for the preceding calendar year.

EXPIRATION DATE

13. An operation permit renewal must be submitted at least 60 days prior to the expiration date of this permit (Rule 17-4.09, F.A.C.).

ISSUED 7-30-97

STATE OF FLORIDA DEPARTMENT
OF ENVIRONMENTAL REGULATION

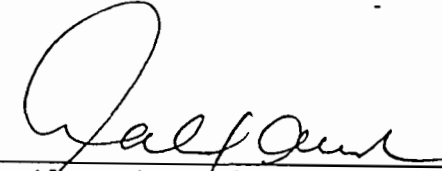
AS 
A. Alexander, District Director
3319 Maguire Boulevard, Suite 232
Orlando, Florida 32803

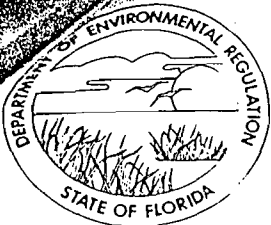

Florida Department of Environmental Regulation

Central District • 3319 Maguire Boulevard, Suite 232 • Orlando, Florida 32803-3767 • 407-894-7555

Bob Martinez, Governor

Dale Twachtmann, Secretary

John Shearer, Assistant Secretary
Alex Alexander, Deputy Assistant Secretary

Permittee:
Walt Disney World Company
Post Office Box 10,000
Lake Buena Vista, Florida 32830

Attention: Bob Penn, Director
Environmental Affairs Division

I. D. Number:
Permit/Certification
Number: AO48-183381
Date of Issue:
Expiration Date: **October 25, 1995**
County: Orange
Latitude/Longitude:
28°25'32"N/81°34'36"W
UTM: 17-443.5 KmE; 3144.2 KmN
Project: Six Paint Spray Booths -
North Service Area

This permit is issued under the provisions of Chapter(s) 403, Florida Statutes, and Florida Administrative Code Rule(s) 17-2. The above named permittee is hereby authorized to perform the work or operate the facility shown on the application and approved drawing(s), plans, and other documents attached hereto or on file with the department and made a part hereof and specifically described as follows:

The permittee can operate Six Paint Spray Booths located at the North Service area as follows:

<u>Name</u>	<u>Number</u>	<u>Description</u>
a. Metalizing Spray Booth ^{PFF-6-8-T-LH}	WDW 5	Binks Model WE-20-7-T
b. Lofting Bldg Spray Booth ✓	WDW 6	Binks Model PFA-20-12-T-LH
c. Paint Shop Spray Booth No. 4 ✓	WDW 11	Binks Model PFF-16-10-T-LH
d. Paint Shop Spray Booth No. 5 ✓	WDW 12	Binks Model PFF-16-10-T-LH
e. Character Head Spray Box	WDW 17	Binks Model PFA-6-8-T-LH
f. Artist's Preparation Shop Spray Booth	WDW 20	Binks Model PFF - 5-8-T-LH

Each Paint Spray Booth is equipped with Andraea Paint Arrestors to control Particulate Matter (PM) emissions.

These sources are located at the North Service Area at Facilities Way, Bay Lake, Orange County, Florida.

General Conditions are attached to be distributed to the permittee only.

PERMITTEE:
Walt Disney World Company

Attention: Bob Penn, Director
Environmental Affairs Division

I. D. Number:
Permit/Certification Number:
A048-183381
Date of Issue:
Expiration Date: October 25, 1995

GENERAL CONDITIONS:

16. No objectionable odors will be allowed, as per Rule 17-2.620(2), F.A.C.
17. All unconfined emissions of particulate matter generated at this site shall be adequately controlled. (Rule 17-2.610(3), F.A.C.) Area must be watered down should unconfined emissions occur.
18. This permit does not preclude compliance with any applicable local permitting requirements and regulations.

SPECIFIC CONDITIONS:

OPERATING CONDITIONS

1. Each source is permitted to operate 4160 hours/year.
2. The permitted materials and utilization rates are as stated in the applications except that these rates shall not cause the VOC emission rates to exceed the limits specified by specific condition No. 7 for WDW 11 and 12.
3. Each Paint Spray Booth should be properly operated and maintained (Rule 17-2.210(2) F.A.C.). No person shall circumvent any pollution control device or allow the emissions of air pollutants without the applicable air pollution control device operating properly (Rule 17-2.240 F.A.C.).
4. Visible emissions are not expected to exceed 5 percent opacity from a properly maintained and operated Paint Spray Booth equipped with Paint Arrestors.
5. Air velocity at the Paint Booth Filter Face shall not exceed 250 ft/min.
6. The maximum expected Volatile Organic Compound (VOC) emission rate for each source is as follows:

<u>Source</u>	<u>VOC Emission Rate (ton/year)</u>
a. WDW 5	2.54 METALLIZING
b. WDW 6	15.0 COATING SHOP
c. WDW 11	2.19 PE #4
d. WDW 12	2.19 PE #5
e. WDW 17	0.94 CHAM. BERTS
f. WDW 20	1.02 AIR-INTAKE PROP.

PERMITTEE:
Walt Disney World Company

Attention: Bob Penn, Director
Environmental Affairs Division

I. D. Number:
Permit/Certification Number:
AO48-183381
Date of Issue:
Expiration Date: **October 25, 1995**

EMISSION LIMITS

7. Regarding sources WDW 11 and WDW 12, to comply with RACT Rule 17-2.650(1)(c)F.A.C., the maximum permitted emission rate of VOC is 3 pounds per hour and 15 pounds per day from each source when painting miscellaneous metal parts and products with coatings which exceed the limits of Rule 17-2.650(1)(f)14,F.A.C. Should either of these VOC emission rates be exceeded under the specified circumstances, these sources may be subject to specific VOC emission limiting standards of RACT Rule 17-2.650(1)(f)14.b,F.A.C., and to control technology of RACT Rule 17-2.650(1)(f)14.c,F.A.C. Any exceedances of these rates shall be reported to the department immediately.
8. Rule 17-2.620(1)(a)FAC states that no person shall store, pump, handle, process, load, unload or use in any process or installation volatile organic compounds or organic solvents without applying known and existing vapor emission control devices or systems deemed necessary and ordered by the department. To comply, procedures to minimize pollutant emissions should include but shall not be limited to the following:
 - a) tightly cover or close all VOC containers when they are not in use,
 - b) tightly cover, where possible, all open troughs, basins, baths, tanks, etc. when they are not in use,
 - c) maintain all piping, valves, fittings, etc. in good operating condition,
 - d) prevent excessive air turbulence across exposed VOC's,
 - e) immediately confine and clean up VOC spills and make sure certain wastes are placed in closed containers for reuse, recycling or proper disposal, and
 - f) maintain a monthly accounting of each VOC based on beginning and ending inventories, deliveries, shipments, etc. for each source.
9. The visible emissions for each source must comply with Rule 17-2.610(2)F.A.C. and the compliance test must be conducted in accordance with Rule 17-2.700(6)(b)9, (DER Method #9) F.A.C.
10. Emissions within the building are not subject to regulation by this department, but for safety and health reasons, OSHA standards should be observed. Toluene emissions from the building should not cause ambient air concentrations to exceed the Acceptable Ambient Concentration (AAC) at ground level of 3.75 mg/m³, based on 80 hours/week of operation.

PERMITTEE:

Walt Disney World Company

Attention: Bob Penn, Director
Environmental Affairs Division

I. D. Number:

Permit/Certification Number:

A048-183381

Date of Issue:

Expiration Date: October 25, 1995

COMPLIANCE TESTING

11. Each source must be tested for visible emissions at yearly intervals from the date of April 17, 1990, in accordance with Rule 17-2.700(6)(b)9, (DER Method #9)F.A.C.
12. This office (Florida Department of Environmental Regulation, Air Permitting, Orlando) shall be notified at least fifteen (15) days in advance of the compliance tests so that we can witness them (Rule 17-2.700(2)(a)5, F.A.C.).
13. This plant is required to operate within 90 to 100 percent of permitted capacity during the compliance tests.
14. The required test report shall be filed with the department as soon as practical but no later than 45 days after the last sampling run of each test is completed (Rule 17-2.700(7)(a),(b) and (c), F.A.C).

REPORTS

15. Each calendar year on or before March 1, submit for each source, an Annual Operations Report DER Form 17-1.202(6) for the preceding calendar year in accordance with Rule 17-4.14, F.A.C.

EXPIRATION DATE

16. An operation permit renewal must be submitted at least 60 days prior to the expiration date of this permit (Rule 17-4.09, F.A.C.).

ISSUED

10-31-90STATE OF FLORIDA DEPARTMENT
OF ENVIRONMENTAL REGULATION

cmc

Alexander
A. Alexander
Deputy Assistant Secretary
3319 Maguire Boulevard
Suite 232
Orlando, Florida 32803
(407) 894-7555



Department of Environmental Protection

Lawton Chiles
Governor

Central District
3319 Maguire Boulevard, Suite 232
Orlando, Florida 32803-3767

Virginia B. Wetherell
Secretary

Walt Disney World Company
Post Office Box 10,000
Lake Buena Vista, Florida 32830-1000

Attention: Bob Penn, Director, Environmental Affairs

Orange County - AP
Seven Paint Spray Booths
Permit No. AO48-183381
Change of Conditions

Dear Mr. Penn:

We are in receipt of your request for a change of the permit conditions. The conditions are changed as follows:

<u>Condition</u>	<u>FROM</u>	<u>TO</u>
Permit Page No. 1	Project: Six Paint Spray Booths - North Service Area	Project: Seven Paint Spray Booths - North Service Area

<u>Condition</u>	<u>Add</u>
Permit Page No. 1	
g. Paint Shop Spray Booth No. 6	WDW 37 Model DB-1210-S

All other conditions remain the same.

This letter must be attached to your permit and becomes a part of that permit.

Sincerely,

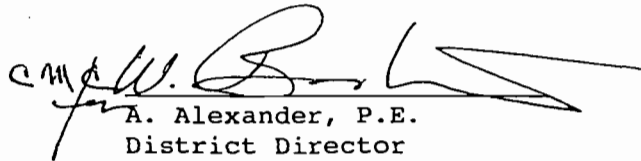
A. Alexander, P.E.
District Director

Date: 7/7/94

AA/jtt

Copies furnished to:



Department of Environmental Protection

Lawton Chiles
Governor

Central District
3319 Maguire Boulevard, Suite 232
Orlando, Florida 32803-3767

Virginia B. Wetherell
Secretary

Walt Disney World Company
Post Office Box 10,000
Lake Buena Vista, Florida 32830-1000

Attention: Bob Penn, Director, Environmental Affairs

Orange County - AP
Seven Paint Spray Booths
Permit No. AO48-183381
Change of Conditions

Dear Mr. Penn:

We are in receipt of your request for a change of the permit conditions. The conditions are changed as follows:

Condition

Specific Condition No. 6

FROM

<u>Source</u>	<u>VOC Emission Rate (ton/year)</u>
a. WDW 5	2.54
b. WDW 6	15.0
c. WDW 11	2.19
d. WDW 12	2.19
e. WDW 17	0.94
f. WDW 20	1.02

TO

<u>Source</u>	<u>VOC Emission Rate (ton/year)</u>
a. WDW 5	2.54
b. WDW 6	9.5
c. WDW 11	2.19
d. WDW 12	2.19
e. WDW 17	0.94
f. WDW 20	1.02
g. WDW 37	2.2

walt Disney World Company
permit No. A048-183381
Change of Conditions
Page Two

All other conditions remain the same.

This letter must be attached to your permit and becomes a part of that permit.

STATE OF FLORIDA DEPARTMENT
OF ENVIRONMENTAL PROTECTION

SUBMITTED BY:

Charles M Collins

Charles M. Collins, P.E.
Air Program Administrator

Sincerely,

Alexander

A. Alexander, P.E.
District Director

Date: 8/12/84

93
AA/jtt 97

Copies furnished to:

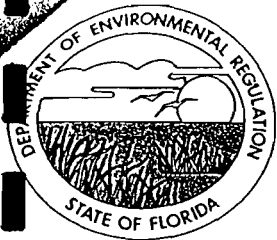

Florida Department of Environmental Regulation

Central District • 3319 Maguire Boulevard, Suite 232 • Orlando, Florida 32803-3767

Lawton Chiles, Governor

Carol M. Browner, Secretary

Permittee:
Walt Disney World Company
Post Office Box 10,000
Buena Vista, FL 32830-1000

Attention: Robert H. Penn, Director,
Environmental Affairs

I. D. Number:
Permit/Certification
Number: A048-192215
Date of Issue:
Expiration Date: September 25, 1996
County: Orange
Latitude/Longitude:
28°25'32"N/81°34'36"W
UTM: 17-443.51 KmE; 3144.22 KmN
Project: Central Shops Paint Mixing
Stations

This permit is issued under the provisions of Chapter(s) 403, Florida Statutes, and Florida Administrative Code Rule(s) 17-2. The above named permittee is hereby authorized to perform the work to operate the facility shown on the location and approved drawing(s), plans, and other documents attached hereto or on file with the Department and made a part hereof and specifically described as follows:

The permittee can operate the seven (7) Fellon-Pinchon Model 23-39-00 mixing stations.

This source is located at Facilities Way in Bay Lake, Orange County, Florida.

General Conditions are attached to be distributed to the permittee only.

PERMITTEE:
Walt Disney World Co.

Attention: Bob Penn, Director,
Environmental Affairs

I. D. Number:
Permit/Certification Number:
A048-192215
Date of Issue:
Expiration Date: September 25, 1996

SPECIFIC CONDITIONS

EMISSION LIMITS

1. The maximum allowable VOC emissions shall not exceed 0.13 lbs/hr and 0.17 tons/yr per booth. These emissions shall be verifiable on a 24-hour (daily) basis as required in specific condition No. 17.
2. Visible emissions shall not exceed 5% opacity.
3. Unless the Department has determined other concentrations are required to protect public health and safety, predicted ambient air impact of any toxic pollutant (as listed in the MSDS submitted with the application) shall not exceed the concentration calculated by the following formula:

$$AAC = \frac{OEL}{\text{Safety Factor}}$$

Where,

AAC = acceptable ambient concentration

Safety Factor = 50 for category B substances and 8 hrs/day
100 for category A substances and 8 hrs/day
210 for category B substances and 24 hrs/day
420 for category A substances and 24 hrs/day

OEL = Occupational exposure level such as ACGIH, OSHA and NIOSH published standards for toxic materials.

COMPLIANCE DETERMINATION

4. Compliance with the VOC standard shall be determined by EPA Method 24, Determination of Volatile Matter Content or manufacturer's specifications and materials balance. The aforementioned method is contained in 40 CFR 60, Appendix A (July 1, 1988), and is adopted by reference in Rule 17-2.700, F.A.C. Testing shall be conducted at yearly intervals from the date of January 31, 1991.

PERMITTEE:
Walt Disney World Co.

Attention: Bob Penn, Director,
Environmental Affairs

I. D. Number:
Permit/Certification Number:
A048-192215
Date of Issue:
Expiration Date: September 25, 1996

SPECIFIC CONDITIONS
(Continued)

5. Compliance with the visible emissions (V.E.) standard, shall be determined by EPA Method 9, Visual Determination of the Opacity of Emissions from Stationary Sources, which is described in 40 CFR 60, Appendix A (July 1, 1988). Testing shall be conducted at yearly intervals from the date of January 31, 1991.
6. The permittee shall notify the DER's Central District office in writing at least 15 days in advance of the compliance test. Compliance test run results shall be submitted to the District office not later than 45 days after the final run.
7. Compliance with the acceptable ambient concentrations shall be demonstrated based on calculations certified by a Professional Engineer registered in Florida using actual operating conditions. Determination of the ambient concentration for organic compounds shall be determined by Department approved dispersion modeling or the Dilution factor Matrix calculations.
8. When the department, after investigation, has good reason (such as complaints, increased visible emissions or questionable maintenance of control equipment) to believe that any applicable emission standard contained in Chapter 17-2, F.A.C. or in this permit is being violated, it may require the owner or operator of the source to conduct compliance tests which identify the nature and quantity of pollutant emissions from the source and to provide a report on the results of said tests to the department.
9. If any spills, leaks, releases, etc., occur; the DER Central District office shall be promptly notified.

OPERATING RATES

10. This source is allowed to operate 8 hrs/day, 6 days/wk, and 52 wks/yr.
11. The maximum material utilization rates are as stated in the application for the specific coatings and solvents which are to be used.

COMMITTEE:
Walt Disney World Co.

Attention: Bob Penn, Director,
Environmental Affairs

I. D. Number:
Permit/Certification Number:
A048-192215
Date of Issue:
Expiration Date: September 25, 1996

SPECIFIC CONDITIONS
(Continued)

12. Any change in the method of operation, raw materials, equipment or operating hours shall be submitted to DER's Central District office for approval.

RULE REQUIREMENTS

13. This source shall comply with all applicable provisions of Chapter 403, Florida Statutes, and Chapters 17-2 and 17-4, Florida Administrative Code.
14. Issuance of this permit does not relieve the facility owner or operator from compliance with any applicable federal, state, or local permitting requirements and regulations (F.A.C. Rule 17-2.210(1)).
15. According to F.A.C. Rule 17-2.620(1)(a), no person shall store, pump, handle, process, load, unload, or use in any process or installation volatile organic compounds or organic solvents without applying known and existing vapor emissions control devices or systems deemed necessary and ordered by the Department. Currently, there are no control strategies associated with this operation other than crew efficiency to minimize pollutant emissions. The following procedures shall be utilized to minimize pollutant emissions:
- maintain tightly fitting covers, lids, etc., on all containers of VOC when they are not being handled, tapped, etc.;
 - prevent excessive air turbulence across exposed VOCs; where possible and practical procure/fabricate a tightly fitting cover for any open trough, basin, bath, etc., of VOC so that it can be covered when not in use;
 - all fittings, valve lines, etc., shall be properly maintained; and,
 - all VOC spills shall be attended to immediately and the waste properly disposed of, recycled, etc.

Disney World Co.
Attention: Bob Penn, Director,
Environmental Affairs

I. D. Number:
Permit/Certification Number:
A048-192215
Date of Issue:
Expiration Date: September 25, 1996

SPECIFIC CONDITIONS
(Continued)

- 16. No person shall cause, suffer, allow, or permit the discharge of air pollutants which cause or contribute to an objectionable odor pursuant to F.A.C. Rule 17-2.620(2). Objectionable odor is defined as any odor present in the outdoor atmosphere which by itself or in combination with other odors, is or may be harmful or injurious to human health or welfare, which unreasonably interferes with the comfortable use and enjoyment of life or property, or which creates a nuisance pursuant to F.A.C. Rule 17-2.100(135).
- 17. Pursuant to F.A.C. 17-2.210(2) Air Operating Permits, the permittee is required to submit annual reports on the actual operating rates and emissions from this source. These reports shall include but are not limited to the following: utilization rates (lbs/yr), VOC and PM emissions (tons/yr, lbs/day, and lbs/hr), and annual hours of operation. Annual reports shall be sent to the Department's Central District office no later than March 1 of each year.

EXPIRATION DATE

- 18. An operation permit renewal must be submitted at least 60 days prior to the expiration date of this permit (Rule 17-4.09, F.A.C.).

ISSUED 10-14-96

STATE OF FLORIDA DEPARTMENT
OF ENVIRONMENTAL REGULATION

c.m.c. *Alexander*
A. Alexander, District Director
3319 Maguire Boulevard, Suite 232
Orlando, Florida 32803

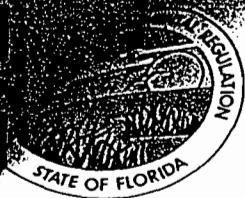

Florida Department of Environmental Regulation

Central District • 3319 Maguire Boulevard, Suite 232 • Orlando, Florida 32803-3767

Lawton Chiles, Governor

Carol M. Browner, Secretary

Permittee:
Walt Disney World
Post Office Box 10,000
Lake Buena Vista, FL 32830

Attention: Bob Penn,
Environmental Affairs Director

I. D. Number:
Permit/Certification
Number: A048-216580
Date of Issue:
Expiration Date: August 30, 1997
County: Orange
Latitude/Longitude:
28°25'29"N/81°34'31"W
UTM: 17-442.6 KmE; 3144.3 KmN
Project: Sand Blast Chamber No. 1

This permit is issued under the provisions of Chapter(s) 403, Florida Statutes, and Florida Administrative Code Rule(s) 17-2. The above named permittee is hereby authorized to perform the work or operate the facility shown on the application and approved drawing(s), plans, and other documents attached hereto or on file with the department and made a part hereof and specifically described as follows:

The permittee can operate a sand blast chamber No. 1. Particulate emissions are controlled with a baghouse manufactured by Carter-Day, Model 144-RJ-84 that has a collection efficiency of approximately 99.7 percent.

This source is located on Facilities Way, Bay Lake, Walt Disney World, Orange County, Florida.

General Conditions are attached to be distributed to the permittee only.

PERMITTEE:
Walt Disney World

Attention: Bob Penn, Environmental
Affairs Director

I. D. Number:
Permit/Certification Number:
A048-216580
Date of Issue:
Expiration Date: August 30, 1997

GENERAL CONDITIONS:

16. No objectionable odors will be allowed, as per Rule 17-2.620(2), F.A.C.
17. All unconfined emissions of particulate matter generated at this site shall be adequately controlled. (Rule 17-2.610(3), F.A.C.) Area must be watered down should unconfined emissions occur.
18. This permit does not preclude compliance with any applicable local permitting requirements and regulations.

SPECIFIC CONDITIONS:

OPERATING CONDITIONS

1. This source is permitted to operate 2600 hours/year.
2. The maximum permitted utilization rate of the Sand Blast Chamber is 6.25 pounds/hour of sand.
3. Each source must be properly operated and maintained (Rule 17-2.210(2) F.A.C.). No person shall circumvent any pollution control device or allow the emissions of air pollutants without the applicable air pollution control device operating properly (Rule 17-2.240 F.A.C.).

EMISSION LIMITS

4. The visible emissions for this source must comply with Rule 17-2.610(2)F.A.C. (20% opacity limit) and the compliance test must be conducted in accordance with Rule 17-2.700(6)(b)9, (DER Method #9) F.A.C.

COMPLIANCE TESTING

5. The source must be tested for visible emissions at yearly intervals from the date of May 5, 1992, in accordance with Rule 17-2.700(6)(b)9, (DER Method #9)F.A.C.

PERMITTEE:
Walt Disney World

Attention: Bob Penn, Environmental
Affairs Director

I. D. Number:
Permit/Certification Number:
A048-216580
Date of Issue:
Expiration Date: August 30, 1997

SPECIFIC CONDITIONS:
(Continued)

6. This office (Florida Department of Environmental Regulation, Air Permitting, Orlando) shall be notified in writing at least fifteen (15) days in advance of the compliance tests so that we can witness them (Rule 17-2.700(2)(a)5, F.A.C.).
7. This plant is required to operate within 90 to 100 percent of permitted capacity during the compliance tests.
8. The required test report shall be filed with the department as soon as practical but no later than 45 days after the last sampling run of each test is completed (Rule 17-2.700(7)(a),(b) and (c), F.A.C.).
9. Each calendar year on or before March 1, submit for each source, an Annual Operations Report DER Form 17-1.202(6) for the preceding calendar year.

EXPIRATION DATE

10. An operation permit renewal must be submitted at least 60 days prior to the expiration date of this permit (Rule 17-4.09, F.A.C.).

ISSUED 10-6-82

STATE OF FLORIDA DEPARTMENT
OF ENVIRONMENTAL REGULATION

Cmc

Alexander
A. Alexander, District Director
3319 Maguire Boulevard, Suite 232
Orlando, Florida 32803



Florida Department of Environmental Regulation

Central District • 3319 Maguire Boulevard, Suite 232 • Orlando, Florida 32803-3767 • 407-894-7555

Bob Martinez, Governor

Dale Twachtmann, Secretary

John Shearer, Assistant Secretary
Alex Alexander, Deputy Assistant Secretary

Permittee:
Reedy Creek Improvement District
P.O. Box 36
Lake Buena Vista, FL 32830

Attention: Thomas M. Moses
Director/ General Manager

I. D. Number:
Permit/Certification
Number: A048-170280
Date of Issue:
Expiration Date: 12/15/94
County: Orange
Latitude/Longitude:
28°25'34"N/81°34'48"W
UTM: 17-442.0 KmE; 3139.0 KmN
Project: Gas Fired Turbine
Generator with Heat Recovery
System

This permit is issued under the provisions of Chapter(s) 403, Florida Statutes, and Florida Administrative Code Rule(s) 17-2. The above named permittee is hereby authorized to perform the work or operate the facility shown on the application and approved drawing(s), plans, and other documents attached hereto or on file with the department and made a part hereof and specifically described as follows:

The permittee can operate a 30.8 MW GE LM5000 gas fired turbine generator system with a heat input capacity of 345 MMBTU/hr. The project includes an in-line duct burner, heat recovery boiler and steam turbine, at the Central Energy Plant. This source is located at Bay Lake, near Lake Buena Vista, Orange County, Florida.

General Conditions are attached to be distributed to the permittee only.

PERMITTEE:
 Reedy Creek Improvement District
 Attention: Thomas M. Moses
 Director/General Manager

I. D. Number:
 Permit/Certification Number:
 AO48-170280
 Date of Issue:
 Expiration Date: 12/15/94

SPECIFIC CONDITIONS:

1. The turbine may operate continuously (8760 hrs/yr).
2. Only natural gas shall be fired in the turbine and duct burner. No. 2 oil shall be used in periods of curtailed natural gas supply. The duration of oil firing shall not exceed 14 days annually.
3. The maximum heat input to the turbine and the duct burner combined shall not exceed 345 MMBTU/hr. (normal duct burner heat input rate of 23 MMBTU/hr).
4. When the gas turbine is not in operation, the duct burner heat input may be increased up to, but not to exceed, 198 MMBTU/hr.
5. The emissions, from the turbine and duct burner combined, shall not exceed:

<u>Pollutant</u>	<u>Gas Fired</u>		<u>Oil Fired¹</u>	
	<u>lb/hr.</u>	<u>TPY*</u>	<u>lb/hr.</u>	<u>TPY</u>
Nitrogen Oxides (NOX) peak @ 40°F	112		132	
	average 77	337	100	17
Sulfur Dioxide (SO ₂)	0.2	0.8	118	20
Particulates (PM)	0.8	3.5	9	2
Carbon Monoxide (CO)	11	48	24	4
Volatile Organics (VOCs)	6	26	6	1
Visible Emissions (VE)	5% opacity		10% opacity	
NOx, at 15% O ₂ dry basis	peak	74 ppmv	82 ppmv ²	
	Average	58 ppmv	68 ppmv	
SO ₂ , at 15% oxygen dry basis	-		58 ppmv	

*TPY (tons per year)

- 1 Oil will be fired only when there is natural gas curtailment. It will be fired for no more than 14 days annually.
- 2 Variation in concentration with variation in ambient air temperature documented by a plot of pollutant concentration versus ambient temperature, as per initial compliance test results.

PERMITTEE:
Reedy Creek Improvement District

Attention: Thomas M. Moses
Director/General Manager

I. D. Number:
Permit/Certification Number:
AO48-170280
Date of Issue:
Expiration Date: 12/15/94

SPECIFIC CONDITIONS:

The average emissions will be calculated using hourly logged averages to obtain a 30 day average and then using 12 consecutive 30 day averages to obtain an annual average. The DER District Office may alter this averaging method after due consideration of alternative compliance plans.

The duct burner NOx emissions shall not exceed (corresponding to 0.2 lb/MMBTU) 4.6 lb/hr for gas or oil at 23 MMBTU heat input or 40 lbs/hr. for gas or oil at 198 MMBTU/hr.

6. The No. 2 oil sulfur content shall not exceed 0.4 percent.
7. The "Black Start" Cummins No. 2 oil fired emergency generator, when fired on a normal basis to maintain a state of readiness, shall not be operated beyond the 10 minutes/week check out period.

For inventory purposes only, the emergency generator's expected emissions are listed below:

<u>Pollutant</u>	<u>lbs/year</u>
NOx	232
CO	36
VOC	9
PM	8
SO ₂	30

8. Water injection shall be utilized for NOx control at a minimum of 0.55 water to fuel ratio. If compliance testing warrants this ratio to be re-investigated, the ratio at which compliance is maintained shall be incorporated into the permit.
9. Annual compliance testing conducted annually from the date of February 1, 1989 shall be conducted with the fuels used in the preceding 12 months period using:
 1. EPA Method 20 for NOx and SO₂
 2. EPA Method 10 for CO
 3. EPA Method 5 for PM
 4. EPA Method 9 for VE

Other DER approved methods may be used for compliance testing only after prior Departmental approval.

PERMITTEE:
Reedy Creek Improvement District

Attention: Thomas M. Moses
Director/General Manager

I. D. Number:
Permit/Certification Number:
A048-170280
Date of Issue:
Expiration Date: 12/15/94

SPECIFIC CONDITIONS:

10. The project shall comply with all the applicable requirements of:
 - a. Chapter 17-2, FAC
 - b. 40 CFR 60, Subpart GG, Gas Turbines
 - c. 40 CFR 60, Subpart Db, Industrial Steam Generating Units.
11. DER's District Office shall be notified in writing 15 days prior to source testing. Written reports of the tests shall be submitted to the district office within 45 days of test completion.
12. Any change in the method of operation, fuels, equipment or operating hours shall be submitted for approval to DER's District Office.
13. Each calendar year on or before March 1, submit for each source, an Annual Operations Report DER Form 17-1.202(6) for the preceding calendar year in accordance with Rule 17-4.14, F.A.C.
14. An operation permit renewal must be submitted at least 60 days prior to the expiration date of this permit (Rule 17-4.09, F.A.C.).

ISSUED 1-3-9

STATE OF FLORIDA DEPARTMENT
OF ENVIRONMENTAL REGULATION

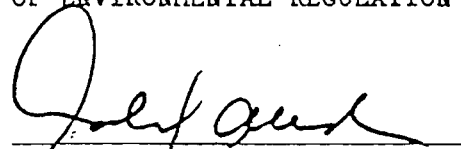
10/8

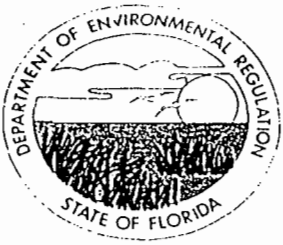
A. Alexander
Deputy Assistant Secretary
3319 Maguire Boulevard
Suite 232
Orlando, Florida 32803



Florida Department of Environmental Regulation

Central District • 3319 Maguire Boulevard, Suite 232 • Orlando, Florida 32803-3767 • 407-894-7555

Bob Martinez, Governor

Dale Twachtman, Secretary

John Shearer, Assistant Secretary
Alex Alexander, Deputy Assistant Secretary

Permittee:
Reedy Creek Energy Services, Inc.
P.O. Box 10,000
Lake Buena Vista, Florida 32830

Attention: H. Robert Kohl,
Director of Operations

I.D. Number:
Permit/Certification
Number: AO48-186868
Date of Issue:
Expiration Date: 12/30/95
County: Orange
Latitude/Longitude:
28°26'00"N/81°35'00"W
UTM: 17-443.1 KmE; 3144.3 KmN
Project: Hot Water Generator
No. 3 (Central Energy
Plant)

This permit is issued under the provisions of Chapter (s) 403, Florida Statutes, and Florida Administrative Code Rule(s) 17-2. The above named permittee is hereby authorized to perform the work or operate the facility shown on the application and approved drawing(s), plans, and other documents attached hereto, or on file with the department and made a part hereof and specifically described as follows:

The permittee can operate Hot Water Generator No. 3 rated at 116.5 MMBTU/hr maximum heat input rate fired by Natural Gas and No. 2 Fuel Oil only.

This source is located at the Central Energy Plant at 5300 North Center Drive at Lake Buena Vista, Orange Co., Florida.

General Conditions are attached to be distributed to the permittee only.

PERMITTEE:
Reedy Creek Energy Services, Inc.

Attention: H. Robert Kohl,
Director of Operations

I.D. Number:
Permit/Certification Number:
AO48-186868
Date of Issue:
Expiration Date: 12/30/95

GENERAL CONDITIONS:

16. No objectionable odors will be allowed, as per Rule 17-2.620(2), F.A.C.
17. This permit does not preclude compliance with any applicable local permitting requirements and regulations.

SPECIFIC CONDITIONS:

OPERATING CONDITIONS

1. This source is permitted to operate 8760 hours/year.
2. This source will be fired with Natural Gas or No. 2 Fuel Oil only.
3. The permitted heat input rate for this source is 116.5 MMBTU/hr.

EMISSION LIMITS

4. The visible emissions for this Hot Water Generator must comply with Rule 17-2.610(2) F.A.C. and the compliance test must be conducted in accordance with Rule 17-2.700(6)(b)9, (DER Method #9) F.A.C.

COMPLIANCE TESTING

5. The source must be tested for visible emissions at yearly intervals from the date of January 10, 1990, in accordance with Rule 17-2.700(6)(a)9, (DER Method 9) F.A.C.
6. This office (Florida Department of Environmental Regulation, Air Permitting, Orlando) shall be notified at least fifteen (15) days in advance of the compliance tests so that we can witness them (Rule 17-2.700(2)(a)5, F.A.C.).
7. This plant is required to operate within 90 - 100 percent of permitted capacity during the compliance tests.
8. The required test report shall be filed with the department as soon as practical but no later than 45 days after the last sampling run of each test is completed (Rule 17-2.700(7)(a),(b) and (c), F.A.C.).
9. The source may be tested on natural gas unless the source has been fired by fuel oil for more than 8 hours/week or 400 hours during the previous year.

PERMITTEE:
Reedy Creek Energy Services, Inc.

Attention: H. Robert Kohl,
Director of Operations

I.D. Number:
Permit/Certification Number:
AO48-186868
Date of Issue:
Expiration Date: 12/30/95

10. Each calendar year on or before March 1, submit for each source, an Annual Operations Report DER Form 17-1.202(6) for the preceding calendar year in accordance with Rule 17-4.14, F.A.C.

EXPIRATION DATE

11. An operation permit renewal must be submitted at least 60 days prior to the expiration date of this permit (Rule 17-4.09, F.A.C.).

ISSUED 1-18-87

STATE OF FLORIDA DEPARTMENT
OF ENVIRONMENTAL REGULATION

cmc Alexander
A. Alexander
Deputy Assistant Secretary
3319 Maguire Boulevard
Suite 232
Orlando, Florida -32803



Florida Department of Environmental Regulation

Central District • 3319 Maguire Boulevard, Suite 232 • Orlando, Florida 32803-3767

Lawton Chiles, Governor

Carol M. Browner, Secretary

Reedy Creek Improvement District
Post Office Box 36
Lake Buena Vista, Florida 32830

Attention: Thomas M. Moses, District Administrator

Orange County - AP
GE Gas Fired Turbine Generator with Heat Recovery System
Permit No. AO48-170280
Change of Conditions

Dear Mr. Moses:

We are in receipt of your request for a change of the permit conditions.
The conditions are changed as follows:

CONDITION

Permit Specific Condition No. 9

FROM:

9. Annual compliance testing conducted annually from the date of February 1, 1989 shall be conducted with the fuels used in the preceding 12 month period using:

1. EPA Method 20 for NO_x and SO₂
2. EPA Method 10 for CO
3. EPA Method 5 for PM
4. EPA Method 9 for VE

Other DER approved methods may be used for compliance testing only after prior Departmental approval.

TO:

9. Annual compliance testing conducted annually from the date of February 1, 1989 shall be conducted with the fuels used in the preceding 12 month period using:

1. EPA Method 20 for NO_x and SO₂
2. EPA Method 10 for CO
3. EPA Method 17 for PM
4. EPA Method 9 for VE

Other DER approved methods may be used for compliance testing only after prior Departmental written approval.

All other conditions remain the same.

This letter must be attached to your permit and becomes a part of that permit.

Sincerely,

c.m.c. Richard B. John

for A. Alexander, P.E.
Deputy Assistant Secretary

2/15/91

Date

AB
AA:jtj *JD*



Florida Department of Environmental Regulation

Central District • 3319 Maguire Boulevard, Suite 232 • Orlando, Florida 32803-3767

Lawton Chiles, Governor

Carol M. Browner, Secretary

Reedy Creek Improvement District
Post Office Box 10,170
Lake Buena Vista, Florida 32830-0170

Attention: Thomas M. Moses, District Administrator

Orange County - AP
GE Gas Fired Turbine Generator
with Heat Recovery System
Permit No. A048-170280
Change of Conditions

Dear Mr. Moses:

We are in receipt of your request for a change of the permit conditions. The permit conditions are changed as follows:

Specific Condition No. 5

The only change affects sulfur dioxide (SO₂) under "Gas Fired", in which the maximum allowable emissions limit is changed from 0.2 lb/hr and 0.8 TPY to 1.2 lbs/hr and 5.1 TPY.

All other conditions remain the same.

This letter must be attached to your permit and becomes a part of that permit.

Sincerely,

Alexander
A. Alexander, District Director

8-13-81
Date

AA
AA/jtt

Copies to:

Edward Godwin, P.E.

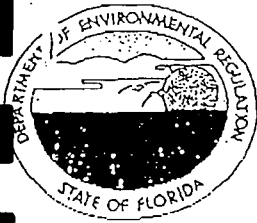

Florida Department of Environmental Regulation

Twin Towers Office Bldg. • 2600 Blair Stone Road • Tallahassee, Florida 32399-2400

Lawton Chiles, Governor

Carol M. Browner, Secretary

✓
file

January 7, 1993

1/15-cc B. Pann
B. Kohl
D. Widenbeck

CERTIFIED MAIL - RETURN RECEIPT REQUESTED

Mr. Thomas M. Moses
District Administrator
Reedy Creek Improvement District
Post Office Box 10170
Lake Buena Vista, Florida 32830-0170

Re: Request for Amendment of Permit No. AC48-137740, PSD-FL-123

This is in reply to your letters dated September 22 and October 9, 1992, requesting amendment of the subject permit to (1) avoid the continuous emission monitoring requirement of Subpart Db, (2) include a limit on total annual hours for fuel oil firing, and (3) convert the weekly time limit on diesel generator operation to an annual time limit.

Item (1) above will not require an amendment for the following reason. Since 40 CFR 60, Subpart Db, Section 60.48b(h) provides an exemption from the continuous emission monitoring (CEM) requirement for the primary operation mode (i.e., turbine firing), the Department will not consider the "duct burner only" operation as a "stand alone boiler" but rather as a temporary operation mode of the combined cycle system wherein the turbine is unfired. Therefore, the Subpart Db CEM exemption will still apply when the facility must be operated without firing the turbine. No amendment is needed as long as the primary operation mode requires turbine firing.

Items (2) and (3) above will be amended since the permit language should be clarified. Therefore, specific conditions 2, 5, and 7 are amended as shown below.

Specific Condition No. 2

Present:

Only natural gas shall be fired in the turbine and duct burner. No. 2 fuel oil shall be used in periods of curtailed natural gas supply. The duration of oil firing shall not exceed 14 days annually.

Mr. Thomas M. Moses
Reedy Creek Improvement District
Page 2

Amended:

Natural gas shall be the primary fuel fired in the turbine and duct burner system. No. 2 fuel oil can be used as a backup fuel for up to 14 days per year.

Specific Condition No. 5 (Footnote 1)

Present:

Oil will be fired only when there is natural gas curtailment. It will be fired for no more than 14 days annually.

Amended:

Fuel oil firing shall be limited to 14 days per year.

Specific Condition No. 7

Present:

The "Black Start" Cummins No. 2 oil fired emergency generator, when fired on a normal basis to maintain a state of readiness shall not be operated beyond the 10 minutes/week check out period.

Amended:

The "Black Start" Cummins No. 2 oil fired emergency generator, when fired on a normal basis to maintain a state of readiness, shall not be operated for more than 9 hours per year.

This letter shall become an attachment of construction permit No. AC48-137740 (PSD-FL-123).

Sincerely,

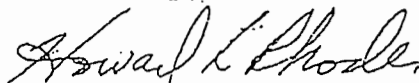

Howard L. Rhodes, P.E.
Director
Division of Air Resources
Management

HR/JR/w

cc: A. Zahm, CD
J. Harper, EPA

H. Culp, P.E.
J. Bunyak, NPS



Florida Department of Environmental Protection

*File
RCID/DEP*

Lawton Chiles
Governor

Twin Towers Office Building
2600 Blair Stone Road
Tallahassee, Florida 32399-2400

Virginia B. Wetherell
Secretary

October 29, 1993

CERTIFIED MAIL - RETURN RECEIPT REQUESTED

Mr. Thomas M. Moses
District Administrator
Reedy Creek Improvement District
P. O. Box 10170
Lake Buena Vista, Florida 32830-0170

Dear Mr. Moses:

RE: Reedy Creek Improvement District (RCID)
Gas Turbine Generator and Heat Recovery Steam Generator with
Duct Burner
Orange County - Permit No. AC48-137740 (AO48-170280)
PSD-FL-123

The Department is in receipt of your letter dated September 29, 1993, on behalf of the above mentioned facility, requesting a permit amendment to change the continuous opacity monitoring requirement for the Heat Recovery Steam Generator (HRSG). RCID proposes to disconnect the fuel oil lines from the HRSG, thereby rendering it incapable of firing fuel oil and eliminating the requirement for a continuous opacity monitor system. The Department has considered your request and has agreed to amend the permit as proposed in your letter. This permit will be amended to include the following:

SPECIFIC CONDITION NO. 2:

FROM:

Only natural gas shall be fired in the turbine and duct burner. No. 2 oil shall be used in periods of curtailed natural gas supply. The duration of oil firing shall not exceed 14 days annually.

TO:

Natural gas shall be the primary fuel fired in the turbines and duct burner system. No. 2 fuel oil can be used as a backup fuel in the turbine only for up to 14 days per year.

Mr. Thomas M. Moses
October 29, 1993
Page Two

SPECIFIC CONDITION NO. 5:

FROM:

The duct burner NO_x emissions shall not exceed (corresponding to 0.2 lb/MMBtu) 4.6 lb/hr for gas or oil at 23 MMBtu input or 40 lbs/hr for gas or oil at 198 Btu/hr.

TO:

The duct burner NO_x emissions shall not exceed (corresponding to 0.2 lb/MMBtu) 4.6 lb/hr for gas at 23 MMBtu heat input or 40 lbs/hr for gas at 198 MMBtu/hr.

SPECIFIC CONDITION NO. 10(c)

FROM:

The project shall comply with all the applicable requirements of:

- a. Chapter 17-2, FAC.
- b. 40 CFR 60, Subpart GG, Gas Turbines.
- c. 40 CFR 60, Subpart Db, Industrial Steam Generating Units.

TO:

The project shall comply with all the applicable requirements of:

- a. Chapter 17-2, FAC.
- b. 40 CFR 60, Subpart GG, Gas Turbines.

If you have any questions, please contact Teresa Heron at (904) 488-1344 or write to me at the above address.

Sincerely,

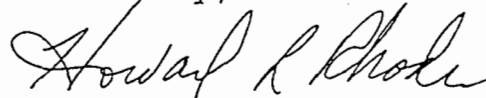

Howard L. Rhodes
Director
Division of Air Resources
Management

HLR/TH/bjb

cc: Alex Alexander



Lawton Chiles
Governor

Florida Department of Environmental Protection

Central District
3319 Maguire Boulevard, Suite 232
Orlando, Florida 32803-3767

Virginia B. Wetherell
Secretary

Reedy Creek Improvement District
Post Office Box 10170
Lake Buena Vista, Florida 32830-0170

Attention: Thomas M. Moses, District Administrator

Orange County - AP
GE Gas Fired Turbine Generator with Heat Recovery System
Permit No. AO48-170280
Change of Conditions

Dear Mr. Moses:

We are in receipt of your request for a change of the permit conditions. The permit conditions are changed as follows:

Specific Condition No. 2

From

"Natural gas shall be the primary fuel fired in the turbine and duct burner system. No. 2 fuel oil can be used as a backup fuel for up to 14 days per year".

To

"Natural gas shall be the primary fuel fired in the turbines and duct burner system. No. 2 fuel oil can be used as a backup fuel in the turbine only for up to 14 days per year".

Specific Condition No. 5

From

"The duct burner NO_x emissions shall not exceed (corresponding to 0.2lb/MMBtu) 4.6 lb/hr for gas or oil at 23MMBtu heat input or 40lb/hr for gas or oil at 198MMBtu/hr."

To

"The duct burner NO_x emissions shall not exceed (corresponding to 0.2 lb/MMBtu) 4.6 lb/hr for gas at 23MMBtu heat input or 40lb/hr for gas at 198MMBtu/hr."

Specific Condition No. 10c

From

"The project shall comply with all the applicable requirements of:

- a. Chapter 17-2. FAC
- b. 40 CFR 60, Subpart GG, Gas Turbines
- c. 40 CFR 60, Subpart Db, Industrial Steam Generating Units"

To

"The project shall comply with all the applicable requirements of:

- a. Chapter 17-200 series, F.A.C.
- b. 40 CFR 60, Subpart GG, Gas Turbines"

All other conditions remain the same.

This letter must be attached to your permit and becomes a part of that permit.

Sincerely

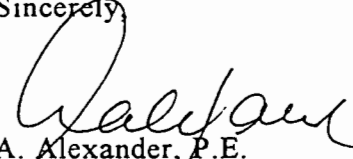
cm 
A. Alexander, P.E.
District Director

Date 12/15/93

AA/lbl



Florida Department of Environmental Protection

Lawton Chiles
Governor

Central District
3319 Maguire Boulevard, Suite 232
Orlando, Florida 32803-3767

Virginia B. Wetherell
Secretary

Reedy Creek Improvement District
Post Office Box 10170
Lake Buena Vista, Florida 32830-1170

Attention: Thomas M. Moses, District Administrator

Orange County - AP
GE Gas Fired Generator with Heat Recovery System
Permit No. AO48-170280
Change of Conditions

Dear Mr. Moses:

We are in receipt of your request for a change of the permit conditions. The conditions are changed as follows:

Condition

Specific Condition #3

From

3. The maximum heat input to the turbine and the duct burner combined shall not exceed 345 MMBtu/hr. (Normal duct burner heat input rate of 23 MMBtu/hr).

To

3. Testing of emissions should be conducted with the source operating at 90% to 100% of design capacity. The source may be tested at less than 90% of design capacity; however subsequent source operation is limited to 110% of the tested rate until a new test is conducted and approved by the Department in writing. Once the unit is so limited, operation at higher capacities not to exceed 450 MMBtu/hr is allowed for a cumulative total of no more than 15 successive calendar days for purposes of additional compliance testing to regain permitted capacity, with prior notification to the Department [Rule 17-4.070(3), F.A.C.].

Reedy Creek Improvement District
Permit No. AO48-170280
Change of Conditions
Page Two

All other conditions remain the same.

This letter must be attached to your permit and becomes a part of that permit.

Sincerely,

cmc 
A. Alexander, P.E.
District Director

Date 2-14-14

AA

AA/azt

Copies furnished to:



Department of Environmental Protection

Lawton Chiles
Governor

Central District
3319 Maguire Boulevard, Suite 232
Orlando, Florida 32803-3767

Virginia B. Wetherell
Secretary

Reedy Creek Improvement District
Post Office Box 10170
Lake Buena Vista, Florida 32830-1170

Attention: Thomas M. Moses, District Administrator

Orange County - AP
GE Gas Fired Generator with Heat Recovery System
Permit No. AO48-170280
Chance of Conditions

Dear Mr. Moses:

We are in receipt of your request for a change of the permit conditions. The conditions are changed as follows:

Condition

Specific Condition No. 10

From

10. The project shall comply with all the applicable requirements of:
- a. Chapter 17-200 series, F.A.C.
 - b. 40 CFR 60, Subpart GG, Gas Turbines"

To

10. The project shall comply with all the applicable requirements of:
- a. Chapters 62-209 through 62-297, F.A.C.
 - b. 40 CFR, Subpart GG, Standards of Performance for Stationary Gas Turbines.
 - c. 40 CFR, Subpart Db, Standards of Performance for Industrial-Commercial-Institutional Steam Generating Units.

In accordance with Rule 62-213.420(3), F.A.C., Standard Application Form and Required Information, the permittee is required to include all applicable requirements as defined in Rule 62-213.100(7), F.A.C., for each emission unit at this facility when applying for a Title V operating permit.

Condition

Specific Condition No. 15

Add

15. The following custom fuel monitoring schedule shall be used at this facility:

Custom Fuel Monitoring Schedule for Natural Gas

- 1) Monitoring of fuel nitrogen content shall not be required while natural gas is the only fuel being fired in the gas turbines.
- 2) Sulfur Monitoring
 - a) Analysis for sulfur content of the natural gas shall be conducted using one of the approved ASTM reference methods for the measurement of sulfur in gaseous fuels, or an approved alternative method. The approved methods are ASTM D1072-80, ASTM D3030-81, ASTM D3246-81, and ASTM D4084-82 as referenced in 40 CFR 60.335(b)(2).
 - b) This custom fuel monitoring schedule shall become effective on the date this amendment becomes valid. Effective the date of this custom schedule, sulfur monitoring shall be conducted at least once per calendar quarter. Sulfur analyses results shall be reported in units of grains of sulfur per 100 cubic feet of natural gas and shall be submitted with the quarterly excess emissions report required by 40 CFR 60.7. (EPA's letter dated June 15, 1994).
 - c) The sulfur content of the fuel shall also be expressed as maximum sulfur dioxide emissions (lb/hr) and shall be consistent with the limits specified in Specific Condition 5 of permit AC48-137740.
 - d) Should any sulfur analysis as required in items 2 (b) above indicate noncompliance with 40 CFR 60.333, the owner or operator shall notify the Department of such excess emissions and the custom schedule shall be re-examined. Sulfur monitoring shall be conducted weekly during the interim period when this custom schedule is being re-examined.
- 3) If there is a change in fuel supply, the owner or operator must notify the Department of such change for re-examination of this custom schedule. A substantial change in fuel quality shall be considered as a change in fuel supply. Sulfur monitoring shall be conducted weekly during the interim period when this custom schedule is being re-examined.
- 4) Records of sample analysis and fuel supply pertinent to this custom schedule shall be retained for a period of three years, and be available for inspection by personnel of federal, state, and local air pollution control agencies.

Reedy Creek Improvement District
Permit No. AO48-170280
Change of Conditions
Page Three

Custom Fuel Monitoring Schedule for Liquid Fuel

- 1) Sulfur and nitrogen content of the liquid fuel:

Upon delivery of the fuel, a sample shall be randomly taken from one compartment of each truck and composited for analysis (for verification of the vendor data) by a third party laboratory using ASTM Method D-3228 for nitrogen analysis, and ASTM Method D-4294 for sulfur analyses.

All other conditions remain the same.

This letter must be attached to your permit and becomes a part of that permit.

STATE OF FLORIDA DEPARTMENT
OF ENVIRONMENTAL PROTECTION

CMC 

William M. Bostwick, Jr., P.E.
Acting District Director

DATE: 2/27/95

WMB/jtt

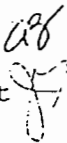
WMB



Department of Environmental Protection

Lawton Chiles
Governor

Twin Towers Office Building
2600 Blair Stone Road
Tallahassee, Florida 32399-2400

Virginia B. Wetherell
Secretary

March 30, 1995

CERTIFIED MAIL- RETURN RECEIPT REQUESTED

Mr. Thomas M. Moses
District Administrator
Reedy Creek Improvement District
Post Office Box 10170
Lake Buena Vista, Florida 32830-0170

Dear Mr. Moses:

RE: Reedy Creek Improvement District (RCID)
GE Gas Turbine with Heat Recovery Steam Generator
PSD-FL-123, AC48-137740

The Department is in receipt of your letter dated February 1, 1995, requesting revisions and deletions of several conditions of the above mentioned permit. The Department considered your request and agreed to revise your permit as proposed in your letter.

The revisions of the specific conditions of the permit are finalized as follows:

SPECIFIC CONDITION No. 7

FROM:

Initial and annual compliance testing shall be conducted with the fuels used in the preceding 12 month period using:

1. EPA Method 20 for NOx and SO2
2. EPA Method 10 for CO
3. EPA Method 5 for PM
4. EPA Method 9 for VE

Other DER approved methods may be used for compliance testing only after prior Department approval.

TO:

Pursuant to Rule 62-297.340, F.A.C., Frequency of Compliance Tests, initial and annual compliance testing shall be conducted with the fuels used in the preceding 12 month period using:

Mr. Thomas M. Moses
March 30, 1995
Page Two

1. EPA Method 20 for NOx and SO2
2. EPA Method 10 for CO
3. EPA Method 9 for VE

Other DEP approved methods may be used for compliance testing only after prior Department approval.

SPECIFIC CONDITION No.7

FROM:

The Black Start Cumming No. 2 oil fired emergency generator, when fired on a normal basis to maintain a state of readiness shall not be operated beyond the 10 minutes/week check out period.

For inventory purposes only, the emergency generator's expected emissions are listed below:

POLLUTANT	lb/yr
NOx	232
CO	36
VOC	9
PM	8
SO2	30

TO:

Pursuant to Rule 62-210.300(3)(u) F.A.C., this condition will be deleted.

It should be noted that pursuant to Rule 62-210.300(3), F.A.C., this source, although exempt from permitting requirements of Chapter 62-210 and Chapter 62-4, F.A.C., is subject to any applicable emission standard specified in Rule 62-252.300, and 62-296, F.A.C., other than Best Available Control Technology (BACT) or Lowest Achievable Emission Rate (LAER) requirements.

Furthermore, pursuant to Rule 62-213.420(3)(m), F.A.C., this source, although currently exempt from permitting, is required to be included in the Title V operation permit application.

A person whose substantial interests are affected by the Department's proposed permitting decision may petition for an administrative proceeding (hearing) in accordance with Section 120.57, Florida Statutes (F.S.). The petition must contain the

Mr. Thomas M. Moses
March 30, 1995
Page Three

information set forth below and must be filed (received) in the Office of General Counsel of the Department at 2600 Blair Stone Road, Tallahassee, Florida 32399-2400. Petitions filed by the applicant of the amendment request/application and the parties listed below must be filed within 14 days of receipt of this amendment. Petitions filed by other persons must be filed within 14 days of the amendment issuance or within 14 days of their receipt of this amendment, whichever occurs first. Petitioner shall mail a copy of the petition to the applicant at the address indicated above at the time of filing. Failure to file a petition within this time period shall constitute a waiver of any right such person may have to request an administrative determination (hearing) under Section 120.57, F.S.

The Petition shall contain the following information:

- (a) The name, address and telephone number of each petitioner, the applicant's name and address, the Department Permit File Number and the county in which the project is proposed;
- (b) A statement of how and when each petitioner received notice of the Department's action or proposed action;
- (c) A statement of how each petitioner's substantial interests are affected by the Department's action or proposed action;
- (d) A statement of the material facts disputed by Petitioner, if any;
- (e) A statement of facts which petitioner contends warrant reversal or modification of the Department's action or proposed action;
- (f) A statement of which rules or statutes petitioner contends require reversal or modification of the Department's action or proposed action; and,
- (g) A statement of the relief sought by petitioner, stating precisely the action the petitioner wants the Department to take with respect to the Department's action or proposed action.

If a petition is filed, the administrative hearing process is designed to formulate agency action. Accordingly, the Department's final action may be different from the position taken by it in this amendment. Persons whose substantial interests will be affected by any decision of the Department with regard to the amendment request/application have the right to petition to become a party to the proceeding. The petition must conform to the requirements specified above and be filed (received) within 14 days of receipt of this amendment in the Office of General Counsel at the above address of the Department. Failure to petition within the allowed time frame constitutes a waiver of any right

Mr. Thomas M. Moses
March 30, 1995
Page Four

such person has to request a hearing under Section 120.57, F.S., and to participate as a party to this proceeding. Any subsequent intervention will only be at the approval of the presiding officer upon motion filed pursuant to Rule 28-5.207, Florida Administrative Code.

A copy of this letter shall be filed with the construction permit, Nos. AC48-137740 and PSD-FL-123, and shall become a part of the permit.

Sincerely,

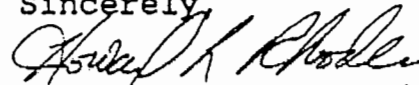

Howard L. Rhodes, Director
Division of Air Resources
Management

HLR/th/t

Enclosure:

Mr. T.M. Moses' letter dated February 1, 1995

cc: Charles Collins
Jewell Harper, EPA

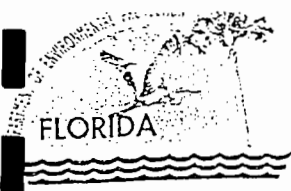

BEST AVAILABLE COPY
Department of
Environmental Protection

Lawton Chiles
Governor

Twin Towers Office Building
2600 Blair Stone Road
Tallahassee, Florida 32399-2400

Virginia B. Wethers
Secretary

June 16, 1995

CERTIFIED MAIL- RETURN RECEIPT REQUESTED

Mr. Thomas M. Moses
District Administrator
Reedy Creek Improvement District
Post Office Box 10170
Lake Buena Vista, Florida 32830-0170

Dear Mr. Moses:

RE: Reedy Creek Improvement District (RCID)
EPCOT Center Diesel Generators No. 1 and No. 2
Construction Permits AC 48-105243 and AC 48-106650 and
GE Gas Turbine with Heat Recovery Steam Generator,
PSD-FL-123 and AC 48-137740

The Department is in receipt of your letter dated April 17, 1995, requesting a revision of Specific Conditions Nos. 2 and 7 of the above mentioned permits. The Department considered your request and agrees to revise your permits as proposed in your letters.

The revision of Specific Condition No. 2 of each permit is finalized as follows:

SPECIFIC CONDITION No. 2 FOR PERMITS AC 48-105243 and AC 48-106650
EPCOT CENTER DIESEL GENERATOR No. 1 and No. 2

FROM:

Old Specific Condition No.2

Emissions rates shall not exceed:

	Max. Allowable Rate lb/hr	Actual Emissions tons/yr
Particulate Matter	10.0	9.5
Sulfur Dioxide	14.5	14.0
Nitrogen Oxides	126.0	126.0
Carbon Monoxide	1.5	2.8
Volatile Organic Compounds	2.0	2.0

"Protect, Conserve and Manage Florida's Environment and Natural Resources"

Mr. Thomas M. Moses
June 16, 1995
Page Two

TO:

New Specific Condition No. 2

Emissions rates shall not exceed:

	Max. Allowable Rate lb/hr	Annual Emissions tons/yr
Particulate Matter	10.0	9.5
Sulfur Dioxide	14.5	14.0
Nitrogen Oxides	126.0	126.0
Carbon Monoxide	2.9	2.8
Volatile Organic Compounds	2.1	2.0

SPECIFIC CONDITION No. 7 FOR PERMITS PSD-FL-123 & AC 48-137740
GE GAS TURBINE WITH HEAT RECOVERY STEAM GENERATOR

RCID COMMENT:

RCID requested to delete reference to Rule 62-252.300, F.A.C., since this rule applies to Gasoline Dispensing Facilities.

DEPARTMENT RESPONSE:

The Department acknowledges that Rule 62.252.300, F.A.C. does not apply to this source. However, this reference will not be deleted since it is part of the general statement of Rule 62-210.300(3), F.A.C., Exemptions. For clarification, specific condition No. 7 will be revised as follows:

FROM:

Old Specific Condition No.7

Pursuant to Rule 62-210.300(3)(u) F.A.C., this condition will be deleted.

It should be noted that pursuant to Rule 62-210.300(3), F.A.C., this source, although exempt from permitting requirements of Chapter 62-210 and Chapter 62-4, F.A.C., is subject to any applicable emission standard specified in Rule 62-252.300, and 62-296, F.A.C., other than Best Available Control Technology (BACT) or Lowest Achievable Emission Rate (LAER) requirements.

Mr. Thomas M. Moses
June 16, 1995
Page Three

Furthermore, pursuant to Rule 62-213.420(3)(m), F.A.C., this source, although currently exempt from permitting, is required to be included in the Title V operation permit application.

TO:

New Specific Condition No. 7

In accordance with Rule 62-210.300(3)(u) F.A.C., the Black Start Cummings No.2 fuel oil fired emergency electric generator is exempt from permitting requirements.

Pursuant to Rule 62-210.300(3), F.A.C., this source, although exempt from permitting requirements of Chapter 62-210 and Chapter 62-4, F.A.C., "shall be subject to any applicable emission standard specified in Rule 62-252.300, and 62-296, F.A.C., other than Best Available Control Technology (BACT) or Lowest Achievable Emission Rate (LAER) requirements."

Furthermore, pursuant to Rule 62-213.420(3)(m), F.A.C., this source, although currently exempt from permitting, is required to be included in the Title V operation permit application.

A person whose substantial interests are affected by the Department's proposed permitting decision may petition for an administrative proceeding (hearing) in accordance with Section 120.57, Florida Statutes (F.S.). The petition must contain the information set forth below and must be filed (received) in the Office of General Counsel of the Department at 2600 Blair Stone Road, Tallahassee, Florida 32399-2400. Petitions filed by the applicant of the amendment request/application and the parties listed below must be filed within 14 days of receipt of this amendment. Petitions filed by other persons must be filed within 14 days of the amendment issuance or within 14 days of their receipt of this amendment, whichever occurs first. Petitioner shall mail a copy of the petition to the applicant at the address indicated above at the time of filing. Failure to file a petition within this time period shall constitute a waiver of any right such person may have to request an administrative determination (hearing) under Section 120.57, F.S.

The Petition shall contain the following information:

(a) The name, address and telephone number of each petitioner, the applicant's name and address, the Department Permit File Number and the county in which the project is proposed;

Florida Department of Environmental Protection



Lawton Chiles
Governor

Central District
3319 Maguire Boulevard, Suite 232
Orlando, Florida 32803-3767

Virginia B. Wetherell
Secretary

Permittee:

Walt Disney World Company
Post Office Box 10,000
Lake Buena Vista, Florida 32830-1000

Attention: Robert H. Penn, Director,
Environmental Affairs

Permit Number: AO48-228914
Date of Issue:
Expiration Date: May 30, 1998
County: Orange
Latitude/Longitude:
28°22'30"N/81°35'30"W
UTM: 17-460.60 KmE; 3141.57 KmN
Project: Traffic Control Equipment
Paint Booth

This permit is issued under the provisions of Chapter(s) 403, Florida Statutes, and Florida Administrative Code Rule(s) 17-2. The above named permittee is hereby authorized to perform the work or operate the facility shown on the application and approved drawing(s), plans, and other documents attached hereto or on file with the department and made a part hereof and specifically described as follows:

The permittee can operate a paint spray booth to paint traffic control equipment. The booth is equipped with Columbus Industries filters.

This source is located at Bear Island Road at Lake Buena Vista, Orange County, Florida.

General Conditions are attached to be distributed to the permittee only.

Disney World Company

Permit Number: A048-228914
Expiration Date: May 30, 1998Attention: Robert H. Penn, Director,
Environmental Affairs**GENERAL CONDITIONS:**

16. No objectionable odors will be allowed, as per Rule 17-296.320(2), F.A.C.
17. All unconfined emissions of particulate matter generated at this site shall be adequately controlled. (Rule 17-296.310(3), F.A.C.) Area must be watered down should unconfined emissions occur.
18. This permit does not preclude compliance with any applicable local permitting requirements and regulations.

SPECIFIC CONDITIONSOPERATING LIMITS

1. Each source is permitted to operate 8 hrs/day, 5 days/week, and 52 weeks/year, pursuant to the application.
2. The maximum permitted usage rate for Delstar enamel or Xymax 66 polyurethane is 2.5 lb/hour.
3. Each source must be properly operated and maintained (Rule 17-210.300,(2), F.A.C.). No person shall circumvent any pollution control device or allow the emissions of air pollutants without the applicable air pollution control device operating properly (Rule 17-210.650, F.A.C.).
4. Air velocity at the Paint Booth Filter Face shall not exceed 250 ft/min.

EMISSION LIMITS

5. The visible emissions for each source must comply with Rule 17-296.406(1), F.A.C., (20% opacity) and the compliance test must be conducted in accordance with DEP Method 9 (Rule 17-297.420, F.A.C.).
6. Acrylonitrile emissions from the source shall not cause the 8 hour average ground level ambient air concentrations to exceed the No Threat Level (NTL) of 43 micrograms/M³. Acrylonitrile was modelled at an emission rate of 0.001 lbs/hr to correspond to a concentration of 0.5 micrograms/M³. Proof of compliance with this condition shall be demonstrated by the professional engineer's calculations based on actual condition.
7. Rule 17-2.620(a), F.A.C. states that no person shall store, pump, handle, process, load, unload or use in any process or installation volatile organic compounds or organic solvents without applying known and existing vapor emission control devices or systems deemed necessary and ordered by the department. To comply, procedures to minimize pollutant emissions should include but shall not be limited to the following:

- a) tightly cover or close all VOC containers when they are not in use,

PERMITTEE:

Walt Disney World Company

Permit Number: AO48-228914

Expiration Date: May 30, 1998

Attention: Robert H. Penn, Director,
Environmental Affairs

SPECIFIC CONDITIONS

(Continued)

- b) tightly cover, where possible, all open troughs, basins, baths, tanks, etc. when they are not in use,
- c) maintain all piping, valves, fittings, etc. in good operating condition,
- d) prevent excessive air turbulence across exposed VOC's,
- e) immediately confine and clean up VOC spills and make sure certain wastes are placed in closed containers for reuse, recycling or proper disposal, and

COMPLIANCE TESTING

- 8. Each source must be tested in accordance with DEP Method 9 for 30 minutes or the length of the batch/cycle at yearly intervals from the date of February 19, 1993. For any other method to be utilized the department must give prior approval.
- 9. The air compliance section of this office shall be notified in writing at least fifteen (15) days in advance of the compliance tests (Rule 17-297.340(1)(i), F.A.C.).
- 10. This source is required to operate within 90 to 100 percent of maximum permitted capacity during the compliance tests.
- 11. The required test report shall be filed with this office as soon as practical but no later than 45 days after the last sampling run of each test is completed (Rule 17-297.570(2), F.A.C.).
- 12. Each calendar year on or before March 1, submit for each source, an Annual Operations Report DEP Form 17-210.900(4) for the preceding calendar year.

EXPIRATION DATE

- 13. An operation permit renewal must be submitted at least 60 days prior to the expiration date of this permit (Rule 17-4.090, F.A.C.).

BEST AVAILABLE COPY

PERMITTEE:
Walt Disney World Company

Permit Number: AO48-228914
Expiration Date: May 30, 1998

Attention: Robert H. Penn, Director,
Environmental Affairs

SPECIFIC CONDITIONS
(Continued)

ISSUED 7-18-83

STATE OF FLORIDA DEPARTMENT
OF ENVIRONMENTAL PROTECTION

cmc Alexander

A. Alexander, P.E.
District Director
3319 Maguire Boulevard
Suite 232
Orlando, Florida 32803

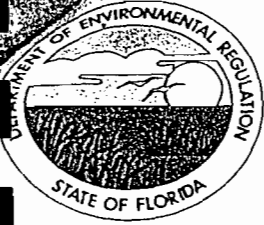

Florida Department of Environmental Regulation

Central District • 3319 Maguire Boulevard, Suite 232 • Orlando, Florida 32803-3767

Lawton Chiles, Governor

Carol M. Browner, Secretary

Permittee:
Walt Disney World
Post Office Box 10,000
Lake Buena Vista, FL 32830-1000

Attention: Robert H. Penn, Director,
Environmental Affairs

I. D. Number:
Permit/Certification
Number: A048-197148
Date of Issue:
Expiration Date: August 25, 1996
County: Orange
Latitude/Longitude:
28°22'15"N/81°33'41"W
UTM: 17-445.00 KmE; 3138.27 KmN
Project: Beach and Yacht Club Paint
Spray Booth (WDW-37)

This permit is issued under the provisions of Chapter(s) 403, Florida Statutes, and Florida Administrative Code Rule(s) 17-2. The above named permittee is hereby authorized to perform the work or operate the facility shown on the application and approved drawing(s), plans, and other documents attached hereto or on file with the department and made a part hereof and specifically described as follows:

The permittee can operate the Beach and Yacht Club Paint Spray Booth which is a Binks, Model PFF-10-8-T-LH, equipped with Paint Arrestors.

This source is located at the Disney Beach and Yacht Club on World Drive, Orange County, Florida.

General Conditions are attached to be distributed to the permittee only.

PERMITTEE:
Walt Disney World Co.

Attention: Bob Penn, Director,
Environmental Affairs

I. D. Number:
Permit/Certification Number:
A048-197148
Date of Issue:
Expiration Date: August 25, 1996

GENERAL CONDITIONS:

16. No person shall cause, suffer, allow, or permit the discharge of air pollutants which cause or contribute to an objectionable odor pursuant to F.A.C. Rule 17-2.620(2). Objectionable odor is defined as any odor present in the outdoor atmosphere which by itself or in combination with other odors, is or may be harmful or injurious to human health or welfare, which unreasonably interferes with the comfortable use and enjoyment of life or property, or which creates a nuisance pursuant to F.A.C. Rule 17-2.100(135).
17. This permit does not preclude compliance with any applicable local permitting requirements and regulations.

SPECIFIC CONDITIONS

OPERATING CONDITIONS

1. This source is allowed to operate 16 hrs/day, 5 days/wk, and 52 wks/yr.
2. The maximum material utilization rates are as stated in the application for the specific coatings and solvents which are to be used.
3. Any change in the method of operation, raw materials, equipment or operating hours shall be submitted to DER's Central District office for approval.
4. This source shall comply with all applicable provisions of Chapter 403, Florida Statutes, and Chapters 17-2 and 17-4, Florida Administrative Code.
5. Issuance of this permit does not relieve the facility owner or operator from compliance with any applicable federal, state, or local permitting requirements and regulations (F.A.C. Rule 17-2.210(1)).
6. If any spills, leaks, releases, etc., occur; the DER Central District office shall be promptly notified.

PERMITTEE:
Walt Disney World Co.

Attention: Bob Penn, Director,
Environmental Affairs

I. D. Number:
Permit/Certification Number:
A048-197148
Date of Issue:
Expiration Date: August 25, 1996

SPECIFIC CONDITIONS
(Continued)

EMISSION LIMITS

7. The maximum allowable VOC emissions shall not exceed 6.0 lbs/hr and 12.3 tons/yr. These emissions shall be verifiable on a 24-hour (daily basis) as required in specific condition No. 12.
8. The maximum allowable PM emissions shall not exceed 0.10 lbs/hr and 0.35 tons/yr.
9. Visible emissions shall not exceed 5% opacity.
10. Unless the Department has determined other concentrations are required to protect public health and safety, predicted ambient air impact of any toxic pollutant (as listed in the MSDS submitted with the application) shall not exceed the concentration calculated by the following formula:

$$AAC = \frac{OEL}{\text{Safety Factor}}$$

Where,

AAC = acceptable ambient concentration

Safety Factor = 50 for category B substances and 8 hrs/day
100 for category A substances and 8 hrs/day
210 for category B substances and 24 hrs/day
420 for category A substances and 24 hrs/day

OEL = Occupational exposure level such as ACGIH, OSHA and NIOSH published standards for toxic materials.

11. According to F.A.C. Rule 17-2.620(1)(a), no person shall store, pump, handle, process, load, unload, or use in any process or installation volatile organic compounds or organic solvents without applying known and existing vapor emissions control devices or systems deemed necessary and ordered by the Department. Currently, there are no control strategies associated with this operation other than crew efficiency to minimize pollutant emissions. The following procedures shall be utilized to minimize pollutant emissions:

PERMITTEE:
Walt Disney World Co.

Attention: Bob Penn, Director,
Environmental Affairs

I. D. Number:
Permit/Certification Number:
A048-197148
Date of Issue:
Expiration Date: August 25, 1996

SPECIFIC CONDITIONS
(Continued)

- a) maintain tightly fitting covers, lids, etc., on all containers of VOC when they are not being handled, tapped, etc.;
- b) prevent excessive air turbulence across exposed VOCs; where possible and practical procure/fabricate a tightly fitting cover for any open trough, basin, bath, etc., of VOC so that it can be covered when not in use;
- c) all fittings, valve lines, etc., shall be properly maintained; and,
- d) all VOC spills shall be attended to immediately and the waste properly disposed of, recycled, etc.

COMPLIANCE TESTING

12. Pursuant to F.A.C. 17-2.210(2) Air Operating Permits, the permittee is required to submit annual reports on the actual operating rates and emissions from this source. These reports shall include but are not limited to the following: utilization rates (lbs/yr), VOC and PM emissions (tons/yr, lbs/day, and lbs/hr), and annual hours of operation. Annual reports shall be sent to the Department's Central District office no later than March 1 of each year.
13. When the department, after investigation, has good reason (such as complaints, increased visible emissions or questionable maintenance of control equipment) to believe that any applicable emission standard contained in Chapter 17-2, F.A.C. or in this permit is being violated, it may require the owner or operator of the source to conduct compliance tests which identify the nature and quantity of pollutant emissions from the source and to provide a report on the results of said tests to the department.
14. Compliance with the VOC standard shall be determined by EPA Method 24, Determination of Volatile Matter Content or manufacturer's specifications and materials balance. The aforementioned method is contained in 40 CFR 60, Appendix A (July 1, 1988), and is adopted by reference in Rule 17-2.700, F.A.C.

BEST AVAILABLE COPY

PERMITTEE:
Walt Disney World Co.

Attention: Bob Penn, Director,
Environmental Affairs

I. D. Number:
Permit/Certification Number: A048-197148
Date of Issue:
Expiration Date: August 25, 1996

SPECIFIC CONDITIONS
(Continued)

15. Compliance with the visible emissions (V.E.) standard, shall be determined by EPA Method 9, Visual Determination of the Opacity of Emissions from Stationary Sources, which is described in 40 CFR 60, Appendix A (July 1, 1988), at yearly intervals from the date of May 20, 1991.
16. This office (Florida Department of Environmental Regulation, Air Permitting, Orlando) shall be notified in writing at least fifteen (15) days in advance of the compliance tests so that we can witness them (Rule 17-2.700(2)(a)5, F.A.C.).
17. This plant is required to operate within 90 to 100 percent of permitted capacity during the compliance tests.
18. The required test report shall be filed with the department as soon as practical but no later than 45 days after the last sampling run of each test is completed (Rule 17-2.700(7)(a), (b) and (c), F.A.C.).
19. Compliance with the acceptable ambient concentrations shall be demonstrated based on calculations certified by a Professional Engineer registered in Florida using actual operating conditions. Determination of the ambient concentration for organic compounds shall be determined by Department approved dispersion modeling or the Dilution factor Matrix calculations.

EXPIRATION DATE

20. An operation permit renewal must be submitted at least 60 days prior to the expiration date of this permit (Rule 17-4.09, F.A.C.).

ISSUED 9-12-81

STATE OF FLORIDA DEPARTMENT
OF ENVIRONMENTAL REGULATION

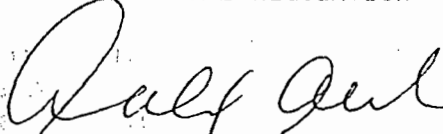
cmc 
Alex Alexander, District Director
3319 Maguire Boulevard, Suite 232
Orlando, Florida 32803



Department of Environmental Protection

Lawton Chiles
Governor

Central District
3319 Maguire Boulevard, Suite 232
Orlando, Florida 32803-3767

Virginia B. Wetherell
Secretary

Permittee:
Walt Disney World Company
Post Office Box 10,000
Lake Buena Vista, Florida 32830-1000

I.D. Number:
Permit Number: AC48-268376
Date of Issue: 10-13-1995
Expiration Date: December 31, 1995
County: Orange
UTM: 17-449 KmE; 3138.0 KmN
Project: Construction Landfill
Generators #1 and #2

Atten: William A. O'Toole,
Senior Vice President

This permit is issued under the provisions of Chapter(s) 403, Florida Statutes, and Florida Administrative Code Rule(s) 62-210. The above named permittee is hereby authorized to perform the work or operate the facility shown on the application and approved drawing(s), plans, and other documents attached hereto or on file with the department and made a part hereof and specifically described as follows:

The permittee can construct two diesel powered electrical generators to provide electricity to the scale house (Unit #1) and the landfill office (Unit #2). Generator #1 is a Coleman/Cummings, Model 4BG, with a maximum diesel fuel heat input of 0.155 MMBtu/hr. Generator #2 is a Coleman/Kubota, Model CK05-15M/V1902-B61, with a maximum diesel fuel heat input of 0.057 MMBtu/hr.

These emission units are located at 1375 Buena Vista Drive at Lake Buena Vista, Orange County, Florida.

General Conditions are attached to be distributed to the permittee only.

Permittee:
Walt Disney World Company

Attention: William A. O'Toole,
Senior Vice President

I.D. Number:
Permit Number: AC48-268376
Expiration Date: December 31, 1995
County: Orange

SPECIFIC CONDITIONS:

OPERATING CONDITIONS

1. The emission unit is permitted to operate a maximum of 8760 hours/year [Pursuant to permit application].
2. The emission unit shall be fired with diesel fuel [Pursuant to permit application].

EMISSION LIMITS

3. The permittee shall not cause, suffer, allow or permit the discharge of air pollutants which cause or contribute to an objectionable odor [Rule 62-296.320(2), F.A.C.].
4. The visible emissions for this emission unit must comply with Rule 62-296.310(2), F.A.C. (limited to less than 20% opacity).

COMPLIANCE TESTING

5. The emission unit must be tested for visible emissions in accordance with DEP Method 9 [Rule 62-297.401, F.A.C.] within 30 days after receipt of this permit. The DEP Method 9 visible emissions test shall last for 30 minutes.
6. The permittee shall notify the Central District Office of the Department of Environmental Protection, in writing, at least 15 days prior to the date on which each formal compliance test is to begin, of the date, time and place of each such test, and the contact person who will be responsible for coordinating and having such tests conducted for the owner. The Department may waive the 15 day notice requirement on a case by case basis [Rule 62-297.340(1)(i), F.A.C.].
7. Testing of emissions shall be conducted with the emissions unit operation at permitted capacity. Permitted capacity is defined as 90 to 100 percent of the maximum operation rate allowed by the permit. If it is impractical to test at permitted capacity, an emissions unit may be tested at less than the minimum permitted capacity; in this case, subsequent emissions unit operation is limited to 110 percent of the test load until a new test is conducted. Once the unit is so limited, operation at higher capacities is allowed for no more than 15 consecutive days for the purpose of additional compliance testing to regain the authority to operate at the permitted capacity [Rule 62-297.310(2), F.A.C.].
8. The type of fuel and the heat input to the emission unit must be entered on the visible emission test report.

Permittee:

Walt Disney World Company

Attention: William A. O'Toole,
Senior Vice President

I.D. Number:

Permit Number: AC48-268376

Expiration Date: December 31, 1995

County: Orange

9. A copy of the compliance test results must be submitted to the Department's Central District Office within 45 days after the last sampling run of each test is completed [Rule 62-297.570(2), F.A.C].
10. A DEP Form No. 62-210.900(5), "Annual Operating Report for Air Pollutant Emitting Facility" including the Emissions Report, shall be completed for each calendar year on or before March 1 of the following year and submitted to this office [Rule 62-210.370(3)(a), F.A.C.].

EXPIRATION DATE

11. This permit will expire December 31, 1995.

STATE OF FLORIDA DEPARTMENT
OF ENVIRONMENTAL PROTECTION

Charles M. Garfein

Vivian F. Garfein
Director of District Management

Issued: 12-1-95

Electronic Submittal

