



Florida Department of Environmental Protection

Memorandum

TO: Joseph Kahn, Division of Air Resource Management
THROUGH: Trina Vielhauer, Bureau of Air Regulation 
FROM: A.A. Linero 
DATE: October 28, 2008
SUBJECT: DEP File No. PSD-FL-105C (0112119-010-AC)
Wheelabrator South Broward Waste-to-Energy Facility
Municipal Waste Combustors - Units 1, 2 and 3
Activated Carbon Injection (ACI) Systems

The Final PSD Permit Modification for this project is attached for your approval and signature. It authorizes the installation of activated carbon injection (ACI) systems on Units 1, 2 and 3 for the purpose of reducing mercury (Hg) emissions. The proposed work will be conducted at the Wheelabrator South Broward Waste-to-Energy Facility, which is located in Broward County, Florida.

The attached Final Determination identifies issuance of the draft permit and summarizes the publication process. No comments on the Draft Permit were received from the applicant or the public.

I recommend your approval of the attached Final Permit for this project.

Attachments

FINAL DETERMINATION

Air Construction Permit (PSD Permit Modification)
South Broward Waste-to-Energy Facility
DEP File No. PSD-FL-105C (0112119-010-AC)
Municipal Waste Combustors - Units 1, 2 and 3

PERMITTEE

South Broward Waste-to-Energy Facility
Wheelabrator South Broward, Inc.
4400 South State Road 7
Ft. Lauderdale, Florida 33314

PERMITTING AUTHORITY

Florida Department of Environmental Protection (Department)
Division of Air Resource Management
Bureau of Air Regulation, Special Projects Section
2600 Blair Stone Road, MS #5505
Tallahassee, Florida 32399-2400

PROJECT

DEP File No. PSD-FL-105C (0112119-010-AC)
South Broward Waste-to-Energy Facility
Municipal Waste Combustors - Units 1, 2 and 3
Activated Carbon Injection (ACI) System
Broward County, Florida

This air construction permit is also a modification of the facility PSD permit. It authorizes the installation of an ACI system on three municipal waste combustor (MWC) designated as Units 1, 2 and 3 for the purpose of reducing mercury (Hg) emissions.

NOTICE AND PUBLICATION

The Department distributed a Written Notice of Intent to Issue PSD Permit Modification on September 26, 2008. The Public Notice of Intent to Issue Air Permit was published on October 4, 2008 in the Sun Sentinel. The Department received the proof of publication on October 14, 2008. No petitions for administrative hearings or extensions of time to petition for an administrative hearing were filed.

COMMENTS

No comments on the Draft Permit were received from the applicant or the public.

CONCLUSION

The final decision by the Department is to issue the PSD permit modification as noted during the public notice period.

STATE OF FLORIDA
DEPARTMENT OF ENVIRONMENTAL PROTECTION

NOTICE OF FINAL PERMIT

*In the Matter of an
Application for PSD Permit Modification by:*

Mr. Jairaj Gosine, Plant Manager
South Broward Waste-to-Energy Facility
Wheelabrator South Broward, Inc.
4400 South State Road 7
Ft. Lauderdale, Florida 33314

DEP File No. PSD-FL-105C (0112119-010-AC)
South Broward Waste-to-Energy Facility
Municipal Waste Combustors - Units 1, 2 and 3
Activated Carbon Injection (ACI) System
Broward County, Florida

Enclosed is the final permit (PSD modification), which authorizes the installation of an ACI system on three municipal waste combustor (MWC) designated as Units 1, 2 and 3 for the purpose of reducing mercury (Hg) emissions. The facility is located in Broward County at 4400 South State Road 7 in Ft. Lauderdale. The original construction permit, was previously issued pursuant to the rules for the Prevention of Significant Deterioration (PSD) of Air Quality pursuant to Rule 62-212.400 of the Florida Administrative Code (F.A.C.). As noted in the attached Final Determination, no changes were made to the permit as drafted. This permit is issued pursuant to Chapter 403, Florida Statutes (F.S.).

Any party to this order (permit) has the right to seek judicial review of the permit pursuant to Section 120.68, F.S., by the filing of a Notice of Appeal pursuant to Rule 9.110, Florida Rules of Appellate Procedure, with the Clerk of the Department in the Legal Office; and by filing a copy of the Notice of Appeal accompanied by the applicable filing fees with the appropriate District Court of Appeal. The Notice of Appeal must be filed within 30 days from the date this Notice is filed with the Clerk of the Department.

Executed in Tallahassee, Florida.

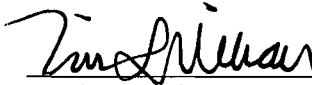

Trina L. Vielhauer, Chief
Bureau of Air Regulation

10/25/08
(Date)

TLV/aal/th

CERTIFICATE OF SERVICE

The undersigned duly designated deputy agency clerk hereby certifies that this Notice of Final Permit (including the Final Determination and the Final Permit) was sent by electronic mail (or a link to these documents made available electronically on a publicly accessible server) with received receipt requested before the close of business on 10/30/08 to the persons listed below.

Jairaj Gosine, Wheelabrator: jgosine@wm.com
Jack Long, DEP SED: jack.long@dep.state.fl.us
Mike Halpin, DEP Siting Office: mike.halpin@dep.state.fl.us
Ken Kosky, P.E., Golder: Ken_Kosky@golder.com
Kathy Forney, EPA Region 4: forney.kathleen@epamail.epa.gov
Heather Abrams, EPA: abrams.heather@epa.gov
Ram Tewari, Broward County: rtewari@broward.org
Mary Beth Busutil, Broward County: MBUSUTIL@broward.org
Richard Meyers, Broward County: rmeyers@broward.org
Vickie Gibson, DEP BAR: Victoria.Gibson@dep.state.fl.us (for read file)

Clerk Stamp

FILING AND ACKNOWLEDGMENT
FILED, on this date, pursuant to §120.52,
Florida Statutes, with the designated
Department Clerk, receipt of which is hereby
acknowledged.

(Clerk)

10/30/08
(Date)

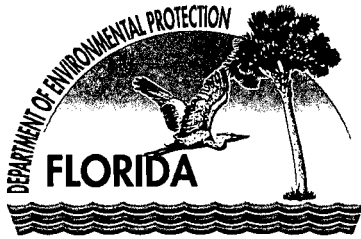

Florida Department of Environmental Protection

Bob Martinez Center
2600 Blairstone Road
Tallahassee, Florida 32399-2400

Charlie Crist
Governor
Jeff Kottkamp
Lt. Governor
Michael W. Sole
Secretary

PERMITTEE

Wheelabrator South Broward, Inc.
4400 South State Road 7
Ft. Lauderdale, Florida 33314

Authorized Representative:
Jairaj Gosine, Plant Manager

DEP File No. PSD-FL-105C (0112119-010-AC)
South Broward Waste-to-Energy Facility
Municipal Waste Combustors, Units 1, 2 and 3
Activated Carbon Injection System
Expiration date: June 30, 2009
Broward County, Florida

PROJECT AND LOCATION

The project is the installation of an activated carbon injection system on three municipal waste combustors designated as Units 1, 2 and 3 at the Wheelabrator South Broward Waste-to-Energy Facility. The purpose of the project is to reduce mercury emissions.

The facility is located in Broward County at 4400 South State Road 7 in Ft. Lauderdale. The UTM coordinates for this site are Zone 17, 579.54 kilometers (km) East and 2883.34 km North.

STATEMENT OF BASIS

This is a modification of the facility Prevention of Significant Deterioration (PSD) permit and is issued under the provisions of Chapter 403 of the Florida Statutes (F.S.), and Chapters 62-4, 62-204, 62-210, 62-212, 62-296 and 62-297 of the Florida Administrative Code (F.A.C.) and Title 40, Parts 60 and 63 of the Code of Federal Regulations (CFR). The permittee is authorized to install the proposed equipment in accordance with the conditions of this permit and as described in the application, approved drawings, plans, and other documents on file with the Department.

CONTENTS

- Section 1. Facility Information
- Section 2. Administrative Requirements
- Section 3. Emissions Units Specific Conditions
- Section 4. Appendices

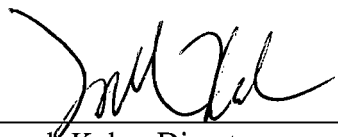

Joseph Kahn, Director
Division of Air Resource
Management

10/30/08
(Date)

SECTION I. FACILITY INFORMATION

FACILITY DESCRIPTION

This facility consists of three municipal solid waste combustors (MWC); Units 1, 2 and 3 with auxiliary burners, lime storage and processing facilities, ash storage and processing facilities, a cooling tower, and ancillary support equipment. Each unit has a maximum capacity of 863 tons per day (TPD) of waste input. There is a metals recovery system which is a potential source of fugitive emissions. The nominal (generator nameplate) electric generating capacity of the facility is 67.6 megawatts (MW), which is sold to the local utility. Also included in this permit are miscellaneous insignificant emissions units and/or activities.

Each unit includes an acid gas, air toxics, and particulate emissions control system consisting of a lime spray dryer absorber and fabric filter baghouse (SDA/FF). Nitrogen oxides are controlled by a urea injection system that operates under the principle of selective non-catalytic reduction (SNCR).

EMISSIONS UNITS

This facility consists of the following emissions units (EU) listed below.

E.U. ID No.	Brief Description
001	863 TPD (maximum) Municipal Waste Combustor & Auxiliary Burners - Unit 1
002	863 TPD (maximum) Municipal Waste Combustor & Auxiliary Burners - Unit 2
003	863 TPD (maximum) Municipal Waste Combustor & Auxiliary Burners - Unit 3
004	236 Ton Lime Silo with a Baghouse
005	Ash Handling System

PROJECT

The project is the installation of a system to inject powdered activated carbon in the flue gas from Units 1, 2 and 3 at a location prior to the acid gas control device on each unit to provide further control of mercury emissions. The system will consist of:

- One powdered activated carbon storage silo sufficient for the three boilers and with a nominal storage capacity of 3,200 cubic feet;
- One vent dust baghouse collector used during pneumatic loading of the silo from tanker truck; and
- Rotary feeders, hoppers, screw feeders and blower assemblies.

REGULATORY CLASSIFICATION

The facility is a major Prevention of Significant Deterioration (PSD) stationary source in accordance with Rule 62-212.400, F.A.C. The proposed project does not trigger the PSD rules as a Major Stationary Source Modification or a determination of best available control technology (BACT). The project does require a modification of the initial facility PSD permit.

The facility is a Title V major source of air pollution in accordance with Chapter 213, Florida Administrative Code (F.A.C.).

SECTION I. FACILITY INFORMATION

The facility operates units subject to the Standards of Performance for New Stationary Sources (NSPS) pursuant to 40 Code of Federal Regulations Part 60 (40 CFR 60). Units 1, 2 and 3 are subject to 40 CFR 60, Subpart Cb-Emissions Guidelines and Compliance Times for Large Municipal Waste Combustors That are Constructed on or Before September 20, 1994.

The existing facility is a major source of hazardous air pollutants (HAP). 40 CFR 60, Subpart Cb addresses the HAP control requirements pursuant to Section 129 of the Clean Air Act.

The facility was certified under the Florida Power Plant Siting Act (FPPSA), 403.501-518, F.S.

RELEVANT DOCUMENTS

The following relevant documents are not a part of this permit modification, but helped form the basis for this permitting action or include important additional requirements applicable to the facility:

- Permit PSD-FL-105 issued by the Environmental Protection Agency (EPA) Region 4 office on May 17, 1987 that authorized construction of the facility;
- An amendment to Permit PSD-FL-105 issued by the Department on March 21, 1996 that allowed use of EPA Method 7E to measure emissions of nitrogen oxides (NO_x) as an alternative to EPA Method 7;
- Permit Modification PSD-FL-105A issued by the Department on May 22, 1997 that allowed the use of EPA Method 29 to measure emissions of mercury (Hg);
- Permit Modification PSD-FL-105B issued by the Department on September 28, 1999 to install a selective non-catalytic reduction system, revise permit conditions consistent with 40 CFR 60, Subpart Cb, permit metals recovery operations, and define the fuel slate for the facility;
- Current facility Title V Air Operation Permit Renewal No. 0112119-010-AV issued on February 23, 2006;
- Application received on September 11, 2008 to install an activated carbon injection system; and,
- The Department's draft permit package including the Technical Evaluation and Preliminary Determination and dated September 26, 2008.

SECTION II. ADMINISTRATIVE REQUIREMENTS

GENERAL AND ADMINISTRATIVE REQUIREMENTS

1. Permitting Authority: All documents related to applications for permits to construct, modify or operate this emissions unit shall be submitted to the Bureau of Air Regulation (BAR), Florida Department of Environmental Protection (DEP), at 2600 Blair Stone Road, Tallahassee, Florida 32399-2400 and phone number 850/488-0114. Copies of these documents shall be submitted to the Compliance Authority.
2. Compliance Authority: All documents related to compliance activities such as reports, tests, and notifications shall be submitted to the Southeast District Office. The mailing address and phone number of the Southeast District Office are: Department of Environmental Protection, Southeast District Office, 400 North Congress Avenue, Suite 200, West Palm Beach, Florida 33401. Telephone: (561)681-6632. Fax: (561)681-6790.
3. Appendices: The following Appendices are attached as part of this permit modification: Appendices Cb and GC (General Conditions).
4. Applicable Regulations, Forms and Application Procedures: Unless otherwise specified in this permit, the construction and operation of the subject emissions units shall be in accordance with the capacities and specifications stated in the application. The facility is subject to all applicable provisions of: Chapter 403, F.S.; and Chapters 62-4, 62-204, 62-210, 62-212, 62-213, 62-214, 62-296 and 62-297, F.A.C. Issuance of this permit does not relieve the permittee from compliance with any applicable federal, state, or local permitting or regulations.
5. New or Additional Conditions: For good cause shown and after notice and an administrative hearing, if requested, the Department may require the permittee to conform to new or additional conditions. The Department shall allow the permittee a reasonable time to conform to the new or additional conditions, and on application of the permittee, the Department may grant additional time. [Rule 62-4.080, F.A.C.]
6. Modifications: No emissions unit shall be constructed or modified without obtaining an air construction permit from the Department. Such permit shall be obtained prior to beginning construction or modification. [Rules 62-210.300(1) and 62-212.300(1)(a), F.A.C.]
7. Construction and Expiration: The permit expiration date includes sufficient time to complete construction and submit an application for a Title V operation permit to the Department. For good cause, the permittee may request that this PSD permit modification be extended. Such a request shall be submitted to the Department's Bureau of Air Regulation at least sixty (60) days prior to the expiration of this permit. [Rules 62-4.070(4), 62-4.080, 62-210.300(1) and 62-212.400(6)(b), F.A.C.]
8. Title V Permit: This PSD permit modification authorizes installation of the activated carbon injection project. This project involves no changes in the descriptions, applicable requirements, or conditions of the facility Title V Operation Permit at this time. However, the permittee is required to apply for a revised Title V operation permit by October 31, 2008 to incorporate a revision promulgated on May 10, 2006 by EPA of 40 CFR 60, Subpart Cb and as incorporated in Section 62-204.204.800(b), F.A.C.

SECTION III. EMISSIONS UNITS SPECIFIC CONDITIONS

Units 1, 2 and 3 – Municipal Waste Combustors

The proposed project affects the following existing units:

E.U. ID No.	Brief Description
001	863 TPD (maximum) Municipal Waste Combustor & Auxiliary Burners - Unit 1
002	863 TPD (maximum) Municipal Waste Combustor & Auxiliary Burners - Unit 2
003	863 TPD (maximum) Municipal Waste Combustor & Auxiliary Burners - Unit 3

ADMINISTRATIVE REQUIREMENTS

1. Previous Permit Conditions: This PSD permit modification authorizes the installation of an activated carbon injection system on three municipal waste combustors designated as Units 1, 2 and 3. The following conditions are in addition to those of any other PSD permits, modifications thereto or operation permits. [Rule 62-4.210, F.A.C.]

CONSTRUCTION ACTIVITIES

2. Installation of Powdered Activated Carbon Injection (ACI) System: The permittee shall install a system to inject powdered activated carbon in the flue gas from the boiler at a location prior to the acid gas control device to provide further control of mercury consisting of:
 - a. One powdered activated carbon storage silo sufficient for the three boilers and with a nominal storage capacity of 3,200 cubic feet;
 - b. One vent dust baghouse collector used during pneumatic loading of the silo from tanker truck; and
 - c. Rotary feeders, hoppers, screw feeders and blower assemblies.

(Applicants Request)

3. Modification of PSD Permit: Permit PSD-FL-105, Condition 8, Air Pollution Control Equipment, is hereby modified by the addition of the following provision:
 - c. The facility shall be equipped with an ACI system as described above to provide additional control of mercury emissions from each boiler.

EMISSION REQUIREMENTS

4. Emission Limits and Testing Requirements: No additional limits or testing requirements are applicable to Units 1, 2 and 3 as a result of this project.

{Permitting Note: The applicable emission limits are specified or maintained in the PSD permit, modifications thereto and the facility Title V operation permit.}

NOTIFICATIONS AND REPORTS

5. Notifications: Within one week of beginning construction, the permittee shall notify the Compliance Authority that the project has commenced and provide a general schedule of construction activities. Within one week of completing construction, the permittee shall notify the Compliance Authority that the project has concluded and provide a general schedule of bringing the unit back on line. [Rule 62-4.210, F.A.C.]

SECTION IV. APPENDICES

Appendix Cb- Emissions Guidelines for Large Municipal Waste Combustors

Applicability of 40 CFR 60, Subpart Cb - Emissions Guidelines and Compliance Times for Large Municipal Waste Combustors That are Constructed on or Before September 20, 1994.

Wheelabrator South Broward Units 1, 2 and 3 are Large Municipal Waste Combustor (Large MWC) because they are waste combustion units that are each capable of combusting more than 250 tons per day (TPD) of municipal solid waste (MSW).

The rules applicable to Large MWC are given at 40 CFR 60, Sections 60.30b through 60.39b. Units 1, 2 and 3 are Mass Burn Waterwall Furnaces. The emission limits applicable to this category of MWC are specified by type of combustor in the relevant sections, paragraphs and tables that address individual pollutants including carbon monoxide (CO), nitrogen oxides (NO_x), sulfur dioxide (SO₂), hydrogen chloride (HCl), particulate matter (PM), dioxin/furan (D/F), opacity, cadmium (Cd), mercury (Hg), and lead (Pb). The various emission monitoring and operational parameters are included therein.

Subpart 40 CFR 60, Subpart Cb was revised on May 10, 2006. Units 1, 2 and 3 are subject to those revisions. The Department is reopening the Title V operation permits or processing applications to incorporate the updated requirements in each facility subject to Subpart Cb. The updated requirements will be included in the revised permits.

The revised version of 40 CFR 60, Subpart Cb is available at:

<http://ecfr.gpoaccess.gov/cgi/t/text/text-idx?c=ecfr&sid=9f85cb975ad1fc48e7b80bf5309b6e08&rgn=div6&view=text&node=40:6.0.1.1.1.5&idno=40>

SECTION IV. APPENDICES

Appendix GC - General Conditions

- G.1. The terms, conditions, requirements, limitations, and restrictions set forth in this permit are "Permit Conditions" and are binding and enforceable pursuant to Sections 403.161, 403.727, or 403.859 through 403.861, Florida Statutes. The permittee is placed on notice that the Department will review this permit periodically and may initiate enforcement action for any violation of these conditions.
- G.2. This permit is valid only for the specific processes and operations applied for and indicated in the approved drawings or exhibits. Any unauthorized deviation from the approved drawings or exhibits, specifications, or conditions of this permit may constitute grounds for revocation and enforcement action by the Department.
- G.3. As provided in Subsections 403.087(6) and 403.722(5), Florida Statutes, the issuance of this permit does not convey and vested rights or any exclusive privileges. Neither does it authorize any injury to public or private property or any invasion of personal rights, nor any infringement of federal, state or local laws or regulations. This permit is not a waiver or approval of any other Department permit that may be required for other aspects of the total project which are not addressed in the permit.
- G.4. This permit conveys no title to land or water, does not constitute State recognition or acknowledgment of title, and does not constitute authority for the use of submerged lands unless herein provided and the necessary title or leasehold interests have been obtained from the State. Only the Trustees of the Internal Improvement Trust Fund may express State opinion as to title.
- G.5. This permit does not relieve the permittee from liability for harm or injury to human health or welfare, animal, or plant life, or property caused by the construction or operation of this permitted source, or from penalties therefore; nor does it allow the permittee to cause pollution in contravention of Florida Statutes and Department rules, unless specifically authorized by an order from the Department.
- G.6. The permittee shall properly operate and maintain the facility and systems of treatment and control (and related appurtenances) that are installed or used by the permittee to achieve compliance with the conditions of this permit, as required by Department rules. This provision includes the operation of backup or auxiliary facilities or similar systems when necessary to achieve compliance with the conditions of the permit and when required by Department rules.
- G.7. The permittee, by accepting this permit, specifically agrees to allow authorized Department personnel, upon presentation of credentials or other documents as may be required by law and at a reasonable time, access to the premises, where the permitted activity is located or conducted to:
- (a) Have access to and copy and records that must be kept under the conditions of the permit;
 - (b) Inspect the facility, equipment, practices, or operations regulated or required under this permit, and,
 - (c) Sample or monitor any substances or parameters at any location reasonably necessary to assure compliance with this permit or Department rules.
- Reasonable time may depend on the nature of the concern being investigated.
- G.8. If, for any reason, the permittee does not comply with or will be unable to comply with any condition or limitation specified in this permit, the permittee shall immediately provide the Department with the following information:
- (a) A description of and cause of non-compliance; and
 - (b) The period of noncompliance, including dates and times; or, if not corrected, the anticipated time the non-compliance is expected to continue, and steps being taken to reduce, eliminate, and prevent recurrence of the non-compliance.

SECTION IV. APPENDICES

Appendix GC - General Conditions

The permittee shall be responsible for any and all damages, which may result and may be subject to enforcement action by the Department for penalties or for revocation of this permit.

- G.9. In accepting this permit, the permittee understands and agrees that all records, notes, monitoring data and other information relating to the construction or operation of this permitted source which are submitted to the Department may be used by the Department as evidence in any enforcement case involving the permitted source arising under the Florida Statutes or Department rules, except where such use is prescribed by Sections 403.73 and 403.111, Florida Statutes. Such evidence shall only be used to the extent it is consistent with the Florida Rules of Civil Procedure and appropriate evidentiary rules.
- G.10. The permittee agrees to comply with changes in Department rules and Florida Statutes after a reasonable time for compliance, provided, however, the permittee does not waive any other rights granted by Florida Statutes or Department rules.
- G.11. This permit is transferable only upon Department approval in accordance with Florida Administrative Code Rules 62-4.120 and 62-730.300, F.A.C., as applicable. The permittee shall be liable for any non-compliance of the permitted activity until the transfer is approved by the Department.
- G.12. This permit or a copy thereof shall be kept at the work site of the permitted activity.
- G.13. This permit also constitutes:
- (a) Determination of Best Available Control Technology (not applicable to project);
 - (b) Determination of Prevention of Significant Deterioration (not applicable to project); and
 - (c) Compliance with New Source Performance Standards (not applicable to project).
- G.14. The permittee shall comply with the following:
- (a) Upon request, the permittee shall furnish all records and plans required under Department rules. During enforcement actions, the retention period for all records will be extended automatically unless otherwise stipulated by the Department.
 - (b) The permittee shall hold at the facility or other location designated by this permit records of all monitoring information (including all calibration and maintenance records and all original strip chart recordings for continuous monitoring instrumentation) required by the permit, copies of all reports required by this permit, and records of all data used to complete the application or this permit. These materials shall be retained at least three years from the date of the sample, measurement, report, or application unless otherwise specified by Department rule.
 - (c) Records of monitoring information shall include:
 - 1. The date, exact place, and time of sampling or measurements;
 - 2. The person responsible for performing the sampling or measurements;
 - 3. The dates analyses were performed;
 - 4. The person responsible for performing the analyses;
 - 5. The analytical techniques or methods used; and
 - 6. The results of such analyses.
- G.15. When requested by the Department, the permittee shall within a reasonable time furnish any information required by law, which is needed to determine compliance with the permit. If the permittee becomes aware that relevant facts were not submitted or were incorrect in the permit application or in any report to the Department, such facts or information shall be corrected promptly.

Livingston, Sylvia

From: Livingston, Sylvia
Sent: Thursday, October 30, 2008 4:09 PM
To: 'jgosine@wm.com'
Cc: Long, Jack; Halpin, Mike; 'Ken_Kosky@golder.com'; 'forney.kathleen@epamail.epa.gov'; 'abrams.heather@epa.gov'; 'rtewari@broward.org'; 'MBUSUTIL@broward.org'; 'rmeyers@broward.org'; Gibson, Victoria; Walker, Elizabeth (AIR); Linero, Alvaro; Read, David
Subject: WHEELABRATOR SOUTH BROWARD; 0112119-010-AC (PSD-FL-105C)

Dear Sir/ Madam:

Attached is the official **Notice of Final Permit** for the project referenced below. Click on the link displayed below to access the permit project documents and send a "reply" message verifying receipt of the document(s) provided in the link; this may be done by selecting "Reply" on the menu bar of your e-mail software, noting that you can view the documents, and then selecting "Send". **We must receive verification that you are able to access the documents.** Your immediate reply will preclude subsequent e-mail transmissions to verify accessibility of the document(s).

Click on the following link to access the permit project documents:

http://ARM-PERMIT2K.dep.state.fl.us/adh/prod/pdf_permit_zip_files/0112119.010.AC.F_pdf.zip

Owner/Company Name: WHEELABRATOR SOUTH BROWARD, INC

Facility Name: WHEELABRATOR SOUTH BROWARD

Project Number: 0112119-010-AC/ PSD-FL-105C

Permit Status: FINAL

Permit Activity: CONSTRUCTION/ ACTIVATED CARBON INJECTION SYS

Facility County: BROWARD

Processor: Al Linero/ David Read

The Bureau of Air Regulation is issuing electronic documents for permits, notices and other correspondence in lieu of hard copies through the United States Postal System, to provide greater service to the applicant and the engineering community. Access these documents by clicking on the link provided above, or search for other project documents using the "*Air Permit Documents Search*" website at <http://www.dep.state.fl.us/air/eproducts/apds/default.asp>.

Permit project documents addressed in this email may require immediate action within a specified time frame. Please open and review the document(s) as soon as possible, and verify that they are accessible. Please advise this office of any changes to your e-mail address or that of the Engineer-of-Record. If you have any problems opening the documents or would like further information, please contact the Florida Department of Environmental Protection, Bureau of Air Regulation at (850)488-0114.



FNOTICE105C.pdf

Sylvia Livingston
Bureau of Air Regulation

Livingston, Sylvia

From: Gosine, Jairaj [jgosine@WM.com]
Sent: Tuesday, December 02, 2008 1:35 PM
To: Livingston, Sylvia
Cc: Faller, Chuck
Subject: RE: WHEELABRATOR SOUTH BROWARD; 0112119-010-AC (PSD-FL-105C)

Dear Ms Livingston,

I have received all documents that are referenced in the link below.

Thank you,
Jairaj Gosine

-----Original Message-----

From: Livingston, Sylvia [mailto:Sylvia.Livingston@dep.state.fl.us]
Sent: Wednesday, November 19, 2008 4:38 PM
To: Gosine, Jairaj
Subject: FW: WHEELABRATOR SOUTH BROWARD; 0112119-010-AC (PSD-FL-105C)

We have not received confirmation that you were able to access the documents attached to this October 30th e-mail, as well as the documents provided in the link (http://ARM-PERMIT2K.dep.state.fl.us/adh/prod/pdf_permit_zip_files/0112119.010.AC.F_pdf.zip) referenced in the email. Please confirm receipt by opening the attachment and clicking on the link to the permit documents, and sending a reply to me.

The Division of Air Resource Management is sending electronic versions of these documents rather than sending them Return Receipt Requested via the US Postal service. Your "receipt confirmation" reply serves the same purpose as tracking the receipt of the signed "Return Receipt" card from the US Postal Service. Please let me know if you have any questions.

Thanks,

Sylvia Livingston
Bureau of Air Regulation
Division of Air Resource Management (DARM)
850/921-0771
sylvia.livingston@dep.state.fl.us

The Department of Environmental Protection values your feedback as a customer. DEP Secretary Michael W. Sole is committed to continuously assessing and improving the level and quality of services provided to you. Please take a few minutes to comment on the quality of service you received. Simply click on [this link to the DEP Customer Survey](#). Thank you in advance for completing the survey.

From: Livingston, Sylvia
Sent: Thursday, October 30, 2008 4:09 PM
To: 'jgosine@wm.com'

Cc: Long, Jack; Halpin, Mike; 'Ken_Kosky@golder.com'; 'forney.kathleen@epamail.epa.gov'; 'abrams.heather@epa.gov'; 'rtewari@broward.org'; 'MBUSUTIL@broward.org'; 'rmeyers@broward.org'; Gibson, Victoria; Walker, Elizabeth (AIR); Linero, Alvaro; Read, David

Subject: WHEELABRATOR SOUTH BROWARD; 0112119-010-AC (PSD-FL-105C)

Dear Sir/ Madam:

Attached is the official **Notice of Final Permit** for the project referenced below. Click on the link displayed below to access the permit project documents and send a "reply" message verifying receipt of the document(s) provided in the link; this may be done by selecting "Reply" on the menu bar of your e-mail software, noting that you can view the documents, and then selecting "Send". **We must receive verification that you are able to access the documents.** Your immediate reply will preclude subsequent e-mail transmissions to verify accessibility of the document(s).

Click on the following link to access the permit project documents:

http://ARM-PERMIT2K.dep.state.fl.us/adh/prod/pdf_permit_zip_files/0112119.010.AC.F_pdf.zip

Owner/Company Name: WHEELABRATOR SOUTH BROWARD, INC

Facility Name: WHEELABRATOR SOUTH BROWARD

Project Number: 0112119-010-AC/ PSD-FL-105C

Permit Status: FINAL

Permit Activity: CONSTRUCTION/ ACTIVATED CARBON INJECTION SYS

Facility County: BROWARD

Processor: Al Linero/ David Read

The Bureau of Air Regulation is issuing electronic documents for permits, notices and other correspondence in lieu of hard copies through the United States Postal System, to provide greater service to the applicant and the engineering community. Access these documents by clicking on the link provided above, or search for other project documents using the "*Air Permit Documents Search*" website at <http://www.dep.state.fl.us/air/eproducts/apds/default.asp>.

Permit project documents are addressed in this email may require immediate action within a specified time frame. Please open and review the document(s) as soon as possible, and verify that they are accessible. Please advise this office of any changes to your e-mail address or that of the Engineer-of-Record. If you have any problems opening the documents or would like further information, please contact the Florida Department of Environmental Protection, Bureau of Air Regulation at (850)488-0114.

<<FNOTICE105C.pdf>>

Sylvia Livingston
Bureau of Air Regulation
Division of Air Resource Management (DARM)
850/921-0771



Wheelabrator South Broward Inc.

A Waste Management Company

4400 South State Road 7
Ft. Lauderdale, FL 33314
(954) 581-6606 Tel
(954) 581-6705 Fax

RECEIVED

OCT 14 2008

BUREAU OF AIR REGULATION

October 10, 2008

Certified Mail 70022030000385124270

Florida Department of Environmental Protection
Bureau of Air Regulation
Twin Towers Office Building
2600 Blair Stone Road
Tallahassee, Florida 32399-2400
Attention: Al Linero

Re: Wheelabrator South Broward
Powdered Activated Carbon System
Public Notice of Intent to Issue PSD Permit Modification
Proof of Publication

Dear Mr. Linero:

Please find enclosed proof of publication of the Public Notice of Intent to Issue PSD Permit Modification for Wheelabrator South Broward's proposed activated carbon injection system which was posted in the Sun Sentinel on October 4, 2008.

If there are any questions, or if further information is required, please contact this office at (954) 581-6606.

Sincerely,

Jairaj Gosine
Plant Manager

cc: Chuck Faller (with attachments)
Tim Porter (without attachments)
Rob French – MPI (without attachments)
Ram Tewari – BCWRS (without attachments)
File: 5.1.3.2 (without attachments)

JG/jlb081010



Published Daily

Fort Lauderdale, Broward County, Florida

Boca Raton, Palm Beach County, Florida

Miami, Miami-Dade County, Florida

STATE OF FLORIDA

COUNTY OF BROWARD/PALM BEACH/MIAMI-DADE

Before the undersigned authority personally appeared James H. Croteau who on oath says that he/she is a duly authorized representative of the Classified Department of the Sun-Sentinel, daily newspaper published in Broward/Palm Beach/Miami-Dade County, Florida, that the attached copy of advertisement, being, a Public Notice in the matter of Intent to Issue PSD Permit Modification in the paper October 4, 2008 - AD#13625503 Affiant further says that the said Sun-Sentinel is a newspaper published in said Broward/Palm Beach/Miami-Dade County, Florida, and that the said newspaper has heretofore been continuously published in said Broward/Palm Beach/Miami-Dade County, Florida, each day, and has entered as second class matter at the post office in Fort Lauderdale, in said Broward County, Florida, for a period of one year next preceding the first publication of the attached copy of advertisement; and affiant says that he/she has neither paid, nor promised, any person, firm or corporation any discount, rebate, commission or refund for the purpose of securing this advertisement for publication in said newspaper.

James H Croteau

(Signature of Affiant) October 6, 2008

NOTARY PUBLIC-STATE OF FLORIDA

Noreen Rubin

Commission # DD365661

Expires: OCT. 24, 2008

Bonded Thru Atlantic Bonding Co., Inc.

Noreen Rubin

(Signature of Notary Public)

(Name of Notary typed, printed or stamped) Personally

Known or Produced Identification

PUBLIC NOTICE OF INTENT TO ISSUE PSD PERMIT MODIFICATION

Florida Department of Environmental Protection
Division of Air Resource Management, Bureau of Air Regulation
DEP File No. PSD-FL-105C (0112119-010-AC)
Wheelabrator South Broward, Inc.
Waste-to-Energy Facility Units 1, 2 and 3
Activated Carbon Injection (ACI) System
Broward County

Applicant: The applicant for this project is Wheelabrator South Broward, Inc. The applicant's authorized representative and mailing address is: Mr. Jairaj Gossine, Plant Manager, South Broward Waste-to-Energy Facility, 4400 South State Road 7, Ft. Lauderdale, Florida 33314

Facility Location: The applicant, Wheelabrator South Broward, Inc. (Wheelabrator) operates the existing South Broward Waste-to-Energy (WTE) Facility, which is located in Broward County at 4400 South State Road 7 in Ft. Lauderdale.

Project: On September 11, 2008, Wheelabrator submitted an application for modification of its construction permit that was previously issued pursuant to the rules for the prevention of significant deterioration of air quality (PSD Permit). The requested modification is to authorize the installation of an ACI system on three municipal waste combustor (MWC) designated as Units 1, 2 and 3 for the purpose of reducing mercury (Hg) emissions.

Emissions are controlled at the facility by a combination of selective non-catalytic reduction, spray dryer absorbers and fabric filters (SNCR/SDA/FF). The ACI systems will be used to inject powdered ACI in the exhaust gas prior to the SDA/FF for each unit. Hg will be adsorbed by the activated carbon that will in turn be retained in the SDA/FF residue.

The facility is required by April 28, 2009 to comply with a revision to 40 Code of Federal Regulation Part 60 (40 CFR 60), Subpart Cb-Emissions Guidelines and Compliance Times for Large Municipal Waste Combustors That are Constructed on or Before September 20, 1994. The present federal Hg emission standards applicable to gases discharged from the facility are 80 micrograms per dry standard cubic meter (ug/dscm) corrected to 7 percent oxygen or reduction of the potential Hg emission concentration by 85 percent by weight. The change will reduce the first of the standards from 80 to 50 ug/dscm. The ACI systems will make it possible to meet the lower value with a reasonable margin and will reduce the loading of Hg into the South Florida environment.

Permitting Authority: Applications for PSD permit modifications are subject to review in accordance with the provisions of Chapter 403, Florida Statutes (F.S.) and Chapters 62-4, 62-210, and 62-212 of the Florida Administrative Code (F.A.C.). The proposed project is not exempt from permitting requirements and a PSD permit modification is required to perform the proposed work. The Bureau of Air Regulation is the Permitting Authority responsible for making a permit determination for this project. The Permitting Authority's physical address is: 111 South Magnolia Drive, Suite 4, Tallahassee, Florida. The Permitting Authority's mailing address is: 2600 Blair Stone Road, Mail Station (MS) 5505, Tallahassee, Florida 32399-2400. The Permitting Authority's telephone number is 850/488-0114.

Project File: A complete project file is available for public inspection during the normal business hours of 8:00 a.m. to 5:00 p.m., Monday through Friday (except legal holidays), at address indicated above for the Permitting Authority. The complete project file includes the Draft PSD permit modification, the Technical Evaluation and Preliminary Determination, the application, and the information submitted by the applicant, exclusive of confidential records under Section 403.111, F.S. Interested persons may contact the Permitting Authority's project review engineer for additional information at the address or phone number listed above. In addition, electronic copies of these documents are available by entering the file number provided above where indicated on the following web site: www.dep.state.fl.us/air/eproducts/apds/default.asp

Notice of Intent to Issue PSD Permit Modification: The Permitting Authority gives notice of its intent to issue a PSD permit modification to the applicant for the project described above. The applicant has provided reasonable assurance that operation of the proposed equipment will not adversely impact air quality and that the project will comply with all appropriate provisions of Chapters 62-4, 62-204, 62-210, 62-212, 62-296 and 62-297, F.A.C. The Permitting Authority will issue a Final PSD permit modification in accordance with the conditions of the proposed Draft PSD permit modification unless a timely petition for an administrative hearing is filed under Sections 120.569 and 120.57, F.S. or unless public comment received in accordance with this notice results in a different decision or a significant change of terms or conditions.

Comments: The Permitting Authority will accept written comments concerning the proposed Draft PSD permit modification for a period of 14 days from the date of publication of the Public Notice. Written comments must be received by the Permitting Authority by close of business (5:00 p.m.) on or before the end of this 14-day period. If written comments received result in a significant change to the Draft PSD permit modification, the Permitting Authority shall revise the Draft PSD permit modification and require, if applicable, another Public Notice. All comments filed will be made available for public inspection.

Petitions: A person whose substantial interests are affected by the proposed permitting decision may petition for an administrative hearing in accordance with Sections 120.569 and 120.57, F.S. The petition must contain the information set forth below and must be filed with (received by) the Department's Agency Clerk in the Office of General Counsel of the Department of Environmental Protection at 3900 Commonwealth Boulevard, Mail Station 35, Tallahassee, Florida 32399-3000. Petitions filed by any persons other than those entitled to written notice under Section 120.60(3), F.S. must be filed within 14 days of publication of this Public Notice or receipt of a written notice, whichever occurs first. Under Section 120.60(3), F.S., however, any person who asked the Permitting Authority for notice of agency action may file a petition within 14 days of receipt of that notice, regardless of the date of publication.

A petitioner shall mail a copy of the petition to the applicant at the address indicated above, at the time of filing. The failure of any person to file a petition within the appropriate time period shall constitute a waiver of that person's right to request an administrative determination (hearing) under Sections 120.569 and 120.57, F.S., or to intervene in this proceeding and participate as a party to it. Any subsequent intervention (in a proceeding initiated by another party) will be only at the approval of the presiding officer upon the filing of a motion in compliance with Rule 28-106.205, F.A.C.

A petition that disputes the material facts on which the Permitting Authority's action is based must contain the following information: (a) The name and address of each agency affected and each agency's file or identification number, if known; (b) The name, address, and telephone number of the petitioner; the name, address and telephone number of the petitioner's representative, if any, which shall be the address for service purposes during the course of the proceeding; and an explanation of how the petitioner's substantial interests will be affected by the agency determination; (c) A statement of when and how each petitioner received notice of the agency action or proposed decision; (d) A statement of all disputed issues of material fact. If there are none, the petition must so state; (e) A concise statement of the ultimate facts alleged, including the specific facts the petitioner contends warrant reversal or modification of the agency's proposed action; (f) A statement of the specific rules or statutes the petitioner contends require reversal or modification of the agency's proposed action including an explanation of how the alleged facts relate to the specific rules or statutes; and, (g) A statement of the relief sought by the petitioner, stating precisely the action the petitioner wishes the agency to take with respect to the agency's proposed action. A petition that does not dispute the material facts upon which the Permitting Authority's action is based shall state that no such facts are in dispute and otherwise shall contain the same information as set forth above, as required by Rule 28-106.301, F.A.C.

Because the administrative hearing process is designed to formulate final agency action, the filing of a petition means that the Permitting Authority's final action may be different from the position taken by it in this Public Notice. Persons whose substantial interests will be affected by any such final decision of the Permitting Authority on the application have the right to petition to become a party to the proceeding, in accordance with the requirements set forth above.

Mediation: Mediation is not available in this proceeding.

October 4, 2008

0 11.2119

Florida Department of
Environmental Protection

Memorandum

TO: Trina Vielhauer
FROM: A.A. Linero 
DATE: September 24, 2008
SUBJECT: DEP File No. PSD-FL-105C (0112119-010-AC)
Wheelabrator South Broward Waste-to-Energy Facility
Municipal Waste Combustors - Units 1, 2 and 3
Activated Carbon Injection (ACI) Systems

This project is subject to minor source preconstruction review. Attached for your review are the following items:

- Written Notice of Intent to Issue PSD Permit Modification;
- Public Notice of Intent to Issue PSD Permit Modification;
- Technical Evaluation and Preliminary Determination;
- Draft Permit (letter) Modification; and
- P.E. Certification.

The Draft PSD Permit Modification authorizes the installation of activated carbon injection (ACI) systems on Units 1, 2 and 3 for the purpose of reducing mercury (Hg) emissions. The proposed work will be conducted at the Wheelabrator South Broward Waste-to-Energy Facility. The Technical Evaluation and Preliminary Determination document provides a detailed description of the project and the rationale for issuance. The P.E. certification briefly summarizes the proposed project.

I recommend your approval of the attached Draft PSD Permit Modification.

Attachments

PROFESSIONAL ENGINEER CERTIFICATION STATEMENT

PERMITTEE

Wheelabrator South Broward, Inc.
4400 South State Road 7
Ft. Lauderdale, Florida 33314

DEP File No. PSD-FL-105C (0112119-010-AC)
South Broward Waste-to-Energy Facility
Activated Carbon Injection (ACI) System
Broward County, Florida

Project: Installation of an ACI system on three municipal waste combustors designated as Units 1, 2 and 3 for the purpose of reducing mercury (Hg) emissions.

Emissions are controlled at the facility by a combination of selective non-catalytic reduction, spray dryer absorbers and fabric filters (SNCR/SDA/FF). The ACI system will be used to inject powdered activated carbon in the exhaust gas prior to SDA/FF at each unit. Hg will be adsorbed by the activated carbon that will in turn be retained in the SDA/FF residue.

The facility is required by April 28, 2009 to comply with a revision to 40 Code of Federal Regulations Part 60, Subpart Cb-Emissions Guidelines and Compliance Times for Large Municipal Waste Combustors That are Constructed on or Before September 20, 1994. The present federal Hg emission standards applicable to gases discharged from the facility are 80 micrograms per dry standard cubic meter ($\mu\text{g}/\text{dscm}$) corrected to 7 percent oxygen or reduction of the potential Hg emission concentration by 85 percent by weight. The change will reduce the first of the standards from 80 to 50 $\mu\text{g}/\text{dscm}$. The ACI system will make it possible to meet the lower value with a reasonable margin and will reduce the loading of Hg into the South Florida environment.

I prepared and the Department distributed a technical evaluation and preliminary determination containing the details of the project and rationale for the preliminary decision to issue a permit for the ACI system.

I HEREBY CERTIFY that the air pollution control engineering features described in the above referenced application and subject to the proposed permit conditions provide reasonable assurance of compliance with applicable provisions of Chapter 403, Florida Statutes, and Florida Administrative Code Chapters 62-4 and 62-204 through 62-297. However, I have not evaluated and I do not certify aspects of the proposal outside of my area of expertise (including, but not limited to, the electrical, mechanical, structural, hydrological, geological, and meteorological features).



Alvaro A. Linero, P.E.
Registration Number: 260320

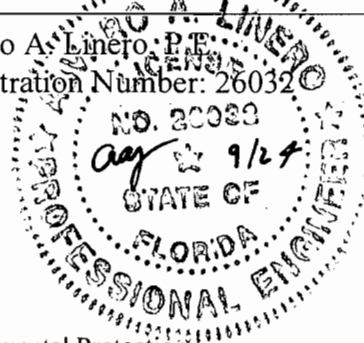

9/24/08

(Date)

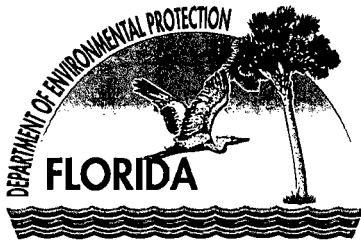

Florida Department of Environmental Protection

Bob Martinez Center
2600 Blairstone Road
Tallahassee, Florida 32399-2400

Charlie Crist
Governor
Jeff Kottkamp
Lt. Governor
Michael W. Sole
Secretary

September 26, 2008

Electronically Sent – Received Receipt Requested.

jgosine@wm.com

Mr. Jairaj Gosine, Plant Manager
South Broward Waste-to-Energy Facility
Wheelabrator South Broward, Inc.
4400 South State Road 7
Ft. Lauderdale, Florida 33314

Re: DEP File No. PSD-FL-105C (0112119-010-AC)
Installation of Activated Carbon Injection (ACI) Systems
Units 1, 2 and 3

Dear Mr. Gosine:

On September 11, 2008, you submitted an application to modify the original Prevention of Significant Deterioration (PSD) permit to install ACI systems on Units 1, 2 and 3 at the facility identified above. Enclosed are the following documents:

- Written Notice of Intent to Issue PSD Permit Modification;
- Public Notice of Intent to Issue PSD Permit Modification;
- Technical Evaluation and Preliminary Determination; and
- Draft PSD Permit (letter) Modification.

The Public Notice of Intent to Issue PSD Permit Modification is the actual notice that you must have published in the legal advertisement section of a newspaper of general circulation in the area affected by this project.

If you have any questions, please contact A. A. Linero, Program Administrator at (850) 921-9523.

Sincerely,

Trina Vielhauer, Chief
Bureau of Air Regulation

TLV/aal/th

Enclosures

WRITTEN NOTICE OF INTENT TO ISSUE PSD PERMIT MODIFICATION

In the Matter of an
Application for PSD Permit Modification by:

Mr. Jairaj Gosine, Plant Manager
South Broward Waste-to-Energy Facility
Wheelabrator South Broward, Inc.
4400 South State Road 7
Ft. Lauderdale, Florida 33314

DEP File No. PSD-FL-105C (0112119-010-AC)
South Broward Waste-to-Energy Facility
Municipal Waste Combustors - Units 1, 2 and 3
Activated Carbon Injection (ACI) System
Broward County, Florida

Facility Location: The applicant, Wheelabrator South Broward, Inc. (Wheelabrator) operates the existing South Broward Waste-to Energy (WTE) Facility, which is located in Broward County at 4400 South State Road 7 in Ft. Lauderdale.

Project: On September 11, 2008, Wheelabrator submitted an application for modification of its permit that was previously issued pursuant to the rules for the prevention of significant deterioration of air quality (PSD Permit). The requested modification is to authorize the installation of an ACI system on Units 1, 2 and 3 for the purpose of reducing mercury (Hg) emissions.

The facility is required by April 28, 2009 to comply with a revision to 40 Code of Federal Regulation Part 60, Subpart Cb-Emissions Guidelines and Compliance Times for Large Municipal Waste Combustors That are Constructed on or Before September 20, 1994. The present federal Hg emission standards applicable to gases discharged from the facility are 80 micrograms per dry standard cubic meter ($\mu\text{g}/\text{dscm}$) corrected to 7 percent oxygen or reduction of the potential Hg emission concentration by 85 percent by weight. The change will reduce the first of the standards from 80 to 50 $\mu\text{g}/\text{dscm}$. The ACI system will make it possible to meet the lower value with a reasonable margin.

Permitting Authority: Applications for air construction permits are subject to review in accordance with the provisions of Chapter 403, Florida Statutes (F.S.) and Chapters 62-4, 62-210, and 62-212 of the Florida Administrative Code (F.A.C.). The proposed project is not exempt from permitting requirements and a PSD Permit Modification is required to perform the proposed work. The Bureau of Air Regulation is the Permitting Authority responsible for making a permit determination for this project. The Permitting Authority's physical address is: 111 South Magnolia Drive, Suite 4, Tallahassee, Florida. The Permitting Authority's mailing address is: 2600 Blair Stone Road, Mail Station (MS) 5505, Tallahassee, Florida 32399-2400. The Permitting Authority's telephone number is 850/488-0114.

Project File: A complete project file is available for public inspection during the normal business hours of 8:00 a.m. to 5:00 p.m., Monday through Friday (except legal holidays), at address indicated above for the Permitting Authority. The complete project file includes the Draft Permit, the Technical Evaluation and Preliminary Determination, the applications, and the information submitted by the applicant, exclusive of confidential records under Section 403.111, F.S. Interested persons may contact the Permitting Authority's project review engineer for additional information at the address or phone number listed above. In addition, electronic copies of these documents are available by entering the file number provided above where indicated on the following web site:

<http://www.dep.state.fl.us/air/eproducts/apds/default.asp>

Notice of Intent to Issue PSD Permit Modification: The Permitting Authority gives notice of its intent to issue a PSD Permit Modification to the applicant for the project described above. The applicant has provided reasonable assurance that operation of the proposed equipment will not adversely impact air quality and that the project will comply with all appropriate provisions of Chapters 62-4, 62-204, 62-210, 62-212, 62-296 and 62-297, F.A.C. The Permitting Authority will issue a Final Permit in accordance with the conditions of the proposed Draft Permit unless a timely petition for an administrative hearing is filed under Sections 120.569 and 120.57, F.S. or unless public comment received in accordance with this notice results in a different decision or a significant change of terms or conditions.

WRITTEN NOTICE OF INTENT TO ISSUE PSD PERMIT MODIFICATION

Public Notice: Pursuant to Section 403.815, F.S. and Rules 62-110.106 and 62-210.350, F.A.C., you (the applicant) are required to publish at your own expense the enclosed Public Notice of Intent to Issue PSD Permit Modification (Public Notice). The Public Notice shall be published one time only as soon as possible in the legal advertisement section of a newspaper of general circulation in the area affected by this project. The newspaper used must meet the requirements of Sections 50.011 and 50.031, F.S. in the county where the activity is to take place. If you are uncertain that a newspaper meets these requirements, please contact the Permitting Authority at above address or phone number. Pursuant to Rule 62-110.106(5) and (9), F.A.C., the applicant shall provide proof of publication to the Permitting Authority at the above address within 7 days of publication. Failure to publish the notice and provide proof of publication may result in the denial of the permit pursuant to Rule 62-110.106(11), F.A.C.

Comments: The Permitting Authority will accept written comments concerning the proposed Draft Permit for a period of 14 days from the date of publication of the Public Notice. Written comments must be received by the Permitting Authority by close of business (5:00 p.m.) on or before the end of this 14-day period. If written comments received result in a significant change to the Draft Permit, the Permitting Authority shall revise the Draft Permit and require, if applicable, another Public Notice. All comments filed will be made available for public inspection.

Petitions: A person whose substantial interests are affected by the proposed permitting decision may petition for an administrative hearing in accordance with Sections 120.569 and 120.57, F.S. The petition must contain the information set forth below and must be filed with (received by) the Department's Agency Clerk in the Office of General Counsel of the Department of Environmental Protection, 3900 Commonwealth Boulevard, MS 35, Tallahassee, Florida 32399-3000. Petitions filed by the applicant or any of the parties listed below must be filed within 14 days of receipt of this Written Notice of Intent to Issue PSD Permit Modification. Petitions filed by any persons other than those entitled to written notice under Section 120.60(3), F.S., must be filed within 14 days of publication of the attached Public Notice or within 14 days of receipt of this Written Notice of Intent to Issue PSD Permit Modification, whichever occurs first. Under Section 120.60(3), F.S., however, any person who asked the Permitting Authority for notice of agency action may file a petition within 14 days of receipt of that notice, regardless of the date of publication. A petitioner shall mail a copy of the petition to the applicant at the address indicated above, at the time of filing. The failure of any person to file a petition within the appropriate time period shall constitute a waiver of that person's right to request an administrative determination (hearing) under Sections 120.569 and 120.57, F.S., or to intervene in this proceeding and participate as a party to it. Any subsequent intervention (in a proceeding initiated by another party) will be only at the approval of the presiding officer upon the filing of a motion in compliance with Rule 28-106.205, F.A.C.

A petition that disputes the material facts on which the Permitting Authority's action is based must contain the following information: (a) The name and address of each agency affected and each agency's file or identification number, if known; (b) The name, address, and telephone number of the petitioner; the name, address and telephone number of the petitioner's representative, if any, which shall be the address for service purposes during the course of the proceeding; and an explanation of how the petitioner's substantial interests will be affected by the agency determination; (c) A statement of when and how each petitioner received notice of the agency action or proposed decision; (d) A statement of all disputed issues of material fact. If there are none, the petition must so state; (e) A concise statement of the ultimate facts alleged, including the specific facts the petitioner contends warrant reversal or modification of the agency's proposed action; (f) A statement of the specific rules or statutes the petitioner contends require reversal or modification of the agency's proposed action including an explanation of how the alleged facts relate to the specific rules or statutes; and, (g) A statement of the relief sought by the petitioner, stating precisely the action the petitioner wishes the agency to take with respect to the agency's proposed action. A petition that does not dispute the material facts upon which the Permitting Authority's action is based shall state that no such facts are in dispute and otherwise shall contain the same information as set forth above, as required by Rule 28-106.301, F.A.C.

WRITTEN NOTICE OF INTENT TO ISSUE PSD PERMIT MODIFICATION

Because the administrative hearing process is designed to formulate final agency action, the filing of a petition means that the Permitting Authority's final action may be different from the position taken by it in this Written Notice of Intent to Issue PSD Permit Modification. Persons whose substantial interests will be affected by any such final decision of the Permitting Authority on the application have the right to petition to become a party to the proceeding, in accordance with the requirements set forth above.

Mediation: Mediation is not available in this proceeding.

Executed in Tallahassee, Florida.

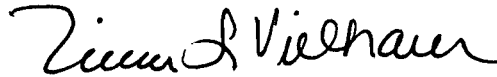

Trina Vielhauer, Chief
Bureau of Air Regulation

CERTIFICATE OF SERVICE

The undersigned duly designated deputy agency clerk hereby certifies that this Written Notice of Intent to Issue PSD Permit Modification package (including the Public Notice, the Technical Evaluation and Preliminary Determination, and the Draft PSD Permit Modification) was sent by electronic mail (or a link to these documents made available electronically on a publicly accessible server) with received receipt requested before the close of business on 9/26/08 to the persons listed below.

- Jairaj Gosine, Wheelabrator: jgosine@wm.com
- Bertha Henry, Interim Administrator, Broward County: bhenry@broward.org
- Jack Long, DEP SED: jack.long@dep.state.fl.us
- Mike Halpin, DEP Siting Office: mike.halpin@dep.state.fl.us
- Ken Kosky, P.E., Golder: Ken_Kosky@golder.com
- Kathy Forney, EPA Region 4: forney.kathleen@epamail.epa.gov
- Ms. Vickie Gibson, DEP BAR: Victoria.Gibson@dep.state.fl.us (for read file)

Clerk Stamp

FILING AND ACKNOWLEDGMENT FILED, on this date, pursuant to §120.52, Florida Statutes, with the designated Department Clerk, receipt of which is hereby acknowledged.

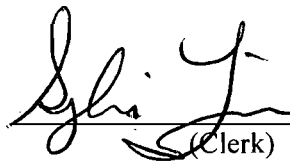
(Clerk)

9/26/08
(Date)

PUBLIC NOTICE OF INTENT TO ISSUE PSD PERMIT MODIFICATION

Florida Department of Environmental Protection
Division of Air Resource Management, Bureau of Air Regulation
DEP File No. PSD-FL-105C (0112119-010-AC)
Wheelabrator South Broward, Inc.
Waste-to-Energy Facility Units 1, 2 and 3
Activated Carbon Injection (ACI) System
Broward County

Applicant: The applicant for this project is Wheelabrator South Broward, Inc. The applicant's authorized representative and mailing address is: Mr. Jairaj Gosine, Plant Manager, South Broward Waste-to-Energy Facility, 4400 South State Road 7, Ft. Lauderdale, Florida 33314

Facility Location: The applicant, Wheelabrator South Broward, Inc. (Wheelabrator) operates the existing South Broward Waste-to Energy (WTE) Facility, which is located in Broward County at 4400 South State Road 7 in Ft. Lauderdale.

Project: On September 11, 2008, Wheelabrator submitted an application for modification of its construction permit that was previously issued pursuant to the rules for the prevention of significant deterioration of air quality (PSD Permit). The requested modification is to authorize the installation of an ACI system on three municipal waste combustor (MWC) designated as Units 1, 2 and 3 for the purpose of reducing mercury (Hg) emissions.

Emissions are controlled at the facility by a combination of selective non-catalytic reduction, spray dryer absorbers and fabric filters (SNCR/SDA/FF). The ACI systems will be used to inject powdered ACI in the exhaust gas prior to the SDA/FF for each unit. Hg will be adsorbed by the activated carbon that will in turn be retained in the SDA/FF residue.

The facility is required by April 28, 2009 to comply with a revision to 40 Code of Federal Regulation Part 60 (40 CFR 60), Subpart Cb-Emissions Guidelines and Compliance Times for Large Municipal Waste Combustors That are Constructed on or Before September 20, 1994. The present federal Hg emission standards applicable to gases discharged from the facility are 80 micrograms per dry standard cubic meter ($\mu\text{g}/\text{dscm}$) corrected to 7 percent oxygen or reduction of the potential Hg emission concentration by 85 percent by weight. The change will reduce the first of the standards from 80 to 50 $\mu\text{g}/\text{dscm}$. The ACI systems will make it possible to meet the lower value with a reasonable margin and will reduce the loading of Hg into the South Florida environment.

Permitting Authority: Applications for PSD permit modifications are subject to review in accordance with the provisions of Chapter 403, Florida Statutes (F.S.) and Chapters 62-4, 62-210, and 62-212 of the Florida Administrative Code (F.A.C.). The proposed project is not exempt from permitting requirements and a PSD permit modification is required to perform the proposed work. The Bureau of Air Regulation is the Permitting Authority responsible for making a permit determination for this project. The Permitting Authority's physical address is: 111 South Magnolia Drive, Suite 4, Tallahassee, Florida. The Permitting Authority's mailing address is: 2600 Blair Stone Road, Mail Station (MS) 5505, Tallahassee, Florida 32399-2400. The Permitting Authority's telephone number is 850/488-0114.

Project File: A complete project file is available for public inspection during the normal business hours of 8:00 a.m. to 5:00 p.m., Monday through Friday (except legal holidays), at address indicated above for the Permitting Authority. The complete project file includes the Draft PSD permit modification, the Technical Evaluation and Preliminary Determination, the application, and the information submitted by the applicant, exclusive of confidential records under Section 403.111, F.S. Interested persons may contact the Permitting Authority's project review engineer for additional information at the address or phone number listed above. In addition, electronic copies of these documents are available by entering the file number provided above where indicated on the following web site:

www.dep.state.fl.us/air/eproducts/apds/default.asp .

Notice of Intent to Issue PSD Permit Modification: The Permitting Authority gives notice of its intent to issue a PSD permit modification to the applicant for the project described above. The applicant has provided reasonable assurance that operation of the proposed equipment will not adversely impact air quality and that the project will comply with all appropriate provisions of Chapters 62-4, 62-204, 62-210, 62-212, 62-296 and 62-297, F.A.C. The Permitting Authority will issue a Final PSD permit modification in accordance with the conditions of the proposed Draft PSD permit modification unless a timely petition for an administrative hearing is filed under Sections 120.569 and 120.57, F.S. or unless public comment received in accordance with this notice results in a different decision or a significant change of terms or conditions.

Comments: The Permitting Authority will accept written comments concerning the proposed Draft PSD permit modification for a period of 14 days from the date of publication of the Public Notice. Written comments must be received by the Permitting Authority by close of business (5:00 p.m.) on or before the end of this 14-day period. If written comments received result in a significant change to the Draft PSD permit modification, the Permitting Authority shall revise the Draft PSD permit modification and require, if applicable, another Public Notice. All comments filed will be made available for public inspection.

Petitions: A person whose substantial interests are affected by the proposed permitting decision may petition for an administrative hearing in accordance with Sections 120.569 and 120.57, F.S. The petition must contain the information set forth below and must be filed with (received by) the Department's Agency Clerk in the Office of General Counsel of the Department of Environmental Protection at 3900 Commonwealth Boulevard, Mail Station 35, Tallahassee, Florida 32399-3000. Petitions filed by any persons other than those entitled to written notice under Section 120.60(3), F.S. must be filed within 14 days of publication of this Public Notice or receipt of a written notice, whichever occurs first. Under Section 120.60(3), F.S., however, any person who asked the Permitting Authority for notice of agency action may file a petition within 14 days of receipt of that notice, regardless of the date of publication.

A petitioner shall mail a copy of the petition to the applicant at the address indicated above, at the time of filing. The failure of any person to file a petition within the appropriate time period shall constitute a waiver of that person's right to request an administrative determination (hearing) under Sections 120.569 and 120.57, F.S., or to intervene in this proceeding and participate as a party to it. Any subsequent intervention (in a proceeding initiated by another party) will be only at the approval of the presiding officer upon the filing of a motion in compliance with Rule 28-106.205, F.A.C.

A petition that disputes the material facts on which the Permitting Authority's action is based must contain the following information: (a) The name and address of each agency affected and each agency's file or identification number, if known; (b) The name, address, and telephone number of the petitioner; the name, address and telephone number of the petitioner's representative, if any, which shall be the address for service purposes during the course of the proceeding; and an explanation of how the petitioner's substantial interests will be affected by the agency determination; (c) A statement of when and how each petitioner received notice of the agency action or proposed decision; (d) A statement of all disputed issues of material fact. If there are none, the petition must so state; (e) A concise statement of the ultimate facts alleged, including the specific facts the petitioner contends warrant reversal or modification of the agency's proposed action; (f) A statement of the specific rules or statutes the petitioner contends require reversal or modification of the agency's proposed action including an explanation of how the alleged facts relate to the specific rules or statutes; and, (g) A statement of the relief sought by the petitioner, stating precisely the action the petitioner wishes the agency to take with respect to the agency's proposed action. A petition that does not dispute the material facts upon which the Permitting Authority's action is based shall state that no such facts are in dispute and otherwise shall contain the same information as set forth above, as required by Rule 28-106.301, F.A.C.

Because the administrative hearing process is designed to formulate final agency action, the filing of a petition means that the Permitting Authority's final action may be different from the position taken by it in this Public Notice. Persons whose substantial interests will be affected by any such final decision of the Permitting Authority on the application have the right to petition to become a party to the proceeding, in accordance with the requirements set forth above.

Mediation: Mediation is not available in this proceeding.

(Public Notice to be Published in the Newspaper)

TECHNICAL EVALUATION
AND
PRELIMINARY DETERMINATION

Wheelabrator South Broward, Inc.
Installation of an Activated Carbon Injection System
South Broward Facility Units 1, 2 and 3
Municipal Waste Combustors
Broward County

DEP File No. 0112119-010-AC
PSD-FL-105C



Department of Environmental Protection
Division of Air Resources Management
Bureau of Air Regulation

September 26, 2008

TECHNICAL EVALUATION AND PRELIMINARY DETERMINATION

1. GENERAL PROJECT INFORMATION

Facility Description and Location

The applicant, Wheelabrator South Broward, Inc. (Wheelabrator) operates the existing South Broward Waste-to Energy (WTE) Facility, which is located in Broward County at 4400 South State Road 7 in Ft. Lauderdale. The UTM coordinates are Zone 17; 579.5 kilometers (km) East and 2,883.34 km North.

The facility is comprised of three municipal waste combustors (MWC), which are categorized under Standard Industrial Classification (SIC) Code No. 4953. This site is in an area that is in attainment (or designated as unclassifiable) for all air pollutants subject to a National Ambient Air Quality Standard (NAAQS).

The following map indicates the location of the existing Wheelabrator South Broward WTE Facility.



Wheelabrator South Broward WTE Facility location in Fort Lauderdale.

Facility Regulatory Categories

Title III: The existing facility is identified as a potential major source of hazardous air pollutants (HAP).

Title V: The existing facility is a Title V major source of air pollution in accordance with Chapter 213, Florida Administrative Code (F.A.C.).

Prevention of Significant Deterioration (PSD): The existing facility is a PSD-major source of air pollution in accordance with Rule 62-212.400, F.A.C.

Facility Description

This facility consists of three MWC with auxiliary burners, lime storage and processing facilities, ash storage and processing facilities, a cooling tower, and ancillary support equipment. Each unit has a maximum capacity of 863 tons per day (TPD) of waste input. There is a metal's recovery system which is a potential source of fugitive emissions. The nominal (generator nameplate) electric generating capacity of the facility is 67.6 megawatts (MW), which is sold to the local utility.

Following is a photograph of the front of the Wheelabrator South Broward WTE Facility (Source Wheelabrator) and a photograph of the rear of the nearly identical Wheelabrator North Broward WTE (Linero 1999). The three exhaust gas ducts from the boilers are visible along with the exhaust stack containing the three flues.

TECHNICAL EVALUATION AND PRELIMINARY DETERMINATION



Photographs of Wheelabrator South and North WTE Facilities.

The following diagram is of the basic waste-to-energy process and control equipment at a typical Wheelabrator facility. Each unit includes an acid gas, air toxics, and particulate emissions control system consisting of: a urea injection system that operates on the principle of selective non-catalytic reduction (SNCR); a lime spray dryer absorber (SDA); and a fabric filter baghouse (FF).

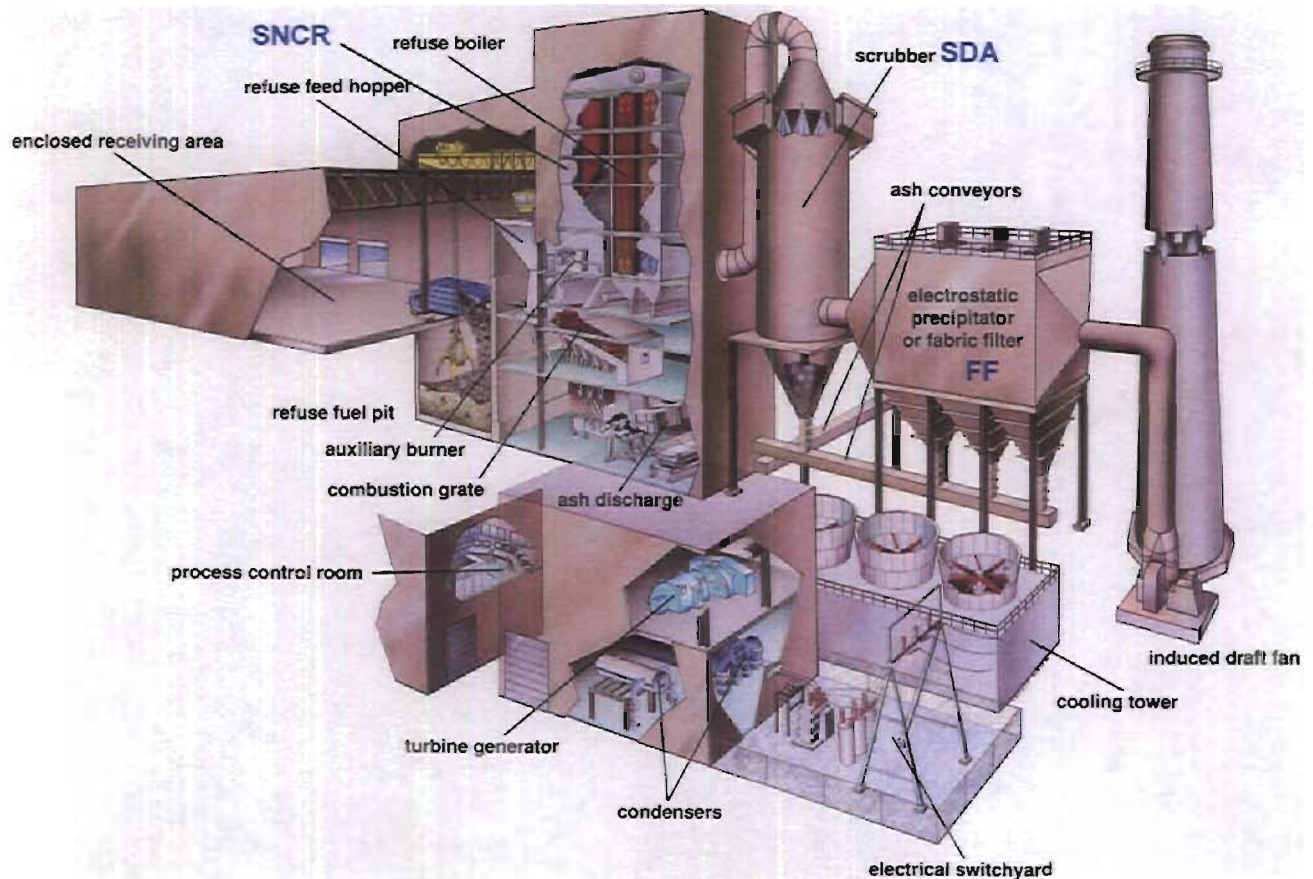

Wheelabrator Mass Burn Waste-to-Energy Process including Pollution Control System.

The three MWC are designated as Emissions Units (E.U.) Nos. 1, 2 and 3 and are listed in the following table from the most recent PSD Permit modification and Title V operation permits issued to Wheelabrator.

TECHNICAL EVALUATION AND PRELIMINARY DETERMINATION

E.U. ID No.	Brief Description
001	863 TPD (maximum) Municipal Waste Combustor & Auxiliary Burners - Unit 1
002	863 TPD (maximum) Municipal Waste Combustor & Auxiliary Burners - Unit 2
003	863 TPD (maximum) Municipal Waste Combustor & Auxiliary Burners - Unit 3

Project Description

Wheelabrator submitted an application for modification of its prevention of significant deterioration of air quality (PSD Permit) originally issued by the U.S. Environmental Protection Agency (EPA). The requested modification is to authorize the installation of an activated carbon injection (ACI) system at the facility for the purpose of reducing mercury (Hg) emissions. The system will consist of:

- One powdered activated carbon storage silo sufficient for the three boilers and with a nominal storage capacity of 3,200 cubic feet;
- One vent dust baghouse collector used during pneumatic loading of the silo from tanker truck; and
- Rotary feeders, hoppers, screw feeders and blower assemblies.

The system will inject powdered activated carbon in the flue gas at a location between the boiler and SDA on each unit as shown in the following diagram.

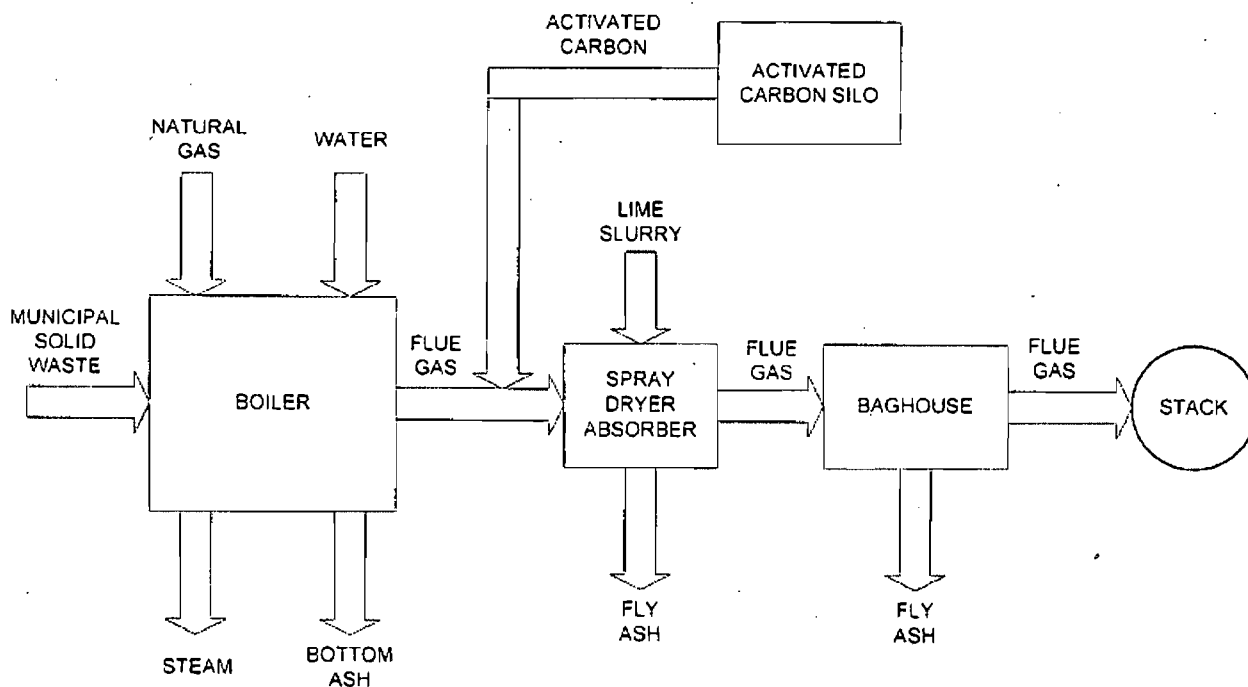

Relation of ACI System to the Process at Wheelabrator South WTE Facility.

There will not be other changes to the existing system to accommodate the ACI system. The project involves no changes in the previously permitted emission, production and fuel use limitations compared with those in the Permit PSD-FL-105 and modifications thereto (PSD-105A and 105B) and the facility Title V operation permit.

TECHNICAL EVALUATION AND PRELIMINARY DETERMINATION

The original Permit PSD-FL-105 required the SDA and FF. Permit Modification PSD-105B authorized the SNCR system. The present application for Permit Modification PSD-FL-105C is to authorize the ACI system for further Hg control. The ACI system for Hg control should also enhance dioxin/furan (D/F) control.

The facility's Title V operation permit will be updated at a future date to reflect more stringent applicable standards and the installation of the ACI system.

Processing Schedule

09/11/2008 Received the application for a minor source air pollution construction permit.
09/26/2008 Department distributed draft Intent to Issue package.

2. APPLICABLE REGULATIONS

State Regulations

This project is subject to the applicable environmental laws specified in Section 403 of the Florida Statutes (F.S.). The Florida Statutes authorize the Department of Environmental Protection to establish rules and regulations regarding air quality as part of the F.A.C. The facility is subject to the applicable rules and regulations defined in the following Chapters of the F.A.C.

<u>Chapter</u>	<u>Description</u>
62-4	Permits
62-204	Air Pollution Control – General Provisions
62-210	Stationary Sources – General Requirements
62-212	Stationary Sources Preconstruction Review
62-213	Operation Permits for Major Sources of Air Pollution
62-296	Stationary Sources – Emissions Standards
62-297	Stationary Sources – Emissions Monitoring

Federal Regulations

The facility was or is subject to the applicable federal provisions regarding air quality as established by the EPA in the following sections of the Code of Federal Regulations (CFR).

<u>Title 40, CFR</u>	<u>Description</u>
Section 52.21	Prevention of Significant Deterioration of Air Quality
Part 60	Subpart A Standards of Performance for New Stationary Sources – General Provisions.
	Subpart Cb Emissions Guidelines and Compliance Times for Large Municipal Waste Combustors that are Constructed Before September 20, 1994.

TECHNICAL EVALUATION AND PRELIMINARY DETERMINATION

General PSD Applicability

The Department regulates major air pollution sources in accordance with Florida's PSD program, as approved by the EPA in Florida's State Implementation Plan and defined in Rule 62-212.400, F.A.C. A PSD review is required in areas currently in attainment with the state and federal Ambient Air Quality Standards (AAQS) or areas designated as "unclassifiable" for a given pollutant. A new facility is considered "major" with respect to PSD if it emits or has the potential to emit:

- 250 tons per year or more of any regulated air pollutant, or
- 100 tons per year or more of any regulated air pollutant and the facility belongs to one of the 28 PSD Major Facility Categories as defined in 62-210.200, F.A.C., or
- 5 tons per year of lead.

For new projects at PSD-major sources, each regulated pollutant is reviewed for PSD applicability based on emissions thresholds known as the "Significant Emission Rates" listed in definitions at Rule 62-210.200, F.A.C. Pollutant emissions from the project exceeding these rates are considered "significant" and the applicant must employ the Best Available Control Technology (BACT) to minimize emissions of each such pollutant and evaluate the air quality impacts. Although a facility may be "major" with respect to PSD for only one regulated pollutant, it may be required to install BACT controls for several "significant" regulated pollutants.

Permitting Requirements and PSD Applicability for ACI Project

A PSD permit with a BACT determination was issued in 1987 by EPA for the Wheelabrator South Broward WTE Facility. Subsequent modifications were made by the Department to that permit primarily to clarify the fuel slate and to reflect more stringent standards and controls required following promulgation by EPA of 40 CFR 60, Subpart.

The project is subject to Section 62-210.300(1)(a), F.A.C., which states:

- (a) Unless exempt from permitting pursuant to paragraph 62-210.300(3)(a) or (b), F.A.C., or Rule 62-4.040, F.A.C., an air construction permit shall be obtained by the owner or operator of any proposed new, reconstructed, or modified facility or emissions unit, **or any new pollution control equipment** prior to the beginning of construction, reconstruction pursuant to 40 CFR 60.15 or 63.2, or modification of the facility or emissions unit or addition of the air pollution control equipment; or to establish a PAL; in accordance with all applicable provisions of this chapter, Chapter 62-212, F.A.C., and Chapter 62-4, F.A.C.*

Therefore, an air construction permit is required and the Department will process the application as a modification to the original authority to construct, i.e. Permit PSD-FL-105.

No changes in permitted emissions, production or fuel use limitations for the three units are requested in the present modification request. There will be emissions less than 1 ton per year from the vent dust baghouse collector used during pneumatic loading of the silo from tanker truck. Therefore, the project constitutes a modification that on its own would be exempt from permitting but for the fact that it involves the installation of control equipment on the three units.

TECHNICAL EVALUATION AND PRELIMINARY DETERMINATION

The key definition of “major source modification” is given at Rule 62-210.200 (192), F.A.C. as follows:

- (a) *Any physical change in or change in the method of operation of a major stationary source that would result in a significant emissions increase of a PSD pollutant and a significant net emissions increase of that pollutant from the major stationary source.*

Besides the minimal emissions from the vent baghouse, there will be no emission increases and likely some emission decreases from Units 1, 2 and 3 caused by the project. Therefore, the project will not result in a significant net emission increase of a PSD pollutant and will not trigger a new PSD review and BACT determination.

3. EMISSIONS STANDARDS

Brief Discussion of Emissions

Per the most recent revision of Subpart Cb, the present federal Hg emission standards applicable to emissions from the facility are 80 micrograms per dry standard cubic meter ($\mu\text{g}/\text{dscm}$) corrected to 7 percent oxygen or reduction of the potential Hg emission concentration by 85 percent (%) by weight, whichever is less stringent.

The State of Florida standards at Section 62-296.416(3)(a)1., F.A.C. are 70 $\mu\text{g}/\text{dscm}$ or 80% reduction. The facility is required by April 28, 2009 to meet the latest revision of Subpart Cb which will limit Hg emissions to 50 $\mu\text{g}/\text{dscm}$ or 85%.

The reported emission concentrations from the three units in $\mu\text{g}/\text{dscm}$ over the past few years are given in the table below from stack tests that are done quarterly on alternating emissions units. Values greater than 50 $\mu\text{g}/\text{dscm}$ are highlighted.

Year/Unit	Unit 1	Unit 2	Unit 3
2001	11, 20	15, 22	12, 57
2002	17, 20	13, 43	43, 14
2003	69 , 17	22, 17	34, 29
2004	21, 9	32, 13	8, 12
2005	30, 14, 83	7, 20	8, 13
2006	14	4, 55	17, 40
2007	13, 18	14, 15	18, 8
2008	16	14	5

Based on a strictly statistical analysis, there is a probability that without additional controls emissions of Hg in the future will at times exceed 50 $\mu\text{g}/\text{dscm}$. Even though the facility could for some of the exceedances rely on the alternative value of 85% Hg removal, the most prudent option is to install additional Hg control capability. This will minimize the probability of exceeding the concentration standard and the removal standard.

Taken over the past ten years, emissions of Hg from the facility have been on the order of 150 pounds per year. This is much less than allowed when the facility was built, but comparable to some of the highest emitters in the state when considering other WTE facilities, cement plants and coal-fueled power plants. The ACI system will substantially reduce the emissions from the

TECHNICAL EVALUATION AND PRELIMINARY DETERMINATION

plant to concentration well below the newly established concentration limits and will decrease the loading of Hg into the South Florida environment.

4. DRAFT PERMIT REQUIREMENTS

The only permit requirement for the ACI system involves language changes to the PSD Permit that:

- Authorize the installation of the ACI equipment; and
- Amend the provisions of the PSD Permit related to air pollution control equipment to reflect the installation of the ACI system.

This will allow construction to begin at the earliest date. The new limits pursuant to Subpart Cb will be incorporated by a revision to the facility's Title V operation permit, for which Wheelabrator has already applied.

The conditions are in the enclosed draft PSD permit modification and will include the following provisions:

1. Installation of Powdered Activated Carbon Injection (ACI) System: The permittee shall install a system to inject powdered activated carbon in the flue gas from the boiler at a location prior to the acid gas control device (SDA) to provide further control of mercury consisting of:
 - a. One powdered activated carbon storage silo sufficient for the three boilers and with a nominal storage capacity of 3,200 cubic feet;
 - b. One vent dust baghouse collector used during pneumatic loading of the silo from tanker truck; and
 - c. Rotary feeders, hoppers, screw feeders and blower assemblies.
2. Modification of PSD Permit: Permit PSD-FL-105, Condition 8, Air Pollution Control Equipment, is hereby modified by the addition of the following provision:
 - c. The facility shall be equipped with an ACI system as described above to provide additional control of mercury emissions from each boiler.

5. PRELIMINARY DETERMINATION

The Department makes a preliminary determination that the proposed project will comply with all applicable state and federal air pollution regulations as conditioned by the draft permit. This determination is based on a technical review of the complete application, reasonable assurances provided by the applicant, and the conditions specified in the draft permit. No air quality modeling analysis is required because the project does not result in a significant increase in emissions. Alvaro Linero is the project engineer responsible for reviewing the application and drafting the permit. Additional details of this analysis may be obtained by contacting the project engineer at the Department's Bureau of Air Regulation at Mail Station #5505, 2600 Blair Stone Road, Tallahassee, Florida 32399-2400.

DRAFT PERMIT

PERMITTEE

Wheelabrator South Broward, Inc.
4400 South State Road 7
Ft. Lauderdale, Florida 33314

Authorized Representative:
Jairaj Gosine, Plant Manager

DEP File No. PSD-FL-105C (0112119-010-AC)
South Broward Waste-to-Energy Facility
Municipal Waste Combustors, Units 1, 2 and 3
Activated Carbon Injection System
Expiration date: June 30, 2009
Broward County, Florida

PROJECT AND LOCATION

The project is the installation of an activated carbon injection system on three municipal waste combustors designated as Units 1, 2 and 3 at the Wheelabrator South Broward Waste-to-Energy Facility. The purpose of the project is to reduce mercury emissions.

The facility is located in Broward County at 4400 South State Road 7 in Ft. Lauderdale. The UTM coordinates for this site are Zone 17, 579.54 kilometers (km) East and 2883.34 km North.

STATEMENT OF BASIS

This is a modification of the facility Prevention of Significant Deterioration (PSD) permit and is issued under the provisions of Chapter 403 of the Florida Statutes (F.S.), and Chapters 62-4, 62-204, 62-210, 62-212, 62-296 and 62-297 of the Florida Administrative Code (F.A.C.) and Title 40, Parts 60 and 63 of the Code of Federal Regulations (CFR). The permittee is authorized to install the proposed equipment in accordance with the conditions of this permit and as described in the application, approved drawings, plans, and other documents on file with the Department.

CONTENTS

- Section 1. Facility Information
- Section 2. Administrative Requirements
- Section 3. Emissions Units Specific Conditions
- Section 4. Appendices

Joseph Kahn, Director
Division of Air Resource
Management

(Date)

SECTION I. FACILITY INFORMATION (DRAFT)

FACILITY DESCRIPTION

This facility consists of three municipal solid waste combustors (MWC); Units 1, 2 and 3 with auxiliary burners, lime storage and processing facilities, ash storage and processing facilities, a cooling tower, and ancillary support equipment. Each unit has a maximum capacity of 863 tons per day (TPD) of waste input. There is a metals recovery system which is a potential source of fugitive emissions. The nominal (generator nameplate) electric generating capacity of the facility is 67.6 megawatts (MW), which is sold to the local utility. Also included in this permit are miscellaneous insignificant emissions units and/or activities.

Each unit includes an acid gas, air toxics, and particulate emissions control system consisting of a lime spray dryer absorber and fabric filter baghouse (SDA/FF). Nitrogen oxides are controlled by a urea injection system that operates under the principle of selective non-catalytic reduction (SNCR).

EMISSIONS UNITS

This facility consists of the following emissions units (EU) listed below.

E.U. ID No.	Brief Description
001	863 TPD (maximum) Municipal Waste Combustor & Auxiliary Burners - Unit 1
002	863 TPD (maximum) Municipal Waste Combustor & Auxiliary Burners - Unit 2
003	863 TPD (maximum) Municipal Waste Combustor & Auxiliary Burners - Unit 3
004	236 Ton Lime Silo with a Baghouse
005	Ash Handling System

PROJECT

The project is the installation of a system to inject powdered activated carbon in the flue gas from Units 1, 2 and 3 at a location prior to the acid gas control device on each unit to provide further control of mercury emissions. The system will consist of:

- One powdered activated carbon storage silo sufficient for the three boilers and with a nominal storage capacity of 3,200 cubic feet;
- One vent dust baghouse collector used during pneumatic loading of the silo from tanker truck; and
- Rotary feeders, hoppers, screw feeders and blower assemblies.

REGULATORY CLASSIFICATION

The facility is a major Prevention of Significant Deterioration (PSD) stationary source in accordance with Rule 62-212.400, F.A.C. The proposed project does not trigger the PSD rules as a Major Stationary Source Modification or a determination of best available control technology (BACT). The project does require a modification of the initial facility PSD permit.

The facility is a Title V major source of air pollution in accordance with Chapter 213, Florida Administrative Code (F.A.C.).

SECTION I. FACILITY INFORMATION (DRAFT)

The facility operates units subject to the Standards of Performance for New Stationary Sources (NSPS) pursuant to 40 Code of Federal Regulations Part 60 (40 CFR 60). Units 1, 2 and 3 are subject to 40 CFR 60, Subpart Cb-Emissions Guidelines and Compliance Times for Large Municipal Waste Combustors That are Constructed on or Before September 20, 1994.

The existing facility is a major source of hazardous air pollutants (HAP). 40 CFR 60, Subpart Cb addresses the HAP control requirements pursuant to Section 129 of the Clean Air Act.

The facility was certified under the Florida Power Plant Siting Act (FPPSA), 403.501-518, F.S.

RELEVANT DOCUMENTS

The following relevant documents are not a part of this permit modification, but helped form the basis for this permitting action or include important additional requirements applicable to the facility:

- Permit PSD-FL-105 issued by the Environmental Protection Agency (EPA) Region 4 office on May 17, 1987 that authorized construction of the facility;
- An amendment to Permit PSD-FL-105 issued by the Department on March 21, 1996 that allowed use of EPA Method 7E to measure emissions of nitrogen oxides (NO_x) as an alternative to EPA Method 7;
- Permit Modification PSD-FL-105A issued by the Department on May 22, 1997 that allowed the use of EPA Method 29 to measure emissions of mercury (Hg);
- Permit Modification PSD-FL-105B issued by the Department on September 28, 1999 to install a selective non-catalytic reduction system, revise permit conditions consistent with 40 CFR 60, Subpart Cb, permit metals recovery operations, and define the fuel slate for the facility;
- Current facility Title V Air Operation Permit Renewal No. 0112119-010-AV issued on February 23, 2006;
- Application received on September 11, 2008 to install an activated carbon injection system; and,
- The Department's draft permit package including the Technical Evaluation and Preliminary Determination and dated September 26, 2008.

SECTION II. ADMINISTRATIVE REQUIREMENTS (DRAFT)

GENERAL AND ADMINISTRATIVE REQUIREMENTS

1. Permitting Authority: All documents related to applications for permits to construct, modify or operate this emissions unit shall be submitted to the Bureau of Air Regulation (BAR), Florida Department of Environmental Protection (DEP), at 2600 Blair Stone Road, Tallahassee, Florida 32399-2400 and phone number 850/488-0114. Copies of these documents shall be submitted to the Compliance Authority.
2. Compliance Authority: All documents related to compliance activities such as reports, tests, and notifications shall be submitted to the Southeast District Office. The mailing address and phone number of the Southeast District Office are: Department of Environmental Protection, Southeast District Office, 400 North Congress Avenue, Suite 200, West Palm Beach, Florida 33401. Telephone: (561)681-6632. Fax: (561)681-6790.
3. Appendices: The following Appendices are attached as part of this permit modification: Appendices Cb and GC (General Conditions).
4. Applicable Regulations, Forms and Application Procedures: Unless otherwise specified in this permit, the construction and operation of the subject emissions units shall be in accordance with the capacities and specifications stated in the application. The facility is subject to all applicable provisions of: Chapter 403, F.S.; and Chapters 62-4, 62-204, 62-210, 62-212, 62-213, 62-214, 62-296 and 62-297, F.A.C. Issuance of this permit does not relieve the permittee from compliance with any applicable federal, state, or local permitting or regulations.
5. New or Additional Conditions: For good cause shown and after notice and an administrative hearing, if requested, the Department may require the permittee to conform to new or additional conditions. The Department shall allow the permittee a reasonable time to conform to the new or additional conditions, and on application of the permittee, the Department may grant additional time. [Rule 62-4.080, F.A.C.]
6. Modifications: No emissions unit shall be constructed or modified without obtaining an air construction permit from the Department. Such permit shall be obtained prior to beginning construction or modification. [Rules 62-210.300(1) and 62-212.300(1)(a), F.A.C.]
7. Construction and Expiration: The permit expiration date includes sufficient time to complete construction and submit an application for a Title V operation permit to the Department. For good cause, the permittee may request that this PSD permit modification be extended. Such a request shall be submitted to the Department's Bureau of Air Regulation at least sixty (60) days prior to the expiration of this permit. [Rules 62-4.070(4), 62-4.080, 62-210.300(1) and 62-212.400(6)(b), F.A.C.]
8. Title V Permit: This PSD permit modification authorizes installation of the activated carbon injection project. This project involves no changes in the descriptions, applicable requirements, or conditions of the facility Title V Operation Permit at this time. However, the permittee is required to apply for a revised Title V operation permit by October 31, 2008 to incorporate a revision promulgated on May 10, 2006 by EPA of 40 CFR 60, Subpart Cb and as incorporated in Section 62-204.204.800(b), F.A.C.

SECTION III. EMISSIONS UNITS SPECIFIC CONDITIONS (DRAFT)

Units 1, 2 and 3 – Municipal Waste Combustors

The proposed project affects the following existing units:

E.U. ID No.	Brief Description
001	863 TPD (maximum) Municipal Waste Combustor & Auxiliary Burners - Unit 1
002	863 TPD (maximum) Municipal Waste Combustor & Auxiliary Burners - Unit 2
003	863 TPD (maximum) Municipal Waste Combustor & Auxiliary Burners - Unit 3

ADMINISTRATIVE REQUIREMENTS

1. Previous Permit Conditions: This PSD permit modification authorizes the installation of an activated carbon injection system on three municipal waste combustors designated as Units 1, 2 and 3. The following conditions are in addition to those of any other PSD permits, modifications thereto or operation permits. [Rule 62-4.210, F.A.C.]

CONSTRUCTION ACTIVITIES

2. Installation of Powdered Activated Carbon Injection (ACI) System: The permittee shall install a system to inject powdered activated carbon in the flue gas from the boiler at a location prior to the acid gas control device to provide further control of mercury consisting of:
 - a. One powdered activated carbon storage silo sufficient for the three boilers and with a nominal storage capacity of 3,200 cubic feet;
 - b. One vent dust baghouse collector used during pneumatic loading of the silo from tanker truck; and
 - c. Rotary feeders, hoppers, screw feeders and blower assemblies.

(Applicants Request)

3. Modification of PSD Permit: Permit PSD-FL-105, Condition 8, Air Pollution Control Equipment, is hereby modified by the addition of the following provision:
 - c. The facility shall be equipped with an ACI system as described above to provide additional control of mercury emissions from each boiler.

EMISSION REQUIREMENTS

4. Emission Limits and Testing Requirements: No additional limits or testing requirements are applicable to Units 1, 2 and 3 as a result of this project.

{Permitting Note: The applicable emission limits are specified or maintained in the PSD permit, modifications thereto and the facility Title V operation permit.}

NOTIFICATIONS AND REPORTS

5. Notifications: Within one week of beginning construction, the permittee shall notify the Compliance Authority that the project has commenced and provide a general schedule of construction activities. Within one week of completing construction, the permittee shall notify the Compliance Authority that the project has concluded and provide a general schedule of bringing the unit back on line. [Rule 62-4.210, F.A.C.]

SECTION IV. APPENDICES (DRAFT)

Appendix Cb- Emissions Guidelines for Large Municipal Waste Combustors

Applicability of 40 CFR 60, Subpart Cb - Emissions Guidelines and Compliance Times for Large Municipal Waste Combustors That are Constructed on or Before September 20, 1994.

Wheelabrator South Broward Units 1, 2 and 3 are Large Municipal Waste Combustor (Large MWC) because they are waste combustion units that are each capable of combusting more than 250 tons per day (TPD) of municipal solid waste (MSW).

The rules applicable to Large MWC are given at 40 CFR 60, Sections 60.30b through 60.39b. Units 1, 2 and 3 are Mass Burn Waterwall Furnaces. The emission limits applicable to this category of MWC are specified by type of combustor in the relevant sections, paragraphs and tables that address individual pollutants including carbon monoxide (CO), nitrogen oxides (NO_x), sulfur dioxide (SO₂), hydrogen chloride (HCl), particulate matter (PM), dioxin/furan (D/F), opacity, cadmium (Cd), mercury (Hg), and lead (Pb). The various emission monitoring and operational parameters are included therein.

Subpart 40 CFR 60, Subpart Cb was revised on May 10, 2006. Units 1, 2 and 3 are subject to those revisions. The Department is reopening the Title V operation permits or processing applications to incorporate the updated requirements in each facility subject to Subpart Cb. The updated requirements will be included in the revised permits.

The revised version of 40 CFR 60, Subpart Cb is available at:

<http://ecfr.gpoaccess.gov/cgi/t/text/text-idx?c=ecfr&sid=9f85cb975ad1fc48e7b80bf5309b6e08&rgn=div6&view=text&node=40:6.0.1.1.1.5&idno=40>

PERMIT

SECTION IV. APPENDICES (DRAFT)

Appendix GC - General Conditions

- G.1. The terms, conditions, requirements, limitations, and restrictions set forth in this permit are "Permit Conditions" and are binding and enforceable pursuant to Sections 403.161, 403.727, or 403.859 through 403.861, Florida Statutes. The permittee is placed on notice that the Department will review this permit periodically and may initiate enforcement action for any violation of these conditions.
- G.2. This permit is valid only for the specific processes and operations applied for and indicated in the approved drawings or exhibits. Any unauthorized deviation from the approved drawings or exhibits, specifications, or conditions of this permit may constitute grounds for revocation and enforcement action by the Department.
- G.3. As provided in Subsections 403.087(6) and 403.722(5), Florida Statutes, the issuance of this permit does not convey and vested rights or any exclusive privileges. Neither does it authorize any injury to public or private property or any invasion of personal rights, nor any infringement of federal, state or local laws or regulations. This permit is not a waiver or approval of any other Department permit that may be required for other aspects of the total project which are not addressed in the permit.
- G.4. This permit conveys no title to land or water, does not constitute State recognition or acknowledgment of title, and does not constitute authority for the use of submerged lands unless herein provided and the necessary title or leasehold interests have been obtained from the State. Only the Trustees of the Internal Improvement Trust Fund may express State opinion as to title.
- G.5. This permit does not relieve the permittee from liability for harm or injury to human health or welfare, animal, or plant life, or property caused by the construction or operation of this permitted source, or from penalties therefore; nor does it allow the permittee to cause pollution in contravention of Florida Statutes and Department rules, unless specifically authorized by an order from the Department.
- G.6. The permittee shall properly operate and maintain the facility and systems of treatment and control (and related appurtenances) that are installed or used by the permittee to achieve compliance with the conditions of this permit, as required by Department rules. This provision includes the operation of backup or auxiliary facilities or similar systems when necessary to achieve compliance with the conditions of the permit and when required by Department rules.
- G.7. The permittee, by accepting this permit, specifically agrees to allow authorized Department personnel, upon presentation of credentials or other documents as may be required by law and at a reasonable time, access to the premises, where the permitted activity is located or conducted to:
- Have access to and copy and records that must be kept under the conditions of the permit;
 - Inspect the facility, equipment, practices, or operations regulated or required under this permit, and,
 - Sample or monitor any substances or parameters at any location reasonably necessary to assure compliance with this permit or Department rules.

Reasonable time may depend on the nature of the concern being investigated.

- G.8. If, for any reason, the permittee does not comply with or will be unable to comply with any condition or limitation specified in this permit, the permittee shall immediately provide the Department with the following information:
- A description of and cause of non-compliance; and
 - The period of noncompliance, including dates and times; or, if not corrected, the anticipated time the non-compliance is expected to continue, and steps being taken to reduce, eliminate, and prevent recurrence of the non-compliance.

SECTION IV. APPENDICES (DRAFT)

Appendix GC - General Conditions

The permittee shall be responsible for any and all damages, which may result and may be subject to enforcement action by the Department for penalties or for revocation of this permit.

- G.9. In accepting this permit, the permittee understands and agrees that all records, notes, monitoring data and other information relating to the construction or operation of this permitted source which are submitted to the Department may be used by the Department as evidence in any enforcement case involving the permitted source arising under the Florida Statutes or Department rules, except where such use is prescribed by Sections 403.73 and 403.111, Florida Statutes. Such evidence shall only be used to the extent it is consistent with the Florida Rules of Civil Procedure and appropriate evidentiary rules.
- G.10. The permittee agrees to comply with changes in Department rules and Florida Statutes after a reasonable time for compliance, provided, however, the permittee does not waive any other rights granted by Florida Statutes or Department rules.
- G.11. This permit is transferable only upon Department approval in accordance with Florida Administrative Code Rules 62-4.120 and 62-730.300, F.A.C., as applicable. The permittee shall be liable for any non-compliance of the permitted activity until the transfer is approved by the Department.
- G.12. This permit or a copy thereof shall be kept at the work site of the permitted activity.
- G.13. This permit also constitutes:
- (a) Determination of Best Available Control Technology (not applicable to project);
 - (b) Determination of Prevention of Significant Deterioration (not applicable to project); and
 - (c) Compliance with New Source Performance Standards (not applicable to project).
- G.14. The permittee shall comply with the following:
- (a) Upon request, the permittee shall furnish all records and plans required under Department rules. During enforcement actions, the retention period for all records will be extended automatically unless otherwise stipulated by the Department.
 - (b) The permittee shall hold at the facility or other location designated by this permit records of all monitoring information (including all calibration and maintenance records and all original strip chart recordings for continuous monitoring instrumentation) required by the permit, copies of all reports required by this permit, and records of all data used to complete the application or this permit. These materials shall be retained at least three years from the date of the sample, measurement, report, or application unless otherwise specified by Department rule.
 - (c) Records of monitoring information shall include:
 - 1. The date, exact place, and time of sampling or measurements;
 - 2. The person responsible for performing the sampling or measurements;
 - 3. The dates analyses were performed;
 - 4. The person responsible for performing the analyses;
 - 5. The analytical techniques or methods used; and
 - 6. The results of such analyses.
- G.15. When requested by the Department, the permittee shall within a reasonable time furnish any information required by law, which is needed to determine compliance with the permit. If the permittee becomes aware that relevant facts were not submitted or were incorrect in the permit application or in any report to the Department, such facts or information shall be corrected promptly.

Livingston, Sylvia

From: Livingston, Sylvia
Sent: Friday, September 26, 2008 11:27 AM
To: 'jgosine@wm.com'
Cc: 'bhenry@broward.org'; Long, Jack; Halpin, Mike; 'Ken_Kosky@golder.com'; 'forney.kathleen@epamail.epa.gov'; Gibson, Victoria; Walker, Elizabeth (AIR); Linero, Alvaro; Read, David
Subject: WHEELABRATOR SOUTH BROWARD; 0112119-010-AC (PSD-FL-105C)
Attachments: 0112119-010-AC INTENT105C.pdf

Dear Sir/Madam:

Attached is the official *Written Notice of Intent to Issue* for the project referenced below. Click on the link displayed below to access the permit project documents and send a "reply" message verifying receipt of the document(s) provided in the link; this may be done by selecting "Reply" on the menu bar of your e-mail software, *noting that you can view the documents*, and then selecting "Send". **We must receive verification that you are able to access the documents.** Your immediate reply will preclude subsequent e-mail transmissions to verify accessibility of the document(s).

Click on the following link to access the permit project documents:

http://ARM-PERMIT2K.dep.state.fl.us/adh/prod/pdf_permit_zip_files/0112119.010.AC.D_pdf.zip

Owner/Company Name: WHEELABRATOR SOUTH BROWARD, INC
Facility Name: WHEELABRATOR SOUTH BROWARD
Project Number: 0112119-010-AC/ PSD-FL-105C
Permit Status: DRAFT
Permit Activity: CONSTRUCTION/ ACTIVATED CARBON INJECTION SYS
Facility County: BROWARD
Processor: David Read/ Al Linero

The Bureau of Air Regulation is issuing electronic documents for permits, notices and other correspondence in lieu of hard copies through the United States Postal System, to provide greater service to the applicant and the engineering community. Access these documents by clicking on the link provided above, or search for other project documents using the "*Air Permit Documents Search*" website at <http://www.dep.state.fl.us/air/eproducts/apds/default.asp>.

Permit project documents are addressed in this email may require immediate action within a specified time frame. Please open and review the document(s) as soon as possible, and verify that they are accessible. Please advise this office of any changes to your e-mail address or that of the Engineer-of-Record. If you have any problems opening the documents or would like further information, please contact the Florida Department of Environmental Protection, Bureau of Air Regulation at (850)488-0114.

Thank you,

Sylvia Livingston
Bureau of Air Regulation
Division of Air Resource Management (DARM)
850/921-0771

Livingston, Sylvia

From: Gosine, Jairaj [jgosine@WM.com]
Sent: Tuesday, September 30, 2008 11:13 AM
To: Livingston, Sylvia
Cc: Faller, Chuck
Subject: RE: WHEELABRATOR SOUTH BROWARD; 0112119-010-AC (PSD-FL-105C)

Dear Ms. Livingston,

This e-mail reply acknowledges the receipt of documents relating to the construction of our Activated Carbon System.

Thank you,
Jairaj Gosine

-----Original Message-----

From: Livingston, Sylvia [mailto:Sylvia.Livingston@dep.state.fl.us]
Sent: Friday, September 26, 2008 11:27 AM
To: Gosine, Jairaj
Cc: bhenry@broward.org; Long, Jack; Halpin, Mike; Ken_Kosky@golder.com; forney.kathleen@epamail.epa.gov; Gibson, Victoria; Walker, Elizabeth (AIR); Linero, Alvaro; Read, David
Subject: WHEELABRATOR SOUTH BROWARD; 0112119-010-AC (PSD-FL-105C)

Dear Sir/Madam:

Attached is the official *Written Notice of Intent to Issue* for the project referenced below. Click on the link displayed below to access the permit project documents and send a "reply" message verifying receipt of the document(s) provided in the link; this may be done by selecting "Reply" on the menu bar of your e-mail software, *noting that you can view the documents*, and then selecting "Send". **We must receive verification that you are able to access the documents.** Your immediate reply will preclude subsequent e-mail transmissions to verify accessibility of the document(s).

Click on the following link to access the permit project documents:

http://ARM-PERMIT2K.dep.state.fl.us/adh/prod/pdf_permit_zip_files/0112119.010.AC.D_pdf.zip

Owner/Company Name: WHEELABRATOR SOUTH BROWARD, INC
Facility Name: WHEELABRATOR SOUTH BROWARD
Project Number: 0112119-010-AC/ PSD-FL-105C
Permit Status: DRAFT
Permit Activity: CONSTRUCTION/ ACTIVATED CARBON INJECTION SYS
Facility County: BROWARD
Processor: David Read/ Al Linero

The Bureau of Air Regulation is issuing electronic documents for permits, notices and other correspondence in lieu of hard copies through the United States Postal System, to provide greater service to the applicant and the engineering community. Access these documents by clicking on the link provided above, or search for other project documents using the "*Air Permit Documents Search*" website at <http://www.dep.state.fl.us/air/eproducts/apds/default.asp>.

Permit project documents are addressed in this email may require immediate action within a specified time frame. Please open and review the document(s) as soon as possible, and verify that they are accessible. Please advise this office of any changes to your e-mail address or that of the Engineer-of-Record. If you have any problems opening the documents or would like further information, please contact the Florida Department of Environmental Protection, Bureau of Air Regulation at (850)488-0114.

Livingston, Sylvia

From: Busutil, Mary Beth [MBUSUTIL@broward.org]
Sent: Monday, September 29, 2008 10:04 AM
To: Livingston, Sylvia
Cc: Tewari, Ram; Meyers, Richard
Subject: RE: Reply: WHEELABRATOR SOUTH BROWARD; 0112119-010-AC (PSD-FL-105C)

As we discussed, the email was received and although I could not open the documents through the link, I was able to access them another way. In the future, I will be the contact, with Ram Tewari and Richard Meyers copied on all such correspondence. Thank you.

Mary Beth Busutil
Director
Broward County Waste & Recycling Services

From: Henry, Bertha
Sent: Saturday, September 27, 2008 3:34 PM
To: Busutil, Mary Beth; Hui, Tony; Brossard, Richard; Chambers, Cynthia
Subject: FW: WHEELABRATOR SOUTH BROWARD; 0112119-010-AC (PSD-FL-105C)

From: Livingston, Sylvia [mailto:Sylvia.Livingston@dep.state.fl.us]
Sent: Friday, September 26, 2008 11:27 AM
To: jgosine@wm.com
Cc: Henry, Bertha; Long, Jack; Halpin, Mike; Ken_Kosky@golder.com; forney.kathleen@epamail.epa.gov; Gibson, Victoria; Walker, Elizabeth (AIR); Linero, Alvaro; Read, David
Subject: WHEELABRATOR SOUTH BROWARD; 0112119-010-AC (PSD-FL-105C)

Dear Sir/Madam:

Attached is the official *Written Notice of Intent to Issue* for the project referenced below. Click on the link displayed below to access the permit project documents and send a "reply" message verifying receipt of the document(s) provided in the link; this may be done by selecting "Reply" on the menu bar of your e-mail software, *noting that you can view the documents*, and then selecting "Send". **We must receive verification that you are able to access the documents.** Your immediate reply will preclude subsequent e-mail transmissions to verify accessibility of the document(s).

Click on the following link to access the permit project documents:

http://ARM-PERMIT2K.dep.state.fl.us/adh/prod/pdf_permit_zip_files/0112119.010.AC.D_pdf.zip

Owner/Company Name: WHEELABRATOR SOUTH BROWARD, INC
Facility Name: WHEELABRATOR SOUTH BROWARD
Project Number: 0112119-010-AC/ PSD-FL-105C
Permit Status: DRAFT
Permit Activity: CONSTRUCTION/ ACTIVATED CARBON INJECTION SYS
Facility County: BROWARD
Processor: David Read/ Al Linero

The Bureau of Air Regulation is issuing electronic documents for permits, notices and other correspondence in lieu of hard copies through the United States Postal System, to provide greater service to the applicant and the engineering community. Access these documents by clicking on the link provided above, or search for other project documents using the "*Air Permit Documents Search*" website at <http://www.dep.state.fl.us/air/eproducts/apds/default.asp>.

9/29/2008

Linero, Alvaro

From: Gosine, Jairaj [jgosine@WM.com]
Sent: Monday, September 15, 2008 2:39 PM
To: Linero, Alvaro
Cc: Faller, Chuck; Porter, Timothy
Subject: Application for South Broward's Powdered Activated Carbon Injection System (PACIS)

Dear Mr. Linero,

As a follow up to the Air Construction Permit application submitted on September 10, 2008 by Golder Associates for the PACIS for Wheelabrator South Broward, please check the Title V box on our application which was inadvertently omitted on our original submittal.

I am the primary Title V Responsible Official for Wheelabrator South Broward.

If you have any questions please contact Chuck Faller or myself.

Respectfully,
Jairaj Gosine
Wheelabrator South Broward
4400 South State Road 7
Ft. Lauderdale, FL 33314
Office: 954-581-6606, x212
Cell: 954-214-2392

Sustainability: Meeting the needs of the present without compromising the ability of future generations to meet their own needs.

U.S. EPA

Livingston, Sylvia

From: Livingston, Sylvia
Sent: Friday, September 19, 2008 9:14 AM
To: Forney.Kathleen@epamail.epa.gov; dee_morse@nps.gov; Clifton Bittle (cbittle@broward.org)
Cc: Read, David; Walker, Elizabeth (AIR)
Subject: Wheelabrator South Broward, Inc. - 0112119-010-AC/ PSD 105C

Tracking: Recipient	Delivery	Read
Forney, Kathleen@epamail.epa.gov		
dee_morse@nps.gov		
Clifton Bittle (cbittle@broward.org)		
Read, David	Delivered: 9/19/2008 9:14 AM	Read: 9/19/2008 9:19 AM
Walker, Elizabeth (AIR)	Delivered: 9/19/2008 9:14 AM	

A new Permit Application has been received in Florida and is currently under review.

Link to Permit Application Documents:

<http://arm-permit2k.dep.state.fl.us/psd/0112119/000030DD.pdf>

ARMS PA Project ID: 0112119-010-AC/ PSD 105C

Facility Name: Wheelabrator South Broward, Inc.
Florida County: Broward
Project Description: ACTIVATED CARBON INJECTION SYS
Permit Application Processor: David Read
Processor Phone: (850) 414-7268
Processor Email Address: David.Read@dep.state.fl.us
Received in-house: 09/11/2008

Or, Search for other Air Permit Documents on [Florida's Air Permit Documents Search](#).

Please direct any questions regarding this permit application to the permit application processor. If you have any problems accessing these documents please let me know.

Thanks,

Sylvia Livingston
 Bureau of Air Regulations
 Division of Air Resource Management (DARM)
 850/921-0771

APPLICATION INFORMATION

Professional Engineer Certification

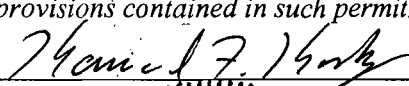
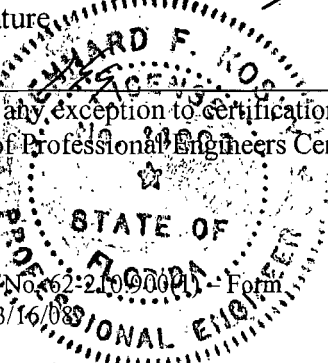
1. Professional Engineer Name: Kennard F. Kosky Registration Number: 14996
2. Professional Engineer Mailing Address... Organization/Firm: Golder Associates Inc.** Street Address: 6241 NW 23rd Street, Suite 500 City: Gainesville State: FL Zip Code: 32653
3. Professional Engineer Telephone Numbers... Telephone: (352) 336-5600 ext. Fax: (352) 336-6603
4. Professional Engineer E-mail Address: kkosky@golder.com
5. Professional Engineer Statement: <i>I, the undersigned, hereby certify, except as particularly noted herein*, that:</i> <i>(1) To the best of my knowledge, there is reasonable assurance that the air pollutant emissions unit(s) and the air pollution control equipment described in this application for air permit, when properly operated and maintained, will comply with all applicable standards for control of air pollutant emissions found in the Florida Statutes and rules of the Department of Environmental Protection; and</i> <i>(2) To the best of my knowledge, any emission estimates reported or relied on in this application are true, accurate, and complete and are either based upon reasonable techniques available for calculating emissions or, for emission estimates of hazardous air pollutants not regulated for an emissions unit addressed in this application, based solely upon the materials, information and calculations submitted with this application.</i> <i>(3) If the purpose of this application is to obtain a Title V air operation permit (check here <input checked="" type="checkbox"/> , if so), I further certify that each emissions unit described in this application for air permit, when properly operated and maintained, will comply with the applicable requirements identified in this application to which the unit is subject, except those emissions units for which a compliance plan and schedule is submitted with this application.</i> <i>(4) If the purpose of this application is to obtain an air construction permit (check here <input checked="" type="checkbox"/> , if so) or concurrently process and obtain an air construction permit and a Title V air operation permit revision or renewal for one or more proposed new or modified emissions units (check here <input type="checkbox"/> , if so), I further certify that the engineering features of each such emissions unit described in this application have been designed or examined by me or individuals under my direct supervision and found to be in conformity with sound engineering principles applicable to the control of emissions of the air pollutants characterized in this application.</i> <i>(5) If the purpose of this application is to obtain an initial air operation permit or operation permit revision or renewal for one or more newly constructed or modified emissions units (check here <input type="checkbox"/> , if so), I further certify that, with the exception of any changes detailed as part of this application, each such emissions unit has been constructed or modified in substantial accordance with the information given in the corresponding application for air construction permit and with all provisions contained in such permit.</i>  Signature _____ Date <u>9/18/09</u> (seal) 

RECEIVED

SEP 19 2008

BUREAU OF AIR REGULATION

* Attach any exception to certification statement.

**Board of Professional Engineers Certificate of Authorization #00001670.

APPLICATION INFORMATION

Purpose of Application

This application for air permit is being submitted to obtain: (Check one)

Air Construction Permit

- Air construction permit.
- Air construction permit to establish, revise, or renew a plantwide applicability limit (PAL).
- Air construction permit to establish, revise, or renew a plantwide applicability limit (PAL), and separate air construction permit to authorize construction or modification of one or more emissions units covered by the PAL.

Air Operation Permit

- Initial Title V air operation permit.
- Title V air operation permit revision.
- Title V air operation permit renewal.
- Initial federally enforceable state air operation permit (FESOP) where professional engineer (PE) certification is required.
- Initial federally enforceable state air operation permit (FESOP) where professional engineer (PE) certification is not required.

Air Construction Permit and Revised/Renewal Title V Air Operation Permit (Concurrent Processing)

- Air construction permit and Title V permit revision, incorporating the proposed project.
- Air construction permit and Title V permit renewal, incorporating the proposed project.

Note: By checking one of the above two boxes, you, the applicant, are requesting concurrent processing pursuant to Rule 62-213.405, F.A.C. In such case, you must also check the following box:

- I hereby request that the department waive the processing time requirements of the air construction permit to accommodate the processing time frames of the Title V air operation permit.

Application Comment

This application is to request the ability to install an activated carbon injection system on the municipal solid waste combustor units 1, 2, and 3 in order to achieve greater mercury control and meet the revised New Source Performance Standards (NSPS). Additionally, a silo will be installed for onsite storage of the activated carbon prior to its use in the combustors. This application also requests changes in the emission limits for cadmium, mercury, lead, and particulate matter in order to be consistent with the revised NSPS. The revised NSPS are applicable after April 28, 2009.

APPLICATION INFORMATION

Application Responsible Official Certification

Complete if applying for an initial, revised, or renewal Title V air operation permit or concurrent processing of an air construction permit and revised or renewal Title V air operation permit. If there are multiple responsible officials, the "application responsible official" need not be the "primary responsible official."

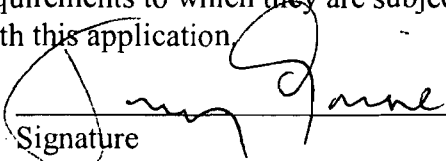
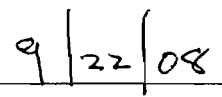
1. Application Responsible Official Name: Jairaj Gosine, Plant, Plant Manager
2. Application Responsible Official Qualification (Check one or more of the following options, as applicable): <input checked="" type="checkbox"/> For a corporation, the president, secretary, treasurer, or vice-president of the corporation in charge of a principal business function, or any other person who performs similar policy or decision-making functions for the corporation, or a duly authorized representative of such person if the representative is responsible for the overall operation of one or more manufacturing, production, or operating facilities applying for or subject to a permit under Chapter 62-213, F.A.C. <input type="checkbox"/> For a partnership or sole proprietorship, a general partner or the proprietor, respectively. <input type="checkbox"/> For a municipality, county, state, federal, or other public agency, either a principal executive officer or ranking elected official. <input type="checkbox"/> The designated representative at an Acid Rain source, CAIR source, or Hg Budget source.
3. Application Responsible Official Mailing Address... Organization/Firm: Wheelabrator South Broward, Inc. Street Address: 4400 South State Road 7 City: Ft. Lauderdale State: FL Zip Code: 33314
4. Application Responsible Official Telephone Numbers... Telephone: (954) 581-6606 ext. Fax: (954) 581-6705
5. Application Responsible Official E-mail Address: jgosine@wm.com
6. Application Responsible Official Certification: I, the undersigned, am a responsible official of the Title V source addressed in this air permit application. I hereby certify, based on information and belief formed after reasonable inquiry, that the statements made in this application are true, accurate and complete and that, to the best of my knowledge, any estimates of emissions reported in this application are based upon reasonable techniques for calculating emissions. The air pollutant emissions units and air pollution control equipment described in this application will be operated and maintained so as to comply with all applicable standards for control of air pollutant emissions found in the statutes of the State of Florida and rules of the Department of Environmental Protection and revisions thereof and all other applicable requirements identified in this application to which the Title V source is subject. I understand that a permit, if granted by the department, cannot be transferred without authorization from the department, and I will promptly notify the department upon sale or legal transfer of the facility or any permitted emissions unit. Finally, I certify that the facility and each emissions unit are in compliance with all applicable requirements to which they are subject, except as identified in compliance plan(s) submitted with this application.  Signature  Date