

**SANFORD PLANT**

---

**TITLE V PERMIT  
APPLICATION**

---

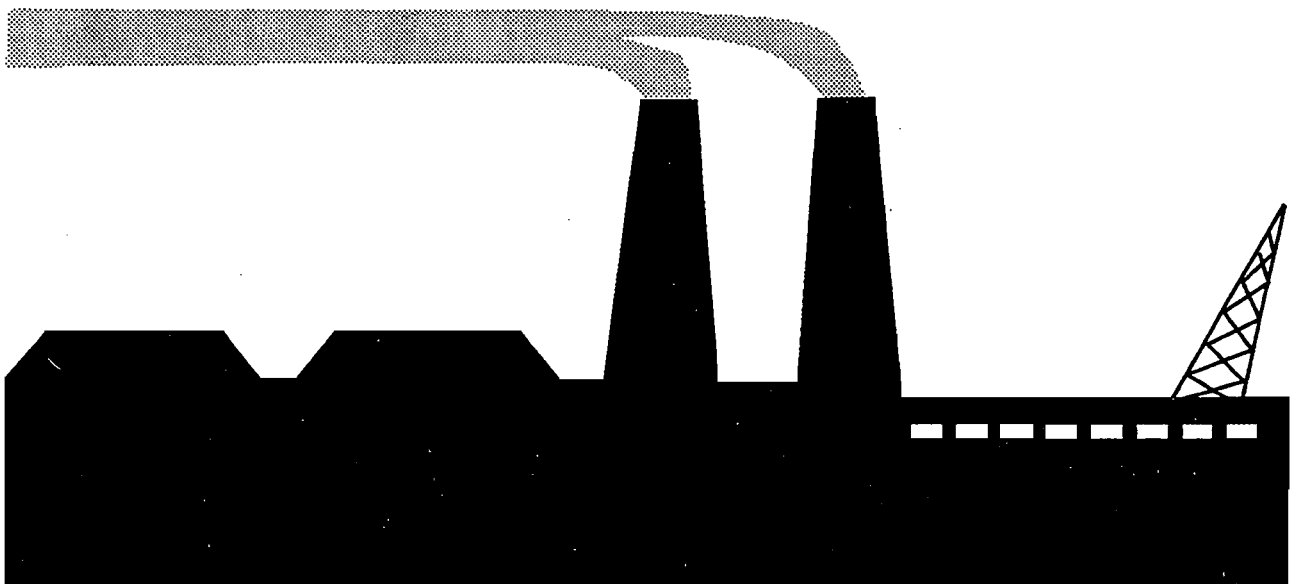



Florida Power & Light Company, P.O. Box 088801, North Palm Beach, FL 33408-8801

VIA AIRBORNE EXPRESS

June 10, 1996

Clair H. Fancy, P.E., Chief  
Bureau of Air Regulation  
State of Florida  
Department of Environmental Protection  
2600 Blair Stone Road  
Tallahassee, FL 32399-2400

RECEIVED  
JUN 12 1996  
BUREAU OF  
AIR REGULATION

**Re: Submittal of FPL Sanford Plant Title V Application**

Dear Mr. Fancy:

Enclosed, pursuant to DEP Rules 62-210.300(2), F.A.C., and 62-213.420(1)(a)1.a., F.A.C., please find four (4) hard copies of the subject Title V permit application. Due to the recent FDEP recall of the ELSA program, the diskettes containing the electronic application are not included at this time. FPL has worked diligently to prepare an electronic submittal and will submit diskettes containing the electronic application at a later date (when the ELSA program deficiencies have been resolved).

If you have any questions regarding this application, please do not hesitate to contact me at (561) 625-7661.

Very truly yours,

A handwritten signature in cursive script that reads "Richard Piper".

Richard Piper  
Environmental Specialist  
Florida Power & Light Company

cc: DEP Central District Office (w/o att)

LEADON - FOL FILES

TOM 8-12-99

Florida Power & Light Company, P.O. Box 088801, North Palm Beach, FL 33408-8801



FPL

RECEIVED

AUG 29 1996

BUREAU OF AIR REGULATION

*Kashong  
please visit scan  
then give to Tom  
Tom please update to ERS  
Amy  
Scott*

August 26, 1996

Clair H. Fancy, P.E., Chief  
Bureau of Air Regulation  
State of Florida  
Department of Environmental Protection  
2600 Blair Stone Road  
Tallahassee, FL 32399-2400

**Re: Electronic Submittal of FPL Sanford Plant Title V Application**

Dear Mr. Fancy:

Enclosed, pursuant to DEP Rules 62-210.300(2), F.A.C., and 62-213.420(1)(a)1.a., F.A.C., please find four (4) electronic copies of the subject Title V permit application in the ELSA format. Please note that these are in addition to the four hard copies which have previously been submitted to your office.

If you have any questions regarding this application, please do not hesitate to contact me at (561) 625-7661.

Very truly yours,

Richard Piper  
Senior Environmental Specialist  
Florida Power & Light Company

*US.  
yrb  
08/29*

cc:

DEP Central District Office (w/o att)

# Table of Contents

## Sanford Title V Application

Section 1 Application Information

Section 2 Facility Information

### Emission Unit Information

(Includes Emission Unit, Emission Point, Applicable Regulations, Segment, Pollutant, Visible Emission, Continuous Monitor, PSD Information and Supplemental Information)

Section 3 EU1 - Unit 3 Boiler

Section 4 EU2 - Unit 4 Boiler

Section 5 EU3 - Unit 5 Boiler

Section 6 EU4 - Unregulated Emission Units

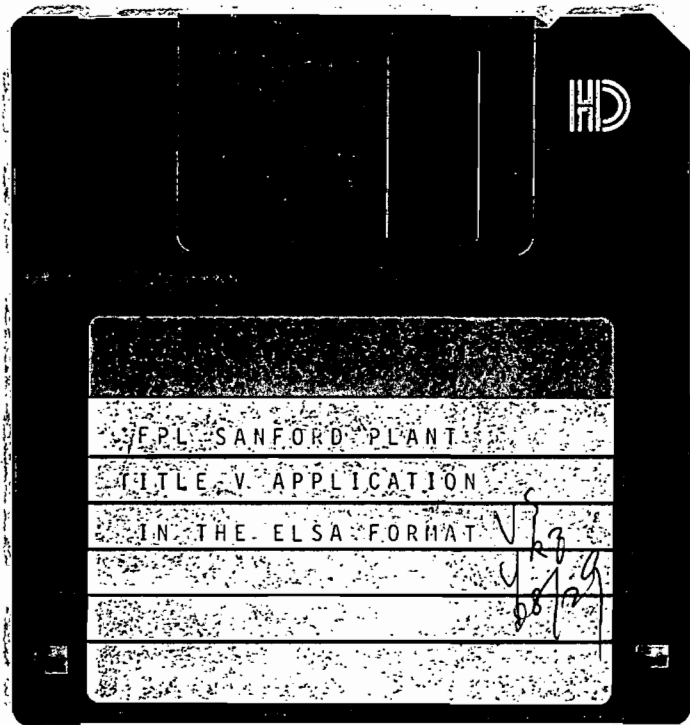

DEPARTMENT OF ENVIRONMENTAL PROTECTION  
DIVISION OF AIR RESOURCES MANAGEMENT

APPLICATION FOR AIR PERMIT - LONG FORM

See Instructions for Form No. 62-210.900(1)

**I. APPLICATION INFORMATION**

This section of the Application for Air Permit form identifies the facility and provides general information on the scope and purpose of this application. This section also includes information on the owner or authorized representative of the facility (or the responsible official in the case of a Title V source) and the necessary statements for the applicant and professional engineer, where required, to sign and date for formal submittal of the Application for Air Permit to the Department. If the application form is submitted to the Department using ELSA, this section of the Application for Air Permit must also be submitted in hard-copy form.

**Identification of Facility Addressed in This Application**

Enter the name of the corporation, business, governmental entity, or individual that has ownership or control of the facility; the facility site name, if any; and a brief reference to the facility's physical location. If known, also enter the facility identification number.

1. Facility Owner/Company Name: Florida Power & Light Company	
2. Site Name: Sanford Plant	
3. Facility Identification Number : 1270009	
4. Facility Location Information: Facility Street Address: P.O. Box 471088 City: Lake Monroe                      County: Volusia                      Zip Code: 32757-1088	
5. Relocatable Facility? (Y/N): N	6. Existing Permitted Facility?(Y/N): Y

**Application Processing Information (DEP Use)**

1. Date of Receipt of Application:	
2. Permit Number:	
3. PSD Number (if applicable):	
4. Siting Number (if applicable):	

**Owner/Authorized Representative or Responsible Official**

1. Name and Title of Owner/Authorized Representative or Responsible Official:

Name: Robert T. Ruhlman  
Title : Plant General Manager

2. Owner or Responsible Official Mailing Address:

Organization/Firm: Florida Power & Light Company, Environmental Affairs Department  
Street Address: 11770 U.S. Highway One, P.O. Box 088801  
City: North Palm Beach State: Florida Zip Code: 33408-8801

3. Owner or Responsible Official Telephone Numbers:

Telephone: (407)668-3685 Fax: (407)668-5183

4. Owner or Responsible Official Statement:

*I, the undersigned, am the owner or authorized representative\* of the non-Title V source addressed in this Application for Air Permit or the responsible official, as defined in Rule 62-210.200 F.A.C., of the Title V source addressed in this application, whichever is applicable. I hereby certify, based on information and belief formed after reasonable inquiry, that the statements made in this application are true, accurate and complete and that, to the best of my knowledge, any estimates of emissions reported in this application are based upon reasonable techniques for calculating emissions. The air pollutant emissions units and air pollution control equipment described in this application will be operated and maintained so as to comply with all applicable standards for control of air pollutant emissions found in the statues of the State of Florida and rules of the Department of Environmental Protection and revisions thereof. I understand that a permit, if granted by the Department, cannot be transferred without authorization from the Department, and I will promptly notify the Department upon sale or legal transfer of any permitted emissions unit.*

Signature 

Date 5/13/96

\* Attach letter of authorization if not currently on file.

**Scope of Application**

This Application for Air Permit addresses the following emissions unit(s) at the facility (or Title V source). An Emissions Unit Information Section (a Section III of the form) must be included for each emissions unit listed.

<b>Emission s Unit Id</b>	<b>Description of Emissions Unit</b>	<b>Permit Type</b>
O1	Fossil Fuel Steam Generator Unit 3 (ARMS ID # 30ORL64000901)	
O2	Fossil Fuel Steam Generator Unit 4 (ARMS ID # 30ORL64000902)	
O3	Fossil Fuel Steam Generator Unit 5 (ARMS ID # 30ORL64000903)	
O4	Unregulated Emission Units	

**Purpose of Application and Category**

Enter the Letter that applies and related information (except as otherwise indicated):

**Category I: All Air Operation Permit Applications Subject to Processing Under Chapter 17-213, F.A.C.**

This Application for Air Permit is submitted to obtain (A,B,C,D,E,F): **A**

[ A ] Initial air operation permit under Chapter 17-213, F.A.C., for an existing facility which is classified as a Title V source.

[ B ] Initial air operation permit under Chapter 17-213, F.A.C., for a facility which, upon start up of one or more newly constructed or modified emissions units addressed in this application, would become classified as a Title V source.

Current construction permit number:

[ C ] Air operation permit renewal under Chapter 17-213, F.A.C., for a Title V source.

Operation permit to be renewed:

[ D ] Air operation permit revision for a Title V source to address one or more newly constructed or modified emissions units addressed in this application.

Current construction permit number:

Operation permit to be revised:

[ E ] Air operation permit revision or administrative correction for a Title V source to address one or more proposed new or modified emissions units and to be processed concurrently with the air construction permit application for such emissions unit(s). Also check appropriate item under Category III.

Operation permit to be revised/corrected:

[ F ] Air operation permit revision for a Title V source for reasons other than construction or modification of an emissions unit. Give reason for the revision; e.g., to comply with a new applicable requirement or to request approval of an "Early Reductions" proposal.

Operation permit to be revised:

Reason for Revision:



**Category II: All Air Operation Permit Applications Subject to Processing Under Rule 17-210.300(2)(b), F.A.C.**

This Application for Air Permit is submitted to obtain (A,B,C):

- [ A ] Initial air operation permit under Rule 17-210.300(2)(b), F.A.C., for an existing facility seeking classification as a synthetic non-Title V source.

Current operation/construction permit number(s):

- [ B ] Renewal air operation permit under Rule 17-210.300(2)(b), F.A.C., for a synthetic non-Title V source.

Operation permit to be renewed:

- [ C ] Air operation permit revision for a synthetic non-Title V source. Give reason for revision; e.g., to address one or more newly constructed or modified emissions units addressed herein.

Operation permit to be revised:

Reason for revision:

**Category III: All Air Construction Permit Applications for All Facilities and Emissions Units**

This Application for Air Permit is submitted to obtain (A,B,C):

- [ A ] Air construction permit to construct or modify one or more emissions units within a facility (including any facility classified as a Title V source).

Current operation permit number(s), if any:

- [ B ] Air construction permit to make federally enforceable an assumed restriction on the potential emissions of one or more existing permitted emissions units.

Current operation permit number(s):

- [ C ] Air construction permit for one or more existing, but unpermitted, emissions units.

**Application Processing Fee**

Check one:

[ N ] Applicable (Y/N)                      Attached - Amount: \$

**Construction/Modification Information**

1. Description of Proposed Project or Alterations : N/A - Existing Facility
2. Projected or Actual Date of Commencement of Construction (DD-MON-YYYY):
3. Projected Dates of Completion of Construction (DD-MON-YYYY):

**Professional Engineer Certification**

1. Professional Engineer Name: Kennard F. Kosky Registration Number: 14966
2. Professional Engineer Mailing Address:  Organization/Firm: KBN Engineering Street Address: 6241 NW 23rd Street, Suite 500 City: Gainesville                                      State: Florida Zip Code: 32653-1500
3. Professional Engineer Telephone Numbers: Telephone: (352)336-5600                                      Fax: (352)336-6603

# SANFORD PLANT

## 4. Professional Engineer Statement:

*I, the undersigned, hereby certify, except as particularly noted herein\*, that:*

*(1) To the best of my knowledge, there is reasonable assurance that the air pollutant emissions unit(s) and the air pollution control equipment described in this Application for Air Permit, when properly operated and maintained, will comply with all applicable standards for control of air pollutant emissions found in the Florida Statutes and rules of the Department of Environmental Protection; and*

*(2) To the best of my knowledge, any emission estimates reported or relied on in this application are true, accurate, and complete and are either based upon reasonable techniques available for calculating emissions or, for emission estimates of hazardous air pollutants not regulated for a emission unit addressed in this application, based solely upon the materials, information and calculations submitted with this application.*

*If the purpose of this application is to obtain a Title V source air operation permit (check here  if so), I further certify that each emissions unit described in this Application for Air Permit, when properly operated and maintained, will comply with the applicable requirements identified in this application to which the unit is subject, except those emissions units for which a compliance schedule is submitted with this application.*

*If the purpose of this application is to obtain an air construction permit for one or more proposed new or modified emission units (check here  if so), I further certify that the engineering features of each such emissions unit described in this application have been designed or examined by me or individuals under my direct supervision and found to be in conformity with sound engineering principles applicable to the control of emissions of the air pollutants characterized in this application.*

*If the purpose of this application is to obtain an initial air operation permit or operation permit revision for one or more newly constructed or modified emissions units (check here  if so), I further certify that, with the exception of any changes detailed as part of this application, each such emissions unit has been constructed or modified in substantial accordance with the information given in the corresponding application for air construction permit and with all provisions contained in such permit.*

Signature *Edward F. Hoff* Date *6/5/96*

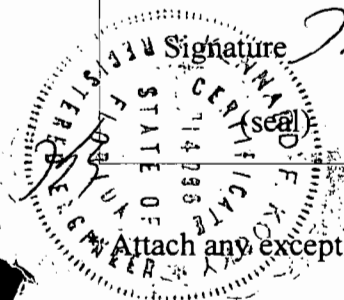

Attach any exception to certification statement.

**Application Contact Information**

1. Name and Title of Application Contact: Name: Richard Piper Title: Environmental Specialist		
2. Application Contact Mailing Address:  Organization/Firm: FPL Environmental Services Department Street Address: P.O. Box 088801 City: North Palm Beach                      State: Florida                      Zip Code: 33408-8801		
3. Application Contact Telephone Numbers: Telephone: (561)625-7661                      Fax: (561)625-7251		

**Application Comment**

This application is for the FPL Sanford Power Plant, which is located on the St. John's River in Volusia County, approximately seven miles northwest of Sanford, Florida.

The plant consists of three conventional steam electric generating stations, designated as units 3, 4, and 5, eight residual fuel oil storage tanks, one distillate fuel oil storage tank, and a 500 kilowatt diesel engine generator.

Unit 3 is comprised of a Babcock and Wilcox outdoor-type boiler/steam generator and Westinghouse outdoor reheat condensing steam turbine which drives a hydrogen-cooled generator with generator nameplate rating of 150 megawatts and a net summer capability of 154 megawatts.

Units 4 and 5 are each comprised of a Foster-Wheeler outdoor-type reheat boiler/steam generator and a Westinghouse tandem compound single reheat turbine generator with generator nameplate rating of 436 megawatts and a net summer capability of 390 megawatts.

Note that the nameplate rating and capability figures were taken from data previously provided to the PSC in the 10-year Site Plan.

## II. FACILITY INFORMATION

### A. GENERAL FACILITY INFORMATION

Information for Facility-Id : 1

#### Facility Location and Type

1. Facility UTM Coordinates:	
Zone: 17	East: 468.3 North: 3190.3
2. Facility Latitude/Longitude:	
Latitude (DD/MM/SS): 28 - 50 - 31	Longitude (DD/MM/SS): 81 - 19 - 32
3. Governmental Facility Code:	
4. Facility Status Code: Active	
5. Facility Major Group SIC Code: 49	
6. Facility SIC(s): 4911	
7. Facility Comment: (limit to 500 characters) Orimulsion, a bitumen-based fuel, may be co-fired with Natural Gas, or with Natural Gas and No. 6 Residual Oil in Sanford Unit 4 boiler.	

#### Facility Contact

1. Name and Title of Facility Contact:		
Name : Mike Halpin	Title : Unit Manager	
2. Facility Contact Mailing Address:		
Organization/Firm: FPL Sanford Plant		
Street Address: P.O. Box 471088		
City: Lake Monroe	State: FL	Zip Code: 32757 - 1088
3. Facility Contact Telephone Numbers:		
Telephone: (407) 668-3685	Fax: (407) 668-5183	
407/575-5100		

## Facility Regulatory Classifications

1. Small Business Stationary Source? (Yes/No/Unknown)(Y/N/U) : N
2. Title V Source? (Yes/No) (Y/N) : Y
3. Synthetic Non-Title V Source? (Yes/No) (Y/N) : N
4. Major Source of Pollutants Other than Hazardous Air Pollutants (HAPs)? (Yes/No) (Y/N) : Y
5. Synthetic Minor Source of Pollutants Other than HAPs? (Yes/No) (Y/N) : N
6. Major Source of HAPs? (Yes/No/Possible) (Y/N/P) : Y
7. Synthetic Minor Source of HAPs? (Yes/No) (Y/N) : N
8. One or More Emissions Units Subject to NSPS? (Yes/No) (Y/N) : N
9. One or More Emissions Units Subject to NESHAP? (Yes/No) (Y/N) : Y
10. Title V Source by EPA Designation? (Yes/No) (Y/N) : N
11. Facility Regulatory Classifications Comment (limit to 200 characters): The Sanford facility is subject to the asbestos NESHAP - 40 CFR 61 Subpart M.

**B. FACILITY REGULATIONS**

**Rule Applicability Discussion** (Required for Category II applications and Category III applications involving non Title-V sources. See Instructions.)

Not Applicable

**List of Applicable Regulations** (Required for Category I applications and Category III applications involving Title-V sources. See Instructions.)

Information for Facility-Id : 1

<p>40 CFR 61.05  40 CFR 61.12(b)  40 CFR 61.145  40 CFR 61.148  40 CFR 61.150  40 CFR 61.19  F.A.C. 62-204.800(8)(b)8.  (state only)  F.A.C. 62-204.800(8)(d)  (state only)  F.A.C. 62-210.300(2)  (except (b))  F.A.C. 62-210.300(3)(a)10.  F.A.C. 62-210.300(3)(a)11.  F.A.C. 62-210.300(3)(a)12.  F.A.C. 62-210.300(3)(a)15.  F.A.C. 62-210.300(3)(a)16.  F.A.C. 62-210.300(3)(a)17.  F.A.C. 62-210.300(3)(a)20.  F.A.C. 62-210.300(3)(a)21.</p>	<p>F.A.C. 62-210.300(3)(a)22.  F.A.C. 62-210.300(3)(a)23.  F.A.C. 62-210.300(3)(a)24.  F.A.C. 62-210.300(3)(a)4.  F.A.C. 62-210.300(3)(a)5.  F.A.C. 62-210.300(3)(a)7.  F.A.C. 62-210.300(3)(a)8.  F.A.C. 62-210.300(3)(a)9.  F.A.C. 62-210.300(3)(b)  F.A.C. 62-210.370(3)  F.A.C. 62-210.900(5)  F.A.C. 62-213.205(1)(a)  F.A.C. 62-213.205(1)(b)  F.A.C. 62-213.205(1)(c)  F.A.C. 62-213.205(1)(e)  F.A.C. 62-213.205(1)(f)  F.A.C. 62-213.205(1)(g)</p>	<p>F.A.C. 62-213.205(1)(i)  F.A.C. 62-213.205(1)(j)  F.A.C. 62-213.205(4)  F.A.C. 62-213.205(5)  F.A.C. 62-213.400  F.A.C. 62-213.410  F.A.C. 62-213.420(1)(b)2.  F.A.C. 62-213.420(1)(b)3.  F.A.C. 62-213.430(3)  F.A.C. 62-213.460  F.A.C. 62-256.300(1)  F.A.C. 62-256.300(2)  F.A.C. 62-256.300(3)  F.A.C. 62-256.300(4)  F.A.C. 62-256.300(7)  F.A.C. 62-256.300(8)  F.A.C. 62-256.300(9)</p>	<p>F.A.C. 62-256.500  F.A.C. 62-256.600  F.A.C. 62-256.700  F.A.C. 62-257.300  F.A.C. 62-257.301  F.A.C. 62-257.350  F.A.C. 62-257.400  F.A.C. 62-257.401  F.A.C. 62-257.900  F.A.C. 62-296.320(2)  (state only)  F.A.C. 62-296.320(3)(b)  (state only)  F.A.C. 62-296.320(4)(b)  F.A.C. 62-296.320(4)(c)  F.A.C. 62-297.310(7)(a)10.  F.A.C. 62-4.030  F.A.C. 62-4.040(1)(a)  F.A.C. 62-4.040(1)(b)  F.A.C. 62-4.100  F.A.C. 62-4.130</p>
---------------------------------------------------------------------------------------------------------------------------------------------------------------------------------------------------------------------------------------------------------------------------------------------------------------------------------------------------------------------------------------------------------------------------------------------------------------------------------------------------------------------------------	-----------------------------------------------------------------------------------------------------------------------------------------------------------------------------------------------------------------------------------------------------------------------------------------------------------------------------------------------------------------------------------------------------------------------------------------------------------------------------------------------------------------------------	--------------------------------------------------------------------------------------------------------------------------------------------------------------------------------------------------------------------------------------------------------------------------------------------------------------------------------------------------------------------------------------------------------------------------------------------------------------------	----------------------------------------------------------------------------------------------------------------------------------------------------------------------------------------------------------------------------------------------------------------------------------------------------------------------------------------------------------------------------------------------------------------------------------------------------------------------------------------------------------------------------



### C. FACILITY POLLUTANTS

**Facility Pollutant Information :**

1. Pollutant Emitted:	2. Pollutant Classification
SO2	A
NOX	A
CO	A
VOC	A
PM	A
PM10	A
H133	A
H106	A
H107	A
SAM	A
HAP	A

## E. FACILITY SUPPLEMENTAL INFORMATION

### Supplemental Requirements for All Applications For Facility :/

1. Area Map Showing Facility Location: PSNFS_1.pcx (Enter the Attached Document ID, NA - Not Applicable or WaiverRequested)
2. Facility Plot Plan: PSNFS_2.pcx (Enter the Attached Document ID, NA - Not Applicable or WaiverRequested)
3. Process Flow Diagram(s): PSNFS_3.pcx (Enter the Attached Document ID, NA - Not Applicable or WaiverRequested)
4. Precautions to Prevent Emissions of Unconfined Particulate Matter: PSNFS_4.txt (Enter the Attached Document ID, NA - Not Applicable or WaiverRequested)
5. Fugitive Emissions Identification : PSNFS_5.txt (Enter the Attached Document ID, NA - Not Applicable or WaiverRequested)
6. Supplemental Information for Construction Permit Application: NA (Enter the Attached Document ID, NA - Not Applicable)

### Additional Supplemental Requirements for Category I Applications Only

7. List of Proposed Exempt Activities: Not Applicable (Enter the Attached Document ID, NA - Not Applicable)
8. List of Equipment/Activities Regulated under Title VI: PSNFS_8.txt (Enter the Attached Document ID, Equipment/Activities Onsite but not Required to be Individually Listed, NA - Not Applicable)
9. Alternative Methods of Operation: PSNFS_9.txt (Enter the Attached Document ID, NA - Not Applicable)
10. Alternative Modes of Operation (Emissions Trading): NA (Enter the Attached Document ID, NA - Not Applicable)
11. Identification of Additional Applicable Requirements: PSNFS_11.txt (Enter the Attached Document ID, NA - Not Applicable)
12. Compliance Assurance Monitoring Plan: Not Applicable (Enter the Attached Document ID, NA - Not Applicable)

13. Risk Management Plan Verification: Plan to be Submitted to Implementing Agency by Required Date

Plan Submitted to Implementing Agency - Verification Attached(Attached Document ID)

Plan to be Submitted to Implementing Agency by Required Date

Not Applicable (NA)

14. Compliance Report and Plan: PSNFS\_13.txt

(Enter the Attached Document ID, NA - Not Applicable)

15. Compliance Statement (Hard-copy Required): PSNFS\_14.txt

(Enter the Attached Document ID, NA - Not Applicable)

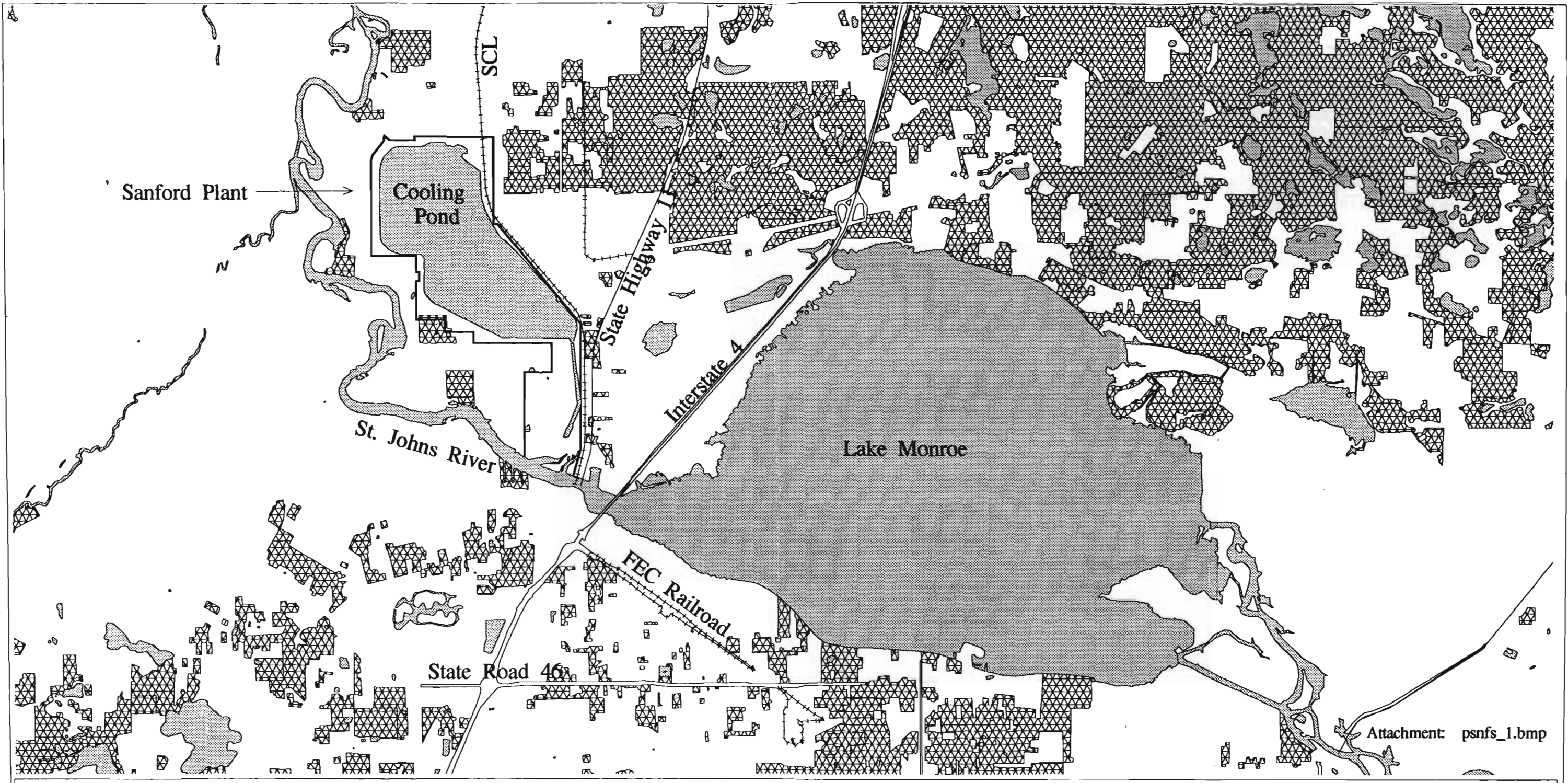

Attachment: psnfs\_1.bmp





# Sanford Plant Area Map

## Volusia County



Environmental  
**FPL Affairs**



-  Water
-  Residential
-  Sanford Plant Site
-  Major Roads
-  Railroads

No expressed or implied warranties including, but not limited to the implied warranties of MERCHANTABILITY OF FITNESS FOR A PARTICULAR PURPOSE are made. The materials contained herein are provided 'as is' and may contain inaccuracies and user is warned to utilize the material's accuracy independently and assumes the risk of any and all loss.

SOURCE: Landuse data provided by Saint Johns River Water Management District (1993)

MATCH LINE - SEE SHEET 2



- UNIT 5 STACK  
EU3  
UTM COORDS.  
N 3190651  
E 468356
- UNIT 4 STACK  
EU2  
UTM COORDS.  
N 3190593  
E 468335
- DIESEL GEN.  
EU4  
UTM COORDS.  
N 3190587  
E 468278
- UNIT 3 STACK  
EU1  
UTM COORDS.  
N 3190588  
E 468281

REVISION INFORMATION		TECHNICAL MODIFICATION	
NO.	DATE	NO.	DATE
AS-BUILT INFORMATION		DRAWING ORGANIZATION	

SCALE 1" = 1'-0"  
FULL SCALE

SCALE 1" = 1'-0"

SCALE 1" = 1'-0"



REV	DATE	ISSUED FOR TITLE V PERMIT	REVISION DESCRIPTION

	SYSTEM	YY	DISCIPLINE	N/A	PLANT/SITE	SANFORD PLANT
	SCALE	1" = 100'	CD FILE NAME	SM004408	TITLE	FACILITY PLOT PLAN ATTACHMENT FS-2 TITLE V
	DRAWING SIZE	E(30" X 42")	ITP ARCHIVE FILE	SM004408		
	DRAWING NUMBER	PSN3-M0002-YY			SHEET	1 OF 2
					REV	0

WALDOUGH WATERSHED		TECHNICAL ASSISTANCE	
DATE	BY	DATE	BY

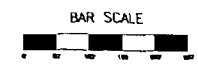
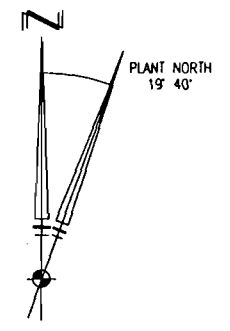
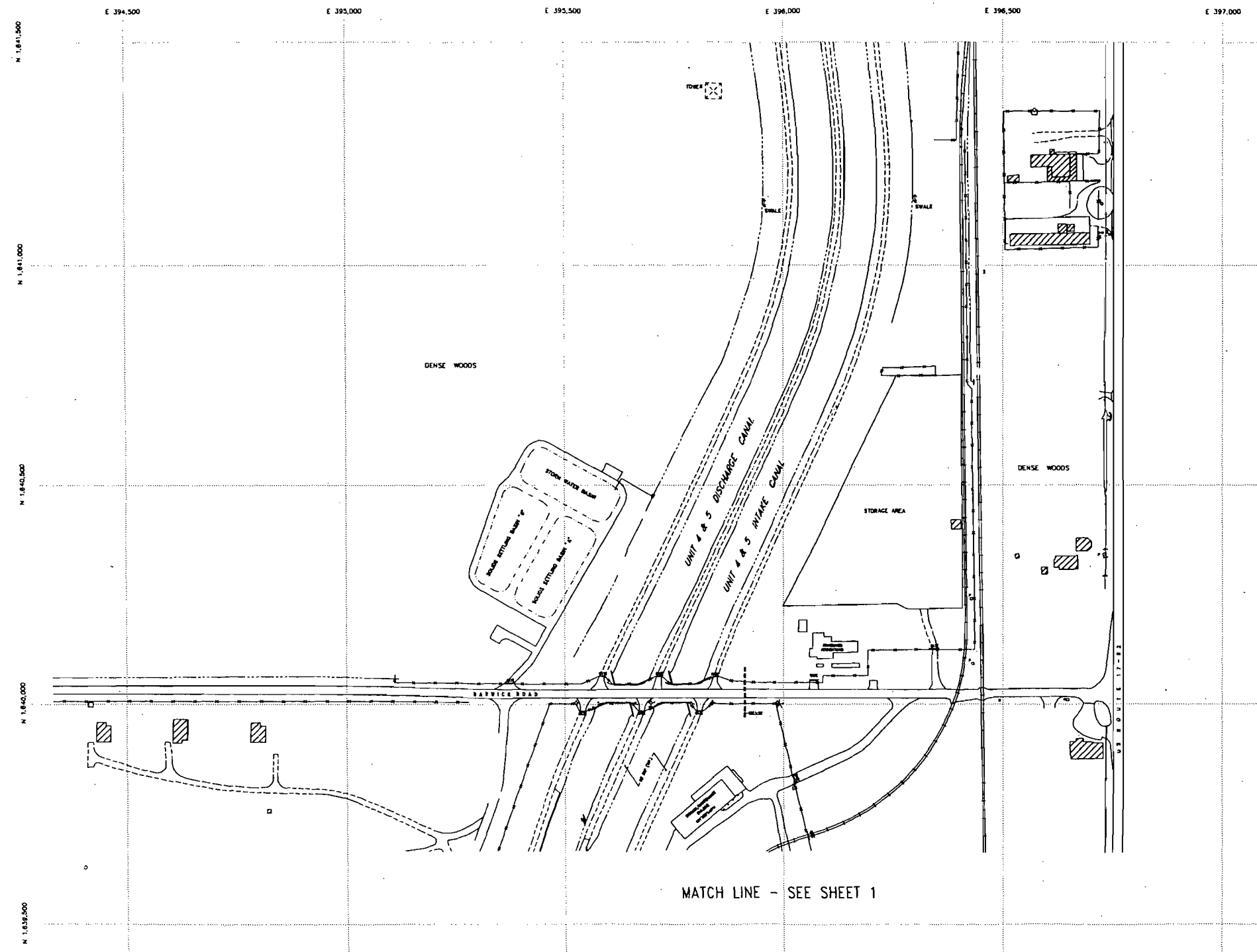
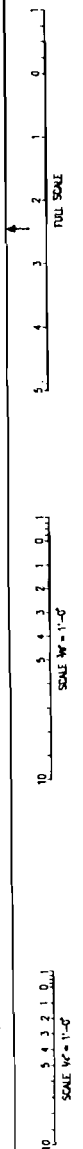

REV	DATE	ISSUED FOR TITLE & PERMIT	REVISION DESCRIPTION
0	2/14/83	ISSUED FOR TITLE & PERMIT	

DESIGNED BY	CHKD BY	APP'D BY	ORG

	SYSTEM	YY	DESCRIPTION	N/A	PLANT/UNIT	SANFORD PLANT
	SCALE	1" = 100'	GRID FILE NAME	SND0440B	TITLE	FACILITY PLOT PLAN
	DRAWING SIZE	E(30" X 42")	FPL ARCHIVE NAME	SND0440B		ATTACHMENT FS-2
	DRAWING NUMBER	PSN3-M0003-YY	SHEET	2	REV	0

TECHNICAL ACCEPTANCE	ORG	BY	DATE
	ENGINEERING ORGANIZATION		
WALKDOWN INFORMATION	ORG	BY	DATE
	AS-BUILT INFORMATION		

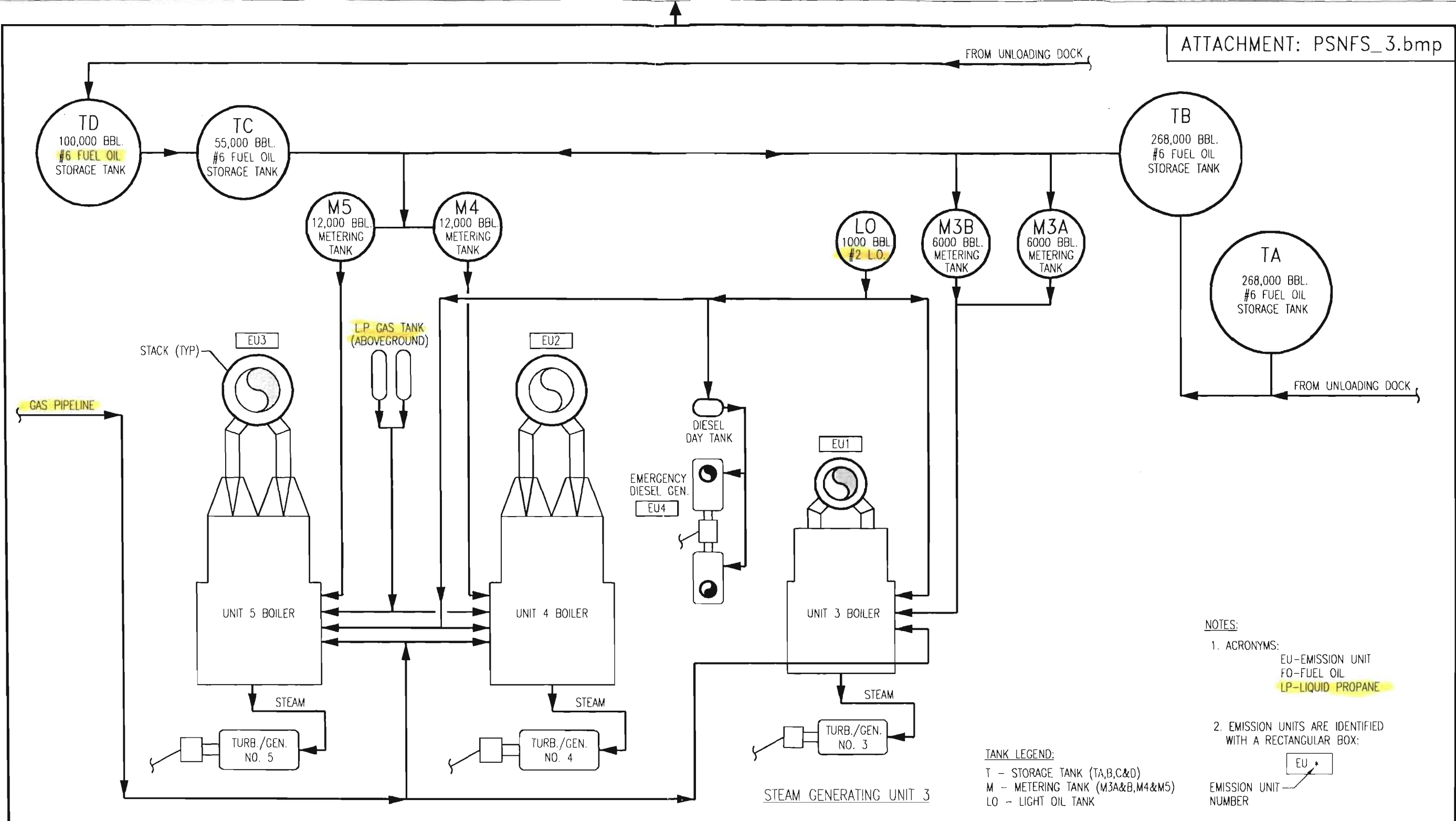

SCALE 3/8" = 1'-0"

SCALE 1/4" = 1'-0"

- NOTES:
- ACRONYMS:  
 EU-EMISSION UNIT  
 FO-FUEL OIL  
 LP-LIQUID PROPANE
  - EMISSION UNITS ARE IDENTIFIED WITH A RECTANGULAR BOX:  
 EMISSION UNIT NUMBER

TANK LEGEND:  
 T - STORAGE TANK (TA,B,C&D)  
 M - METERING TANK (M3A&B,M4&M5)  
 LO - LIGHT OIL TANK

	SYSTEM	DISCIPLINE	PLANT/UNIT	BAR CODE
	YY	M	SANFORD PLANT-UNIT 3,4&5	
	SCALE	CAD FILE NAME	TITLE	
	N/A	SN004408	FACILITY SOURCE FLOW DIAGRAM ATTACHMENT NO. FS-3 TITLE V	
DRAWING SIZE	FPL ARCHIVE NAME	DRAWING NUMBER		SHEET
B(11"X17")	SN004408	PSN3-M0102-YY		1 OF 1
REV	DATE	ISSUED FOR TITLE V PERMIT	REVISION DESCRIPTION	REVISION
				0

0	7/17/95	ISSUED FOR TITLE V PERMIT						
REV	DATE	ISSUED FOR TITLE V PERMIT	REVISION DESCRIPTION	PWB	PWB	CSP	CSP	ETS
				BY	CH	COR	APR	ORG

**Attachment PSNFS\_4.txt**  
**Precautions to Prevent Emissions of Unconfined Particulate Matter**

The facility has negligible amounts of unconfined particulate matter as a result of the operation of the facility. Potential examples of particulate matter include:

- fugitive dust from unpaved roads
- sandblasting abrasive material from plant maintenance activities
- fugitive particulates from the use of bagged chemical products (soda ash, di-, tri- and monosodium phosphate, and other chemicals as needed)

Several precautions were taken to prevent emissions of particulate matter in the *original design* of the facility. These include:

- Paving of roads, parking areas and equipment yards
- Landscaping and planting of vegetation

*Operational measures* are undertaken at the facility which also minimize particulate emissions, in accordance with 17-296.310 F.A.C.:

- Use of thick poly flaps over the doorways to prevent any sandblasting material from leaving the sandblast facility. The facility also constructs temporary sandblasting enclosures when necessary, in order to perform sandblasting on fixed plant equipment.
- Maintenance of paved areas as needed
- Regular mowing of grass and care of vegetation
- Limiting access to plant property by unnecessary vehicles.
- Bagged chemical products are stored in weather-tight buildings until they are used. Spills of powdered chemical products are cleaned up as soon as practicable.
- Vehicles are restricted to slow speeds on the plant site



**Attachment PSNFS\_5.txt  
Fugitive Emission Identification**

***Criteria and Precursor Air Pollutants***

Fugitive particulate emissions are addressed in Attachment PSNFS\_4.DOC. FPL is not aware of fugitive emissions of sulfur dioxide, nitrogen oxides, carbon monoxide or lead compounds which would exceed the reporting thresholds defined in the permit application instructions.

***Fugitive HAPs Emissions***

FPL is not aware of fugitive emissions of HAP pollutants which would exceed the reporting thresholds defined in the permit application instructions.

**Attachment PSNFS\_8.TXT**

**EQUIPMENT / ACTIVITIES REGULATED UNDER TITLE VI**

The Sanford facility currently has no equipment with CFC's greater than 50 lbs. Air conditioning units associated with boiler units 3, 4, and 5 are water cooled and the rest have CFC's less than 50 lbs.

**Attachment PSNFS\_9.txt**  
**Alternative Methods of Operation**

There are no known methods of operation at the current time at Sanford which would simultaneously affect emissions at more than one emissions unit but would not constitute emissions trading.

**Attachment PSNFS\_13.txt  
Sanford Plant  
Compliance Report and Plan**

The facility and emissions units identified in this application are **in compliance** with the Applicable Requirements identified in Sections II.B. and III.D. of the application form and attachments referenced in Section III.L. 12 (if included). Compliance is certified as of the date this application is submitted to the Florida Department of Environmental Regulation as required in Rule 62-213.420(1)(a) F.A.C.

Attachment PFLFS 14.txt  
Sanford Plant  
Compliance Statement

I, the undersigned, am the responsible official as defined in Chapter 62-213, F.A.C., of the Title V source for which this report is being submitted. I hereby certify, based on information and belief formed after reasonable inquiry, that the statements made and data contained in this report are true, accurate, and complete.



Signature, Responsible Official

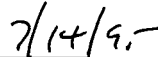

Date

Proposed Schedule for submittal of periodic compliance statements to the Department:

FPL will submit an annual compliance statement to the Department's Central District Office concurrently with the submittal of the Annual Operating Report for this facility.

Emission Unit Information Section \_\_\_\_ of \_\_\_\_

**III. EMISSIONS UNIT INFORMATION**

Information for Facility - ID : 1 Emission Unit # : 1

A separate Emissions Unit Information Section (including subsections A through L as required) must be completed for each emissions unit addressed in this Application for Air Permit. If submitting the application form in hard copy, indicate, in the space provided at the top of each page, the number of this Emissions Unit Information Section and the total number of Emissions Unit Information Sections submitted as part of this application. Some of the subsections comprising the Emissions Unit Information Section of the form are intended for regulated emissions units only. Others are intended for both regulated and unregulated emissions units. Each subsection is appropriately marked.

**A. TYPE OF EMISSIONS UNIT  
(Regulated and Unregulated Emissions Units)****Type of Emissions Unit Addressed in This Section**

1. Regulated or Unregulated Emissions Units? Check one:

- [ X ] The emissions unit addressed in this Emissions Unit Information Section is a regulated emissions unit.
- [ ] The emissions unit addressed in this Emissions Unit Information Section is a unregulated emissions unit.

2. Single Process, Group Processes, or Fugitive Only?

Enter The Number (1-3): 1

- [ 1 ] This Emissions Unit Information Section addresses, as a single emissions unit, a single process or production unit, or activity, which produces one or more air pollutants and which has at least one definable emission point (stack or vent).
- [ 2 ] This Emissions Unit Information Section addresses, as a single emissions unit, a group of process or production units and activities which has at least one definable emission point(stack or vent) but may also produce fugitive emissions.
- [ 3 ] This Emissions Unit Information Section addresses, as a single emissions unit, one or more process or production units and activities which produce fugitive emissions only.

**B. GENERAL EMISSIONS UNIT INFORMATION  
(Regulated and Unregulated Emissions Units)**

**Emissions Unit Description and Status**

1. Description of Emissions Unit Addressed in This Section (limit to 60 characters): Unit 3 fossil fuel steam generator
2. Emissions Unit Identification Number: 001 (No Corresponding ID or Unknown)
3. Emission Unit Status Code: (A or C): A
4. Acid Rain Unit? (Y/N): Y
5. Emissions Unit Major Group SIC Code: 49
6. Emissions Unit Comment (limit to 500 characters): The generator nameplate rating is taken from the 10-year Site Plan the FPL supplies annually to the Florida Public Service Commission. Actual generator output may exceed the value given, or may vary seasonally, with changes in unit efficiency, or due to fluctuations in system load demand.  The method of compliance for determining the heat input rate is fuel sampling and analysis in conjunction with fuel flow measurement.

**Emissions Unit Control Equipment**

**A. Control Equipment # :**

1. Description (limit to 200 characters):
2. Control Device or Method Code:

**B. Control Equipment # :**

1. Description (limit to 200 characters):
2. Control Device or Method Code:

**C. Control Equipment # :**

1. Description (limit to 200 characters):
2. Control Device or Method Code:



**C. EMISSIONS UNIT DETAIL INFORMATION  
(Regulated Emissions Units)**

**Emissions Unit Details**

1. Initial Startup Date (DD-MON-YYYY): 05/01/59
2. Long-term Reserve Shutdown Date (DD-MON-YYYY):
3. Package Unit: Manufacturer: Babcock & Wilcox <span style="float: right;">Model</span> Number: NA
4. Generator Nameplate Rating: 150 MW
5. Incinerator Information: Dwell Temperature: °F Dwell Time: seconds Incinerator Afterburner Temperature: °F

**Emissions Unit Operating Capacity**

1. Maximum Heat Input Rate: 1762 mmBtu/hr gas
2. Maximum Incineration Rate: lbs/hr tons/day
3. Maximum Process or Throughput Rate: Units:
4. Maximum Production Rate: Units:
5. Operating Capacity Comment (limit to 200 characters): Heat input rate in item 1 is for nat. gas fuel. Max. permitted heat input rate for oil firing is 1650 mmBtu/hour. The compliance method for heat input rate is fuel sampling and analysis.

**Emissions Unit Operating Schedule**

Requested Maximum Operating Schedule:

hours/day

days/week

weeks/yr

8760 hours/yr

**D. EMISSIONS UNIT REGULATIONS  
(Regulated Emissions Units Only)**

**Rule Applicability Analysis** (Required for Category II applications and Category III applications involving non Title-V sources. See Instructions.)

Not Applicable

**List of Applicable Regulations** (Required for Category I applications and Category III applications involving Title-V sources. See Instructions.)

## Emissions Unit ID 1

40 C.F.R. 279.72	40 C.F.R. 75 Appendix B	40 C.F.R. 75.35	F.A.C. 62-214.300
40 C.F.R. 72.20(a)	40 C.F.R. 75 Appendix C-1	40 C.F.R. 75.36	F.A.C. 62-214.330
40 C.F.R. 72.20(b)	40 C.F.R. 75 Appendix C-2	40 C.F.R. 75.4(a)(4)(ii)	F.A.C. 62-214.350 (2)
40 C.F.R. 72.20(c)	40 C.F.R. 75 Appendix D	40 C.F.R. 75.5	F.A.C. 62-214.350 (3)
40 C.F.R. 72.21(a)	40 C.F.R. 75 Appendix F	40 C.F.R. 75.51(c)	F.A.C. 62-214.350 (5)
40 C.F.R. 72.21(b)	40 C.F.R. 75 Appendix G-2	40 C.F.R. 75.53(a)	F.A.C. 62-214.350 (6)
40 C.F.R. 72.21(d)	40 C.F.R. 75 Appendix G-4	40 C.F.R. 75.53(b)	F.A.C. 62-214.370 (1)
40 C.F.R. 72.22(a)	40 C.F.R. 75 Appendix H	40 C.F.R. 75.53(c)	F.A.C. 62-214.370 (3)
40 C.F.R. 72.22(c)	40 C.F.R. 75.10(a)(1)	40 C.F.R. 75.53(d)(1)	F.A.C. 62-214.370 (4)
40 C.F.R. 72.23	40 C.F.R. 75.10(a)(2)	40 C.F.R. 75.54	F.A.C. 62-214.370 (7)
40 C.F.R. 72.24(a)	40 C.F.R. 75.10(a)(3)(i)	40 C.F.R. 75.55(c)	F.A.C. 62-214.430
40 C.F.R. 72.30(a)	40 C.F.R. 75.10(a)(4)	40 C.F.R. 75.55(e)	F.A.C. 62-296.405(1)(a)
40 C.F.R. 72.30(b)(2)	40 C.F.R. 75.10(b)	40 C.F.R. 75.56	paragraph 2
40 C.F.R. 72.30(c)	40 C.F.R. 75.10(c)	40 C.F.R. 75.60(a)	F.A.C. 62-296.405(1)(b)
40 C.F.R. 72.30(d)	40 C.F.R. 75.10(d)	40 C.F.R. 75.60(b)	F.A.C. 62-296.405(1)(c)1.j.
40 C.F.R. 72.32	40 C.F.R. 75.10(f)	40 C.F.R. 75.60(c)(3)	F.A.C. 62-296.405(1)(e)(1)
40 C.F.R. 72.33(b)	40 C.F.R. 75.10(g)	40 C.F.R. 75.61(a)(1)	F.A.C. 62-296.405(1)(e)(2)
40 C.F.R. 72.33(c)	40 C.F.R. 75.11(b)(1)	40 C.F.R. 75.61(a)(5)	F.A.C. 62-296.405(1)(e)(3)
40 C.F.R. 72.33(d)	40 C.F.R. 75.11(c)(3)	40 C.F.R. 75.61(b)	F.A.C.
40 C.F.R. 72.40(a)	40 C.F.R. 75.11(d)	40 C.F.R. 75.62	62-296.405(1)(f)1.a.(i)
40 C.F.R. 72.40(b)	40 C.F.R. 75.12(a)	40 C.F.R. 75.63	F.A.C. 62-296.405(1)(f)1.b.
40 C.F.R. 72.40(c)	40 C.F.R. 75.12(b)	40 C.F.R. 75.64(a)	F.A.C. 62-296.500(2)(a)1.
40 C.F.R. 72.40(d)	40 C.F.R. 75.13(a)	40 C.F.R. 75.64(b)	F.A.C. 62-296.500(2)(c)
40 C.F.R. 72.51	40 C.F.R. 75.13(b)	40 C.F.R. 75.64(c)	F.A.C. 62-297.310(1)
40 C.F.R. 72.90	40 C.F.R. 75.14(a)	40 C.F.R. 75.64(d)	F.A.C. 62-297.310(2)(b)
40 C.F.R. 72.9(a)(1)(iii)	40 C.F.R. 75.20(a)(5)	40 C.F.R. 75.65	F.A.C. 62-297.310(3)
40 C.F.R. 72.9(a)(1)(i)	40 C.F.R. 75.20(b)	40 C.F.R. 75.66(a)	F.A.C. 62-297.310(4)(a)1.
40 C.F.R. 72.9(a)(2)	40 C.F.R. 75.20(c)	40 C.F.R. 75.66(b)	F.A.C. 62-297.310(4)(a)2.c.
40 C.F.R. 72.9(b)	40 C.F.R. 75.20(d)	40 C.F.R. 75.66(c)	F.A.C. 62-297.310(4)(b)
40 C.F.R. 72.9(c)(1)(iii)	40 C.F.R. 75.20(f)	40 C.F.R. 75.66(d)	F.A.C. 62-297.310(4)(c)
40 C.F.R. 72.9(c)(2)	40 C.F.R. 75.20(g)	40 C.F.R. 75.66(g)	F.A.C. 62-297.310(4)(d)
40 C.F.R. 72.9(c)(4)	40 C.F.R. 75.21(a)	40 C.F.R. 75.66(h)	F.A.C. 62-297.310(4)(e)
40 C.F.R. 72.9(c)(5)	40 C.F.R. 75.21(b)	40 C.F.R. 76.13	F.A.C. 62-297.310(5)
40 C.F.R. 72.9(d)	40 C.F.R. 75.21(c)	40 C.F.R. 77.3	F.A.C. 62-297.310(6)(a)
40 C.F.R. 72.9(e)	40 C.F.R. 75.21(d)	40 C.F.R. 77.5(b)	F.A.C. 62-297.310(6)(c)
40 C.F.R. 72.9(f)	40 C.F.R. 75.21(e)	40 C.F.R. 77.6	F.A.C. 62-297.310(6)(d)
40 C.F.R. 72.9(g)(4)	40 C.F.R. 75.21(f)	F.A.C. 62-204.800(12)	F.A.C. 62-297.310(6)(e)
40 C.F.R. 73.33	40 C.F.R. 75.22	(state only)	F.A.C. 62-297.310(6)(f)
40 C.F.R. 73.35	40 C.F.R. 75.24	F.A.C. 62-204.800(13)	F.A.C. 62-297.310(6)(g)
40 C.F.R. 75 Appendix A-1	40 C.F.R. 75.30(a)(1)	(state only)	F.A.C. 62-297.310(7)(a)1.
40 C.F.R. 75 Appendix A-2	40 C.F.R. 75.30(a)(2)	F.A.C. 62-204.800(14)	F.A.C. 62-297.310(7)(a)2.
40 C.F.R. 75 Appendix A-3	40 C.F.R. 75.30(a)(3)	(state only)	F.A.C. 62-297.310(7)(a)3.
40 C.F.R. 75 Appendix A-4	40 C.F.R. 75.31	F.A.C. 62-210.650	F.A.C. 62-297.310(7)(a)4.
40 C.F.R. 75 Appendix A-5	40 C.F.R. 75.32	F.A.C. 62-210.700 (1)	F.A.C. 62-297.310(7)(a)5.
40 C.F.R. 75 Appendix A-6	40 C.F.R. 75.33	F.A.C. 62-210.700 (2)	F.A.C. 62-297.310(7)(a)9.
		F.A.C. 62-210.700 (3)	F.A.C. 62-297.310(7)(c)
		F.A.C. 62-210.700 (4)	F.A.C. 62-297.310(8)
		F.A.C. 62-210.700 (6)	Table 62-297.310-1

**E. EMISSION POINT (STACK/VENT) INFORMATION  
(Regulated Emissions Units Only)**

**Emission Point Description and Type**

Information for Facility-ID   1   Emission Unit #   1  

1. Identification of Point on Plot Plan or Flow Diagram: EU1-Boiler No. 3
2. Emission Point Type Code (1,2,3,4) : 1
3. Descriptions of Emissions Points Comprising this Emissions Unit (limit to 100 characters): NA
4. ID Numbers or Descriptions of Emission Units with this Emission Point in Common: NA
5. Discharge Type Code (D, F, H, P, R, V, W) : v
6. Stack Height: 302 ft
7. Exit Diameter: 9.5 ft
8. Exit Temperature: 300 °F
9. Actual Volumetric Flow Rate: 651270.9 acfm
10. Percent Water Vapor: %
11. Maximum Dry Standard Flow Rate: dscfm
12. Nonstack Emission Point Height: ft
13. Emission Point UTM Coordinates: Zone: 17 East: 468.28 North: 3190.57
14. Emission Point Comment (limit to 200 characters): Information in items 8 and 9 above reflects the highest temperature and flow rate measured during the May 1994 particulate emissions test at this unit. Flow rates measured at other times may vary.

**F. SEGMENT (PROCESS/FUEL) INFORMATION  
(Regulated and Unregulated Emissions Units)**

**Segment Description and Rate:**

Information for Facility\_ID :/ Emission Unit #: / Segment #: /

1. Segment Description (Process/Fuel Type and Associated Operating Method/Mode) (limit to 500 characters): Unit 3 Boiler burning natural gas fuel
2. Source Classification Code (SCC): 1-01-006-01
3. SCC Units: Million cubic feet burned
4. Maximum Hourly Rate: 1.678
5. Maximum Annual Rate: 14699
6. Estimated Annual Activity Factor:
7. Maximum Percent Sulfur: 0.0031
8. Maximum Percent Ash:
9. Million Btu per SCC Unit: 1050
10. Segment Comment (limit to 200 characters): The unit is currently permitted to burn a variable combination of No. 6 residual oil, natural gas, No. 2 fuel oil, propane gas or on-specification used oil from FPL operations.

**F. SEGMENT (PROCESS/FUEL) INFORMATION  
(Regulated and Unregulated Emissions Units)**

**Segment Description and Rate:**

Information for Facility\_ID :/ Emission Unit #: 1 Segment #: 2

1. Segment Description (Process/Fuel Type and Associated Operating Method/Mode) (limit to 500 characters): Unit 3 Boiler burning No. 6 residual oil
2. Source Classification Code (SCC): 1-01-004-01
3. SCC Units: thousand gallons burned
4. Maximum Hourly Rate: 10.86
5. Maximum Annual Rate: 95134
6. Estimated Annual Activity Factor:
7. Maximum Percent Sulfur: 2.5
8. Maximum Percent Ash:
9. Million Btu per SCC Unit: 152
10. Segment Comment (limit to 200 characters): The unit is currently permitted to burn a variable combination of No. 6 residual oil, natural gas, No. 2 fuel oil, propane gas or on-specification used oil from FPL operations.

**F. SEGMENT (PROCESS/FUEL) INFORMATION  
(Regulated and Unregulated Emissions Units)**

**Segment Description and Rate:**

Information for Facility\_ID :1 Emission Unit #: 1 Segment #: 3

1. Segment Description (Process/Fuel Type and Associated Operating Method/Mode) (limit to 500 characters): Unit 3 Boiler burning No.2 diesel fuel oil
2. Source Classification Code (SCC): 1-01-005-01
3. SCC Units: Thousand gallons burned
4. Maximum Hourly Rate: 12.13
5. Maximum Annual Rate: 106259
6. Estimated Annual Activity Factor:
7. Maximum Percent Sulfur: 0.5
8. Maximum Percent Ash:
9. Million Btu per SCC Unit: 136
10. Segment Comment (limit to 200 characters): The Unit is currently permitted to burn a variable combination of No. 6 residual oil, natural gas, No. 2 fuel oil, propane gas or on-specification used oil from FPL operations.



**F. SEGMENT (PROCESS/FUEL) INFORMATION  
(Regulated and Unregulated Emissions Units)**

**Segment Description and Rate:**

Information for Facility\_ID :1 Emission Unit #: 1 Segment #: 4

1. Segment Description (Process/Fuel Type and Associated Operating Method/Mode) (limit to 500 characters): Unit 3 Boiler burning propane
2. Source Classification Code (SCC): 1-01-006-01
3. SCC Units: Million cubic feet burned
4. Maximum Hourly Rate: 1.762
5. Maximum Annual Rate: 15435
6. Estimated Annual Activity Factor:
7. Maximum Percent Sulfur:
8. Maximum Percent Ash:
9. Million Btu per SCC Unit: 1000
10. Segment Comment (limit to 200 characters): The unit is currently permitted to burn a variable combination of No. 6 residual oil, natural gas, No. 2 fuel oil, propane gas or on-specification used oil from FPL operations.

**F. SEGMENT (PROCESS/FUEL) INFORMATION  
(Regulated and Unregulated Emissions Units)**

**Segment Description and Rate:**

Information for Facility\_ID :1 Emission Unit #: 1 Segment #: 5

1. Segment Description (Process/Fuel Type and Associated Operating Method/Mode) (limit to 500 characters): Unit 3 Boiler burning on-specification used oil
2. Source Classification Code (SCC): 1-01-013-02
3. SCC Units: thousand gallons burned
4. Maximum Hourly Rate: 12.13 <i>Same as #2 FO</i>
5. Maximum Annual Rate: 993.384 <i>#1 of #2 FO Annual rate</i>
6. Estimated Annual Activity Factor:
7. Maximum Percent Sulfur: 2.5 <i>Same as #6 FO Limit</i>
8. Maximum Percent Ash:
9. Million Btu per SCC Unit: 136 <i>Same as #2 FO</i>
10. Segment Comment (limit to 200 characters): The quantity of on-specification used oil which the Sanford Unit 3 boiler may burn is currently limited to 993,384 gallons per year under the existing FDEP permit. <i>~ 1x10<sup>6</sup> GPY</i>

**F. SEGMENT (PROCESS/FUEL) INFORMATION  
(Regulated and Unregulated Emissions Units)**

**Segment Description and Rate:**

Information for Facility\_ID :1 Emission Unit #: 1 Segment #: 6

1. Segment Description (Process/Fuel Type and Associated Operating Method/Mode) (limit to 500 characters): Unit 3 co-firing all possible combinations of natural gas, residual oil, on specification used oil, #2 fuel oil, and propane.
2. Source Classification Code (SCC): 1-01-006-01
3. SCC Units: million cubic feet and thousand gallons
4. Maximum Hourly Rate:
5. Maximum Annual Rate:
6. Estimated Annual Activity Factor:
7. Maximum Percent Sulfur: 1
8. Maximum Percent Ash: 0.1
9. Million Btu per SCC Unit:
10. Segment Comment (limit to 200 characters): Air Operation Permit # AO-64-217877 allows Unit 3 to burn a mixture of the above fuels in a ratio that will result in a max. SO2 emission rate of 2.75 lbs/mmBtu.

**F. SEGMENT (PROCESS/FUEL) INFORMATION  
(Regulated and Unregulated Emissions Units)**

**Segment Description and Rate:**

Information for Facility\_ID :1 Emission Unit #: 1 Segment #: 7

1. Segment Description (Process/Fuel Type and Associated Operating Method/Mode) (limit to 500 characters): Unit 3 Boiler chemical cleaning waste evaporation
2. Source Classification Code (SCC): 1-01-013-01
3. SCC Units: thousand gallons burned
4. Maximum Hourly Rate: 3
5. Maximum Annual Rate: 500
6. Estimated Annual Activity Factor:
7. Maximum Percent Sulfur:
8. Maximum Percent Ash:
9. Million Btu per SCC Unit:
10. Segment Comment (limit to 200 characters): Items 6,7,8 & 9 do not apply. This activity to be undertaken on a periodic basis in accordance with DARM guidance, and EPA waste rules (40 CFR 279.72).

**G. EMISSIONS UNIT POLLUTANTS  
(Regulated Emissions Units Only)**

**Information for Facility\_ID: / Emission Unit #: /**

1. Pollutant Emitted	2. Primary Control Device Code	3. Secondary Control Device Code	4. Pollutant Regulatory Code
SO2	NA	NA	EL
NOX	NA	NA	NS
CO	NA	NA	NS
PM	NA	NA	EL
PM10	NA	NA	NS
VOC	NA	NA	NS
H133	NA	NA	NS
H107	NA	NA	NS
H106	NA	NA	NS
SAM	NA	NA	NS
HAP	NA	NA	NS

**H. EMISSIONS UNIT POLLUTANT DETAIL INFORMATION  
(Regulated Emissions Units Only - Emissions Limited Pollutants Only)**

Information for Facility\_ID: / Emission Unit #: / Pollutant #: /

**Pollutant Detail Information**

1. Pollutant Emitted:	Particulate Matter - Total
2. Total Percent Efficiency of Control:	%
3. Potential Emissions:	206.3 lbs/hr                      903.4 tons/yr
4. Synthetically Limited? (Yes/No):	N
5. Range of Estimated Fugitive/Other Emissions: (1, 2, 3):	to tons/yr
6. Emission Factor:	0.125                      Units    lb/mmBtu
Reference:	Rule 62-296.405(1)(b) and Rule 62-210.700(3)
7. Emissions Method Code: (0, 1, 2, 3, 4, 5):	0
	<input type="checkbox"/> 0 <input type="checkbox"/> 1 <input type="checkbox"/> 2 <input type="checkbox"/> 3 <input type="checkbox"/> 4 <input type="checkbox"/> 5
8. Calculation of Emissions (limit to 600 characters):	0.125 lb/mmBtu * 1650 mmBtu/hr = 206.3 lb/hr (206.3 lb/hr * 8760 hr/yr) / 2000 lb/ton = 903.40 TPY
9. Pollutant Potential/Estimated Emissions Comment (limit to 200 characters):	A particulate matter emissions limit of 3 hours /24 hours at 0.3 lb/mmBtu and 21 hours/24hours at 0.1 lb/mmBtu is equivalent to an average of 0.125 lb/mmBtu.

**Information for Facility\_ID: / Emission Unit #: / Pollutant #: /  
Basis For Allowable Emission #: 1**

**Allowable Emissions** (Pollutant identified on front page)

1. Basis for Allowable Emissions Code: Emissions limit required by rule
2. Future Effective Date of Allowable Emissions:
3. Requested Allowable Emissions and Units: 0.3 Units : lb/mmBtu
4. Equivalent Allowable Emissions: 495 lbs/hr 271 tons/yr
5. Method of Compliance: DEP Rule 62-296.405(1)(e)2.
6. Pollutant Allowable Emissions Comment ( <b>Desc. of Related Operating Method/Mode</b> ) (limit to 200 characters): <b>133</b> Equivalent allowable emissions based on 3 hours of sootblowing per 24-hour period. Regulatory limit on PM is from Rule 62-210.700(3).

**Information for Facility\_ID: 1 Emission Unit #: 1 Pollutant #: 1  
Basis For Allowable Emission #: 2**

**Allowable Emissions** (Pollutant identified on front page)

1. Basis for Allowable Emissions Code: Emissions limit required by rule
2. Future Effective Date of Allowable Emissions:
3. Requested Allowable Emissions and Units: 0.1 Units : lb/mmBtu while steady-state
4. Equivalent Allowable Emissions: 165 lbs/hr 632.4 tons/yr
5. Method of Compliance: DEP Rule 62-296.405(1)(e)2.
6. Pollutant Allowable Emissions Comment ( <b>Desc. of Related Operating Method/Mode</b> ) (limit to 200 characters): FDEP Rule 62-296.340(1)(e) is the basis for the emission limit. The equivalent allowable emissions given above are based on steady-state operation 21 hours per 24-hour period.



**H. EMISSIONS UNIT POLLUTANT DETAIL INFORMATION  
(Regulated Emissions Units Only - Emissions Limited Pollutants Only)**

**Information for Facility\_ID: 1 Emission Unit #: 1 Pollutant #: 3**

**Pollutant Detail Information**

1. Pollutant Emitted: <b>Sulfur Dioxide</b>	
2. Total Percent Efficiency of Control:	%
3. Potential Emissions: 4537.5 lbs/hr	<b>19874.25 tons/yr</b>
4. Synthetically Limited? (Yes/No): N	
5. Range of Estimated Fugitive/Other Emissions: (1, 2, 3) : to tons/yr	
6. Emission Factor: <b>2.75</b>	Units <b>lb/mmBtu</b>
Reference: <b>Rule 62-296.405(1)(c)1.j.</b>	
7. Emissions Method Code: (0, 1, 2, 3, 4, 5): 0 <input type="checkbox"/> 0 <input type="checkbox"/> 1 <input type="checkbox"/> 2 <input type="checkbox"/> 3 <input type="checkbox"/> 4 <input type="checkbox"/> 5	
8. Calculation of Emissions (limit to 600 characters):  2.75 lb/mmBtu * 1,650 mmBtu = 4,537.5 lb/hr 4,537.5 lb/hr * 8760 hr/yr / (2000 lb/ton) = 19,874.25 TPY	
9. Pollutant Potential/Estimated Emissions Comment (limit to 200 characters): Information provided reflects <b>#6 oil firing</b> . A co-firing fuel mixture will consist of up to <b>4.0% sulfur #6 fuel oil co-fired with enough natural gas to result in an SO2 emission rate &lt; 2.75 lb/mmBtu.</b>	

**Information for Facility\_ID: 1 Emission Unit #: 1 Pollutant #: 3  
Basis For Allowable Emission #: 1**

**Allowable Emissions** (Pollutant identified on front page)

1. Basis for Allowable Emissions Code: Emissions limit required by rule
2. Future Effective Date of Allowable Emissions:
3. Requested Allowable Emissions and Units: 2.75 Units : lb/mmBtu
4. Equivalent Allowable Emissions: 4537.5 lbs/hr 19874.25 tons/yr
5. Method of Compliance: Fuel sampling & analysis
6. Pollutant Allowable Emissions Comment ( <b>Desc. of Related Operating Method/Mode</b> ) (limit to 200 characters): 125 Information provided on this page is based on fuel oil firing only. FDEP permit limits and emission factors are for fuel oil.

**I. VISIBLE EMISSIONS INFORMATION  
(Regulated Emissions Units Only)**

Information for Facility-ID : 1 Emission Unit #: 1  
Visible Emissions Limitation #: 1

1. Visible Emissions Subtype: VE40	
2. Basis for Allowable Opacity Code(R/O):   RULE       [ ] Rule       [ ] Other	
3. Allowable Opacity: Normal Conditions: 40 % Exceptional Conditions: % (1) 2 min period/hr Maximum Period of Excess Opacity Allowed:     min/hr	
4. Method of Compliance Code:   EPA Method 9	
5. Visible Emissions Comment (limit to 200 characters): DEP Rule 62-296.405(1)(a) and (1)(e)1., F.A.C. Visible Emissions limited to 40% opacity, except for allowed excess emissions. Compliance testing is performed annually using EPA Method 9.	

*Handwritten notes:*  
 (1) 2 min period/hr  
 (1) 6 min period/hr  
 20% 27% Soot flow

**I. VISIBLE EMISSIONS INFORMATION  
(Regulated Emissions Units Only)**

Information for Facility-ID : 1 Emission Unit #: 1  
Visible Emissions Limitation #: 2

1. Visible Emissions Subtype: VE60
2. Basis for Allowable Opacity Code(R/O):   RULE       [ ] Rule       [ ] Other
3. Allowable Opacity: Normal Conditions: 60                           % Exceptional Conditions: 100    % Maximum Period of Excess Opacity Allowed: 24   min/hr
4. Method of Compliance Code:   EPA Method 9
5. Visible Emissions Comment (limit to 200 characters): Rule 62-210.700(3), F.A.C. limits soot blowing & load changing to 60% opacity for up to 3 hrs/24 hrs, with < 4, 6-minute pds of up to 100% opac. if unit has an operational CEM.



**J. CONTINUOUS MONITOR INFORMATION  
(Regulated Emissions Units Only)**

Information for Facility-ID : 1 Emission Unit #: 1  
Continuous Monitor #: 2

**Continuous Monitoring System**

1. Parameter Code:			
2. Pollutant(s):	Nitrogen Oxides		
3. CMS Requirement Code(R/O):	RULE	Rule	/ Other
4. Monitor Information:			
Manufacturer: TECO		Serial Number: 42-48507-280	
Model Number: 42			
5. Installation Date (DD-MON-YYYY): 08/30/94			
6. Performance Specification Test Date (DD-MON-YYYY): 10/12/94			
7. Continuous Monitor Comment (limit to 200 characters): Required by 40 CFR 75.10(a)(2)			

**J. CONTINUOUS MONITOR INFORMATION  
(Regulated Emissions Units Only)**

Information for Facility-ID : 1 Emission Unit #: 1  
Continuous Monitor #: 1

**Continuous Monitoring System**

1. Parameter Code:			
2. Pollutant(s):	Sulfur Dioxide		
3. CMS Requirement Code(R/O):	RULE	Rule	/ Other
4. Monitor Information:			
Manufacturer: TECO		Serial Number: 43B-48525-281	
Model Number: 43B			
5. Installation Date (DD-MON-YYYY): 08/30/94			
6. Performance Specification Test Date (DD-MON-YYYY): 10/12/94			
7. Continuous Monitor Comment (limit to 200 characters): Required by 40 CFR 75.10(a)(1)			

**J. CONTINUOUS MONITOR INFORMATION  
(Regulated Emissions Units Only)**

Information for Facility-ID : 1 Emission Unit #: 1  
Continuous Monitor #: 3

**Continuous Monitoring System**

1. Parameter Code:			
2. Pollutant(s):	Carbon dioxide		
3. CMS Requirement Code(R/O):	RULE	Rule	/ Other
4. Monitor Information:			
Manufacturer: Milton Roy		Serial Number: N3L2460T	
Model Number: 3300			
5. Installation Date (DD-MON-YYYY): 08/30/94			
6. Performance Specification Test Date (DD-MON-YYYY): 10/12/94			
7. Continuous Monitor Comment (limit to 200 characters): Required by 40 CFR 75.10(a)(3)(i)			



**J. CONTINUOUS MONITOR INFORMATION  
(Regulated Emissions Units Only)**

Information for Facility-ID : 1 Emission Unit #: 1  
Continuous Monitor #: 4

**Continuous Monitoring System**

1. Parameter Code:		
2. Pollutant(s):	Volumetric flow rate	
3. CMS Requirement Code(R/O):	RULE	Rule / Other
4. Monitor Information:		
Manufacturer:	Air Monitor	
Model Number:	MASSTRON	Serial Number: 6083D
5. Installation Date (DD-MON-YYYY):	08/30/94	
6. Performance Specification Test Date (DD-MON-YYYY):	10/12/94	
7. Continuous Monitor Comment (limit to 200 characters):	Required by 40 CFR 75.10(a)(1)	

**J. CONTINUOUS MONITOR INFORMATION  
(Regulated Emissions Units Only)**

Information for Facility-ID : 1 Emission Unit #: 1  
Continuous Monitor #: 5

**Continuous Monitoring System**

1. Parameter Code:		
2. Pollutant(s):	Visible emissions (opacity)	
3. CMS Requirement Code(R/O):	RULE	Rule / Other
4. Monitor Information:		
Manufacturer:	Lear Siegler	
Model Number:	RM41	Serial Number: 38926
5. Installation Date (DD-MON-YYYY):	03/01/78	
6. Performance Specification Test Date (DD-MON-YYYY):	12/14/94	
7. Continuous Monitor Comment (limit to 200 characters):	Required by 40 CFR 75.10(a)(4). The date of manufacture is used as the installation date. The actual date of manufacture is not known so the first day of the month was substituted.	

**K. PREVENTION OF SIGNIFICANT DETERIORATION (PSD) INCREMENT  
TRACKING INFORMATION  
(Regulated and Unregulated Emissions Units)**

Information for Facility-ID : / Emission Unit # : /

**PSD Increment Consumption Determination**

1. Increment Consuming for Particulate Matter or Sulfur Dioxide?

If the emissions unit addressed in this section emits particulate matter or sulfur dioxide, answer the following series of questions to make a preliminary determination as to whether or not the emissions unit consumes PSD increment for particulate matter or sulfur dioxide. Check the first statement, if any, that applies and skip remaining statements.

Select (1-5) : 5

- [ 1 ] The emissions unit is undergoing PSD review as part of this application, or has undergone PSD review previously, for particulate matter or sulfur dioxide. Final determination is that emissions unit consumes increment.
- [ 2 ] The facility addressed in this application is classified as an EPA major source pursuant to paragraph (c) of the definition of "major source of air pollution" in Chapter 17-213, F.A.C., and the emissions unit addressed in this section commenced (or will commence) construction after January 6, 1975. Preliminary determination is that baseline emissions are zero, and emissions unit consumes increment.
- [ 3 ] The facility addressed in this application is classified as an EPA major source, and the emissions unit began initial operation after January 6, 1975, but before December 27, 1977. Preliminary determination is that baseline emissions are zero, and emissions unit consumes increment.
- [ 4 ] For any facility, the emissions unit began (or will begin) initial operation after December 27, 1977. Preliminary determination is that baseline emissions are zero, and emissions unit consumes increment.
- [ 5 ] None of the above apply. If so, the baseline emissions of the emissions unit are nonzero. In such case, additional analysis, beyond the scope of this application, is needed to determine whether changes in emissions have occurred (or will occur) after the baseline date that may consume or expand increment.

2. Increment Consuming for Nitrogen Dioxide?

If the emissions unit addressed in this section emits nitrogen oxides, answer the following series of questions to make a preliminary determination as to whether or not the emissions unit consumes PSD increment for nitrogen dioxide. Check first statement, if any, that applies and skip remaining statements.

Select (1-5) : 5

- [ 1 ] The emissions unit addressed in this section is undergoing PSD review as part of this application, or has undergone PSD review previously, for nitrogen dioxide. Final determination is that emissions unit consumes increment.
- [ 2 ] The facility addressed in this application is classified as an EPA major source pursuant to paragraph (c) of the definition of "major source of air pollution" in Chapter 17-213, F.A.C., and the emissions unit addressed in this section commenced (or will commence) construction after February 8, 1988. Preliminary determination is that baseline emissions are zero, and emissions unit consumes increment.
- [ 3 ] The facility addressed in this application is classified as an EPA major source, and the emissions unit began initial operation after February 8, 1988, but before March 28, 1988. Preliminary determination is that baseline emissions are zero, and emissions unit consumes increment.
- [ 4 ] For any facility, the emissions unit began (or will begin) initial operation after March 28, 1988. Preliminary determination is that baseline emissions are zero, and emissions unit consumes increment.
- [ 5 ] None of the above apply. If so, the baseline emissions of the emissions unit are nonzero. In such case, additional analysis, beyond the scope of this application, is needed to determine whether changes in emissions have occurred (or will occur) after the baseline date that may consume or expand increment.

3. Increment Consuming/Expanding Code: (C, E, U- unkown):		
PM	U	
SO2	U	
NO2	U	
4. Baseline Emissions:		
PM	lbs/hr	tons/yr
SO2	lbs/hr	tons/yr
NO2	tons/yr	

5. PSD Comment (limit to 200 characters):

This emission unit was constructed in 11/5/59 which pre-dates the major source PSD baseline date of 1/5/75. FPL believes PSD does not apply to this emission unit.

**L. EMISSIONS UNIT SUPPLEMENTAL INFORMATION  
(Regulated Emissions Units Only)**

Information for Facility-ID : / Emission Unit # : /

**Supplemental Requirements for All Applications**

1. Process Flow Diagram : PSNU1_1.bmp Attached Document ID / Not Applicable / Waiver Requested
2. Fuel Analysis or Specification: PSNU1_2.txt Attached Document ID / Not Applicable / Waiver Requested
3. Detailed Description of Control Equipment : Not Applicable Attached Document ID / Not Applicable / Waiver Requested
4. Description of Stack Sampling Facilities : PSNU1_4.bmp Attached Document ID / Not Applicable / Waiver Requested
5. Compliance Test Report : Previously submitted date: 6/12/95 Attached Document ID / Previously submitted, Date / Not Applicable
6. Procedures for Startup and Shutdown : PSNU1_6.txt Attached Document ID / Not Applicable
7. Operation and Maintenance Plan : Not Applicable Attached Document ID / Not Applicable
8. Supplemental Information for Construction Permit Application : Not Applicable Attached Document ID / Not Applicable
9. Other Information Required by Rule or Statute : Not Applicable Attached Document ID / Not Applicable

**Additional Supplemental Requirements for Category I Applications Only**

10. <b>Alternative Methods of Operation</b> : PSNU1_10.txt Attached Document ID / Not Applicable
11. Alternative Modes of Operation (Emissions Trading) : Not Applicable Attached Document ID / Not Applicable
12. Identification of <b>Additional Applicable Requirements</b> : <b>Not Applicable</b> Attached Document ID / Not Applicable
13. Enhanced Monitoring Plan : Not Applicable Attached Document ID / Not Applicable
14. Acid Rain Permit Application  Acid Rain Application - Phase II (Form No. 17-210.900(1)(a)) <b>Attached Document ID: Not Applicable</b>  Repowering Extension Plan (Form No. 17-210.900(1)(b)) Attached Document ID: Not Applicable  New Unit Exemption (Form No. 17-210.900(1)(c)) Attached Document ID: Not Applicable  Retired Unit Exemption (Form No. 17-210.900(1)(c)) Attached Document ID: Not Applicable  Not Applicable

WALKDOWN INFORMATION			TECHNICAL ACCEPTANCE		
ORC	BY	DATE	ORC	BY	DATE
AS-BUILT INFORMATION	ENGINEERING ORGANIZATION				

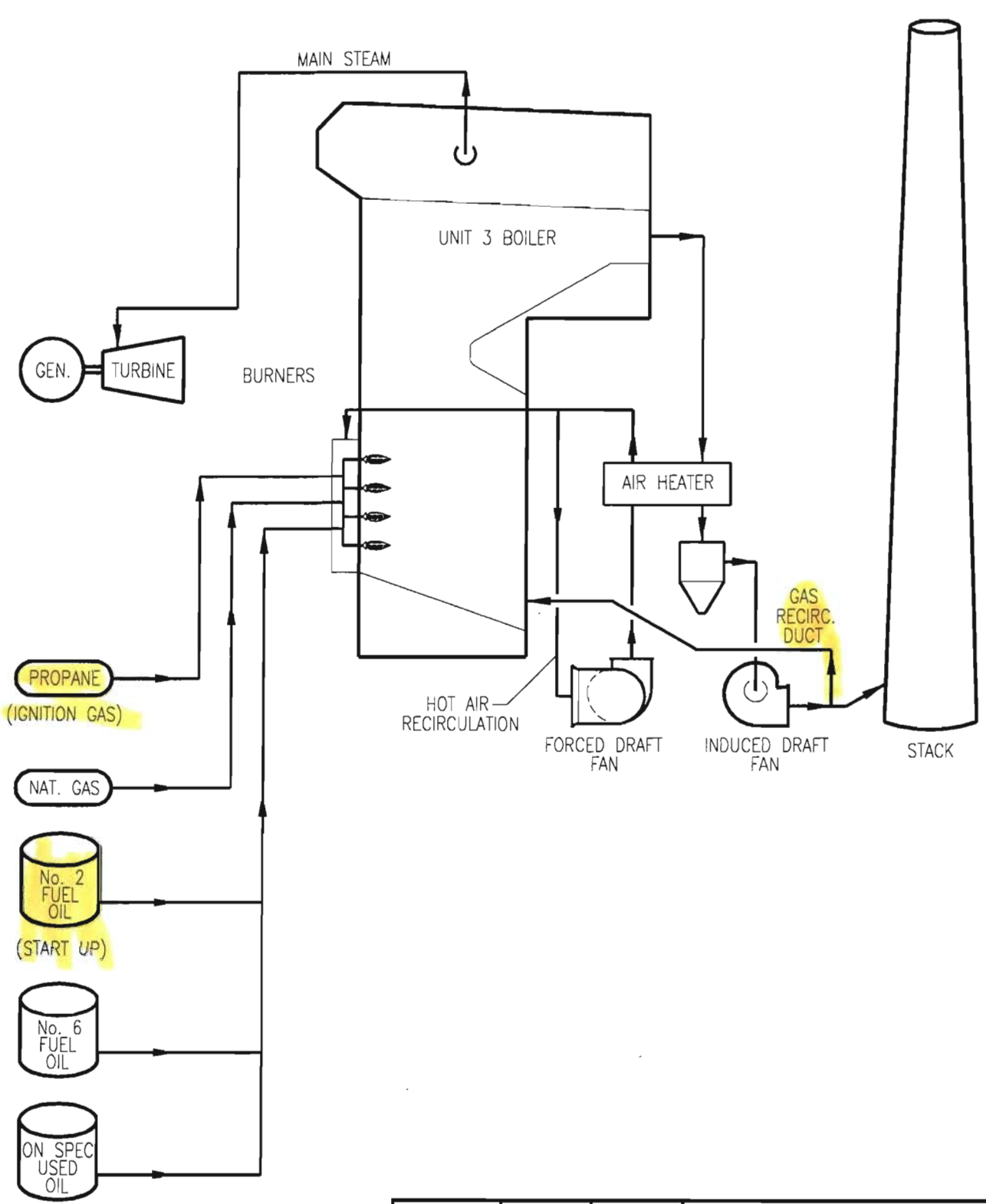

BAR CODE

PERMITTED FUEL OPTIONS

	SYSTEM YY	DISCIPLINE M	PLANT/UNIT SANFORD PLANT
	SCALE N/A	CAD FILE NAME SN004409	TITLE EMISSION UNIT PROCESS FLOW DIAGRAM STEAM GENERATOR/BOILER ATTACHMENT NO. EU1
	DRAWING SIZE A (8.5X11)	FPL ARCHIVE NAME SN004409	

0	7/17/95	ISSUED FOR TITLE V PERMIT	PWB	PWB	CSP	CSP	ETS
REV	DATE	REVISION DESCRIPTION	BY	CH	COR	APR	ORG

DRAWING NUMBER PSN3-M0103-YY	SHEET 1 OF 1	REV 0
---------------------------------	-----------------	----------



Fuel Analysis  
Natural Gas Analysis (typical)<sup>2</sup>

<u>Parameter</u>	<u>Typical value</u>	<u>Max value</u>
Specific gravity(@ 60° F)	0.887	none
Heat content (Btu/cu ft)	950 - 1124	none
% sulfur (grains/CCF)	0.43 <sup>1</sup>	1.00
% nitrogen (by volume)	0.8	none
% ash	negligible	none

\*Note: The values listed are "typical" values based upon information supplied to FPL by Florida Gas Transmission (FGT). However, analytical results from grab samples of fuel taken at any given point in time may vary from those listed.

- (1) Data from laboratory analysis
- (2) The values are "typical" based upon the following:
  - Information gathered by FPL through laboratory analysis, and
  - FPL's fuel purchasing specifications. It should be noted that the analytical results obtained from grab samples taken at any given time may vary from those listed.

## Attachment PSNU1\_2.txt

Fuel Analysis  
No.6 Oil Analysis (typical)<sup>4</sup>

<u>Parameter</u>	<u>Typical value</u>	<u>Specifications</u>
API gravity (@ 60° F)	6 - 12	none
Heat content (MBtu/bbl)	6,310 - 6420	6,340 <sup>1</sup>
% Sulfur	2.0 <sup>5</sup>	2.5 max <sup>3</sup>
% Nitrogen	0.2 - 0.5 <sup>2</sup>	none
% Ash	0.06 - 0.09 <sup>2</sup>	0.10 max <sup>1</sup>

Footnotes:

- (1) Data taken from FPL fuel specifications.
- (2) Data taken from laboratory analysis.
- (3) Maximum permitted from current air operation permit.
- (4) The values are "typical" based upon the following:
  - Information gathered by FPL through laboratory analysis,
  - FPL's fuel purchasing specifications. It should be noted that the analytical results obtained from grab samples taken at any given time may vary from those listed.
- (5) Sulfur content values typically range between 1.6% and 2.4% and are derived from as-fired laboratory analysis of fuel oil fired at Sanford Power Plant.

## Attachment PSNU1\_2.txt

Fuel Analysis  
No. 2 Distillate oil (typical)<sup>3</sup>

<u>Parameter</u>	<u>Typical value</u>	<u>Specifications</u>
API gravity (@ 60 F)	35.0 <sup>2</sup>	30 - 40 <sup>1</sup>
Heat content (MBtu/bbl)	5,700 - 5,800 <sup>2</sup>	none
% sulfur	0.3 - 0.5 <sup>1</sup>	0.5 maximum <sup>1</sup>
% nitrogen	no specification	none
% ash	<0.01 <sup>2</sup>	0.01 <sup>1</sup>

Footnotes:

- (1) Data taken from FPL fuel specifications.
- (2) Data taken from laboratory analysis.
- (3) The values are "typical" based upon the following:
  - Information gathered by FPL through laboratory analysis, and
  - FPL's fuel purchasing specifications. It should be noted that the analytical results obtained from grab samples taken at any given time may vary from those listed.

## Attachment PSNU1\_2.txt

Fuel Analysis  
Propane (typical)<sup>1</sup>

Emission unit #1 may occasionally light off (start up) on propane fuel, then switch to another fuel, such as No.6 residual oil. The propane fuel is supplied by a commercial vendor and is stored in small tanks located at the bottom of the boiler area. The chemical formula for propane is C<sub>3</sub>H<sub>8</sub> .

<u>Parameter</u>	<u>Typical value</u>	<u>Specifications</u>
Specific gravity (@ 60 F)	0.51 <sup>1</sup>	none
Heat content (MBtu/bbl)	600 - 1,000	none
% sulfur	0.0031	none
% nitrogen	no specification	none
% ash	no specification	none

Footnotes:

- (1) The values are "typical" based upon the following:
- Information gathered by FPL through laboratory analysis, and
  - FPL's fuel purchasing specifications. It should be noted that the analytical results obtained from grab samples taken at any given time may vary from those listed.

## Attachment PSNU1\_2.txt

Fuel Analysis  
On Specification Used Oil

The boiler may occasionally burn used oil during normal operation. All used oil fired in the unit meets the specifications mandated by 40 CFR 279.11. Used oil fired by this boiler is typically derived from plant maintenance activities, and may include used lube oils, transformer oils, etc. that meet the analytical specifications. Criteria used oil values follow:

<u>Parameter</u>	<u>Typical value</u>	<u>Specifications</u>
API gravity (@ 60 F)	30.0 <sup>1</sup>	none
Heat content (MBtu/bbl)	6,000 <sup>1</sup>	none
% sulfur	0.3 <sup>1</sup>	none
% nitrogen	negligible	none
% ash	0.01 <sup>1</sup>	0.01

Footnotes:

- (1) The values are "typical" based upon the following:
- Information gathered by FPL through laboratory analysis, and
  - FPL's fuel purchasing specifications. It should be noted that the analytical results obtained from grab samples taken at any given time may vary from those listed.

**FLORIDA POWER & LIGHT CO.  
STACK SAMPLING FACILITIES  
SANFORD SITE**

**FOSSIL FUEL STEAM GENERATOR  
UNIT 3**

**STACK DIAGRAM**

**STACK SPECIFICATIONS**

SAMPLING DIAMETER: 150 in.  
 SAMPLING AREA: 122.7 sq. ft.  
 SAMPLING PORT DEPTH: 85.75 in.  
 No. OF PORTS: 4  
 NOTE: DRAWING IS NOT TO SCALE

**PROBE DIAGRAM**

(Method 17 - Particulate Test)

No. OF POINTS PER TRAVERSE: 6  
 TOTAL No. OF POINTS : 24  
 SAMPLING TIME PER POINT: 2.5 min.  
 TOTAL SAMPLING TIME: 60.0 min.

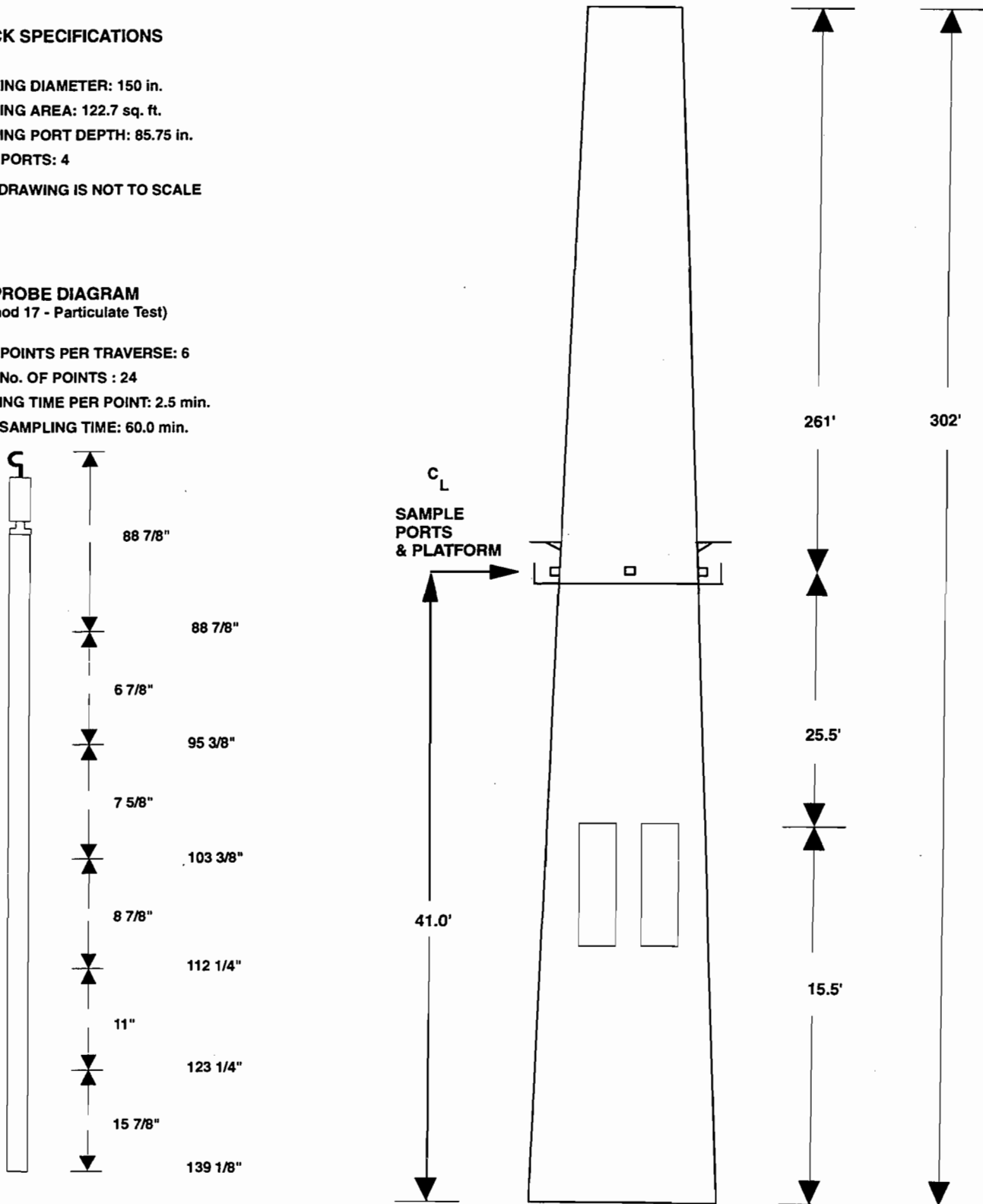

Access to the sampling ports is provided by a ladder. Channel iron with a trolley system is above each port for probe support. AC power is available at the base of the stack.

## Attachment PSNU1\_6.txt

### Startup & Shutdown Procedures - Minimizing Excess Emissions

Startup of the fossil-fuel boiler begins when fuel (either natural gas or oil) is introduced into one or more burners within the boiler and lighted (commencement of combustion). Startup is complete and steady-state operation begins when the combustion process has stabilized and the megawatt load on the unit is stable.

Shutdown of the fossil-fuel boilers begins when unit megawatt load is decreased to below 10% of maximum and continues until the final burner gun is removed from service and the final Induced-draft or Forced-draft fan is removed from service.

Excess emissions may be detected during all modes of boiler operation by any one of several continuous emissions monitors. Continuous emission monitors are currently in place for NO<sub>x</sub>, SO<sub>2</sub>, and opacity. An audible and visual alarm are activated whenever permitted values for any of the above parameters are approached.

Countermeasures which may be taken in the event of excess emissions include, but are not limited to:

- proper excess air adjustments
- recognizing and removal of faulty burners
- fuel oil temperature adjustments
- proper and timely operation of boiler cleaning devices
- removal of the unit from system-dispatch mode
- reduction of unit megawatt load
- stopping and restarting of boiler cleaning devices
- lowering load rate
- pressure rate changes

Best Operational Practices to prevent excess emissions, and knowledge of the appropriate countermeasures to take if an excess emissions condition exists, are taught during routine operator training. Control Center Operators and the Plant Foremen who operate the fossil fuel-fired boilers receive this training. In addition, plant operations and supervisory staff are periodically given Air Regulation Awareness Training by the FPL Environmental Affairs Department. Topics include current permit limits, maximum allowable duration of authorized excess emissions, appropriate countermeasures for excess emissions, duty to notify, etc.

PSNU1\_10.txt  
Alternative Methods of Operation

Operation at Various Capacities and Heat Input Rates

The Sanford Unit 3 boiler may be operated up to 8760 hours per year at heat input rates from zero to 1,650 MMBtu per hour on No.#6 oil, and from zero to 1,762 MMBtu per hour on natural gas. When a blend of fuel oil and natural gas are burned, the heat input is prorated based upon the percent heat input of each fuel.

Different Fuel Types

The unit may be fired with a variable combination of No. 6 residual fuel oil, natural gas, or No. 2 fuel oil. The unit may occasionally utilize propane fuel to light off (start up) the boiler, then switch to another fuel, such as No.6 residual oil. The unit may also burn on-specification used oil meeting EPA specifications under 40 CFR 279.11. The quantity of on-specification used oil shall not exceed 993,384 gallons per year for Unit 3.

Current emissions limitations are as follows:

<u>Pollutant</u>	<u>Emission Limit</u>
Particulate matter-steady state	0.1 lb/MMBtu
Particulate matter-soot blowing	0.3 lb/MMBtu
Sulfur dioxide	2.75 lb/MMBtu

Oil and Gas Co-firing

This emission unit may co-fire natural gas with residual oil. When combusting both fuels simultaneously, the percentage of natural gas will be adjusted to ensure that the applicable SO<sub>2</sub> emission limit and visible emission limits are complied with.

Soot blowing

The unit may blow soot for up to 24 hours per day, so long as excess emissions are limited to 60% opacity for 3 hours in 24 hours with four 6-minute periods of up to 100% opacity.

Utilization of Additives

Additives such as Magnesium hydroxide Mg(OH)<sub>2</sub> are added to the boiler periodically at various loads. When magnesium hydroxide is used, it is injected into the boiler via the I.K. soot blower lances and through manual hand lances on a batch basis, rather than continuously. The dosage rate is based on the quantity of fuel burned and the amount of ash in the fuel. FPL reserves the right to use other additives if they are suitable.



**Attachment PSNU1\_10.txt**  
**Alternative Methods of Operation**

Evaporation of Spent Boiler Chemical Cleaning Chemicals

On a periodic basis, as part of routine maintenance, the inside of the steam generator tubes (boiler tubes) at Sanford Unit 3 are cleaned using a series of chemical solutions that remove deposited scale which adversely affects the efficiency and reliability of the generating units.

The solutions and rinsewaters are collected in large mobile tanks ("frac tanks") pursuant to guidance issued by the Department. Upon completion of the cleaning process and prior to disposal of the spent cleaning solution and rinses, representative sampling of the liquids collected in the "frac tanks" is conducted as per 40 CFR 261, Appendix I, to determine the hazardous waste status of the accumulated wastewater, using Toxicity Characteristic Leaching Procedure (TCLP) analysis.

If the wastewater is determined to be hazardous, it will be managed as such in accordance with 40 CFR 262.34, 40 CFR 265 Subpart I, and 40 CFR 268 with respect to generators accumulating and treating waste in containers and tanks. An appropriate waste analysis plan will be developed to determine and document the pre- and post-treatment characteristics of the wastewater. Hazardous waste may also be transported to an approved hazardous waste facility for the appropriate disposal.

If the spent cleaning solution and rinses are determined to be non-hazardous, they are then disposed by evaporation in the units boiler. Introduction into the boiler will occur at a rate that will not cause an exceedence of the opacity limit of the unit in which evaporation is occurring (in this case, 40 percent opacity).

## Attachment PSNU1\_12.txt

### Identification of Additional Applicable Requirements

Applicable Requirements as defined in Rule 62-210.200(29) not identified in Section D of this emission unit section are included in this attachment of the application. Any air operation permit issued by the Department (or local program designee) and included in this attachment is provided for information purposes. The specific conditions of the operating permit are not Applicable Requirements as defined in Rule 62-210.200(29) unless implementing a specific Applicable Requirement of the Department's rules (e.g. emission limitations and consent orders).

Air operation permit No. AO64-217877 contains the following conditions:

1. Heat input rate for Unit 3 is not to exceed 1,650 mmBtu/hour when firing No. 6 residual fuel oil and 1,762 mmBtu/hour when firing natural gas. Unit 3 shall fire no more than 1.85 million barrels per year of fuel oil if Orimulsion is co-fired in Unit 4. *FPL tracks heat input on a continuous basis using fuel sampling and analysis and fuel flow measurement.*
2. The boiler shall be fired with a variable combination of No. 6 residual fuel oil, natural gas, No. 2 fuel oil, propane gas or on-specification used oil from FPL operations. The quantity of on-specification used oil to be fired shall not exceed 993,384 gallons/year. *FPL tracks the fuel usage on a continuous basis.*
3. The maximum allowable emissions for Unit 3 are as follows:

Pollutant	Fuel	Emission Limit	Test Method
<u>Particulate Matter - Steady-State</u>	Oil	0.1 lb/mmBtu	EPA Method 5 or 17
Soot Blowing or Load Changing	Oil	0.3 lb/mmBtu (3 hrs/24 hrs)	EPA Method 5 or 17
<u>Sulfur Dioxide -</u>	Oil	2.75 lb/mmBtu	Monthly Fuel Analysis
<u>Visible Emissions - Steady-State</u>	Oil	40 percent opacity	DEP Method 9
Soot Blowing or Load Changing	Oil	60 percent opacity (3 hrs/24 hrs)	DEP Method 9

*Handwritten note: 2.95 fired 20%*

*FPL conducts annual compliance testing to determine compliance with permitted emission limitations.*

**III. EMISSIONS UNIT INFORMATION**

Information for Facility - ID : 1 Emission Unit # : 2

A separate Emissions Unit Information Section (including subsections A through L as required) must be completed for each emissions unit addressed in this Application for Air Permit. If submitting the application form in hard copy, indicate, in the space provided at the top of each page, the number of this Emissions Unit Information Section and the total number of Emissions Unit Information Sections submitted as part of this application. Some of the subsections comprising the Emissions Unit Information Section of the form are intended for regulated emissions units only. Others are intended for both regulated and unregulated emissions units. Each subsection is appropriately marked.

**A. TYPE OF EMISSIONS UNIT  
(Regulated and Unregulated Emissions Units)**

**Type of Emissions Unit Addressed in This Section**

1. Regulated or Unregulated Emissions Units? Check one:

- [ X ] The emissions unit addressed in this Emissions Unit Information Section is a regulated emissions unit.
- [ ] The emissions unit addressed in this Emissions Unit Information Section is a unregulated emissions unit.

2. Single Process, Group Processes, or Fugitive Only?

Enter The Number (1-3): 1

- [ 1 ] This Emissions Unit Information Section addresses, as a single emissions unit, a single process or production unit, or activity, which produces one or more air pollutants and which has at least one definable emission point (stack or vent).
- [ 2 ] This Emissions Unit Information Section addresses, as a single emissions unit, a group of process or production units and activities which has at least one definable emission point(stack or vent) but may also produce fugitive emissions.
- [ 3 ] This Emissions Unit Information Section addresses, as a single emissions unit, one or more process or production units and activities which produce fugitive emissions only.

**B. GENERAL EMISSIONS UNIT INFORMATION  
(Regulated and Unregulated Emissions Units)**

**Emissions Unit Description and Status**

1. Description of Emissions Unit Addressed in This Section (limit to 60 characters): Unit 4 Fossil Fuel Steam Generator
2. Emissions Unit Identification Number: 002 (No Corresponding ID or Unknown)
3. Emission Unit Status Code: (A or C) : A
4. Acid Rain Unit? (Y/N): Y
5. Emissions Unit Major Group SIC Code: 49
6. Emissions Unit Comment (limit to 500 characters): Fly ash reinjection is part of the original design of the multicyclone separator, but has not been used for many years. Generator nameplate rating is from the 10-year Site Plan that FPL provides yearly to the Florida PSC. Actual generator output may exceed the value given, or may vary with changes in unit efficiency, or due to fluctuations in system load demand.  Method of compliance for determining the heat input rate is fuel sampling and analysis in conjunction with fuel flow measurement.

**Emissions Unit Control Equipment**

**A. Control Equipment # : 1**

1. Description (limit to 200 characters): Multiple cyclone w/Fly ash Reinjection
2. Control Device or Method Code: Multiple Cyclone w/Fly Ash Reinjection

**B. Control Equipment # :**

1. Description (limit to 200 characters):
2. Control Device or Method Code:

**C. Control Equipment # :**

1. Description (limit to 200 characters):
2. Control Device or Method Code:



**D. EMISSIONS UNIT REGULATIONS  
(Regulated Emissions Units Only)**

**Rule Applicability Analysis** (Required for Category II applications and Category III applications involving non Title-V sources. See Instructions.)

Not Applicable

**List of Applicable Regulations** (Required for Category I applications and Category III applications involving Title-V sources. See Instructions.)

Emissions Unit ID 2

<p>40 C.F.R. 279.72  40 C.F.R. 72.20(a)  40 C.F.R. 72.20(b)  40 C.F.R. 72.20(c)  40 C.F.R. 72.21(a)  40 C.F.R. 72.21(b)  40 C.F.R. 72.21(d)  40 C.F.R. 72.22(a)  40 C.F.R. 72.22(c)  40 C.F.R. 72.23  40 C.F.R. 72.24(a)  40 C.F.R. 72.30(a)  40 C.F.R. 72.30(b)(2)  40 C.F.R. 72.30(c)  40 C.F.R. 72.30(d)  40 C.F.R. 72.32  40 C.F.R. 72.33(b)  40 C.F.R. 72.33(c)  40 C.F.R. 72.33(d)  40 C.F.R. 72.40(a)  40 C.F.R. 72.40(b)  40 C.F.R. 72.40(c)  40 C.F.R. 72.40(d)  40 C.F.R. 72.51  40 C.F.R. 72.90  40 C.F.R. 72.9(a)(1)(iii)  40 C.F.R. 72.9(a)(1)(i)  40 C.F.R. 72.9(a)(2)  40 C.F.R. 72.9(b)  40 C.F.R. 72.9(c)(1)(iii)  40 C.F.R. 72.9(c)(2)  40 C.F.R. 72.9(c)(4)  40 C.F.R. 72.9(c)(5)  40 C.F.R. 72.9(d)  40 C.F.R. 72.9(e)  40 C.F.R. 72.9(f)  40 C.F.R. 72.9(g)(4)  40 C.F.R. 73.33  40 C.F.R. 73.35  40 C.F.R. 75 Appendix A-1  40 C.F.R. 75 Appendix A-2  40 C.F.R. 75 Appendix A-3  40 C.F.R. 75 Appendix A-4  40 C.F.R. 75 Appendix A-5  40 C.F.R. 75 Appendix A-6</p>	<p>40 C.F.R. 75 Appendix B  40 C.F.R. 75 Appendix C-1  40 C.F.R. 75 Appendix C-2  40 C.F.R. 75 Appendix D  40 C.F.R. 75 Appendix F  40 C.F.R. 75 Appendix G-2  40 C.F.R. 75 Appendix G-4  40 C.F.R. 75 Appendix H  40 C.F.R. 75.10(a)(1)  40 C.F.R. 75.10(a)(2)  40 C.F.R. 75.10(a)(3)(i)  40 C.F.R. 75.10(a)(4)  40 C.F.R. 75.10(b)  40 C.F.R. 75.10(c)  40 C.F.R. 75.10(d)  40 C.F.R. 75.10(f)  40 C.F.R. 75.10(g)  40 C.F.R. 75.11(b)(1)  40 C.F.R. 75.11(c)(3)  40 C.F.R. 75.11(d)  40 C.F.R. 75.12(a)  40 C.F.R. 75.12(b)  40 C.F.R. 75.13(a)  40 C.F.R. 75.13(b)  40 C.F.R. 75.14(a)  40 C.F.R. 75.20(a)(5)  40 C.F.R. 75.20(b)  40 C.F.R. 75.20(c)  40 C.F.R. 75.20(d)  40 C.F.R. 75.20(f)  40 C.F.R. 75.20(g)  40 C.F.R. 75.21(a)  40 C.F.R. 75.21(b)  40 C.F.R. 75.21(c)  40 C.F.R. 75.21(d)  40 C.F.R. 75.21(e)  40 C.F.R. 75.21(f)  40 C.F.R. 75.22  40 C.F.R. 75.24  40 C.F.R. 75.30(a)(1)  40 C.F.R. 75.30(a)(2)  40 C.F.R. 75.30(a)(3)  40 C.F.R. 75.31  40 C.F.R. 75.32  40 C.F.R. 75.33</p>	<p>40 C.F.R. 75.35  40 C.F.R. 75.36  40 C.F.R. 75.4(a)(4)(ii)  40 C.F.R. 75.5  40 C.F.R. 75.51(c)  40 C.F.R. 75.53(a)  40 C.F.R. 75.53(b)  40 C.F.R. 75.53(c)  40 C.F.R. 75.53(d)(1)  40 C.F.R. 75.54  40 C.F.R. 75.55(c)  40 C.F.R. 75.55(e)  40 C.F.R. 75.56  40 C.F.R. 75.60(a)  40 C.F.R. 75.60(b)  40 C.F.R. 75.60(c)(3)  40 C.F.R. 75.61(a)(1)  40 C.F.R. 75.61(a)(5)  40 C.F.R. 75.61(b)  40 C.F.R. 75.62  40 C.F.R. 75.63  40 C.F.R. 75.64(a)  40 C.F.R. 75.64(b)  40 C.F.R. 75.64(c)  40 C.F.R. 75.64(d)  40 C.F.R. 75.65  40 C.F.R. 75.66(a)  40 C.F.R. 75.66(b)  40 C.F.R. 75.66(c)  40 C.F.R. 75.66(d)  40 C.F.R. 75.66(g)  40 C.F.R. 75.66(h)  40 C.F.R. 76.13  40 C.F.R. 77.3  40 C.F.R. 77.5(b)  40 C.F.R. 77.6  F.A.C. 62-204.800(12)  (state only)  F.A.C. 62-204.800(13)  (state only)  F.A.C. 62-204.800(14)  (state only)  F.A.C. 62-210.650  F.A.C. 62-210.700 (1)  F.A.C. 62-210.700 (2)  F.A.C. 62-210.700 (3)  F.A.C. 62-210.700 (4)  F.A.C. 62-210.700 (6)</p>	<p>F.A.C. 62-214.300  F.A.C. 62-214.330  F.A.C. 62-214.350 (2)  F.A.C. 62-214.350 (3)  F.A.C. 62-214.350 (5)  F.A.C. 62-214.350 (6)  F.A.C. 62-214.370 (1)  F.A.C. 62-214.370 (3)  F.A.C. 62-214.370 (4)  F.A.C. 62-214.370 (7)  F.A.C. 62-214.430  F.A.C. 62-296.405(1)(a)  paragraph 2  F.A.C. 62-296.405(1)(b)  F.A.C. 62-296.405(1)(c)1.j.  F.A.C. 62-296.405(1)(e)(1)  F.A.C. 62-296.405(1)(e)(2)  F.A.C. 62-296.405(1)(e)(3)  F.A.C.  62-296.405(1)(f)1.a.(i)  F.A.C. 62-296.405(1)(f)1.b.  F.A.C. 62-296.500(2)(a)1.  F.A.C. 62-296.500(2)(c)  F.A.C. 62-297.310(1)  F.A.C. 62-297.310(2)(b)  F.A.C. 62-297.310(3)  F.A.C. 62-297.310(4)(a)1.  F.A.C. 62-297.310(4)(a)2.c.  F.A.C. 62-297.310(4)(b)  F.A.C. 62-297.310(4)(c)  F.A.C. 62-297.310(4)(d)  F.A.C. 62-297.310(4)(e)  F.A.C. 62-297.310(5)  F.A.C. 62-297.310(6)(a)  F.A.C. 62-297.310(6)(c)  F.A.C. 62-297.310(6)(d)  F.A.C. 62-297.310(6)(e)  F.A.C. 62-297.310(6)(f)  F.A.C. 62-297.310(6)(g)  F.A.C. 62-297.310(7)(a)1.  F.A.C. 62-297.310(7)(a)2.  F.A.C. 62-297.310(7)(a)3.  F.A.C. 62-297.310(7)(a)4.  F.A.C. 62-297.310(7)(a)5.  F.A.C. 62-297.310(7)(a)9.  F.A.C. 62-297.310(7)(c)  F.A.C. 62-297.310(8)  Table 62-297.310-1</p>
-----------------------------------------------------------------------------------------------------------------------------------------------------------------------------------------------------------------------------------------------------------------------------------------------------------------------------------------------------------------------------------------------------------------------------------------------------------------------------------------------------------------------------------------------------------------------------------------------------------------------------------------------------------------------------------------------------------------------------------------------------------------------------------------------------------------------------------------------------------------------------------------------------------------------------------------------------------------------------------------------------------------------------------------------------------------------------------------------------------------------------------------------------------------------------	---------------------------------------------------------------------------------------------------------------------------------------------------------------------------------------------------------------------------------------------------------------------------------------------------------------------------------------------------------------------------------------------------------------------------------------------------------------------------------------------------------------------------------------------------------------------------------------------------------------------------------------------------------------------------------------------------------------------------------------------------------------------------------------------------------------------------------------------------------------------------------------------------------------------------------------------------------------------------------------------------------------------------------------------------------------------------------------------------------------------------------------------------------------------------------------------	-------------------------------------------------------------------------------------------------------------------------------------------------------------------------------------------------------------------------------------------------------------------------------------------------------------------------------------------------------------------------------------------------------------------------------------------------------------------------------------------------------------------------------------------------------------------------------------------------------------------------------------------------------------------------------------------------------------------------------------------------------------------------------------------------------------------------------------------------------------------------------------------------------------------------------------------------------------------------------------------------------------------------------------------------------------------------------------------------------------------------------------------------------------------------------------	--------------------------------------------------------------------------------------------------------------------------------------------------------------------------------------------------------------------------------------------------------------------------------------------------------------------------------------------------------------------------------------------------------------------------------------------------------------------------------------------------------------------------------------------------------------------------------------------------------------------------------------------------------------------------------------------------------------------------------------------------------------------------------------------------------------------------------------------------------------------------------------------------------------------------------------------------------------------------------------------------------------------------------------------------------------------------------------------------------------------------------------------------------------------------------------------------------------------------------------------------------------------------------------------------------------------------------------------------------------------------------------------------------



**E. EMISSION POINT (STACK/VENT) INFORMATION  
(Regulated Emissions Units Only)**

**Emission Point Description and Type**

Information for Facility-ID 1 Emission Unit # :2

1. Identification of Point on Plot Plan or Flow Diagram: EU2-Boiler No. 4
2. Emission Point Type Code (1,2,3,4) : 1
3. Descriptions of Emissions Points Comprising this Emissions Unit (limit to 100 characters):
4. ID Numbers or Descriptions of Emission Units with this Emission Point in Common:
5. Discharge Type Code (D, F, H, P, R, V, W) : v
6. Stack Height: 400 ft
7. Exit Diameter: 19.2 ft
8. Exit Temperature: 308 °F
9. Actual Volumetric Flow Rate: 1433038.1 acfm
10. Percent Water Vapor: %
11. Maximum Dry Standard Flow Rate: dscfm
12. Nonstack Emission Point Height: ft
13. Emission Point UTM Coordinates: Zone: 17 East: 468.34 North: 3190.59
14. Emission Point Comment (limit to 200 characters): The information in items 8 and 9 above reflects the highest measured temperature and flow rate during the July 1994 particulate test for this unit. Flow rates measured at other times may vary.

**F. SEGMENT (PROCESS/FUEL) INFORMATION  
(Regulated and Unregulated Emissions Units)**

**Segment Description and Rate:**

Information for Facility\_ID :1 Emission Unit #: 2 Segment #: 1

1. Segment Description (Process/Fuel Type and Associated Operating Method/Mode) (limit to 500 characters): Unit 4 Boiler burning natural gas fuel
2. Source Classification Code (SCC): 1-01-006-01
3. SCC Units: Million cubic feet burned
4. Maximum Hourly Rate: 4.029
5. Maximum Annual Rate: 35294
6. Estimated Annual Activity Factor:
7. Maximum Percent Sulfur: 0.0031
8. Maximum Percent Ash:
9. Million Btu per SCC Unit: 1050
10. Segment Comment (limit to 200 characters): The unit is currently permitted to burn a variable combination of No. 6 residual oil, natural gas, No. 2 fuel oil, propane gas, Orimulsion, or on-specification used oil from FPL operations.

**F. SEGMENT (PROCESS/FUEL) INFORMATION  
(Regulated and Unregulated Emissions Units)**

**Segment Description and Rate:**

Information for Facility\_ID :1 Emission Unit #: 2 Segment #: 2

1. Segment Description (Process/Fuel Type and Associated Operating Method/Mode) (limit to 500 characters): Unit 4 Boiler burning No. 6 residual oil
2. Source Classification Code (SCC): 1-01-004-01
3. SCC Units: thousand gallons burned
4. Maximum Hourly Rate: 26.64
5. Maximum Annual Rate: 233366.4
6. Estimated Annual Activity Factor:
7. Maximum Percent Sulfur: 2.5
8. Maximum Percent Ash: 0.1
9. Million Btu per SCC Unit: 152
10. Segment Comment (limit to 200 characters): The unit is currently permitted to burn a variable combination of No. 6 residual oil, natural gas, No. 2 fuel oil, propane gas, Orimulsion, or on-specification used oil from FPL operations.

**F. SEGMENT (PROCESS/FUEL) INFORMATION  
(Regulated and Unregulated Emissions Units)**

**Segment Description and Rate:**

Information for Facility\_ID :1 Emission Unit #: 2 Segment #: 3

1. Segment Description (Process/Fuel Type and Associated Operating Method/Mode) (limit to 500 characters): Unit 4 Boiler burning No.2 diesel oil
2. Source Classification Code (SCC): 1-01-005-01
3. SCC Units: Thousand gallons burned
4. Maximum Hourly Rate: 29.78
5. Maximum Annual Rate: 260873
6. Estimated Annual Activity Factor:
7. Maximum Percent Sulfur: 0.5
8. Maximum Percent Ash:
9. Million Btu per SCC Unit: 136
10. Segment Comment (limit to 200 characters): The unit is currently permitted to burn a variable combination of No. 6 residual oil, natural gas, No. 2 fuel oil, propane gas, Orimulsion, or on-specification used oil from FPL operations.

**F. SEGMENT (PROCESS/FUEL) INFORMATION  
(Regulated and Unregulated Emissions Units)**

**Segment Description and Rate:**

Information for Facility\_ID :1 Emission Unit #: 2 Segment #: 4

1. Segment Description (Process/Fuel Type and Associated Operating Method/Mode) (limit to 500 characters): Unit 4 Boiler burning propane
2. Source Classification Code (SCC): 1-01-006-01
3. SCC Units: Million cubic feet burned
4. Maximum Hourly Rate: 4.23
5. Maximum Annual Rate: 37055
6. Estimated Annual Activity Factor:
7. Maximum Percent Sulfur: 0
8. Maximum Percent Ash:
9. Million Btu per SCC Unit: 1000
10. Segment Comment (limit to 200 characters): Propane gas is used primarily for lighting off the boiler for start-up.

**F. SEGMENT (PROCESS/FUEL) INFORMATION  
(Regulated and Unregulated Emissions Units)**

**Segment Description and Rate:**

Information for Facility\_ID : / Emission Unit #: 2 Segment #: 5

1. Segment Description (Process/Fuel Type and Associated Operating Method/Mode) (limit to 500 characters): Unit 4 Boiler burning on-specification used oil
2. Source Classification Code (SCC): 1-01-013-02
3. SCC Units: thousand gallons burned
4. Maximum Hourly Rate: 29.78
5. Maximum Annual Rate: 2442.972
6. Estimated Annual Activity Factor:
7. Maximum Percent Sulfur: 2.5
8. Maximum Percent Ash:
9. Million Btu per SCC Unit: 136
10. Segment Comment (limit to 200 characters): The unit is currently permitted to burn a variable combination of No. 6 residual oil, natural gas, No. 2 fuel oil, propane gas, Orimulsion, or on-specification used oil from FPL operations.

**F. SEGMENT (PROCESS/FUEL) INFORMATION  
(Regulated and Unregulated Emissions Units)**

**Segment Description and Rate:**

Information for Facility\_ID :/ Emission Unit #: 2 Segment #: 6

1. Segment Description (Process/Fuel Type and Associated Operating Method/Mode) (limit to 500 characters): Unit 4 co-firing all possible combinations of natural gas, residual oil, on specification used oil, #2 fuel oil, and propane.
2. Source Classification Code (SCC): 1-01-006-01
3. SCC Units: million cubic feet and thousand gallons
4. Maximum Hourly Rate:
5. Maximum Annual Rate:
6. Estimated Annual Activity Factor:
7. Maximum Percent Sulfur: 1
8. Maximum Percent Ash: 0.1
9. Million Btu per SCC Unit:
10. Segment Comment (limit to 200 characters): Air Operation Permit # AO-64-217877 allows Unit 4 to burn a mixture of the above fuels in a ratio that will result in a max. SO2 emission rate of 2.75 lbs/mmBtu.

**F. SEGMENT (PROCESS/FUEL) INFORMATION  
(Regulated and Unregulated Emissions Units)**

**Segment Description and Rate:**

Information for Facility\_ID :1 Emission Unit #: 2 Segment #: 7

1. Segment Description (Process/Fuel Type and Associated Operating Method/Mode) (limit to 500 characters): Unit 4 Boiler chemical cleaning waste evaporation
2. Source Classification Code (SCC): 1-01-013-01
3. SCC Units: thousand gallons burned
4. Maximum Hourly Rate: 3
5. Maximum Annual Rate: 500
6. Estimated Annual Activity Factor:
7. Maximum Percent Sulfur:
8. Maximum Percent Ash:
9. Million Btu per SCC Unit:
10. Segment Comment (limit to 200 characters): Items 6,7,8 & 9 do not apply. This activity to be undertaken on a periodic basis in accordance with DARM guidance, and EPA waste rules (40 CFR 279.72).



**F. SEGMENT (PROCESS/FUEL) INFORMATION  
(Regulated and Unregulated Emissions Units)**

**Segment Description and Rate:**

Information for Facility\_ID : / Emission Unit #: 2 Segment #: 8

1. Segment Description (Process/Fuel Type and Associated Operating Method/Mode) (limit to 500 characters): Unit 4 Boiler co-firing Orimulsion with natural gas and No. 6 fuel oil.
2. Source Classification Code (SCC): 1-01-006-01
3. SCC Units: million cubic feet burned
4. Maximum Hourly Rate: 11.34
5. Maximum Annual Rate: 99338.4
6. Estimated Annual Activity Factor:
7. Maximum Percent Sulfur: 0.5
8. Maximum Percent Ash: 0
9. Million Btu per SCC Unit: 1050
10. Segment Comment (limit to 200 characters): Values in the fields above represent natural gas specifications. For fuel no. 6 and orimulsion refer to attachment PSNU2_2.txt. The specification for the co-firing mode are: % S = 4.0 and % ash = 0.25.

#6 oil?

**F. SEGMENT (PROCESS/FUEL) INFORMATION  
(Regulated and Unregulated Emissions Units)**

**Segment Description and Rate:**

Information for Facility\_ID :1 Emission Unit #: 2 Segment #: 9

1. Segment Description (Process/Fuel Type and Associated Operating Method/Mode) (limit to 500 characters): Unit 4 Boiler co-firing <b>Orimulsion</b> with natural gas.
2. Source Classification Code (SCC): 1-01-006-01
3. SCC Units: million cubic feet burned
4. Maximum Hourly Rate: 2.268
5. Maximum Annual Rate: 19867.68 <i>Less than w/ oil?</i>
6. Estimated Annual Activity Factor:
7. Maximum Percent Sulfur: 0.0031
8. Maximum Percent Ash: 0
9. Million Btu per SCC Unit: 1050
10. Segment Comment (limit to 200 characters): Information in fields above are representative of natural gas only. <b>Orimulsion fuel specifications are: % sulfur is 2.9, % ash is 0.25, and million Btu per thousand gallons burned is 1050.</b>

**G. EMISSIONS UNIT POLLUTANTS  
(Regulated Emissions Units Only)**

**Information for Facility\_ID: 1 Emission Unit #: 2**

1. Pollutant Emitted	2. Primary Control Device Code	3. Secondary Control Device Code	4. Pollutant Regulatory Code
SO2	NA	NA	EL
NOX	NA	NA	NS
CO	NA	NA	NS
PM	077	NA	EL
PM10	077	NA	NS
VOC	NA	NA	NS
H133	NA	NA	NS
H107	NA	NA	NS
H106	NA	NA	NS
SAM	NA	NA	NS
HAP	NA	NA	NS

**H. EMISSIONS UNIT POLLUTANT DETAIL INFORMATION  
(Regulated Emissions Units Only - Emissions Limited Pollutants Only)**

**Information for Facility\_ID: 1 Emission Unit #: 2 Pollutant #: 1**

**Pollutant Detail Information**

1. Pollutant Emitted: <b>Particulate Matter - Total</b>	
2. Total Percent Efficiency of Control:	%
3. Potential Emissions: 506.25 lbs/hr	<b>2217.38 tons/yr</b>
4. <b>Synthetically Limited?</b> (Yes/No): <b>N</b>	
5. Range of Estimated Fugitive/Other Emissions: (1, 2, 3) : to tons/yr	
6. Emission Factor: 0.125	<b>Units</b> lb/mmBtu
Reference: DEP Rule 62-296.405(1)(b)	
7. Emissions Method Code: (0, 1, 2, 3, 4, 5): 0 <input type="checkbox"/> 0 <input type="checkbox"/> 1 <input type="checkbox"/> 2 <input type="checkbox"/> 3 <input type="checkbox"/> 4 <input type="checkbox"/> 5	
8. Calculation of Emissions (limit to 600 characters):  0.125 lb/mmBtu * 4050 mmBtu/hr = 506.25 lb/hr (506.25 lb/hr * 8760 hr/yr) / 2000 lb/ton = 2217.38 tpy	
9. Pollutant Potential/Estimated Emissions Comment (limit to 200 characters): A particulate matter emissions limit of 3 hours /24 hours at 0.3 lb/mmBtu and 21 hours/24hours at 0.1 lb/mmBtu is equivalent to an average of 0.125 lb/mmBtu.	

**Information for Facility\_ID: 1 Emission Unit #: 2 Pollutant #: 1  
Basis For Allowable Emission #: 1**

**Allowable Emissions** (Pollutant identified on front page)

1. Basis for Allowable Emissions Code:	Emissions limit required by rule
2. Future Effective Date of Allowable Emissions:	
3. Requested Allowable Emissions and Units:	0.1 Units : lb/mmBtu
4. Equivalent Allowable Emissions:	405 lbs/hr 1552.2 tons/yr
5. Method of Compliance:	DEP Rule 62-296.405(1)(e)2.
6. Pollutant Allowable Emissions Comment ( <b>Desc. of Related Operating Method/Mode</b> ) (limit to 200 characters): 175 FDEP Rule 62-296.340(1)(e) is the basis for the emission limit. The equivalent allowable emissions given above are based on steady-state operation <u>21 hours per 24-hour period.</u>	

**Information for Facility\_ID: 1 Emission Unit #: 2 Pollutant #: 1  
Basis For Allowable Emission #: 2**

**Allowable Emissions** (Pollutant identified on front page)

1. Basis for Allowable Emissions Code: Emissions limit required by rule
2. Future Effective Date of Allowable Emissions:
3. Requested Allowable Emissions and Units: 0.3 Units : lb/mmBtu
4. Equivalent Allowable Emissions: 1215 lbs/hr 665.2 tons/yr
5. Method of Compliance: DEP Rule 62-296.405(1)(e)2.
6. Pollutant Allowable Emissions Comment ( <b>Desc. of Related Operating Method/Mode</b> ) (limit to 200 characters): 133 Equivalent allowable emissions based on 3 hours of sootblowing per 24-hour period. Regulatory limit on PM is from Rule 62-210.700(1).

**H. EMISSIONS UNIT POLLUTANT DETAIL INFORMATION  
(Regulated Emissions Units Only - Emissions Limited Pollutants Only)**

Information for Facility\_ID: 1 Emission Unit #: 2 Pollutant #: 3

**Pollutant Detail Information**

1. Pollutant Emitted:	Sulfur Dioxide
2. Total Percent Efficiency of Control:	%
3. Potential Emissions:	11137.5 lbs/hr                      48782.3 tons/yr
4. Synthetically Limited? (Yes/No):	N
5. Range of Estimated Fugitive/Other Emissions: (1, 2, 3):	to tons/yr
6. Emission Factor:	2.75                      Units    lb/mmBtu
Reference:	DEP Rule 62-296.405(1)(c)1.j.
7. Emissions Method Code: (0, 1, 2, 3, 4, 5):	0
	<input type="checkbox"/> 0 <input type="checkbox"/> 1 <input type="checkbox"/> 2 <input type="checkbox"/> 3 <input type="checkbox"/> 4 <input type="checkbox"/> 5
8. Calculation of Emissions (limit to 600 characters):	
	2.75 lb/mmBtu * 4050 mmBtu = 11,137.5 lb/hr 11,137.5 * 8760 hr/yr / 2000 lb/ton = 48,782.3 TPY
9. Pollutant Potential/Estimated Emissions Comment (limit to 200 characters):	
	Sanford Unit 4 could fire a mixture of No. 6 fuel oil with up to 4.0% sulfur with sufficient quantities of natural gas to meet the 2.75 lb/mmBtu heat input SO2 emission limit.

**Information for Facility\_ID: 1 Emission Unit #: 2 Pollutant #: 3  
Basis For Allowable Emission #: 1**

**Allowable Emissions** (Pollutant identified on front page)

1. Basis for Allowable Emissions Code:	Emissions limit required by rule
2. Future Effective Date of Allowable Emissions:	
3. Requested Allowable Emissions and Units:	2.75 Units : lb/mmBtu
4. Equivalent Allowable Emissions:	11137.5 lbs/hr 48782.3 tons/yr
5. Method of Compliance:	Fuel sampling & analysis
6. Pollutant Allowable Emissions Comment ( <b>Desc. of Related Operating Method/Mode</b> ) (limit to 200 characters): 139 Information provided on this page is for No.6 residual oil firing only. FDEP permit limit and emission factor are for fuel oil firing only.	



**Information for Facility\_ID: 1 Emission Unit #: 2 Pollutant #: 3  
Basis For Allowable Emission #: 2**

**Allowable Emissions** (Pollutant identified on front page)

1. Basis for Allowable Emissions Code: <b>Current FDEP Air Operating Permit #AO64-217877</b>
2. Future Effective Date of Allowable Emissions:
3. Requested Allowable Emissions and Units: <b>1.6 Units : lb/mmBtu</b>
4. Equivalent Allowable Emissions: <b>6480 lbs/hr 28382.4 tons/yr</b>
5. Method of Compliance: <b>DEP Rule 62-296.405(1)(e)3.</b>
6. Pollutant Allowable Emissions Comment ( <b>Desc. of Related Operating Method/Mode</b> ) (limit to 200 characters): <b>142</b> Information provided on this page is for <b>Orimulsion co-firing only. FDEP permit limit and emission factors are for orimulsion co-firing only.</b>

**I. VISIBLE EMISSIONS INFORMATION  
(Regulated Emissions Units Only)**

Information for Facility-ID : 1 Emission Unit #: 2  
Visible Emissions Limitation #: 1

1. Visible Emissions Subtype: VE40
2. Basis for Allowable Opacity Code(R/O):   RULE       [ ] Rule       [ ] Other
3. Allowable Opacity: Normal Conditions: 40                           % Exceptional Conditions:    % Maximum Period of Excess Opacity Allowed:   min/hr
4. Method of Compliance Code:   EPA Method 9
5. Visible Emissions Comment (limit to 200 characters): DEP Rule 62-296.405(1)(a) and (1)(e)1., F.A.C. Visible Emissions limited to 40% opacity, except for allowed excess emissions. Compliance testing is performed annually using EPA Method 9.

**I. VISIBLE EMISSIONS INFORMATION  
(Regulated Emissions Units Only)**

Information for Facility-ID : 1 Emission Unit #: 2  
Visible Emissions Limitation #: 2

1. Visible Emissions Subtype: VE60
2. Basis for Allowable Opacity Code(R/O): RULE <input type="checkbox"/> Rule <input type="checkbox"/> Other
3. Allowable Opacity: Normal Conditions: 60                      % Exceptional Conditions: 100    % Maximum Period of Excess Opacity Allowed: 24    min/hr
4. Method of Compliance Code: EPA Method 9
5. Visible Emissions Comment (limit to 200 characters): Rule 62-210.700(3), F.A.C. limits soot blowing & load changing to 60% opacity for up to 3 hrs/24 hrs, with < 4, 6-minute pds of up to 100% opac. if unit has an operational CEM.



**J. CONTINUOUS MONITOR INFORMATION  
(Regulated Emissions Units Only)**

Information for Facility-ID : 1 Emission Unit #: 2  
Continuous Monitor #: 1

**Continuous Monitoring System**

1. Parameter Code:		
2. Pollutant(s):	Sulfur Dioxide	
3. CMS Requirement Code(R/O):	RULE	Rule / Other
4. Monitor Information:		
Manufacturer:	TECO	
Model Number:	43B	Serial Number: 43B-49518-284
5. Installation Date (DD-MON-YYYY):	11/08/94	
6. Performance Specification Test Date (DD-MON-YYYY):	12/02/94	
7. Continuous Monitor Comment (limit to 200 characters):	Required by 40 CFR 75.10(a)(1)	

**J. CONTINUOUS MONITOR INFORMATION**  
**(Regulated Emissions Units Only)**

Information for Facility-ID : 1 Emission Unit #: 2  
Continuous Monitor #: 2

**Continuous Monitoring System**

1. Parameter Code:			
2. Pollutant(s):		Nitrogen Oxides	
3. CMS Requirement Code(R/O):			
RULE	Rule	/ Other	
4. Monitor Information:			
Manufacturer: TECO		Serial Number: 42-40011-262	
Model Number: 42			
5. Installation Date (DD-MON-YYYY): 11/08/94			
6. Performance Specification Test Date (DD-MON-YYYY): 12/02/94			
7. Continuous Monitor Comment (limit to 200 characters): Required by 40 CFR 75.10(a)(2)			

**J. CONTINUOUS MONITOR INFORMATION**  
**(Regulated Emissions Units Only)**

Information for Facility-ID : 1 Emission Unit #: 2  
Continuous Monitor #: 3

**Continuous Monitoring System**

1. Parameter Code:			
2. Pollutant(s):		Carbon dioxide	
3. CMS Requirement Code(R/O):			
RULE	Rule	/ Other	
4. Monitor Information:			
Manufacturer: Milton Roy		Serial Number: N2E0313T	
Model Number: 3300			
5. Installation Date (DD-MON-YYYY): 11/08/94			
6. Performance Specification Test Date (DD-MON-YYYY): 12/02/94			
7. Continuous Monitor Comment (limit to 200 characters): Required by 40 CFR 75.10(a)(3)(i)			

**J. CONTINUOUS MONITOR INFORMATION  
(Regulated Emissions Units Only)**

Information for Facility-ID : 1 Emission Unit #: 2  
Continuous Monitor #: 4

**Continuous Monitoring System**

1. Parameter Code:		
2. Pollutant(s):	Volumetric flow rate	
3. CMS Requirement Code(R/O):	RULE	Rule / Other
4. Monitor Information:		
Manufacturer:	Air Monitor	
Model Number:	MASSTRON	Serial Number: 4949
5. Installation Date (DD-MON-YYYY):	11/08/94	
6. Performance Specification Test Date (DD-MON-YYYY):	12/02/94	
7. Continuous Monitor Comment (limit to 200 characters):	Required by 40 CFR 75.10(a)(1)	



**J. CONTINUOUS MONITOR INFORMATION  
(Regulated Emissions Units Only)**

Information for Facility-ID : 1 Emission Unit #: 2  
Continuous Monitor #: 5

**Continuous Monitoring System**

1. Parameter Code:		
2. Pollutant(s):	Visible emissions (opacity)	
3. CMS Requirement Code(R/O):	RULE	Rule / Other
4. Monitor Information:		
Manufacturer:	Lear Siegler	
Model Number:	RM41	Serial Number: 38880
5. Installation Date (DD-MON-YYYY):	03/01/78	
6. Performance Specification Test Date (DD-MON-YYYY):	01/11/95	
7. Continuous Monitor Comment (limit to 200 characters): Required by 40 CFR 75.10(a)(4). The date of manufacture is used as the installation date. The actual date of manufacture is not known, so the first day of the month was substituted.		

**K. PREVENTION OF SIGNIFICANT DETERIORATION (PSD) INCREMENT  
TRACKING INFORMATION  
(Regulated and Unregulated Emissions Units)**

Information for Facility-ID : 1 Emission Unit # : 2

**PSD Increment Consumption Determination**

**1. Increment Consuming for Particulate Matter or Sulfur Dioxide?**

If the emissions unit addressed in this section emits particulate matter or sulfur dioxide, answer the following series of questions to make a preliminary determination as to whether or not the emissions unit consumes PSD increment for particulate matter or sulfur dioxide. Check the first statement, if any, that applies and skip remaining statements.

Select (1-5) : 5

- [ 1 ] The emissions unit is undergoing PSD review as part of this application, or has undergone PSD review previously, for particulate matter or sulfur dioxide. Final determination is that emissions unit consumes increment.
- [ 2 ] The facility addressed in this application is classified as an EPA major source pursuant to paragraph (c) of the definition of "major source of air pollution" in Chapter 17-213, F.A.C., and the emissions unit addressed in this section commenced (or will commence) construction after January 6, 1975. Preliminary determination is that baseline emissions are zero, and emissions unit consumes increment.
- [ 3 ] The facility addressed in this application is classified as an EPA major source, and the emissions unit began initial operation after January 6, 1975, but before December 27, 1977. Preliminary determination is that baseline emissions are zero, and emissions unit consumes increment.
- [ 4 ] For any facility, the emissions unit began (or will begin) initial operation after December 27, 1977. Preliminary determination is that baseline emissions are zero, and emissions unit consumes increment.
- [ 5 ] None of the above apply. If so, the baseline emissions of the emissions unit are nonzero. In such case, additional analysis, beyond the scope of this application, is needed to determine whether changes in emissions have occurred (or will occur) after the baseline date that may consume or expand increment.

2. Increment Consuming for Nitrogen Dioxide?

If the emissions unit addressed in this section emits nitrogen oxides, answer the following series of questions to make a preliminary determination as to whether or not the emissions unit consumes PSD increment for nitrogen dioxide. Check first statement, if any, that applies and skip remaining statements.

Select (1-5) : 5

- [ 1 ] The emissions unit addressed in this section is undergoing PSD review as part of this application, or has undergone PSD review previously, for nitrogen dioxide. Final determination is that emissions unit consumes increment.
- [ 2 ] The facility addressed in this application is classified as an EPA major source pursuant to paragraph (c) of the definition of "major source of air pollution" in Chapter 17-213, F.A.C., and the emissions unit addressed in this section commenced (or will commence) construction after February 8, 1988. Preliminary determination is that baseline emissions are zero, and emissions unit consumes increment.
- [ 3 ] The facility addressed in this application is classified as an EPA major source, and the emissions unit began initial operation after February 8, 1988, but before March 28, 1988. Preliminary determination is that baseline emissions are zero, and emissions unit consumes increment.
- [ 4 ] For any facility, the emissions unit began (or will begin) initial operation after March 28, 1988. Preliminary determination is that baseline emissions are zero, and emissions unit consumes increment.
- [ 5 ] None of the above apply. If so, the baseline emissions of the emissions unit are nonzero. In such case, additional analysis, beyond the scope of this application, is needed to determine whether changes in emissions have occurred (or will occur) after the baseline date that may consume or expand increment.

3. Increment Consuming/Expanding Code: (C, E, U- unkown):		
PM	U	
SO2	U	
NO2	U	
4. Baseline Emissions:		
PM	lbs/hr	tons/yr
SO2	lbs/hr	tons/yr
NO2	tons/yr	

5. PSD Comment (limit to 200 characters):  
Sanford Unit 4 was constructed in 1972 which pre-dates the major source PSD baseline date of 1/5/75.

**L. EMISSIONS UNIT SUPPLEMENTAL INFORMATION  
(Regulated Emissions Units Only)**

Information for Facility-ID : 1 Emission Unit # : 2

**Supplemental Requirements for All Applications**

1. Process Flow Diagram : PSNU2_1.bmp Attached Document ID / Not Applicable / Waiver Requested
2. Fuel Analysis or Specification: PSNU2_2.txt Attached Document ID / Not Applicable / Waiver Requested
3. Detailed Description of Control Equipment : PSNU2_3.txt Attached Document ID / Not Applicable / Waiver Requested
4. Description of Stack Sampling Facilities : PSNU2_4.bmp Attached Document ID / Not Applicable / Waiver Requested
5. Compliance Test Report : Previously submitted date: 8/8/94 Attached Document ID / Previously submitted, Date / Not Applicable
6. Procedures for Startup and Shutdown : PSNU2_6.txt Attached Document ID / Not Applicable
7. Operation and Maintenance Plan : NA Attached Document ID / Not Applicable
8. Supplemental Information for Construction Permit Application : NA Attached Document ID / Not Applicable
9. Other Information Required by Rule or Statute : NA Attached Document ID / Not Applicable

**Additional Supplemental Requirements for Category I Applications Only**

10. Alternative Methods of Operation : PSNU2_10.txt Attached Document ID / Not Applicable
11. Alternative Modes of Operation (Emissions Trading) : NA Attached Document ID / Not Applicable
12. Identification of Additional Applicable Requirements : NA Attached Document ID / Not Applicable
13. Enhanced Monitoring Plan : NA Attached Document ID / Not Applicable
14. Acid Rain Permit Application  Acid Rain Application - Phase II (Form No. 17-210.900(1)(a)) Attached Document ID: Not Applicable  Repowering Extension Plan (Form No. 17-210.900(1)(b)) Attached Document ID: NA  New Unit Exemption (Form No. 17-210.900(1)(c)) Attached Document ID: NA  Retired Unit Exemption (Form No. 17-210.900(1)(c)) Attached Document ID: NA  Not Applicable

WALKDOWN INFORMATION	AS-BUILT INFORMATION	ORG	BY	DATE
	TECHNICAL ACCEPTANCE	ENGINEERING ORGANIZATION	ORG	BY

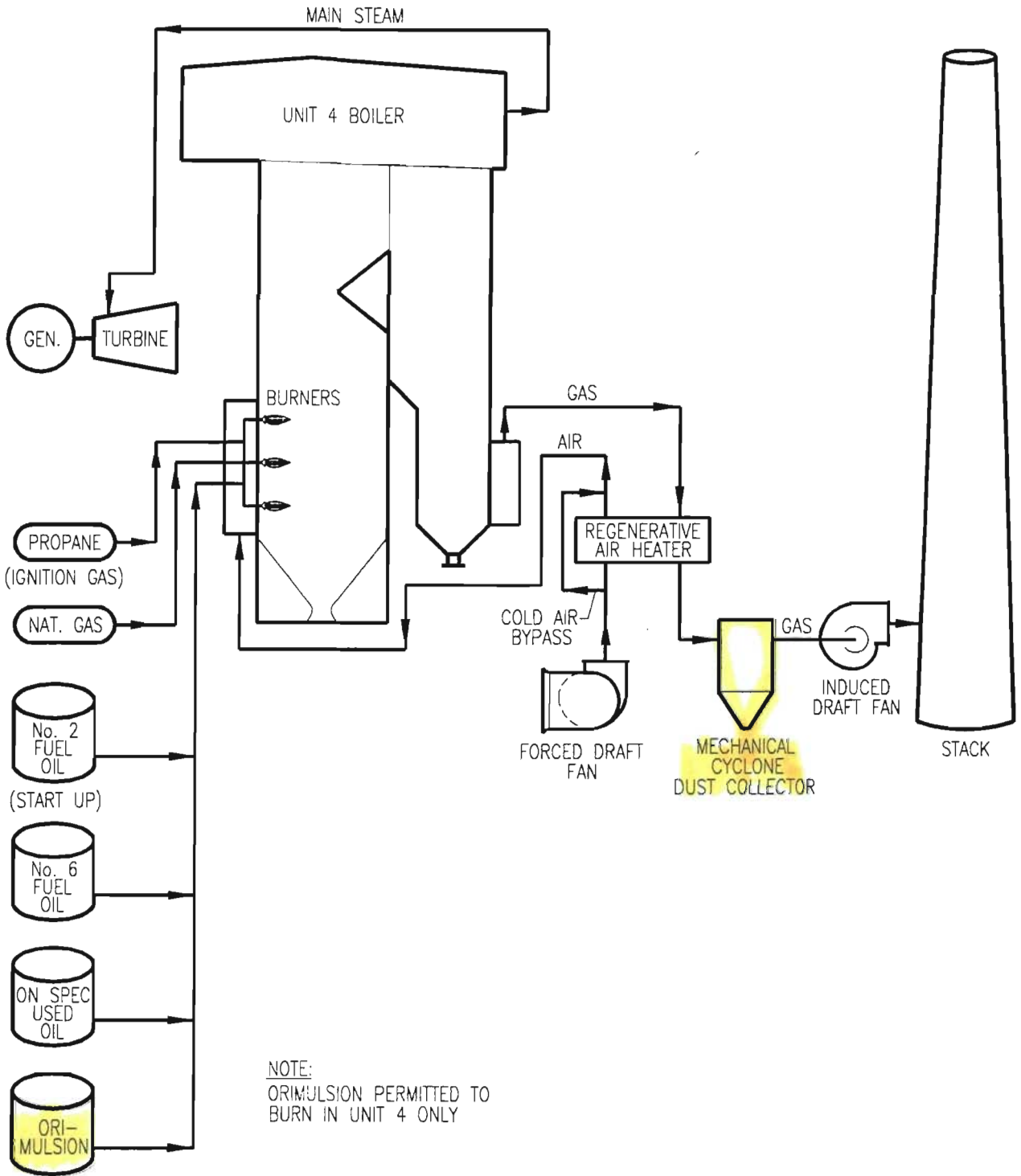

NOTE:  
ORIMULSION PERMITTED TO  
BURN IN UNIT 4 ONLY

PERMITTED FUEL OPTIONS

BAR CODE

0	7/17/95	ISSUED FOR TITLE V PERMIT	FWB	PWB	CSP	CSP	ETS
REV	DATE	REVISION DESCRIPTION	BY	CH	COR	APR	ORG

	SYSTEM	YY	DISCIPLINE	M	PLANT/UNIT	SANFORD PLANT		
	SCALE	N/A	CAD FILE NAME	SN004410	TITLE	EMISSION UNIT PROCESS FLOW DIAGRAM STEAM GENERATOR/BOILER ATTACHMENT NO. EU2		
	DRAWING SIZE	A (8.5X11)	FPL ARCHIVE NAME	SN004410				
DRAWING NUMBER					PSN3-M0104-YY			
					SHEET	1 OF 1	REV	0

Fuel Analysis  
Natural Gas Analysis (typical)<sup>2</sup>

<u>Parameter</u>	<u>Typical value</u>	<u>Max value</u>
Specific gravity(@ 60° F)	0.887	none
Heat content (Btu/cu ft)	950 - 1124	none
% sulfur (grains/CCF)	0.43 <sup>1</sup>	1.00
% nitrogen (by volume)	0.8	none
% ash	negligible	none

\*Note: The values listed are "typical" values based upon information supplied to FPL by Florida Gas Transmission (FGT). However, analytical results from grab samples of fuel taken at any given point in time may vary from those listed.

(1) Data from laboratory analysis

(2) The values are "typical" based upon the following:

- Information gathered by FPL through laboratory analysis, and
- FPL's fuel purchasing specifications. It should be noted that the analytical results obtained from grab samples taken at any given time may vary from those listed.



## Attachment PSNU2\_2.txt

Fuel Analysis  
No.6 Oil Analysis (typical)<sup>4</sup>

<u>Parameter</u>	<u>Typical value</u>	<u>Specifications</u>
API gravity (@ 60° F)	8 - 12	10.1 min <sup>1</sup>
Heat content(MBtu/bbl)	6,310 - 6420	6,340 <sup>1</sup>
% Sulfur	2.0 <sup>5</sup>	2.5 max <sup>3</sup>
% Nitrogen	0.2 - 0.5 <sup>2</sup>	none
% Ash	0.06 - 0.09 <sup>2</sup>	0.10 max <sup>1</sup>

Footnotes:

(1) Data taken from FPL fuel specifications.

(2) Data taken from laboratory analysis.

(3) Maximum permitted from current air operation permit.

(4) The values are "typical" based upon the following:

- Information gathered by FPL through laboratory analysis,
- FPL's fuel purchasing specifications. It should be noted that the analytical results obtained from grab samples taken at any given time may vary from those listed.

(5) Sulfur content values typically range between 1.6% and 2.4% and are derived from as-fired laboratory analysis of fuel oil fired at Sanford Power Plant.

## Attachment PSNU2\_2.txt

**Fuel Analysis**  
**No. 2 Distillate oil (typical)<sup>3</sup>**

<u>Parameter</u>	<u>Typical value</u>	<u>Specifications</u>
API gravity (@ 60 F)	35.0 <sup>2</sup>	30 - 40 <sup>1</sup>
Heat content (MBtu/bbl)	5,700 - 5,800 <sup>2</sup>	none
% sulfur	0.3 - 0.5 <sup>1</sup>	0.5 maximum <sup>1</sup>
% nitrogen	no specification	none
% ash	<0.01 <sup>2</sup>	0.01 <sup>1</sup>

Footnotes:

(1) Data taken from FPL fuel specifications.

(2) Data taken from laboratory analysis.

(3) The values are "typical" based upon the following:

- Information gathered by FPL through laboratory analysis, and
- FPL's fuel purchasing specifications. It should be noted that the analytical results obtained from grab samples taken at any given time may vary from those listed.

## Attachment PSNU2\_2.txt

Fuel Analysis  
Propane (typical)<sup>1</sup>

Emission unit #1 may occasionally light off (start up) on propane fuel, then switch to another fuel, such as No.6 residual oil. The propane fuel is supplied by a commercial vendor and is stored in small tanks located at the bottom of the boiler area. The chemical formula for propane is C<sub>3</sub>H<sub>8</sub>

*much lower than Nat gas*

<u>Parameter</u>	<u>Typical value</u>	<u>Specifications</u>
Specific gravity (@ 60 F)	0.51 <sup>1</sup>	none
Heat content (MBtu/bbl)	600 - 1,000	none
% sulfur	0.0031	none
% nitrogen	no specification	none
% ash	no specification	none

Footnotes:

- (1) The values are "typical" based upon the following:
- Information gathered by FPL through laboratory analysis, and
  - FPL's fuel purchasing specifications. It should be noted that the analytical results obtained from grab samples taken at any given time may vary from those listed.

## Attachment PSNU2\_2.txt

Fuel Analysis  
On Specification Used Oil

The boiler may occasionally burn used oil during normal operation. All used oil fired in the unit meets the specifications mandated by 40 CFR 279.11. Used oil fired by this boiler is typically derived from plant maintenance activities, and may include used lube oils, transformer oils, etc. that meet the analytical specifications. Criteria used oil values follow:

<u>Parameter</u>	<u>Typical value</u>	<u>Specifications</u>
API gravity (@ 60 F)	30.0 <sup>1</sup>	none
Heat content (MBtu/bbl)	6,000 <sup>1</sup>	none
% sulfur	0.3 <sup>1</sup>	none
% nitrogen	negligible	none
% ash	0.01 <sup>1</sup>	0.01

Footnotes:

(1) The values are "typical" based upon the following:

- Information gathered by FPL through laboratory analysis, and
- FPL's fuel purchasing specifications. It should be noted that the analytical results obtained from grab samples taken at any given time may vary from those listed.

## Attachment PSNU2\_2.txt

Fuel Analysis  
Orimulsion

The following is confidential information:

<u>Parameter</u>	<u>Typical value</u>	<u>Specifications</u>
API gravity (@ 60 F)	NA	NA
Heat content (MBtu/bbl)	4,513	4,406
% sulfur	NA	NA
% nitrogen	NA	NA
% ash	0.2	0.25

**Attachment PSNU2\_3.txt**  
**Detailed Description of Control Equipment**

**A. Cyclone Separator** - This steam generator (boiler) is supplied with two 104B-GHS #19-684 UOP tubular mechanical dust collectors with side inlet and universal outlet. Each dust collector consists of 695 tubes and four dust collection hoppers. The dust collector has the following efficiency at 2.55 inches of water @ peak load:

<u>Particle Range</u> <u>(micron)</u>	<u>Mean Diameter</u> <u>(micron)</u>	<u>Estimated Efficiency</u> <u>(percent)</u>
0 - 5	2.5	30.3
5 - 10	7.5	66.2
10 - 20	15	88.6
20 - 45	32.5	99.1
45 +	45	99.5

**FLORIDA POWER & LIGHT CO.  
STACK SAMPLING FACILITIES  
SANFORD SITE**

**FOSSIL FUEL STEAM GENERATOR  
UNITS 4 & 5**

**STACK DIAGRAM**

**STACK SPECIFICATIONS**

SAMPLING DIAMETER: 256.8 in.  
 SAMPLING AREA: 359.7 sq. ft.  
 SAMPLING PORT DEPTH: 60.0 in.  
 No. OF PORTS: 4

NOTE: DRAWING IS NOT TO SCALE

**PROBE DIAGRAM  
(Method 17 - Particulate Test)**

No. OF POINTS PER TRAVERSE: 6  
 TOTAL No. OF POINTS : 24  
 SAMPLING TIME PER POINT: 2.5 min.  
 TOTAL SAMPLING TIME: 60.0 min.

**PROBE DIAGRAM**

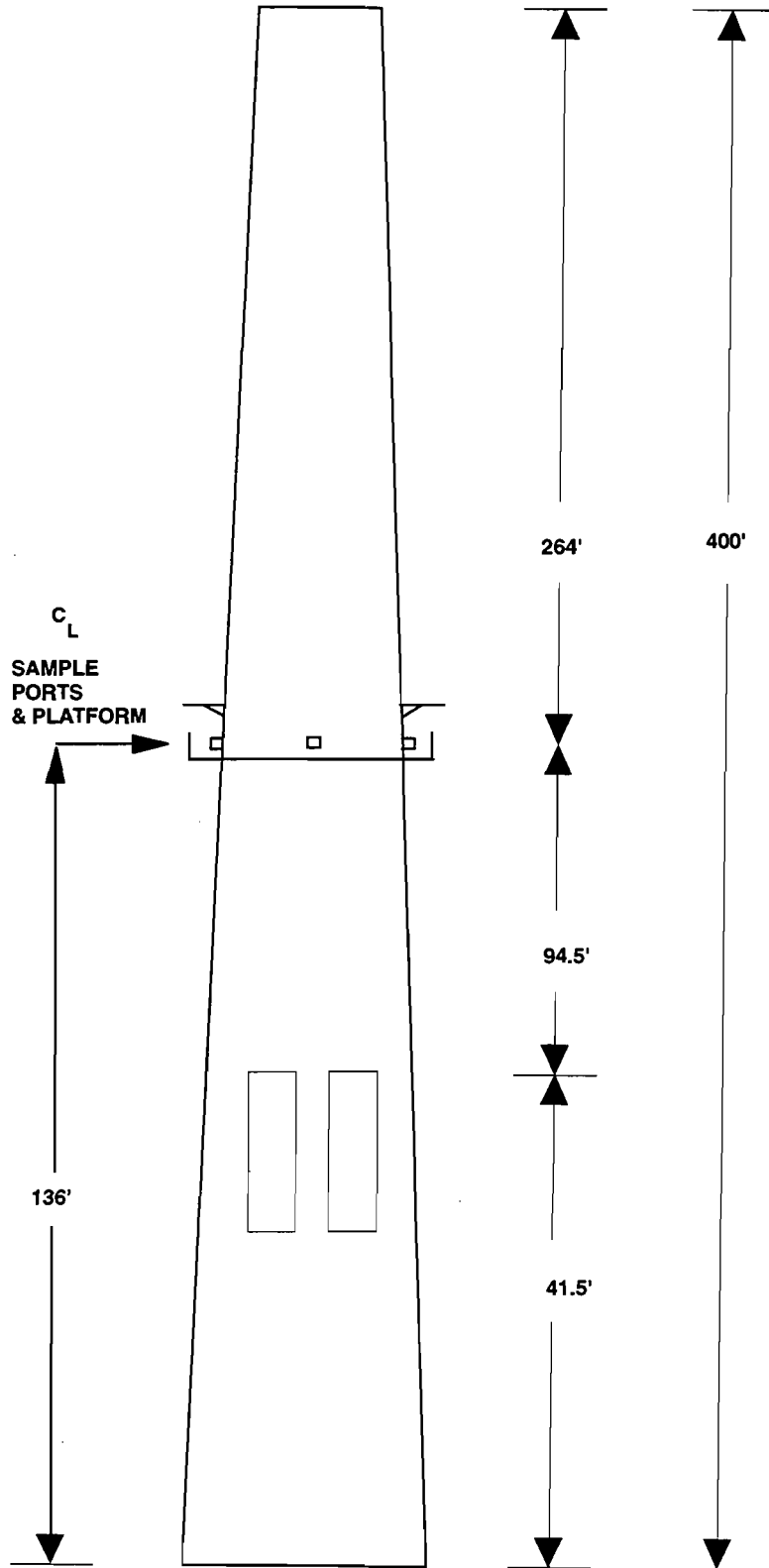
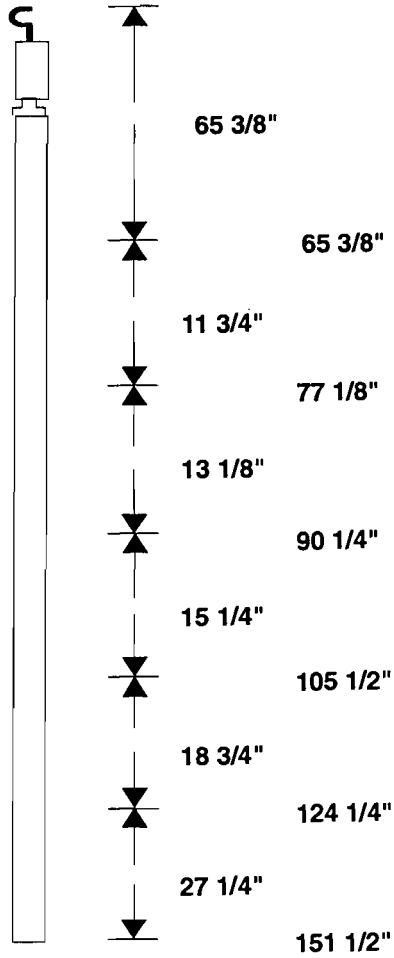

Access to the sampling ports is provided by a ladder. Channel iron with a trolley system is above each port for probe support. AC power is available at the base of the stack.

## Attachment PSNU2\_6.txt

### Startup & Shutdown Procedures - Minimizing Excess Emissions

Startup of the fossil-fuel boiler begins when fuel (either natural gas or oil) is introduced into one or more burners within the boiler and lighted (commencement of combustion). Startup is complete and steady-state operation begins when the combustion process has stabilized and the megawatt load on the unit is stable.

Shutdown of the fossil-fuel boilers begins when unit megawatt load is decreased to below 10% of maximum and continues until the final burner gun is removed from service and the final Induced-draft or Forced-draft fan is removed from service.

Excess emissions may be detected during all modes of boiler operation by any one of several continuous emissions monitors. Continuous emission monitors are currently in place for NO<sub>x</sub>, SO<sub>2</sub> and opacity. An audible and visual alarm are activated whenever permitted values for any of the above parameters are approached.

Countermeasures which may be taken in the event of excess emissions include, but are not limited to:

- proper excess air adjustments
- recognizing and removal of faulty burners
- fuel oil temperature adjustments
- proper and timely operation of boiler cleaning devices
- removal of the unit from system-dispatch mode
- reduction of unit megawatt load
- stopping and restarting of boiler cleaning devices
- lowering load rate
- pressure rate changes

Best Operational Practices to prevent excess emissions, and knowledge of the appropriate countermeasures to take if an excess emissions condition exists, are taught during routine operator training. Control Center Operators and the Plant Foremen who operate the fossil fuel-fired boilers receive this training. In addition, plant operations and supervisory staff are periodically given Air Regulation Awareness Training by the FPL Environmental Affairs Department. Topics include current permit limits, maximum allowable duration of authorized excess emissions, appropriate countermeasures for excess emissions, duty to notify, etc.



PSNU2\_10.txt  
Alternative Methods of Operation

Operation at Various Capacities and Heat Input Rates

The Sanford Unit 4 boiler may be operated up to 8760 hours per year at heat input rates from zero to 4050 MMBtu per hour on No.#6 oil, from zero to 4230 MMBtu per hour on natural gas and from zero to 4050 when co-firing Orimulsion. When a blend of fuel oil and natural gas are burned, the heat input is prorated based upon the percent heat input of each fuel.

Different Fuel Types

The unit may be fired with a variable combination of No. 6 residual fuel oil, natural gas, orimulsion or No. 2 fuel oil. The unit may occasionally utilize propane fuel to light off (start up) the boiler, then switch to another fuel, such as No.6 residual oil. The unit may also burn on-specification used oil meeting EPA specifications under 40 CFR 279.11. The quantity of on-specification used oil shall not exceed 2,442,972 gallons per year for Unit 4.

Current emissions limitations are as follows:

<u>Pollutant</u>	<u>Emission Limit</u>
Particulate matter-steady state	0.1 lb/MMBtu
Particulate matter-soot blowing	0.3 lb/MMBtu
Sulfur dioxide	2.75 lb/MMBtu

Oil and Gas Co-firing

This emission unit may co-fire natural gas with residual oil. When combusting both fuels simultaneously, the percentage of natural gas will be adjusted to ensure that the applicable SO<sub>2</sub> emission limit and visible emission limits are complied with.

Orimulsion Cofiring

Orimulsion may be cofired with natural gas, or with natural gas and residual oil. When cofired with natural gas only, the maximum currently permitted portion of orimulsion is 41.2%. When cofired with both natural gas and #6 residual oil, the maximum permitted portion is 20.6% orimulsion and 50% fuel oil.

Soot blowing

The unit may blow soot for up to 24 hours per day, so long as excess emissions are limited to 60% opacity for 3 hours in 24 hours with four 6-minute periods of up to 100% opacity.

Utilization of Additives

Additives such as Magnesium hydroxide Mg(OH)<sub>2</sub> are added to the boiler periodically at various loads. When magnesium hydroxide is used, it is injected into the boiler via the I.K. soot blower lances and through manual hand lances on a batch basis, rather than continuously. The dosage rate is based on the quantity of fuel burned and the amount of ash in the fuel. FPL reserves the right to use other additives if they are suitable.

**Attachment PSNU2\_10.txt**  
**Alternative Methods of Operation**

Evaporation of Spent Boiler Chemical Cleaning Chemicals

On a periodic basis, as part of routine maintenance, the inside of the steam generator tubes (boiler tubes) at Sanford Unit 4 are cleaned using a series of chemical solutions that remove deposited scale which adversely affects the efficiency and reliability of the generating units.

The solutions and rinsewaters are collected in large mobile tanks ("frac tanks") pursuant to guidance issued by the Department. Upon completion of the cleaning process and prior to disposal of the spent cleaning solution and rinses, representative sampling of the liquids collected in the "frac tanks" is conducted as per 40 CFR 261, Appendix I, to determine the hazardous waste status of the accumulated wastewater, using Toxicity Characteristic Leaching Procedure (TCLP) analysis.

If the wastewater is determined to be hazardous, it will be managed as such in accordance with 40 CFR 262.34, 40 CFR 265 Subpart I, and 40 CFR 268 with respect to generators accumulating and treating waste in containers and tanks. An appropriate waste analysis plan will be developed to determine and document the pre- and post-treatment characteristics of the wastewater. Hazardous waste may also be transported to an approved hazardous waste facility for the appropriate disposal.

If the spent cleaning solution and rinses are determined to be non-hazardous, they are then disposed by evaporation in the units boiler. Introduction into the boiler will occur at a rate that will not cause an exceedence of the opacity limit of the unit in which evaporation is occurring (in this case, 40 percent opacity).

## Attachment PSNU2\_12.txt

### Identification of Additional Applicable Requirements

Applicable Requirements as defined in Rule 62-210.200(29) not identified in Section D of this emission unit section are included in this attachment of the application. Any air operation permit issued by the Department (or local program designee) and included in this attachment is provided for information purposes. The specific conditions of the operating permit are not Applicable Requirements as defined in Rule 62-210.200(29) unless implementing a specific Applicable Requirement of the Department's rules (e.g. emission limitations and consent orders).

Air operation permit No. AO64-217877 contains the following conditions:

1. Heat input rate for Unit 4 is not to exceed 4,050 mmBtu/hour when firing No. 6 residual fuel oil or when co-firing Orimulsion and 4,230 mmBtu/hour when firing natural gas. *FPL tracks heat input on a continuous basis using fuel sampling and analysis and fuel flow measurement.*
2. The boiler shall be fired with a variable combination of No. 6 residual fuel oil, natural gas, No. 2 fuel oil, propane gas or on-specification used oil from FPL operations. The quantity of on-specification used oil to be fired shall not exceed 2,442,972 gallons/year. *FPL tracks the fuel usage on a continuous basis.*
3. Orimulsion may be co-fired with natural gas, or with natural gas and No. 6 residual fuel oil. When Orimulsion is co-fired with natural gas, the maximum permitted portion of Orimulsion is 41.2 percent. When Orimulsion is co-fired with natural gas and fuel oil, the maximum permitted portion is 20.6 percent Orimulsion and 50 percent fuel oil. Percentages are expressed as heat input.
4. The maximum allowable emissions for Unit 4 are as follows:

Pollutant	Fuel	Emission Limit	Test Method
<u>Particulate Matter - Steady-State</u>	Oil	0.1 lb/mmBtu	EPA Method 5 or 17 EPA Method 5 or 17
	Orimulsion Co-Firing	0.1 lb/mmBtu	
Soot Blowing or Load Changing	Oil	0.3 lb/mmBtu (3 hrs/24 hrs)	EPA Method 5 or 17 EPA Method 5 or 17
	Orimulsion Co-Firing	0.3 lb/mmBtu (3 hrs/24 hrs)	
<u>Sulfur Dioxide -</u>	Oil	2.75 lb/mmBtu	Monthly Fuel Analysis  Continuous Emissions Monitor (CEMS) - 3 hour average
	Orimulsion Co-Firing	1.6 lb/mmBtu	
<u>Visible Emissions - Steady-State</u>	Oil	40 percent opacity	DEP Method 9 COM
	Orimulsion Co-Firing	35 percent opacity	
Soot Blowing or Load Changing	Oil	60 percent opacity (3 hrs/24 hrs)	DEP Method 9 COM
	Orimulsion Co-Firing	60 percent opacity (3 hrs/24 hrs)	

*FPL conducts annual compliance testing to determine compliance with permitted emission limitations with the exceptions noted above when Orimulsion is co-fired, in which case continuous emissions monitors for sulfur dioxide and opacity (COM) are required under the air operation permit for compliance determination.*

**III. EMISSIONS UNIT INFORMATION**

Information for Facility - ID : 1 Emission Unit # : 3

A separate Emissions Unit Information Section (including subsections A through L as required) must be completed for each emissions unit addressed in this Application for Air Permit. If submitting the application form in hard copy, indicate, in the space provided at the top of each page, the number of this Emissions Unit Information Section and the total number of Emissions Unit Information Sections submitted as part of this application. Some of the subsections comprising the Emissions Unit Information Section of the form are intended for regulated emissions units only. Others are intended for both regulated and unregulated emissions units. Each subsection is appropriately marked.

**A. TYPE OF EMISSIONS UNIT  
(Regulated and Unregulated Emissions Units)****Type of Emissions Unit Addressed in This Section**

1. Regulated or Unregulated Emissions Units? Check one:

- [ X ] The emissions unit addressed in this Emissions Unit Information Section is a regulated emissions unit.
- [ ] The emissions unit addressed in this Emissions Unit Information Section is a unregulated emissions unit.

2. Single Process, Group Processes, or Fugitive Only?

Enter The Number (1-3): 1

- [ 1 ] This Emissions Unit Information Section addresses, as a single emissions unit, a single process or production unit, or activity, which produces one or more air pollutants and which has at least one definable emission point (stack or vent).
- [ 2 ] This Emissions Unit Information Section addresses, as a single emissions unit, a group of process or production units and activities which has at least one definable emission point(stack or vent) but may also produce fugitive emissions.
- [ 3 ] This Emissions Unit Information Section addresses, as a single emissions unit, one or more process or production units and activities which produce fugitive emissions only.

**B. GENERAL EMISSIONS UNIT INFORMATION  
(Regulated and Unregulated Emissions Units)**

**Emissions Unit Description and Status**

1. Description of Emissions Unit Addressed in This Section (limit to 60 characters): Unit 5 Fossil fuel steam generator
2. Emissions Unit Identification Number: 003 (No Corresponding ID or Unknown)
3. Emission Unit Status Code: (A or C) : A
4. Acid Rain Unit? (Y/N): Y
5. Emissions Unit Major Group SIC Code: 49
6. Emissions Unit Comment (limit to 500 characters): Fly ash reinjection is part of the original design of the multicyclone separator, but has not been used for many years. Generator nameplate rating is from the 10-year Site Plan that FPL provides yearly to the Florida PSC. Actual generator output may exceed the value given, or may vary with changes in unit efficiency, or due to fluctuations in system load demand.  Method of compliance for determining the heat input rate is fuel sampling and analysis in conjunction with fuel flow measurement.

**Emissions Unit Control Equipment**

**A. Control Equipment # : 1**

1. Description (limit to 200 characters): Multiple Cyclone w/Fly Ash Reinjection
2. Control Device or Method Code: Multiple Cyclone w/Fly Ash Reinjection

**B. Control Equipment # :**

1. Description (limit to 200 characters):
2. Control Device or Method Code:

**C. Control Equipment # :**

1. Description (limit to 200 characters):
2. Control Device or Method Code:

**C. EMISSIONS UNIT DETAIL INFORMATION  
(Regulated Emissions Units)**

**Emissions Unit Details**

1. Initial Startup Date (DD-MON-YYYY): 06/16/73
2. Long-term Reserve Shutdown Date (DD-MON-YYYY):
3. Package Unit: Manufacturer: Foster-Wheeler <span style="float:right">Model Number: NA</span>
4. Generator Nameplate Rating: 436 MW
5. Incinerator Information: Dwell Temperature: °F Dwell Time: seconds Incinerator Afterburner Temperature: °F

**Emissions Unit Operating Capacity**

1. Maximum Heat Input Rate: 4230 mmBtu/hr
2. Maximum Incineration Rate: lbs/hr tons/day
3. Maximum Process or Throughput Rate: Units:
4. Maximum Production Rate: Units:
5. Operating Capacity Comment (limit to 200 characters): Heat input rate in item 1 is for natural gas fuel. The maximum permitted heat input rate for oil firing is 4050 mmBtu/hour. The compliance method for heat input rate is fuel sampling and analysis.

**Emissions Unit Operating Schedule**

Requested Maximum Operating Schedule: hours/day                      days/week weeks/yr                      8760 hours/yr
----------------------------------------------------------------------------------------------------------------------------------

**D. EMISSIONS UNIT REGULATIONS  
(Regulated Emissions Units Only)**

**Rule Applicability Analysis** (Required for Category II applications and Category III applications involving non Title-V sources. See Instructions.)

Not Applicable



**List of Applicable Regulations** (Required for Category I applications and Category III applications involving Title-V sources. See Instructions.)

Emissions Unit ID 3

<p>40 C.F.R. 279.72                  40 C.F.R. 72.20(a)                  40 C.F.R. 72.20(b)                  40 C.F.R. 72.20(c)                  40 C.F.R. 72.21(a)                  40 C.F.R. 72.21(b)                  40 C.F.R. 72.21(d)                  40 C.F.R. 72.22(a)                  40 C.F.R. 72.22(c)                  40 C.F.R. 72.23                  40 C.F.R. 72.24(a)                  40 C.F.R. 72.30(a)                  40 C.F.R. 72.30(b)(2)                  40 C.F.R. 72.30(c)                  40 C.F.R. 72.30(d)                  40 C.F.R. 72.32                  40 C.F.R. 72.33(b)                  40 C.F.R. 72.33(c)                  40 C.F.R. 72.33(d)                  40 C.F.R. 72.40(a)                  40 C.F.R. 72.40(b)                  40 C.F.R. 72.40(c)                  40 C.F.R. 72.40(d)                  40 C.F.R. 72.51                  40 C.F.R. 72.90                  40 C.F.R. 72.9(a)(1)(iii)                  40 C.F.R. 72.9(a)(1)(i)                  40 C.F.R. 72.9(a)(2)                  40 C.F.R. 72.9(b)                  40 C.F.R. 72.9(c)(1)(iii)                  40 C.F.R. 72.9(c)(2)                  40 C.F.R. 72.9(c)(4)                  40 C.F.R. 72.9(c)(5)                  40 C.F.R. 72.9(d)                  40 C.F.R. 72.9(e)                  40 C.F.R. 72.9(f)                  40 C.F.R. 72.9(g)(4)                  40 C.F.R. 73.33                  40 C.F.R. 73.35                  40 C.F.R. 75 Appendix A-1                  40 C.F.R. 75 Appendix A-2                  40 C.F.R. 75 Appendix A-3                  40 C.F.R. 75 Appendix A-4                  40 C.F.R. 75 Appendix A-5                  40 C.F.R. 75 Appendix A-6</p>	<p>40 C.F.R. 75 Appendix B                  40 C.F.R. 75 Appendix C-1                  40 C.F.R. 75 Appendix C-2                  40 C.F.R. 75 Appendix D                  40 C.F.R. 75 Appendix F                  40 C.F.R. 75 Appendix G-2                  40 C.F.R. 75 Appendix G-4                  40 C.F.R. 75 Appendix H                  40 C.F.R. 75.10(a)(1)                  40 C.F.R. 75.10(a)(2)                  40 C.F.R. 75.10(a)(3)(i)                  40 C.F.R. 75.10(a)(4)                  40 C.F.R. 75.10(b)                  40 C.F.R. 75.10(c)                  40 C.F.R. 75.10(d)                  40 C.F.R. 75.10(f)                  40 C.F.R. 75.10(g)                  40 C.F.R. 75.11(b)(1)                  40 C.F.R. 75.11(c)(3)                  40 C.F.R. 75.11(d)                  40 C.F.R. 75.12(a)                  40 C.F.R. 75.12(b)                  40 C.F.R. 75.13(a)                  40 C.F.R. 75.13(b)                  40 C.F.R. 75.14(a)                  40 C.F.R. 75.20(a)(5)                  40 C.F.R. 75.20(b)                  40 C.F.R. 75.20(c)                  40 C.F.R. 75.20(d)                  40 C.F.R. 75.20(f)                  40 C.F.R. 75.20(g)                  40 C.F.R. 75.21(a)                  40 C.F.R. 75.21(b)                  40 C.F.R. 75.21(c)                  40 C.F.R. 75.21(d)                  40 C.F.R. 75.21(e)                  40 C.F.R. 75.21(f)                  40 C.F.R. 75.22                  40 C.F.R. 75.24                  40 C.F.R. 75.30(a)(1)                  40 C.F.R. 75.30(a)(2)                  40 C.F.R. 75.30(a)(3)                  40 C.F.R. 75.31                  40 C.F.R. 75.32                  40 C.F.R. 75.33</p>	<p>40 C.F.R. 75.35                  40 C.F.R. 75.36                  40 C.F.R. 75.4(a)(4)(ii)                  40 C.F.R. 75.5                  40 C.F.R. 75.51(c)                  40 C.F.R. 75.53(a)                  40 C.F.R. 75.53(b)                  40 C.F.R. 75.53(c)                  40 C.F.R. 75.53(d)(1)                  40 C.F.R. 75.54                  40 C.F.R. 75.55(c)                  40 C.F.R. 75.55(e)                  40 C.F.R. 75.56                  40 C.F.R. 75.60(a)                  40 C.F.R. 75.60(b)                  40 C.F.R. 75.60(c)(3)                  40 C.F.R. 75.61(a)(1)                  40 C.F.R. 75.61(a)(5)                  40 C.F.R. 75.61(b)                  40 C.F.R. 75.62                  40 C.F.R. 75.63                  40 C.F.R. 75.64(a)                  40 C.F.R. 75.64(b)                  40 C.F.R. 75.64(c)                  40 C.F.R. 75.64(d)                  40 C.F.R. 75.65                  40 C.F.R. 75.66(a)                  40 C.F.R. 75.66(b)                  40 C.F.R. 75.66(c)                  40 C.F.R. 75.66(d)                  40 C.F.R. 75.66(g)                  40 C.F.R. 75.66(h)                  40 C.F.R. 76.13                  40 C.F.R. 77.3                  40 C.F.R. 77.5(b)                  40 C.F.R. 77.6                  F.A.C. 62-204.800(12)                  (state only)                  F.A.C. 62-204.800(13)                  (state only)                  F.A.C. 62-204.800(14)                  (state only)                  F.A.C. 62-210.650                  F.A.C. 62-210.700 (1)                  F.A.C. 62-210.700 (2)                  F.A.C. 62-210.700 (3)                  F.A.C. 62-210.700 (4)                  F.A.C. 62-210.700 (6)</p>	<p>F.A.C. 62-214.300                  F.A.C. 62-214.330                  F.A.C. 62-214.350 (2)                  F.A.C. 62-214.350 (3)                  F.A.C. 62-214.350 (5)                  F.A.C. 62-214.350 (6)                  F.A.C. 62-214.370 (1)                  F.A.C. 62-214.370 (3)                  F.A.C. 62-214.370 (4)                  F.A.C. 62-214.370 (7)                  F.A.C. 62-214.430                  F.A.C. 62-296.405(1)(a)                  paragraph 2                  F.A.C. 62-296.405(1)(b)                  F.A.C. 62-296.405(1)(c)1.j.                  F.A.C. 62-296.405(1)(e)(1)                  F.A.C. 62-296.405(1)(e)(2)                  F.A.C. 62-296.405(1)(e)(3)                  F.A.C.                  62-296.405(1)(f)1.a.(i)                  F.A.C. 62-296.405(1)(f)1.b.                  F.A.C. 62-296.500(2)(a)1.                  F.A.C. 62-296.500(2)(c)                  F.A.C. 62-297.310(1)                  F.A.C. 62-297.310(2)(b)                  F.A.C. 62-297.310(3)                  F.A.C. 62-297.310(4)(a)1.                  F.A.C. 62-297.310(4)(a)2.c.                  F.A.C. 62-297.310(4)(b)                  F.A.C. 62-297.310(4)(c)                  F.A.C. 62-297.310(4)(d)                  F.A.C. 62-297.310(4)(e)                  F.A.C. 62-297.310(5)                  F.A.C. 62-297.310(6)(a)                  F.A.C. 62-297.310(6)(c)                  F.A.C. 62-297.310(6)(d)                  F.A.C. 62-297.310(6)(e)                  F.A.C. 62-297.310(6)(f)                  F.A.C. 62-297.310(6)(g)                  F.A.C. 62-297.310(7)(a)1.                  F.A.C. 62-297.310(7)(a)2.                  F.A.C. 62-297.310(7)(a)3.                  F.A.C. 62-297.310(7)(a)4.                  F.A.C. 62-297.310(7)(a)5.                  F.A.C. 62-297.310(7)(a)9.                  F.A.C. 62-297.310(7)(c)                  F.A.C. 62-297.310(8)                  Table 62-297.310-1</p>
-------------------------------------------------------------------------------------------------------------------------------------------------------------------------------------------------------------------------------------------------------------------------------------------------------------------------------------------------------------------------------------------------------------------------------------------------------------------------------------------------------------------------------------------------------------------------------------------------------------------------------------------------------------------------------------------------------------------------------------------------------------------------------------------------------------------------------------------------------------------------------------------------------------------------------------------------------------------------------------------------------------------------------------------------------------------------------------------------------------------------------------------------------------------------------------------------------------------------------------------------------------------------------------------------------------------------------------------------------------------------------------------------------------------------------------------------------------------------------------------------------------------------------------------------------------------------------------------------------------------------------------------------------------------------------------------------------------------------------------------------------------------------------------------------------------------------------------------------------------------------------------------------------------	-----------------------------------------------------------------------------------------------------------------------------------------------------------------------------------------------------------------------------------------------------------------------------------------------------------------------------------------------------------------------------------------------------------------------------------------------------------------------------------------------------------------------------------------------------------------------------------------------------------------------------------------------------------------------------------------------------------------------------------------------------------------------------------------------------------------------------------------------------------------------------------------------------------------------------------------------------------------------------------------------------------------------------------------------------------------------------------------------------------------------------------------------------------------------------------------------------------------------------------------------------------------------------------------------------------------------------------------------------------------------------------------------------------------------------------------------------------------------------------------------------------------------------------------------------------------------------------------------------------------------------------------------------------------------------------------------------------------------------------------------------------------------------------------------------------------------------------------------------------------------------------------------------------------------------	---------------------------------------------------------------------------------------------------------------------------------------------------------------------------------------------------------------------------------------------------------------------------------------------------------------------------------------------------------------------------------------------------------------------------------------------------------------------------------------------------------------------------------------------------------------------------------------------------------------------------------------------------------------------------------------------------------------------------------------------------------------------------------------------------------------------------------------------------------------------------------------------------------------------------------------------------------------------------------------------------------------------------------------------------------------------------------------------------------------------------------------------------------------------------------------------------------------------------------------------------------------------------------------------------------------------------------------------------------------------------------------------------------------------------------------------------------------------------------------------------------------------------------------------------------------------------------------------------------------------------------------------------------------------------------------------------------------------------------------------------------------------------------------------------------------------------------------------------------------------------------------------------------------------------------------------------------------------	----------------------------------------------------------------------------------------------------------------------------------------------------------------------------------------------------------------------------------------------------------------------------------------------------------------------------------------------------------------------------------------------------------------------------------------------------------------------------------------------------------------------------------------------------------------------------------------------------------------------------------------------------------------------------------------------------------------------------------------------------------------------------------------------------------------------------------------------------------------------------------------------------------------------------------------------------------------------------------------------------------------------------------------------------------------------------------------------------------------------------------------------------------------------------------------------------------------------------------------------------------------------------------------------------------------------------------------------------------------------------------------------------------------------------------------------------------------------------------------------------------------------------------------------------------------------------------------------------------------------------------------------------------------------------------------------------------------------------------------------------------------------------------------------------------------------------------------------------------------------------------------------------------------------------------------------------------------------------------------------------------------------------------------------------------------------------------------------------------------------------------------------------------------------------------------

**E. EMISSION POINT (STACK/VENT) INFORMATION  
(Regulated Emissions Units Only)**

**Emission Point Description and Type**

Information for Facility-ID 1 Emission Unit # :3

1. Identification of Point on Plot Plan or Flow Diagram: EU3-Boiler No. 5
2. Emission Point Type Code (1,2,3,4) : 1
3. Descriptions of Emissions Points Comprising this Emissions Unit (limit to 100 characters):
4. ID Numbers or Descriptions of Emission Units with this Emission Point in Common:
5. Discharge Type Code (D, F, H, P, R, V, W) : v
6. Stack Height: 400 ft
7. Exit Diameter: 19.17 ft
8. Exit Temperature: 308 °F
9. Actual Volumetric Flow Rate: 1434070.7 acfm
10. Percent Water Vapor: %
11. Maximum Dry Standard Flow Rate: dscfm
12. Nonstack Emission Point Height: ft
13. Emission Point UTM Coordinates: Zone: 17 East: 468.36 North: 3190.65
14. Emission Point Comment (limit to 200 characters): Information in items 8 and 9 above reflects the highest temperature and flow rate measured during the June 1994 particulate test for this unit. Flow rates measured at other times may vary.

**F. SEGMENT (PROCESS/FUEL) INFORMATION  
(Regulated and Unregulated Emissions Units)**

**Segment Description and Rate:**

Information for Facility\_ID : 1 Emission Unit #: 3 Segment #: 1

1. Segment Description (Process/Fuel Type and Associated Operating Method/Mode) (limit to 500 characters): Unit 5 Boiler burning natural gas fuel
2. Source Classification Code (SCC): 1-01-006-01
3. SCC Units: Million cubic feet burned
4. Maximum Hourly Rate: 4.029
5. Maximum Annual Rate: 35294
6. Estimated Annual Activity Factor:
7. Maximum Percent Sulfur: 0.0031
8. Maximum Percent Ash:
9. Million Btu per SCC Unit: 1050
10. Segment Comment (limit to 200 characters): The unit is currently permitted to burn a variable combination of No. 6 residual oil, natural gas, No. 2 fuel oil, propane gas, or on-specification used oil from FPL operations.

**F. SEGMENT (PROCESS/FUEL) INFORMATION  
(Regulated and Unregulated Emissions Units)**

**Segment Description and Rate:**

Information for Facility\_ID :/ Emission Unit #: 3 Segment #: 2

1. Segment Description (Process/Fuel Type and Associated Operating Method/Mode) (limit to 500 characters): Unit 5 Boiler burning No.6 residual oil
2. Source Classification Code (SCC): 1-01-004-01
3. SCC Units: thousand gallons burned
4. Maximum Hourly Rate: 26.64
5. Maximum Annual Rate: 233366.4
6. Estimated Annual Activity Factor:
7. Maximum Percent Sulfur: 2.5
8. Maximum Percent Ash:
9. Million Btu per SCC Unit: 152
10. Segment Comment (limit to 200 characters): The unit is currently permitted to burn a variable combination of No. 6 residual oil, natural gas, No. 2 fuel oil, propane gas, orimulsion, or on-specification used oil from FPL operations.

**F. SEGMENT (PROCESS/FUEL) INFORMATION  
(Regulated and Unregulated Emissions Units)**

**Segment Description and Rate:**

Information for Facility\_ID : 1 Emission Unit #: 3 Segment #: 3

1. Segment Description (Process/Fuel Type and Associated Operating Method/Mode) (limit to 500 characters): Unit 5 Boiler burning No.2 diesel oil
2. Source Classification Code (SCC): 1-01-005-01
3. SCC Units: Thousand gallons burned
4. Maximum Hourly Rate: 29.78
5. Maximum Annual Rate: 260873,000 GPY
6. Estimated Annual Activity Factor:
7. Maximum Percent Sulfur: 0.5
8. Maximum Percent Ash:
9. Million Btu per SCC Unit: 136
10. Segment Comment (limit to 200 characters): The unit is currently permitted to burn a variable combination of No. 6 residual oil, natural gas, No. 2 fuel oil, propane gas or on-specification used oil from FPL operations.

**F. SEGMENT (PROCESS/FUEL) INFORMATION  
(Regulated and Unregulated Emissions Units)**

**Segment Description and Rate:**

Information for Facility\_ID :1 Emission Unit #: 3 Segment #: 4

1. Segment Description (Process/Fuel Type and Associated Operating Method/Mode) (limit to 500 characters): Unit 5 Boiler burning propane
2. Source Classification Code (SCC): 1-01-006-01
3. SCC Units: Million cubic feet burned
4. Maximum Hourly Rate: 4.23
5. Maximum Annual Rate: 37055
6. Estimated Annual Activity Factor:
7. Maximum Percent Sulfur:
8. Maximum Percent Ash:
9. Million Btu per SCC Unit: 1000
10. Segment Comment (limit to 200 characters): Propane gas is used primarily for lighting off the boiler for start-up.

**F. SEGMENT (PROCESS/FUEL) INFORMATION  
(Regulated and Unregulated Emissions Units)**

**Segment Description and Rate:**

Information for Facility\_ID :1 Emission Unit #: 3 Segment #: 5

1. Segment Description (Process/Fuel Type and Associated Operating Method/Mode) (limit to 500 characters): Unit 5 Boiler burning on-specification used oil
2. Source Classification Code (SCC): 1-01-013-02
3. SCC Units: thousand gallons burned
4. Maximum Hourly Rate: 29.78
5. Maximum Annual Rate: 2442.972
6. Estimated Annual Activity Factor:
7. Maximum Percent Sulfur: 2.5
8. Maximum Percent Ash:
9. Million Btu per SCC Unit: 136
10. Segment Comment (limit to 200 characters): The quantity of on-specification used oil which may be burned in the Sanford boiler unit 5 is currently limited to 2,442,972 gallons per year under the existing FDEP permit.

**F. SEGMENT (PROCESS/FUEL) INFORMATION  
(Regulated and Unregulated Emissions Units)**

**Segment Description and Rate:**

Information for Facility\_ID : / Emission Unit #: / Segment #: 6

1. Segment Description (Process/Fuel Type and Associated Operating Method/Mode) (limit to 500 characters): Unit 5 co-firing all possible combinations of natural gas, residual oil, on specification used oil, #2 fuel oil, and propane.
2. Source Classification Code (SCC): 1-01-006-01
3. SCC Units: million cubic feet and thousand gallons
4. Maximum Hourly Rate:
5. Maximum Annual Rate:
6. Estimated Annual Activity Factor:
7. Maximum Percent Sulfur: 1
8. Maximum Percent Ash: 0.1
9. Million Btu per SCC Unit:
10. Segment Comment (limit to 200 characters): Air Operation Permit # AO-64-217877 allows Unit 5 to burn a mixture of the above fuels in a ratio that will result in a max. SO2 emission rate of 2.75 lbs/mmBtu.



**F. SEGMENT (PROCESS/FUEL) INFORMATION  
(Regulated and Unregulated Emissions Units)**

**Segment Description and Rate:**

Information for Facility\_ID : 1 Emission Unit #: 3 Segment #: 7

1. Segment Description (Process/Fuel Type and Associated Operating Method/Mode) (limit to 500 characters): Unit 5 Boiler chemical cleaning waste evaporation
2. Source Classification Code (SCC): 1-01-013-01
3. SCC Units: thousand gallons burned
4. Maximum Hourly Rate: 3
5. Maximum Annual Rate: 500
6. Estimated Annual Activity Factor:
7. Maximum Percent Sulfur:
8. Maximum Percent Ash:
9. Million Btu per SCC Unit:
10. Segment Comment (limit to 200 characters): Items 6,7,8 & 9 do not apply. This activity to be undertaken on a periodic basis in accordance with DARM guidance, and EPA waste rules (40 CFR 279.72).

**G. EMISSIONS UNIT POLLUTANTS  
(Regulated Emissions Units Only)**

**Information for Facility\_ID: 1 Emission Unit #: 3**

1. Pollutant Emitted	2. Primary Control Device Code	3. Secondary Control Device Code	4. Pollutant Regulatory Code
SO2	NA	NA	EL
NOX	NA	NA	NS
CO	NA	NA	NS
PM	077	NA	EL
PM10	077	NA	NS
VOC	NA	NA	NS
H133	NA	NA	NS
H107	NA	NA	NS
H106	NA	NA	NS
SAM	NA	NA	NS
HAP	NA	NA	NS

**H. EMISSIONS UNIT POLLUTANT DETAIL INFORMATION  
(Regulated Emissions Units Only - Emissions Limited Pollutants Only)**

Information for Facility\_ID: 1 Emission Unit #: 3 Pollutant #: 1

**Pollutant Detail Information**

1. Pollutant Emitted:	Particulate Matter - Total
2. Total Percent Efficiency of Control:	%
3. Potential Emissions:	506.25 lbs/hr                      2217.38 tons/yr
4. Synthetically Limited? (Yes/No):	N
5. Range of Estimated Fugitive/Other Emissions: (1, 2, 3) :	to    tons/yr
6. Emission Factor:	0.125                      Units    lb/mmBtu Reference:    DEP Rule 62-296.405(1)(b)
7. Emissions Method Code: (0, 1, 2, 3, 4, 5):	0 <input type="checkbox"/> 0 <input type="checkbox"/> 1 <input type="checkbox"/> 2 <input type="checkbox"/> 3 <input type="checkbox"/> 4 <input type="checkbox"/> 5
8. Calculation of Emissions (limit to 600 characters):	 0.125 lb/mmBtu * 4050 mmBtu/hr = 506.25 lb/hr (506.25 lb/hr * 8760 hr/yr) / 2000 lb/ton = 2217.38 tpy
9. Pollutant Potential/Estimated Emissions Comment (limit to 200 characters):	A particulate matter emissions limit of 3 hours /24 hours at 0.3 lb/mmBtu and 21 hours/24hours at 0.1 lb/mmBtu is equivalent to an average of 0.125 lb/mmBtu.

**Information for Facility\_ID: 1 Emission Unit #: 3 Pollutant #: 1  
Basis For Allowable Emission #: 1**

**Allowable Emissions** (Pollutant identified on front page)

1. Basis for Allowable Emissions Code: Emissions limit required by rule
2. Future Effective Date of Allowable Emissions:
3. Requested Allowable Emissions and Units: 0.1 Units : lb/mmBtu
4. Equivalent Allowable Emissions: 405 lbs/hr 1552.2 tons/yr
5. Method of Compliance: DEP Rule 62-296.405(1)(e)2.
6. Pollutant Allowable Emissions Comment ( <b>Desc. of Related Operating Method/Mode</b> ) (limit to 200 characters): <b>175</b> FDEP Rule 62-296.340(1)(e) is the basis for the emission limit. The equivalent allowable emissions given above are based on steady-state operation 21 hours per 24-hour period.

**Information for Facility\_ID: 1 Emission Unit #: 3 Pollutant #: 1  
Basis For Allowable Emission #: 2**

**Allowable Emissions** (Pollutant identified on front page)

1. Basis for Allowable Emissions Code: Emissions limit required by rule
2. Future Effective Date of Allowable Emissions:
3. Requested Allowable Emissions and Units: 0.3 Units : lb/mmBtu
4. Equivalent Allowable Emissions: 1215 lbs/hr 665.2 tons/yr
5. Method of Compliance: DEP Rule 62-296.405(1)(e)2.
6. Pollutant Allowable Emissions Comment ( <b>Desc. of Related Operating Method/Mode</b> ) (limit to 200 characters): 133 Equivalent allowable emissions based on 3 hours of sootblowing per 24-hour period. Regulatory limit on PM is from Rule 62-210.700(1).

**H. EMISSIONS UNIT POLLUTANT DETAIL INFORMATION  
(Regulated Emissions Units Only - Emissions Limited Pollutants Only)**

**Information for Facility\_ID: 1 Emission Unit #: 3 Pollutant #: 3**

**Pollutant Detail Information**

1. Pollutant Emitted: Sulfur Dioxide	
2. Total Percent Efficiency of Control:	%
3. Potential Emissions: 11137.5 lbs/hr	48782.3 tons/yr
4. Synthetically Limited? (Yes/No): N	
5. Range of Estimated Fugitive/Other Emissions: (1, 2, 3) : to tons/yr	
6. Emission Factor: 2.75	Units lb/mmBtu
Reference: DEP Rule 62-296.405(1)(c)1.j.	
7. Emissions Method Code: (0, 1, 2, 3, 4, 5): 0 [ ] 0 [ ] 1 [ ] 2 [ ] 3 [ ] 4 [ ] 5	
8. Calculation of Emissions (limit to 600 characters):  2.75 lb/mmBtu * 4050 mmBtu = 11,137.5 lb/hr 11,137.5 * 8760 hr/yr / 2000 lb/ton = 48,782.3 TPY	
9. Pollutant Potential/Estimated Emissions Comment (limit to 200 characters): Sanford Unit 5 could fire a mixture of No. 6 fuel oil with up to 4.0% sulfur with sufficient quantities of natural gas to meet the 2.75 lb/mmBtu heat input SO2 emission limit.	

**Information for Facility\_ID: 1 Emission Unit #: 3 Pollutant #: 3**  
**Basis For Allowable Emission #: 1**

**Allowable Emissions** (Pollutant identified on front page)

1. Basis for Allowable Emissions Code: Emissions limit required by rule	
2. Future Effective Date of Allowable Emissions:	
3. Requested Allowable Emissions and Units: 2.75 Units : lb/mmBtu	Same 99 wt
4. Equivalent Allowable Emissions: 11137.5 lbs/hr 48782.3 tons/yr	
5. Method of Compliance: Fuel sampling & analysis	
6. Pollutant Allowable Emissions Comment ( <b>Desc. of Related Operating Method/Mode</b> ) (limit to 200 characters): 139 Information provided on this page is for No.6 residual oil firing only. FDEP permit limit and emission factor are for fuel oil firing only.	

**I. VISIBLE EMISSIONS INFORMATION  
(Regulated Emissions Units Only)**

Information for Facility-ID : 1 Emission Unit #: 3  
Visible Emissions Limitation #: 1

1. Visible Emissions Subtype: VE40
2. Basis for Allowable Opacity Code(R/O):   RULE       [ ] Rule               [ ] Other
3. Allowable Opacity: Normal Conditions: 40                               % Exceptional Conditions:       % Maximum Period of Excess Opacity Allowed:     min/hr
4. Method of Compliance Code:   EPA Method 9
5. Visible Emissions Comment (limit to 200 characters): DEP Rule 62-296.405(1)(a) and (1)(e)1., F.A.C. Visible Emissions limited to 40% opacity, except for allowed excess emissions. Compliance testing is performed annually using EPA Method 9.



**I. VISIBLE EMISSIONS INFORMATION  
(Regulated Emissions Units Only)**

Information for Facility-ID : 1 Emission Unit #: 3  
Visible Emissions Limitation #: 2

1. Visible Emissions Subtype: VE60
2. Basis for Allowable Opacity Code(R/O):   RULE       [ ] Rule       [ ] Other
3. Allowable Opacity: Normal Conditions: 60                           % Exceptional Conditions: 100    % Maximum Period of Excess Opacity Allowed: 24   min/hr
4. Method of Compliance Code:   EPA Method 9
5. Visible Emissions Comment (limit to 200 characters): Rule 62-210.700(3), F.A.C. limits soot blowing & load changing to 60% opacity for up to 3 hrs/24 hrs, with < 4, 6-minute pds of up to 100% opac. if unit has an operational CEM.



**J. CONTINUOUS MONITOR INFORMATION**  
**(Regulated Emissions Units Only)**

Information for Facility-ID : 1 Emission Unit #: 3  
Continuous Monitor #: 1

**Continuous Monitoring System**

1. Parameter Code:		
2. Pollutant(s):	Sulfur Dioxide	
3. CMS Requirement Code(R/O):	RULE	Rule / Other
4. Monitor Information:		
Manufacturer:	TECO	
Model Number:	43B	Serial Number: 43B-48521-281
5. Installation Date (DD-MON-YYYY):	08/30/94	
6. Performance Specification Test Date (DD-MON-YYYY):	10/12/94	
7. Continuous Monitor Comment (limit to 200 characters):	Required by 40 CFR 75.10(a)(1)	

**J. CONTINUOUS MONITOR INFORMATION  
(Regulated Emissions Units Only)**

Information for Facility-ID : 1 Emission Unit #: 3  
Continuous Monitor #: 2

**Continuous Monitoring System**

1. Parameter Code:		
2. Pollutant(s):	Nitrogen Oxides	
3. CMS Requirement Code(R/O):	RULE	Rule / Other
4. Monitor Information:		
Manufacturer:	TECO	
Model Number:	42	Serial Number: 42-48369-280
5. Installation Date (DD-MON-YYYY):	08/30/94	
6. Performance Specification Test Date (DD-MON-YYYY):	10/12/94	
7. Continuous Monitor Comment (limit to 200 characters):	Required by 40 CFR 75.10(a)(2)	

**J. CONTINUOUS MONITOR INFORMATION  
(Regulated Emissions Units Only)**

Information for Facility-ID : 1 Emission Unit #: 3  
Continuous Monitor #: 3

**Continuous Monitoring System**

1. Parameter Code:		
2. Pollutant(s):	Carbon dioxide	
3. CMS Requirement Code(R/O):	RULE	Rule / Other
4. Monitor Information:		
Manufacturer:	Milton Roy	
Model Number:	3300	Serial Number: N3L2493T
5. Installation Date (DD-MON-YYYY):	08/30/94	
6. Performance Specification Test Date (DD-MON-YYYY):	10/12/94	
7. Continuous Monitor Comment (limit to 200 characters):	Required by 40 CFR 75.10(a)(3)(i)	

**J. CONTINUOUS MONITOR INFORMATION  
(Regulated Emissions Units Only)**

Information for Facility-ID : 1 Emission Unit #: 3  
Continuous Monitor #: 4

**Continuous Monitoring System**

1. Parameter Code:		
2. Pollutant(s):	Volumetric flow rate	
3. CMS Requirement Code(R/O):	RULE	Rule / Other
4. Monitor Information:		
Manufacturer:	Air Monitor	
Model Number:	MASSTRON	Serial Number: 6084D
5. Installation Date (DD-MON-YYYY):	08/30/94	
6. Performance Specification Test Date (DD-MON-YYYY):	10/12/94	
7. Continuous Monitor Comment (limit to 200 characters):	Required by 40 CFR 75.10(a)(1)	

**J. CONTINUOUS MONITOR INFORMATION  
(Regulated Emissions Units Only)**

Information for Facility-ID : 1 Emission Unit #: 3  
 Continuous Monitor #: 5

**Continuous Monitoring System**

1. Parameter Code:			
2. Pollutant(s):		Visible emissions (opacity)	
3. CMS Requirement Code(R/O):		RULE	Rule / Other
4. Monitor Information:			
Manufacturer: Lear Siegler		Serial Number: 38972	
Model Number: RM41			
5. Installation Date (DD-MON-YYYY): 03/01/78			
6. Performance Specification Test Date (DD-MON-YYYY): 12/14/94			
7. Continuous Monitor Comment (limit to 200 characters):			
Required by 40 CFR 75.10(a)(4) The date of manufacture is used as the installation date. The actual date of manufacture is no known, so the first day of the month was substituted.			

**K. PREVENTION OF SIGNIFICANT DETERIORATION (PSD) INCREMENT  
TRACKING INFORMATION  
(Regulated and Unregulated Emissions Units)**

Information for Facility-ID : 1 Emission Unit # : 3

**PSD Increment Consumption Determination**

1. Increment Consuming for Particulate Matter or Sulfur Dioxide?

If the emissions unit addressed in this section emits particulate matter or sulfur dioxide, answer the following series of questions to make a preliminary determination as to whether or not the emissions unit consumes PSD increment for particulate matter or sulfur dioxide. Check the first statement, if any, that applies and skip remaining statements.

Select (1-5) : 5

- [ 1 ] The emissions unit is undergoing PSD review as part of this application, or has undergone PSD review previously, for particulate matter or sulfur dioxide. Final determination is that emissions unit consumes increment.
- [ 2 ] The facility addressed in this application is classified as an EPA major source pursuant to paragraph (c) of the definition of "major source of air pollution" in Chapter 17-213, F.A.C., and the emissions unit addressed in this section commenced (or will commence) construction after January 6, 1975. Preliminary determination is that baseline emissions are zero, and emissions unit consumes increment.
- [ 3 ] The facility addressed in this application is classified as an EPA major source, and the emissions unit began initial operation after January 6, 1975, but before December 27, 1977. Preliminary determination is that baseline emissions are zero, and emissions unit consumes increment.
- [ 4 ] For any facility, the emissions unit began (or will begin) initial operation after December 27, 1977. Preliminary determination is that baseline emissions are zero, and emissions unit consumes increment.
- [ 5 ] None of the above apply. If so, the baseline emissions of the emissions unit are nonzero. In such case, additional analysis, beyond the scope of this application, is needed to determine whether changes in emissions have occurred (or will occur) after the baseline date that may consume or expand increment.



2. Increment Consuming for Nitrogen Dioxide?

If the emissions unit addressed in this section emits nitrogen oxides, answer the following series of questions to make a preliminary determination as to whether or not the emissions unit consumes PSD increment for nitrogen dioxide. Check first statement, if any, that applies and skip remaining statements.

Select (1-5) : 5

- [ 1 ] The emissions unit addressed in this section is undergoing PSD review as part of this application, or has undergone PSD review previously, for nitrogen dioxide. Final determination is that emissions unit consumes increment.
- [ 2 ] The facility addressed in this application is classified as an EPA major source pursuant to paragraph (c) of the definition of "major source of air pollution" in Chapter 17-213, F.A.C., and the emissions unit addressed in this section commenced (or will commence) construction after February 8, 1988. Preliminary determination is that baseline emissions are zero, and emissions unit consumes increment.
- [ 3 ] The facility addressed in this application is classified as an EPA major source, and the emissions unit began initial operation after February 8, 1988, but before March 28, 1988. Preliminary determination is that baseline emissions are zero, and emissions unit consumes increment.
- [ 4 ] For any facility, the emissions unit began (or will begin) initial operation after March 28, 1988. Preliminary determination is that baseline emissions are zero, and emissions unit consumes increment.
- [ 5 ] None of the above apply. If so, the baseline emissions of the emissions unit are nonzero. In such case, additional analysis, beyond the scope of this application, is needed to determine whether changes in emissions have occurred (or will occur) after the baseline date that may consume or expand increment.

3. Increment Consuming/Expanding Code: (C, E, U- unkown):

PM	U
SO2	U
NO2	U

4. Baseline Emissions:

PM	lbs/hr	tons/yr
SO2	lbs/hr	tons/yr
NO2	tons/yr	

5. PSD Comment (limit to 200 characters):  
Sanford Unit 5 was constructed in 1973 which pre-dates the major source PSD baseline date of 1/5/75.

**L. EMISSIONS UNIT SUPPLEMENTAL INFORMATION  
(Regulated Emissions Units Only)**

Information for Facility-ID : 1 Emission Unit # : 3

**Supplemental Requirements for All Applications**

1. Process Flow Diagram : PSNU3_1.bmp Attached Document ID / Not Applicable / Waiver Requested
2. Fuel Analysis or Specification: PSNU3_2.txt Attached Document ID / Not Applicable / Waiver Requested
3. Detailed Description of Control Equipment : PSNU3_3.txt Attached Document ID / Not Applicable / Waiver Requested
4. Description of Stack Sampling Facilities : PSNU3_4.bmp Attached Document ID / Not Applicable / Waiver Requested
5. Compliance Test Report : Previously submitted date: 7/27/94 Attached Document ID / Previously submitted, Date / Not Applicable
6. Procedures for Startup and Shutdown : PSNU3_6.txt Attached Document ID / Not Applicable
7. Operation and Maintenance Plan : NA Attached Document ID / Not Applicable
8. Supplemental Information for Construction Permit Application : NA Attached Document ID / Not Applicable
9. Other Information Required by Rule or Statute : NA Attached Document ID / Not Applicable

**Additional Supplemental Requirements for Category I Applications Only**

10. Alternative Methods of Operation : PSNU3_10.txt Attached Document ID / Not Applicable
11. Alternative Modes of Operation (Emissions Trading) : NA Attached Document ID / Not Applicable
12. Identification of Additional Applicable Requirements : NA Attached Document ID / Not Applicable
13. Enhanced Monitoring Plan : NA Attached Document ID / Not Applicable
14. Acid Rain Permit Application  Acid Rain Application - Phase II (Form No. 17-210.900(1)(a)) Attached Document ID: Not Applicable  Repowering Extension Plan (Form No. 17-210.900(1)(b)) Attached Document ID: NA  New Unit Exemption (Form No. 17-210.900(1)(c)) Attached Document ID: NA  Retired Unit Exemption (Form No. 17-210.900(1)(c)) Attached Document ID: NA  Not Applicable

TECHNICAL ACCEPTANCE		
ORG	BY	DATE
WALKDOWN INFORMATION		
ORG	BY	DATE
AS-BUILT INFORMATION		

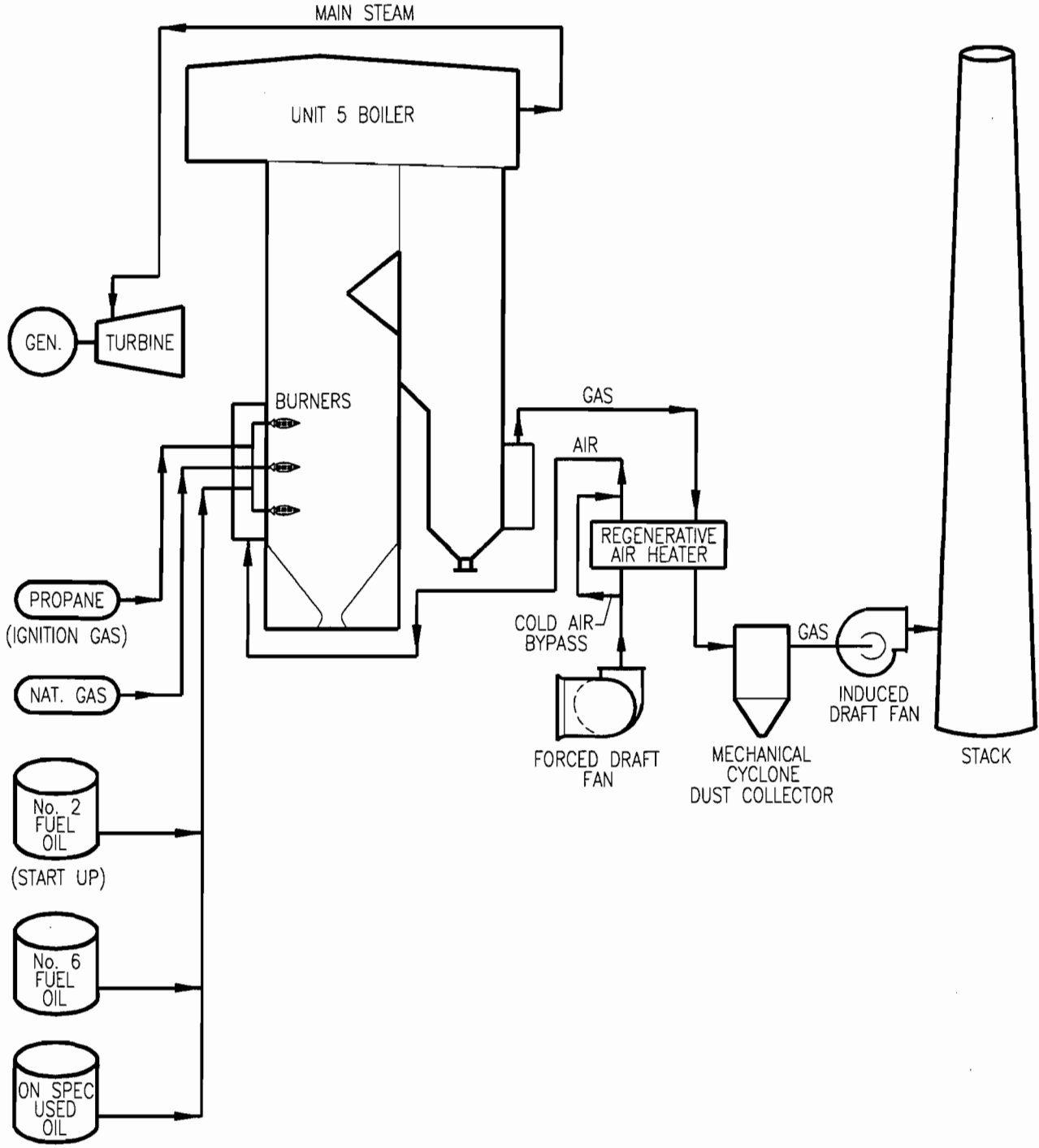

PERMITTED FUEL OPTIONS

BAR CODE

	SYSTEM YY	DISCIPLINE M	PLANT/UNIT SANFORD PLANT
	SCALE N/A	CAD FILE NAME SN004411	TITLE EMISSION UNIT PROCESS FLOW DIAGRAM STEAM GENERATOR/BOILER ATTACHMENT NO. EU3
	DRAWING SIZE A (8.5X11)	FPL ARCHIVE NAME SN004411	

0	7/17/95	ISSUED FOR TITLE V PERMIT	PWB	PWB	CSP	CSP	ETS
REV	DATE	REVISION DESCRIPTION	BY	CH	COR	APR	ORG

DRAWING NUMBER	SHEET	REV
PSN3-M0105-YY	1 OF 1	0

Fuel Analysis  
Natural Gas Analysis (typical)<sup>2</sup>

<u>Parameter</u>	<u>Typical value</u>	<u>Max value</u>
Specific gravity(@ 60° F)	0.887	none
Heat content (Btu/cu ft)	950 - 1124	none
% sulfur (grains/CCF)	0.43 <sup>1</sup>	1.00
% nitrogen (by volume)	0.8	none
% ash	negligible	none

\*Note: The values listed are "typical" values based upon information supplied to FPL by Florida Gas Transmission (FGT). However, analytical results from grab samples of fuel taken at any given point in time may vary from those listed.

(1) Data from laboratory analysis

(2) The values are "typical" based upon the following:

- Information gathered by FPL through laboratory analysis, and
- FPL's fuel purchasing specifications. It should be noted that the analytical results obtained from grab samples taken at any given time may vary from those listed.

## Attachment PSNU3\_2.txt

Fuel Analysis  
No.6 Oil Analysis (typical)<sup>4</sup>

<u>Parameter</u>	<u>Typical value</u>	<u>Specifications</u>
API gravity (@ 60° F)	8 - 12	10.1 min <sup>1</sup>
Heat content (MBtu/bbl)	6,310 - 6420	6,340 <sup>1</sup>
% Sulfur	2.0 <sup>5</sup>	2.5 max <sup>3</sup>
% Nitrogen	0.2 - 0.5 <sup>2</sup>	none
% Ash	0.06 - 0.09 <sup>2</sup>	0.10 max <sup>1</sup>

Footnotes:

- (1) Data taken from FPL fuel specifications.
- (2) Data taken from laboratory analysis.
- (3) Maximum permitted from current air operation permit.
- (4) The values are "typical" based upon the following:
  - Information gathered by FPL through laboratory analysis,
  - FPL's fuel purchasing specifications. It should be noted that the analytical results obtained from grab samples taken at any given time may vary from those listed.
- (5) Sulfur content values typically range between 1.6% and 2.4% and are derived from as-fired laboratory analysis of fuel oil fired at Sanford Power Plant.

## Attachment PSNU3\_2.txt

Fuel Analysis  
No. 2 Distillate oil (typical)<sup>3</sup>

<u>Parameter</u>	<u>Typical value</u>	<u>Specifications</u>
API gravity (@ 60 F)	35.0 <sup>2</sup>	30 - 40 <sup>1</sup>
Heat content (MBtu/bbl)	5,700 - 5,800 <sup>2</sup>	none
% sulfur	0.3 - 0.5 <sup>1</sup>	0.5 maximum <sup>1</sup>
% nitrogen	no specification	none
% ash	<0.01 <sup>2</sup>	0.01 <sup>1</sup>

Footnotes:

- (1) Data taken from FPL fuel specifications.
- (2) Data taken from laboratory analysis.
- (3) The values are "typical" based upon the following:
  - Information gathered by FPL through laboratory analysis, and
  - FPL's fuel purchasing specifications. It should be noted that the analytical results obtained from grab samples taken at any given time may vary from those listed.



**Attachment PSNU3\_2.txt**

Fuel Analysis  
Propane (typical)<sup>1</sup>

Emission unit #1 may occasionally light off (start up) on propane fuel, then switch to another fuel, such as No.6 residual oil. The propane fuel is supplied by a commercial vendor and is stored in small tanks located at the bottom of the boiler area. The chemical formula for propane is C<sub>3</sub>H<sub>8</sub> .

<u>Parameter</u>	<u>Typical value</u>	<u>Specifications</u>
Specific gravity (@ 60 F)	0.51 <sup>1</sup>	none
Heat content (MBtu/bbl)	600 - 1,000	none
% sulfur	0.0031	none
% nitrogen	no specification	none
% ash	no specification	none

Footnotes:

- (1) The values are "typical" based upon the following:
- Information gathered by FPL through laboratory analysis, and
  - FPL's fuel purchasing specifications. It should be noted that the analytical results obtained from grab samples taken at any given time may vary from those listed.

**Attachment PSNU3\_2.txt****Fuel Analysis  
On Specification Used Oil**

The boiler may occasionally burn used oil during normal operation. All used oil fired in the unit meets the specifications mandated by 40 CFR 279.11. Used oil fired by this boiler is typically derived from plant maintenance activities, and may include used lube oils, transformer oils, etc. that meet the analytical specifications. Criteria used oil values follow:

<u>Parameter</u>	<u>Typical value</u>	<u>Specifications</u>
API gravity (@ 60 F)	30.0 <sup>1</sup>	none
Heat content (MBtu/bbl)	6,000 <sup>1</sup>	none
% sulfur	0.3 <sup>1</sup>	none
% nitrogen	negligible	none
% ash	0.01 <sup>1</sup>	0.01

Footnotes:

- (1) The values are "typical" based upon the following:
- Information gathered by FPL through laboratory analysis, and
  - FPL's fuel purchasing specifications. It should be noted that the analytical results obtained from grab samples taken at any given time may vary from those listed.

**Attachment PSNU3\_3.txt**  
**Detailed Description of Control Equipment**

**A. Cyclone Separator** - This steam generator (boiler) is supplied with two 104B-GHS #19-684 UOP tubular mechanical dust collectors with side inlet and universal outlet. Each dust collector consists of 695 tubes and four dust collection hoppers. The dust collector has the following efficiency at 2.55 inches of water @ peak load:

<u>Particle Range</u> <u>(micron)</u>	<u>Mean Diameter</u> <u>(micron)</u>	<u>Estimated Efficiency</u> <u>(percent)</u>
0 - 5	2.5	30.3
5 - 10	7.5	66.2
10 - 20	15	88.6
20 - 45	32.5	99.1
45 +	45	99.5

FLORIDA POWER & LIGHT CO.  
 STACK SAMPLING FACILITIES  
 SANFORD SITE

FOSSIL FUEL STEAM GENERATOR  
 UNITS 4 & 5

STACK DIAGRAM

STACK SPECIFICATIONS

SAMPLING DIAMETER: 256.8 in.  
 SAMPLING AREA: 359.7 sq. ft.  
 SAMPLING PORT DEPTH: 60.0 in.  
 No. OF PORTS: 4

NOTE: DRAWING IS NOT TO SCALE

PROBE DIAGRAM  
 (Method 17 - Particulate Test)

No. OF POINTS PER TRAVERSE: 6  
 TOTAL No. OF POINTS : 24  
 SAMPLING TIME PER POINT: 2.5 min.  
 TOTAL SAMPLING TIME: 60.0 min.

PROBE DIAGRAM

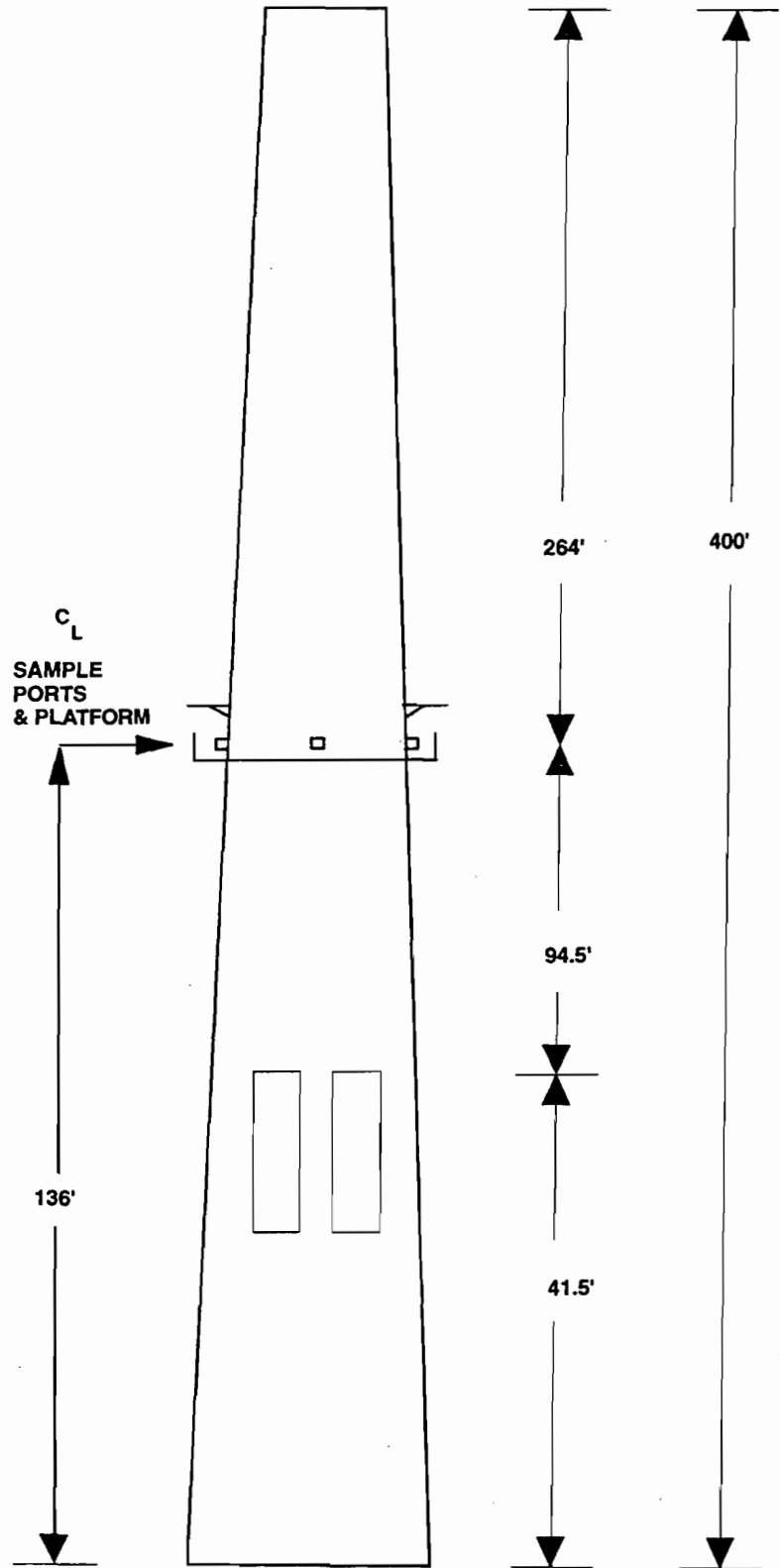
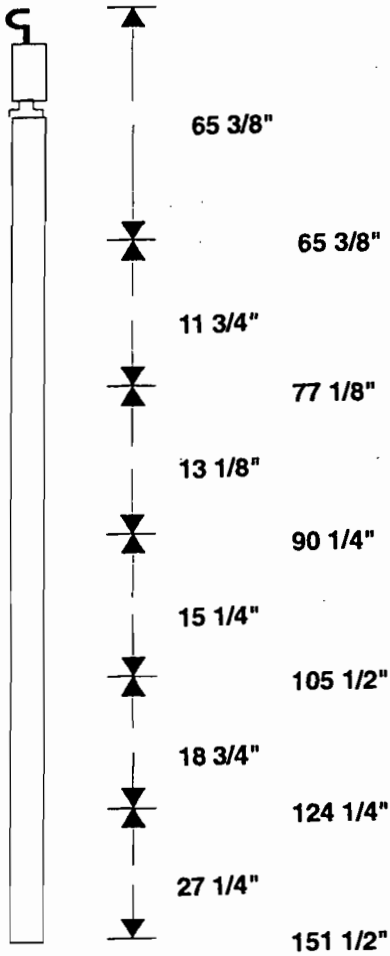

Access to the sampling ports is provided by a ladder. Channel iron with a trolley system is above each port for probe support. AC power is available at the base of the stack.

## Attachment PSNU3\_6.txt

### Startup & Shutdown Procedures - Minimizing Excess Emissions

Startup of the fossil-fuel boiler begins when fuel (either natural gas or oil) is introduced into one or more burners within the boiler and lighted (commencement of combustion). Startup is complete and steady-state operation begins when the combustion process has stabilized and the megawatt load on the unit is stable.

Shutdown of the fossil-fuel boilers begins when unit megawatt load is decreased to below 10% of maximum and continues until the final burner gun is removed from service and the final Induced-draft or Forced-draft fan is removed from service.

Excess emissions may be detected during all modes of boiler operation by any one of several continuous emissions monitors. Continuous emission monitors are currently in place for NO<sub>x</sub>, SO<sub>2</sub> and opacity. An audible and visual alarm are activated whenever permitted values for any of the above parameters are approached.

Countermeasures which may be taken in the event of excess emissions include, but are not limited to:

- proper excess air adjustments
- recognizing and removal of faulty burners
- fuel oil temperature adjustments
- proper and timely operation of boiler cleaning devices
- removal of the unit from system-dispatch mode
- reduction of unit megawatt load
- stopping and restarting of boiler cleaning devices
- lowering load rate
- pressure rate changes

Best Operational Practices to prevent excess emissions, and knowledge of the appropriate countermeasures to take if an excess emissions condition exists, are taught during routine operator training. Control Center Operators and the Plant Foremen who operate the fossil fuel-fired boilers receive this training. In addition, plant operations and supervisory staff are periodically given Air Regulation Awareness Training by the FPL Environmental Affairs Department. Topics include current permit limits, maximum allowable duration of authorized excess emissions, appropriate countermeasures for excess emissions, duty to notify, etc.

**PSNU3\_10.txt**  
**Alternative Methods of Operation**

Operation at Various Capacities and Heat Input Rates

The Sanford Unit 5 boiler may be operated up to 8760 hours per year at heat input rates from zero to 4050 MMBtu per hour on No.#6 oil, and from zero to 4230 MMBtu per hour on natural gas. When a blend of fuel oil and natural gas are burned, the heat input is prorated based upon the percent heat input of each fuel.

Different Fuel Types

The unit may be fired with a variable combination of No. 6 residual fuel oil, natural gas, or No. 2 fuel oil. The unit may occasionally utilize propane fuel to light off (start up) the boiler, then switch to another fuel, such as No.6 residual oil. The unit may also burn on-specification used oil meeting EPA specifications under 40 CFR 279.11. The quantity of on-specification used oil shall not exceed 2,442,972 gallons per year for Unit 5.

Current emissions limitations are as follows:

<u>Pollutant</u>	<u>Emission Limit</u>
Particulate matter-steady state	0.1 lb/MMBtu
Particulate matter-soot blowing	0.3 lb/MMBtu
Sulfur dioxide	2.75 lb/MMBtu

Oil and Gas Co-firing

This emission unit may co-fire natural gas with residual oil. When combusting both fuels simultaneously, the percentage of natural gas will be adjusted to ensure that the applicable SO<sub>2</sub> emission limit and visible emission limits are complied with.

Soot blowing

The unit may blow soot for up to 24 hours per day, so long as excess emissions are limited to 60% opacity for 3 hours in 24 hours with four 6-minute periods of up to 100% opacity.

Utilization of Additives

Additives such as Magnesium hydroxide Mg(OH)<sub>2</sub> are added to the boiler periodically at various loads. When magnesium hydroxide is used, it is injected into the boiler via the I.K. soot blower lances and through manual hand lances on a batch basis, rather than continuously. The dosage rate is based on the quantity of fuel burned and the amount of ash in the fuel. FPL reserves the right to use other additives if they are suitable.

**Attachment PSNU3\_10.txt**  
**Alternative Methods of Operation**

Evaporation of Spent Boiler Chemical Cleaning Chemicals

On a periodic basis, as part of routine maintenance, the inside of the steam generator tubes (boiler tubes) at Sanford Unit 5 are cleaned using a series of chemical solutions that remove deposited scale which adversely affects the efficiency and reliability of the generating units.

The solutions and rinsewaters are collected in large mobile tanks ("frac tanks") pursuant to guidance issued by the Department. Upon completion of the cleaning process and prior to disposal of the spent cleaning solution and rinses, representative sampling of the liquids collected in the "frac tanks" is conducted as per 40 CFR 261, Appendix I, to determine the hazardous waste status of the accumulated wastewater, using Toxicity Characteristic Leaching Procedure (TCLP) analysis.

If the wastewater is determined to be hazardous, it will be managed as such in accordance with 40 CFR 262.34, 40 CFR 265 Subpart I, and 40 CFR 268 with respect to generators accumulating and treating waste in containers and tanks. An appropriate waste analysis plan will be developed to determine and document the pre- and post-treatment characteristics of the wastewater. Hazardous waste may also be transported to an approved hazardous waste facility for the appropriate disposal.

If the spent cleaning solution and rinses are determined to be non-hazardous, they are then disposed by evaporation in the units boiler. Introduction into the boiler will occur at a rate that will not cause an exceedence of the opacity limit of the unit in which evaporation is occurring (in this case, 40 percent opacity).

## Attachment PSNU3\_12.txt

### Identification of Additional Applicable Requirements

Applicable Requirements as defined in Rule 62-210.200(29) not identified in Section D of this emission unit section are included in this attachment of the application. Any air operation permit issued by the Department (or local program designee) and included in this attachment is provided for information purposes. The specific conditions of the operating permit are not Applicable Requirements as defined in Rule 62-210.200(29) unless implementing a specific Applicable Requirement of the Department's rules (e.g. emission limitations and consent orders).

Air operation permit No. AO64-217877 contains the following conditions:

1. Heat input rate for Unit 5 is not to exceed 4,050 mmBtu/hour when firing No. 6 residual fuel oil and 4,230 mmBtu/hour when firing natural gas. *FPL tracks heat input on a continuous basis using fuel sampling and analysis and fuel flow measurement.*
2. The boiler shall be fired with a variable combination of No. 6 residual fuel oil, natural gas, No. 2 fuel oil, propane gas or on-specification used oil from FPL operations. The quantity of on-specification used oil to be fired shall not exceed 2,442,972 gallons/year. *FPL tracks the fuel usage on a continuous basis.*
3. The maximum allowable emissions for Unit 5 are as follows:

Pollutant	Fuel	Emission Limit	Test Method
<u>Particulate Matter - Steady-State</u>	Oil	0.1 lb/mmBtu	EPA Method 5 or 17
Soot Blowing or Load Changing	Oil	0.3 lb/mmBtu (3 hrs/24 hrs)	EPA Method 5 or 17
<u>Sulfur Dioxide -</u>	Oil	2.75 lb/mmBtu	Monthly Fuel Analysis
<u>Visible Emissions - Steady-State</u>	Oil	40 percent opacity	DEP Method 9
Soot Blowing or Load Changing	Oil	60 percent opacity (3 hrs/24 hrs)	DEP Method 9

2.5% S Limit on #6 FO?

FPL conducts annual compliance testing to determine compliance with permitted emission limitations.



### III. EMISSIONS UNIT INFORMATION

Information for Facility - ID : 1 Emission Unit # : 4

A separate Emissions Unit Information Section (including subsections A through L as required) must be completed for each emissions unit addressed in this Application for Air Permit. If submitting the application form in hard copy, indicate, in the space provided at the top of each page, the number of this Emissions Unit Information Section and the total number of Emissions Unit Information Sections submitted as part of this application. Some of the subsections comprising the Emissions Unit Information Section of the form are intended for regulated emissions units only. Others are intended for both regulated and unregulated emissions units. Each subsection is appropriately marked.

#### A. TYPE OF EMISSIONS UNIT (Regulated and Unregulated Emissions Units)

##### Type of Emissions Unit Addressed in This Section

1. Regulated or Unregulated Emissions Units? Check one:

- [ X ] The emissions unit addressed in this Emissions Unit Information Section is a regulated emissions unit.
- [ ] The emissions unit addressed in this Emissions Unit Information Section is a unregulated emissions unit.

2. Single Process, Group Processes, or Fugitive Only?

Enter The Number (1-3): 1

- [ 1 ] This Emissions Unit Information Section addresses, as a single emissions unit, a single process or production unit, or activity, which produces one or more air pollutants and which has at least one definable emission point (stack or vent).
- [ 2 ] This Emissions Unit Information Section addresses, as a single emissions unit, a group of process or production units and activities which has at least one definable emission point(stack or vent) but may also produce fugitive emissions.
- [ 3 ] This Emissions Unit Information Section addresses, as a single emissions unit, one or more process or production units and activities which produce fugitive emissions only.

**B. GENERAL EMISSIONS UNIT INFORMATION  
(Regulated and Unregulated Emissions Units)**

**Emissions Unit Description and Status**

1. Description of Emissions Unit Addressed in This Section (limit to 60 characters): Unregulated Emission Units
2. Emissions Unit Identification Number: Unknown (No Corresponding ID or Unknown)
3. Emission Unit Status Code: (A or C) : A
4. Acid Rain Unit? (Y/N): N
5. Emissions Unit Major Group SIC Code: 049
6. Emissions Unit Comment (limit to 500 characters): Information in this Emission Unit Section includes all unregulated emission units at the Sanford facility, including the emergency diesel generator. Attachment PSN - FW provides a list of all included emission units.

**Emissions Unit Control Equipment**

**A. Control Equipment # :**

1. Description (limit to 200 characters):
2. Control Device or Method Code:

**B. Control Equipment # :**

1. Description (limit to 200 characters):
2. Control Device or Method Code:

**C. Control Equipment # :**

1. Description (limit to 200 characters):
2. Control Device or Method Code:



**D. EMISSIONS UNIT REGULATIONS  
(Regulated Emissions Units Only)**

**Rule Applicability Analysis** (Required for Category II applications and Category III applications involving non Title-V sources. See Instructions.)

Not Applicable

**List of Applicable Regulations** (Required for Category I applications and Category III applications involving Title-V sources. See Instructions.)

Emissions Unit ID 4

F.A.C. 62-210.700(1) F.A.C. 62-210.700(4)	F.A.C. 62-210.700(6) F.A.C. 62-296.320(4)(b)	F.A.C. 62-296.320(4)(c) F.A.C. 62-297.310(2)(b)	F.A.C. 62-297.310(4)(a)2. F.A.C. 62-297.310(5) F.A.C. 62-297.310(7)(a)9. F.A.C. 62-297.310(8)
----------------------------------------------	-------------------------------------------------	----------------------------------------------------	--------------------------------------------------------------------------------------------------------

**E. EMISSION POINT (STACK/VENT) INFORMATION  
(Regulated Emissions Units Only)**

**Emission Point Description and Type**

Information for Facility-ID 1 Emission Unit # :4

1. Identification of Point on Plot Plan or Flow Diagram: Emergency Diesel Gen
2. Emission Point Type Code (1,2,3,4) : 1
3. Descriptions of Emissions Points Comprising this Emissions Unit (limit to 100 characters):
4. ID Numbers or Descriptions of Emission Units with this Emission Point in Common:
5. Discharge Type Code (D, F, H, P, R, V, W) : H
6. Stack Height: 12 ft
7. Exit Diameter: 0.6667 ft
8. Exit Temperature: 950 °F
9. Actual Volumetric Flow Rate: 2970 acfm
10. Percent Water Vapor: %
11. Maximum Dry Standard Flow Rate: dscfm
12. Nonstack Emission Point Height: ft
13. Emission Point UTM Coordinates: Zone: 17 East: 468.28 North: 3190.6
14. Emission Point Comment (limit to 200 characters):

**F. SEGMENT (PROCESS/FUEL) INFORMATION  
(Regulated and Unregulated Emissions Units)**

**Segment Description and Rate:**

Information for Facility\_ID :1 Emission Unit #: 4 Segment #: 1

1. Segment Description (Process/Fuel Type and Associated Operating Method/Mode) (limit to 500 characters): Diesel fuel burned in the emergency diesel generator which supplies boiler units 4, and 5.
2. Source Classification Code (SCC): 2-02-001-02
3. SCC Units: thousand gallons burned
4. Maximum Hourly Rate: 0.025
5. Maximum Annual Rate: 10
6. Estimated Annual Activity Factor:
7. Maximum Percent Sulfur: 0.5
8. Maximum Percent Ash:
9. Million Btu per SCC Unit: 136
10. Segment Comment (limit to 200 characters): The maximum annual rate is calculated based upon 400 hours per year of operation.



**F. SEGMENT (PROCESS/FUEL) INFORMATION  
(Regulated and Unregulated Emissions Units)**

**Segment Description and Rate:**

Information for Facility\_ID :1 Emission Unit #: 4 Segment #: 2

1. Segment Description (Process/Fuel Type and Associated Operating Method/Mode) (limit to 500 characters): Above-ground tank #A - Working and breathing loss
2. Source Classification Code (SCC): 4-03-010-21
3. SCC Units: Thousand gallons transferred or handled
4. Maximum Hourly Rate:
5. Maximum Annual Rate:
6. Estimated Annual Activity Factor: 236912130
7. Maximum Percent Sulfur:
8. Maximum Percent Ash:
9. Million Btu per SCC Unit: 152
10. Segment Comment (limit to 200 characters): Breathing loss = 65.28 lbs VOC / yr (per EPA Tanks2 program) Working loss = 117.38 lbs VOC / yr (per EPA Tanks2 program) Total estimated losses = 0.09 TPY, using estimated activity factor given above.

**F. SEGMENT (PROCESS/FUEL) INFORMATION  
(Regulated and Unregulated Emissions Units)**

**Segment Description and Rate:**

Information for Facility\_ID :1 Emission Unit #: 4 Segment #: 3

1. Segment Description (Process/Fuel Type and Associated Operating Method/Mode) (limit to 500 characters): Above-ground tank #B - Working and breathing loss
2. Source Classification Code (SCC): 4-03-010-21
3. SCC Units: Thousand gallons transferred or handled
4. Maximum Hourly Rate:
5. Maximum Annual Rate:
6. Estimated Annual Activity Factor: 236912130
7. Maximum Percent Sulfur:
8. Maximum Percent Ash:
9. Million Btu per SCC Unit: 152
10. Segment Comment (limit to 200 characters): Breathing loss = 65.28 lbs VOC / yr (per EPA Tanks2 program) Working loss = 117.38 lbs VOC / yr (per EPA Tanks2 program) Total estimated losses = 0.09 TPY, using estimated activity factor given above.

**F. SEGMENT (PROCESS/FUEL) INFORMATION  
(Regulated and Unregulated Emissions Units)**

**Segment Description and Rate:**

Information for Facility\_ID :/ Emission Unit #: 4 Segment #: 4

1. Segment Description (Process/Fuel Type and Associated Operating Method/Mode) (limit to 500 characters): Above-ground tank #C - Working and breathing loss
2. Source Classification Code (SCC): 4-03-010-21
3. SCC Units: Thousand gallons transferred or handled
4. Maximum Hourly Rate:
5. Maximum Annual Rate:
6. Estimated Annual Activity Factor: 233258000
7. Maximum Percent Sulfur:
8. Maximum Percent Ash:
9. Million Btu per SCC Unit: 152
10. Segment Comment (limit to 200 characters): Breathing loss = 13.16 lbs VOC / yr (per EPA Tanks2 program) Working loss = 53.93 lbs VOC / yr (per EPA Tanks2 program) Total estimated losses = 0.03 TPY, using estimated activity factor given above.

**F. SEGMENT (PROCESS/FUEL) INFORMATION  
(Regulated and Unregulated Emissions Units)**

**Segment Description and Rate:**

Information for Facility\_ID :/ Emission Unit #: 4 Segment #: 5

1. Segment Description (Process/Fuel Type and Associated Operating Method/Mode) (limit to 500 characters): Above-ground tank #D - Working and breathing loss
2. Source Classification Code (SCC): 4-03-010-21
3. SCC Units: Thousand gallons transferred or handled
4. Maximum Hourly Rate:
5. Maximum Annual Rate:
6. Estimated Annual Activity Factor: 234855932
7. Maximum Percent Sulfur:
8. Maximum Percent Ash:
9. Million Btu per SCC Unit: 152
10. Segment Comment (limit to 200 characters): Breathing loss = 25.69 lbs VOC / yr (per EPA Tanks2 program) Working loss = 85.26 lbs VOC / yr (per EPA Tanks2 program) Total estimated losses = 0.06 TPY, using estimated activity factor given above.

**F. SEGMENT (PROCESS/FUEL) INFORMATION  
(Regulated and Unregulated Emissions Units)**

**Segment Description and Rate:**

Information for Facility\_ID :1 Emission Unit #: 4 Segment #: 6

1. Segment Description (Process/Fuel Type and Associated Operating Method/Mode) (limit to 500 characters): Above-ground tank #3AD - Working and breathing loss
2. Source Classification Code (SCC): 4-03-010-21
3. SCC Units: Thousand gallons transferred or handled
4. Maximum Hourly Rate:
5. Maximum Annual Rate:
6. Estimated Annual Activity Factor: 233527280
7. Maximum Percent Sulfur:
8. Maximum Percent Ash:
9. Million Btu per SCC Unit: 152
10. Segment Comment (limit to 200 characters): Breathing loss = 1.47 lbs VOC / yr (per EPA Tanks2 program) Working loss = 23.06 lbs VOC / yr (per EPA Tanks2 program) Total estimated losses = 0.09 TPY, using estimated activity factor given above.

**F. SEGMENT (PROCESS/FUEL) INFORMATION  
(Regulated and Unregulated Emissions Units)**

**Segment Description and Rate:**

Information for Facility\_ID :/ Emission Unit #: 4 Segment #: 7

1. Segment Description (Process/Fuel Type and Associated Operating Method/Mode) (limit to 500 characters): Above-ground tank #3BD - Working and breathing loss
2. Source Classification Code (SCC): 4-03-010-21
3. SCC Units: Thousand gallons transferred or handled
4. Maximum Hourly Rate:
5. Maximum Annual Rate:
6. Estimated Annual Activity Factor: 233527280
7. Maximum Percent Sulfur:
8. Maximum Percent Ash:
9. Million Btu per SCC Unit: 152
10. Segment Comment (limit to 200 characters): Breathing loss = 1.47 lbs VOC / yr (per EPA Tanks2 program) Working loss = 23.06 lbs VOC / yr (per EPA Tanks2 program) Total estimated losses = 0.01 TPY, using estimated activity factor given above.

**F. SEGMENT (PROCESS/FUEL) INFORMATION  
(Regulated and Unregulated Emissions Units)**

**Segment Description and Rate:**

Information for Facility\_ID :1 Emission Unit #: 4 Segment #: 8

1. Segment Description (Process/Fuel Type and Associated Operating Method/Mode) (limit to 500 characters): Above-ground tank #4M - Working and breathing loss
2. Source Classification Code (SCC): 4-03-010-21
3. SCC Units: Thousand gallons transferred or handled
4. Maximum Hourly Rate:
5. Maximum Annual Rate:
6. Estimated Annual Activity Factor: 233462140
7. Maximum Percent Sulfur:
8. Maximum Percent Ash:
9. Million Btu per SCC Unit: 152
10. Segment Comment (limit to 200 characters): Breathing loss = 2.66 lbs VOC / yr (per EPA Tanks2 program) Working loss = 26.23 lbs VOC / yr (per EPA Tanks2 program) Total estimated losses = 0.01 TPY, using estimated activity factor given above.

**F. SEGMENT (PROCESS/FUEL) INFORMATION  
(Regulated and Unregulated Emissions Units)**

**Segment Description and Rate:**

Information for Facility\_ID :/ Emission Unit #: 4 Segment #: 9

1. Segment Description (Process/Fuel Type and Associated Operating Method/Mode) (limit to 500 characters): Above-ground tank #5M - Working and breathing loss
2. Source Classification Code (SCC): 4-03-010-21
3. SCC Units: Thousand gallons transferred or handled
4. Maximum Hourly Rate:
5. Maximum Annual Rate:
6. Estimated Annual Activity Factor: 233462140
7. Maximum Percent Sulfur:
8. Maximum Percent Ash:
9. Million Btu per SCC Unit: 152
10. Segment Comment (limit to 200 characters): Breathing loss = 2.66 lbs VOC / yr (per EPA Tanks2 program) Working loss = 26.23 lbs VOC / yr (per EPA Tanks2 program) Total estimated losses = 0.01 TPY, using estimated activity factor given above.



**F. SEGMENT (PROCESS/FUEL) INFORMATION  
(Regulated and Unregulated Emissions Units)**

**Segment Description and Rate:**

Information for Facility\_ID :1 Emission Unit #: 4 Segment #: 10

1. Segment Description (Process/Fuel Type and Associated Operating Method/Mode) (limit to 500 characters): Above-ground tank #LO - Working and breathing loss
2. Source Classification Code (SCC): 4-03-010-21
3. SCC Units: Thousand gallons transferred or handled
4. Maximum Hourly Rate:
5. Maximum Annual Rate:
6. Estimated Annual Activity Factor: 456895431
7. Maximum Percent Sulfur:
8. Maximum Percent Ash:
9. Million Btu per SCC Unit: 136
10. Segment Comment (limit to 200 characters): Breathing loss = 23.99 lbs VOC / yr (per EPA Tanks2 program) Working loss = 3440.38 lbs VOC / yr (per EPA Tanks2 program) Total estimated losses = 1.7 TPY, using estimated activity factor given above.

**F. SEGMENT (PROCESS/FUEL) INFORMATION  
(Regulated and Unregulated Emissions Units)**

**Segment Description and Rate:**

Information for Facility\_ID :/ Emission Unit #: 4 Segment #: 11

1. Segment Description (Process/Fuel Type and Associated Operating Method/Mode) (limit to 500 characters): Above-ground tank #LO2 - Working and breathing loss
2. Source Classification Code (SCC): 4-03-010-21
3. SCC Units: Thousand gallons transferred or handled
4. Maximum Hourly Rate:
5. Maximum Annual Rate:
6. Estimated Annual Activity Factor: 160513539
7. Maximum Percent Sulfur:
8. Maximum Percent Ash:
9. Million Btu per SCC Unit: 136
10. Segment Comment (limit to 200 characters): Breathing loss = 23.99 lbs VOC / yr (per EPA Tanks2) Working loss = 1248.11 lbs VOC / yr (per EPA Tanks2 program) Total estimated losses = 0.63 TPY, using estimated activity factor given above.



**J. CONTINUOUS MONITOR INFORMATION  
(Regulated Emissions Units Only)**

Information for Facility-ID : / Emission Unit #: 4  
Continuous Monitor #:

**Continuous Monitoring System**

1. Parameter Code:		
2. Pollutant(s):		
3. CMS Requirement Code(R/O):	Rule	/ Other
4. Monitor Information: Manufacturer: Model Number:		
Serial Number:		
5. Installation Date (DD-MON-YYYY):		
6. Performance Specification Test Date (DD-MON-YYYY):		
7. Continuous Monitor Comment (limit to 200 characters): Continuous monitors are not required for the emergency diesel generators.		

**K. PREVENTION OF SIGNIFICANT DETERIORATION (PSD) INCREMENT  
TRACKING INFORMATION  
(Regulated and Unregulated Emissions Units)**

Information for Facility-ID : 1 Emission Unit # : 4

**PSD Increment Consumption Determination**

1. Increment Consuming for Particulate Matter or Sulfur Dioxide?

If the emissions unit addressed in this section emits particulate matter or sulfur dioxide, answer the following series of questions to make a preliminary determination as to whether or not the emissions unit consumes PSD increment for particulate matter or sulfur dioxide. Check the first statement, if any, that applies and skip remaining statements.

Select (1-5) : 5

- [ 1 ] The emissions unit is undergoing PSD review as part of this application, or has undergone PSD review previously, for particulate matter or sulfur dioxide. Final determination is that emissions unit consumes increment.
- [ 2 ] The facility addressed in this application is classified as an EPA major source pursuant to paragraph (c) of the definition of "major source of air pollution" in Chapter 17-213, F.A.C., and the emissions unit addressed in this section commenced (or will commence) construction after January 6, 1975. Preliminary determination is that baseline emissions are zero, and emissions unit consumes increment.
- [ 3 ] The facility addressed in this application is classified as an EPA major source, and the emissions unit began initial operation after January 6, 1975, but before December 27, 1977. Preliminary determination is that baseline emissions are zero, and emissions unit consumes increment.
- [ 4 ] For any facility, the emissions unit began (or will begin) initial operation after December 27, 1977. Preliminary determination is that baseline emissions are zero, and emissions unit consumes increment.
- [ 5 ] None of the above apply. If so, the baseline emissions of the emissions unit are nonzero. In such case, additional analysis, beyond the scope of this application, is needed to determine whether changes in emissions have occurred (or will occur) after the baseline date that may consume or expand increment.

2. Increment Consuming for Nitrogen Dioxide?

If the emissions unit addressed in this section emits nitrogen oxides, answer the following series of questions to make a preliminary determination as to whether or not the emissions unit consumes PSD increment for nitrogen dioxide. Check first statement, if any, that applies and skip remaining statements.

Select (1-5) : 5

- [ 1 ] The emissions unit addressed in this section is undergoing PSD review as part of this application, or has undergone PSD review previously, for nitrogen dioxide. Final determination is that emissions unit consumes increment.
- [ 2 ] The facility addressed in this application is classified as an EPA major source pursuant to paragraph (c) of the definition of "major source of air pollution" in Chapter 17-213, F.A.C., and the emissions unit addressed in this section commenced (or will commence) construction after February 8, 1988. Preliminary determination is that baseline emissions are zero, and emissions unit consumes increment.
- [ 3 ] The facility addressed in this application is classified as an EPA major source, and the emissions unit began initial operation after February 8, 1988, but before March 28, 1988. Preliminary determination is that baseline emissions are zero, and emissions unit consumes increment.
- [ 4 ] For any facility, the emissions unit began (or will begin) initial operation after March 28, 1988. Preliminary determination is that baseline emissions are zero, and emissions unit consumes increment.
- [ 5 ] None of the above apply. If so, the baseline emissions of the emissions unit are nonzero. In such case, additional analysis, beyond the scope of this application, is needed to determine whether changes in emissions have occurred (or will occur) after the baseline date that may consume or expand increment.

3. Increment Consuming/Expanding Code: (C, E, U- unkown):		
PM	U	
SO2	U	
NO2	U	
4. Baseline Emissions:		
PM	lbs/hr	tons/yr
SO2	lbs/hr	tons/yr
NO2	tons/yr	

5. PSD Comment (limit to 200 characters):

**L. EMISSIONS UNIT SUPPLEMENTAL INFORMATION  
(Regulated Emissions Units Only)**

Information for Facility-ID : 1 Emission Unit # : 4

**Supplemental Requirements for All Applications**

1. Process Flow Diagram : PSNU4_1.bmp Attached Document ID / Not Applicable / Waiver Requested
2. Fuel Analysis or Specification: PSNU4_2.txt Attached Document ID / Not Applicable / Waiver Requested
3. Detailed Description of Control Equipment : Not Applicable Attached Document ID / Not Applicable / Waiver Requested
4. Description of Stack Sampling Facilities : Not Applicable Attached Document ID / Not Applicable / Waiver Requested
5. Compliance Test Report : Not Applicable Attached Document ID / Previously submitted, Date / Not Applicable
6. Procedures for Startup and Shutdown : PSNU4_6.doc Attached Document ID / Not Applicable
7. Operation and Maintenance Plan : NA Attached Document ID / Not Applicable
8. Supplemental Information for Construction Permit Application : NA Attached Document ID / Not Applicable
9. Other Information Required by Rule or Statute : NA Attached Document ID / Not Applicable



**Additional Supplemental Requirements for Category I Applications Only**

10. Alternative Methods of Operation : Not Applicable Attached Document ID / Not Applicable
11. Alternative Modes of Operation (Emissions Trading) : NA Attached Document ID / Not Applicable
12. Identification of Additional Applicable Requirements : Attached Document ID / Not Applicable
13. Enhanced Monitoring Plan : Not Applicable Attached Document ID / Not Applicable
14. Acid Rain Permit Application  Acid Rain Application - Phase II (Form No. 17-210.900(1)(a)) Attached Document ID: Not Applicable  Repowering Extension Plan (Form No. 17-210.900(1)(b)) Attached Document ID: Not Applicable  New Unit Exemption (Form No. 17-210.900(1)(c)) Attached Document ID: Not Applicable  Retired Unit Exemption (Form No. 17-210.900(1)(c)) Attached Document ID: Not Applicable  Not Applicable

**ATTACHMENT PSN - FW**

**LIST OF UNREGULATED TRIVIAL AND DE MINIMIS EMISSION UNITS**

Following are several pages of unregulated trivial and de minimis emission units and activities at the facility. The trivial activities identified in this application are provided for information only and are identified as examples of, but not limited to, the trivial activities identified by the Division of Air Resources Management's (DARM) guidance. It is understood that such activities do not have to be included in with the Title V Application. The trivial activities identified herein are consistent, in terms of amounts of emissions and types, with those activities listed in DARM's guidance.

Pursuant to Rule 62-210.300(3)(b)1., notice is herein provided that the emissions units listed below are not subject to a permit issued by the Department of Environmental Protection and are exempt from permitting until a final determination is made under the Title V permitting requirements (Rule 62-213 F.A.C.). These units would not have triggered review under Rules 62-212.400 or 62-212.500 or any new source performance standard listed in Rule 62-204.800 F.A.C.

ATTACHMENT PSN - FW

LIST OF UNREGULATED TRIVIAL OR DEMINIMIS EMISSION UNITS

UNIT 3 BOILER/STEAM GENERATOR POWER BLOCK

Steam Systems

Steam Air Heater-1" Vent

Extraction Heater Relief Valves

Extraction Heater Vents

Priming Ejector Exhaust head-8" Vent

Hogging Ejector 8" Vent

After Condenser 4" Vent

After Condenser ¼" Vent

Gland Steam Controller 8" Relief Valves

Evaporator Relief Valve

Evaporator Vent

Desuper Heater 12" Relief Valve

Economizer Inlet Header 1" Vents

Reheater Inlet Header Relief Valves

Reheater Outlet Header 6" Relief Valve

Secondary Super Heater Outlet Header Relief Valves

Main Steam-1" By-Pass Vent

Steam Drum Relief Valves w/Silencers

Steam Drum Vents 1½"

Ash Removal

Sump

ATTACHMENT PSN - FW

LIST OF UNREGULATED TRIVIAL OR DEMINIMIS EMISSION UNITS

Boiler Feed, Condensate & Heater Drain Systems

Boiler Feed Pumps ¾" Relief Valves

Condensate Pumps Vents

Condensate Storage Tank (60,000 Gal.) Vent

Gland Seal Condenser Fan 6" Vent

Gland Seal Condenser ½" Vents

Condensate Recovery Tank (26,000 Gal.) Vents

Condensate Collecting Cooler-¾" Vent

Vent Condenser ½" Vent to Atmosphere

Flash Tank-3" Relief Valve

Drip Tank Vent to

Evaporator 1" Vent from Tubes

Phosphate Pumps Relief Valves

Sulphite Pumps Relief Valves

Service/Cooling Water

Bearing Cooling Water Surge Tank 3" Vent

Bearing Cooling Water Heat Exchanger ¾" Vent

Bearing Cooling Water Heat Exchanger Relief Valve

Hydrogen Cooler ½" Vent

Turbine Lube Oil Coolers ¾" Vent

Gas Chlorinator ½" Vent

50,000 Gal. Rain Water Tank 6" Vent

Coagulator Tank

Clearwell Tank

Sludge Sump

Chemical Feed Pump ¼" Relief Valve

ATTACHMENT PSN - FW

LIST OF UNREGULATED TRIVIAL OR DEMINIMIS EMISSION UNITS

Oil Systems

Fuel Oil Storage Tank (100,000 BBL) Vents

Oil Recovery Blowback Drum Relief Valve

Oil Recovery Blowback Drum Service Air  $\frac{3}{4}$ " Vent to Atmosphere

Fuel Oil Transfer Heater  $\frac{3}{4}$ " Vent to Atmosphere

Light Oil Tank (1,000 BBL) Vents

Fuel Oil Day Tanks (6,000 BBL) Vent

Fuel Oil Day Tanks Suction Heater Vent

Lube Oil Reservoir Vapor Extractor 4" Vent to Atmosphere

Lube Oil Coolers  $\frac{3}{4}$ " Vents to Atmosphere

Fuel Oil Strainer  $\frac{1}{2}$ " Vents to Atmosphere

Fuel Oil Booster Pumps  $\frac{3}{4}$ " Vents

Lube Oil Pump Tank 1" Vent

Transfer Oil Tanks (10,000 Gal.) Vent (Abandoned)

Loop Seal Tank Oil Vapor Extractor - 4" Exhaust head

Misc. Lube Oil Relief Valves

Misc. Lube Oil Vents

Turbine Generator

Generator Venting

C.E.M. Equipment

Monitoring Gases

ATTACHMENT PSN - FW

LIST OF UNREGULATED TRIVIAL OR DEMINIMIS EMISSION UNITS

Steam & Heater Drains

Steam Drum 6" & 2" Relief Valves

Cold Reheat 8" & 10" Relief Valves

Main Steam 6" & 4" Relief Valves

Main Steam Blowdown & Vent

Boiler Feedwater 1" Vents

Control Building Heating Steam Relief Valve

Steam Relief Valves 10" & 2"

Heater 2" & ½" Vents

Heater 1" & 4" Relief Valves

Heater Drains ¾" Vents

Condensate & Feedwater

Condensate Storage Tank Vent

Condensate Recovery Pump ½" Vent

Boiler Feedwater Pump 1" Relief Valves

Inter-condenser 1" Relief Valve

Gland Steam Condenser 1" Relief Valve

Condensate Recovery Flash Tank 8" Relief Valve

Condensate Recovery Tank 4" Vents

Recovery Drain Cooler ¾" Vent

Condensate Recovery Vent Condenser ¾" Vent

Blowdown Tank 16" Vent

Condensate Sump Pits

Condensate ¾" Vents

ATTACHMENT PSN - FW

LIST OF UNREGULATED TRIVIAL OR DEMINIMIS EMISSION UNITS

Service/Instrument Air

Service Air Aftercooler Relief Valve

Service Air Receiver Relief Valve

Instrument Air Aftercooler Relief Valve

Instrument Air Receiver Relief Valve

Service Water

Well Pumps Casing Vents 4"

Groundwater Storage Tank Vent

Elevated Water Storage Tank Vent

1" Service Water to Control Building Relief Valve

Service Water to Lab Building 1" Relief Valve

Caustic Wash & Lime Slurry

1" Condensate Relief Valve

Steam Coil Supply Caustic Mix Tank 3" Relief Valve

Ash Sump

Lime Slurry Pumps Gland Seal Water 1" Relief Valve

Caustic Wash Service Tank 2" Vent

Turbine Generator

Turbine Lube Oil Reservoir Demister 6" Vent

Lube Oil Conditioner Vent Fan

Gland Steam Condenser Fan 6" Vent

Generator Hydrogen 2" Vent

Hydrogen Seal Oil Vapor Extractor 4" Vent

Chlorination Circ. Water

Chlorinator 1/2" Vent

Evaporator 1" Vent

ATTACHMENT PSN - FW

LIST OF UNREGULATED TRIVIAL OR DEMINIMIS EMISSION UNITS

Air Evacuation

Priming Ejector 10" Exhaust Head

Vacuum Tank Drain Bottle Vent

Water Box Vacuum Pumps Snubber Vents

Cooling Water

F.D. Fan Cplg. Cooler ¾" Vents

I.D. Fan Cplg. Cooler ¾" Vents

Exciter Coolers ¾" Vent

Circ. Water Pumps Condenser Inlet Vents

BFP Cplg. Coolers ¾" Vent

Closed Cooling Waster Pumps ¾" Vent

Closed Cooling Water

Chemical Feed Tank Vent

Nitrogen Purge System

Relief Valve to Atmosphere

Steam Drum Header 1" Vent

Reheater Outlet Header 1" Vent

Pendant Outlet Header 1" Vent

Lime Slurry

Lime Slurry Mixing Tank

Lime Slurry Service Tank

Chemical Feed

Cyclohexylamine Solution Tanks Vent

Hydrazine Solution Tanks Vent

Phosphate Solution Tanks Vent



ATTACHMENT PSN - FW

LIST OF UNREGULATED TRIVIAL OR DEMINIMIS EMISSION UNITS

Fuel Oil

Storage Tanks (268,000 BBL) Conservation Type Vent to Atmosphere

Metering Tanks (12,000 BBL) Vent to Atmosphere

Fuel Oil Unloading Pump Vent

Fuel Oil Unloading Pump Strainer Vent

Fuel Oil Transfer Pumps Strainer Vent

Fuel Oil Burner Pumps Strainer Vent

Fuel Oil Burner Pump Vents

Fuel Oil Transfer Heater " Vents

Blowback Tank at Metering Tank Relief Valve

Blowback Tank at Burner Pumps Relief Valves

Blowback Tank at Burner Heaters Relief Valve

Blowback Tanks at Burner Front

Burner Booster Pump Strainers " Vent

Light Oil Pumps Vent

Light Oil Pump Strainer Vents

Diesel Day Tank

(Gal) 2" Vent to Atmosphere

Storage Tanks Draw Off Sumps

Miscellaneous Storage Tanks

Orimulsion Slop Tank Vent

Gas Metering Area

Miscellaneous Relief Valves

L.P. Gas

Tanks Relief Valve

Turbine Generator

Generator Venting

ATTACHMENT PSN - FW

LIST OF UNREGULATED TRIVIAL OR DEMINIMIS EMISSION UNITS

C.E.M. Equipment  
Monitoring Equipment

→ Diesel Generators  
500 kW fixed diesel generator, 3.4 mmBtu/hr

→ 500 kW mobile diesel generator, 4.6 mmBtu/hr

Miscellaneous Activities

Home Heating and Comfort Heating with a gross maximum heat output of less than one million BTU/hour

Internal combustion engines in boats, aircraft and vehicles used for transportation of passengers or freight.

Vacuum Pumps used in laboratory operations

Equipment used for steam cleaning

Belt or drum sanders having a total sanding surface of five square feet or less and other equipment used exclusively on wood or plastics or their products having a density of 20 pounds per cubic foot or more.

Equipment used exclusively for space heating, other than boilers

Laboratory equipment used exclusively for chemical or physical analysis

Brazing, soldering or welding equipment

Laundry dryers, extractors, or tumblers for fabrics cleaned with only water solutions of bleach or detergents

Fire & Safety equipment

Surface coating facilities in ozone attainment areas (provided that 6.0 gallons of coatings per day are applied)

Degreasing units using heavier-than-air vapors exclusively, except any such unit using or emitting any substance classified as a hazardous air pollutant

Miscellaneous welding and cutting operations

Compressed Air

Argon

Acetylene

Oxygen

**ATTACHMENT PSN - FW**

**LIST OF UNREGULATED TRIVIAL OR DEMINIMIS EMISSION UNITS**

Miscellaneous Activities

Plant Grounds Maintenance

Routine Maintenance / Repair Activities

Non-Halogenated Solvent Cleaning Operations

Use of spray cans & solvents for maintenance activities

Internal Combustion Engines Which Drive Compressors, Generators, Water Pumps or other Auxiliary Equipment

Transformers, Switches and Switchgear, Processing & Venting

Electrically Heated Equipment Used for Heat Treating, Tracing, Drying, Soaking, Case Hardening or Surface Conditioning

Air Compressors and Centrifuges Used for Compressing Air  
Storage of Product in Sealed Containers

Painting of Plant Equipment

Removal of paint & rust with baking soda blaster (high pressure water & baking soda)

Miscellaneous Mobile Vehicle Operation

Cars, Light Trucks, heavy Duty Trucks, Back Hoes, Tractors, Forklifts, Cranes, Etc.

Miscellaneous Mobile Equipment Operation

Compressors, Chain Saws, Small Generators, (<100kw) Welding Machines, Electric Saws & Drills, Etc.

ATTACHMENT PSN - FW

LIST OF UNREGULATED TRIVIAL OR DEMINIMIS EMISSION UNITS

Water Treatment

Acid Storage Tank (10,000 Gal) "Vent

Acid Storage Tank Dri-Breather Vent

Muriatic Acid Storage 55 Gal. Drums (Sealed)

Caustic Storage Tank (10,000 Gal) "Vent-

Caustic Storage Tank Vent -1 ½"

Brine Measuring Tank

Brine Solution Heat Exchanger Relief Valve

Brine Solution Heater Exchange Vent

Lime Tank Vent

Alum Tank Vent

Caustic Dilution Water Heat Exchanger Relief Valve

Cation Units 1" Vent

Organic Scavengers 1" Vent

Anion Units Vent

Mixed Bed Units Vent ¾"

Coagulator Tank

Clearwell Tank

Sand Filters Vent

Sand Filters Back Wash Sump

Mixed Bed Units Air Blower Discharge

Water Treatment Chemical Storage

Chlorinator & Chlorine Cylinders (3)

Lime Slurry Mixing Tank

Caustic Mix Tank

ATTACHMENT PSN - FW

LIST OF UNREGULATED TRIVIAL OR DEMINIMIS EMISSION UNITS

Waste Water Treatment

Polymer Concentrate 55 Gal. Drum

Sodium Hydroxide Caustic Feed Tank

Sulfuric Acid Feed Drums

P.H. Adjustment Tank

Lamella Flash Mix Tank

Sludge Transfer Pumps Relief Valves

Storm Water Treatment System

Storm Water Sumps

Oil/Water Seperator

Tank Vent

Waste Neutralization Basin

Storm Water Basin

Solids Settling Basins "A & B"

Ash Disposal Basin

WALKDOWN INFORMATION	ORG	BY	DATE
	AS-BUILT INFORMATION		
TECHNICAL ACCEPTANCE	ENGINEERING ORGANIZATION	BY	DATE

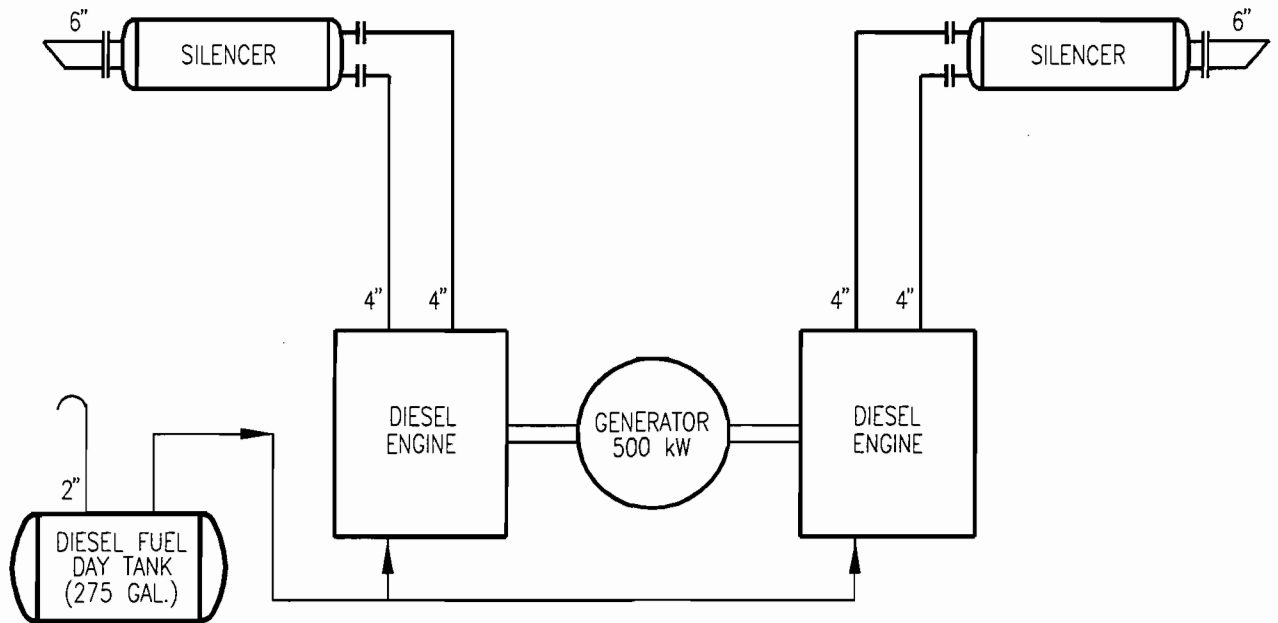

BAR CODE

0	7/17/95	ISSUED FOR TITLE V PERMIT	PWB	PWB	CSP	CSP	ETS
REV	DATE	REVISION DESCRIPTION	BY	CH	COR	APR	ORG

	SYSTEM	YY	DISCIPLINE	M	PLANT/UNIT	SANFORD PLANT				
	SCALE	N/A	CAD FILE NAME	SN004412	TITLE	EMISSION UNIT FLOW DIAGRAM				
	DRAWING SIZE	A (8.5X11)	FPL ARCHIVE NAME	SN004412	TITLE	EMERGENCY DIESEL GENERATOR				
DRAWING NUMBER					PSN3-M0106-YY		SHEET	1 OF 1	REV	0

## Fuel Analysis

Light Distillate oil (typical)\*

<u>Parameter</u>	<u>Typical value</u>	<u>Specifications</u>
API gravity (@ 60 F)	35.0 <sup>2</sup>	30 - 40 <sup>1</sup>
Heat content (MBtu/bbl)	5,700 - 5,800 <sup>2</sup>	none
% sulfur	0.3 - 0.5 <sup>1</sup>	0.5 maximum <sup>1</sup>
% nitrogen	no specification	none
% ash	<0.01 <sup>2</sup>	0.01 <sup>1</sup>

Footnotes:

- (1) Data taken from FPL fuel specifications.
- (2) Data taken from laboratory analysis.
- (3) The values are "typical" based upon the following:
  - Information gathered by FPL through laboratory analysis, and
  - FPL's fuel purchasing specifications. It should be noted that the analytical results obtained from grab samples taken at any given time may vary from those listed.

## Attachment PSNU4\_6.txt

### Procedures for Startup / Shutdown

The emergency diesel generator is the main backup power supply component for the fossil steam boiler generating units. The function of the emergency diesel generator is to supply electric power to key power plant equipment during emergency loss-of-power situations. This equipment is typically test-run on a monthly basis to ensure that it will function properly when needed in an emergency.

Startup for the emergency diesel generator begins with actuating a switch which sends an electric signal to a starter motor on the diesel engine which "turns over" the diesel engine until ignition of the diesel fuel commences.

Shutdown is performed when the normal electric power supply to plant equipment is restored. Shutdown is performed by shutting off the diesel fuel supply to the emergency diesel generator.

Best Operating Practices include proper maintenance of the diesel engine on the generating unit, and monitoring the visible emissions from the emergency diesel generator to ensure that the opacity limitation is not exceeded. All efforts to minimize both the level and duration of excess emissions are undertaken.