

#4: Rated Capacity 360,000 lbs/hr steam

415 MM Btu/hr Heat
Input

PREVENTION OF SIGNIFICANT DETERIORATION
ANALYSIS FOR THE
PROPOSED GEORGIA-PACIFIC
PLANT MODIFICATION

Prepared for:

GEORGIA-PACIFIC CORPORATION
Palatka, Florida

Prepared by:

ESE, INC.
Gainesville, Florida

June 1981

ESE No. 81-128-100

TABLE OF CONTENTS

<u>Section</u>		<u>Page</u>
1.0	<u>SUMMARY</u>	1-1
2.0	<u>PROJECT DESCRIPTION</u>	2-1
3.0	<u>AIR QUALITY REVIEW REQUIREMENTS</u>	3-1
	3.1 AMBIENT AIR QUALITY STANDARDS	3-1
	3.2 PREVENTION OF SIGNIFICANT DETERIORATION	3-3
	3.2.1 <u>General Requirements</u>	3-3
	3.2.2 <u>Source Applicability</u>	3-7
	3.3 GOOD ENGINEERING PRACTICE STACK HEIGHT	3-15
4.0	<u>ATMOSPHERIC DISPERSION MODELING METHODOLOGY</u>	4-1
	4.1 COMPUTER MODELS	4-4
	4.2 METEOROLOGY	4-5
	4.3 EMISSIONS INVENTORY	4-5
	4.4 AIR QUALITY IMPACT DETERMINATION	4-7
	4.5 INCREMENT CONSUMPTION DETERMINATION	4-7
	4.6 DOWNWASH METHODOLOGY	4-10
5.0	<u>AMBIENT AIR MONITORING</u>	5-1
6.0	<u>AIR QUALITY IMPACT RESULTS</u>	6-1
	6.1 AIR QUALITY STANDARDS	6-1
	6.1.1 <u>Particulate Matter</u>	6-1
	6.1.2 <u>Sulfur Dioxide</u>	6-1
	6.1.3 <u>Nitrogen Oxides and Carbon Monoxide</u>	6-1
	6.2 INCREMENT CONSUMPTION	6-2
	6.3 CLASS I IMPACTS	6-3
	6.4 DOWNWASH	6-3
7.0	<u>ADDITIONAL IMPACTS ON SOILS, VEGETATION, AND VISIBILITY</u>	7-1
	7.1 IMPACTS ON SOILS AND VEGETATION	7-1
	7.2 VISIBILITY IMPACTS	7-2
8.0	<u>CONCLUSIONS</u>	8-1

REFERENCES

APPENDIX A--CONSTRUCTION PERMIT APPLICATIONS
APPENDIX B--CALCULATION OF CONTEMPORANEOUS EMISSION REDUCTIONS
APPENDIX C--COMPUTER MODEL PRINTOUTS

LIST OF TABLES

<u>Table</u>		<u>Page</u>
2-1	Stack Parameters for G-P Existing and Proposed Sources	2-2
2-2	Projected Emissions from Proposed Sources for the G-P Plant Modification	2-3
3-1	National and State of Florida AAQS Applicable to the Proposed G-P Modification	3-2
3-2	Significant Emission Rates and <u>De Minimis</u> Air Quality Impact Levels	3-4
3-3	Federal and State of Florida PSD Allowable Increments	3-6
3-4	PSD Regulations Applicable to the Proposed G-P Modification	3-8
3-5	Comparison of EPA Contemporaneous Emission Reductions with Proposed Emissions for G-P Paper Mill Modification	3-11
3-6	List of Key Dates for the Proposed G-P Modification	3-12
3-7	Building Dimensions for Major Influencing Structures at G-P Palatka Paper Mill	3-16
4-1	Short-Term Modeling Case Runs and Meteorological Periods	4-6
4-2	Modeled Sources and Emissions for G-P Proposed Modification	4-8
6-1	Proposed G-P Mill Modification; Maximum Annual and Highest, Second-Highest Short-Term Predicted Concentrations	6-2
6-2	Summary of PSD Increment Consumption Results: Proposed G-P Modification	6-4

LIST OF FIGURES

<u>Figure</u>		<u>Page</u>
4-1	Flow Diagram for the Application of Atmospheric Dispersion Models	4-2
5-1	Location of Existing Ambient Monitors and Proposed Georgia-Pacific Monitoring Stations	5-2

1.0 SUMMARY

Georgia-Pacific Corporation (G-P) is proposing to construct and operate five new sources of air pollutants at its existing kraft pulp mill near Palatka, Florida (see Figure 5-1 in Section 5 of this report). These new sources will include a recovery boiler and associated smelt tanks (2), a lime kiln, and a combination boiler fired by bark and peat. The proposed modification at the G-P mill will double production to 2,400 tons per day of unbleached pulp.

The State of Florida Department of Environmental Regulation (DER) and United States Environmental Protection Agency (EPA) have promulgated regulations concerning the Prevention of Significant Deterioration (PSD). All new major sources of air pollution must undergo a PSD review to determine if significant deterioration will be caused by the proposed new source. The proposed action is subject to both state and federal PSD regulations by virtue of an increase over specified emission levels for several air pollutants.

In response to these requirements, G-P contracted ESE, Inc. to perform a PSD analysis for the proposed action. The analysis was conducted using suggested and approved EPA and Florida DER atmospheric dispersion models and modeling techniques. Results showed that allowable PSD increments and State of Florida Ambient Air Quality Standards (AAQS) would not be violated as a result of the increased operating capacity of the mill. The analysis was based on maximum predicted emissions from the proposed and existing units.

Best Available Control Technology (BACT) for all affected pollutants will be met using appropriate control techniques and proper operation and maintenance procedures for the proposed modification. A BACT analysis is presented in the construction permit applications, which are submitted concurrently with this report to the State of Florida for state and federal review (see Appendix A).

Operation of the mill with the proposed additions functioning is not expected to have a significant impact upon visibility, soils, or vegetation, or on any area which has been designated Class I for PSD purposes. This report provides an evaluation of the PSD analysis and provides a complete description of the methods, data bases, results, and conclusions of the study.

6/1/81

2.0 PROJECT DESCRIPTION

This PSD report concerns the impact analysis for a proposed major modification to the existing G-P kraft pulp mill. Currently, two power boilers, a combination boiler and a recovery boiler are operating at the mill. In addition, there are two smelt tanks associated with the recovery boiler, and a lime kiln. The proposed action will add a recovery boiler and associated smelt tanks, a combination boiler, and a lime kiln. The new units at the Palatka mill will enable G-P to double the pulp production from the current rate and generate 2,400 tons per day of pulp.

The proposed combination boiler will burn peat and wood for steam production while the recovery boiler will burn black liquor solids. Fuel oil will be burned in these boilers only for startup, shutdown, emergencies, and system checking. The lime kiln uses lime mud (CaCO_3) in the process and also burns fuel oil. Site construction for the combination boiler is scheduled for December 1981 with completion targeted for 1983. Construction on the recovery boiler and lime kiln will begin approximately in September 1982, with completion scheduled for 1985.

Stack parameters for all G-P sources (existing and proposed) are presented in Table 2-1. The projected modeled emissions for the sources represent maximum capacity and maximum fuel usage. Emissions for the proposed sources are shown in Table 2-2. Emissions for existing sources are shown in Table 4-2 in Section 4. Maximum particulate emissions for the proposed combination boiler result from 100-percent bark firing, and maximum SO_2 emissions result from 100-percent peat firing.

Table 2-1. Stack Parameters for G-P Existing and Proposed Sources

Source	Stack Height (ft)	Stack Diameter (ft)	Flue Gas Temperature (°F)	Flue Gas Velocity (fps)
Power Boiler No. 4 (P.B. #4)	122	4.0	400	47.7
Power Boiler No. 5 (P.B. #5)	230	9.2	477	50.2
Combination Boiler No. 4 (Combo Blr #4)	230	10.0	400	34.5
Lime Kiln No. 4 (L.K. #4)	149	4.3	172	54.0
Recovery Boiler No. 4 (R.B. #4)	250	13.2	394	45.7
Smelt Dissolving Tanks No (4) (Smelt #4)	250	5.0	163	27.1
Proposed R.B. #5	250	13.2	394	45.7
Proposed L.K. #5	149	4.3	172	54.0
Proposed Combo Blr. #5	250	12.0	351	50.5
Proposed Smelt Tank Vents (Smelt #5)	250	5.0	163	27.1

Sources: ESE, 1981. G-P, 1981.

Table 2-2. Projected Emissions from Proposed Sources for the G-P Plant Modification

Source	Pollutant	Emissions		Allowable Emissions (lb/hr)	Potential Emissions	
		Maximum (lb/hr)	Actual (TPY)		(lb/hr)	(TPY)
Combination Boiler #5	Particulate	216.7	928	216.7	9,561	41,878 ✓
	SO ₂	653.6	2,206		654	2,863
	NO _x	255.0	981		255	1,117
	VOC	69.4	282		69	304
	CO	255.0	981		255	1,117
Recovery Boiler #5	Particulate	75.4	323.0	75.4	7,500	32,850
	SO ₂	250.0	1,071.0		250	1,095
	NO _x	89.1	381.7		89	390
	VOC	48.0	205.6		48	210
	CO	871.2	3,732.0		871	3,816
	TRS	5.2	22.3	5.2	650	2,847
Smelt Tank Vents #5	Particulate	15.0	64.3	15.0	250	1,095
	SO ₂	5.0	21.4		5	22
	TRS	1.3	5.4	1.3	22	96
Lime Kiln #5	Particulate	29.3	125.5	29.3	2,250	9,855
	SO ₂	10.0	42.8		15	66
	NO _x	93.8	402.0		94	411
	VOC	24.0	102.8		27	120
	CO	500.0	2,142.0		500	2,190
	TRS	1.1	4.7	1.1	38	164

Source: ESE, 1981.

3.0 AIR QUALITY REVIEW REQUIREMENTS

The following discussion pertains to air quality regulatory requirements that must be met for the major modification proposed by G-P. These requirements include demonstrating compliance with AAQS and PSD increment consumption.

3.1 AMBIENT AIR QUALITY STANDARDS

As a result of the requirements of the 1970 Amendments to the Clean Air Act (CAA), EPA enacted Primary and Secondary National AAQS (Federal Register, 1971) for six air pollutants. Primary National AAQS are required to protect the public health, and Secondary National AAQS are required to protect the public welfare from any known or anticipated adverse effects associated with the presence of pollutants in the ambient air.

Table 3-1 presents the existing applicable National and State of Florida AAQS. In January 1972, the State of Florida promulgated the Secondary National AAQS as the State AAQS. Since states have the discretion of adopting or maintaining more stringent ambient air quality standards than those established by EPA, the State of Florida has chosen to retain the annual AAQS and 24-hour secondary AAQS for sulfur dioxide (SO₂) that have been eliminated by EPA since 1971. Pollutants for which AAQS have been established are termed "criteria" pollutants.

Areas of the country in violation of any of the AAQS are designated as "nonattainment areas," and new or modified sources to be located in or near these areas may be subject to more stringent air permitting requirements than sources located in ~~non~~attainment areas. Putnam County is designated as an attainment area for all pollutants. However, Duval County, approximately 51 kilometers (km) to the north-northeast, has been designated as nonattainment for ozone (O₃), and the downtown Jacksonville area (approximately 71 km from G-P) in Duval County has been designated as nonattainment for particulate matter. No other areas within 100 km of the G-P site have been designated as nonattainment for any pollutant.

Table 3-1. National and State of Florida AAQS Applicable to the Proposed G-P Modification

Pollutant	Averaging Time	National		Florida
		Primary Standard	Secondary Standard	
Suspended Particulate Matter	Annual Geometric Mean	75 ug/m ³	60 ug/m ³	60 ug/m ³
	24-Hour Maximum*	260 ug/m ³	150 ug/m ³	150 ug/m ³
Sulfur Dioxide	Annual Arithmetic Mean	80 ug/m ³	NA†	60 ug/m ³
	24-Hour Maximum*	365 ug/m ³	NA†	260 ug/m ³
	3-Hour Maximum*	NA†	1,300 ug/m ³	1,300 ug/m ³
Carbon Monoxide	8-Hour Maximum*	10 mg/m ³	10 mg/m ³	10 mg/m ³
	1-Hour Maximum*	40 mg/m ³	40 mg/m ³	40 mg/m ³
Hydrocarbons	3-Hour Maximum* (6 to 9 A.M.)	160 ug/m ³	160 ug/m ³	160 ug/m ³
Nitrogen Dioxide	Annual Arithmetic Mean	100 ug/m ³	100 ug/m ³	100 ug/m ³
Ozone	1-Hour Maximum*	235 ug/m ³	235 ug/m ³	160 ug/m ³
Lead	Calendar Quarter Arithmetic Mean	1.5 ug/m ³	1.5 ug/m ³	NA†

* Maximum concentration not to be exceeded more than once per year.

† No standard exists.

Source: 40 CFR Part 50, 1980.

3.2 PREVENTION OF SIGNIFICANT DETERIORATION

3.2.1 General Requirements

Under federal PSD review requirements, all major new or modified sources of air pollutants regulated under the CAA must be reviewed and approved by EPA (or in this case, reviewed by Florida DER since technical and administrative review authority before final approval by EPA has been delegated to the state). A "major stationary source" is defined as any one of 28 named source categories which has the potential to emit 100 tons per year (TPY) or more, or any other stationary source which has the potential to emit 250 TPY or more, of any pollutant regulated under the Act. "Potential to emit" means the capability at maximum design capacity to emit a pollutant after the application of control equipment (40 CFR 52.21).

"Major modification" means any physical change in the design or operation of a major stationary source, or a series of contemporaneous changes in the design or operation of a major stationary source, that would result in a significant net increase in the source's potential to emit any pollutant subject to regulation under the CAA. (40 CFR 52.21). "Significant" is defined as any increase in emissions in excess of specified levels (Table 3-2).

The PSD review is used to determine whether significant air quality deterioration will result from the new or modified source. This section addresses PSD requirements contained in 40 CFR 52.21, Prevention of Significant Deterioration of Air Quality, and in the State of Florida PSD Regulations, Chapter 17-2, Florida Administrative Code. New major sources and modifications are required to undergo the following federal reviews related to PSD:

1. Control technology review,
2. Source impact analysis,
3. Air quality analysis (monitoring),

Table 3-2. Significant Emission Rates and De Minimis Air Quality Impact Levels

Pollutant	Significant Emission Rate (TPY)	<u>De Minimis</u> Air Quality Impact Level
Carbon Monoxide	100	575 ug/m ³ , 8-hour average
Nitrogen Dioxide	40	14 ug/m ³ , 24-hour
Total Suspended Particulates	25	10 ug/m ³ , 24-hour
Sulfur Dioxide	40	13 ug/m ³ , 24-hour
Ozone*	40	
	(volatile organic compounds)	
Lead	0.5	0.1 ug/m ³ , 3-month
Mercury	0.1	0.25 ug/m ³ , 24-hour
Beryllium	0.0004	0.0005 ug/m ³ , 24-hour
Asbestos	1	†
Fluorides	3.0	0.25 ug/m ³ , 24-hour
Sulfuric Acid Mist	7	†
Vinyl Chloride	1.0	15 ug/m ³ , maximum value
Total Reduced Sulfur		
Hydrogen sulfide	10	10 ug/m ³ , 1-hour
Reduced Sulfur Compounds (including H ₂ S)	10	10 ug/m ³ , 1-hour
Hydrogen sulfide	10	0.023 ug/m ³ , 1-hour
Benzene	0	0
Radionuclides	0	0
Inorganic Arsenic	0	0

* A de minimis air quality level is not given for ozone. However, a plant which is subject to PSD review and has a net increase of 100 TPY of volatile organic compounds would be required to perform an ambient air quality analysis.

† No satisfactory monitoring technique available at this time.

Source: EPA, 1980, 40CFR Part 52, Section 52.21.

4. Source information, and
5. Additional impact analyses.

The control technology review includes determination of BACT for each applicable pollutant. BACT information is contained in the DER construction permit application submitted concurrently with this report (see Appendix A).

Source impact analysis requires demonstration of compliance with federal and state AAQS and allowable increment limitations (see Table 3-3). Projected ambient impacts upon designated nonattainment areas and federally promulgated Class I PSD areas must also be addressed. The monitoring portion of PSD review requires that an analysis of continuous ambient air monitoring data be performed for the impact area of the proposed source. Source information, including process design parameters and control equipment information, must be submitted to the reviewing agencies. Additional analyses of the proposed source's impact upon soils, vegetation, and visibility, especially pertaining to Class I PSD areas, must be performed.

The PSD regulations specifically require the use of atmospheric dispersion models in performing impact analyses, estimating baseline and future air quality levels, and determining compliance with AAQS and allowable PSD increments. Guidance for the use and application of dispersion models is presented in the EPA publication, "Guideline on Air Quality Models" (EPA, 1978a). (Note: Recently, EPA held conferences and distributed revised guidelines in draft form.) The models used in the PSD analysis for G-P were the long-term (ISCLT) and short-term (ISCST) Industrial Source Complex models.

Various lengths of record for meteorological data can be used for short-term modeling. A 5-year period can be used with corresponding evaluation of highest, second-highest concentrations for comparison to AAQS or PSD increments. The term "highest, second-highest" refers to

Table 3-3. Federal and State of Florida PSD Allowable Increments
(ug/m³)

Pollutant/Averaging Time	Class		
	I	II	III
Particulate Matter			
Annual Geometric Mean	5	19	37
24-Hour Maximum*	10	37	75
Sulfur Dioxide			
Annual Arithmetic Mean	2	20	40
24-Hour Maximum*	5	91	182
3-Hour Maximum*	25	512	700

* Maximum concentration not to be exceeded more than once per year.

Sources: Public Law 95-95, Clean Air Act Amendments of 1977.
Federal Register, Vol. 43, No. 118, June 19, 1978.

the highest at all receptors of the second-highest concentrations (i.e., the highest concentration at each receptor is discarded). The second-highest concentration is significant because the short-term AAQS specify that the level should not be exceeded at any location more than once a year. If less than 5 years of meteorological data are used, the highest concentration at any location must be used.

Florida DER has promulgated PSD regulations similar to those of EPA. Table 3-4 presents the applicable PSD regulations of Florida DER and EPA. Some important differences between the state and federal review requirements exist. The first is in the definition of "potential to emit," which determines if a new or modified source is "major" and therefore subject to PSD review. EPA defines "potential to emit" as emissions after control, and takes into account any decrease in emissions due to the application of control equipment which has been incorporated into the design of the source. Florida DER defines "potential emissions" as those emissions before the application of control equipment, unless such equipment is an inherent part of the process. The second major difference is in the EPA and Florida DER definition of "baseline" air quality. The following discussions describe in more detail the PSD requirements for the state and federal regulations, including the difference in baseline analysis.

3.2.2 Source Applicability

DER Review

The level of PSD analysis required for state review is based on the quantity of projected emissions from the modification. Pollutants from the proposed action with potential emissions (prior to control) in excess of 100 TPY are subject to PSD review. As Table 2-2 shows, the proposed action exceeds this amount for all pollutants listed therein. As such, a demonstration of air quality impacts and PSD increments is required. With regard to BACT, under DER rules for a PSD source, no increase in pollutant concentrations over the baseline will be allowed unless BACT is employed to control emissions from the facility.

5/27/81

Table 3-4. PSD Regulations Applicable to the Proposed G-P Modification

Requirement	Federal Regulation*	State of Florida Regulation†
General Source Applicability	40 CFR 52.21(i)	FAC 17-2.04(1)
Control Technology Review	40 CFR 52.21(j)	
New Source Performance Standards	40 CFR 52.21(j)(1)	FAC 17-2.03(1)(a)
Best Available Control Technology	40 CFR 52.21(j)(2)	FAC 17-2.04(6)(c)
Source Impact Analysis	40 CFR 52.21(k)	
Ambient Air Quality Standards	40 CFR 52.21(k)(1)	FAC 17-2.04(6)(a)
Allowable Increments	40 CFR 52.21(k)(2)	FAC 17-2.04(6)(a)
Air Quality Analysis (Monitoring)	40 CFR 52.21(m)	
Source Information	40 CFR 52.21(n)	FAC 17-2.04(6)(a)
Stack Heights	40 CFR 52.21(h)	
Additional Impact Analyses	40 CFR 52.21(o)	
Public Participation	40 CFR 52.21(q)	FAC 17-2.04(9)
Referenced Requirements		
Best Available Control Technology	40 CFR 52.21(b)(10)	FAC 17-2.03
Ambient Air Quality Standards	40 CFR 50	FAC 17-2.06(1)
Allowable Increments	40 CFR 52.21(c)	FAC 17-2.04(1)

* CFR = Code of Federal Regulations, 1980.

† FAC = Florida Administrative Code, Chapter 17-2, Supplement 101.

Sources: Code of Federal Regulations, 1980.

Florida Administrative Code, Chapter 17-2, Supplement 101.

As shown in the modeling analysis included with this report, no net increase in TSP concentrations is predicted over the baseline concentration. In addition, because of the large estimated decrease in TRS emissions, since the baseline, it can be assumed that no increase over the baseline for TRS has occurred.

In Chapter 17-2.03, Florida Administrative Code, it is required that a BACT determination be made following receipt of a permit to construct a major emitting facility which does not have an emission limiting standard in Section 17-2.05 or which is subject to BACT under 17-2.04. Since the proposed Combination Boiler #5 and Recovery Boiler #5 have a particulate emission limiting standard in Chapter 17-2.05, and the proposed Recovery Boiler #5 has a TRS emission limiting standard, and no increase over the baseline is predicted for these pollutants, BACT is not applicable to particulate and TRS emissions from these sources. A BACT analysis was conducted for all other pollutants listed in Table 2-2 and is contained in the construction permit application for each appropriate source (see Appendix A).

Baseline--State of Florida

For PSD purposes, the State of Florida has defined baseline concentration as:

For sulfur dioxide and particulate matter, the applicable ambient concentration levels existing during 1974 plus any additional concentrations for the area of impact estimated to result from sources permitted for construction but not operating prior to January 1, 1975 . . . In the case of the 3-hour and 24-hour concentrations, only the second highest concentrations shall be considered [Florida Administrative Code, Chapter 17-2.02(14)].

In October 1978, the Florida DER Bureau of Air Quality Management published "Guidelines on Prevention of Significant Deterioration (PSD)--PSD Review." The document states: "Baseline emissions data consist of

the January 1, 1975 allowable emission rates and January 1, 1975 stack configurations for all sources holding either an operating or construction permit during any part of 1974." As a result, Florida DER requires the formal establishment of a baseline concentration level. Because of the adopted definition, only modeling can be used to determine the baseline levels.

EPA Review

Under EPA regulations for PSD, the level of analysis required for a new major source or major modification is based on the net emissions increases in comparison with significant emission levels presented in Table 3-2. For a particular pollutant, a net increase in emissions due to a new major source or modification of a major source which is greater than the appropriate de minimis level would impose compliance with BACT, an air quality and PSD increment impact analysis, and preconstruction monitoring and the other PSD requirements listed in Table 3-4 for that pollutant.

The net emissions increase for a modification is determined after consideration of contemporaneous changes in actual emissions. A decrease in actual emissions may be credited only if it occurs after the date of 5 years prior to the commencement of construction (on the modification) (Federal Register, Vol. 45, No. 154, pp. 52701).

Certain contemporaneous emission decreases have occurred at G-P for which reduction credit is taken. The final year of operation for Recovery Boilers (RB) No. 1, 2, and 3, and the associated smelt tanks, was 1976. The 5-year period prior to the projected date on the commencement of construction (December 1981) began in December 1976. Therefore, emissions from RB Nos. 1, 2, and 3 and the associated smelt tanks are contemporaneous (see Table 3-6). These emissions are shown in Table 3-5 and are compared with the proposed sources. The existing sources at G-P are not included in the comparison because the normal operation, and therefore the annual emissions, will not change. As the

Table 3-5. Comparison of EPA Contemporaneous Emission Reductions With Proposed Emissions For G-P Paper Mill Modification

	Emissions (TPY)					
	TSP	SO ₂	CO	NO ₂	VOC	TRS
<u>EPA Contemporaneous Reduction Sources</u>						
Recovery Boiler #1	331	207	1,282	126	21	537
Recovery Boiler #2	423	296	1,832	180	30	768
Recovery Boiler #3	458	286	1,766	174	29	745
Smelt Tanks #1	10	4	—	—	—	19
Smelt Tanks #2	15	6	—	—	—	26
Smelt Tanks #3	14	6	—	—	—	25
Totals	1,251	805	4,880	480	80	2,120
<u>Proposed Sources</u>						
Lime Kiln #5	126	43	2,142	402	103	5
Recovery Boiler #5	323	1,071	3,732	382	206	22
Smelt Tanks #5	15	21	—	—	—	5
Combination Boiler #5	928	2,206	981	981	282	—
Totals	1,392	3,341	6,855	1,765	591	32
Difference*	+141	+2,536	+1,975	+1,285	+511	-2,088

* Positive numbers indicate a net emission increase; a (-) indicates a net emission decrease.

Source: ESE, 1981.

Table 3-6. List of Key Dates for the Proposed G-P Modification

Source	Construction Permit or Commence Construction	Operation Permit	Cease Operation
Lime Kiln #1	Prior to January 1, 1975	May 17, 1973	June 1976
Lime Kiln #2	Prior to January 1, 1975	May 17, 1973	1976
Lime Kiln #3	Prior to January 1, 1975	May 17, 1973	1976
Recovery Boiler and Smelt #1	Prior to January 1, 1975	May 17, 1973	December 1976†
Recovery Boiler and Smelt #2	Prior to January 1, 1975	May 17, 1973	December 1976†
Recovery Boiler and Smelt #3	Prior to January 1, 1975	May 17, 1973	December 1976†
Power Boiler #4	March 11, 1971	September 10, 1976	NA
Power Boiler #5††	May 17, 1973	October 19, 1976	NA
Combination Boiler #4	July 3, 1975*	March 3, 1971	NA
Lime Kiln #4	October 1974	March 1976	NA
Recovery Boiler and Smelt #4	October 1974	August 5, 1977	NA

* Application for new collectors. Operation permit with new collectors granted October 7, 1977.

† Served on a standby operation status before permanent shutdown in March 1977.

†† May 1973 was the initial construction date. October 1976 represents a modification to the boiler and corresponding emission reductions.

Source: ESE, 1981.

difference between the emissions from the contemporaneous reduction sources and the proposed sources shows, there is a decrease in total reduced sulfur (TRS) compound; therefore, further PSD analysis for this pollutant is not required. An impact analysis and BACT are required for pollutants other than TRS, due to net emission increases greater than the appropriate significant emission rates (see Table 3-2).

Source applicability with regard to preconstruction monitoring is addressed in the PSD Plan of Study (POS) document for the proposed G-P plant modification. This document was submitted to DER in May 1981. Results of the ambient monitoring applicability analysis show that total suspended particulate (TSP) and SO₂ monitoring is necessary. This monitoring is being conducted in accordance with the network design, data reporting, and quality assurance procedures outlined in the POS document.

In addition to air quality impact analyses, federal PSD regulations require additional analyses of the impairment to visibility and the impacts on soils and vegetation that would occur as a result of the proposed modification for pollutants for which there is a significant emissions increase. These analyses are to be conducted primarily for Class I PSD areas. Impacts due to general commercial, residential, industrial, and other growth associated with the source must also be addressed.

Baseline--EPA

EPA defines baseline concentration as that ambient concentration level which exists in the baseline area at the time of the applicable baseline date (40 CFR 52.21 (b)(13)(i)). A baseline concentration is determined for each pollutant for which a baseline date is established and shall include:

1. The allowable emissions of major stationary sources which commenced construction before January 6, 1975, but were not in operation by the applicable baseline date;
2. The actual emissions representative of sources in existence on the applicable baseline date, except for those listed below, which will affect the maximum allowable increases:
 - a. Actual emissions from any major stationary source on which construction commenced after January 6, 1975; and
 - b. Actual emissions increases and decreases at any stationary source occurring after the baseline date.

When considering actual emission rates, EPA is referring to emissions estimated from source records and any other information reflecting actual source operation over the 2-year time period preceding the baseline date. The baseline date is 1977 and is applicable for both particulate matter and SO₂ for all attainment areas of the state. When applying the baseline emissions concept, EPA does not require the establishment of a formal baseline concentration.

When considering factors such as hours of operation, capacity utilization, and types of materials combusted, processed, and/or stored, the values existing at the baseline date will generally be used; however, the EPA baseline emissions concept can also include future increases in hours of operation or capacity utilization as they occur, if it is demonstrated that a source's operation after the baseline date is more representative of normal operation than its operation preceding the baseline date (Federal Register, 1980).

Modeling

In the modeling for PSD increment consumption, source applicability refers to dates for commencement of construction, beginning of

operation, and any dates for the cease of operation. These dates are listed for all G-P sources in Table 3-6. The dates are important in determining baseline emission rates.

Federal PSD regulations require that changes in actual emissions due to major source construction commencing after January 6, 1975 not be included in the EPA baseline and that they affect the maximum allowable increments. As shown in Table 3-6, several sources were shut down in 1976. These sources were operating prior to 1975 and thus are included in the DER baseline. Curtailment of emissions from these sources expands the increment and is therefore included as EPA baseline to take credit for said expansion upon subtraction from the projected concentrations. Normal operation of the other sources listed in Table 3-6 will not be affected by the proposed action and therefore baseline emission conditions are the same as the projected emissions conditions.

3.3 GOOD ENGINEERING PRACTICE STACK HEIGHT

The 1977 CAA Amendments require that the degree of emission limitation necessary for control of any pollutant not be affected by a stack height that exceeds good engineering practice (GEP) or any other dispersion technique. On January 12, 1979, EPA promulgated proposed regulations on stack heights. The proposed GEP stack height means the highest of:

- a) 30 meters, or
- b) a height established by applying the formula:

$$H_g = H + 1.5L \quad (\text{Equation 1})$$

where: H_g = GEP stack height,

H = Height of the structure or nearby structure, and

L = Lesser dimension (height or width of the structure or nearby structure).

"Nearby" is defined for a specific structure or terrain feature as that distance equal to five times the lesser of the height or width dimension

of the structure or terrain feature not greater than one-half mile (EPA, 1978d). While the actual stack height employed can exceed this height, modeling for determining compliance with AAQS and PSD increments must incorporate the GEP stack height.

Two major imposing structures are present at the G-P mill. All stacks except for the lime kiln stacks will be most affected by the Recovery Boiler Building wake. The lime kiln stacks are influenced by the lime kiln structure. The lime kiln structure is not a solid building but a lattice of steel members; however, it was considered for building wake effects. The appropriate building dimensions are listed in Table 3-7. Following is a GEP stack height determination for each proposed stack using the above equation and the appropriate building dimensions given in Table 3-7.

Lime Kiln: Influencing Height = 82 feet
Influencing Width = 47 feet
GEP = $82 + 1.5(47) = 153$ feet
(Proposed height = 149 feet)

Combination Boiler:
Influencing Height = 211.7 feet
Influencing Width = 88 feet
GEP = $211.7 + 1.5(88) = 344$ feet
(Proposed height = 250 feet)

Recovery Boiler: Same as Combination Boiler
(Proposed height = 250 feet)

Smelt Tanks: Influencing Height = 211.7 feet
Influencing Width = 102.5 feet (stacks located on top
of recovery boiler)
GEP = $211.7 + 1.5(102.5) = 365$ feet
(Proposed height = 250 feet)

Table 3-7. Building Dimensions for Major Influencing Structures At
G-P Palatka Paper Mill

Structure	Height (ft)	Width (ft)	Depth (ft)
Recovery Boiler	211.7	88	102.5
Lime Kiln	82	47	40

Source: G-P, 1981.

Because of the proposed stack heights being less than GEP, a downwash analysis must be performed and is presented in Section 6.

4.0 ATMOSPHERIC DISPERSION MODELING METHODOLOGY

To evaluate completely the impact of emissions and to determine compliance with AAQS and other regulations, the relationship between atmospheric emissions and air quality must be established. One approach to determine this relationship is to assume that a change in emissions would cause a proportionate change in air quality. This approach, however, does not explicitly include the effects of meteorology, topography, and stack gas parameters. Therefore, this method does not ensure an accurate estimate of the impact of emissions on the overall air quality.

In response to this deficiency, the air quality dispersion model has become an accepted method for estimating the spatial distribution of pollutant concentrations. Currently, the dispersion models are generally restricted to nonreactive or slow-reacting pollutants, such as SO₂, particulate matter, and CO. Current state-of-the-art techniques in dispersion modeling cannot accurately predict concentrations for reactive pollutant species such as nitrogen dioxide (NO₂), hydrocarbons (HC), and photochemical oxidants.

Mathematical dispersion models simulate the effects of stack height, stack flow parameters, source distributions, and atmospheric elements such as air flow and mixing on the transport and dispersion of pollutants emitted into the atmosphere. Dispersion models are useful for calculating the spatial distribution of concentrations that result from various sources, and these models can be used to estimate ground-level concentrations for extreme meteorological conditions. Figure 4-1, which illustrates the procedure to follow in applying a mathematical model, shows that by compiling existing emissions, meteorological, and air quality data, a dispersion model can estimate the impact of source emissions on air quality. The model is also useful in predicting the relative change in air quality as a result of varying emission parameters, meteorological conditions, and source distributions.

4-2

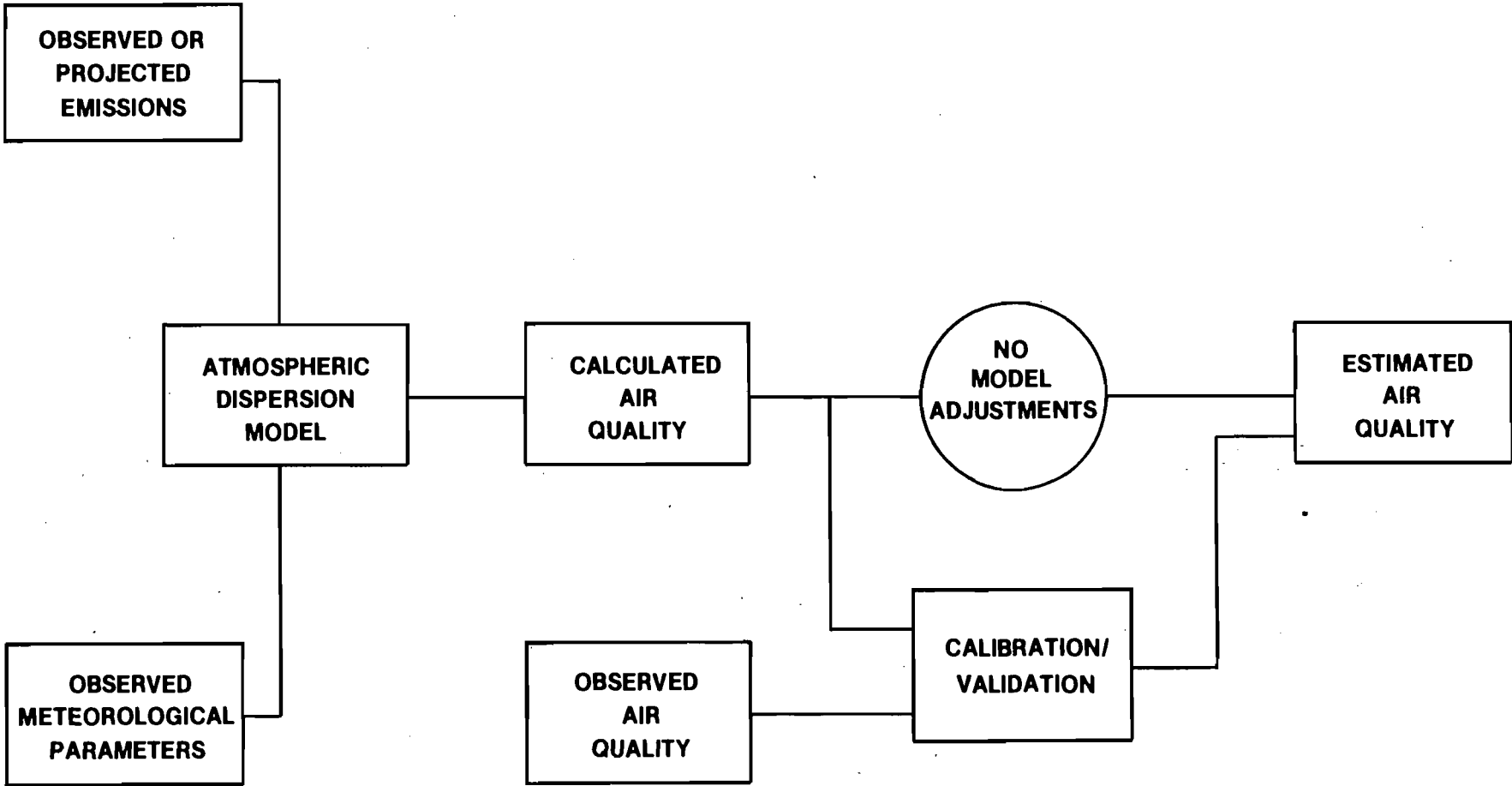

Figure 4-1
FLOW DIAGRAM FOR THE APPLICATION OF ATMOSPHERIC DISPERSION MODELS.

**ENVIRONMENTAL SCIENCE
AND ENGINEERING, INC.**

EPA has developed several dispersion models which use the Gaussian diffusion equation. The basic formulation of the Gaussian equation assumes that the ground-level concentration is inversely proportional to the mean wind speed. The Gaussian distribution describes the horizontal and vertical pollutant dispersion in a plane normal to the wind direction.

An atmospheric dispersion model can be defined as a mathematical description of the transport, dispersion, and transformation processes that occur in the atmosphere. In the case of SO₂, it is generally assumed that chemical conversion of this substance is small with respect to its average residence time in the atmosphere. In the case of particulate matter, it is assumed that no particles are scavenged from the atmosphere by fallout or washout. These conservative assumptions tend to result in higher predicted concentrations than actual measured concentrations.

Florida DER and EPA Ambient Air Quality Standards are for annual, 24-hour, 8-hour, and 3-hour periods of time; therefore, the dispersion models must predict concentrations for various averaging times. Most dispersion models, however, estimate concentrations for a 1-hour period or for seasonal or annual time periods. If an average concentration for an intermediate period is required, then two options, both of which are approved by EPA and Florida DER, are available:

1. The short-term model can be used to estimate concentrations hour by hour for the period of interest, and an average of all hours can be taken with consideration given to an appropriate calibration factor.
2. Statistical techniques suggested by Larsen (1971) for log-normally distributed data or empirical techniques as summarized by Strom (1976) for point sources can be utilized to convert a concentration from one averaging time to another.

In this study, Method 1 was utilized to determine point source impacts for the annual, 24-hour, 8-hour, 3-hour, and 1-hour averaging times.

5/31/81

The long-term AAQS for TSP is expressed in terms of an annual geometric mean. The air dispersion models, however, calculate annual arithmetic mean concentrations. Therefore, a method of conversion from arithmetic mean to geometric mean concentration is necessary in order to compare estimates with air quality standards. Larsen (1971) has developed an equation which expresses the relationship for log-normally distributed data:

$$M_g = \frac{M_{aa}}{\exp(0.5 \ln^2 S_g)} \quad (\text{Equation 2})$$

where: M_g = geometric mean

M_{aa} = arithmetic mean

S_g = standard geometric deviation

An analysis of many years of ambient TSP data indicates that the log-normal assumption is a good approximation for suspended particulates in suburban and rural areas. This analysis also shows that S_g values normally range from 1.0 to 2.0 for an annual period, with a typical value of 1.5. Inserting an S_g of 1.5 into Equation 2 results in a M_g/M_{aa} ratio of 0.92. This ratio is used to convert arithmetic mean TSP levels to geometric mean TSP levels, based upon the modeling results.

4.1 COMPUTER MODELS

Two EPA-approved computer models were used to estimate or predict the ground-level pollutant concentrations in this study. The Industrial Source Complex Model Long Term (ISCLT) was used to predict annual impacts, and the Industrial Source Complex Model Short Term (ISCST) was used for impact predictions for shorter averaging times.

In the ISCLT, sources within a 50-km radius were modeled. The impact area receptor grid for the model covered a 25-km² radius surrounding the G-P site, with receptors placed at a 0.5-km spacing.

5/31/81

In the ISCST, the receptors were spaced at 0.3-km intervals along 10-degree radials, beginning at 0.6 km for SO₂ and 0.3 for TSP. The worst-case meteorology was determined from this modeling. The ISCST model allows the user to input spatially distributed sources and was used for receptor refinement (at 2 degrees radial, and 0.1-km spacing) to resolve the maximum impact predictions. The short-term modeling case runs and meteorological periods are presented in Table 4-1.

4.2 METEOROLOGY

Meteorological data used in the ISC modeling were obtained from the Jacksonville Airport (surface observations) and Valdosta, Georgia (upper air data) for the years 1970 through 1974. Recorded data included wind direction, wind speed, stability class, mixing depth, and ambient temperature for each hour. Wind directions are randomized within a 10-degree sector by EPA's randomization scheme. The ISCST model processed each hour of the data set to estimate hourly concentrations over the 5-year period. These concentrations were averaged over each applicable averaging period to provide the user with the desired concentrations.

The ISCLT used the data record as a joint frequency distribution of wind direction, wind speed, and atmospheric stability class over the 5-year period. This data format is provided by the National Climatic Center's (NCC) "Star" program. In addition, annual averaged values of temperature, pressure, and maximum afternoon mixing heights are used. These data are used in the ISCLT to estimate the spatial distribution of annual averaged concentrations of baseline and future ambient concentration levels.

4.3 EMISSIONS INVENTORY

For short-term modeling, major sources located within a 15-km radius were considered, while the area of consideration extended to 50-km in the long-term modeling. Basis for the inventory was the Air Permit Inventory System (APIS). In addition, construction permit applications

Table 4-1. Short-Term Modeling Case Runs and Meteorological Periods

Scenario	Day
<u>SO₂</u>	
Maximum 24-Hour	195, 1971 280, 1970
Interaction with Seminole Electric	230, 1972
Interaction with FP&L Plants	180, 1974
Maximum 3-Hour	126, 8/1973
Interaction with Seminole Electric	109, 4/1974
Interaction with FP&L Plants	219, 5/1972
<u>TSP</u>	
Maximum 24-Hour	222, 1971 137, 1973 281, 1970
Interaction with Seminole Electric	7, 1973
Interaction with FP&L Plants	143, 1971

and various modeling reports were considered in developing the inventory, and the maximum emission rates contained therein were used.

4.4 AIR QUALITY IMPACT DETERMINATION

The ISCLT model was used to estimate annual average ground-level concentrations for TSP and SO₂. For these pollutants, modeling was performed for permitted sources within a 50-km radius, including the G-P sources. For annual nitrogen oxides (NO_x), reference is made to the March 1981 POS for which NO_x modeling was conducted. These modeling results showed that the proposed action will pose no threat to the AAQS. All annual printouts are included in Appendix B of this report.

Evaluation of short-term maximum impacts (highest, second-highest) for TSP and SO₂ for the G-P proposed conditions was made using the ISCST. The appropriate highest, second-highest concentrations were determined in 5-year ISCST executions with the following short-term interacting sources included with the G-P sources in the source input data:

1. Seminole Electric (7.5 km and 39 degrees from G-P),
2. FPL Putnam (10.9 km and 150 degrees from G-P), and
3. FPL Palatka (10.6 km and 147 degrees from G-P).

The results of the 5-year ISCST modeling were refined using the ISCST model to determine the maximum impacts and impacts in the interacting directions. The modeled sources and emissions are shown in Table 4-2.

4.5 INCREMENT CONSUMPTION DETERMINATION

The maximum short-term PSD increment consumption was determined by subtracting receptors point-by-point in 5-year ISCST baseline executions from 5-year ISCST projected impacts. Seminole Electric is the only new source in the G-P impact area and currently is under construction. FPL Palatka consumes TSP increments by virtue of a variance to emit particulate up to 0.3 lb/10⁶ Btu, increased from 0.1 lb/10⁶ Btu. FPL Putnam

Table 4-2. Modeled Sources and Emissions for G-P Proposed Modification

Source	Baseline Emissions				Projected Emissions	
	Annual (TPY)		Short-Term (lb/hr)		(lb/hr)	
	TSP	SO ₂	TSP	SO ₂	TSP	SO ₂
Recovery Boiler #1	345	216	78.8	49.3	—	— ✓
Recovery Boiler #2	441	309	100.7	70.5	—	— ✓
Recovery Boiler #3	477	298	109.0	68.1	—	— ✓
Recovery Boiler #4	729	1,215	166.5	277.5	166.5	277.5
Proposed Recovery Boiler #5	—	—	—	—	75.4	250.0
Smelt #1	11	4	2.4	1.0	—	— ✓
Smelt #2	16	6	3.6	1.4	—	— ✓
Smelt #3	14	6	3.3	1.4	—	— ✓
Smelt #4	193	25	40.8	5.6	40.8	5.6
Proposed Smelt	—	—	—	—	15.0	5.2
Lime Kiln #1	788	8	180.0	0.24	—	— ✓
Lime Kiln #2	416	8	95.0	0.24	—	— ✓
Lime Kiln #3	407	17	93.0	0.48	—	— ✓
Lime Kiln #4	54.6	48.6	31.6	11.1	31.6	11.1
Proposed Lime Kiln #5	—	—	—	—	29.3	10.5
Power Boiler #4	105	1,192	106.3	2,848.1	106.3	2,848.1
Power Boiler #5	186	4,658	46.4	1,279.0	46.4	1,279.0
Combination Boiler #4	2,561	1,008	711.8	962.5	117.0	962.5
Proposed Combination						
Boiler #5	—	—	—	—	216.7	654.0
FPL Palatka	468	12,888	107.0	2,942.5	321.0	2,942.5
FPL Putnam	1,206	6,723	275.4	1,535.0	275.4	3,070.0
Seminole	—	—	—	—	324.6	12,984.1

Sources: ESE, 1981. G-P, 1981.

affects SO₂ increment due to a fuel switch (0.35 to 0.7-percent sulfur oil) and a stack height increase.

Maximum allowable emissions for the existing sources at G-P were used for both short-term baseline and projected modeling. Use of these data is justifiable for the short-term baseline modeling because stack test results showed that the sources operated up to the maximum allowable rates. For the long-term baseline modeling, however, conditions represented in annual operating reports were used. The modeled sources and the emissions are shown in Table 4-2.

As with the short-term increment analysis, impacts in 5-year ISCLT baseline executions were subtracted from 5-year ISCLT executions for the projected conditions to determine long-term TSP and SO₂ increment consumption.

A TSP background concentration was unavailable from existing data. However, the Seminole Electric PSD was consulted and the values therein were used. The second-highest measured 24-hour TSP concentration from a former FDER monitor at Kay Larkin Airport was 80 ug/m³. This value is very high for background and probably include some influence from the G-P mill. The probability of this level occurring concurrent with worst-case meteorology for point source emissions is very small. Nevertheless, 80 ug/m³ was used to represent extreme worst-case conditions. The annual TSP background concentration was assumed 40 ug/m³ and was obtained from PSD modeling guidelines.

4.6 DOWNWASH METHODOLOGY

As shown in Section 3.3, the proposed stacks for G-P are at a height less than GEP. The required downwash analysis was conducted using the downwash option in the ISCST. The ISCST refinement executions for the highest, second-highest 24-hour TSP and SO₂ concentrations were modified to request contributions from the proposed G-P sources only, with and without downwash considerations. These modeling executions

were compared to show what increase in impact could be expected due to downwash effects.

In addition, 4 hours of meteorological conditions conducive to downwash effects were selected and requested in ISCST executions with and without downwash conditions. These four meteorological conditions were: a "C" stability class and a low wind speed representative of that class (5 mps); a "C" stability class and a high wind speed representative of that class (10 mps), and; a low (12 mps) and high wind speed (15 mps) representative of a "D" stability class.

These comparisons with and without downwash considerations indicate whether downwash conditions will have an adverse effect on the air quality impact of the proposed sources.

5.0 AMBIENT AIR MONITORING

Preconstruction ambient monitoring is being conducted at the G-P site. Preliminary emissions analysis and modeling indicated that TSP and SO₂ monitoring was necessary. One SO₂ continuous site and four TSP sites were chosen to represent background, and an area of high impact for existing and proposed conditions (see Figure 5-1 for locations of preconstruction monitoring sites). The monitoring data collected at these sites will be submitted quarterly to DER. For further description of the preconstruction monitoring analysis, refer to the POS submitted to DER in March 1981.

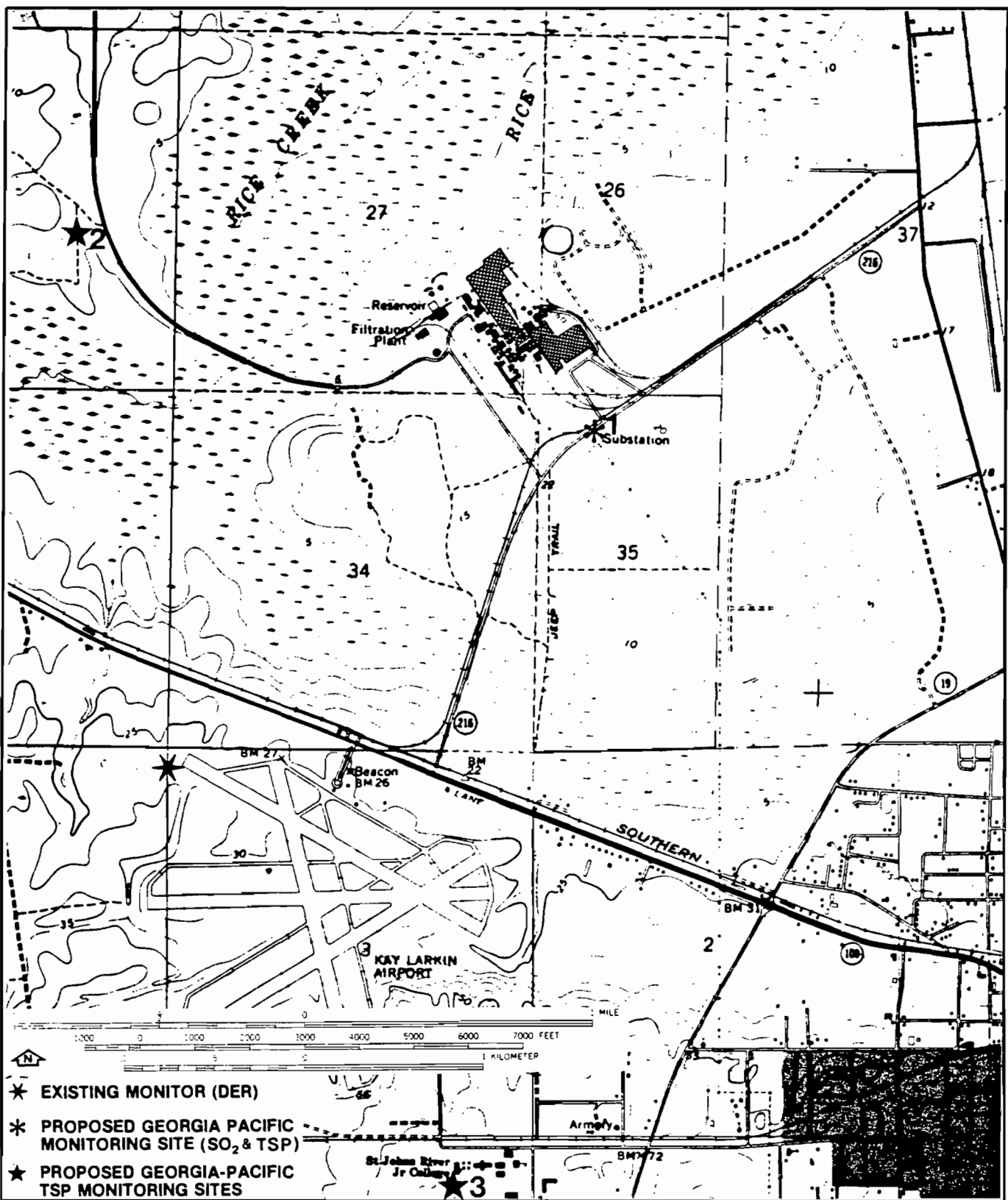

Figure 5-1
LOCATION OF EXISTING AMBIENT MONITORS
AND PROPOSED GEORGIA-PACIFIC MONITORING
STATIONS

SOURCE: ESE, 1981.

GEORGIA-PACIFIC
CORPORATION

6.0 IMPACT ANALYSIS RESULTS

6.1 AIR QUALITY STANDARDS

6.1.1 Particulate Matter

The highest, second-highest predicted 24-hour ground-level concentration for the projected conditions considering the proposed action at G-P is 107.5 ug/m³, including an assumed background concentration of 80 ug/m³. This predicted maximum impact (highest, second-highest) is 72 percent of the AAQS for TSP. Predicted maximum interaction impacts are 101, 105, and 102 ug/m³ (including background). These interactions are 67, 70, and 68 percent of the AAQS for TSP and result from operations at Seminole Electric, FPL Palatka, and FPL Putnam, respectively.

The maximum predicted annual TSP impact for the projected conditions, including all interacting sources, is 44 ug/m³ and is 73 percent of the annual AAQS for TSP. This value includes the assumed background of 40 ug/m³. All modeling results are shown in Table 6-1 along with the applicable AAQS for visual comparison.

6.1.2 Sulfur Dioxide

The highest, second-highest 3- and 24-hour concentrations predicted for the proposed conditions are 295 and 98 ug/m³, respectively. Predicted highest, second-highest concentrations due to interaction with Seminole Electric, FPL Putnam, and FPL Palatka are 191, 214, and 214 ug/m³, respectively, for the 3-hour averaging time, and 47, 59, and 59 ug/m³, respectively, for the 24-hour averaging time (see Table 6-1). The maximum predicted annual SO₂ impact as a result of the proposed action and including interacting sources is 22 ug/m³, or 37 percent of the annual SO₂ standard.

6.1.3 Nitrogen Oxides and Carbon Monoxide

Preliminary modeling conducted for the POS showed small impacts for NO_x and CO; therefore, no additional modeling was conducted.

6.2 INCREMENT CONSUMPTION

The short-term increment consumption analysis is the same for the federal review as for DER; however, because EPA uses actual baseline emissions

Table 6-1. Proposed G-P Mill Modification: Maximum Annual and Highest, Second-Highest Short-Term Predicted Concentrations*

Scenario	Concentration (ug/m ³)				
	3-Hour SO ₂	24-Hour SO ₂	24-Hour TSP	Annual SO ₂	Annual TSP
Maximum Predicted	295	98	108	22	44
Interaction with Seminole Electric	191	47	101	--	--
Interaction with FPL Putnam	214	59	105	--	--
Interaction with FPL Palatka	214	59	102	--	--
State of Florida Standard	1,300	260	150	60	60

* Concentrations include a TSP background of 80 ug/m³ (24-hour) and 40 ug/m³ (annual).

Source: ESE, 1981.

instead of allowable, the annual analysis predicted slightly different consumptions for the proposed action. The predicted short-term SO₂ and TSP increment consumption under both EPA and DER regulations is negative (i.e., an air quality improvement at all locations compared to the baseline concentrations).

Annual TSP increment consumption under both DER and EPA regulations was negative at all receptor locations, indicating an improvement in TSP air quality compared to the baseline concentrations. Annual SO₂ increment consumption based on DER regulations was less than 5 ug/m³, and annual SO₂ increment consumption was less than 6 ug/m³. In both the annual and short-term maximum increment consumption results, the appropriate interacting sources were considered. Maximum interactions are presented in Table 6-2 along with allowable Class II increments for comparison purposes.

6.3 CLASS I IMPACTS

Because of the distance to the nearest Class I area (Okefenokee Swamp, 120 km northwest), impacts on the Class I area were not addressed quantitatively. However, increment modeling in the vicinity of G-P showed a substantial decrease in TSP levels since the baseline.

6.4 DOWNWASH

In comparing the 24-hour highest, second-highest TSP refinement execution requesting the G-P proposed sources only with and without downwash, it was found that with the consideration of downwash effects, the maximum increase was only 1 ug/m³ above no downwash considerations. For the 24-hour SO₂ refinement, the maximum increase was 5 ug/m³ above the no-downwash case (24-hour averages).

In comparing four selected hours of meteorological data conducive to downwash effects, the maximum 1-hour increase due to downwash was 27 ug/m³ for TSP and 50 ug/m for SO₂. Using the EPA method given in the guidelines document, Volume 10, a factor of 0.6 (maximum) was used

Table 6-2. Summary of PSD Increment Consumption Results: Proposed G-P Modification

Pollutant	Increment Consumption ($\mu\text{g}/\text{m}^3$)					
	EPA			DER		
	3-Hour	24-Hour	Annual	3-Hour	24-Hour	Annual
<u>Sulfur Dioxide</u>						
Maximum Increment Consumption	<0	<0	<6	<0	<0	<5
Allowable Increment	512	91	20	512	91	20
<u>Particulate</u>						
Maximum Increment Consumption	--	<0	<0	--	<0	<0
Allowable Increment	--	37	19	--	37	19

Source: ESE, 1981.

to correct for a 24-hour average. The increases were then predicted to be 16 ug/m³ and 30 ug/m³, respectively. If these increases were applied to the worst-case modeling results (see Sections 6.1.1 and 6.1.2), the resulting concentrations would remain below AAQS (123.5 ug/m³ for 24-hour TSP and 127.6 for 24-hour SO₂), indicating that the stacks proposed at heights less than GEP will not pose a threat to AAQS.

7.0 ADDITIONAL IMPACTS ON SOILS, VEGETATION, AND VISIBILITY

7.1 IMPACTS ON SOILS AND VEGETATION

Impacts on soils and vegetation due to operation of the proposed sources are expected to be minor. The projected highest, second-highest 3-hour SO₂ concentration of 295 ug/m³ and annual mean concentration of 22 ug/m³ (see Table 7-1) are well below levels generally reported for damage to sensitive plant species. As an example of such damage levels, European studies have found one-half hour levels of 3,406 ug/m³ and long-term means of 393 ug/m³ to approximate threshold levels for several species (Heck and Brandt, 1977). Other long-term studies have indicated threshold ranges for sensitive species of 47 ug/m³ to 78 ug/m³ over two to four months of exposure and 31 ug/m³ over seven months (Florida Sulfur Oxides Study, Inc., 1978).

Alfalfa, which is commonly thought to be one of the most SO₂-sensitive species, has a 2-hour threshold level of at least 2,620 ug/m² and an 8-hour threshold of 655 ug/m² (Heck and Brandt, 1977), far above the predicted impact levels. Based upon results such as these, no discernable impacts are predicted from this source.

Particulate matter is generally considered to have a relatively unimportant effect on vegetation (Jacobson & Hill, 1970). A net air quality improvement is predicted over the baseline conditions (see Section 7); as such, no adverse effect on soils and vegetation due to particulate emissions is expected.

Plant species classified as "sensitive" to NO₂, such as pinto bean, cucumber, lettuce, and tomato, displayed injury when exposed to NO₂ levels of 3,760 to 4,960 ug/m³ for a 2-hour period. Extremely resistant species, such as heath, were unaffected by an exposure of 1,900,000 ug/m³ for 1 hour. Blue grass, orange tree plants, and rye are all classified as "intermediate" in resistance to NO₂ injury.

It has been found that NO_x concentration is more important to plant injury than the duration of exposure (Jacobson, et al., 1970). Because of the very low levels of NO₂ predicted to occur due to the proposed action, no effect on plants or soils is expected.

Effects of SO₂, NO₂, and particulate matter emissions upon soils are expected to be negligible. Acid rain effects in the area are generally unknown due to a lack of data for the region (Florida Sulfur Oxides Study, Inc., 1978): the potential for significant acid rain effects due to the proposed source is considered to be very low.

7.2 VISIBILITY IMPACTS

The proposed source is expected to have no significant impairment on visibility in the immediate affected area or upon the nonattainment or Class I PSD areas previously described in Section 2.0. During construction at the mill, construction activities may have a small transient effect on local visibility. The visible particulate emissions produced by various construction activities such as earth movement and heavy machinery operation, should have short-term impacts on visibility and should occur only during the actual construction activities. There should be no long-term impairment on visibility due to construction activities for the proposed source.

No significant impact on visibility is expected at the nearest Class I area from operation of the various facilities for the proposed modification. This area (Okefenokee Swamp) is located more than 120 km from the G-P site, and therefore, no quantitative visibility analysis was conducted.

6/1/81

8.0 CONCLUSIONS

Based upon atmospheric dispersion modeling results presented in Section 5, it is predicted that the allowable Class II PSD increments will not be exceeded. Impacts on the nearest Class I area will be less than the allowable increments as a result of the proposed G-P mill modification due to the large distance to the Class I area. In addition, it is expected that AAQS will not be exceeded, and that designated nonattainment areas will not be significantly affected by the proposed source. These results are based on modeling of worst-case meteorological conditions, 100-percent load conditions, and maximum allowable emissions from all G-P and interacting sources. This scenario has a low probability of occurrence, since the above conditions would have to occur simultaneously.

All NSPS will be met by appropriate facilities in the complex. Each facility will apply BACT where required to control emissions.

Impacts upon soils, vegetation, and visibility in the area of the proposed site are not predicted to be significant. All stacks within the complex will conform to GEP regulations. All ambient air monitoring requirements are being satisfied by the preconstruction monitoring program conducted by G-P.

In summary, the proposed action for the G-P Palatka plant is expected to comply with all state and federal PSD and air quality regulations.

REFERENCES

- Florida Sulfur Oxides Study, Inc. 1978. Final Report of Florida Sulfur Oxides Study.
- Heck, W.W., and Brandt, C.S. 1977. Air Pollution, Effects on Vegetation: Native Crops, Forests. In: Air Pollution. A.C. Stern, Editor. Vol. II. The Effects of Air Pollution. Academic Press, Inc., New York.
- Jacobson, J.L., and Hill, A.C. 1970. Recognition of Air Pollution Injury to Vegetation: A Pictorial Atlas. Air Pollution Control Association, Pittsburgh, Pennsylvania.
- Larsen, R.I. 1971. A Mathematical Model for Relating Air Quality Measurements to Air Quality Standards. Pub. No. AP-89. U.S. EPA, Office of Air Programs, Research Triangle Park, North Carolina.
- Peters, J.A., and Duncan, C.F. 1980. Nonfossil Fueled Boilers: Emission Test Report, U.S. Sugar Company, Bryant, Florida. Monsanto Research Corporation, Dayton, Ohio, Project No. 80-WFB-6.
- U.S. Environmental Protection Agency, Office of Air Quality Planning and Standards. 1980. Workbook for Estimating Visibility Impairment. RTP No. 27711. July 1980.
- U.S. Environmental Protection Agency, Office of Air Quality Planning and Standards. 1978a. Ambient Air Guidelines for Prevention of Significant Deterioration. EPA-450/2-78-019.
- U.S. Environmental Protection Agency, Office of Air Quality Planning and Standards. 1978b. Guideline on Air Quality Models. EPA-450/2-78-027.
- U.S. Environmental Protection Agency, Office of Air Quality Planning and Standards. 1978c. Guidelines for Determining Best Available Control Technology (BACT).
- U.S. Environmental Protection Agency, Office of Air Quality Planning and Standards. 1978d. Technical Support for Determination of Good Engineering Practice Stack Height. Research Triangle Park, North Carolina.

APPENDIX A

CONSTRUCTION PERMIT APPLICATIONS

COMBINATION BOILER NO. 5



AC 54- 43773

STATE OF FLORIDA
DEPARTMENT OF ENVIRONMENTAL REGULATION
APPLICATION TO OPERATE/CONSTRUCT
AIR POLLUTION SOURCES

SOURCE TYPE: Combination Boiler No. 5 [] New¹ [] Existing¹

APPLICATION TYPE: [] Construction [] Operation [] Modification

COMPANY NAME: Georgia-Pacific Corporation COUNTY: Putnam

Identify the specific emission point source(s) addressed in this application (i.e. Lime-Kiln No. 4 with Venturi Scrubber; Peeking Unit No. 2, Gas Fired) Combination Boiler No. 5 with ESP

SOURCE LOCATION: Street N. of S.R. 216, W. of U.S. 17 City Palatka

UTM: East 434.0 North 3,283.4

Latitude 29 ° 41 ' 00 "N Longitude 81 ° 40 ' 45 "W

APPLICANT NAME AND TITLE: Roger C. Sherwood, Technical Director

APPLICANT ADDRESS: P.O. Box 919, Palatka, Florida 32077

SECTION I: STATEMENTS BY APPLICANT AND ENGINEER

A. APPLICANT

I am the undersigned owner or authorized representative* of Georgia-Pacific Corporation

I certify that the statements made in this application for a construction permit are true, correct and complete to the best of my knowledge and belief. Further, I agree to maintain and operate the pollution control source and pollution control facilities in such a manner as to comply with the provision of Chapter 403, Florida Statutes, and all the rules and regulations of the department and revisions thereof. I also understand that a permit, if granted by the department, will be non-transferable and I will promptly notify the department upon sale or legal transfer of the permitted establishment.

*Attach letter of authorization

Signed: Roger C. Sherwood
Roger C. Sherwood, Technical Director
Name and Title (Please Type)

Date: 6-2-81 Telephone No. 904/325-2001

B. PROFESSIONAL ENGINEER REGISTERED IN FLORIDA (where required by Chapter 471, F.S.)

This is to certify that the engineering features of this pollution control project have been designed/examined by me and found to be in conformity with modern engineering principles applicable to the treatment and disposal of pollutants characterized in the permit application. There is reasonable assurance, in my professional judgment, that the pollution control facilities, when properly maintained and operated, will discharge an effluent that complies with all applicable statutes of the State of Florida and the rules and regulations of the department. It is also agreed that the undersigned will furnish, if authorized by the owner, the applicant a set of instructions for the proper maintenance and operation of the pollution control facilities and, if applicable, pollution sources.

Signed: David A. Buff
David A. Buff
Name (Please Type)

Environmental Science and Engineering, Inc.
Company Name (Please Type)
P.O. Box ESE, Gainesville, Florida 32604
Mailing Address (Please Type)

Date: 6-2-81 Telephone No. 904/372-3318

(Affix Seal)

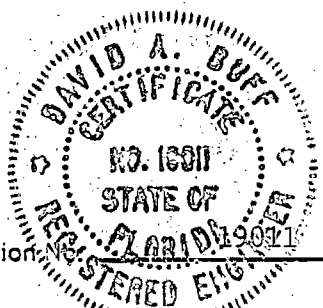

Florida Registration

¹See Section 17-2.02(15) and (22), Florida Administrative Code, (F.A.C.)

SECTION II: GENERAL PROJECT INFORMATION

A. Describe the nature and extent of the project. Refer to pollution control equipment, and expected improvements in source performance as a result of installation. State whether the project will result in full compliance. Attach additional sheet if necessary.

A new 700,000 lb/hr steam combination boiler equipped with an ESP will be constructed adjacent to the present No.4 recovery boiler. The boiler will be fired by peat, wood waste (primarily bark), or a combination of these two fuels. The source will comply with all applicable state and federal regulations.

B. Schedule of project covered in this application (Construction Permit Application Only)

Start of Construction: December, 1981 Completion of Construction 1983

C. Costs of pollution control system(s): (Note: Show breakdown of estimated costs only for individual components/units of the project serving pollution control purposes. Information on actual costs shall be furnished with the application for operation permit.)

ESP: \$2.5 million - \$4.0 million

D. Indicate any previous DER permits, orders and notices associated with the emission point, including permit issuance and expiration dates.

Not applicable

E. Is this application associated with or part of a Development of Regional Impact (DRI) pursuant to Chapter 80, Florida Statutes, and Chapter 22F-2, Florida Administrative Code? Yes: No:

F. Normal equipment operating time: hrs/day 24; days/wk 7; wks/yr 51; if power plant, hrs/yr 1; if seasonal, describe: _____

G. If this is a new source or major modification, answer the following questions. (Yes or No)

- | | |
|---|-----|
| 1. Is this source in a non-attainment area for a particular pollutant? | No |
| a. If yes, has "offset" been applied? | - |
| b. If yes, has "Lowest Achievable Emission Rate" been applied? | - |
| c. If yes, list non-attainment pollutants. | - |
| 2. Does best available control technology (BACT) apply to this source? If yes, see Section VI. | Yes |
| 3. Does the State "Prevention of Significant Deterioration" (PSD) requirements apply to this source? If yes, see Sections VI and VII. | Yes |
| 4. Do "Standards of Performance for New Stationary Sources" (NSPS) apply to this source? | No |
| 5. Do "National Emission Standards for Hazardous Air Pollutants" (NESHAP) apply to this source? | No |

Attach all supportive information related to any answer of "Yes". Attach any justification for any answer of "No" that might be considered questionable.

SECTION III: AIR POLLUTION SOURCES & CONTROL DEVICES (Other than Incinerators)

A. Raw Materials and Chemicals Used in your Process, if applicable:

Description	Contaminants		Utilization Rate - lbs/hr	Relate to Flow Diagram
	Type	% Wt		
	Not applicable			

B. Process Rate, if applicable: (See Section V, Item 1)

- Total Process Input Rate (lbs/hr): Not applicable
- Product Weight (lbs/hr): 700,000 lb/hr steam max

C. Airborne Contaminants Emitted:

Name of Contaminant	Emission ¹		Allowed Emission ² Rate per Ch. 17-2, F.A.C.	Allowable ³ Emission lbs/hr	Potential Emission ⁴		Relate to Flow Diagram
	Maximum lbs/hr	Actual T/yr			lbs/hr	T/yr	
Particulate	216.7	928	17-2.05; 0.2 lb/MM Btu	216.7	9,561	41,878	D
Sulfur Dioxide	653.6	2,206	NA		654	2,863	D
Nitrogen Oxides	255.0	981	NA		255	1,117	D
VOC	69.4	282	NA		69	304	D
Carbon Monoxide	255.0	981	NA		255	1,117	D

D. Control Devices: (See Section V, Item 4)

Name and Type (Model & Serial No.)	Contaminant	Efficiency	Range of Particles ⁵ Size Collected (in microns)	Basis for Efficiency (Sec. V, It ⁵)
Electrostatic Precipitator: Environmental Elements or equivalent	Particulate matter	99%+	Submicron	See Item VI.F.10 and Attachment B

¹ See Section V, Item 2.

² Reference applicable emission standards and units (e.g., Section 17-2.05(6) Table II, E. (1), F.A.C. - 0.1 pounds per million BTU heat input)

³ Calculated from operating rate and applicable standard

⁴ Emission, if source operated without control (See Section V, Item 3)

⁵ If Applicable

E. Fuels

Type (Be Specific)	Consumption*		Maximum Heat Input (MMBTU/hr)
	avg/hr	max./hr	
Wood Waste	76,490 lb/hr	254,965 lb/hr*	1,083.6
Peat	152,508 lb/hr	217,869 lb/hr*	1,005.9
No.6 Fuel Oil (2.5% S)**	0	40	250

*Units Natural Gas, MMCF/hr; Fuel Oils, barrels/hr; Coal, lbs/hr
 Fuel Analysis: See Attachment A for peat and wood waste
 Percent Sulfur: _____ Oil: 2.5% S _____ Percent Ash: 0
 Density: 7.9 _____ lbs/gal Typical Percent Nitrogen: 0.1 _____
 Heat Capacity: 18,500 _____ BTU/lb 146,000 _____ BTU/gal
 Other Fuel Contaminants (which may cause air pollution): _____

* When fired singly and not in combination with other fuel.
 ** Utilized for startup, shutdown, and emergency only

F. If applicable, indicate the percent of fuel used for space heating. Annual Average NA Maximum NA

G. Indicate liquid or solid wastes generated and method of disposal.
ESP particulate collected

H. Emission Stack Geometry and Flow Characteristics (Provide data for each stack):

Stack Height: 250 ft Stack Diameter: 12.0 ft
 Gas Flow Rate: 403,275¹/342,900² ACFM Gas Exit Temperature: 350/350 °F.
 Water Vapor Content: 14/12 % Velocity: 59.4/50.5 FPS

1 = 100% wood waste firing
 2 = 100% peat firing

SECTION IV: INCINERATOR INFORMATION

Not Applicable

Type of Waste	Type O (Plastics)	Type I (Rubbish)	Type II (Refuse)	Type III (Garbage)	Type IV (Pathological)	Type V (Liq & Gas By-prod.)	Type VI (Solid By-prod.)
Lbs/hr Incinerated							

Description of Waste _____

Total Weight Incinerated (lbs/hr) _____ Design Capacity (lbs/hr) _____

Approximate Number of Hours of Operation per day _____ days/week _____

Manufacturer _____

Date Constructed _____ Model No. _____

	Volume (ft) ³	Heat Release (BTU/hr)	Fuel		Temperature (°F)
			Type	BTU/hr	
Primary Chamber					
Secondary Chamber					

Stack Height: _____ ft. Stack Diameter _____ Stack Temp. _____

Gas Flow Rate: _____ ACFM _____ DSCFM* Velocity _____ FPS

*If 50 or more tons per day design capacity, submit the emissions rate in grains per standard cubic foot dry gas corrected to 50% excess air.

Type of pollution control device: [] Cyclone [] Wet Scrubber [] Afterburner [] Other (specify) _____

Brief description of operating characteristics of control devices: _____

Ultimate disposal of any effluent other than that emitted from the stack (scrubber water, ash, etc.):

SECTION V: SUPPLEMENTAL REQUIREMENTS

Please provide the following supplements where required for this application.

- Total process input rate and product weight — show derivation.
See Attachment A
- To a construction application, attach basis of emission estimate (e.g., design calculations, design drawings, pertinent manufacturer's test data, etc.) and attach proposed methods (e.g., FR Part 60 Methods 1, 2, 3, 4, 5) to show proof of compliance with applicable standards. To an operation application, attach test results or methods used to show proof of compliance. Information provided when applying for an operation permit from a construction permit shall be indicative of the time at which the test was made.
See Attachment A
- Attach basis of potential discharge (e.g., emission factor, that is, AP42 test).
See Attachment A
- With construction permit application, include design details for all air pollution control systems (e.g., for baghouse include cloth to air ratio; for scrubber include cross-section sketch, etc.).
See Attachment B
- With construction permit application, attach derivation of control device(s) efficiency. Include test or design data. Items 2, 3, and 5 should be consistent: actual emissions = potential (1-efficiency).
See Attachment B
- An 8½" x 11" flow diagram which will, without revealing trade secrets, identify the individual operations and/or processes. Indicate where raw materials enter, where solid and liquid waste exit, where gaseous emissions and/or airborne particles are evolved and where finished products are obtained.
See Attachment A
- An 8½" x 11" plot plan showing the location of the establishment, and points of airborne emissions, in relation to the surrounding area, residences and other permanent structures and roadways (Example: Copy of relevant portion of USGS topographic map).
See PSD report
- An 8½" x 11" plot plan of facility showing the location of manufacturing processes and outlets for airborne emissions. Relate all flows to the flow diagram.
See Attachment A

ATTACHMENT A
EMISSIONS ESTIMATES

A. Fuel Usage Calculations

Heat Requirements: 1,548 Btu/lb, with 65% boiler efficiency on wood waste; 1,437 Btu/lb, with 70% boiler efficiency on peat.

Fuel Analysis (see attached documentation):

Wood waste: 4,250 Btu/lb at 50% moisture
Peat: 4,617 Btu/lb at 50% moisture

Steam Requirements = 700,000 lb/hr design

Wood Waste Usage and Heat Input:

$$700,000 \times 1,548 \div 4,250 = 254,965 \text{ lb/hr (wet)}$$
$$254,965 \times 4,250 = 1,083.6 \times 10^6 \text{ Btu/hr}$$

Peat Usage and Heat Input:

$$700,000 \times 1,437 \div 4,617 = 217,869 \text{ lb/hr (wet)}$$
$$217,869 \times 4,617 = 1,005.9 \times 10^6 \text{ Btu/hr}$$

Fuel Oil Burning: 2.5% S oil will be utilized for startup, shutdown, and emergencies only. Maximum heat input due to oil will be 250×10^6 Btu/hr.

B. Emissions Calculations

Particulate

Emission Regulations: Since this is not a fossil-fuel fired boiler, only State of Florida regulation for carbonaceous fuel burning equipment applies Pg. 05-32 (17-2)

$$0.2 \text{ lb}/10^6 \text{ Btu}$$

$$\text{Max Heat Input} = 1,083.6 \times 10^6 \text{ Btu/hr}$$

$$\text{Max Emissions} = 1,083.6 \times 0.2 = 216.7 \text{ lb/hr}$$

$$\text{Actual Emissions} = 216.7 \times 24 \times 7 \times 51 \div 2,000 = 928.3 \text{ tons/yr}$$

949.1

Peat:

$$\text{Max. Heat Input} = 1005.9 \times 10^6 \text{ Btu/hr}$$

$$\text{Max. Emissions} = \text{''} \times 0.2 = 201.2 \text{ lb/hr}$$

$$\text{Actual Emissions} = 201.2 \times \frac{8568}{8760} \div 2000 = 861.9 \text{ TPY}$$

= 881.3

Potential Emissions: Use AP-42 factor for uncontrolled bark firing (Table 1.6-1) of 75 lb/ton

$$254,965 \text{ lb/hr} \div 2,000 \times 75 = 9,561.2 \text{ lb/hr} = 41,878.1 \text{ TPY} @ 8760$$

$$\text{Peat: } 217,869 = 8,170.1 = 35,000.7 @ 8568$$

Calculation of Outlet Grain Loading: $= 35,785.0 @ 8760$

$$216.7 \text{ lb/hr} \div 226,562 \text{ dscf/min} \div 60 \times 7,000 \text{ gr/lb} = 0.11 \text{ gr/dscf}$$

Peat: 201.2
Sulfur Dioxide

Potential
Maximum Emissions:

Controlled:

Bark: 57.4 lb/hr
x.3 245.7 TPY

Wood waste: AP-42 factor (Table 1.6-1) = 1.5 lb/ton (wet)

$$254,965 \text{ lb/hr} \div 2,000 \times 1.5 = 191.2 \text{ lb/hr}$$

819.1 TPY
837.5

Peat: 457.5 lb/hr
x.7 1959.9 TPY

Peat: Assume max 0.3% S (dry basis) in fuel, or 0.15% S on a wet basis, and total conversion to SO₂*

$$217,869 \text{ lb/hr (wet)} \times 0.0015 \times 2 \text{ lb SO}_2/\text{lb S} = 653.6 \text{ lb/hr}$$

2800.0 TPY
2862.8

Actual Emissions: Assume 70% peat firing and 30% wood waste firing annually

$$\text{Wood waste: } 191.2 \text{ lb/hr} \times 24 \times 7 \times 51 \times 0.30 \div 2,000 = 245.7 \text{ tons/yr}$$

245.7

$$\text{Peat: } 653.6 \text{ lb/hr} \times 24 \times 7 \times 51 \times 0.70 \div 2,000 = 1,960 \text{ tons/yr}$$

1959.9

$$\text{TOTAL} = 2,205.7 \text{ tons/yr}$$

2,205.6

Potential Emissions:

Greatest potential is with 100% peat firing

$$653.6 \text{ lb/hr} \times 8,760 \div 2,000 = 2,863 \text{ tons/yr}$$

8,568 2,800 TPY

Nitrogen Oxides

Maximum Emissions: From paper presented at 1981 TAPPI Environmental Conference (copy attached), for normal stoker-spreader boiler, maximum measured emissions for wood waste = 1.91 lb/ton wet. A factor of 2 lb/ton was therefore used (assume same for peat).

$$\text{Wood waste: } 254,965 \text{ lb/hr} \div 2,000 \times 2 = 255 \text{ lb/hr}$$

$$1083.6 \times 10^6 \text{ Btu/hr} \times 0.21 \text{ lb}/10^6 \text{ Btu} = 227.6 \text{ lb/hr}$$

$$\text{Peat: } 217,869 \text{ lb/hr} \div 2,000 \times 2 = 217.9 \text{ lb/hr}$$

$$1005.9 \times 10^6 \text{ Btu/hr} \times 0.21 \text{ lb}/10^6 \text{ Btu} = 211.2 \text{ lb/hr}$$

975.0 TPY @ 8568
996.9 @ 8760
904.8 TPY
925.1

Should have used Emissions as 0.21 lb/10⁶ Btu (rounded out upper level)

0.1764 lb/10⁶ Btu
0.6498 lb/10⁶ Btu

* Available literature indicates as little as 20 percent of the theoretical SO₂ from peat firing exits with the boiler flue gases.

Actual Emissions:

$227.6 \text{ lb/hr} = 975 \text{ TPY}$

Controlled:

Bark
 $\times 3 \left\{ \begin{array}{l} 68.3 \text{ lb/hr} \\ 292.6 \text{ TPY} \end{array} \right.$

Wood waste: $255 \times 24 \times 7 \times 51 \times 0.3 \div 2,000 = 327.7 \text{ tons/yr}$
 227.6 $211.2 \text{ lb/hr} = 904.8$
 292.5

Peat
 $\times 7 \left\{ \begin{array}{l} 147.8 \text{ lb/hr} \\ 633.2 \text{ TPY} \end{array} \right.$

Peat: $217.9 \times 24 \times 7 \times 51 \times 0.7 \div 2,000 = 653.4 \text{ tons/yr}$
 211.2 633.3

TOTAL = 981 tons/yr
 925.8

Potential Emissions: Greatest when firing 100% wood waste

$255 \text{ lb/hr} \times 8,760 \div 2,000 = 1,117 \text{ tons/yr}$
 216.7 $8,568$ 928.3

Volatile Organic Compounds (VOC)

Maximum Emissions: From paper presented at 1981 TAPPI Environmental Conference. Proposed boiler will utilize suspension burning, therefore no underfire or overfire air. Since this type burning promotes fuel and air mixing and therefore good combustion, the average VOC emission factor of 0.064 lb/10⁶ Btu was used. Same factor assumed for peat.

Wood waste: $1,083.6 \times 10^6 \text{ Btu/hr} \times 0.064/10^6 = 69.4 \text{ lb/hr}$

Peat: $1,005.9 \times 10^6 \text{ Btu/hr} \times 0.064/10^6 = 64.4 \text{ lb/hr}$

Controlled:

Actual Emissions:

$69.4 \text{ lb/hr} = 297.3 \text{ TPY}$

Bark
 $\times 3 \left\{ \begin{array}{l} 20.8 \text{ lb/hr} \\ 89.2 \text{ TPY} \end{array} \right.$

Wood waste: $69.4 \times 24 \times 7 \times 51 \times 0.3 \div 2,000 = 89.2 \text{ tons/yr}$
 304.0

$64.4 \text{ lb/hr} = 275.9 \text{ TPY}$

Peat: $64.4 \times 24 \times 7 \times 51 \times 0.7 \div 2,000 = 193.1 \text{ tons/yr}$
 282.1

Peat
 $\times 7 \left\{ \begin{array}{l} 45.1 \text{ lb/hr} \\ 193.1 \text{ TPY} \end{array} \right.$

TOTAL = 282.3 tons/yr

Potential Emissions: Greatest when burning 100% wood waste

$69.4 \text{ lb/hr} \times 8,760 \div 2,000 = 304 \text{ tons/yr}$
 $8,568$ 297.3

Carbon Monoxide

Maximum Emissions: Use lower AP-42 factor (Table 1.6-1) of 2 lb/ton wet wood waste for well designed boiler. Assume same for peat.

Controlled:

Bark
 $\times 3 \left\{ \begin{array}{l} 77 \text{ lb/hr} \\ 328 \text{ TPY} \end{array} \right.$
Peat
 $\times 7 \left\{ \begin{array}{l} 153 \text{ lb/hr} \\ 653 \text{ TPY} \end{array} \right.$

Wood waste: $254,965 \div 2,000 \times 2 = 255 \text{ lb/hr}$
 1092.4 TPY

Peat: $217,869 \div 2,000 \times 2 = 217.9 \text{ lb/hr}$
 1116.9

933.48 TPY
 954.4

0.235
0.24 lb/10⁶ Btu

COMBUSTION CALCULATIONS

Following methods outlined in Steam, Badcock & Wilcox, 1975.

Wood (Pine Bark)

Based on 50 percent moisture in as-fired fuel, mole method. 75 percent excess air.

	Ultimate Analysis (lb/100 lb fuel)	Moles/ 100 lb Fuel		Required for Combustion Moles/100 lb Fuel at 100 Percent Total Air	
				Oxygen	Dry Air
		2.225			
C	26.7 ÷ 12	= 2.23	x 1.0, 4.76	2.23 2.225	10.61 10.591
H ₂	2.8 ÷ 2.016	= 1.39	x 0.5, 2.38	0.7 0.695	3.31 3.306
O ₂	18.95 ÷ 32	= 0.592			
N ₂	0.05 ÷ 28	= 0.002			
S	0.05 ÷ 32	= 0.002	x 1.0, 4.76	0.002	0.010
H ₂ O	50 ÷ 18	= 2.78			
Ash.	1.45 --				
TOTAL	100.0	6.99		2.93 2.922	13.92 13.907
Less O ₂ in Fuel				-0.59 0.592	-2.81 2.808
Required at 100% Total Air				2.34 2.33	11.11 11.10
Required at 125% Total Air				2.92 2.913	13.89 13.875
Excess Air				--	2.78 2.778
Excess O ₂				0.58 0.583	--

<u>Products of Combustion</u>		<u>Moles/100 lb fuel</u>	
CO ₂	2.23 x 1	2.23	2.225
H ₂ O	1.39 x 1 + 0.592 + 0.29	2.27	2.272
SO ₂	0.002 x 1	0.002	0.002
N ₂	13.89 x 0.79	10.97	10.961
O ₂ (excess)		0.58	0.583
TOTAL WET		16.05	16.043
TOTAL DRY		13.78	13.771

$$\text{ACFM: } 254,965 \text{ lb/hr wet} \times \overset{16,043}{16.05} \text{ moles/100 lb fuel} = \overset{40,904}{40,922} \text{ moles/hr}$$

$$40,922 \text{ moles/hr} \times 1,545.3 \text{ ft-lb}_f/\text{lb-mole-}^\circ\text{R} \times (350 + 460)^\circ\text{R} \\ \div 2,116.8 \text{ lb}_f/\text{ft}^2 \div 60 \text{ min/hr} = 403,295 \text{ acfm}$$

$$\text{DSCFM: } 254,965 \text{ lb/hr wet} \times \overset{13,771}{13.78} \text{ moles/100 lb fuel} = \overset{35,111}{35,134} \text{ moles/hr}$$

$$35,134 \text{ moles/hr} \times 1,545.3 \times (70 + 460) \div 2,116.8 \div 60 \\ = 226,562 \text{ dscfm}$$

Peat

Based on 50 percent moisture in as-fired fuel, mole method, 25 percent excess air.

	Ultimate Analysis (lb/100 lb fuel)	Moles/ 100 lb Fuel		Required for Combustion Moles/100 lb Fuel at 100 Percent Total Air	
				Oxygen	Dry Air
C	27.88 ÷ 12	= 2.32	x 1.0, 4.76	2.32	11.04
H ₂	2.22 ÷ 2.016	= 1.10	x 0.5, 2.38	0.55	2.62
O ₂	16.11 ÷ 32	= 0.5			
N ₂	0.91 ÷ 28	= 0.03			
S	0.12 ÷ 32	= 0.004	x 1.0, 4.76	0.004	0.02
H ₂ O	50 ÷ 18	= 2.78			
Ash	2.77	--			
TOTAL	100.0	6.73		2.87	13.68
	Less: O ₂ in Fuel			-0.50	-2.38
	Required at 100% Total Air			2.37	11.30
	Required at 125% Total Air			2.96	14.13
	Excess Air			--	2.83
	Excess O ₂			0.59	--

<u>Products of Combustion</u>				Moles/100 lb fuel
CO ₂	2.32	x 1		2.32
H ₂ O	1.1	x 1 + 0.5 + 0.3		1.9
SO ₂	0.004	x 1		0.004
N ₂	14.13	x 0.79		11.16
O ₂ (excess)				0.59
TOTAL WET				15.97
TOTAL DRY				14.07

5/27/81

ACFM: 217,869 lb/hr wet x 15.97 moles/100 lb fuel = 34,794 moles/hr

$$\begin{aligned} & 34,794 \text{ moles/hr} \times 1,545.3 \times (350 + 460) \div 2,116.8 \div 60 \\ & = 342,900 \text{ acfm} \end{aligned}$$

DSCFM: 217,869 lb/hr wet x 14.07 moles/100 lb fuel = 30,654 moles/hr

$$\begin{aligned} & 30,654 \text{ moles/hr} \times 1,545.3 \times (70 + 460) \div 2,116.8 \div 60 \\ & = 197,673 \text{ dscfm} \end{aligned}$$

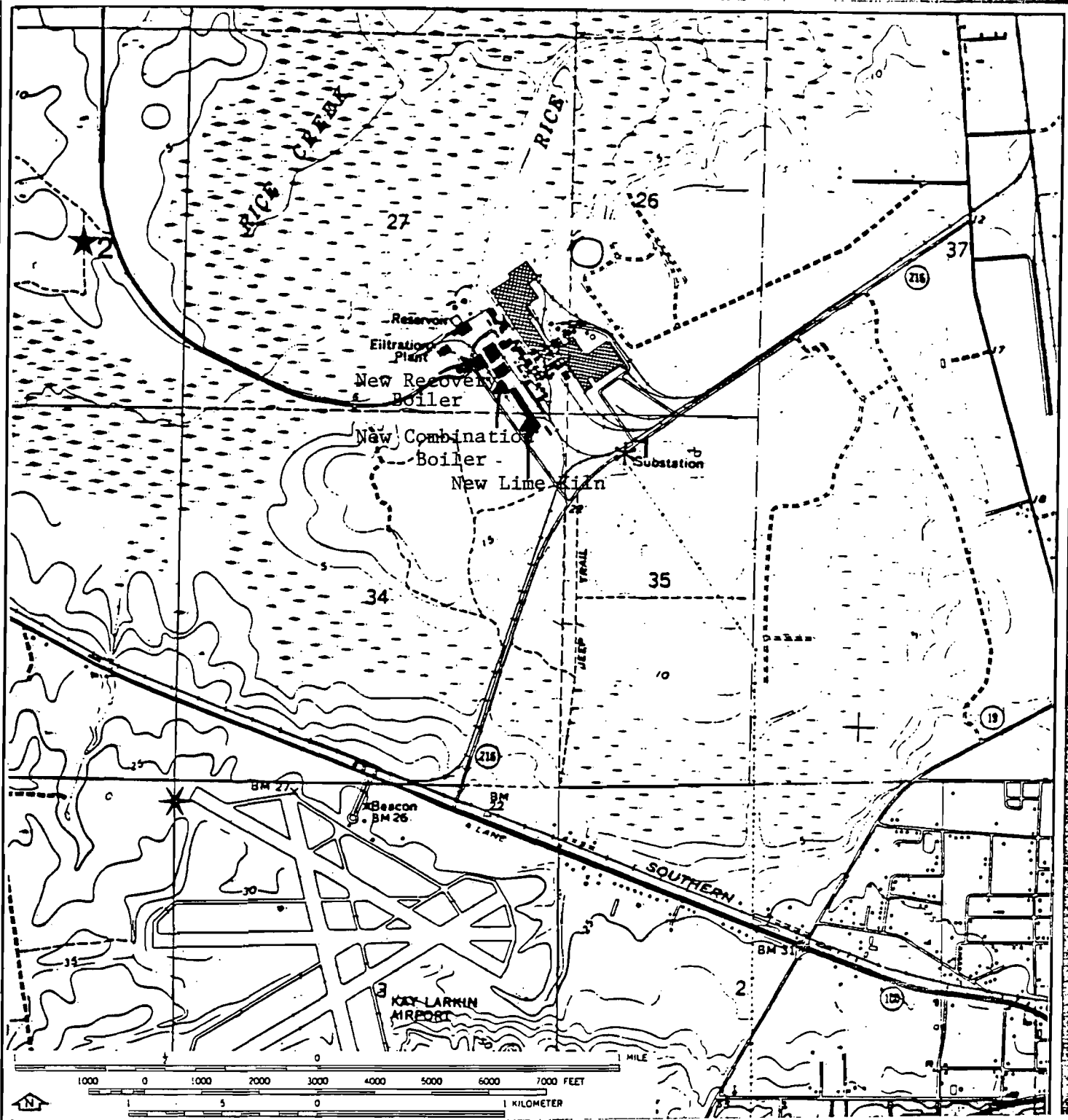

Georgia-Pacific Corporation
 Plot Plan
 Palatka, Florida

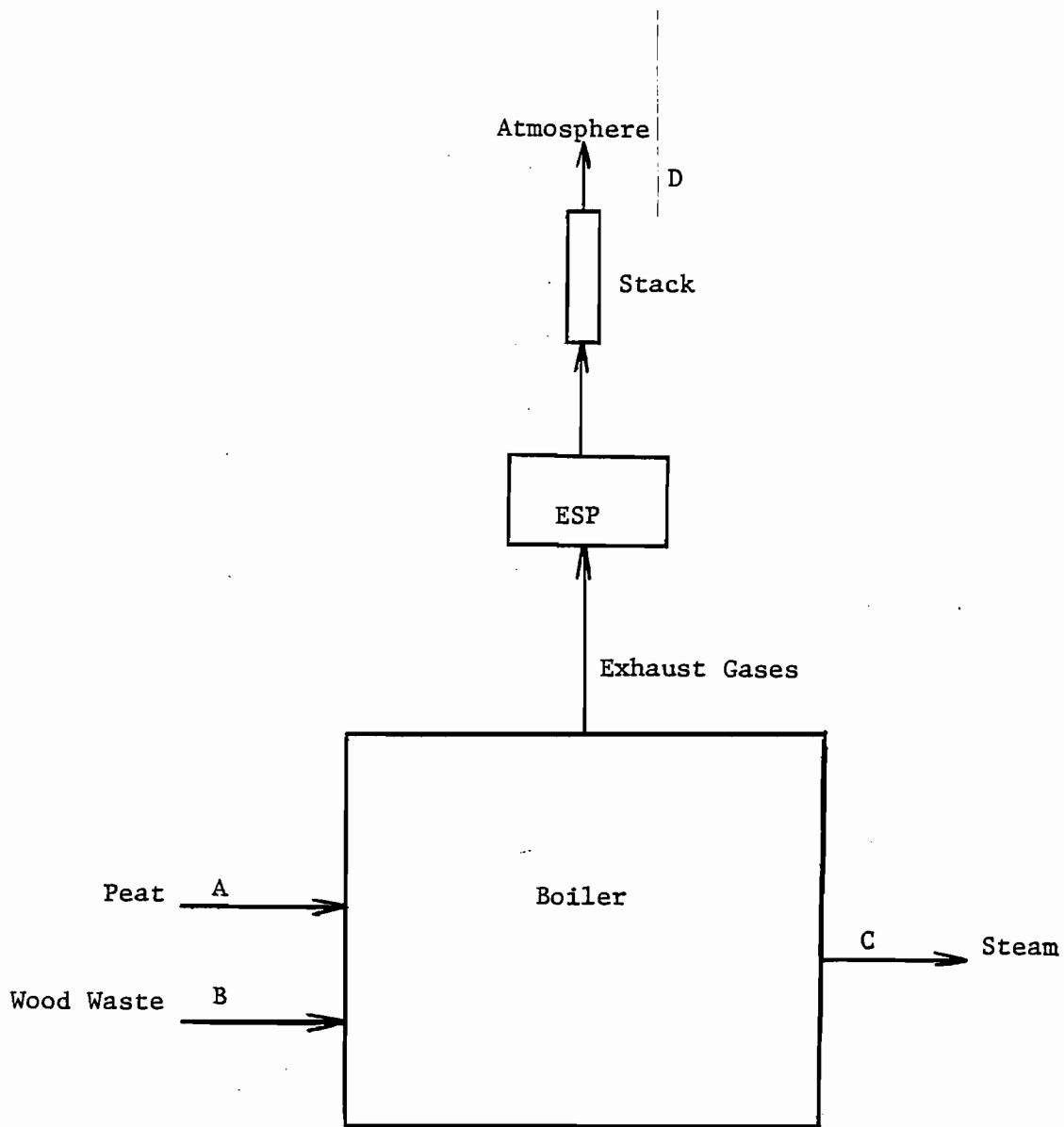

Flow Diagram
Proposed Combination Boiler

PITTSBURGH TESTING LABORATORY

ESTABLISHED 1881

850 POPLAR STREET, PITTSBURGH, PA. 15220

PLEASE REPLY TO:
P. O. BOX 1646
PITTSBURGH, PA. 15230

AS A MUTUAL PROTECTION TO CLIENTS, THE PUBLIC AND OURSELVES, ALL REPORTS ARE SUBMITTED AS THE CONFIDENTIAL PROPERTY OF CLIENTS, AND AUTHORIZATION FOR PUBLICATION OF STATEMENTS, CONCLUSIONS OR EXTRACTS FROM OR REGARDING OUR REPORTS IS RESERVED PENDING OUR WRITTEN APPROVAL.

AREA CODE 412 TELEPHONE 922-4000

LABORATORY No. 813880

ORDER No. PG-16017

CLIENT'S No. Ltr. of 1/15/81
Mr. Paul M. White

REPORT

Feb. 20, 1981

Sample Description: P E A T

Sample Identification: L/4 - P/18 *Little Santa Fe Tract*

Submitted by: Georgia Pacific Corporation

Reported to: Georgia Pacific Corporation
Southern Division
Florida Woodland
P.O. Box 1040
Palatka, Florida 32077

	<u>As Received</u>	<u>Dry Basis</u>	<i>GP Result</i>
Moisture	89.61%	----	
BTU Per Pound	959	9,234	<i>9,024</i>
Carbon	-----	55.76%	
Hydrogen	-----	4.44%	
Oxygen	-----	32.21%	
Nitrogen	-----	1.82%	
Sulfur	-----	.24%	
Ash	-----	5.53%	<i>3.39</i>

PITTSBURGH TESTING LABORATORY

(Signature)
William S. Carlson
Manager, Chemical Department

2-Client
Attn: Mr. Paul M. White

fvl

Steam / its generation and use

Mark D. Mangano

Babcock & Wilcox
161 East 42nd Street, New York, N.Y. 10017

which in turn is cracked to a gas by the heat. Refinery gas is also used for enrichment. It may either be mixed with the steam and passed through the coke bed or mixed directly with the water gas. Such enriched water gas is called "carbureted water gas" (Table 30) and it is piped for relatively short distances through city mains for industrial and domestic consumption. Where it is so used, it is cleaned at the source to remove sulfur gases and other impurities. In many areas use of carbureted water gas has been replaced by natural gas.

Producer gas. When coal or coke is burned with a deficiency of air and a controlled amount of moisture (steam), a gas known as producer gas is obtained. This gas, after removal of entrained ash and sulfur compounds, is used near its source because of its low heating value.

Gasification using in-situ combustion of coal has been carried out by the Bureau of Mines on an experimental basis at Gorgas, Alabama. The purpose of these tests was to demonstrate that energy from coal in seams too thin for mining could be made available through underground gasification. Russia has made producer gas for power generation using this process. This means of gasification is not economically competitive in the U.S. at the present time.

Coke from petroleum

The heavy residuals from the various petroleum cracking processes are presently utilized in a number of ways to produce a higher yield of lighter hydrocarbons and a solid residue suitable for fuel. Characteristics of these residues vary widely, depending on the process used. Solid fuels from oil include delayed coke, fluid coke and petroleum pitch. Some selected analyses are given in Table 31.

Table 31
Selected analyses of solid fuels derived from oil

Analyses (dry basis), % by wt	Delayed Coke		Fluid Coke	
Proximate				
Volatile matter	10.8	9.0	6.0	6.7
Fixed carbon	88.5	90.9	93.7	93.2
Ash	0.7	0.1	0.3	0.1
Ultimate				
Sulfur	9.9	1.5	4.7	5.7
Heating value, Btu/lb	14,700	15,700	14,160	14,290

The delayed coking process uses residual oil heated and pumped to a reactor for coking. Coke is deposited as a solid mass and is subsequently stripped either mechanically or hydraulically, in the form of lumps and granular material. Some of these cokes are easy to burn and pulverize, while others are quite difficult.

Fluid coke is produced by spraying hot residual feed onto externally heated seed coke in a fluid bed. The fluid coke is removed as small particles, which are built up in layers similar to an onion. This coke can be pulverized and burned, or it can be burned in the as-received size in a Cyclone Furnace. Both types of firing require some supplemental fuel to aid ignition.

The process producing petroleum pitch is an alternate to the coking process and yields fuels of various charac-

teristics. Melting points vary considerably and the physical properties vary from soft and gummy to hard and friable. The low melting point pitches may be heated and burned like heavy oil, while those with higher melting points may be pulverized and burned, or crushed and burned in the Cyclone Furnace.

Wood

Selected analyses and heating values of several types of wood (also analyses of wood ash) are given in Table 32. Wood, in common with all types of vegetation, is composed primarily of carbohydrates and consequently has a relatively low heating value compared with bituminous coal and oil.

Wood bark may pick up impurities during transportation. It is common practice to drag the rough logs to central loading points in the logging area. This results in sand pick-up. Where the logs are salt-water borne, bark will absorb sea water with its included salt. Combustion temperatures from burning dry bark may be high enough for impurities to cause fluxing of refractory furnace walls and fouling of boiler heating surfaces, unless sufficient furnace cooling surface is provided. Sand passing through the boiler banks can cause erosion of boiler

Table 32
Analyses of wood and wood ash

Wood analyses (dry basis), % by wt	Pine Bark	Oak Bark	Spruce Bark*	Redwood Bark*
Proximate				
Volatile matter	72.9	76.0	69.6	72.6
Fixed carbon	24.2	18.7	26.6	27.0
Ash	2.9	5.3	3.8	0.4
Ultimate				
Hydrogen	5.6	5.4	5.7	5.1
Carbon	53.4	49.7	51.8	51.9
Sulfur	0.1	0.1	0.1	0.1
Nitrogen	0.1	0.2	0.2	0.1
Oxygen	37.9	39.3	38.4	42.4
Ash	2.9	5.3	3.8	0.4
Heating value, Btu/lb	9030	8370	8740	8350
Ash analyses, % by wt				
SiO ₂	39.0	11.1	32.0	14.3
Fe ₂ O ₃	3.0	3.3	6.4	3.5
TiO ₂	0.2	0.1	0.8	0.3
Al ₂ O ₃	14.0	0.1	11.0	4.0
Mn ₃ O ₄	Trace	Trace	1.5	0.1
CaO	25.5	64.5	25.3	6.0
MgO	6.5	1.2	4.1	6.6
Na ₂ O	1.3	8.9	8.0	18.0
K ₂ O	6.0	0.2	2.4	10.6
SO ₃	0.3	2.0	2.1	7.4
Cl	Trace	Trace	Trace	18.4
Ash fusibility, F				
Reducing				
Initial deformation	2180	2690		
Softening	2240	2720		
Fluid	2310	2740		
Oxidizing				
Initial deformation	2210	2680		
Softening	2280	2730		
Fluid	2350	2750		

* Salt-water stored.

1.6.1 General 1-3

Today, the burning of wood/bark waste in boilers is largely confined to those industries where it is available as a by-product. It is burned both to recover heat energy and to alleviate a potential solid waste disposal problem. Wood/bark waste may include large pieces such as slabs, logs, and bark strips as well as smaller pieces such as ends, shavings, and sawdust. Heating values for this waste range from 8000 to 9000 Btu/lb; on a dry basis; however, because of typical moisture contents of 40 to 75 percent, the as-fired heating values for many wood/bark waste materials range as low as 4000 to 6000 Btu/lb. Generally, bark is the major type of waste burned in pulp mills; whereas, a variable mixture of wood and bark waste, or wood waste alone, is most frequently burned in the lumber, furniture, and plywood industries.

1.6.2 Firing Practices¹⁻³

A variety of boiler firing configurations are utilized for burning wood/bark waste. One common type in smaller operations is the Dutch Oven, or extension type of furnace with a flat grate. In this unit the fuel is fed through the furnace roof and burned in a cone-shaped pile on the grate. In many other, generally larger, operations, more conventional boilers have been modified to burn wood/bark waste. These units may include spreader stokers with traveling grates, vibrating grate stokers, etc., as well as tangentially fired or cyclone fired boilers. Generally, an auxiliary fuel is burned in these units to maintain constant steam when the waste fuel supply fluctuates and/or to provide more steam than is possible from the waste supply alone.

1.6.3 Emissions 1,2,4-8

The major pollutant of concern from wood/bark boilers is particulate matter although other pollutants, particularly carbon monoxide, may be emitted in significant amounts under poor operating conditions. These emissions depend on a number of variables including (1) the composition of the waste fuel burned, (2) the degree of fly-ash reinjection employed, and (3) furnace design and operating conditions.

The composition of wood/bark waste depends largely on the industry from whence it originates. Pulping operations, for instance, produce great quantities of bark that may contain more than 70 percent moisture (by weight) as well as high levels of sand and other noncombustibles. Because of this, bark boilers in pulp mills may emit considerable amounts of particulate matter to the atmosphere unless they are well controlled. On the other hand, some operations such as furniture manufacture, produce a clean, dry (5 to 50 percent moisture) wood waste that results in relatively few particulate emissions when properly burned. Still other operations, such as sawmills, burn a variable mixture of bark and wood waste that results in particulate emissions somewhere in between these two extremes.

Fly-ash reinjection, which is commonly employed in many larger boilers to improve fuel-use efficiency, has a considerable effect on particulate emissions. Because a fraction of the collected fly-ash is reinjected into the boiler, the dust loading from the furnace, and consequently from the collection device, increases significantly per ton of wood waste burned. It is reported that full reinjection can cause a 10-fold increase in the dust loadings of some systems although increases of 1.2 to 2 times are more typical for boilers employing 50 to 100 percent reinjection. A major factor affecting this dust loading increase is the extent to which the sand and other non-combustibles can be successfully separated from the fly-ash before reinjection to the furnace.

Furnace design and operating conditions are particularly important when burning wood and bark waste. For example, because of the high moisture content in this waste, a larger area of refractory surface should be provided to dry the fuel prior to combustion. In addition, sufficient secondary air must be supplied over the fuel bed to burn the volatiles that account for most of the combustible material in the waste. When proper drying conditions

do not exist, or when sufficient secondary air is not available, the combustion temperature is lowered, incomplete combustion occurs, and increased particulate, carbon monoxide, and hydrocarbon emissions will result.

Emission factors for wood waste boilers are presented in Table 1.6-1. For boilers where fly-ash reinjection is employed, two factors are shown: the first represents the dust loading reaching the control equipment; the value in parenthesis represents the dust loading after controls assuming about 80 percent control efficiency. All other factors represent uncontrolled emissions.

Table 1.6-1. EMISSION FACTORS FOR WOOD AND BARK WASTE COMBUSTION IN BOILERS
EMISSION FACTOR RATING: B

Pollutant	Emissions	
	lb/ton	kg/MT
Particulates ^a		
Bark ^{b,c}		
With fly-ash reinjection ^d	75 (15)	37.5 (7.5)
Without fly-ash reinjection	50	25
Wood/bark mixture ^{b,e}		
With fly-ash reinjection ^d	45 (9)	22.5 (4.5)
Without fly-ash reinjection	30	15
Wood ^{f,g}	5-15	2.5-7.5
Sulfur oxides (SO ₂) ^{h,i}	1.5	0.75
Carbon monoxide ^j	2-60	1-30
Hydrocarbons ^k	2-70	1-35
Nitrogen oxides (NO ₂) ^l	10	5

^aThese emission factors were determined for boilers burning gas or oil as an auxiliary fuel, and it was assumed all particulates resulted from the waste fuel alone. When coal is burned as an auxiliary fuel, the appropriate emission factor from Table 1.1-2 should be used in addition to the above factor.

^bThese factors based on an as-fired moisture content of 50 percent.

^cReferences 2, 4, 9.

^dThis factor represents a typical dust loading reaching the control equipment for boilers employing fly-ash reinjection. The value in parenthesis represents emissions after the control equipment assuming an average efficiency of 80 percent.

^eReferences 7, 10.

^fThis waste includes clean, dry (5 to 50 percent moisture) sawdust, shavings, ends, etc., and no bark. For well designed and operated boilers use lower value and higher values for others. This factor is expressed on an as-fired moisture content basis assuming no fly-ash reinjection.

^gReferences 11-13.

^hThis factor is calculated by material balance assuming a maximum sulfur content of 0.1 percent in the waste. When auxiliary fuels are burned, the appropriate factors from Tables 1.1-2, 1.3-1, or 1.4-1 should be used in addition to determine sulfur oxide emissions.

ⁱReferences 1, 5, 7.

^jThis factor is based on engineering judgment and limited data from references 11 through 13. Use lower values for well designed and operated boilers.

^kThis factor is based on limited data from references 13 through 15. Use lower values for well designed and operated boilers.

^lReference 16.

References for Section 1.6

1. Steam, Its Generation and Use, 37th Ed. New York, Babcock and Wilcox Co., 1963. p. 19-7 to 19-10 and 3-A4.
2. Atmospheric Emissions from the Pulp and Paper Manufacturing Industry. U.S. Environmental Protection Agency, Research Triangle Park, N.C. Publication No. EPA-450/1-73-002. September 1973.

- 9. An application fee of \$20, unless exempted by Section 17-4.05(3), F.A.C. The check should be made payable to the Department of Environmental Regulation.
- 10. With an application for operation permit, attach a Certificate of Completion of Construction indicating that the source was constructed as shown in the construction permit.

SECTION VI: BEST AVAILABLE CONTROL TECHNOLOGY

A. Are standards of performance for new stationary sources pursuant to 40 C.F.R. Part 60 applicable to the source?
 Yes No

Contaminant	Rate or Concentration

B. Has EPA declared the best available control technology for this class of sources (If yes, attach copy) Yes No

Contaminant	Rate or Concentration
<u>See Attachment B-Note: These BACT determinations for wood-waste boilers.</u>	
<u>No BACT determinations are known to have been made for a peat/wood waste boiler.</u>	

C. What emission levels do you propose as best available control technology?

Contaminant	Rate or Concentration
<u>Particulate Matter</u>	<u>0.2 lb/10⁶ Btu heat input</u>
<u>Sulfur Dioxide</u>	<u>0.65 lb/10⁶ Btu heat input</u>
<u>Nitrogen Oxides, VOC, CO</u>	<u>Boiler design and proper operation</u>

D. Describe the existing control and treatment technology (if any). See Item VI.E.

- | | |
|---------------------------|----------------------|
| 1. Control Device/System: | |
| 2. Operating Principles: | |
| 3. Efficiency: * | 4. Capital Costs: |
| 5. Useful Life: | 6. Operating Costs: |
| 7. Energy: | 8. Maintenance Cost: |
| 9. Emissions: | |

Contaminant	Rate or Concentration

*Explain method of determining D 3 above.

10. Stack Parameters

- a. Height: _____ ft.
- b. Diameter: _____ ft.
- c. Flow Rate: _____ ACFM
- d. Temperature: _____ °F
- e. Velocity: _____ FPS

E. Describe the control and treatment technology available (As many types as applicable, use additional pages if necessary).

1. Particulate

- a. Control Device: Electrostatic precipitator w/wo Mechanical Collector
- b. Operating Principles: Electrical charging of particles by high-voltage corona, migration of particles to oppositely charged electrode for collection. Cyclone dry collection can be used to reduce particle loading to ESP.
- c. Efficiency*: 99%+ w/o Mech. Collector
- d. Capital Cost: _____
- e. Useful Life: 99.5%+ w Mech. Collector
- f. Operating Cost: See Item F.10.
- g. Energy*: 5 to 10 years
- h. Maintenance Cost: _____
- g. Energy*: 300/450 kw
- i. Availability of construction materials and process chemicals: Good
- j. Applicability to manufacturing processes: Satisfactory. Bark fly ash reported harder to collect because of low resistivity.
- k. Ability to construct with control device, install in available space, and operate within proposed levels: Good. ESP's in operation on wood-fired boilers have demonstrated high, acceptable removal efficiencies.

2. Particulate

- a. Control Device: Venturi Scrubber w/wo Mechanical Collector
- b. Operating Principles: Exhaust gas stream is passed through throat or orifice where gas velocities are very high. Scrubbing liquid is introduced at throat, causing dispersal, and impaction and interception of particulate matter. Cyclone or mist eliminator follows to remove droplets. Mech. Collection used to reduce particulate load to scrubber
- c. Efficiency*: 90%-95% w/o Mech. Collector
- d. Capital Cost: _____
- e. Useful Life: 95%-99%+w Mech. Collector
- f. Operating Cost: See Item F.10.
- g. Energy**: 5 to 10 years
- h. Maintenance Costs: _____
- g. Energy**: 900/1,200 kw
- i. Availability of construction materials and process chemicals: Good
- j. Applicability to manufacturing processes: Good
- k. Ability to construct with control device, install in available space, and operate within proposed levels: Good. Venturi Scrubbers have been proven acceptable in meeting air pollution codes.

*Explain method of determining efficiency.

**Energy to be reported in units of electrical power - KWH design rate.

3. Particulate

- a. Control Device: Fabric filter w/wo Mechanical Collector
- b. Operating Principles: Exhaust gases are passed through a fabric filter where upon a dust cake is formed and particles are removed. Can be preceded by a Mechanical Collector to reduce dust load to baghouse.
- c. Efficiency*: 99%+ w/o Mech. Collector
- d. Capital Cost: _____
- e. Life: 99.5%+ w Mech. Collector
- f. Operating Cost: See Item F.10.
- g. Energy: 15 to 20 years
- h. Maintenance Cost: _____
- g. Energy: 500/800 kw

*Explain method of determining efficiency above.

i. Availability of construction materials and process chemicals:

Good

j. Applicability to manufacturing processes: Only a few installations on wood-fired boilers due to fire hazards. Recently, safety improvements have been made.
k. Ability to construct with control device, install in available space and operate within proposed levels:

4. Particulate

a. Control Device Gravel Bed Filter w/wo Mechanical Collector

b. Operating Principles: Utilizes a moving bed of granular material, through which gas stream is passed and particles are entrapped. Cyclone can precede to reduce dust loading.

c. Efficiency*: 95% wo Mech. Collector
99% w Mech. Collector

d. Capital Cost:

e. Life: 5 to 10 years

f. Operating Cost: See Item F.10.

g. Energy: 450/750 kw

h. Maintenance Cost:

i. Availability of construction materials and process chemicals:

Good

j. Applicability to manufacturing processes:

Has proven to be successful on non-salt wood-waste fired boilers.

k. Ability to construct with control device, install in available space, and operate within proposed levels:
Good. Can generally meet air pollution codes.

F. Describe the control technology selected:

1. Control Device: Electrostatic Precipitator

2. Efficiency*: 99%+

3. Capital Cost:

4. Life: 5 to 10 years

5. Operating Cost: See Item F.10.

6. Energy: 300 kw

7. Maintenance Cost:

8. Manufacturer: Environmental Elements or equivalent

9. Other locations where employed on similar processes:

a. See Attachment B--attached list of ESP installations

(1) Company:

(2) Mailing Address:

(3) City:

(4) State:

(5) Environmental Manager:

(6) Telephone No.:

*Explain method of determining efficiency above.

(7) Emissions*:

Contaminant

Rate or Concentration

Contaminant	Rate or Concentration

(8) Process Rate*:

b.

(1) Company:

(2) Mailing Address:

(3) City:

(4) State:

*Applicant must provide this information when available. Should this information not be available, applicant must state the reason(s) why.

(5) Environmental Manager:

(6) Telephone No.:

(7) Emissions*:

Contaminant	Rate or Concentration
_____	_____
_____	_____
_____	_____

(8) Process Rate*:

10. Reason for selection and description of systems:

ESP's, venturi scrubbers, fabric filters, and gravel bed filters, all with or without mechanical collectors preceding, have been demonstrated to adequately achieve the State of Florida regulation of 0.2 lb/10⁶ Btu heat input due to carbonaceous fuel. All these devices can achieve similar levels of efficient particulate collection, exceeding 99 percent. Mechanical collectors are common on present installations, preceding the more efficient control device, primarily because most of these installations already were equipped with them to meet less stringent pollution codes and were later retrofitted.

Venturi scrubbers have proven to be the most popular devices on wood-waste boilers, due to their wide range of applicability for particulate removal. However, venturi's create a wastewater disposal problem, operating costs are high, and wear on the scrubber can be severe. ESP's have not been used as extensively because the resistivity of wood-waste fly ash makes such particles hard to collect. However, recent improvements and pilot studies on ESP operation now make these devices very attractive (see attached vendor literature). Fabric filters have also historically not been widely used on wood-waste boilers, primarily due to the fire hazard. Recent improvements in fire prevention and safety precautions now make these devices more attractive.

A cost comparison of the various particulate control devices is presented below, based upon three different cost computing sources. Because the parameters and assumptions utilized by each source are different, comparisons cannot be made between the different sources.

*Applicant must provide this information when available. Should this information not be available, applicant must state the reason(s) why.

6/1/81

Control Method	Estimated Efficiency	Capital Costs (\$ x 10 ⁶)			Annual Costs (\$ x 10 ⁶)	
		Ref. 1	Ref. 2	Ref. 3	Ref. 1	Ref. 2
Venturi scrubber	95%	1.5	--	0.7	0.7	--
Venturi scrubber w/mech. collector	99%	--	4.9	1.3	--	2.1
ESP	99%	2.3	--	--	0.5	--
ESP w/mech. collector	99.5%	--	6.6	1.8	--	1.8
Fabric filter	99%	4.4	--	0.9	--	--
Fabric filter w/mech. collector	99.5%	--	7.7	1.5	--	2.2
Gravel bed filter	95%	--	--	0.7	--	--
Gravel bed filter w/mech. collector	99%	--	6.3	1.3	--	1.2

The data indicate the following:

1. Fabric filters display the highest capital costs, with ESP's next and venturi scrubbers the cheapest.
2. The addition of mechanical collectors can significantly increase capital costs, while only significantly increasing overall efficiency for the low efficiency control devices (i.e., gravel bed filter).
3. ESP's result in the lowest annualized costs, except for gravel bed filters, with venturi scrubbers next and baghouses most expensive.
4. ESP's achieve the highest degree of efficiency, as do baghouses, with venturi scrubbers and gravel bed filters displaying lower efficiencies.

To date, five BACT determinations have been made by U.S. EPA for bark and wood-waste boilers. These are summarized below:

Boiler Size	Fuels Fired	Particulate Emission Limit	Control	Efficiency
Approx. 520 x 10 ⁶ Btu/hr	Bark & wood waste only	0.15 lb/10 ⁶ Btu	ESP	96.5%
400,000 lb stm/hr	Wood waste only	0.02 gr/dscf	ESP	--
300,000 lb stm/hr	Wood waste only	0.04 gr/dscf	Venturi scrubber	--
200,000 lb stm/hr	Bark and wood waste	0.04 gr/dscf	Impingement scrubber	--
550,000 lb stm/hr	Bark and wood waste	0.20 lb/10 ⁶ Btu	None listed	--

As shown, both ESP's and venturi scrubbers have been chosen as BACT, with varying resulting emission limits. For two of the applications, ESP's have been chosen.

G-P is proposing an ESP as BACT for particulate matter for the proposed combination peat/wood-waste fired boiler. ESP's are capable of achieving the highest degree of efficiency of any of the available control methods. Venturi scrubbers were rejected because of their high operating costs, maintenance and energy requirements, and waste-water disposal problems. Fabric filters were rejected because of their lack of widespread use on wood-waste boilers, their potential fire hazard, and their high annualized costs.

Because very limited data are available on the characteristics of peat firing, i.e., particle size, composition, resistivity, etc., and no full-scale boiler operations are known to exist in the U.S. at this time, G-P is proposing a BACT emission limit equal to the Florida carbonaceous fuel-burning regulation of 0.2 lb/10⁶ Btu. This is approximately equivalent to an outlet grain loading of 0.11 gr/dscf based upon theoretical combustion calculations. It is believed a lower emission rate and grain loading can be achieved, but until further test data become available, G-P does not want to commit to any lower limit. As design data concerning the ESP become available, G-P will submit such information to the Florida DER. The PSD report indicates that the proposed emission level does not adversely affect particulate matter air quality levels in the area of the G-P mill.

10. Stack Parameters

- a. Height: ft.
- b. Diameter: ft.
- c. Flow Rate: ACFM
- d. Temperature: °F
- e. Velocity: FPS

E. Describe the control and treatment technology available (As many types as applicable, use additional pages if necessary).

1. Sulfur Dioxide

- a. Control Device: Sodium Scrubbing
- b. Operating Principles: Wet scrubbing with aqueous solution, SO₂ is absorbed by solution. Requires sludge disposal, water treatment, and solution preparation.
- c. Efficiency*: 90%+
- d. Capital Cost: \$4.0 million
- e. Useful Life: 5 to 10 years
- f. Operating Cost: Annualized costs = \$2.3 million
- g. Energy*: 2,400 kw
- h. Maintenance Cost:
- i. Availability of construction materials and process chemicals:
Assumed adequate
- j. Applicability to manufacturing processes:
Has been applied to coal boilers
- k. Ability to construct with control device, install in available space, and operate within proposed levels:
Assumed adequate

2. Sulfur Dioxide

- a. Control Device: Dual Alkali Scrubbing
- b. Operating Principles: Wet scrubbing of SO₂ gases by absorption in alkaline solution. Requires sludge disposal, water treatment, and solution preparation. Regeneration of solution by calcium alkali.
- c. Efficiency*: 90%+
- d. Capital Cost: \$4.8 million
- e. Useful Life: 5 to 10 years
- f. Operating Cost: Annualized costs = \$2.4 million
- g. Energy**: 1,900 kw
- h. Maintenance Costs:
- i. Availability of construction materials and process chemicals:
Assumed good.
- j. Applicability to manufacturing processes:
Has been applied to coal boilers
- k. Ability to construct with control device, install in available space, and operate within proposed levels:
Assumed adequate. Requires large land area for waste disposal.

*Explain method of determining efficiency.

**Energy to be reported in units of electrical power - KWH design rate.

3. Sulfur Dioxide

- a. Control Device: Lime/Limestone Scrubbing
- b. Operating Principles: Wet scrubbing with lime/limestone slurry. Waste disposal to settling pond, water recycle. SO₂ is absorbed by aqueous solution.
- c. Efficiency*: 90%+
- d. Capital Cost: \$5.4 million
- e. Life: 5 to 10 years
- f. Operating Cost: Annualized costs = \$2.9 million
- g. Energy: 4,800 kw
- h. Maintenance Cost:

*Explain method of determining efficiency above.

i. Availability of construction materials and process chemicals:

Good

j. Applicability to manufacturing processes:

Has been applied to coal boilers

k. Ability to construct with control device, install in available space and operate within proposed levels:

Assumed satisfactory. Requires large land area for waste disposal.

4. Sulfur Dioxide

a. Control Device: Low Sulfur Fuel (Peat/Wood)

b. Operating Principles: Low sulfur-containing fuels are utilized in the boiler, such as wood and/or peat.

c. Efficiency*:

d. Capital Cost:

e. Life: See Item F

f. Operating Cost: See Item F

g. Energy:

h. Maintenance Cost:

i. Availability of construction materials and process chemicals:

Good

j. Applicability to manufacturing processes:

k. Ability to construct with control device, install in available space, and operate within proposed levels:

F. Describe the control technology selected:

1. Control Device: Low Sulfur Fuel (Peat/Wood)

2. Efficiency*: 78%+, based upon comparison with 2.5% S oil

3. Capital Cost: Essentially none

4. Life:

5. Operating Cost:

6. Energy: None required except for fuel handling

7. Maintenance Cost: None

8. Manufacturer:

Not applicable

9. Other locations where employed on similar processes:

a. No known facilities presently burning peat. Many Kraft Pulp Mill boilers burning wood waste as fuel.

(1) Company:

(2) Mailing Address:

(3) City:

(4) State:

(5) Environmental Manager:

(6) Telephone No.:

*Explain method of determining efficiency above.

(7) Emissions*:

Contaminant

Rate or Concentration

Contaminant	Rate or Concentration

(8) Process Rate*:

b.

(1) Company:

(2) Mailing Address:

(3) City:

(4) State:

*Applicant must provide this information when available. Should this information not be available, applicant must state the reason(s) why.

(5) Environmental Manager:

(6) Telephone No.:

(7) Emissions*:

Contaminant	Rate or Concentration

(8) Process Rate*:

10. Reason for selection and description of systems:

Sulfur Dioxide

The firing of peat and/or wood waste is chosen as the best system of emission reduction considering energy, environmental, and economic impacts. Peat and wood waste both have inherent low sulfur contents. Based upon the AP-42 factor for wood waste burning of 1.5 lb/ton wet and a Btu value of 4,250 Btu/lb wet, SO₂ emissions from wood waste are equivalent to 0.18 lb/10⁶ Btu. Similarly, based upon 0.15 percent S max (wet basis) and 4,617 Btu/lb SO₂ emissions from peat are equivalent to 0.65 lb/10⁶ Btu heat input. Both of these values are well below the NSPS for fossil-fuel steam generators (non-utility) firing liquid fuel of 0.8 lb/10⁶ Btu.

In addition, the available literature concerning peat firing indicates as much as 80 percent of the theoretical SO₂ is contained in the bottom ash or absorbed by the fly ash, therefore, it is expected that SO₂ emissions will be lower than the maximum figures presented herein. However, until the proposed unit becomes operational or test firings are conducted, the actual removal for Florida peat fired in a large wood waste boiler cannot be determined.

Presented below are several alternative fuel usage scenarios based upon peat, wood waste, and oil firing.

*Applicant must provide this information when available. Should this information not be available, applicant must state the reason(s) why.

Percentage of Steam Produced From:				Sulfur Dioxide Emissions (tons/year)
Peat	Wood Waste	2.5% S Oil	1.0% S Oil	
70%	30%	---	--	2,206
--	--	100	--	10,131
--	--	--	100	4,052
--	50	50	--	5,475
--	100	--	--	818

The 70% peat/30% wood waste scenario is the anticipated usage for the proposed combination boiler. As shown, SO₂ emissions from this fuel scenario are about five (5) times less than from burning high-sulfur fuel oil and about a factor of two (2) times less than burning low-sulfur fuel oil. The peat/wood-waste scenario is also much less than a combination boiler fired by 50% wood waste and 50% oil. Only the 100% wood-waste firing represents lower SO₂ emission.

Out of five (5) BACT determinations by U.S. EPA on bark and wood-waste boilers, only one resulted in SO₂ emission limits being set. This was for a wood-waste only boiler, with a limit of 0.21 lb/10⁶ Btu. None of the BACT determinations resulted in add-on SO₂ removal systems.

Add-on SO₂ removal systems for the proposed combination boiler were not considered justified due to the inherent low sulfur content of peat and wood waste, the excessive costs associated with an add-on system (estimated at over \$4 million dollars capital costs and \$2.3 million annualized costs), and the solid waste disposal and handling problems associated with these devices. The firing of peat and wood-waste in the proposed boiler is considered to be BACT, with a proposed maximum emission limit of 0.65 lb/10⁶ Btu (based upon peat firing and until further data becomes available). As shown in the PSD report, this emission level does not adversely impact air quality in the area of the G-P mill.

Nitrogen Oxides, VOC, CO

Nitrogen oxides emissions have generally not been addressed in the literature with respect to wood waste and peat-fired boilers. The NCASI study (see attached copy) is the most specific study to date, dealing with wood-waste emissions. NO_x emissions from wood waste boilers were demonstrated to be significantly less than the AP-42 factor of 10 lb/ton wet wood waste. The highest measured rate was 1.91 lb/ton wet wood waste, or 0.21 lb/10⁶ Btu. This is less than the NSPS for liquid fuel-burning fossil fuel steam generators of 0.3 lb/10⁶ Btu. No significant dependence of NO_x on boiler size was found. Because of its low NO_x production, the proper burning of wood-waste (with peat assumed similar) and proper boiler operation is considered as the best available control technology. However, it is probable further reductions in NO_x emissions can be achieved by applying typical NO_x reduction techniques: flue gas recirculation; low excess air firing, low air preheat, and burner and boiler design. These techniques however must be balanced with proper boiler operation and the effects upon VOC and CO emissions considered.

Similarly, VOC emissions reported recently by NCASI for wood-waste burning are one-half or less of the AP-42 factor of about 0.22 lb/10⁶ Btu. Emissions were found by NCASI to be a function of the percent overfire air utilized in the boiler: the greater the percentage of overfire, the lower the VOC emissions. Boilers using overfire air promote good combustion and thereby minimize VOC emissions. No relationship between VOC emissions and steam production, and flue gas moisture and temperature were found. Since no add-on VOC controls are feasible, and the proposed boiler will utilize suspension burning which promotes air/fuel mixing and good combustion, the proper firing of wood waste and peat and good boiler operation is considered to be BACT.

No add-on controls are feasible for CO, and again proper boiler operation and firing practices are considered as BACT. Although emissions of NO_x, VOC, and CO from peat burning are expected to be

in the range of emissions from wood-waste burning, little literature is available on specific emission rates. Therefore, only "good boiler operation" is proposed as BACT at this time, with no specific emission limits.

REFERENCES

1. Operation and Maintenance of Particulate Control Devices in Kraft Pulp Mill and Crushed Stone Industries. PEDCO Environmental Specialists, Inc., Cincinnati, Ohio. EPA-600/2-78-210, October 1978.
2. Nonfossil Fuel-Fired Boilers--Background Information for Proposed Standards, Draft EPA Report, Chapters 3-9.
3. Control of Particulate Emission from Wood-Fired Boilers. PEDCO Environmental, Inc. EPA 340/1-77-026, 1977.
4. Personal Communication. Neal R. Davis, Applications Engineer, Environmental Elements Corporation, Baltimore, Maryland. May 22, 1981.
5. Technology Assessment Report for Industrial Boiler Applications: NO_x Flue Gas Treatment. Radian Corporation, EPA-600/7-79-178 g, December, 1978.
6. Control Techniques for Nitrogen Oxides Emissions from Stationary Sources, Second Edition. Acurex Corp., EPA-450/1-78-001, January 1978.
7. NO_x Emissions from Combustion Sources in the Pulp and Paper Industry. Hood, H.T. and Maner, R.A., NCASI. Paper presented at 1981 TAPPI Environmental Conference, New Orleans, LA.
8. Volatile Organic Compound Emissions from Pacific Northwest Pulp and Paper Industry Combustion Sources. Dallons, V.J. and Simon, C., NCASI. Paper presented at 1981 TAPPI Environmental Conference, New Orleans, LA.
9. Compilation of BACT/LAER Determinations, Revised. PEDCO Environmental Specialists, Inc. EPA-950/2-08-070, May 1980.

Attachment B

Combination Boiler BACT Information

Note: Neither the ESP equipment vendor nor the specific ESP model have yet been selected; therefore, generic design data are presented. Once specific equipment data become available, they will be provided to Florida DER.

1. Efficiency Calculations (based on wood-waste firing)

Maximum emissions at State of Florida Standard = 216.7 lb/hr
Potential emissions (uncontrolled) = 9,561 lb/hr.

Required efficiency = $(9,561 - 216.7) \div 9,561 \times 100 = 97.7\%$.

2. Outlet grain loading at 216.7 lb/hr = 0.11 gr/dscf (see Attachment A).

BACT/LAER CLEARINGHOUSE REPORT

(not a kraft process)

SOURCE TYPE/SIZE: New bark/wood-waste boiler (72.4 tons of bark per hour @ 60% moisture) at an existing Paper Mill

NAME/ADDRESS: Great Northern Paper Co., East Millinocket, Maine 04430

DETERMINATION IS: ~~CONSTRUCTION~~/FINAL/~~PERMITS~~ ISSUED on May 1, 1979, BASIS* of ~~BACT/LAER~~/BAC¹ for ~~NEW~~/MODIFIED SOURCE (date)

BY Environmental Protection Agency Region I (Agency) John Courcier (Person) 223-4448 (Phone)

<u>PERMIT PARAMETERS:</u> AFFECTED FACILITIES	<u>THROUGHPUT CAPACITY</u> (Weight Rate)	<u>POLLUTANT (s)</u> EMITTED	<u>EMISSION LIMIT (s)</u> and (basis for)**	<u>CONTROL STRATEGY DESCRIPT</u> Equipment Type, Etc.	<u>Eff</u>
Bark & Wood-waste Boiler	72.4 Tons of bark per hour (@ 60% moisture)	TSP	0.15 [#] /MBtu (B)	ESP	96.4%
		SO ₂	0.21 [#] /MBtu - Bark Only (State Permit)	Displacing oil consumption by burning bark	-
		NO ₂	0.70 [#] /MBtu-bark on bark oil 0.30 [#] /MBtu-oil (State Permit)	Design Features in Boiler	-
		CO	0.23 [#] /MBtu - (B)	Design Features in Boiler	-
		HC	0.23 [#] /MBtu - (B)	Design Features in Boiler	-

NOTES: Source will be allowed to continue using 2.5% S oil during emergency situations. It was determined that the severe economic and energy impact of using a lower sulfur oil when compared with the nominal environmental benefits did not justify the switch to the low S. oil.

* Circle one. BACT¹ means a determination made under pre-1977 amendments; BACT² means post-1977 amendments to CAA.
** Basis symbols: Use B=BACT, N=NSPS, C=SIP, L=LAER

BACT/LAER CLEARINGHOUSE REPORT

1.3

SOURCE TYPE/SIZE: Power Plant - Wood Waste Fired

NAME/ADDRESS: Washington Water Power Kettle Falls, WA

DETERMINATION DATA: CONDITIONAL **FINAL** PENDING for BACT/LAER on **NEW** MODIFIED SOURCE
 KEY DATES: Application-Recd. _____, Completed _____; Determination-Proposed _____, Final 3/13/80

BY: (Agency) EPA Region X Person Paul Boys Phone _____

AFFECTED FACILITIES	THROUGHPUT CAPACITY	EMISSION RATE* -UNCONTROLLED	EMISSION LIMITS (Basis)**	CONTROL STRATEGY DESCRIPTION Equipment type, etc.	Eff. %
Wood fired boiler	400,000#steam/hr	PM	.02gr./dscf@12% CO ₂ (B)	electrostatic precipitator	
			Opacity 10% (B)		
		NOx	456(T/yr) (N)	proper equipment operation	
		CO	701(T/yr) (N)		
		HC	701(T/yr) (N)		

SOURCE OPERATION: BATCH/CONTINUOUS: _____ hrs/yr; % by Season W Sp Su F

NOTES: _____

* Specify pollutant (PM, SO₂, NO_x, HC, CO or other) and mass emission rate
 ** Basis symbols: Use B = BACT, N = NSPS, S = SIP, A = Achieved-in-Practice (AIP)

BACT/LAER CLEARINGHOUSE REPORT

1.3

SOURCE TYPE/SIZE: Hog fuel boiler/300,000 lb/hr steam

NAME/ADDRESS: Publishers Paper Newburg, Oregon

DETERMINATION DATA: CONDITIONAL **FINAL** PENDING for BACT/LAER or **NEW** MODIFIED SOURCE

KEY DATES: Application-Recd. _____, Completed _____; Determination-Proposed _____, Final 9/6/79

BY: (Agency) EPA Region X Person Paul Boys Phone _____

AFFECTED FACILITIES	THROUGHPUT CAPACITY	EMISSION RATE* -UNCONTROLLED	EMISSION LIMITS (Basis)**	CONTROL STRATEGY DESCRIPTION Equipment type, etc.	Eff. %
Hog fuel boiler	300,000 lb/hr steam	TSP	0.04 gr/dscf (B)	venturi scrubber	
		CO	569 ton/yr (B)	efficient operation	
		HC	569 ton/yr (B)	efficient operation	
		NOx	2850 ton/yr (B)	efficient operation	

SOURCE OPERATION: BATCH/CONTINUOUS: _____ hrs/yr; % by Season W Sp Su F

NOTES: _____

* Specify pollutant (PM, SO₂, NO_x, HC, CO or other) and mass emission rate
 ** Basis symbols: Use B = BACT, N = NSPS, S = SIP, A = Achieved-in-Practice (AIP)

BACT/LAER CLEARINGHOUSE REPORT

SOURCE TYPE/SIZE: KRAFT PULP MILL

PULPING CAPACITY 1034 TONS/DAY

NAME/ADDRESS: BOISE CASCADE, P.O. BOX 500, WALLULA, WA 99363

DETERMINATION IS: CONDITIONAL/FINAL/PENDING: DATE OF ISSUE: 2/24/78 BASIS: * BACT¹ LAER/BACT² FOR NEW/MODIFIED SOURCE

BY EPA REGION X (Agency) LARRY SIMS AND PAUL BOYS (Person) (206) 442-1106 (Phone)

Table with 5 columns: PERMIT PARAMETERS, AFFECTED FACILITIES, THROUGHPUT CAPACITY, weight rate, POLLUTANT(S) EMITTED, EMISSION LIMIT(S) AND BASIS FOR**, CONTROL STRATEGY DESCRIPTION (Equipment type, etc., Eff.,%). Rows include Hogfuel boiler and Power boiler with various pollutants and control strategies.

NOTES:

* Circle one. BACT-1 indicates determination made under pre-1977 amendments; BACT-2 indicates post-1977 amendments to CAA.

** Basis symbols: Use B = BACT, N = NSPS, S = SIP, L = LAER, P = PSD Increment

465

BACT/LAER CLEARINGHOUSE REPORT

1.3

SOURCE TYPE/SIZE: Hog fuel boiler/550,000 lb/hr steam

NAME/ADDRESS: Potlatch, Lewiston, Idaho

DETERMINATION DATA: CONDITIONAL/FINAL PENDING for BACT/LAER on NEW MODIFIED SOURCE
 KEY DATES: Application-Recd. _____, Completed _____; Determination-Proposed _____, Final 8/19/80

BY: (Agency) EPA Region X Person Paul Boys Phone _____

AFFECTED FACILITIES	THROUGHPUT CAPACITY	EMISSION RATE* -UNCONTROLLED	EMISSION LIMITS (Basis)**	CONTROL STRATEGY DESCRIPTION Equipment type, etc.	Eff. %
#4 Power Boiler	550,000lb/hr steam	NOx	0.2 lb/10 ⁶ Btu (B)	Continuous air discharge grate, suspension firing of dry wood, tangential firing, large firebox	

SOURCE OPERATION: BATCH/CONTINUOUS: _____ hrs/yr; % by Season _____
 W Sp Su F

NOTES: _____

* Specify pollutant (PM, SO₂, NO_x, HC, CO or other) and mass emission rate
 ** Basis symbols: Use B = BACT, N = NSPS, S = SIP, A = Achieved-in-Practice (AIP)

Pilot Precipitator Studies on Combination Fuel Boilers

Clyde O. Humbert
Manager, Field Engineering
Air Cleaning Systems Group
Environmental Elements Corporation
Baltimore, Md. 21203

Neil R. Davis
Field Engineer
Air Cleaning Systems Group
Environmental Elements Corporation
Baltimore, Md. 21203

Abstract

Environmental Elements Corporation, a subsidiary of Koppers Company, Inc., has employed an "In-house" pilot sized precipitator to study the precipitability of the particulate emanating from certain combination fuel-fired boilers. Studies were made with boilers burning bark and coal, bark and natural gas, and bark and oil. The results of these studies are described in this paper.

INTRODUCTION

Since the beginning of man's reign in our world, efforts have been continuing to extract the most energy out of whatever was at hand. Back in the days of the caveman, whenever an animal was killed, nearly every part of it was used. The meat was eaten, the skin treated and made into clothing or coverings, and the bones made into utensils, tools, and weapons. In those days, this was necessary because their weapons were such that they were unable to obtain an abundance of anything.

As man's technology advanced, he went through an era of waste. The thought then was that the earth's resources were unlimited, and man used them with this in mind. The great herds of buffalo, once thought to be limitless, are now almost extinct. Many other animals and other natural resources have suffered the same fate. We have, in time, come almost full circle, back to the realization that we can no longer waste energy that we must use our natural resources wisely, because in most cases, Mother Nature is slow to replace or replenish the supply.

An example of this awareness appeared in a recent advertisement from Georgia-Pacific. The American Pioneers were a hardy lot, but in clearing the land for home and farm, they consumed our forest resources at a rate we couldn't live with today. For a typical 320 sq. ft. (29.73 m²) (16 ft. x 20 ft.) (4.88m x 6.10m) log cabin, our forebearers used 70 trees and burned what was left over. Today, that same number of trees would provide a 3,500 sq. ft. (325.16 m²) home - plus enough tissue and paper product for an average family - for over 30 years. Today we know that we must grow our trees scientifically and manage our forests so that we can have a continuous harvest to feed the seemingly insatiable hunger for wood, for paper, and for paper products. Part of this process includes the complete utilization of all parts of the trees. The pulp and paper industry make paper from the cellulose fibers, which amount to about 50% of this primary raw material. Steam is generated by burning the remainder in the form of waste liquor and bark. I'm certain that all of you are aware of the processes that produce the bark which is a sizable by-product which must be disposed of, so I won't burden you with a description of them, but merely say that bark is a fuel, it is available, it will continue to be available, it is being used as a fuel, and it will continue to be used as a fuel. However, since it is a fuel and has an ash content, the various governments have decreed that the exhausting of this material into the atmosphere must be controlled. The burning of bark as a fuel is not a new concept but has been in progress for many years. Also, the pulp and paper industry have long ago recognized the fact that the exhaust gases from these combination boilers had to be treated to remove much of the resultant fly ash. It has been common practice to install mechanical collectors (cyclones, multiclones, etc.) in the system. Since the ash from this coal and bark firing usually contained a large amount of unburned material, the collected ash was re injected into the furnace. This method is nominally 70-80% efficient when the collector is well maintained, but could easily degrade to 50% or less if the collector is not maintained properly.

Since today's pollution control regulations require that discharges must be much less than that attainable with this type of collector, Environmental Elements Corporation deployed their mobile pilot precipitator to study the precipitability of fly ashes that originate in this type of steam generator. Our first investigation into the feasibility of using an electrostatic precipitator on a combination fuel boiler was at the Covington, Virginia Mill of the West Virginia Pulp and Paper Company. This boiler burned a combination of bark and coal in a traveling-grate stoker-fired

boiler. Two studies were made there, one with the fly ash that was removed by the cyclones reinjected into the boiler, and one without the fly ash reinjected. The second and most recent study into this subject was at the Ferguson Mill of the St. Regis Paper Company at Monticello, Mississippi. This boiler burns a combination of bark and natural gas or bark and No. 6 fuel oil. Here, of course, the only fuel burned on the traveling-grate stoker is the bark. This paper will be devoted to the presentation of the results of these studies.

The Covington, Virginia Mill of the West Virginia Pulp and Paper Company operates a power station which produces its own electrical power and uses the exhaust steam from the generators throughout the mill for processing. In two stoker-fired boilers they supplement their coal firing with the bark removed from the wood before pulping. In addition to obtaining the additional energy, it also eliminates the need of otherwise disposing of the bark. The boilers fire, on the average, between 32,500 to 35,000 pounds (13,620 to 15,890 Kg.) of bark per hour and were equipped with mechanical collectors of the multiclone type. The Ferguson Mill of the St. Regis Paper Company has a power station which combines the outputs of their waste heat boilers, a small package boiler and combination boiler which was used in this program. This plant normally produces all of the electrical power required in the mill. The combination boiler is rated at 600,000# (272,400 Kg.) of steam per hour. Normally, 60-70% of the fuel used is bark which is supplemented with gas or oil.

Test Equipment (Plate A)

The pilot precipitator used in the WESTVACO tests was a single chamber, 4 gas passage, 2 field precipitator, rigidly mounted on a 32 ft. (9.75m) semi-trailer. The discharge electrodes are mounted in pipe frames. The collecting plates are 10 gauge (3.571mm) flat plates, 4 ft. (1.22m) wide with a vertical center stiffener. The wire frames are suspended from a single center-bolt through the top pipe to a half-round, T-slotted bar, and are supported by insulators. The insulator compartments are outside the gas stream, and power is conveyed to the unit from the potheads by a metal bus bar. The plates are suspended from their corners on traverse support bars. The center two traverse bars are connected by a heavy bar with a center tapered socket which accepts the inner end of the plate rapper rod. The rapper rod projects through the roof with a multiflex boot providing a seal. The entire roof is removable so that alignment may be made or plate and/or frames removed or replaced. A small access door is provided between the fields on the side of the unit for inspection and/or maintenance. Transition sections at the inlet and outlet provide for the proper channeling of the gases into and out of the precipitator. Two perforated plates are installed in the inlet transition to give optimum flow distribution. The front end of the semi-trailer is enclosed and houses the transformer/rectifier, all electrical instruments and meters, and the necessary gear for running efficiency determinations. An eighteen inch diameter (.457m) duct was used to transport the gases from the boiler room, and the discharge was a short stack mounted directly on top of the fan. Test ports were located at the required distances from duct disturbances, and all tests were made at a single point. Traverses were made early in the program, and samples were withdrawn from a point of average velocity. An orifice with orifice taps was installed in the inlet duct, calibrated, and later used to set flow through the precipitator.

The pilot precipitator used in the St. Regis Paper Company tests was our, shall we say, Mark II model. Time and hard use finally rendered the first unit unfit for active duty, so a second one was built. Experience, gained from many tests run with the first unit brought about a much more sophisticated, and easier to operate unit. We have unitized it, so that it can be installed in places where the earlier one

could not. We have improved the housing of the new one so that assembly can be more easily accomplished. We have installed automatic power controls to replace the old manual control. The control room is separate and contains improved instrumentation. The same 2.2 KVA transformer/rectifier is used, but it is located directly on the precipitator. Discharge electrode rappers have been installed and can be operated during the test if so desired. Plate rapping still employs a pneumatic impulse rapper which is normally actuated once each 30 seconds. A reverse impact pitot tube connected to a differential pressure gauge is now used to set and monitor flow which is controlled by a radial vane damper on the fan.

Test Procedure

Testing for efficiency in the WESTVACO Test Program was in accordance with ASME Power Test Codes 21 and 27 with some slight modifications, using medium porosity alundum thimbles. The tests conducted at St. Regis further modified the PTCs to use an instack Gelman Type A47 mm glass fibre filter at the outlet test station due to the small amount of sample collected during the short time duration tests. Alundum thimbles were used to determine inlet loadings as before.

Conclusions on Bark and Coal-Fired Boiler

Following the test program on the bark and coal boiler at WESTVACO, it was concluded that the precipitability of the ash could be classed as medium to good with 100% of the ash being reinjected. Precipitability decreased as the amount of reinjection decreased. Performance indicated that barbed wire discharge electrodes would be recommended with high intensity collector electrode rapping.

Summary of Results on Bark and Coal-Fired Boiler

The program was conducted using a stabilized efficiency method. Parameters were set up, such as gas velocity, rapper pressure, rapper interval, etc. early in the day. Sampling tests of 60 minutes duration were conducted over an eight to ten hour test period. A plot of these test results (Figures 1-A & 1-B) showed how collection efficiency varied with time. Parameters were varied from day to day until performance was constant. This represented the conditions at which the precipitator wanted to run. These numbers were then used in calculating appropriate sizes or a full size precipitator. Other information gained from these tests indicated that, even though the fly ash produced by the coal and ash was on the high side of what we consider normal resistivity, being 1.5×10^{11} ohm-cm, it was readily precipitable because of the high combustible content in the ash (25% LOI) plus the high moisture content of the gases (10-12%).

The effect of velocity was also studied, and we found that for increases in velocity from 3 ft./sec. (.9141m/sec.) to 5 ft./sec. (1.52m/sec.) the collection efficiency remained relatively constant.

The coal burned during the tests was an eastern, low sulfur (less than 1%S), high volatile bituminous coal with approximately 7.0% ash. Two types of discharge electrodes were tested - barbed and squared. The barbed indicated better performance. The high content of combustibles in the ash and the presence of an occasional, large fragment of still-burning bark was always possible. Self-ignition of the ash in the holding tank after removal from the pilot precipitator occurred several times which lead to a recommendation of some type of continuous ash removal system. Small buildups in the precipitator presented no problems along

these lines, but the lack of inleakage kept the oxygen levels low and greatly reduced the chances of ignition either on the collecting surfaces or in hoppers, etc. The presence of a multiclone mechanical collector in front of the precipitator would be a help in removing most of the larger particles, although in the later study these sparkers were still encountered, despite the presence of a multiclone collector.

Another factor noted during the test period was, that when the bark was removed from the fuel supply, precipitator performance declined. This reflects truly the fact that low sulfur coal was being burned. When the moisture was lowered from 10-13% to 4-7%, the resistivity of the resultant ash was probably very high, and even though the inlet loading was reduced almost 50%, the residual was higher, being typically like a precipitator collecting ash from a low sulfur coal-fired boiler.

COAL ANALYSES (AS RECEIVED)

<u>Sample Date</u>	<u>Percent Moisture</u>	<u>Percent Volatile</u>	<u>Percent Fixed Carbon</u>	<u>Percent Ash</u>	<u>Percent Sulfur</u>
4/20	0.93	31.7	61.5	6.7	1.14
4/21	1.10	32.4	60.8	6.8	0.95
4/22	0.98	34.4	59.4	6.4	0.88
4/23	0.93	32.3	61.6	6.1	0.81
4/26	1.86	32.2	60.2	7.6	0.84
4/27	3.91	23.7	45.1	31.4	0.55*
4/28	1.49	31.4	60.9	7.7	0.97
4/29	1.12	32.5	59.6	7.9	1.00
4/30	1.24	32.2	61.4	6.3	0.95
5/1	1.30	33.0	58.8	8.2	1.01

*Bad Sample

Figure 1-A.

ASH ANALYSES

<u>Sample Date</u>	<u>Fly Ash Reinjection</u>	<u>Ash Bark Firing</u>	<u>Resistivity Ohm-CM</u>	<u>Percent Loss on lgn.</u>	<u>Fineness % 10</u>
4/21	Full	No	1.5×10^{11}	25.2	14.5
4/28	Full	Yes	7.2×10^7	18.6	17.0
4/29 (A M)	Part	Yes	5.7×10^7	29.1	11.0
4/29 (P M)	Part.	Yes	1.5×10^7	26.3	7.1

Figure 1-B.

Conclusions on Bark and Oil or Gas-Fired Boiler

The ash produced by bark and oil or bark and gas firing could be classified as relatively easily precipitated. The ash produced by bark and oil firing produced a higher collection efficiency than the ash from bark and gas firing. Only one of our standard discharge electrodes was employed in the main phase of our program.

Summary of Results on Bark
and Gas or Oil-Fired Boiler

The test program at the Ferguson Mill of the St. Regis Paper Company was conducted in a different manner than the tests at WESTVACO. At this location, we followed a procedure that has evolved as a result of doing numerous pilot precipitator studies during the interim between the WESTVACO tests and these. Our practice now is, based on past studies, we select the type of discharge electrode we feel will be best, set a gas volume which will give us a velocity in the unit that we feel will be comparable, and adjust the rapper to give us a medium intensity rap (Figure 2). With these parameters set, we request that the plant being tested set a load and fuel rate that is close to normal and maintain these conditions during our test period (Figure 3). They would come to the test conditions approximately three hours prior to our daily starting time and would maintain a steady state until we concluded our tests for the day. We maintained these conditions and tested for approximately one week. We ran as many short duration tests (25 minutes) as we could during an eight hour period and studied the results for stability, collection level, repeatability, etc. The bulk of our tests were run with oil being used as the supplemental fuel since it appears that natural gas will not be too available as a constant fuel source, plus there are many places where gas will not be available at all (Figure 4). These tests established a base which was subsequently used to compare with later results using other parameters. Using this method of evaluation, we determined that a low or medium level of rapping was sufficient to keep the wires and plates clean enough to maintain a constant performance. Sight glasses, installed in the roof of the pilot unit, were also utilized to insure that the plates and wires were uniformly and lightly builtup. These sight glasses were located over the two outside gas passages, and by utilizing a spotlight, one could look clearly into the outer gas passage and observe the cleanliness, the rapper action, etc.

RAPPING INTENSITY VS. PERFORMANCE

<u>Rapping Intensity</u>	<u>Inlet Loading Gr/DSCF</u>	<u>Outlet Loading Gr/DSCF</u>	<u>Efficiency Percent</u>
Low	0.3896	0.0073	98.13
Medium	0.3134	0.0070	97.77
High	0.4776	0.0101	97.88

NOTE: Gr/DSCF x 2.289 = Grams/Cubic Meter

Figure 2.

The effect of velocity was also studied, and we found that for increases in velocity from 3 ft./sec. (.9141m/sec.) to 5 ft./sec. (1.52m/sec.), the collection efficiency remained relatively constant.

Figure 3 shows that although the efficiencies remained nearly constant, the inlet loadings increased with the velocity, and the added inlet dust burden made a higher

collection efficiency possible than would have been obtained assuming a constant inlet loading.

<u>Gas Velocity Ft./Sec.</u>	<u>Inlet Loading Gr/DSCF</u>	<u>Outlet Loading Gr/DSCF</u>	<u>Efficiency Percent</u>
3	0.3134	0.0070	97.77
4	0.3541	0.0098	97.23
5	0.3798	0.0103	97.29

NOTE: Gr/DSCF x 2.289 = Grams/Cubic Meter

Figure 3.

This was the limiting velocity on our equipment with this particular duct set-up, but it did indicate that a higher drift velocity than was obtained at 5 ft./sec. (1.52m/sec.) could be probably obtained and utilized for projecting a full sized precipitator. One of the main parameters studied in Figure 4 was the various fuel combinations.

FUEL COMBINATIONS VS. PERFORMANCE

<u>Type of Fuel</u>	<u>Inlet Loading Gr/DSCF</u>	<u>Outlet Loading Gr/DSCF</u>	<u>Efficiency Percent</u>
Natural Gas Plus Bark	0.3713	0.0176	95.26
Fuel Oil Plus Bark	0.3134	0.0070	97.77

Figure 4.

The combination of bark and oil and bark and natural gas were the two main factors under study (Figure 4). The ash produced by bark and fuel oil firing was more precipitable than the ash resulting from bark and natural gas firing. This is thought to be the result of several things. First, there are some sulfur oxides formed that aid in precipitation, and if any of the oil was not burned completely, its combining with the ash from the bark would tend to lower its normal resistivity. The ash resulting from the bark and oil precipitated with a drift velocity approximately 25% higher than when bark and gas were fired. When the amount of bark being burned with the oil was varied, it was found that as the amount of bark decreased, performance decreased. Of course, the inlet loading also decreased proportionately to the amount of bark being fired, and higher efficiencies are more difficult to obtain with very low inlet loads.

Dust loadings coming to the pilot precipitator were low during the entire program.

This is very understandable since the bark was the largest contributor to the total ash burden, and analysis showed that it only had approximately 0.7%-2.0% ash. In addition to this, the gases go through a multiclone mechanical collector before coming to the pilot precipitator. Throughout the program, we found inlet loadings from 0.150 to 0.500 Gr/SCFD ($.3435 \frac{\text{gram}}{\text{DSM}}$ to $1.157 \frac{\text{gram}}{\text{DS-M}}$)

The fly ash was analyzed and showed the following properties (Figure 5).

BARK ANALYSES FROM ST. REGIS

<u>Sample Number</u>	<u>Moisture Percent</u>	<u>Volatile Percent</u>	<u>Fixed Carbon Percent</u>	<u>Ash Percent</u>	<u>Sulfur Percent</u>	<u>BTU/LB.</u>
1	37.8	47.0	14.1	1.1	0.06	5,755
2	35.7	49.6	13.7	1.0	0.02	5,701
3	30.5	55.9	11.9	1.7	0.01	5,983
4	36.9	47.3	14.9	0.9	0.05	5,728
5	36.5	49.9	11.9	1.7	0.04	5,503
6	34.6	50.6	14.1	0.7	0.03	5,869
7	31.5	54.7	11.9	1.9	0.02	5,910
8	31.0	56.6	10.5	1.9	0.02	5,610
Avg.	34.3	51.5	12.9	1.4	0.03	5,735

Figure 5.

1. It is very low in resistivity ($10^6 - 10^7$ ohm-cm).
2. It is relatively fine, 60% (by weight) less than 10 microns and 25% less than 5 microns. Tests also indicated no appreciable amount (by weight) is submicronic.
3. It had a very high loss on ignition (35-40%).
4. It had a bulk density of 18-23 lb./ft.³ ($288.3 \frac{\text{Kg}}{\text{M}^3} - 368.4 \frac{\text{Kg}}{\text{M}^3}$)

The bark being used at this installation had the following properties, based on the average of daily samples analyzed.

1. Moisture, as received 30-38%.
2. Volatile, as received 47-57%.
3. Fixed carbon, as received 10-15%.
4. Ash, as received 0.7-2.0%.
5. Sulfur, as received 0.01-0.06%.
6. BTU, as received 4,500-6,000/lb. ($10506.6 \frac{\text{KJ}}{\text{Kg}} - 14008.8 \frac{\text{KJ}}{\text{Kg}}$)

The tests described in Figure 5 were run when the boiler was off load control; however, when large swings in load demand occurred, or when load demand was very low, the steam flow would vary. These plant variations were expected, and no demands were made that the system operate in a strict, narrow pattern. During the program, we experienced steam flow variations of greater than 2 to 1, bark firing rates also in the 2 to 1 range with oil and gas rates to match. Generally speaking, the pilot precipitator was capable of adjusting to any change in the flue

gases and fly ash that occurred during these variations. Except on days when a low percentage of bark was specifically requested, bark rates averaged from approximately 60% to greater than 85% of the fuel based on BTU inputs. The bulk of our data was obtained under these conditions. The program consisted of approximately 200 individual grain loading determinations (inlet and outlet) during 24 days of testing over an 8 week period.

This program showed that this combination of fuels fired gives a fly ash that will be easily precipitated but also very easily reentrained, partially as a result of the high moisture content in the flue gases. If the bark were to be dried to a low moisture content, the resistivity would no doubt increase, but the high combustible content of the ash would keep it in the low resistivity, easy precipitability area. Also, because of the high combustible content, care will have to be taken when considering ash storage and removal. Occasionally, as we had found earlier at WESTVACO, "sparkers" will come through the multiclones, could lodge in a hopper full of ash, and with sufficient oxygen, start to char. This calls for continuous ash removal in any full size collector.

It has been clearly demonstrated, as has been described in the preceding pages, that electrostatic precipitators can successfully handle the effluent from combination fuel-fired boilers using bark and coal, bark and fuel oil, or bark and natural gas. The ash produced from the firing of these fuels in combination are not difficult to precipitate; the precipitator itself need not be excessively large to produce an acceptable stack appearance, and if a reliable ash removal system is employed, no fear should arise of the possibility of damage occurring because of still-burning pieces of bark being precipitated.

AIR CLEANING SYSTEMS

PARTIAL LISTING

Fly Ash Installations

Employing Low Sulfur Coal

Air Cleaning Systems Group
P.O. Box 1318, 3700 Koppers St.
Baltimore, Maryland 21203
Telephone 301 368-7222.

<u>CUSTOMER PLANT AND LOCATION</u>	<u>NUMBER OF PRECIPITATORS ACFM</u>	<u>FUEL SOURCE</u>	<u>% SULFUR % ASH</u>
NEW YORK STATE ELECTRIC & GAS Units 1-3 Jennison, New York	3 Precipitators Total 532,000	Eastern Bituminous	1.0 to 1.8 18 to 21
NEW YORK STATE ELECTRIC & GAS Units 1-4 Hickling, New York	4 Precipitators Total 570,000	Eastern Bituminous	1.0 to 1.9 25
ALCOA Units 1-3 Rockdale, Texas	6 Precipitators Total 1,380,000	Texas Lignite	0.8 to 1.1 15
APPALACHIAN POWER COMPANY Units 1-3 Clinch River, Carbo, Virginia	6 Precipitators Total 2,700,000	Eastern Bituminous	0.5 to 1.3 25
OHIO POWER COMPANY Gavin Units 1 & 2 Cheshire, Ohio	12 Precipitators Total 8,820,000	Eastern Bituminous	0.9 to 1.75 6 to 17
OHIO POWER COMPANY Amos #3 Scary, West Virginia	6 Precipitators Total 4,410,000	Eastern Bituminous	0.8 to 1.6 16
PACIFIC POWER AND LIGHT COMPANY Centralia 1 & 2 Centralia, Washington	4 Precipitators Total 4,932,000	Mine Mouth	0.38 to 0.62 14 to 17
KENTUCKY POWER COMPANY Big Sandy #1 Louisa, Kentucky	1 Precipitator Total 950,000	Eastern Bituminous	0.7 to 0.97 10 to 20
APPALACHIAN POWER COMPANY OHIO POWER COMPANY Sporn 1-4 New Haven, West Virginia	4 Precipitators Total 2,400,000	Eastern Bituminous	1.0 to 3.0 6 to 20
NEBRASKA PUBLIC POWER DISTRICT Gerald Gentlemen #2 Sutherland, Nebraska	4 Precipitators Total 3,700,000	Amax (WYO)	0.15 to 0.45 5 to 11
MEAD CORPORATION Chillicothe 5 & 7 Chillicothe, Ohio	1 Precipitator Total 310,000	West Kentucky	0.7 to 3.0 5 to 10
VIRGINIA ELECTRIC & POWER CO. Chesterfield #5 Dutch Gap, Virginia	2 Precipitators Total 1,300,000	Eastern Bituminous	0.7 to 1.5 8 to 11.5

**ENVIRONMENTAL
ELEMENTS
CORPORATION**
Subsidiary of Koppers Company, Inc.

AIR CLEANING SYSTEMS

PARTIAL LISTING

Recent Fly Ash Installations

Air Cleaning Systems Group
P.O. Box 1318, 3700 Koppers St.
Baltimore, Maryland 21203
Telephone 301 368-7222

CUSTOMER PLANT AND LOCATION

START-UP AND OPERATING DATA

BALTIMORE GAS & ELECTRIC Unit #3, Wagner Station Baltimore, Maryland	April 1966; 1 boiler, 320 MW, 900,000 ACFM @ 295° F, 99.0% guaranteed efficiency.
NEW ENGLAND POWER CO. Units #1 and #2, Brayton Point Somerset, Massachusetts	May 1963, May 1964; 2 boilers, 240 MW each, 716,000 ACFM @ 260° F, 98.4% guaranteed efficiency.
NEW ENGLAND POWER CO. Unit #3, Brayton Point Somerset, Massachusetts	Late 1968; 1 boiler, 640 MW, 1,560,000 ACFM @ 255° F, 99.0% guaranteed efficiency.
CLEVELAND ELECTRIC ILLUMINATING COMPANY Unit #18, Lake Shore Station Cleveland, Ohio	July 1962; 1 boiler, 256 MW, 790,000 ACFM @ 250° F, 99.4% guaranteed efficiency.
COMMONWEALTH EDISON CO. Unit #8, Waukegan, Illinois	June 1962; 1 boiler, 355 MW, 1,051,000 ACFM @ 284° F, 98.0% guaranteed efficiency.
COMMONWEALTH EDISON CO. Unit #6, Joliet, Illinois	June 1966; 1 boiler, 360 MW, 1,105,000 ACFM @ 290° F, 98.0% guaranteed efficiency.
KENTUCKY POWER (A.E.P.) Kentucky Power, Big Sandy #1 Louisa, Kentucky	Late 1969; 1 boiler, 265 MW, 950,000 ACFM @ 285° F, 98.5% guaranteed efficiency.
VIRGINIA ELECTRIC & POWER CO. Unit #1 Yorktown, Virginia	April 1961; 1 boiler, 170 MW, 700,000 ACFM @ 350° F, 98.0% guaranteed efficiency. Coal/Coke Fired Boiler.
KANSAS CITY POWER AND LIGHT COMPANY Grand Ave. Station Kansas City, Missouri	Oct. 1968; 4 boilers, 95 MW total, 410,000 ACFM @ 355° F, 97.0% guaranteed efficiency.
ARCO POLYMERS Units #3 and #4 Monaca, Pennsylvania	Nov. 1969; 1 boiler, 400,000 #/Hr. Steam, 175,000 ACFM @ 400° F, 96.0% guaranteed efficiency.

**ENVIRONMENTAL
ELEMENTS
CORPORATION**
Subsidiary of Koppers Company, Inc.

**CUSTOMER
PLANT AND LOCATION**

START-UP AND OPERATING DATA

**PUBLIC SERVICE COMPANY
OF COLORADO**

Cherokee Unit #4
Denver, Colorado

Late 1968; 1 boiler, 350 MW, 1,390,000 ACFM @ 267° F, 87.0% guaranteed efficiency.

**PITTSBURGH PLATE GLASS
INDUSTRIES**

Units #11 & #12
Barberton, Ohio

Dec. 1968; 1 boiler, 600,000 #/Hr. Steam, 156,000 ACFM @ 325° F, 98.7% guaranteed efficiency. 1 boiler, 420,000 #/Hr. Steam, 232,000 ACFM.

PACIFIC POWER & LIGHT CO.

AND

WASHINGTON WATER POWER CO.

Centralia, Washington
Boilers #1 & #2

Sept. 1971; 1 boiler, 700 MW, 2,400,000 ACFM @ 315° F, 99.4% guaranteed efficiency.

Sept. 1972; 1 boiler, 700 MW, 2,400,000 ACFM @ 315° F, 99.4% guaranteed efficiency.

APPALACHIAN POWER CO. (AEP)

Amos Unit #3, Scary, West Virginia

Sept. 1973; 1 boiler, 1,300 MW, 6 @ 735,000 ACFM @ 300° F, 99.75% guaranteed efficiency.

OHIO POWER CO. (AEP)

Gavin Unit 1
Cheshire, Ohio

Jan. 1974; 1 boiler, 1,300 MW, 6 @ 735,000 ACFM @ 300° F, 99.75% guaranteed efficiency.

Gavin Unit 2
Cheshire, Ohio

Jan. 1975; 1 boiler, 1,300 MW, 6 @ 735,000 ACFM @ 300° F, 99.75% guaranteed efficiency.

APPALACHIAN POWER CO. (AEP)

Clinch River,
Carbo, Virginia

Feb. 1974; 3 boilers, 230 MW, 6 @ 450,000 ACFM @ 315° F, 99.8% guaranteed efficiency.

**NORTHERN INDIANA PUBLIC
SERVICE**

Unit 12
Michigan City, Indiana

April 1974; 1 boiler, 600 MW, 2 @ 904,800 ACFM @ 325° F, 99.5% guaranteed efficiency.

**NEW YORK STATE ELECTRIC
AND GAS**

Hickling Units 1-4
East Coming, New York

March 1974; 4 boilers, 70 MW, 2 @ 135,000 ACFM @ 310° F, 99.5% guaranteed efficiency.

ALUMINUM CO. OF AMERICA

Rockdale, Texas

Oct. 1974; 1 boiler, 150 MW, 3 @ 460,000 ACFM @ 300° F, 98.0% guaranteed efficiency. 2 Precipitators

Feb. 1974; 1 boiler, 150 MW, @ 300° F. 2 Precipitators

April 1975; 1 boiler, 150 MW, @ 300° F. 2 Precipitators

**NEW YORK STATE ELECTRIC
AND GAS**

Greenidge, New York

March 1975; 2 boilers, 125,000 #/Hr. Steam, 57,500 ACFM @ 380° F, 99.8% guaranteed efficiency.

Dec. 1974; 1 boiler, 200,000 #/Hr. Steam, 118,000 ACFM @ 320° F, 99.5% guaranteed efficiency.

**NEW YORK STATE ELECTRIC
AND GAS**

Jennison, New York

July 1975; 3 boilers, 200,000 #/Hr. Steam, 3-399,000 ACFM @ 320° F, 99.5% guaranteed efficiency.

**CUSTOMER
PLANT AND LOCATION**

START-UP AND OPERATING DATA

CONSUMERS POWER COMPANY Kam #1 and #2 Essexville, Michigan	Nov. 1976; 1 boiler, 265 MW, 2 @ 1,172,000 ACFM @ 315° F, 97.0% guaranteed efficiency. 1977, 1 boiler, 265 MW
OHIO POWER (AEP) Spom #5 New Haven, West Virginia	Dec. 1977; 1 boiler, 450 MW, 2 @ 875,000 ACFM @ 310° F, 99.8% guaranteed efficiency.
OHIO POWER/APPALACHIAN POWER (AEP) Spom #1, 2, 3, & 4 New Haven, West Virginia	Jan. 1979; 4 boilers, 155 MW 4 @ 600,000 ACFM @ 315° F, 99.8% guaranteed efficiency.
INDIANA & MICHIGAN ELECTRIC Breed Station #1 Fairfield, Indiana	Late 1977; 1 Cyclone Boiler, 450 MW, 2,000,000 ACFM @ 350° F, 98.7% guaranteed efficiency.
ST. JOSEPH POWER AND LIGHT Lake Road, Boiler #5 St. Joseph, Missouri	Nov. 1976; 1 pulverized coal boiler, 250,000 #/Hr. Steam 134,500 ACFM @ 311° F, 99.0% guaranteed efficiency.
INTERNATIONAL PAPER Mobile, Alabama	July 1976; Two Cyclone Boilers 450,000 #/Hr. Steam each, 219,000 ACFM @ 336° F, 99.5% guaranteed efficiency.
MEAD PAPERS INC. Boilers #5 & #7 Chillicothe, Ohio	Sept. 1976; 1 pulverized coal boiler, 570,000 #/Hr. Steam, 310,000 ACFM @ 334° F, 98.75% guaranteed efficiency. 1 Precipitators
MEAD PAPERS, INC. Boiler #8 Chillicothe, Ohio	Sept. 1976; 1 pulverized coal boiler, 410,000 #/Hr. Steam 218,000 ACFM @ 318° F, 98.75% guaranteed efficiency. 1 Precipitators
NEBRASKA PUBLIC POWER DISTRICT Gerald Gentleman #2 Sutherland, Nebraska	Jan. 1981; 1 pulverized coal boiler, 4,700,000 #/Hr. Steam 3,700,000 ACFM @ 720° F, 99.8% guaranteed efficiency. 4 Precipitators
WESTVACO Charleston, South Carolina	July, 1979; 1 pulverized coal boiler, 350,000 #/Hr. Steam 215,000 ACFM @ 375° F, 98.37% guaranteed efficiency (Rigid Discharge Electrode Design, "Rigitrode")
VIRGINIA ELECTRIC AND POWER COMPANY Dutch Gap, Virginia	June 1980, 1 pulverized coal boiler, 2,053,000 #/Hr. Steam 1,300,000 ACFM @ 311° F, 99.7% guaranteed efficiency (1 field out of service) 99.8% guaranteed efficiency (all fields in service) (Rigid Discharge Electrode Design, "Rigitrode") 2 Precipitators
ATLANTIC CITY ELECTRIC B.L. England Sta. Units 1 & 2 Beesley's Pt., New Jersey	Unit 1 Oct. 1980; 1 cyclone boiler 135MW, 593,000 ACFM @ 255° F 99.8% guaranteed efficiency, (Rigid Discharge Electrode Design, "Rigitrode") Unit 2 April 1981; 1 cyclone boiler 160MW, 760,000 ACFM @ 255° F; 99.11% guaranteed efficiency (Rigid Discharge Electrode Design, "Rigitrode")
INTERNATIONAL PAPER Mansfield, Louisiana	July 1981, 2 Pulverized Coal & Bark boilers 500,000 # Hr. steam 2-347,000 ACFM @ 350° F, 99.8% efficiency.

**CUSTOMER
PLANT AND LOCATION**

START-UP AND OPERATING DATA

CROWN ZELLERBACH CANADA, LTD.
Campbell River, B.C.
Boilers 1, 2, 3

January, 1982; 3 Hog Fuel Boilers (salt-soaked logs); 285,000 ACFM @ 395°F; 87.50% guaranteed efficiency, triple chamber (Rigid Discharge Electrode Design, "Rigitrode")

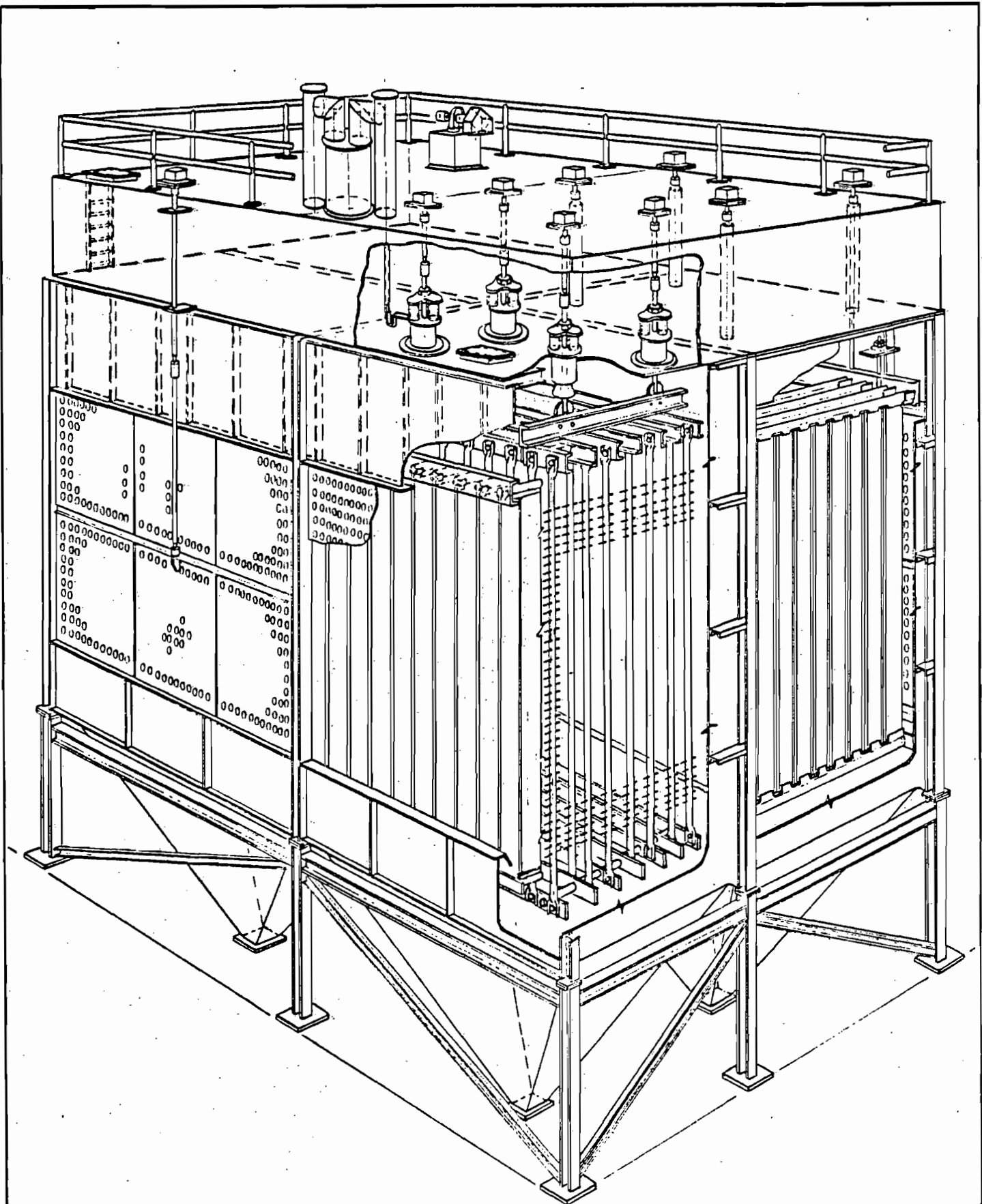

**ENVIRONMENTAL
ELEMENTS
CORPORATION**
Subsidiary of Koppers Company, Inc.

TYPICAL RIGITRODE
ARRANGEMENT WITH
ELECTRIC RAPPING

DWG No. 1130

REV
F.W.S. 10-28-80

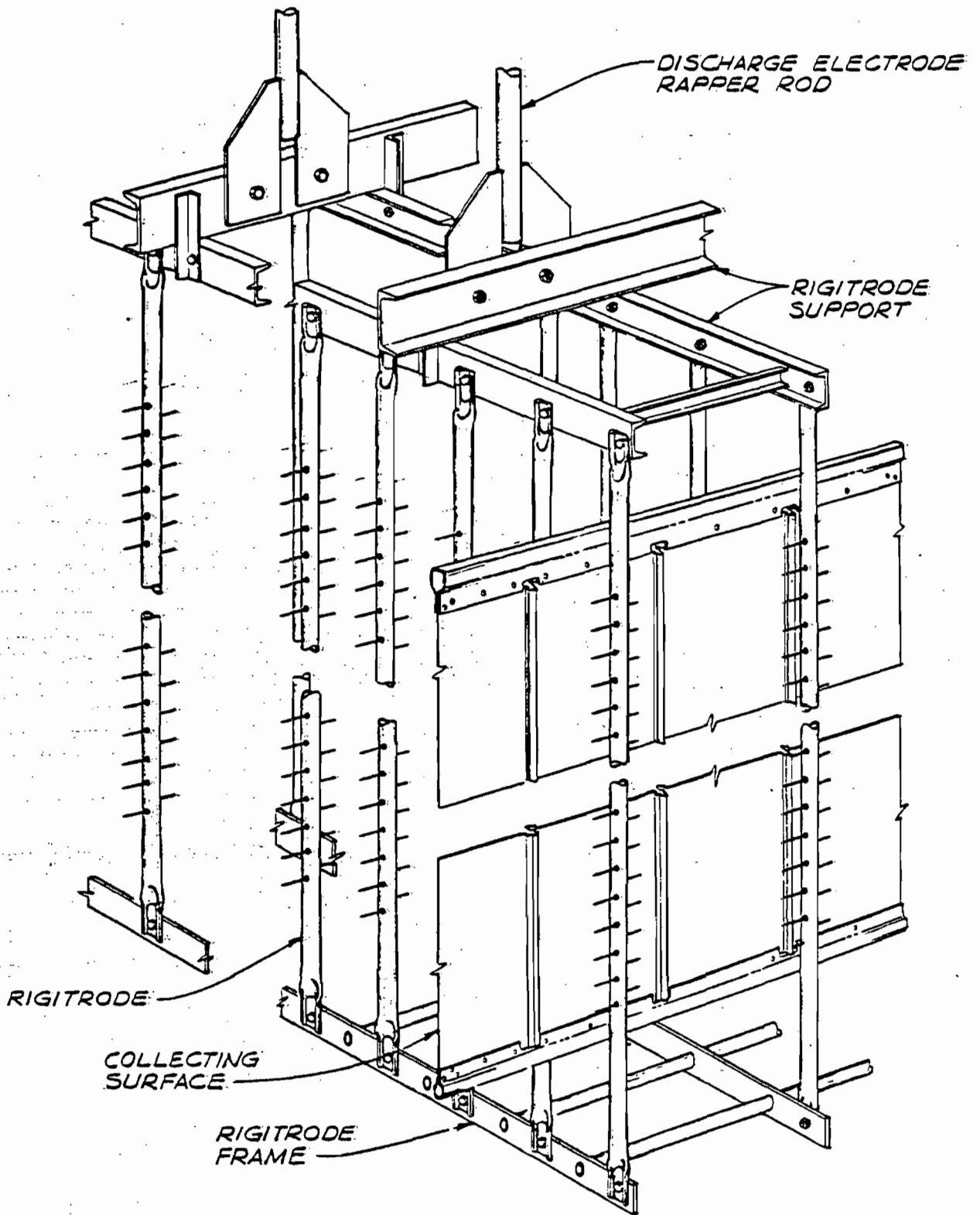

**ENVIRONMENTAL
ELEMENTS
CORPORATION**
Subsidiary of Koppers Company, Inc.

RIGITRODE
DISCHARGE ELECTRODE
ARRANGEMENT

DWG. No. 1121

REV.
ELK 10-29-90

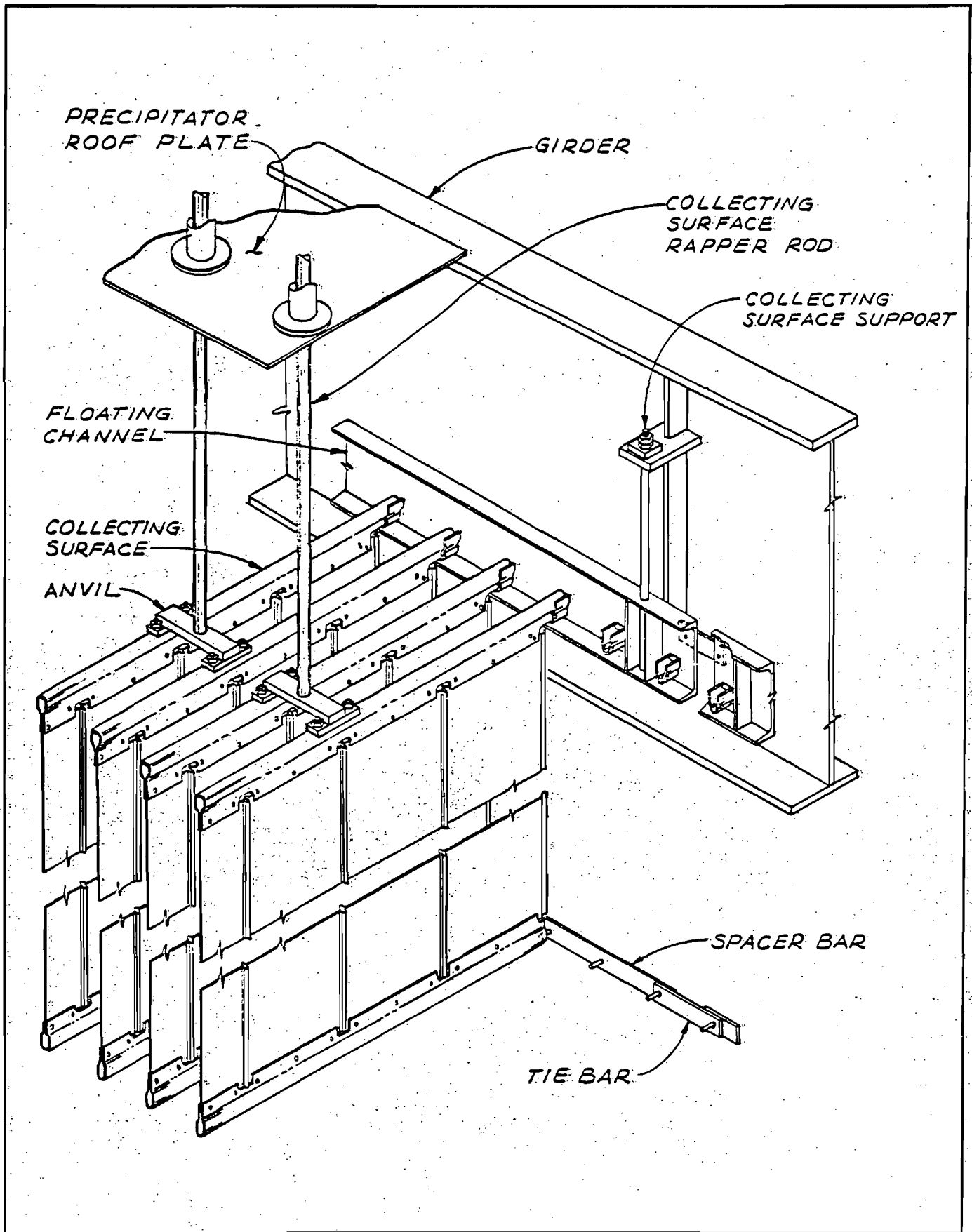

**ENVIRONMENTAL
 ELEMENTS
 CORPORATION**
 Subsidiary of Koppers Company, Inc.

COLLECTING SURFACE
 RAPPER ARRANGEMENT

DWG. No. 1120

SECTION VII - PREVENTION OF SIGNIFICANT DETERIORATION

A. Company Monitored Data

1. 3 no sites 3 TSP 1 (C) SO₂* 1 Wind spd/dir

Period of monitoring June / / 1981 to June / / 1982
month day year month day year

Other data recorded Ambient temperature at one (1) site

Attach all data or statistical summaries to this application.

2. Instrumentation, Field and Laboratory

a) Was instrumentation EPA referenced or its equivalent? Yes No

b) Was instrumentation calibrated in accordance with Department procedures? Yes No Unknown

B. Meteorological Data Used for Air Quality Modeling

1. 5 Year(s) of data from 1 / 1 / 70 to 1 / 1 / 74
month day year month day year

2. Surface data obtained from (location) Jacksonville, Florida

3. Upper air (mixing height) data obtained from (location) Waycross, Georgia

4. Stability wind rose (STAR) data obtained from (location) Jacksonville, Florida

C. Computer Models Used

1. ISCST (5-year) Modified? If yes, attach description.

2. ISCLT (5-year) Modified? If yes, attach description.

3. _____ Modified? If yes, attach description.

4. _____ Modified? If yes, attach description.

Attach copies of all final model runs showing input data, receptor locations, and principle output tables.

D. Applicants Maximum Allowable Emission Data

Pollutant	Emission Rate
TSP	<u>See Section III.C.</u> grams/sec
SO ₂	<u>See Section III.C.</u> grams/sec

E. Emission Data Used in Modeling

Attach list of emission sources. Emission data required is source name, description on point source (on NEDS point number), UTM coordinates, stack data, allowable emissions, and normal operating time.

F. Attach all other information supportive to the PSD review.

*Specify bubbler (B) or continuous (C).

G. Discuss the social and economic impact of the selected technology versus other applicable technologies (i.e., jobs, payroll, production, taxes, energy, etc.). Include assessment of the environmental impact of the sources.

Positive social and economic impacts are expected as a result of using the selected control technologies.

H. Attach scientific, engineering, and technical material, reports, publications, journals, and other competent relevant information describing the theory and application of the requested best available control technology.

See Attachments

RECOVERY BOILER NO. 5

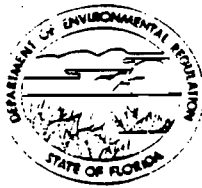

STATE OF FLORIDA
DEPARTMENT OF ENVIRONMENTAL REGULATION
APPLICATION TO OPERATE/CONSTRUCT
AIR POLLUTION SOURCES

SOURCE TYPE: Recovery Boiler No. 5 [] New¹ [] Existing¹

APPLICATION TYPE: [] Construction [] Operation [] Modification

COMPANY NAME: Georgia-Pacific Corporation COUNTY: Putnam

Identify the specific emission point source(s) addressed in this application (i.e. Lime Kiln No. 4 with Venturi Scrubber; Peeking Unit No. 2, Gas Fired) Recovery Boiler No. 5 with ESP and two Smelt Dissolving Tanks (No. 5 with scrubber)

SOURCE LOCATION: Street N. of S.R. 216, W. of U.S.17 City Palatka

UTM: East 434.0 North 3283.4

Latitude 29 ° 41 ' 00 "N Longitude 81 ° 40 ' 45 "W

APPLICANT NAME AND TITLE: Roger C. Sherwood, Technical Director

APPLICANT ADDRESS: P.O. Box 919, Palatka, Florida 32077

SECTION I: STATEMENTS BY APPLICANT AND ENGINEER

A. APPLICANT

I am the undersigned owner or authorized representative* of Georgia-Pacific Corporation

I certify that the statements made in this application for a construction permit are true, correct and complete to the best of my knowledge and belief. Further, I agree to maintain and operate the pollution control source and pollution control facilities in such a manner as to comply with the provision of Chapter 403, Florida Statutes, and all the rules and regulations of the department and revisions thereof. I also understand that a permit, if granted by the department, will be non-transferable and I will promptly notify the department upon sale or legal transfer of the permitted establishment.

*Attach letter of authorization

Signed: Roger C. Sherwood
Roger C. Sherwood, Technical Director
Name and Title (Please Type)

Date: 6-2-81 Telephone No. 904/325-2001

B. PROFESSIONAL ENGINEER REGISTERED IN FLORIDA (where required by Chapter 471, F.S.)

This is to certify that the engineering features of this pollution control project have been designed/examined by me and found to be in conformity with modern engineering principles applicable to the treatment and disposal of pollutants characterized in the permit application. There is reasonable assurance, in my professional judgment, that the pollution control facilities, when properly maintained and operated, will discharge an effluent that complies with all applicable statutes of the State of Florida and the rules and regulations of the department. It is also agreed that the undersigned will furnish, if authorized by the owner, the applicant a set of instructions for the proper maintenance and operation of the pollution control facilities and, if applicable, pollution sources.

Signed: David A. Buff
David A. Buff
Name (Please Type)

Environmental Science and Engineering, Inc.
Company Name (Please Type)

P.O. Box ESE, Gainesville, Florida 32604
Mailing Address (Please Type)

Date: 6-2-81 Telephone No. 904/372-3318

(Affix Seal)

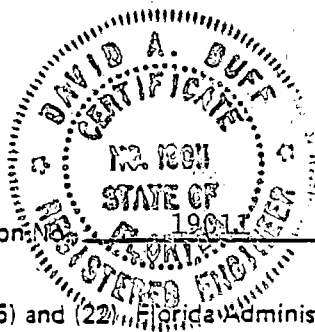

Florida Registration: _____

¹See Section 17-2.02(15) and (22), Florida Administrative Code, (F.A.C.)

SECTION II: GENERAL PROJECT INFORMATION

A. Describe the nature and extent of the project. Refer to pollution control equipment, and expected improvements in source performance as a result of installation. State whether the project will result in full compliance. Attach additional sheet if necessary.
A new 607,500 pound steam/hr. low odor, non-direct contact evaporation Recovery Boiler, No. with electrostatic precipitator, will be constructed. In addition, two smelt dissolving tanks, No. 5, will be constructed, equipped with wet scrubbers. The source will comply with all applicable emission and air quality standards.

B. Schedule of project covered in this application (Construction Permit Application Only)
 Start of Construction September 1982 Completion of Construction 1985

C. Costs of pollution control system(s): (Note: Show breakdown of estimated costs only for individual components/units of the project serving pollution control purposes. Information on actual costs shall be furnished with the application for operation permit.)
Precipitator - approx. \$4.0 million
2 scrubber systems - approx. \$210,000 each

D. Indicate any previous DER permits, orders and notices associated with the emission point, including permit issuance and expiration dates.
Not applicable

E. Is this application associated with or part of a Development of Regional Impact (DRI) pursuant to Chapter 380, Florida Statutes, and Chapter 22F-2, Florida Administrative Code? Yes No

F. Normal equipment operating time: hrs/day 24 ; days/wk 7 ; wks/yr 51 ; if power plant, hrs/yr _____ ; if seasonal, describe: _____

52 6/26/81 Mr. Adams Mr. Skerwood

- G. If this is a new source or major modification, answer the following questions. (Yes or No)
- | | |
|---|------------|
| 1. Is this source in a non-attainment area for a particular pollutant? | <u>No</u> |
| a. If yes, has "offset" been applied? | <u>-</u> |
| b. If yes, has "Lowest Achievable Emission Rate" been applied? | <u>-</u> |
| c. If yes, list non-attainment pollutants. | <u>-</u> |
| 2. Does best available control technology (BACT) apply to this source? If yes, see Section VI. | <u>Yes</u> |
| 3. Does the State "Prevention of Significant Deterioration" (PSD) requirements apply to this source? If yes, see Sections VI and VII. | <u>Yes</u> |
| 4. Do "Standards of Performance for New Stationary Sources" (NSPS) apply to this source? | <u>Yes</u> |
| 5. Do "National Emission Standards for Hazardous Air Pollutants" (NESHAP) apply to this source? | <u>No</u> |

Attach all supportive information related to any answer of "Yes". Attach any justification for any answer of "No" that might be considered questionable.

SECTION III: AIR POLLUTION SOURCES & CONTROL DEVICES (Other than Incinerators)

A. Raw Materials and Chemicals Used in your Process, if applicable:

Description	Contaminants		Utilization* Rate - lbs/hr	Relate to Flow Diagram
	Type	% Wt		
Black Liquor	Particulate	5.5	230,769	A
Black Liquor Solids	Particulate	Unknown	150,000	A
Smelt	Particulate	Unknown	63,000	C

*At rated capacity

B. Process Rate, if applicable: (See Section V, Item 1)

1. Total Process Input Rate (lbs/hr): 150,000 lbs. Black Liquor Solids/hr.

2. Product Weight (lbs/hr): 63,000 lbs. Smelt/hr.; 607,500 lb/hr steam

C. Airborne Contaminants Emitted: See attached sheet

Name of Contaminant	Emission ¹		Allowed Emission ² Rate per Ch. 17-2, F.A.C.	Allowable ³ Emission lbs/hr	Potential Emission ⁴		Relate to Flow Diagram
	Maximum lbs/hr	Actual T/yr			lbs/hr	T/yr	

D. Control Devices: (See Section V, Item 4)

Name and Type (Model & Serial No.)	Contaminant	Efficiency	Range of Particles ⁵ Size Collected (in microns)	Basis for Efficiency (Sec. V, It ⁵)
ESP-Environmental elements or equivalent	Particulate	99%	Submicron	See Attach- ment B
Scrubbers--Flex Kleen or equivalent	Particulate	98%	Submicron	

¹ See Section V, Item 2.

² Reference applicable emission standards and units (e.g., Section 17-2.05(6) Table II, E. (1), F.A.C. - 0.1 pounds per million BTU heat input)

³ Calculated from operating rate and applicable standard

⁴ Emission, if source operated without control (See Section V, Item 3)

⁵ If Applicable

Section III-C. Airborne Contaminants Emitted

Name of Contaminant	Emission		Allowed Emission Rate Per Ch. 17-2, F.A.C.	Allowable Emission (lbs/hr)	Potential (lbs/hr)	Emission (Tons/yr)	Relate to Flow Diagram
	Maximum (lbs/hr)	Actual (Tons/yr)					
Recovery Boiler:							
Particulate	75.4	323.0	0.03 lb/3,000 lbs 3 lb/3,000 H ₂ S* ¹⁷⁻²	75.4**	7,500	32,850	D
Sulfur Dioxide	250.0	1,071.0	NA	NA	250	1,095	D
Nitrogen Oxides	89.1	381.7	NA	NA	89	390	D
Carbon Monoxide	871.2	3,732.0	NA	NA	871	3,816	D
Volatile Org. Comp.	48.0	205.6	NA	NA	48	210	D
Total Reduced Sulfur	5.2	22.3	1 ppm	5.2**	650	2,847	D
Smelt Tank Vents:							
Particulate	15.0	64.3	NA	15.0**	250	1,095	E
Sulfur Dioxide	5.0	21.4	NA	NA	5	22	E
Total Reduced Sulfur	1.3	5.4	NA	1.3**	22	96	E

* Federal NSPS is more stringent than State Regulation

** NSPS Level

E. Fuels

Type (Be Specific)	Consumption*		Maximum Heat Input (MMBTU/hr)
	avg/hr	max./hr	
Black Liquor at 65% Solids	230,679	230,679	990
No.6 Fuel Oil *	-	23.8	146

*Units Natural Gas, MMCF/hr; Fuel Oils, barrels/hr; Coal, lbs/hr

*Used only for startup, shutdown, emergencies, and system checking

Fuel Analysis: Black Liquor Solids/No. 6 Fuel Oil

Percent Sulfur: */2.5 Percent Ash: */0.1

Density: */7.88 lbs/gal Typical Percent Nitrogen: */0

Heat Capacity: 6,600/18,500 BTU/lb */145,780 BTU/gal

Other Fuel Contaminants (which may cause air pollution): *Unknown

F. If applicable, indicate the percent of fuel used for space heating. Annual Average NA Maximum NA

G. Indicate liquid or solid wastes generated and method of disposal.

Particulate collected in ESP reinjected into process

Scrubber water reinjected to process or sent to waste treatment system

H. Emission Stack Geometry and Flow Characteristics (Provide data for each stack):

Stack Height: 250-RB; 250-STV ft Stack Diameter: 13.2-RB; 5.0-STV* ft

Gas Flow Rate: 375,100-RB; 31,900 ea-STV ACFM Gas Exit Temperature: 393-RB/163-STV °F

Water Vapor Content: 25 % Velocity: 45.7-RB; 27.1 ea-STV FPS

*Two identical stacks

SECTION IV: INCINERATOR INFORMATION

Not Applicable

Type of Waste	Type O (Plastics)	Type I (Rubbish)	Type II (Refuse)	Type III (Garbage)	Type IV (Pathological)	Type V (Liq & Gas By-prod.)	Type VI (Solid By-prod.)
Lbs/hr Incinerated							

Description of Waste: _____

Total Weight Incinerated (lbs/hr) _____ Design Capacity (lbs/hr) _____

Approximate Number of Hours of Operation per day _____ days/week _____

Manufacturer _____

Date Constructed _____ Model No. _____

	Volume (ft) ³	Heat Release (BTU/hr)	Fuel		Temperature (°F)
			Type	BTU/hr	
Primary Chamber					
Secondary Chamber					

Stack Height: _____ ft. Stack Diameter _____ Stack Temp. _____

Gas Flow Rate: _____ ACFM _____ DSCFM* Velocity _____ FPS

*If 50 or more tons per day design capacity, submit the emissions rate in grains per standard cubic foot dry gas corrected to 50% excess air.

Type of pollution control device: Cyclone Wet Scrubber Afterburner Other (specify) _____

Brief description of operating characteristics of control devices: _____

Ultimate disposal of any effluent other than that emitted from the stack (scrubber water, ash, etc.):

SECTION V: SUPPLEMENTAL REQUIREMENTS

Please provide the following supplements where required for this application.

- Total process input rate and product weight — show derivation.
- To a construction application, attach basis of emission estimate (e.g., design calculations; design drawings; pertinent manufacturer's test data, etc.) and attach proposed methods (e.g., FR Part 60 Methods 1, 2, 3, 4, 5) to show proof of compliance with applicable standards. To an operation application, attach test results or methods used to show proof of compliance. Information provided when applying for an operation permit from a construction permit shall be indicative of the time at which the test was made.
See Attachment A
- Attach basis of potential discharge (e.g., emission factor, that is, AP42 test).
- With construction permit application, include design details for all air pollution control systems (e.g., for baghouse include cloth to air ratio; for scrubber include cross-section sketch, etc.).
See Attachment B
- With construction permit application, attach derivation of control device(s) efficiency. Include test or design data. Items 2, 3, and 5 should be consistent: actual emissions = potential (1-efficiency).
See Attachment B
- An 8½" x 11" flow diagram which will, without revealing trade secrets, identify the individual operations and/or processes. Indicate where raw materials enter, where solid and liquid waste exit, where gaseous emissions and/or airborne particles are evolved and where finished products are obtained.
See Attachment A
- An 8½" x 11" plot plan showing the location of the establishment, and points of airborne emissions, in relation to the surrounding area, residences and other permanent structures and roadways (Example: Copy of relevant portion of USGS topographic map).
See PSD report
- An 8½" x 11" plot plan of facility showing the location of manufacturing processes and outlets for airborne emissions. Relate all flows to the flow diagram.
See Combination Boiler #5 Application

ATTACHMENT A

EMISSIONS ESTIMATES

A. Fuel Usage and Process Weight Rates

Black liquor solids = 6,600 Btu/lb (dry basis)
Black liquor solids feed = 150,000 lb/hr (dry)
Btu needed per lb steam = 1,629.6
 $150,000 \text{ lb/hr} \times 6,600 \text{ Btu/lb} \div 1,629.6 \text{ Btu/lb} = 607,500 \text{ lb steam/hr}$

Heat input = $150,000 \times 6,600 = 990 \times 10^6 \text{ Btu/hr}$
Fuel oil only burned for startup, shut down, emergencies, and system checking
Maximum fuel oil, when burned =
 $1,000 \text{ gal/hr} \times 145,780 \text{ Btu/gal} = 146 \times 10^6 \text{ Btu}$

B. Recovery Boiler

1. Maximum Emissions

Particulate

Based on NSPS of 0.044 gr/dscf
Max flow rate = 200,000 dscfm (based on No. 4 recovery boiler operation)
 $200,000 \text{ dscfm} \times 60 \times 0.044 \text{ gr/dscf} \div 7,000 \text{ gr/lb} = 75.42 \text{ lb/hr}$
323.01 TPY
330.3

Based on Table II: $3 \text{ lb}/3000 \text{ lb black liq. solids} \times 150,000 \text{ lb/hr (dry) feed BLS} = 150 \text{ lb/hr}$ *NSPS more stringent*

Sulfur Dioxide

From AP-42: 5 lb SO₂/ton of air dried unbleached pulp ✓

3,000 lb BLS = 1 ton air dried unbleached pulp (ADUP)
 $150,000 \text{ lb/hr BLS} \div 3,000 = 50 \text{ tons/hr ADUP}$
 $50 \times 5 = 250 \text{ lb/hr}$ ✓
1071 TPY
1095

Nitrogen Oxides

From 1981 TAPPI conference paper, used highest emission factor for nondirect contact evaporator boilers with production greater than 1,000 tons/day: 0.09 lb/10⁶ Btu

$990 \times 10^6 \text{ Btu/hr} \times 0.09/10^6 = 89.1 \text{ lb/hr}$ ✓

VOC

381.70 TPY
390.3

From TAPPI conference paper, for nondirect contact evaporator boilers, highest factor: 0.32 lb/1,000 lb BLS

$150,000 \text{ lb/hr} \times 0.32 \text{ lb}/1,000 \text{ lb} = 48.0 \text{ lb/hr}$ ✓

205.63 TPY
210.24

Carbon Monoxide

From TAPPI conference paper, for nondirect contact evaporator furnaces, highest factor: 0.88 lb/10⁶ Btu /

$$990 \times 10^6 \times 0.88/10^6 = 871.2 \text{ lb/hr}$$

From AP-42: use lower value, ^{3,732.2 TPY} ^{3,415.9} for properly operated boiler:
2 lb/ton air dried unbleached pulp

$$150,000 \div 3,000 \times 2 = 100 \text{ lb/hr}$$

428.4 TPY

Total Reduced Sulfur

Table II = 1 ppm = 1340.6 μg/m³
NSPS = 5 ppm dry basis
MW H₂S = 34; 5 ppm = 6,953 ug/m³
200,000 dscfm x (.3048)³ m³/ft³ x 60 x 6,953, x 10⁻⁶ ÷ 454
= 5.2 lb/hr

277°F

Table II 1.04, ^{4.6} ^{4.4 TPY} ^{1.04} ^{1.0}
State of Florida Standard = 1 ppm or 0.03 lb/3,000 lb BLS

1 ppm = 1 lb/hr
0.03 lb/3,000 lb BLS x 150,000 = 1.5 lb/hr ✓

Other Regulated Pollutants

^{6.43 TPY}
6.57

No known emission factor for other pollutants.

2. Actual Emissions

Particulate

$$75.4 \text{ lb/hr} \times 24 \times 7 \times 51 \div 2,000 = 323 \text{ tons/yr}$$

Sulfur Dioxide

$$250 \text{ lb/hr} \times 24 \times 7 \times 51 \div 2,000 = 1,071 \text{ tons/yr}$$

Nitrogen Oxides

$$89.1 \text{ lb/hr} \times 24 \times 7 \times 51 \div 2,000 = 381.7 \text{ tons/yr}$$

VOC

$$48 \text{ lb/hr} \times 24 \times 7 \times 51 \div 2,000 = 205.6 \text{ tons/yr}$$

Carbon Monoxide

$$871.2 \text{ lb/hr} \times 24 \times 7 \times 51 \div 2,000 = 3,732 \text{ tons/yr}$$

Total Reduced Sulfur

$$5.2 \text{ lb/hr} \times 24 \times 7 \times 51 \div 2,000 = 22.3 \text{ tons/yr}$$

22.8

3. Potential Emissions

Particulate

Use AP-42 untreated emission factor (Table 10.1.2-1) of
150 lb/ton ADUP

$$50 \text{ tons/hr ADUP} \times 150 = 7,500 \text{ lb/hr} = 32,850 \text{ tons/yr}$$

$$\text{Sulfur Dioxide} \quad \text{99\%} = 75 \text{ lb/hr} = \frac{321.3 \text{ TPY}}{328.5}$$

AP-42 untreated factor same as with ESP (5 lb/ton)

$$250 \text{ lb/hr} \times 8,760 \div 2,000 = 1,095 \text{ tons/yr}$$

$$\text{Nitrogen Dioxide} \quad \frac{1071.0 \text{ TPY}}{1095.0}$$

$$89.1 \text{ lb/hr} \times 8,760 \div 2,000 = 390 \text{ tons/yr}$$
$$381.7 \text{ TPY} \quad 390.3$$

VOC

$$48 \text{ lb/hr} \times 8,760 \div 2,000 = 210.2 \text{ tons/yr}$$

Carbon Monoxide

$$871.2 \text{ lb/hr} \times 8,760 \div 2,000 = 3,815.9 \text{ tons/yr}$$

Total Reduced Sulfur

Use AP-42 factor for H₂S and reduced sulfur compounds =
12. + 1 = 13 lb/ton ADUP

$$50 \text{ tons/hr} \times 13 = 650 \text{ lb/hr} = 2,847 \text{ tons/yr} \checkmark$$

4. Smelt Dissolving Tanks

Particulate

Maximum Emissions: NSPS = 0.2 lb/ton BLS (dry basis)
150,000 lb/hr \div 2,000 \times 0.2 = 15 lb/hr

$$\text{Actual Emissions: } 15.0 \text{ lb/hr} \times 24 \times 7 \times 51 \div 2,000 = 64.3 \text{ tons/yr}$$
$$8760 \quad = 65.7$$

Potential Emissions: AP-42 factor for untreated emissions =
5 lb/ton ADUP

$$50 \text{ tons/hr} \times 5 = 250 \text{ lb/hr} \stackrel{8760}{=} 1,095 \text{ tons/yr} \checkmark$$

Sulfur Dioxide

Maximum Emissions: use AP-42 factor = 0.1 lb/ton ADUP
50 tons/hr \times 0.1 = 5 lb/hr

Actual Emissions

$$5.0 \text{ lb/hr} \times 24 \times 7 \times 51 \div 2,000 = 21.4 \text{ tons/yr}$$
$$8760 \quad = 21.9$$

10. WOOD PRODUCTS INDUSTRY

Wood processing involves the conversion of raw wood to either pulp, pulpboard, or one of several types of wallboard including plywood, particleboard, or hardboard. This section presents emissions data for chemical wood pulping, for pulpboard and plywood manufacturing, and for woodworking operations. The burning of wood waste in boilers and conical burners is not included as it is discussed in Chapters 1 and 2 of this publication.

10.1 CHEMICAL WOOD PULPING

Revised by Thomas Lahre

10.1.1 General¹

Chemical wood pulping involves the extraction of cellulose from wood by dissolving the lignin that binds the cellulose fibers together. The principal processes used in chemical pulping are the kraft, sulfite, neutral sulfite semichemical (NSSC), dissolving, and soda; the first three of these display the greatest potential for causing air pollution. The kraft process accounts for about 65 percent of all pulp produced in the United States; the sulfite and NSSC processes, together, account for less than 20 percent of the total. The choice of pulping process is determined by the product being made, by the type of wood species available, and by economic considerations.

10.1.2 Kraft Pulping

10.1.2.1 Process Description^{1,2}—The kraft process (see Figure 10.1.2-1) involves the cooking of wood chips under pressure in the presence of a cooking liquor in either a batch or a continuous digester. The cooking liquor, or "white liquor," consisting of an aqueous solution of sodium sulfide and sodium hydroxide, dissolves the lignin that binds the cellulose fibers together.

When cooking is completed, the contents of the digester are forced into the blow tank. Here the major portion of the spent cooking liquor, which contains the dissolved lignin, is drained, and the pulp enters the initial stage of washing. From the blow tank the pulp passes through the knotter where unreacted chunks of wood are removed. The pulp is then washed and, in some mills, bleached before being pressed and dried into the finished product.

It is economically necessary to recover both the inorganic cooking chemicals and the heat content of the spent "black liquor," which is separated from the cooked pulp. Recovery is accomplished by first concentrating the liquor to a level that will support combustion and then feeding it to a furnace where burning and chemical recovery take place.

Initial concentration of the weak black liquor, which contains about 15 percent solids, occurs in the multiple-effect evaporator. Here process steam is passed countercurrent to the liquor in a series of evaporator tubes that increase the solids content to 40 to 55 percent. Further concentration is then effected in the direct contact evaporator. This is generally a scrubbing device (a cyclonic or venturi scrubber or a cascade evaporator) in which hot combustion gases from the recovery furnace mix with the incoming black liquor to raise its solids content to 55 to 70 percent.

The black liquor concentrate is then sprayed into the recovery furnace where the organic content supports combustion. The inorganic compounds fall to the bottom of the furnace and are discharged to the smelt dissolving tank to form a solution called "green liquor." The green liquor is then conveyed to a causticizer where slaked lime (calcium hydroxide) is added to convert the solution back to white liquor, which can be reused in subsequent cooks. Residual lime sludge from the causticizer can be recycled after being dewatered and calcined in the hot lime kiln.

Many mills need more steam for process heating, for driving equipment, for providing electric power, etc., than can be provided by the recovery furnace alone. Thus, conventional industrial boilers that burn coal, oil, natural gas, and in some cases, bark and wood waste are commonly employed.

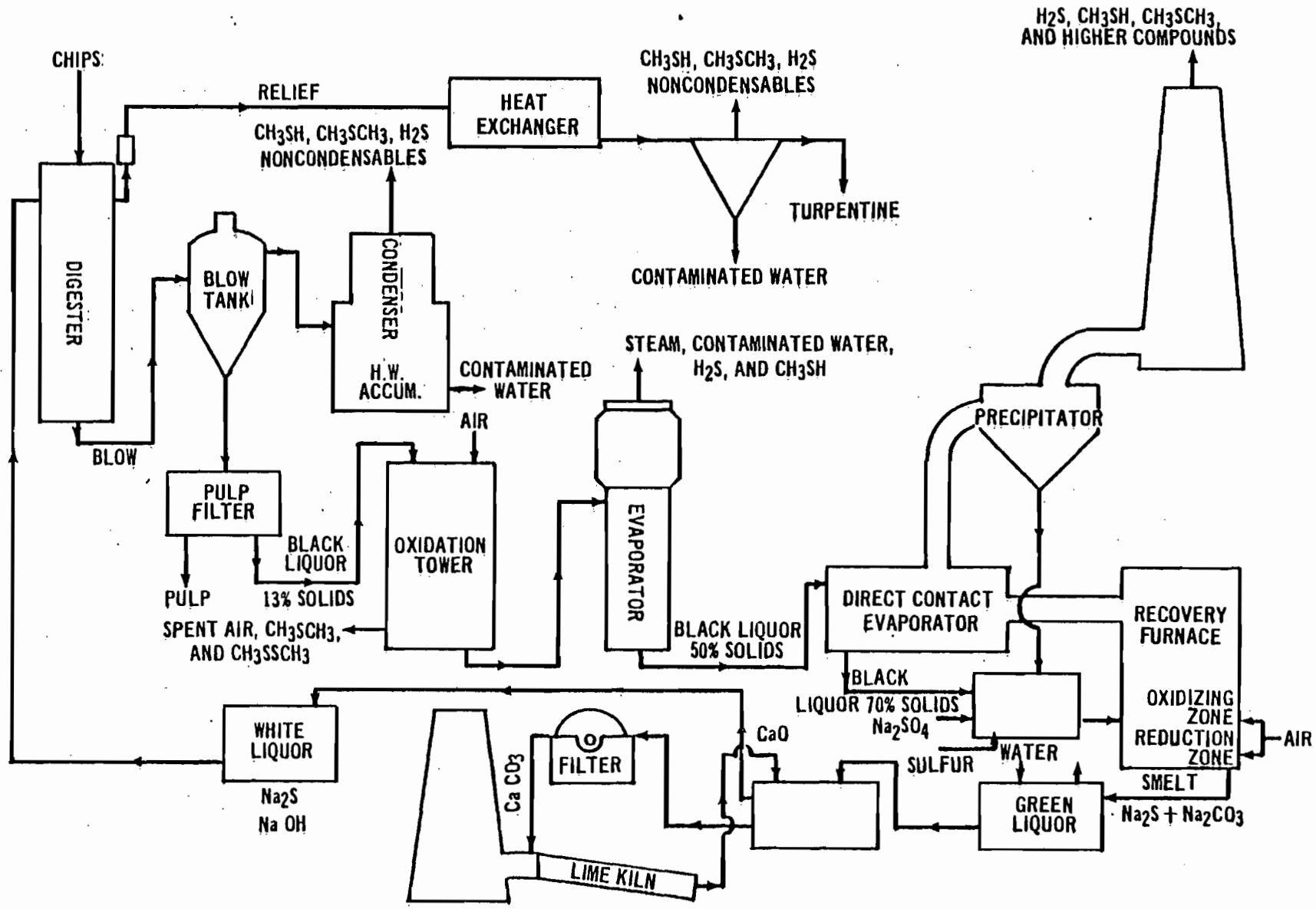

Figure 10.1.2-1. Typical kraft sulfate pulping and recovery process.

10.1.2.2. Emission and Controls¹⁻⁶—Particulate emissions from the kraft process occur primarily from the recovery furnace, the lime kiln, and the smelt dissolving tank. These emissions consist mainly of sodium salts but include some calcium salts from the lime kiln. They are caused primarily by the carryover of solids plus the sublimation and condensation of the inorganic chemicals.

Particulate control is provided on recovery furnaces in a variety of ways. In mills where either a cyclonic scrubber or cascade evaporator serves as the direct contact evaporator, further control is necessary as these devices are generally only 20 to 50 percent efficient for particulates. Most often in these cases, an electrostatic precipitator is employed after the direct contact evaporator to provide an overall particulate control efficiency of 85 to >99 percent. In a few mills, however, a venturi scrubber is utilized as the direct contact evaporator and simultaneously provides 80 to 90 percent particulate control. In either case auxiliary scrubbers may be included after the precipitator or the venturi scrubber to provide additional control of particulates.

Particulate control on lime kilns is generally accomplished by scrubbers. Smelt dissolving tanks are commonly controlled by mesh pads but employ scrubbers when further control is needed.

The characteristic odor of the kraft mill is caused in large part by the emission of hydrogen sulfide. The major source is the direct contact evaporator in which the sodium sulfide in the black liquor reacts with the carbon dioxide in the furnace exhaust. The lime kiln can also be a potential source as a similar reaction occurs involving residual sodium sulfide in the lime mud. Lesser amounts of hydrogen sulfide are emitted with the noncondensable off-gasses from the digesters and multiple-effect evaporators.

The kraft-process odor also results from an assortment of organic sulfur compounds, all of which have extremely low odor thresholds. Methyl mercaptan and dimethyl sulfide are formed in reactions with the wood component lignin. Dimethyl disulfide is formed through the oxidation of mercaptan groups derived from the lignin. These compounds are emitted from many points within a mill; however, the main sources are the digester/blow tank systems and the direct contact evaporator.

Although odor control devices, per se, are not generally employed in kraft mills, control of reduced sulfur compounds can be accomplished by process modifications and by optimizing operating conditions. For example, black liquor oxidation systems, which oxidize sulfides into less reactive thiosulfates, can considerably reduce odorous sulfur emissions from the direct contact evaporator, although the vent gases from such systems become minor odor sources themselves. Noncondensable odorous gases vented from the digester/blow tank system and multiple-effect evaporators can be destroyed by thermal oxidation, usually by passing them through the lime kiln. Optimum operation of the recovery furnace, by avoiding overloading and by maintaining sufficient oxygen residual and turbulence, significantly reduces emissions of reduced sulfur compounds from this source. In addition, the use of fresh water instead of contaminated condensates in the scrubbers and pulp washers further reduces odorous emissions. The effect of any of these modifications on a given mill's emissions will vary considerably.

Several new mills have incorporated recovery systems that eliminate the conventional direct contact evaporators. In one system, preheated combustion air rather than flue gas provides direct contact evaporation. In the other, the multiple-effect evaporator system is extended to replace the direct contact evaporator altogether. In both of these systems, reduced sulfur emissions from the recovery furnace/direct contact evaporator reportedly can be reduced by more than 95 percent from conventional uncontrolled systems.

Sulfur dioxide emissions result mainly from oxidation of reduced sulfur compounds in the recovery furnace. It is reported that the direct contact evaporator absorbs 50 to 80 percent of these emissions; further scrubbing, if employed, can reduce them another 10 to 20 percent.

Potential sources of carbon monoxide emissions from the kraft process include the recovery furnace and lime kilns. The major cause of carbon monoxide emissions is furnace operation well above rated capacity, making it impossible to maintain oxidizing conditions.

Some nitrogen oxides are also emitted from the recovery furnace and lime kilns although the amounts are relatively small. Indications are that nitrogen oxides emissions from each of these sources are on the order of 1 pound per air-dried ton (0.5 kg/air-dried MT) of pulp produced.^{5 6}

A major source of emissions in a kraft mill is the boiler for generating auxiliary steam and power. The fuels used are coal, oil, natural gas, or bark/wood waste. Emission factors for boilers are presented in Chapter 1.

Table 10.1.2-1 presents emission factors for a conventional kraft mill. The most widely used particulate controls devices are shown along with the odor reductions resulting from black liquor oxidation and incineration of noncondensable off-gases.

10.1.3 Acid Sulfite Pulping

by Tom Lahre

10.1.3.1 Process Description¹⁴ - The production of acid sulfite pulp proceeds similarly to kraft pulping except that different chemicals are used in the cooking liquor. In place of the caustic solution used to dissolve the lignin in the wood, sulfurous acid is employed. To buffer the cooking solution, a bisulfite of sodium, magnesium, calcium, or ammonium is used. A simplified flow diagram of a magnesium-base process is shown in Figure 10.1.3-1.

Digestion is carried out under high pressure and high temperature in either batch-mode or continuous digesters in the presence of a sulfurous acid-bisulfite cooking liquor. When cooking is completed, the digester is either discharged at high pressure into a blow pit or its contents are pumped out at a lower pressure into a dump tank. The spent sulfite liquor (also called red liquor) then drains through the bottom of the tank and is either treated and disposed, incinerated, or sent to a plant for recovery of heat and chemicals. The pulp is then washed and processed through screens and centrifuges for removal of knots, bundles of fibers, and other materials. It subsequently may be bleached, pressed, and dried in paper-making operations.

Because of the variety of bases employed in the cooking liquor, numerous schemes for heat and/or chemical recovery have evolved. In calcium-base systems, which are used mostly in older mills, chemical recovery is not practical, and the spent liquor is usually discarded or incinerated. In ammonium-base operations, heat can be recovered from the spent liquor through combustion, but the ammonium base is consumed in the process. In sodium- or magnesium-base operations heat, sulfur, and base recovery are all feasible.

If recovery is practiced, the spent weak red liquor (which contains more than half of the raw materials as dissolved organic solids) is concentrated in a multiple-effect evaporator and direct contact evaporator to 55 to 60 percent solids. Strong liquor is sprayed into a furnace and burned, producing steam for the digesters, evaporators, etc., and to meet the mills power requirements.

When magnesium base liquor is burned, a flue gas is produced from which magnesium oxide is recovered in a multiple cyclone as fine white powder. The magnesium oxide is then water-slaked and used as circulating liquor in a series of venturi scrubbers which are designed to absorb sulfur dioxide from the flue gas and form a bisulfite solution for use in the cook cycle. When sodium-base liquor is burned, the inorganic compounds are recovered as a molten smelt containing sodium sulfide and sodium carbonate. This smelt may be processed further and used to absorb sulfur dioxide from the flue gas and sulfur burner. In some sodium-base mills, however, the smelt may be sold to a nearby kraft mill as raw material for producing green liquor.

Table 10.1.2-1. EMISSION FACTORS FOR SULFATE PULPING^a
(unit weights of air-dried unbleached pulp)
EMISSION FACTOR RATING: A

Source	Type control	Particulates ^b		Sulfur dioxide (SO ₂) ^c		Carbon monoxide ^d		Hydrogen sulfide(S ²⁻) ^e		RSH, RSR, RSSR(S ²⁻) ^{e,f}	
		lb/ton	kg/MT	lb/ton	kg/MT	lb/ton	kg/MT	lb/ton	kg/MT	lb/ton	kg/MT
Digester relief and blow tank	Untreated ^g	—	—	—	—	—	—	0.1	0.06	1.5	0.75
Brown stock washers	Untreated	—	—	0.01	0.005	—	—	0.02	0.01	0.2	0.1
Multiple effect evaporators	Untreated ^g	—	—	0.01	0.005	—	—	0.1	0.05	0.4	0.2
Recovery boiler and direct contact evaporator	Untreated ^h	150	75	5	2.5	2 - 60	1 - 30	12 ⁱ	6 ⁱ	1 ⁱ	0.5 ⁱ
	Venturi scrubber ^j	47	23.5	5	2.5	2 - 60	1 - 30	12 ⁱ	6 ⁱ	1 ⁱ	0.5 ⁱ
	Electrostatic precipitator	8	4	5	2.5	2 - 60	1 - 30	12 ⁱ	6 ⁱ	1 ⁱ	0.5 ⁱ
	Auxiliary scrubber	3 - 15 ^k	1.5 - 7.5 ^k	3	1.5	2 - 60	1 - 30	12 ⁱ	6 ⁱ	1 ⁱ	0.5 ⁱ
Smelt dissolving tank	Untreated	5	2.5	0.1	0.05	—	—	0.04	0.02	0.4	0.2
	Mesh pad	1	0.5	0.1	0.05	—	—	0.04	0.02	0.4	0.2
Lime kilns	Untreated	45	22.5	0.3	0.15	10	5	0.5	0.25	0.25	0.125
	Scrubber	3	1.5	0.2	0.1	10	5	0.5	0.25	0.25	0.125
Turpentine condenser	Untreated	—	—	—	—	—	—	0.01	0.005	0.5	0.25
Miscellaneous sources ^l	Untreated	—	—	—	—	—	—	—	—	0.5	0.25

^a For more detailed data on specific types of mills, consult Reference 1.

^b References 1, 7, 8.

^c References 1, 7, 9, 10.

^d References 6, 11. Use higher value for overloaded furnaces.

^e References 1, 4, 7-10, 12, 13. These reduced sulfur compounds are usually expressed as sulfur.

^f RSH-methyl mercaptan; RSR-dimethyl sulfide; RSSR-dimethyl disulfide.

^g If the noncondensable gases from these sources are vented to the lime kiln, recovery furnace, or equivalent, the reduced sulfur compounds are destroyed.

^h These factors apply when either a cyclonic scrubber or cascade evaporator is used for direct contact evaporation with no further controls.

ⁱ These reduced sulfur compounds (TRS) are typically reduced by 50 percent when black liquor oxidation is employed but can be cut by 90 to 99 percent when oxidation is complete and the recovery furnace is operated optimally.

^j These factors apply when a venturi scrubber is used for direct contact evaporation with no further controls.

^k Use 15(7.5) when the auxiliary scrubber follows a venturi scrubber and 3(1.5) when employed after an electrostatic precipitator.

^l Includes knottler vents, brownstock seal tanks, etc. When black liquor oxidation is included, a factor of 0.6(0.3) should be used.

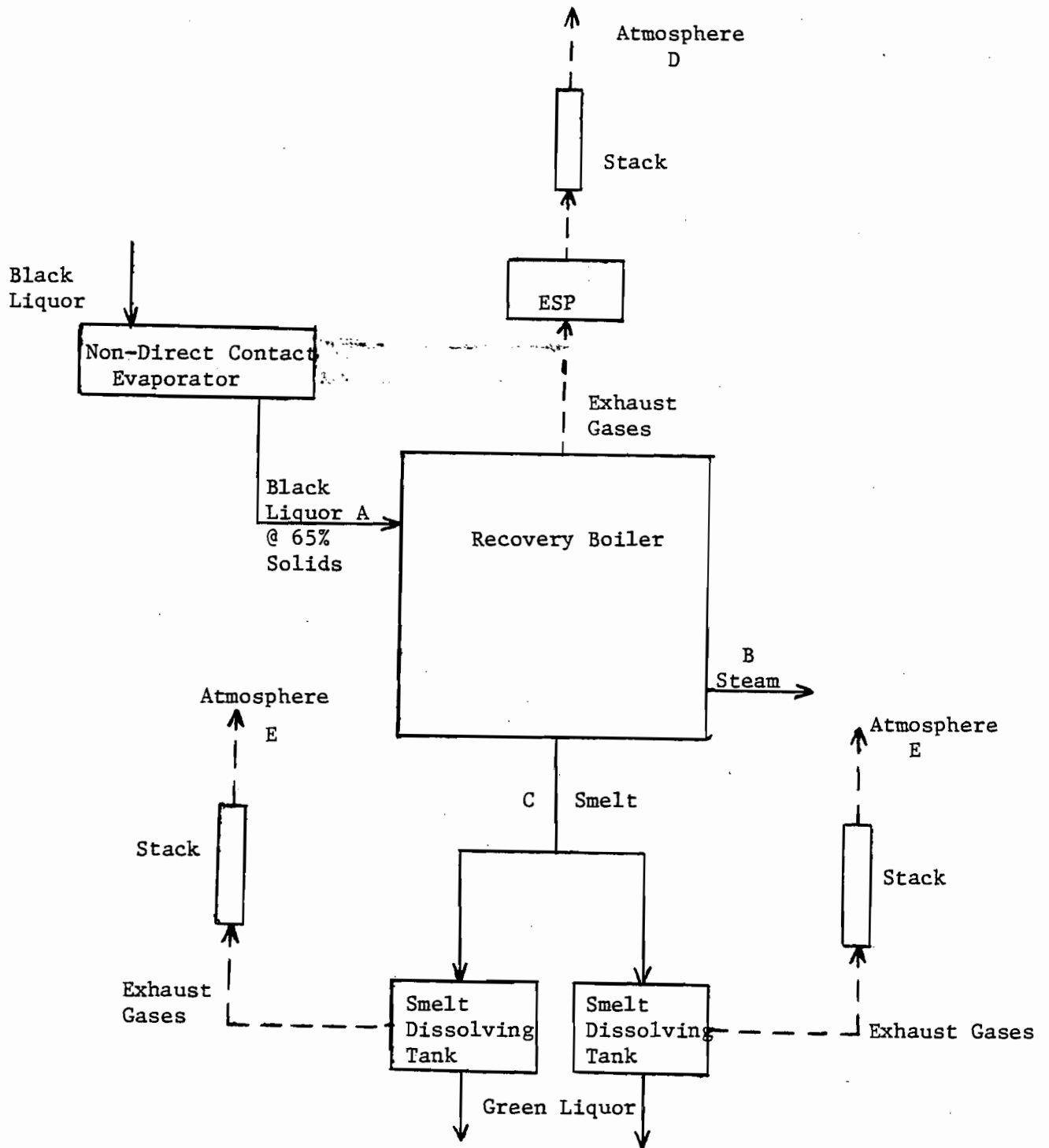

Flow Diagram
Recovery Boiler #5

9. An application fee of \$20, unless exempted by Section 17-4.05(3), F.A.C. The check should be made payable to the Department of Environmental Regulation.
10. With an application for operation permit, attach a Certificate of Completion of Construction indicating that the source was constructed as shown in the construction permit.

SECTION VI: BEST AVAILABLE CONTROL TECHNOLOGY

Recovery Boiler

- A. Are standards of performance for new stationary sources pursuant to 40 C.F.R. Part 60 applicable to the source?
 Yes No

Contaminant	Rate or Concentration
Particulate Matter	0.044 gr/dscf and 35% opacity
Total Reduced Sulfur	5 ppm by volume (dry basis)

- B. Has EPA declared the best available control technology for this class of sources (If yes, attach copy) Yes No

Contaminant	Rate or Concentration
Particulate Matter	0.10 g/dscm (0.044 gr/dscf) at 8% O ₂
Sulfur Dioxide	50 ppm - Internal Process Design of Boiler
Total Reduced Sulfur	5 ppm at 8% O ₂ - low odor design of boiler

- C. What emission levels do you propose as best available control technology?

Contaminant	Rate or Concentration
Recovery Boiler: Particulate Matter	0.044 gr/dscf and 35% opacity
Total Reduced Sulfur	5 ppm at 8% O ₂ - low odor design of boiler
All other pollutants	Boiler design and proper operation

- D. Describe the existing control and treatment technology (if any).

- Control Device/System: Electrostatic Precipitator
- Operating Principles: Electric charging of particles by high voltage corona followed by migration to oppositely charged electrode for collection.
- Efficiency: *99+ (manufacturer's data)
- Capital Costs:
- Useful Life: 5 to 10 years
- Operating Costs: See Attachment B
- Energy: 150 KW
- Maintenance Cost:
- Emissions:

Contaminant	Rate or Concentration
See Attachment B	

*Explain method of determining D 3 above.

10. Stack Parameters See Attachment B

- | | | | |
|---------------|------|-----------------|-----|
| a. Height: | ft. | b. Diameter: | ft. |
| c. Flow Rate: | ACFM | d. Temperature: | °F |
| e. Velocity: | FPS | | |

E. Describe the control and treatment technology available (As many types as applicable, use additional pages if necessary).

1.

- a. Control Device: Electrostatic Precipitator
- b. Operating Principles: See Item D
- c. Efficiency*:
- d. Capital Cost:
- e. Useful Life:
- f. Operating Cost:
- g. Energy*:
- h. Maintenance Cost:
- i. Availability of construction materials and process chemicals:
- j. Applicability to manufacturing processes:
- k. Ability to construct with control device, install in available space, and operate within proposed levels:

2.

- a. Control Device:
- b. Operating Principles:
- c. Efficiency*:
- d. Capital Cost:
- e. Useful Life:
- f. Operating Cost:
- g. Energy**:
- h. Maintenance Costs:
- i. Availability of construction materials and process chemicals:
- j. Applicability to manufacturing processes:
- k. Ability to construct with control device, install in available space, and operate within proposed levels:

*Explain method of determining efficiency.

**Energy to be reported in units of electrical power - KWH design rate.

3.

- a. Control Device:
- b. Operating Principles:
- c. Efficiency*:
- d. Capital Cost:
- e. Life:
- f. Operating Cost:
- g. Energy:
- h. Maintenance Cost:

*Explain method of determining efficiency above.

- i. Availability of construction materials and process chemicals:
 - j. Applicability to manufacturing processes:
 - k. Ability to construct with control device, install in available space and operate within proposed levels:
- 4.
- a. Control Device
 - b. Operating Principles:
 - c. Efficiency*:
 - d. Capital Cost:
 - e. Life:
 - f. Operating Cost:
 - g. Energy:
 - h. Maintenance Cost:
 - i. Availability of construction materials and process chemicals:
 - j. Applicability to manufacturing processes:
 - k. Ability to construct with control device, install in available space, and operate within proposed levels:

F: Describe the control technology selected:

- 1. Control Device: Electrostatic Precipitator
- 2. Efficiency*: 99%+
- 3. Capital Cost: See Attachment B
- 4. Life: 5 to 10 years
- 5. Operating Cost: See Attachment B
- 6. Energy: 150 KW
- 7. Maintenance Cost:
- 8. Manufacturer: Environmental Elements or equivalent
- 9. Other locations where employed on similar processes:
 - a. See attached vendor list and efficiency guarantees.
 - (1) Company:
 - (2) Mailing Address:
 - (3) City:
 - (4) State:
 - (5) Environmental Manager:
 - (6) Telephone No.:

*Explain method of determining efficiency above.

- (7) Emissions*:

Contaminant	Rate or Concentration

- (8) Process Rate*:

b.

- (1) Company:
- (2) Mailing Address:
- (3) City:
- (4) State:

*Applicant must provide this information when available. Should this information not be available, applicant must state the reason(s) why.

(5) Environmental Manager:

(6) Telephone No.:

(7) Emissions*:

Contaminant	Rate or Concentration
_____	_____
_____	_____
_____	_____

(8) Process Rate*:

10. Reason for selection and description of systems:

See attached sheet..

*Applicant must provide this information when available. Should this information not be available, applicant must state the reason(s) why.

Recovery Boiler - Nearly all recovery furnaces in the pulp and paper industry have been controlled by electrostatic precipitators (ESP's). The degree of control has varied, ranging from 90 percent on older installations to 99.8 percent on recent installations. The attached Environmental Elements brochure lists many of these installations, most of which are guaranteed at efficiencies above 99 percent. The proposed boiler will be a low odor, non-direct contact evaporation type boiler. No applications of fabric filters or wet scrubbers (except after ESP on existing unit) have been reported in the literature.

Because of the widespread usage of ESP's on recovery boilers, and their high removal efficiencies, an ESP was chosen as BACT for this application. Fabric filters would be unsuitable because of the sticky nature of the particulate, which would plug the bags.

An economic analysis was performed for various ESP control levels (see Attachment B). This analysis indicates that achieving a 0.02 gr/dscf exhaust loading compared to 0.044 (NSPS) would require 20 to 30 percent greater capital investment and about a 10 percent increase in annualized costs. In addition, the low-odor requirement for the new recovery boiler increases the size of the ESP by about 20 percent as compared to a high-odor boiler, further increasing the cost of control. Because of the relatively low particulate emission rate associated with the boilers at NSPS levels (75 lb/hr) and the small impact of all particulate sources at G-P (see PSD report), control below the NSPS level is not considered necessary or justified.

Three (3) BACT determinations are known to date for a recovery boiler. In all three, ESPs at 99.5 to 99.7 percent efficiency were selected to control particulate emissions to the 0.10 g/dscm (corrected to 8% O₂) NSPS level. This level is equivalent to 0.044 gr/dscf.

The attached test data summary for the existing recovery boiler at G-P (Attachment B) shows that the 0.044 gr/dscf NSPS level has been exceeded on occasion (6 times out of 23 tests). This has occurred even though the ESP for this recovery boiler is oversized (as stated by Environmental Elements and confirmed by their list of ESP installations--Hudson Pulp and Paper designed for 540,200 acfm but has actually not exceeded about 375,000 acfm). This overdesign has resulted in lower particulate emissions. As a result, the NSPS level of 0.044 gr/dscf is considered to be an emission level reasonably achievable, considering economics, energy and environmental impacts.

Sulfur dioxide control systems are not known to have been applied to recovery boilers, except in one case where BACT was an impingement-type wet scrubber. Because of the relatively low sulfur dioxide emission rate of the boiler of 250 lb/hr, equivalent to about 0.25 lb/10⁶ Btu, no add on control systems are justified. Such a system would cost upwards of \$4 million (see proposed Combination boiler application for similar costs), would produce a solid waste sludge which must be disposed of, and would require a significant energy input (approximately 2,000 kw). As a further comparison, the Seminole Electric Cooperative plant currently under construction near G-P will emit approximately 13,000 lb/hr of SO₂ under maximum load conditions. Therefore, BACT for the proposed recovery boiler for SO₂ is proposed as the uncontrolled AP-42 emission rate. EPA has declared BACT for SO₂ to be internal process design of boiler in the other BACT determinations done to date.

Information concerning NO_x emissions from Kraft Pulp Mill recovery furnaces is virtually nonexistent. As a result, little information is available concerning operational techniques and furnace modifications to reduce NO_x formation. The NCASI study (see Combination boiler application) represents the most comprehensive, up-to-date study available. In this study, NO_x emissions were found to be only a function of firing rate as a percentage of total capacity: as firing

rate increased, NO_x emissions per 10⁶ Btu heat input decreased. No relationship was found between NO_x emissions and:

- the number of liquor burners employed,
- the type of burner tips used, or
- the liquor pressure at the burner tips.

Since the NSPS for fossil-fuel steam generators for liquid fuel firing is 0.3 lb/10⁶ Btu, the firing of black liquor in the proposed recovery furnace, with an expected emission rate of 0.09 lb/10⁶ Btu for large furnaces, represents the best control method available for NO_x.

Similarly, no feasible control methods, except for proper boiler operation, are known to exist for VOC or CO. VOC emissions were found to be less for non-direct contact evaporation furnaces than for direct-contact evaporator furnaces (see NCASI study). Therefore, the proposed recovery boiler represents a lower VOC emission level. The data also indicate that minimum VOC emission correlate with minimum CO emissions.

For TRS, process controls and non-contact evaporators are considered as the only control technique for use on existing boilers (see Final Guideline Document: Control of TRS Emissions from Existing Kraft Pulp Mills). TRS emissions are described as a function of combustion air, rate of black liquor solids feed, turbulence in the oxidation zone, oxygen content of the fluegas, the spray pattern and droplet size of black liquor feed, and the degree of disturbance of the smelt bed. New boiler designs have considered these parameters as reducing TRS emissions.

The promulgated NSPS of 5 ppm was based upon achievable levels with the low-odor boiler. In the only BACT determination known to date for recovery boilers, the NSPS level was selected as BACT, with the control

technique being the low-odor design. Consequently, BACT for TRS for the proposed boiler is proposed as the 5 ppm NSPS level, with utilization of the low-odor type recovery boiler.

REFERENCES

1. Personal Communication. Neal R. Davis, Applications Engineer, Environmental Elements Corporation, Baltimore, Maryland. May 22, 1981.
2. Operation and Maintenance of Particulate Control Devices in Kraft Pulp Mill and Crushed Stone Industries. PEDCO Environmental Specialists, Inc., Cincinnati, Ohio. EPA-600/2-78-210, October 1978.
3. Federal Register, Vol. 43, No. 37, February 23, 1981. Kraft Pulp Mills NSPS, pg. 7568-7598.
4. Technology Assessment Report for Industrial Boiler Applications: NO_x Flue Gas Treatment. Radian Corporation, EPA-600/7-79-178 g, December, 1978.
5. Control Techniques for Nitrogen Oxides Emissions from Stationary Sources, Second Edition. Acurex Corp., EPA-450/1-78-001, January 1978.
6. NO_x Emissions from Combustion Sources in the Pulp and Paper Industry. Hood, H.T. and Maner, R.A., NCASI. Paper presented at 1981 TAPPI Environmental Conference, New Orleans, LA.
7. Volatile Organic Compound Emissions from Pacific Northwest Pulp and Paper Industry Combustion Sources. Dallons, V.J. and Simon, C., NCASI. Paper presented at 1981 TAPPI Environmental Conference, New Orleans, LA.
8. Final Guideline Document: Control of TRS Emissions from Existing Kraft Pulp Mills. U.S. EPA, EPA-450/2-78-003a, 1978.
9. Compilation of BACT/LAER Determination, Revised. PEDCO. Environmental Specialists, Inc. May 1980. EPA-450-2-08-070.

ATTACHMENT B

RECOVERY BOILER BACT INFORMATION

Flow Rate = 200,000 dscfm, 375,100 acfm (from present No. 4 recovery boiler operation)

NSPS Level = 0.044 gr/dscf particulate

Efficiency Calculations:

1. $0.044 \text{ gr/dscf} \times 200,000 \times 60 \div 7,000 = 75.4 \text{ lb/hr}$

Uncontrolled emissions (see Attachment A) = 7,500 lb/hr

Efficiency = $(7,500 - 75.4) \div 7,500 \times 100 = 99\%$ to meet NSPS level.

2. $0.03 \text{ gr/dscf} \times 200,000 \times 60 \div 7,000 = 51.4 \text{ lb/hr}$

Efficiency required = $(7,500 - 51.4) \div 7,500 \times 100 = 99.3\%$

3. $0.02 \text{ gr/dscf} \times 200,000 \times 60 \div 7,000 = 34.3 \text{ lb/hr}$

Efficiency required = $(7,500 - 34.3) \div 7,500 \times 100 = 99.5\%$

Cost Data for Low-Odor Recovery Boiler

<u>Grain Loading</u> (gr/dscf)	<u>Mass Emissions</u> (lb/hr)	<u>Required Efficiency</u> (%)	<u>Capital Cost</u> (\$x106)	<u>Annual Cost</u> (\$x103)
0.044	75.4	99.0	2.1	465
0.03	51.4	99.3	2.4	500
0.02	34.3	99.5	2.5	520

Cost data obtained from "Operation and Maintenance of Particulate Control Devices in Kraft Pulp Mill and Crushed Stone Industries," adjusted for 10 percent inflation rate per year. By comparison, Environmental Elements roughly estimated \$5 million capital costs to meet 0.02 gr/dscf and \$3.75 million capital cost to meet 0.044 gr/dscf.

OPERATION OF NO. 4 RECOVERY BOILER WITH ESP:
SUMMARY OF TSP EMISSIONS TESTS

Date	Flow Rate (dscfm)	Grain Loading (gr/dscf)
02/28/77	164,109	0.0113
03/04/77	156,147	0.0497
03/04/77	159,474	0.0229
Average	<u>159,910</u>	<u>0.0280</u>
09/28/77	138,965	0.0369
09/29/77	140,863	0.0416
09/29/77	141,025	0.0157
Average	<u>140,284</u>	<u>0.0314</u>
03/78	167,837	0.0510
	165,821	0.0819
	185,644	0.0293
Average	<u>173,100</u>	<u>0.0541</u>
09/78	150,368	0.0485
	153,896	0.0446
	142,433	0.0514
Average	<u>148,899</u>	<u>0.0482</u>
04/79	229,303	--
	171,399	0.0306
	183,489	0.0158
Average	<u>194,730</u>	<u>0.0232</u>
09/79	134,951	0.0296
	142,429	0.0145
	152,045	0.0123
Average	<u>143,142</u>	<u>0.0188</u>
03/80	174,981	0.0060
	173,501	0.0141
	177,782	0.0139
Average	<u>175,421</u>	<u>0.0113</u>
09/80	196,637	0.038
	192,917	0.041
	198,136	0.007
Average	<u>195,897</u>	<u>0.029</u>

SOURCE NAME/TYPE: Kraft pulp mill, 850 ADT pulp/c.

NAME/ADDRESS: Boise-Cascade Corporation, Rumford, Maine 04276

DETERMINATION IS: CONDITIONAL/FINAL/PENDING ISSUED on 4/6/79, BASIS* of BACT¹/LAER/BAC
for NEW/MODIFIED SOURCE (date)

BY Environmental Protection Agency, Region 1 John Courcier (FTS) 223-4448
(Agency) (Person) (Phone)

PERMIT PARAMETERS: AFFECTED FACILITIES	THROUGHPUT CAPACITY (Weight Rate)	POLLUTANT(S) EMITTED	EMISSION LIMIT(S) and (basis for)**	CONTROL STRATEGY DESCRIPT Equipment Type, Etc.	Eff
Recovery Boiler	850 ADT pulp/day	Particulates	0.10 g/dscm, ^{corrected to} 8% O ₂ ; N	ESP	99.7%
		SO ₂	150 ppm, ^{corrected to} 8% O ₂ ; B	Internal Process Design of boiler	
		TRS	5 ppm, ^{corrected to} 8% O ₂ ; N	Low-odor Design of boiler	
Smelt tank	850 ADT pulp/day	Particulates	0.1 g/kg of black liquor solids; N	low pressure (6-8" H ₂ O) scrubber	95%
		TRS	0.0084 g/kg black liquor solids; N	Wet scrubber	

NOTES: NSPS was considered to be BACT in this situation because the regs for kraft pulp mills are relatively recent (2/23/78)

* Circle one. BACT¹ means a determination made under pre-1977 amendments; BACT² means post-1977 amendments to CAA.

** Basis symbols: Use B=BACT, N=NSPS, S=SIP, L=LAER

BACT/LAER CLEARINGHOUSE REPORT

10.1

SOURCE TYPE/SIZE: SEMICHEMICAL/KRAFT PULP MILL; 2194 TAD/D

NAME/ADDRESS: INTERNATIONAL PAPER COMPANY, PO BOX 160707, MOBILE, ALABAMA 36616

DETERMINATION DATA: CONDITIONAL/FINAL/PENDING for BACT LAER on NEW/MODIFIED SOURCE
 KEY DATES: Application-Recd. _____, Completed _____; Determination-Proposed _____, Final _____

BY: (Agency) U.S. EPA REGION VI Person _____ Phone _____

AFFECTED FACILITIES	THROUGHPUT CAPACITY	EMISSION RATE* -UNCONTROLLED	EMISSION LIMITS (Basis)**	CONTROL STRATEGY DESCRIPTION Equipment type, etc.	Eff. %
Recovery furnaces (2) (straight kraft)		SO ₂	510 lb/h each (B)	Good process controls	
		TRS	5 ppmv, at 8% O ₂ (N)	Good process controls	
		CO	110 lb/h (B)	Good process controls	
		NO _x	88 lb/h (B)	Good process controls	
		PM	54.0 lb/h ea, and (N) 0.10 g/dscm at 8% O ₂	Electrostatic precipitators with pneumatic rappers	99.7
Power/Steam Boilers (2)					
Coal fired:	645x10 ⁶ Btu/h max.	SO ₂	^a 1.2 lb/10 ⁶ Btu, (N) and 774 lb/h ea.	Low sulfur fossil fuels to meet NSPS requirements.	

SOURCE OPERATION: BATCH/CONTINUOUS: _____ hrs/yr; % by Season _____
 _____ W _____ Sp _____ Su _____ F

- NOTES: ^a Coal firing only
^b 100% oil firing
^c Firing fossil fuel with wood residue: proration is 1.2 lb/10⁶ Btu for coal, 0.80 lb/10⁶ Btu for oil, 0.24 lb/10⁶ for wood contribution.
^d Firing fossil fuels

* Specify pollutant (PM, SO₂, NO_x, HC, CO or other) and mass emission rate
 ** Basis symbols: Use B = BACT, N = NSPS, S = SIP, A = Achieved-in-Practice (AIP)

BACT/LAER CLEARINGHOUSE REPORT

SOURCE TYPE/SIZE: KRAFT PULP MILL

PULPING CAPACITY 1034 TONS/DAY

NAME/ADDRESS: BOISE CASCADE, P.O. BOX 500, WALLULA, WA 99363

DETERMINATION IS: CONDITIONAL/FINAL/PENDING: DATE OF ISSUE: 2/24/78 BASIS: * BACT¹/LAER (BACT)²
 FOR NEW/MODIFIED SOURCE

BY EPA REGION X LARRY SIMS AND PAUL BOYS (206) 442-1106
 (Agency) (Person) (Phone)

AFFECTED FACILITIES	THROUGHPUT CAPACITY, weight rate	POLLUTANT(S) EMITTED	EMISSION LIMIT(S) AND BASIS FOR**	CONTROL STRATEGY DESCRIPTION	
				Equipment type, etc.	Eff., %
Recovery boiler (No. 2)	238 ADT/day	TSP	0.44 gr/scf/476 (N)	ESP	99.5
	feed or 738,000 ^a		lb/day		
		SO ₂	160 ppm/5424 lb/day (B)	Impinger type wet scrubber	95
		Opacity	35% (N)		
Lime kiln	544 tons/day	TSP (gas)	0.067 gr/scf/466 (B)	Venturi scrubber	
	or 847 ADT		lb/day		

NOTES: ^a Pounds black liquor dry solids/day; ADT means Air Dried Tons.
 Where no NSP requirement, state standards apply for opacity - 20%

* Circle one. BACT-1 indicates determination made under pre-1977 amendments; BACT-2 indicates post-1977 amendments to CAA.

** Basis symbols: Use B = BACT, N = NSPS, S = SIP, L = LAER, P = PSD Increment

BACT/LAER CLEARINGHOUSE REPORT

SOURCE TYPE/SIZE: KRAFT PULP MILL PULPING CAPACITY 1034 TONS/DAY

NAME/ADDRESS: BOISE CASCADE, P.O. BOX 500, WALLULA, WA 99363

DETERMINATION IS: CONDITIONAL/FINAL/PENDING: DATE OF ISSUE: 2/24/78 BASIS:* BACT¹/LAER/BACT²
FOR NEW/MODIFIED SOURCE

BY EPA REGION X LARRY SIMS AND PAUL BOYS (206) 442-1106
(Agency) (Person) (Phone)

PERMIT PARAMETERS: AFFECTED FACILITIES	THROUGHPUT CAPACITY, weight rate	POLLUTANT(S) EMITTED	EMISSION LIMIT(S) AND BASIS FOR**	CONTROL STRATEGY DESCRIPTION	
				Equipment type, etc.	Eff.,%
Lime kiln (continued)		TSP (oil)	0.12 gr/scf/906 (B)		
			lb/day		
		Opacity	20% (S)		
		SO ₂	5 ppm/19 lb/day (B)		
No.2 Dissolver vent	253 ADT	TSP	71 lb/day (N)	Chemico-type scrubber	
		Opacity	20% (S)		
Decker hood	200 ADT	TSP	0.01 ADT/2 lb/day (B)		
		Opacity	20% (S)		

NOTES: _____

* Circle one. BACT-1 indicates determination made under pre-1977 amendments; BACT-2 indicates post-1977 amendments to CAA.

** Basis symbols: Use B = BACT, N = NSPS, S = SIP, L = LAER, P = PSD Increment

**ENVIRONMENTAL
ELEMENTS
CORPORATION**

Subsidiary of Koppers Company, Inc.

Clean Air From Paper Mill Recovery Boilers Without Corrosion

J. R. ZARFOSS
Mgr. Technical Development
Air Cleaning Systems
Environmental Elements Corp.
Baltimore, Maryland

PRESENTED AT A JOINT SEMINAR
SPONSORED BY
AIR POLLUTION CONTROL ASSOCIATION
NATIONAL ASSOCIATION OF CORROSION ENGINEERS
INDUSTRIAL GAS CLEANING INSTITUTE
ATLANTA, GEORGIA, JANUARY 1976

BEST AVAILABLE COPY

BACKGROUND

Collection of sodium sulphate (salt cake) from paper mill recovery boiler flue gas by electrostatic precipitators requires special attention. Excessive corrosion is an ever present hazard. The sources of the problem are the high moisture content of the flue gas and the corrosive atmosphere surrounding most installations.

A brief look at history will provide an understanding of the severity of the situation. In the fifties, a precipitator was typically located on the ground with horizontal ductwork leading to a masonry stack. The ductwork was made of mild steel. In many installations salt cake accumulated on the duct floor; probably the result of eddies and swirls in the gas stream. The steel under these accumulations corroded at a rapid rate.

The precipitator shell was made of glazed tile block to inhibit chemical attack. Performance was generally satisfactory; however, cracks in the mortar and tile resulted in corrosion of the structural steel embedded in the wall.

Internal components of the precipitator were made of mild steel and had satisfactory life.

In the early sixties, a major design change was initiated in order to extend the life of the ductwork. Precipitators were placed on top of the boiler building. All ductwork could then be vertically oriented to eliminate fall-out. In addition, the quality of insulation was improved.

Ductwork corrosion was now under control. Because of the high elevation, tall stacks were not needed. Short, 15 foot, steel stub stacks were attached to the top of the precipitator. It was quickly discovered that the stacks had to be well insulated to prevent corrosion event at gas temperatures of 75°C (350°F).

These new boiler buildings were typically taller than the older buildings, and the precipitator was frequently engulfed in vapors and gases from nearby vents and stacks which were shorter in height. The atmosphere contained both acid mist and mists that were caustic. Water as a vapor and a mist was also present. The paint on all exterior surfaces was rapidly attacked making it difficult to protect the steel. Copper was particularly vulnerable. Electrical components required frequent maintenance. Specification required that the aluminum hand rails could not be an alloy containing copper. Fittings, locks, and gauges of brass had a very short life.

The shell of the precipitator was still made of tile block, but the precipitators became larger in size due to higher efficiency requirements. Building movement, vibration, and thermal stresses, combined with the larger size, caused additional maintenance problems for the tile shell. These problems caused designers to consider alternatives, and by 1967 steel shell precipitators were in use. It was anticipated that this transition would require a thorough understanding of precipitator corrosion.

PROBLEM IDENTIFICATION

In the early stages, metal which is corroding rapidly has the appearance of many thin brittle sheets separated by layers of granular material. The brittle sheets are iron oxide in color, and the granular material is sometimes a bright orange. With time, the layers break away from the parent metal and extend out into space hinged along one side. The combined thickness can be as much as 1/2 inch. When the parent metal is examined in these localized areas, it has been found that only a few thousandths of an inch have been removed. This indicates a substantial increase in volume. Rapid corrosion is most frequently found on the inside surface of steel which has stiffeners or structural columns attached to the outside. It is also prevalent around door frames and in the corners of the shell. A typical precipitator is shown in fig. 1.

Corrosion problems were not restricted to the paper mill application; the scientific community, in response to the needs of industry, searched for the mechanisms by which metal is attacked when exposed to flue gas. In 1971, J. Gooch wrote an excellent summary of this work.

Flue gas from a boiler contains H₂O vapor with some SO₂ present. Below 415°F, 99% of the SO₂ vapor combines quickly with the H₂O vapor to form H₂SO₄ in the vapor phase.¹ As the temperature of the flue gas is lowered, the H₂SO₄ vapor becomes saturated and forms a "mist." Sulphuric acid in flue gas does not necessarily condense on a cool surface.²

The acid "dew-point" temperature is the beginning of the saturation process. This temperature cannot be accurately defined because there is no sharp boundary between the vapor and liquid phase. The amount "condensing" is a function of temperature with the maximum rate occurring 40-60°F below the onset temperature. As the temperature is lowered further, the rate decreases. Avoiding the temperature associated with the peak rate of saturation is highly desirable and more important than dew-point in controlling corrosion.² Unfortunately, it is not predictable.

The charts and graphs seen in literature relating H₂O, SO₂, and H₂SO₄ vapor to dew-point temperature should be considered only as the theoretical amount available in the gas. They cannot be used to predict corrosion.

The general "rusty" condition seen in most precipitators is probably the result of acid deposits and other harmful elements, such as chlorides, as they relate to both operating conditions and atmospheric moisture during idle periods. The rapid catastrophic corrosion, seen occasionally, is most likely the result of water condensing on the metal surface during operation and forming a dilute solution with whatever acids and salts are present. Depending on composition, this solution can vigorously attack the metal.² (Do not overlook air leakage as an aggravation factor.)

The dew-point temperature of the

uncombined water vapor is separate and distinct from the acid dew-point. It is predictable and measurable and must be avoided to minimize corrosion. The dew-point is process dependent, but 75°C (165°F) is a typical value for recovery boiler flue gas.

There are other sources of trouble. Some precipitators have a re-circulating pool of liquid, referred to as "black liquor", under the treatment zone. It is used to catch and remove the collected material. Vapors from this pool are corrosive and this characteristic increases with greater amounts of oxygen and sodium sulphide.³ Water vapor which also escapes from this pool, can locally raise the dew point temperature. Further compounding the problem is the temperature of the black liquor. The pool, being at 80°C (180°F), conducts heat from the steel shell causing it to approach the water vapor dew point.

To summarize, the amount of corrosion occurring on a low temperature metal surface in a precipitator is a function of the water and acid content of the flue gas, the metal and gas temperature, the composition of the particulate matter, the nature of the interactions occurring between the vapors, steel, and particulate matter and the rate of acid transfer to the metal surface.¹

THE SOLUTION: maintain the temperature of the steel exposed to the flue gas above the dew point of the water vapor.

DESIGNS FOR TODAY

Precipitator installations being designed today have evolved from the problems of the past. Locating the precipitator on top of the boiler building is not as attractive as it once was because of the high cost of exterior maintenance. Horizontal ductwork is again being used but is kept to a minimum. High quality insulation is used to maintain the temperature of the steel. Satisfactory ductwork is an accepted fact.

The main concern is the precipitator shell. Problems arise because the temperature of the shell varies over its surface. Heat available from the gas to maintain the shell temperature is not uniform inside the precipitator. The lowest amount of heat is available in the zones of slow gas circulation, such as the top, bottom and corners of the shell. Also, the heat loss characteristic is not uniform because of the structural members attached to the shell. At flue gas temperatures above 180°C (350°F) a well constructed, well insulated steel shell precipitator will have no problem, even in the cooler zones. Gas temperatures of 130°C to 140°C (265°F) are known to be a problem because the highest heat-loss surfaces, in the cooler zones, begin to show evidence of rapid corrosion. In practice, 150°C (300°F) is the approximate boundary below which supplemental heating is required in addition to insulation.

There are two heating techniques in practice today. Stationary electric heaters are sometimes placed between the insulation and shell panels

in the problem areas. Another technique is to circulate heated air in the space between the insulation and the shell; 7000 CFM and 500,000 BTU per hour are typical values. This hot air chamber can also be formed by a double wall of steel. In the latter case, insulation is then placed against the outer skin. All steel components attached to the outside shell surface must be totally within the hot air chamber to inhibit heat loss.

The user, as well as the designer, must give careful consideration to the operating procedures. There have been instances where vapors and gases have been vented into the precipitator as a means of releasing them into the atmosphere. If these gases are low in temperature and/or have a high moisture content, they can create major problems. Rapid localized corrosion surrounding the point of entry is a result typical of this practice. The reason is, of course, the raising of the dew-point temperature or the cooling of steel in the troubled area. Two examples illustrate the severity of the situation. A vent from a tank containing a hot liquid was introduced into the lower portion of the precipitator. This is typically the zone of lowest temperature. In this space under the treatment zone or located gas baffles and the lower extremities of the collection surfaces. After three months of this practice, a 3 ft. diameter hole was found in the 1/2 inch baffle, and the bottom 24 inches of nearby 18 GA. collection surfaces were destroyed. At another installation, water was substituted for the

black liquor pool under the treatment zone. The additional moisture from the water pool and, possibly, its temperature caused rapid corrosion. In only six months, the bottom six feet of all collection surfaces were transformed into a configuration similar to face.

Upon shutting down a precipitator and observing the salt cake clinging to the inside surfaces, some operators have thought it best to wash the components with water. Sodium sulphate is soluble in water, and washing is a relatively easy accomplishment. However, this raises the humidity of the air inside the treatment zone, and the liquid solution created by the water and Sodium Sulfate can be highly corrosive. The result is more harmful than if the precipitator had been left dirty. Every washing seems to take its toll especially if the precipitator is then to remain idle for long periods of time. The recommended procedure for idle periods is to close all doors and hatches and to maintain the temperature of the steel shell above the water dew-point of the contained atmosphere.

In the past, experimenters have painted the inside surface of the steel with protective coatings. The object was to prevent condensation from coming in contact with the metal. In this way, it was hoped to eliminate the dependency upon expensive insulation. Surface preparation was costly and had to be done expertly to have any chance of success. With use, small ruptures in the coating were commonplace allowing the elements

of corrosion to enter. This procedure has not had a good long-range history.

Good maintenance is paramount in the fight against corrosion. The integrity of the insulation must be frequently inspected and kept water tight. Many precipitators operate under negative pressure and the inleakage of air can be disastrous. Inleakage around door seals, access ports, and cracks in the steel must be sealed as soon as discovered.

Corrosion in the paper mill atmosphere is commonplace, and describing the problems of precipitator installations does not mean that they are misapplied. Properly designed and maintained, a precipitator will give many years of dependable service. The original steel shell designs are 9 years old and going strong.

REFERENCES

1. J. P. Gooch, "Low Temperature Corrosion by Sulphuric Acid in Power Plant Systems." Paper presented by Southern Research Institute at the Electrostatic Precipitator Symposium. February, 1971.
2. J. R. Rylands and J. R. Jenkinson. "The Acid Dew Point." *Journal of Institute of Fuel*. June, 1954. Page 299.
3. L. Stockman and A. Tansen, *Svensk Papperstidn.* 62, 907 to 914 (1959) (original in Swedish with English and German summaries); through *Abstr. Bull. Inst. Paper Chem.* 30, 1164 to 1165 (1960). *The Paper Industry*. June, 1960. Page 215.

Fig. 1

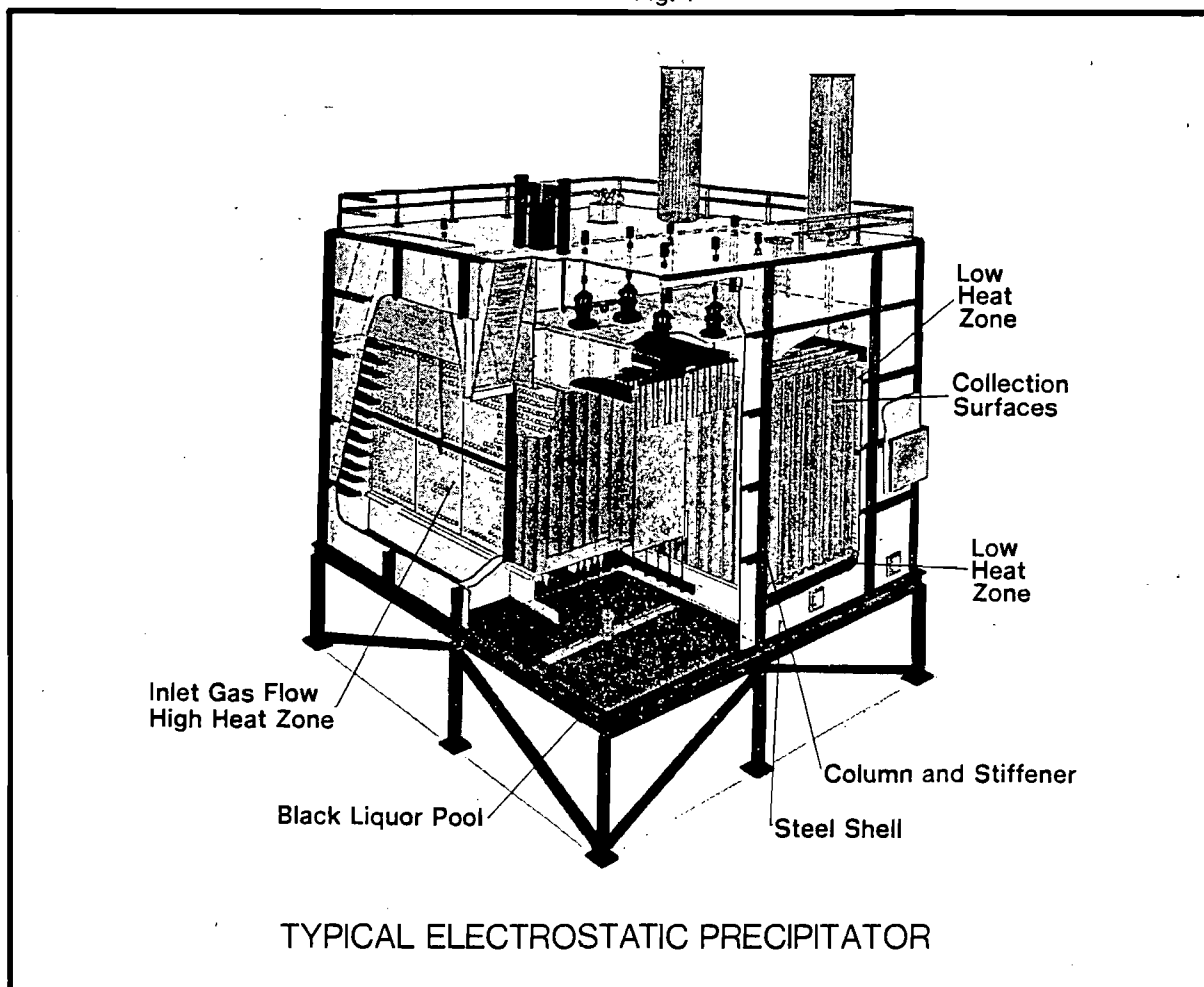

AIR CLEANING SYSTEMS

PARTIAL LISTING

SALT CAKE PRECIPITATOR INSTALLATIONS

Air Cleaning Systems Group
P.O. Box 1318, 3700 Koppers St.
Baltimore, Maryland 21203
Telephone 301 368-7222

<u>YEAR & S. O. NUMBER</u>	<u>CUSTOMER PLANT AND LOCATION</u>	<u>OPERATING DATA</u>
1971		
370568	WESTVACO CORPORATION Charleston, South Carolina	278,000 ACFM @ 350°, 99.3% guaranteed efficiency, wet bottom, steel shell
370570	LINCOLN PULP & PAPER CO. Lincoln, Maine	121,500 ACFM @ 436°, 99.0% guaranteed efficiency, dry bottom, steel shell, CONTROLLED ODOR BOILER
370578	SOUTHWEST FOREST INDUSTRIES Panama City, Florida	300,000 ACFM @ 325°, 99.6% guaranteed efficiency, wet bottom, steel shell
370593	FEDERAL PAPER BOARD CO., INC. Reigelwood, North Carolina	212,000 ACFM @ 375°, 99.7% guaranteed efficiency, wet bottom, steel shell
370597	CHAMPION PAPER Pasadena, Texas (2 units)	216,000 ACFM each @ 400°, 99.75% guaranteed efficiency, wet bottom, filled tile shell
370600	OWENS-ILLINOIS Tomahawk, Wisconsin	83,000 ACFM @ 450°, 99.5% guaranteed efficiency, dry bottom, steel shell
370601	OWENS-ILLINOIS Valdosta, Georgia	128,000 ACFM @ 320°, 99.6% guaranteed efficiency, wet bottom, steel shell
370602	OWENS-ILLINOIS Valdosta, Georgia	128,000 ACFM @ 320°, 99.6% guaranteed efficiency, wet bottom, steel shell
1972		
370607	TEMPLE, INC. Silsbee, Texas	220,000 ACFM @ 330°, secondary collection, 96.9% guaranteed efficiency, wet bottom, steel shell
370608	TEMPLE, INC. Silsbee, Texas	250,000 ACFM @ 300°, secondary collector, 90.0% guaranteed efficiency, wet bottom, steel shell
370610	BOWATERS CAROLINA CORP. Catawba, South Carolina	200,000 ACFM @ 310°, 99.6% guaranteed efficiency, wet bottom, steel shell
370623	CONTINENTAL FOREST INDUSTRIES Augusta, Georgia	220,000 ACFM @ 325°, 99.5% guaranteed efficiency, wet bottom, steel shell
370626	INTERNATIONAL PAPER CO. Georgetown, South Carolina	345,000 ACFM @ 325°, 99.5% guaranteed efficiency, wet bottom, steel shell
370628	UNION CAMP CORP. Savannah, Georgia	502,000 ACFM @ 350°, 99.65% guaranteed efficiency, wet bottom, steel shell
370635	CHAMPION INTERNATIONAL Pasadena, Texas	281,000 ACFM @ 315°, 99.8% guaranteed efficiency, wet bottom, steel shell
370637	CONTINENTAL FOREST INDUSTRIES Port Wentworth, Georgia	240,000 ACFM @ 325°, 99.5% guaranteed efficiency, wet bottom, steel shell

**ENVIRONMENTAL
ELEMENTS
CORPORATION**
Subsidiary of Koppers Company, Inc.

<u>YEAR & S. O. NUMBER</u>	<u>CUSTOMER PLANT AND LOCATION</u>	<u>OPERATING DATA</u>
370639	INTERNATIONAL PAPER Gardiner, Oregon	275,000 ACFM @ 395°, 99.5% guaranteed efficiency, dry bottom, steel shell
370640	SCOTT PAPER COMPANY Mobile, Alabama	140,000 ACFM @ 250°, 99.7% guaranteed efficiency, wet bottom, steel shell
370663	SOUTH CAROLINA INDUSTRIES Florence, South Carolina	375,000 ACFM @ 450°, 99.7% guaranteed efficiency, wet bottom, steel shell, CONTROLLED ODOR BOILER
1973 370676	P.H. GLATFELTER CO. Spring Grove, Pennsylvania	230,000 ACFM @ 300°, 99.5% guaranteed efficiency, wet bottom, steel shell
370678	ARKANSAS KRAFT CORP. Morrilton, Arkansas	260,000 ACFM @ 430°, 99.5% guaranteed efficiency, wet bottom, steel shell, CONTROLLED ODOR BOILER
370680	INTERNATIONAL PAPER CO. Springhill, Louisiana	185,000 ACFM @ 325°, 99.6% guaranteed efficiency, wet bottom, steel shell
370681	INTERNATIONAL PAPER CO. Springhill, L.A.	250,000 ACFM @ 325°, 99.6% guaranteed efficiency, wet bottom, steel shell
370682	INTERNATIONAL PAPER CO. Pine Bluff, Arkansas	319,000 ACFM @ 325°, 99.6% guaranteed efficiency, wet bottom, steel shell
370683	INTERNATIONAL PAPER CO. Natchez, Mississippi	315,000 ACFM @ 325°, 99.6% guaranteed efficiency, wet bottom, steel shell
370692	CONTAINER CORPORATION Fernandina Beach, Florida	240,000 ACFM @ 240°, 99.6% guaranteed efficiency, wet bottom, steel shell
370693	CONTAINER CORPORATION Fernandina Beach, Florida	420,000 ACFM @ 400°, 99.6% guaranteed efficiency, dry bottom, steel shell, CONTROLLED ODOR BOILER
370694	SCOTT PAPER COMPANY Mobile, Alabama	160,000 ACFM @ 300°, 99.6% guaranteed efficiency, wet bottom, steel shell
370697	ST. REGIS PAPER CO. Pensacola, Florida	335,000 ACFM @ 370°, 99.63% guaranteed efficiency, dry bottom, steel shell, CONTROLLED ODOR BOILER
370709	PINEVILLE KRAFT CORP. Pineville, L.A.	300,000 ACFM @ 290°, 99.6% guaranteed efficiency, wet bottom, steel shell
370710	GULF STATES PAPER Demopolis, Alabama	250,000 ACFM @ 350°, 99.5% guaranteed efficiency, wet bottom, steel shell
1974 370717	FEDERAL PAPERBOARD CO. Riegelwood, North Carolina	260,000 ACFM @ 275°, 99.525% guaranteed efficiency, wet bottom, steel shell
370718	CONTINENTAL FOREST INDUSTRIES Hodge, Louisiana	162,500 ACFM @ 300°, 99.5% guaranteed efficiency, wet bottom, steel shell
370722	SCOTT PAPER COMPANY Skowhegan, Maine	450,000 ACFM @ 400°, 99.8% guaranteed efficiency, dry bottom, steel shell, CONTROLLED ODOR BOILER
370725	CONTAINER CORPORATION Brewton, Alabama	200,000 ACFM @ 270°, 99.5% guaranteed efficiency, wet bottom, steel shell
370726	CONTAINER CORPORATION Cali, Columbia	118,000 ACFM @ 325°, 99.5% guaranteed efficiency, wet bottom, steel shell
370735	WESTERN KRAFT COMPANY Hawesville, Kentucky	125,000 ACFM @ 350°, 99.5% guaranteed efficiency, wet bottom, steel shell
370741	HUDSON PULP & PAPER CO. Palatka, Florida	540,200 ACFM @ 385°, 99.75% guaranteed efficiency, dry bottom, steel shell, CONTROLLED ODOR BOILER
370747	GEORGIA PACIFIC CORP. Port Hudson, Louisiana	455,000 ACFM @ 325°, 99.5% guaranteed efficiency, wet bottom, steel shell

**YEAR &
S. O. NUMBER** **CUSTOMER
PLANT AND LOCATION**

OPERATING DATA

370750	CONSOLIDATED PAPERS Wisconsin Rapids, Wisconsin	175,000 ACFM @ 310°, 99.5% guaranteed efficiency, wet bottom, steel shell
370751	OLINKRAFT, INC. West Monroe, Louisiana	315,000 ACFM @ 410°, 99.7% guaranteed efficiency, wet bottom, steel shell, CONTROLLED ODOR BOILER
1975		
370758	POTLATCH CORPORATION McGehee, Arkansas	225,000 ACFM @ 410°, 99.7% guaranteed efficiency, dry bottom, steel shell, CONTROLLED ODOR BOILER
370760	KIMBERLY CLARK CORP. UNIT 2 Coosa Pines, Alabama	100,000 ACFM @ 340°, 99.6% guaranteed efficiency, wet bottom, steel shell
370761	KIMBERLY CLARK CORP. UNIT 3 Coosa Pines, Alabama	337,000 ACFM @ 426°, 99.7% guaranteed efficiency, dry bottom, steel shell, CONTROLLED ODOR BOILER
370764	UNION-CAMP CORPORATION Franklin, Virginia	500,000 ACFM @ 470°, 99.8% guaranteed efficiency, dry bottom, steel shell, CONTROLLED ODOR BOILER
370771	OLINKRAFT, INC. West Monroe, Louisiana	185,000 ACFM @ 325°, Secondary Collector, 94% guaranteed efficiency, wet bottom, steel shell
370772	THE MEAD CORPORATION Chillicothe, Ohio	399,000 ACFM @ 420°, 99.7% guaranteed efficiency, dry bottom, steel shell, CONTROLLED ODOR BOILER
370783	INTERNATIONAL PAPER Texarkana, Texas	440,000 ACFM @ 325°, 99.6% guaranteed efficiency, wet bottom, steel shell
370785	WESTERN KRAFT Campti, Louisiana	173,000 ACFM @ 415°, 99.65% guaranteed efficiency, wet bottom, steel shell, CONTROLLED ODOR BOILER
1976		
370801	INTERNATIONAL PAPER CO. Bastrop, Louisiana	125,000 ACFM @ 315°, 97.33% guaranteed efficiency, wet bottom, steel shell
370804	CONTAINER CORPORATION Cali, Colombia	81,250 ACFM @ 325°, 99.55% guaranteed efficiency, wet bottom, steel shell
370808	GEORGIA PACIFIC CORP. Crossett, Arkansas	450,000 ACFM @ 325°, 99.5% guaranteed efficiency, wet bottom, steel shell
370809	CONTAINER CORPORATION Fernandina Beach, Florida	500,000 ACFM @ 400°, 99.75% guaranteed efficiency, dry bottom, steel shell, CONTROLLED ODOR BOILER
1977		
370833	NIGERIAL PAPER MILL, LTD. Lagos, Nigeria	94,350 ACFM @ 325°, 99% guaranteed efficiency, wet bottom, steel shell
370834	CONTINENTAL FOREST INDUS. Port Wentworth, Ga.	535,000 ACFM @ 410°, 99.8125% guaranteed efficiency, wet bottom, steel shell, 1200 T/D B&W
370846	TEMPLE EASTEX, INC. Silsbee, Texas	250,000 ACFM @ 425°, 98% guaranteed efficiency (99.75% overall guarantee) wet bottom, steel shell, boiler converted to low odor
370851	WESTVACO Charleston, S.C.	400,000 ACFM @ 285°, 99% guaranteed efficiency, wet bottom, steel shell, #6 #7 & #8 boilers @ 250 T/D each
370858	CONTINENTAL FOREST INDUS. Augusta, Ga.	220,000 ACFM @ 325°, 99.5% guaranteed efficiency, wet bottom steel shell 550 T/D B & W

YEAR & S. O. NUMBER **CUSTOMER PLANT AND LOCATION**

OPERATING DATA

1978

370863 **MEAD CORPORATION**
Escanaba, Michigan 400,000 ACFM @ 465°, 99.7% guaranteed efficiency, dry bottom, steel shell, 500 T/D **CONTROLLED ODOR BOILER**

370868 **SCOTT PAPER COMPANY**
Mobile, Alabama 180,000 ACFM @ 300°, 99.6% guaranteed efficiency, wet bottom, steel shell, 500 T/D boiler.

370875 **INTERNATIONAL PAPER CO.**
Gardiner, Oregon 325,000 ACFM @ 425°, additional field 99.6% overall guaranteed efficiency, dry bottom, steel shell, two 420 T/D **CONTROLLED ODOR BOILER**

370879 **CONTINENTAL FOREST IND.**
Hopewell, Virginia 432,000 ACFM @ 425°, 99.7% guaranteed efficiency, wet bottom, steel shell, **CONTROLLED ODOR BOILER.**

370884 **CHAMPION PAPER, INC.**
Canton, North Carolina 360,000 ACFM @ 325°, 99.5% guaranteed efficiency, wet bottom, steel shell, 900 T/D Boiler

370891 **S. D. WARREN**
Muskegon, Michigan 145,000 ACFM @ 300°, 99.5% guaranteed efficiency, wet bottom, steel shell.

370896 **OWENS ILLINOIS**
Orange, Texas 430,000 @ 300°, secondary collector 94.0% guaranteed efficiency, wet bottom, steel shell, two 550 T/D B & W boilers.

1979

420016 **TEMPLE EASTEX**
Silsbee, Texas 220,000 ACFM @ 330°F, Primary Collector, 99.6% guaranteed overall efficiency, wet bottom, steel shell.

420025 **WESTYACO**
Wickliffe, Kentucky 360,000 ACFM @ 320°F, 99.5% guaranteed efficiency, wet bottom, steel shell, 3,200,000 lbs. Bls/Day.

420026 **HAMMERMILL PAPER CO.**
Selma, Alabama 380,000 ACFM @ 410°F, 99.65% guaranteed efficiency, wet bottom, steel shell, 900 TPD **CONTROLLED ODOR BOILER.**

420027 **INTERNATIONAL PAPER CO.**
Mansfield, Louisiana Two precipitators each 370,000 ACFM @ 412°F, 99.7% guaranteed efficiency, wet bottom, steel shell, two 900 TPD boilers **CONTROLLED ODOR BOILERS.**

1980

420034 **ALABAMA KRAFT CORPORATION**
Phenix City, Alabama 360,000 ACFM @ 340°F, 99.66% guaranteed efficiency, wet bottom, steel shell, conventional boiler

420041 **GEORGIA PACIFIC CORP.**
Crossett, Arkansas 730,000 ACFM @ 430°F, 99.8% guaranteed efficiency, wet bottom, steel shell, 1500 TPD **CONTROLLED ODOR BOILER**

420051 **MACMILLAN BLOEDEL, INC.**
Pine Hill, Alabama 461,351 ACFM @ 414°F, 99.8% guaranteed efficiency, wet bottom, steel shell, 1500 TPD **CONTROLLED ODOR BOILER**

420062 **UNION CAMP CORPORATION**
Montgomery, Alabama 320,000 ACFM @ 350°F, 99.7% guaranteed efficiency, wet bottom, steel shell, 750 TPD conventional boiler

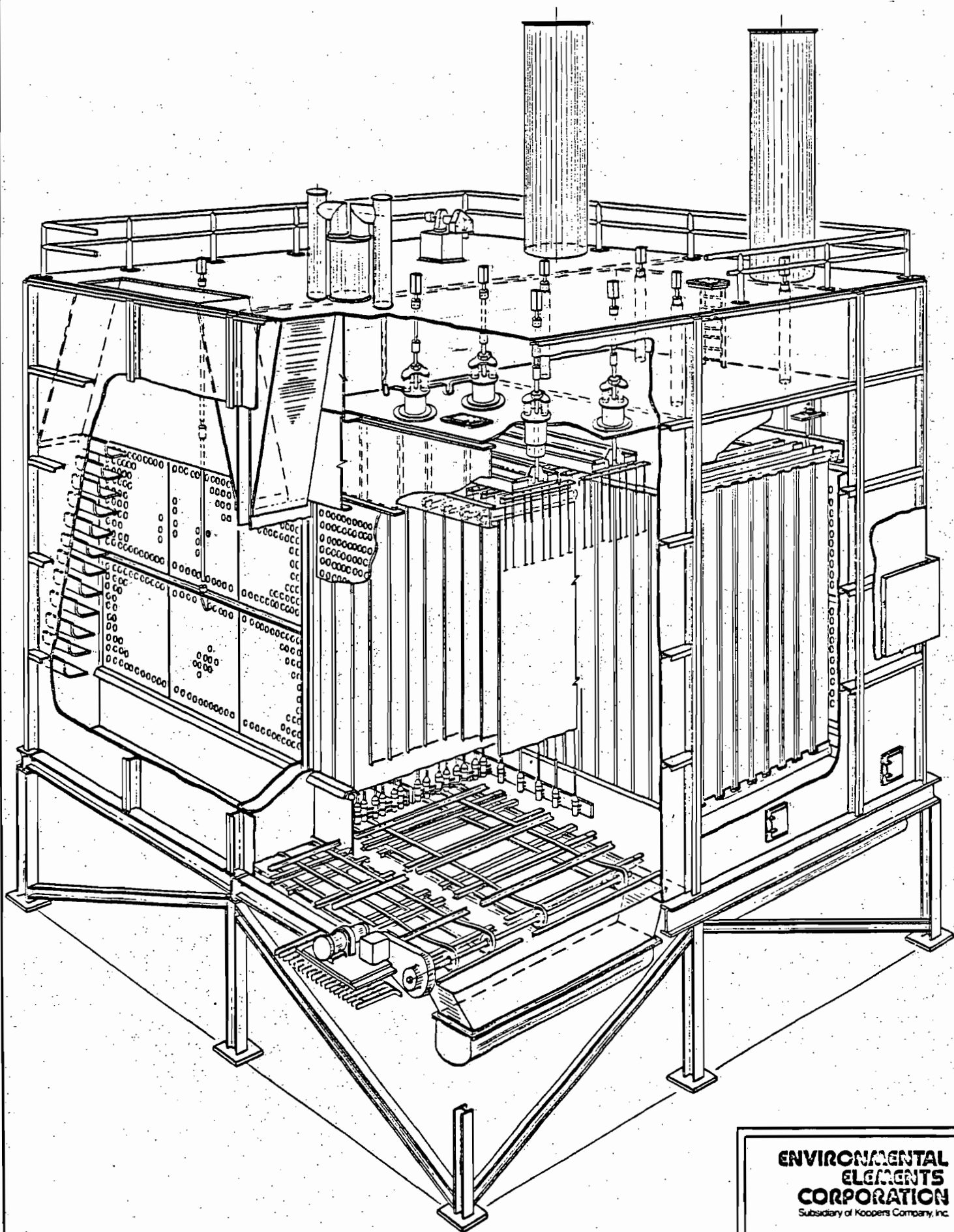

**ENVIRONMENTAL
ELEMENTS
CORPORATION**
Subsidiary of Koopers Company, Inc.

Dwg. No. 1039

E.W.C. 1-76

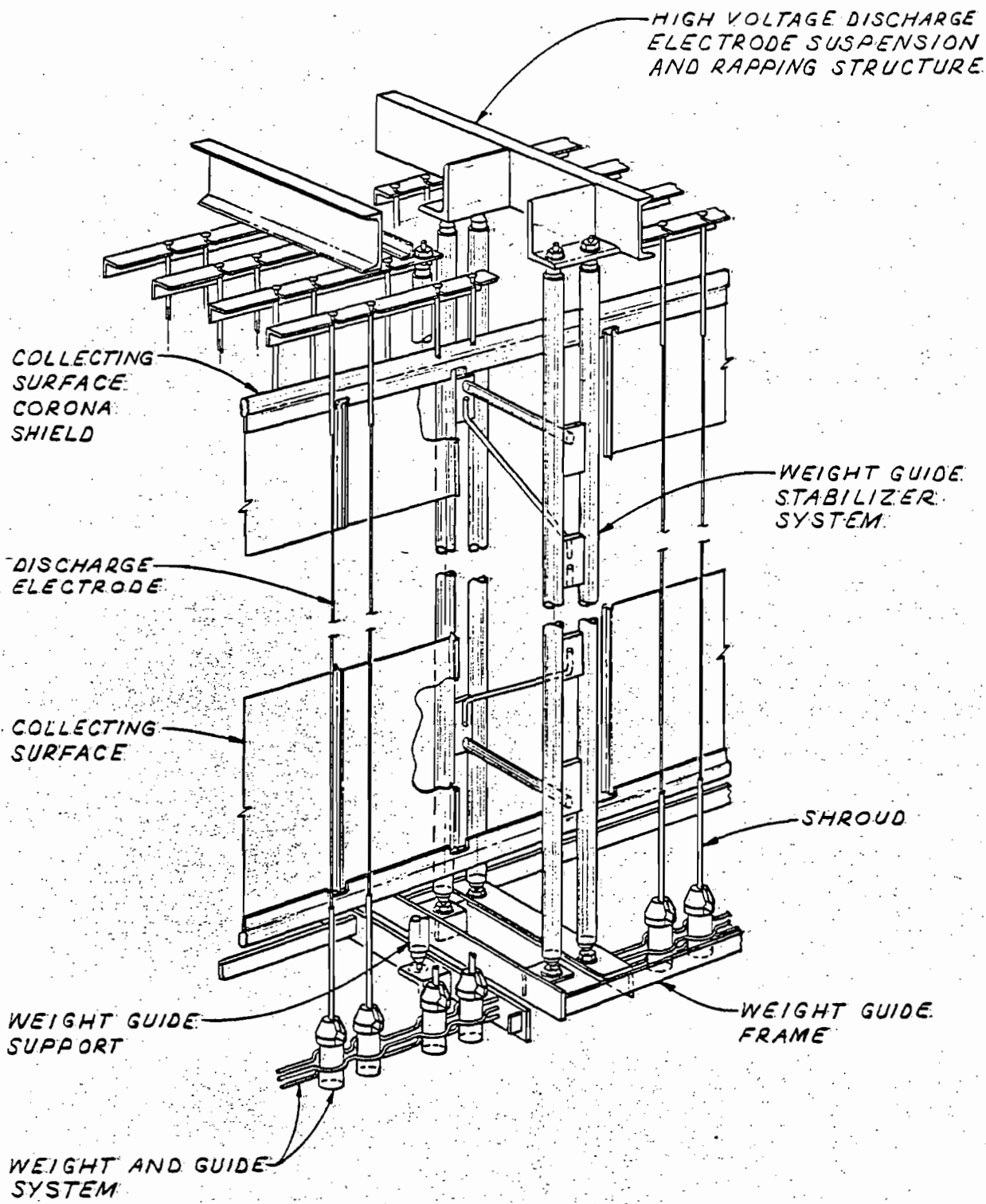

**ENVIRONMENTAL
ELEMENTS
CORPORATION**
Subsidiary of Koppers Company, Inc.

DISCHARGE ELECTRODE
SUPPORT AND STABILIZER
SYSTEM

DWG. NO. 1037

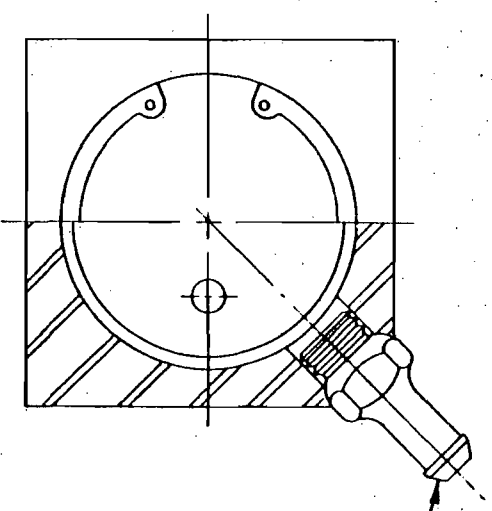
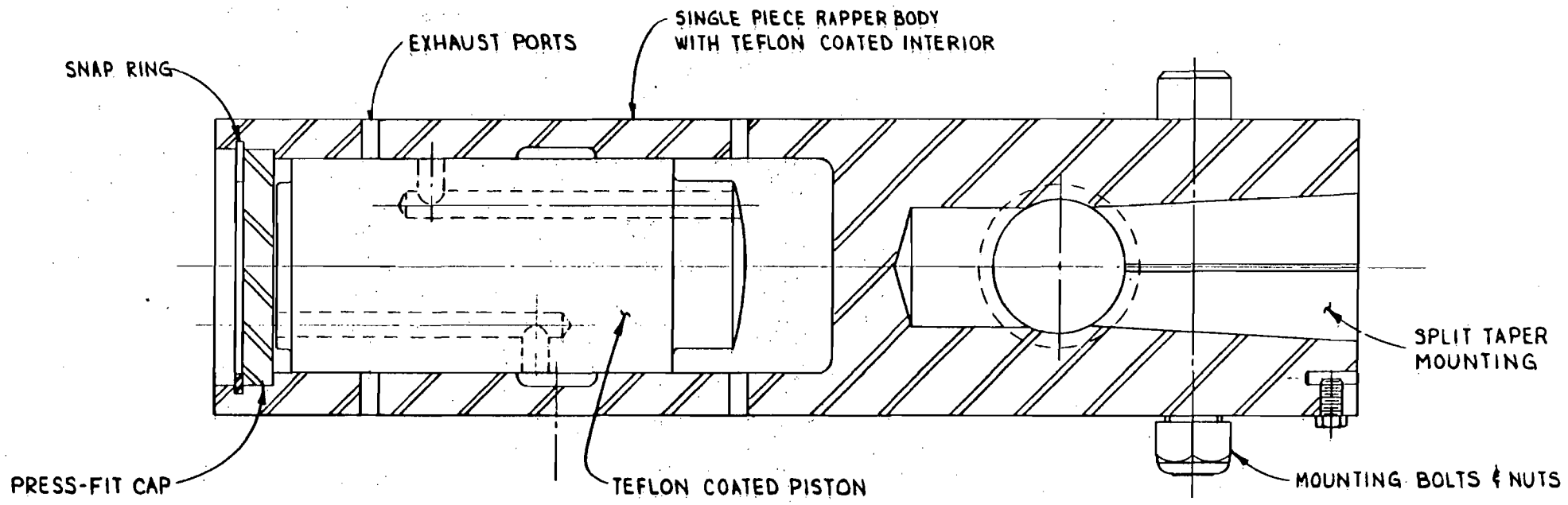

AIR INLET FITTING WITH RESTRICTION

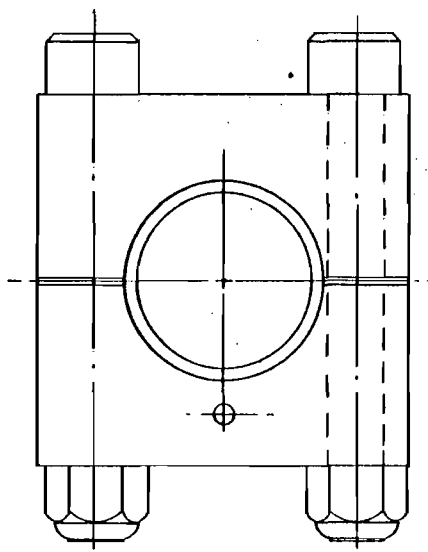

**ENVIRONMENTAL
ELEMENTS
CORPORATION**
Subsidiary of Koppers Company, Inc.

PNEUMATIC
RECIPROCATING RAPPER

DWG. N^o 1030

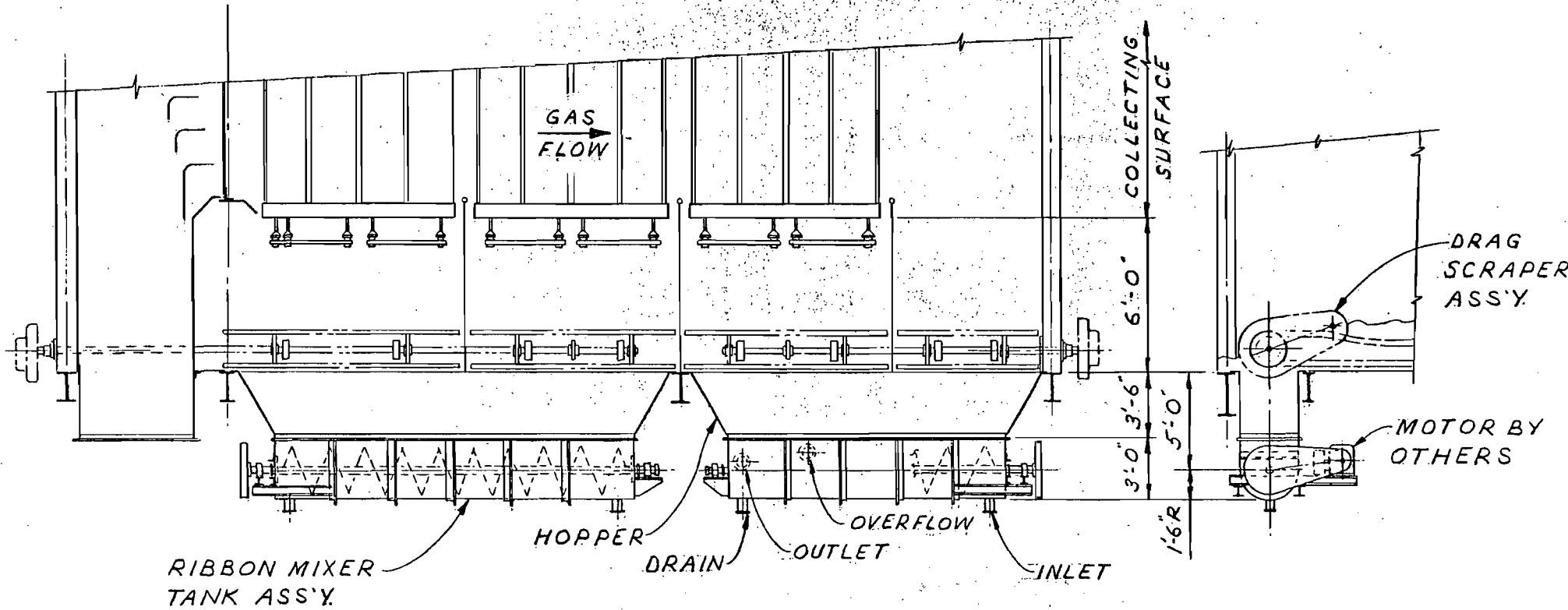

**ENVIRONMENTAL
 ELEMENTS
 CORPORATION**
 Subsidiary of Koppers Company, Inc.

TYPICAL
 RIBBON MIXER TANK
 ARRANGEMENT
 DWG. NO. 1027

PRECIPITATOR
ROOF PLATE

GIRDER

COLLECTING
SURFACE
RAPPER ROD

COLLECTING
SURFACE SUPPORT
SYSTEM

FLOATING
CHANNEL

COLLECTING
SURFACE

SPACER BAR

TIE BAR

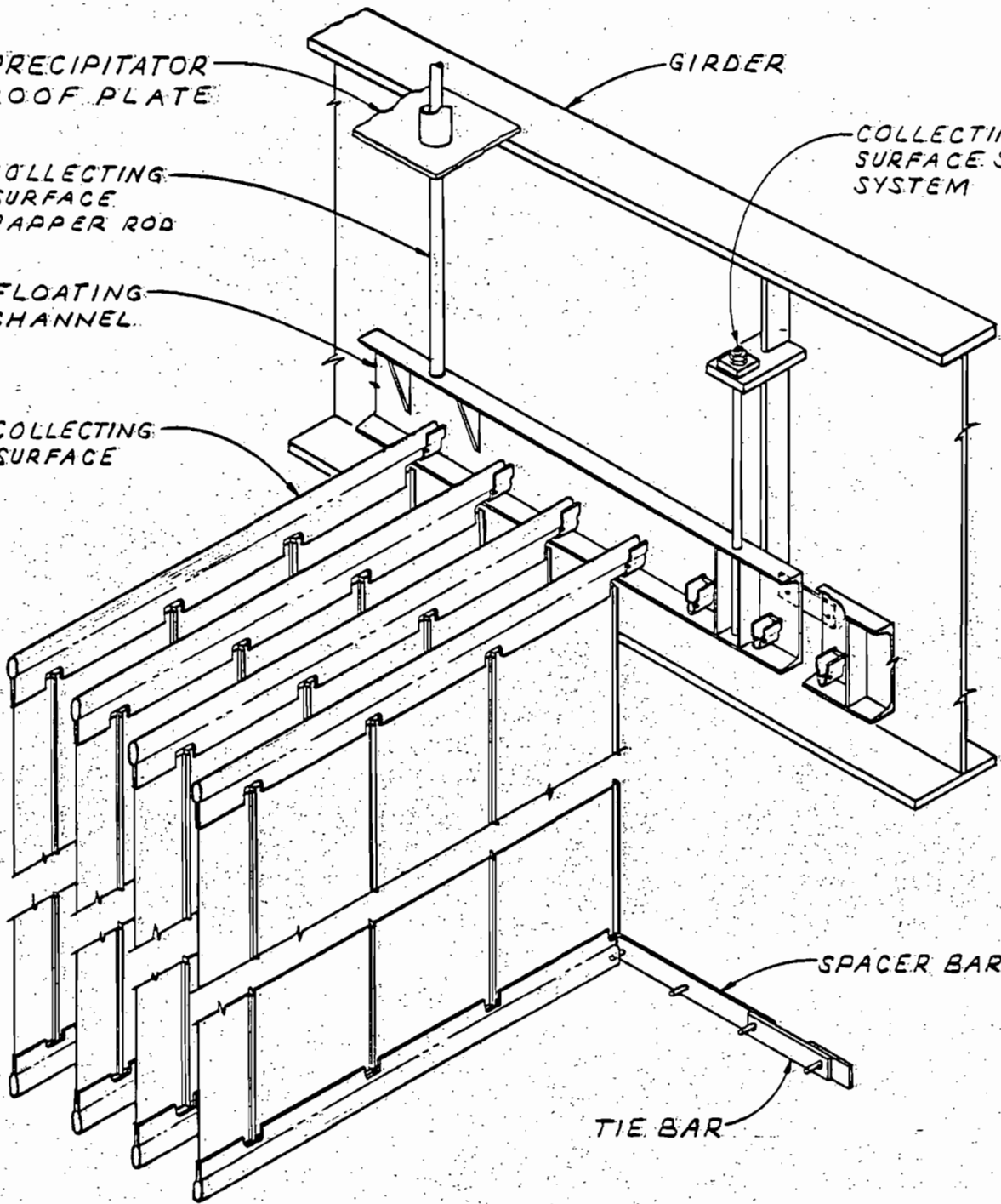

**ENVIRONMENTAL
ELEMENTS
CORPORATION**
Subsidiary of Koppers Company, Inc.

SUSPENSION ARRANGEMENT
ROLL-FORMED
COLLECTING SURFACE

DWG. NO. 1026

BUS DUCT

TRANSFORMER
RECTIFIER

DISCHARGE
ELECTRODE
RAPPER

PENTHOUSE
ROOF PLATE

SUSPENSION
INSULATOR

ROOF PLATE

DISCHARGE ELECTRODE
SUSPENSION AND
RAPPING STRUCTURE

**ENVIRONMENTAL
ELEMENTS
CORPORATION**
Subsidiary of Koppers Company, Inc.

HIGH VOLTAGE SYSTEM
PENTHOUSE ARR'G'T.

DWG. NO. 1024A

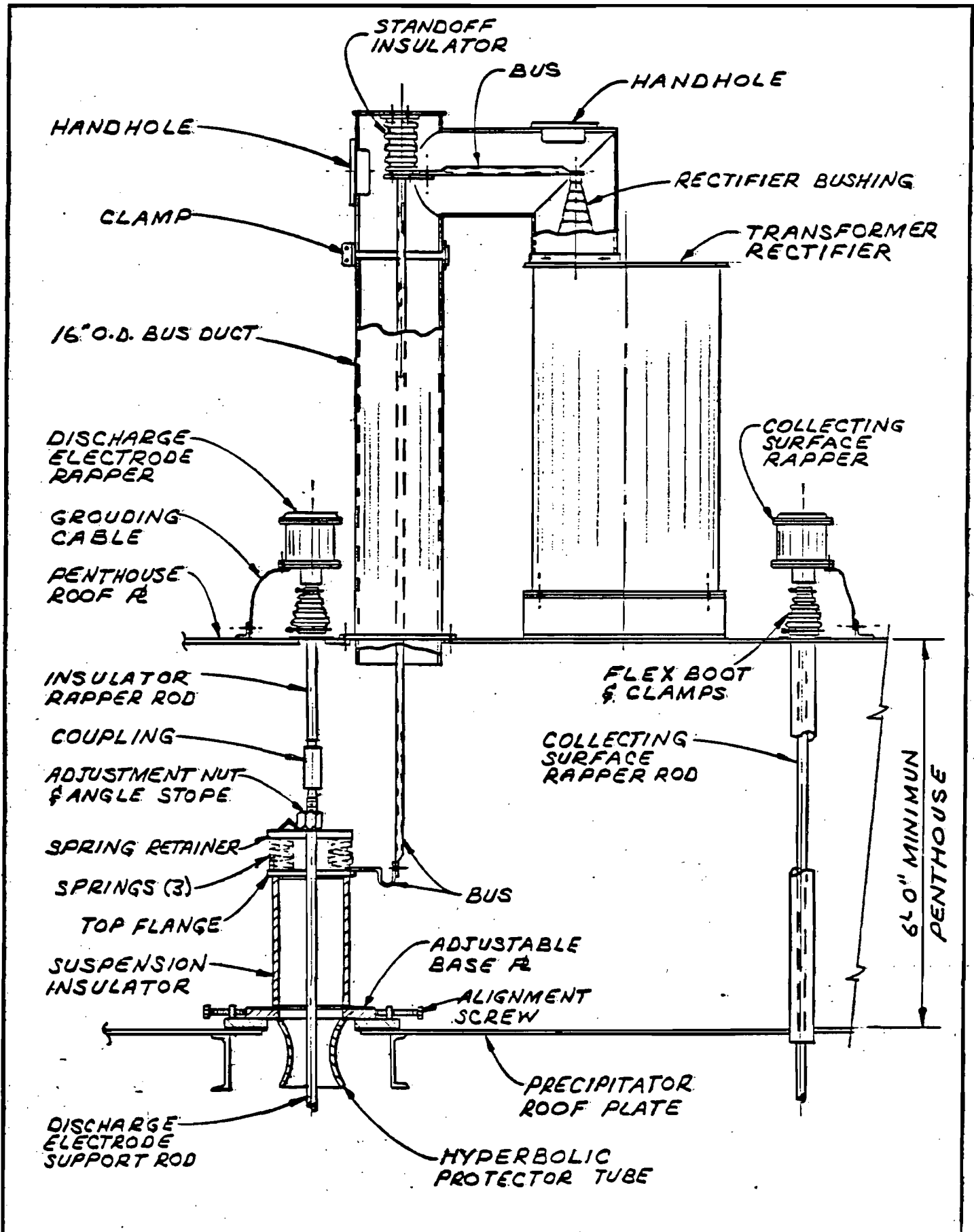

STANDOFF INSULATOR
 BUS
 HANDHOLE
 HANDHOLE
 CLAMP
 RECTIFIER BUSHING
 TRANSFORMER RECTIFIER
 16" O.D. BUS DUCT
 DISCHARGE ELECTRODE RAPPER
 GROUNDING CABLE
 PENTHOUSE ROOF R
 COLLECTING SURFACE RAPPER
 INSULATOR RAPPER ROD
 FLEX BOOT & CLAMPS
 COUPLING
 COLLECTING SURFACE RAPPER ROD
 ADJUSTMENT NUT & ANGLE STOP
 64" MINIMUM PENTHOUSE
 SPRING RETAINER
 SPRINGS (3)
 BUS
 TOP FLANGE
 SUSPENSION INSULATOR
 ADJUSTABLE BASE R
 ALIGNMENT SCREW
 PRECIPITATOR ROOF PLATE
 DISCHARGE ELECTRODE SUPPORT ROD
 HYPERBOLIC PROTECTOR TUBE

<p>ENVIRONMENTAL ELEMENTS CORPORATION <small>Subsidiary of Koppers Company, Inc.</small></p>	<p>HIGH VOLTAGE SYSTEM PENTHOUSE ARR'G'T. DWG. NO 1024</p>
--	---

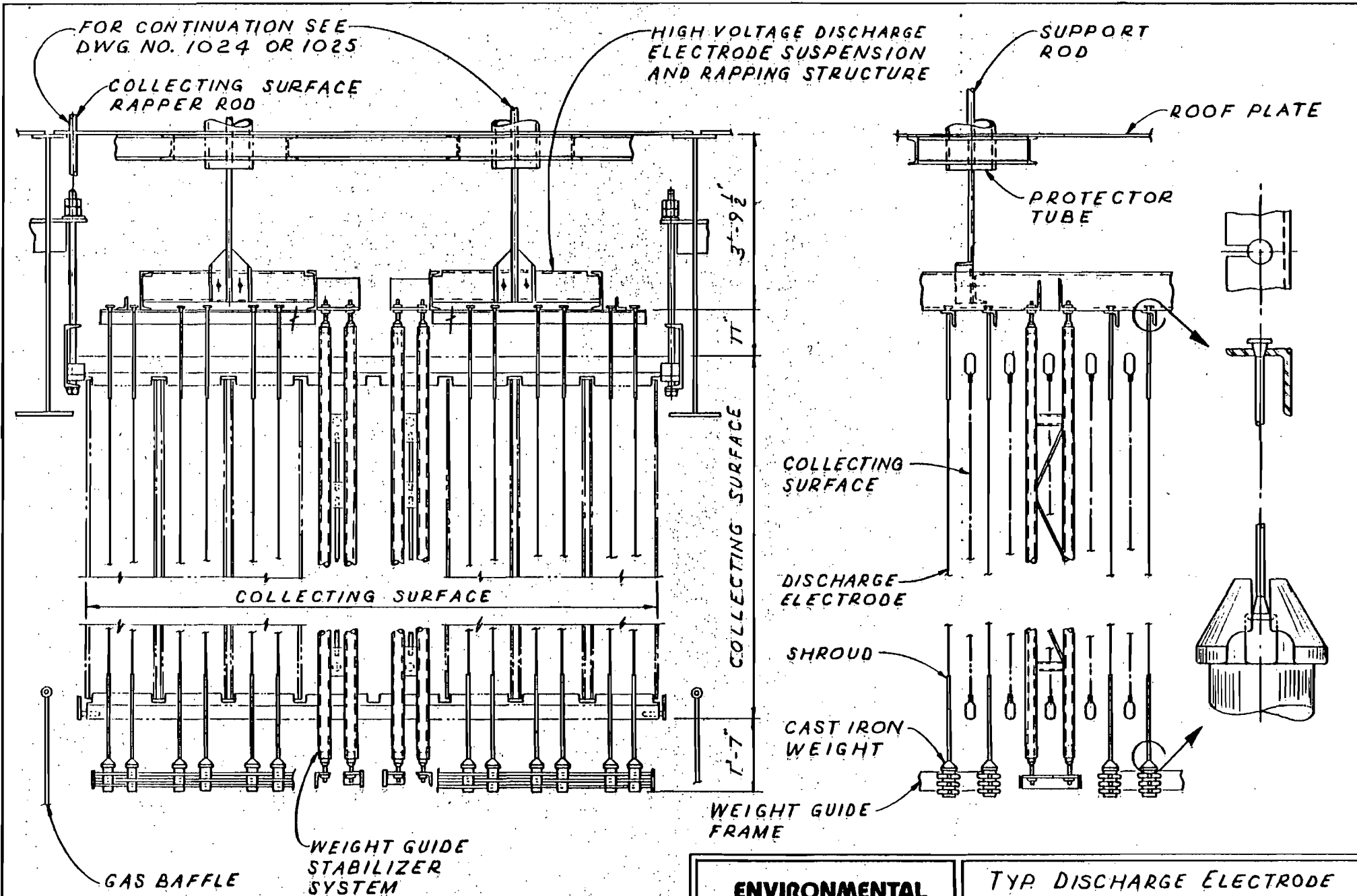

**ENVIRONMENTAL
ELEMENTS
CORPORATION**
Subsidiary of Koppers Company, Inc.

TYP. DISCHARGE ELECTRODE
SUPPORT ARRANGEMENT—
DOUBLE ELECTRICAL FIELD
DWG. NO. 1023

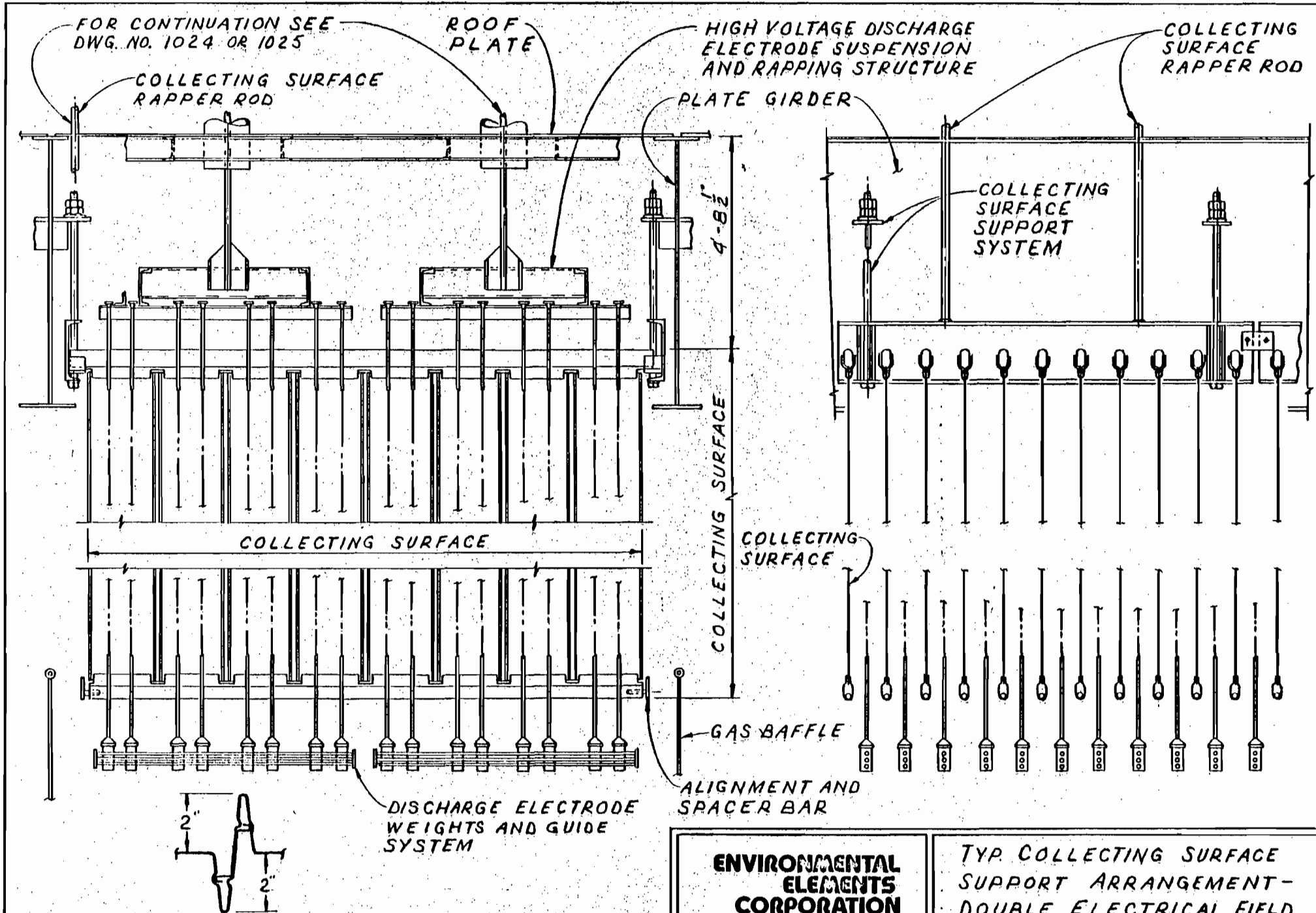

FOR CONTINUATION SEE
DWG. NO. 1024 OR 1025

COLLECTING SURFACE
RAPPER ROD

ROOF
PLATE

HIGH VOLTAGE DISCHARGE
ELECTRODE SUSPENSION
AND RAPPING STRUCTURE

COLLECTING
SURFACE
RAPPER ROD

PLATE GIRDER

COLLECTING
SURFACE
SUPPORT
SYSTEM

COLLECTING SURFACE

COLLECTING
SURFACE

COLLECTING SURFACE

GAS BAFFLE

ALIGNMENT AND
SPACER BAR

DISCHARGE ELECTRODE
WEIGHTS AND GUIDE
SYSTEM

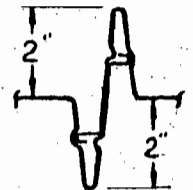

SECTION THRU PLATE

**ENVIRONMENTAL
ELEMENTS
CORPORATION**
Subsidiary of Koppers Company, Inc.

TYP. COLLECTING SURFACE
SUPPORT ARRANGEMENT -
DOUBLE ELECTRICAL FIELD
DWG. NO. 1022

9. An application fee of \$20, unless exempted by Section 17-4.05(3), F.A.C. The check should be made payable to the Department of Environmental Regulation.

10. With an application for operation permit, attach a Certificate of Completion of Construction indicating that the source was constructed as shown in the construction permit.

SECTION VI: BEST AVAILABLE CONTROL TECHNOLOGY

Smelt Dissolving Tanks

A. Are standards of performance for new stationary sources pursuant to 40 C.F.R. Part 60 applicable to the source?
 Yes [] No

Contaminant	Rate or Concentration
<u>Particulate Matter</u>	<u>0.2 lb/ton black liquor solids (dry weight)</u>
<u>Total Reduced Sulfur</u>	<u>0.0168 lb/ton black liquor solids (dry weight)</u>

B. Has EPA declared the best available control technology for this class of sources (If yes, attach copy) Yes [] No

Contaminant	Rate or Concentration
<u>Particulate Matter</u>	<u>0.1 g/kg (0.2 lb/ton) black liquor solids</u>
<u>Total Reduced Sulfur</u>	<u>0.0084 g/kg (0.0168 lb/ton) black liquor solids</u>

C. What emission levels do you propose as best available control technology?

Contaminant	Rate or Concentration
<u>Particulate Matter</u>	<u>0.2 lb/ton black liquor solids (dry weight)</u>
<u>Total Reduced Sulfur</u>	<u>0.0168 lb/ton black liquor solids (dry weight)</u>
<u>Sulfur Dioxide</u>	<u>Proper process control and wet scrubber</u>

D. Describe the existing control and treatment technology (if any).

- 1. Control Device/System: See Item E
- 2. Operating Principles:
- 3. Efficiency: *
- 4. Capital Costs:
- 5. Useful Life:
- 6. Operating Costs:
- 7. Energy:
- 8. Maintenance Cost:
- 9. Emissions:

Contaminant	Rate or Concentration

*Explain method of determining D 3 above.

10. Stack Parameters

- a. Height: _____ ft.
- b. Diameter: _____ ft.
- c. Flow Rate: _____ ACFM
- d. Temperature: _____ °F
- e. Velocity: _____ FPS

E. Describe the control and treatment technology available (As many types as applicable, use additional pages if necessary).

1. Particulate Matter/TRS

- a. Control Device: Mist Eliminator Pad
- b. Operating Principles: Fine wire mesh screen collects condensed gases, screen is backflushed with water sprays.
- c. Efficiency*: 80 percent (literature)
- d. Capital Cost: \$100,000 each
- e. Useful Life: 20 years
- f. Operating Cost: \$50,000/yr/scrubber
- g. Energy*: 50 kw
- h. Maintenance Cost: \$15,000/yr/scrubber
- i. Availability of construction materials and process chemicals:
Good.
- j. Applicability to manufacturing processes:
- k. Ability to construct with control device, install in available space, and operate within proposed levels:
Provides relatively low collection efficiency.

2. Particulate Matter/TRS

- a. Control Device: Venturi Scrubber
- b. Operating Principles: Exhaust gas stream is passed through throat or orifice where gas velocities are very high. Scrubbing liquid is introduced at throat, causing disposal and impaction and interruption of particulate matter. Cyclone or mist eliminator follows.
- c. Efficiency*: 95 percent
- d. Capital Cost: \$210,000 each
- e. Useful Life: 5 to 10 years
- f. Operating Cost: \$105,000/yr/scrubber
- g. Energy**: 100 kw
- h. Maintenance Costs: \$30,000/yr/scrubber
- i. Availability of construction materials and process chemicals:
- j. Applicability to manufacturing processes:
- k. Ability to construct with control device, install in available space, and operate within proposed levels:

*Explain method of determining efficiency.

**Energy to be reported in units of electrical power - KWH design rate.

3. Particulate Matter/TRS

- a. Control Device: Packed Tower
- b. Operating Principles: Tower media provides substrate for scrubbing liquid disposal and contact with gases. Contact removes particulate, TRS, and SO2 from gas stream.
- c. Efficiency*: Up to 95 percent
- d. Capital Cost: \$200,000 each
- e. Life: 5 to 10 years
- f. Operating Cost: \$100,000/yr/scrubber
- g. Energy: 100 kw
- h. Maintenance Cost: \$25,000/yr/scrubber

*Explain method of determining efficiency above.

- i. Availability of construction materials and process chemicals:
 - j. Applicability to manufacturing processes:
 - k. Ability to construct with control device, install in available space and operate within proposed levels:
4. Particulate Matter/TRS
- a. Control Device Packed tower with mist eliminator
 - b. Operating Principles: Combined features of individual controls as described above.
- | | | | |
|-----------------|-----------------------|----------------------|-----------------------|
| c. Efficiency*: | 92 to 98 (literature) | d. Capital Cost: | \$200,000 each |
| e. Life: | 5 to 10 years | f. Operating Cost: | \$100,000/yr/scrubber |
| g. Energy: | 100 kw | h. Maintenance Cost: | \$25,000/yr/scrubber |
- i. Availability of construction materials and process chemicals:
Good. Freshwater needed.
 - j. Applicability to manufacturing processes: Good
 - k. Ability to construct with control device, install in available space, and operate within proposed levels: Good

F. Describe the control technology selected:

- 1. Control Device: Venturi Scrubber
 - 2. Efficiency*:
 95 percent (literature) | - 3. Capital Cost:
 \$210,000 each |
 - 4. Life:
 5 to 10 years | - 5. Operating Cost:
 \$105,000/yr/scrubber |
 - 6. Energy:
 100 kw. | - 7. Maintenance Cost:
 \$30,000/yr/scrubber |
 - 8. Manufacturer: Flex-kleen, or equivalent
 - 9. Other locations where employed on similar processes: See Item F.10.
- a.
 - (1) Company:
 - (2) Mailing Address:
 - (3) City:
 - (4) State:
 - (5) Environmental Manager:
 - (6) Telephone No.:

*Explain method of determining efficiency above.

- (7) Emissions*:

Contaminant:	Rate or Concentration

- (8) Process Rate*:

b.

- (1) Company:
- (2) Mailing Address:
- (3) City:
- (4) State:

*Applicant must provide this information when available. Should this information not be available, applicant must state the reason(s) why.

Particulate Matter

Smelt Dissolving Tanks (SDT) vent gases are controlled in existing kraft pulp mills primarily by mist eliminator pads or low pressure wet scrubbers. Wet scrubbers exhibit higher removal efficiencies, about 95 percent, than do the mist eliminators which only achieve about 80 percent efficiency. Wet scrubbers can be of the venturi, packed tower, or wet cyclonic type. These scrubbers also display similar capital and annual operating costs due to similar pressure drop (6 to 8 in H₂O), and water usage requirements.

Three federal BACT determinations are known to have been made for new smelt dissolving tanks. In all three of these (copies attached) the NSPS of 0.1 g/kg of black liquor solids fed (0.2 lb/ton) was determined to be BACT for particulate matter. All three achieved these levels through water scrubbing--two with venturi scrubbers and one with a wet impingement scrubber.

Based upon this information, and historic operation at the G-P Palatka mill, two (2) low energy wet venturi scrubbers identical to two now in operation at G-P in Palatka are proposed as BACT for particulate matter emissions (one for each smelt tank vent). The attached test results of these scrubbers show large fluctuations in the measured emission rates. The NSPS level of 0.2 lb/ton black liquor solids has been met on roughly half of the tests. It is believed that by maintaining better control over the operation of the scrubber (e.g., by installing a pressure drop indicator) the NSPS level can be continuously achieved.

Total Reduced Sulfur

Smelt dissolving tank TRS emissions are generally a function of process conditions. The presence of reduced sulfur compounds in the smelt or water feed may cause TRS emissions. The prime control method is the use of water that is low in dissolved sulfides. Therefore, the use of such water in the particulate control device is deemed the best available control technology, and will reduce TRS emissions from the smelt dissolving tanks to 0.0168 lb/ton of black liquor solids (dry weight) fed to the smelt tanks, or less. Of three BACT determinations known to be made to date on smelt dissolving tanks, two included emission limits for TRS. Both determinations resulted in the NSPS level of 0.0084 g/kg (0.0168 lb/ton) of black liquor solids fed (one expressed as 5 ppm TRS), with both achieved by wet scrubbing.

SMELT DISSOLVING TANKS OPERATION
SUMMARY OF PARTICULATE TEST RESULTS

Date	Allowable Emission* (lb/hr)	Smelt Input (lb/hr)	Black Liquor Solids Input† (lb/hr dry)	Measured Emission	
				(lb/hr)	(lb/ton BLS)
9/28/77	30.24	65,319	155,521	7.9	0.10
9/30/77	27.76	54,178	128,995	6.0	0.09
	30.07	63,047	150,112	5.8	0.08
03/78	31.78	89,153	212,269	47.5	0.45
	31.55	85,196	202,848	44.2	0.44
	29.09	58,424	139,105	43.5	0.63
09/78	28.60	56,845	135,345	8.8	0.13
	30.22	65,090	154,976	76.0	0.98
	30.35	66,860	159,190	7.2	0.09
03/79	--	--	--	--	--
	30.40	67,551	160,836	32.0	0.40
	30.08	63,228	150,543	17.6	0.23
09/79	30.80	73,302	174,529	12.6	0.14
	29.99	62,055	147,750	22.2	0.30
	29.99	62,055	147,750	12.1	0.16
03/80	30.50	68,952	164,171	22.0	0.27
	30.55	69,662	165,862	25.1	0.30
	30.50	68,952	164,171	19.2	0.23
09/80	30.34	66,722	158,862	15.1	0.19
	30.53	69,377	165,183	11.5	0.14
	30.38	67,274	160,176	29.7	0.37

* Based on Florida Process Weight Regulation: $E = 17.31 P^{0.16}$
($P > 30$ tons/hr).

† Based on 1 lb BLS = 0.42 lb smelt (industry average).

REFERENCES

1. PEDCo Environmental Specialists, Inc. October 1978. Operation and Maintenance of Particulate Control Devices in Kraft Pulp Mill and Crushed Stone Industries. EPA-600/2-78-210.
2. U.S. Environmental Protection Agency. January 1978. Draft Guideline Document: Control of TRS Emissions from Existing Kraft Pulp Mills. EPA-450/2-78-003a.
3. PEDCo Environmental Specialists, Inc. May 1980. Compilation of BACT/LAER Determinations, Revised. EPA-450/2-08-070.

SECTION VII - PREVENTION OF SIGNIFICANT DETERIORATION

Items A - C: See No. 5 Combination Boiler Application

A. Company Monitored Data

1. _____ no sites _____ TSP _____ () SO2* _____ Wind spd/dir

Period of monitoring _____ / _____ / _____ to _____ / _____ / _____
month day year month day year

Other data recorded _____

Attach all data or statistical summaries to this application.

2. Instrumentation, Field and Laboratory

a) Was instrumentation EPA referenced or its equivalent? _____ Yes _____ No

b) Was instrumentation calibrated in accordance with Department procedures? _____ Yes _____ No _____ Unknown

B. Meteorological Data Used for Air Quality Modeling

1. _____ Year(s) of data from _____ / _____ / _____ to _____ / _____ / _____
month day year month day year

2. Surface data obtained from (location) _____

3. Upper air (mixing height) data obtained from (location) _____

4. Stability wind rose (STAR) data obtained from (location) _____

C. Computer Models Used

1. _____ Modified? If yes, attach description.

2. _____ Modified? If yes, attach description.

3. _____ Modified? If yes, attach description.

4. _____ Modified? If yes, attach description.

Attach copies of all final model runs showing input data, receptor locations, and principle output tables.

D. Applicants Maximum Allowable Emission Data

Pollutant:	Emission Rate:
TSP	See Section III.C _____ grams/sec
SO ²	See Section III.C _____ grams/sec

E. Emission Data Used in Modeling

Attach list of emission sources. Emission data required is source name, description on point source (on NEDS point number), UTM coordinates, stack data, allowable emissions, and normal operating time.

F. Attach all other information supportive to the PSD review.

*Specify bubbler (B) or continuous (C).

G. Discuss the social and economic impact of the selected technology versus other applicable technologies (i.e., jobs, payroll, production, taxes, energy, etc.). Include assessment of the environmental impact of the sources.

Enhanced social and economic benefits are expected as a result of employing the selected technologies

H. Attach scientific, engineering, and technical material, reports, publications, journals, and other competent relevant information describing the theory and application of the requested best available control technology.

LIME KILN



AC54-43795

STATE OF FLORIDA
DEPARTMENT OF ENVIRONMENTAL REGULATION
APPLICATION TO OPERATE/CONSTRUCT
AIR POLLUTION SOURCES

SOURCE TYPE: Lime Kiln No. 5 [X] New [] Existing

APPLICATION TYPE: [X] Construction [] Operation [] Modification

COMPANY NAME: Georgia-Pacific Corporation COUNTY: Putnam

Identify the specific emission point source(s) addressed in this application (i.e. Lime Kiln No. 4 with Venturi Scrubber; Peeking Unit No. 2, Gas Fired) Lime Kiln No. 5 with Venturi Scrubber

SOURCE LOCATION: Street N of SR 216, W of US 17 City Palatka

UTM: East 434.0 North 3283.4

Latitude 29 0 41 ' 00 "N Longitude 81 0 40 ' 45 "W

APPLICANT NAME AND TITLE: Roger C. Sherwood, Technical Director

APPLICANT ADDRESS: P.O. Box 919 Palatka, Florida 32077

SECTION I: STATEMENTS BY APPLICANT AND ENGINEER

A. APPLICANT

I am the undersigned owner or authorized representative* of Georgia-Pacific Corporation

I certify that the statements made in this application for a Construction

permit are true, correct and complete to the best of my knowledge and belief. Further, I agree to maintain and operate the pollution control source and pollution control facilities in such a manner as to comply with the provision of Chapter 403, Florida Statutes, and all the rules and regulations of the department and revisions thereof. I also understand that a permit, if granted by the department, will be non-transferable and I will promptly notify the department upon sale or legal transfer of the permitted establishment.

*Attach letter of authorization

Signed: Roger C. Sherwood, Technical Director
Name and Title (Please Type)

Date: 6-2-81 Telephone No. 904/325-2001

B. PROFESSIONAL ENGINEER REGISTERED IN FLORIDA (where required by Chapter 471, F.S.)

This is to certify that the engineering features of this pollution control project have been designed/examined by me and found to be in conformity with modern engineering principles applicable to the treatment and disposal of pollutants characterized in the permit application. There is reasonable assurance, in my professional judgment, that the pollution control facilities, when properly maintained and operated, will discharge an effluent that complies with all applicable statutes of the State of Florida and the rules and regulations of the department. It is also agreed that the undersigned will furnish, if authorized by the owner, the applicant a set of instructions for the proper maintenance and operation of the pollution control facilities and, if applicable, pollution sources.

Signed: David A. Buff
Name (Please Type)

Environmental Science and Engineering, Inc.
Company Name (Please Type)

P.O. Box ESE, Gainesville, Florida 32604
Mailing Address (Please Type)

Date: 6-2-81 Telephone No. 904/372-3318

(Affix Seal)

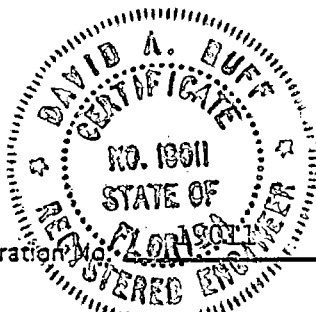

Florida Registration No.

1 See Section 17-2.02(15) and (22), Florida Administrative Code, (F.A.C.)

SECTION II: GENERAL PROJECT INFORMATION

- A. Describe the nature and extent of the project. Refer to pollution control equipment, and expected improvements in source performance as a result of installation. State whether the project will result in full compliance. Attach additional sheet if necessary.
A new 320 ton/day Lime Kiln, No. 5, with a high energy venturi scrubber, will be constructed. The project will result in full compliance with all applicable emission and air quality control regulations.
- B. Schedule of project covered in this application (Construction Permit Application Only)
 Start of Construction September 1982 Completion of Construction 1985
- C. Costs of pollution control system(s): (Note: Show breakdown of estimated costs only for individual components/units of the project serving pollution control purposes. Information on actual costs shall be furnished with the application for operation permit.)
Scrubber - \$300,000
- D. Indicate any previous DER permits, orders and notices associated with the emission point, including permit issuance and expiration dates.
Not Applicable
- E. Is this application associated with or part of a Development of Regional Impact (DRI) pursuant to Chapter 380, Florida Statutes, and Chapter 22F-2, Florida Administrative Code? Yes No
- F. Normal equipment operating time: hrs/day 24; days/wk 7; wks/yr 51; if power plant, hrs/yr _____; if seasonal, describe: _____
- G. If this is a new source or major modification; answer the following questions. (Yes or No)
- | | |
|---|------------|
| 1. Is this source in a non-attainment area for a particular pollutant? | <u>No</u> |
| a. If yes, has "offset" been applied? | <u>---</u> |
| b. If yes, has "Lowest Achievable Emission Rate" been applied? | <u>---</u> |
| c. If yes, list non-attainment pollutants. | <u>---</u> |
| 2. Does best available control technology (BACT) apply to this source? If yes, see Section VI. | <u>Yes</u> |
| 3. Does the State "Prevention of Significant Deterioration" (PSD) requirements apply to this source? If yes, see Sections VI and VII. | <u>Yes</u> |
| 4. Do "Standards of Performance for New Stationary Sources" (NSPS) apply to this source? | <u>Yes</u> |
| 5. Do "National Emission Standards for Hazardous Air Pollutants" (NESHAP) apply to this source? | <u>No</u> |
- Attach all supportive information related to any answer of "Yes". Attach any justification for any answer of "No" that might be considered questionable.

52 6/26/81 Mr. Adams
Mrs. Sherwood

SECTION III: AIR POLLUTION SOURCES & CONTROL DEVICES (Other than Incinerators)

A. Raw Materials and Chemicals Used in your Process, if applicable:

Description	Contaminants		Utilization Rate - lbs/hr	Relate to Flow Diagram
	Type	% Wt		
CaCO ₃ (dry)	Particulate	10	47,619	A
Inerts	Particulate	10	2,964	A
Recycle CaCO ₃	Particulate		11,906	B
Recycle Inerts	Particulate		740	B

B. Process Rate, if applicable: (See Section V, Item 1)

1. Total Process Input Rate (lbs/hr): 63,229

2. Product Weight (lbs/hr): 26,667

C. Airborne Contaminants Emitted:

Name of Contaminant	Emission ¹		Allowed Emission ² Rate per Ch. 17-2, F.A.C.	Allowable ³ Emission lbs/hr	Potential Emission ⁴		Relate to Flow Diagram
	Maximum lbs/hr	Actual T/yr			lbs/hr	T/yr	
Particulate	29.3	125.5	NA	29.3*	2,250	9,855	C
Sulfur Dioxide	10.0	42.8	NA	NA	15.0	66	C
Nitrogen Oxides	93.8	402.0	NA	NA	93.8	411	C
VOC	24.0	102.8	NA	NA	27.3	120	C
Carbon Monoxide	500.0	2,142.0	NA	NA	500.0	2,190	C
Total Reduced Sulfur	1.1	4.7	NA	1.1*	37.5	164.3	

D. Control Devices: (See Section V, Item 4)

Name and Type (Model & Serial No.)	Contaminant	Efficiency	Range of Particles ⁵ Size Collected (in microns)	Basis for Efficiency (Sec. V, It ⁵)
High Energy Venturi Scrubber, Zurn, or equivalent	Particulate	99.7	Submicron	See Attachment B

* Based upon Federal NSPS.

¹ See Section V, Item 2.

² Reference applicable emission standards and units (e.g., Section 17-2.05(6) Table II, E. (1), F.A.C. - 0.1 pounds per million BTU heat input)

³ Calculated from operating rate and applicable standard

⁴ Emission, if source operated without control (See Section V, Item 3)

⁵ If Applicable

E. Fuels

Type (Be Specific)	Consumption*		Maximum Heat Input (MMBTU/hr)
	avg/hr	max./hr	
No. 6 Fuel Oil	16.6	16.6	102

*Units Natural Gas, MMCF/hr; Fuel Oils, barrels/hr; Coal, lbs/hr

Fuel Analysis:

Percent Sulfur: 2.5 Percent Ash: 0.1
 Density: 7.9 lbs/gal Typical Percent Nitrogen: 0
 Heat Capacity: 18,500 BTU/lb 146,000 BTU/gal

Other Fuel Contaminants (which may cause air pollution): _____

F. If applicable, indicate the percent of fuel used for space heating. Annual Average NA Maximum NA

G. Indicate liquid or solid wastes generated and method of disposal.
Scrubber water reused in process

H. Emission Stack Geometry and Flow Characteristics (Provide data for each stack):
 Stack Height: 149 ft. Stack Diameter: 4.33 ft.
 Gas Flow Rate: 48,250 ACFM Gas Exit Temperature: 170 °F.
 Water Vapor Content: 40 % Velocity: 57 FPS

SECTION IV: INCINERATOR INFORMATION

Not Applicable

Type of Waste	Type O (Plastics)	Type I (Rubbish)	Type II (Refuse)	Type III (Garbage)	Type IV (Pathological)	Type V (Liq & Gas By-prod.)	Type VI (Solid By-prod.)
Lbs/hr Incinerated							

Description of Waste _____

Total Weight Incinerated (lbs/hr) _____ Design Capacity (lbs/hr) _____

Approximate Number of Hours of Operation per day _____ days/week _____

Manufacturer _____

Date Constructed _____ Model No. _____

	Volume (ft) ³	Heat Release (BTU/hr)	Fuel		Temperature (°F)
			Type	BTU/hr	
Primary Chamber					
Secondary Chamber					

Stack Height: _____ ft. Stack Diameter _____ Stack Temp. _____

Gas Flow Rate: _____ ACFM _____ DSCFM* Velocity _____ FPS

*If 50 or more tons per day design capacity, submit the emissions rate in grains per standard cubic foot dry gas corrected to 50% excess air.

Type of pollution control device: Cyclone Wet Scrubber Afterburner Other (specify) _____

Brief description of operating characteristics of control devices: _____

Ultimate disposal of any effluent other than that emitted from the stack (scrubber water, ash, etc.):

SECTION V: SUPPLEMENTAL REQUIREMENTS

Please provide the following supplements where required for this application.

- Total process input rate and product weight — show derivation.
See Attachment A.
- To a construction application, attach basis of emission estimate (e.g., design calculations, design drawings, pertinent manufacturer's test data, etc.) and attach proposed methods (e.g., FR Part 60 Methods 1, 2, 3, 4, 5) to show proof of compliance with applicable standards. To an operation application, attach test results or methods used to show proof of compliance. Information provided when applying for an operation permit from a construction permit shall be indicative of the time at which the test was made.
See Attachment A.
- Attach basis of potential discharge (e.g., emission factor, that is, AP42 test).
See Attachment A.
- With construction permit application, include design details for all air pollution control systems (e.g., for baghouse include cloth to air ratio; for scrubber include cross-section sketch, etc.).
See Attachment B.
- With construction permit application, attach derivation of control device(s) efficiency. Include test or design data. Items 2, 3, and 5 should be consistent: actual emissions = potential (1-efficiency).
See Attachment B.
- An 8½" x 11" flow diagram which will, without revealing trade secrets, identify the individual operations and/or processes. Indicate where raw materials enter, where solid and liquid waste exit, where gaseous emissions and/or airborne particles are evolved and where finished products are obtained.
See Attachment B.
- An 8½" x 11" plot plan showing the location of the establishment, and points of airborne emissions, in relation to the surrounding area, residences and other permanent structures and roadways (Example: Copy of relevant portion of USGS topographic map).
See PSD report.
- An 8½" x 11" plot plan of facility showing the location of manufacturing processes and outlets for airborne emissions. Relate all flows to the flow diagram.
See Combination Boiler #5 Application.

ATTACHMENT A

EMISSIONS ESTIMATES

A. Total Process Product Rate and Input Rate Calculation

1. Assume 20 percent recirculation rate (i.e., only 80 percent of wet end feed will exit as product and 20 percent will be carried out by flue gas and captured by the venturi scrubber). This recycle rate is based on the experience of Rust Engineering Company.
2. The product is 90 percent available lime. This is based on laboratory test results.
3. Basic Equation:

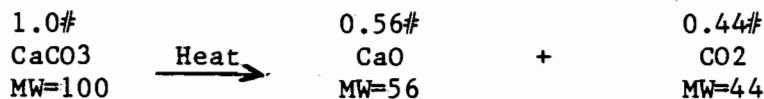

4. Total Process Input Rate = 758.7 tons/day = 63,229 lb/hr
63,225
5. Basic Equation at 90 percent CaO with Feed Rate of 63,229 lb/hr

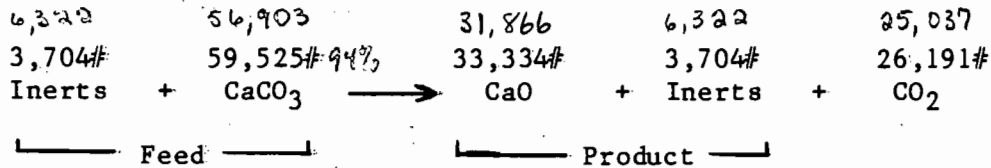

6. Basic Equation at 90 percent CaO with 20 percent Scrubber Capture Recirculation

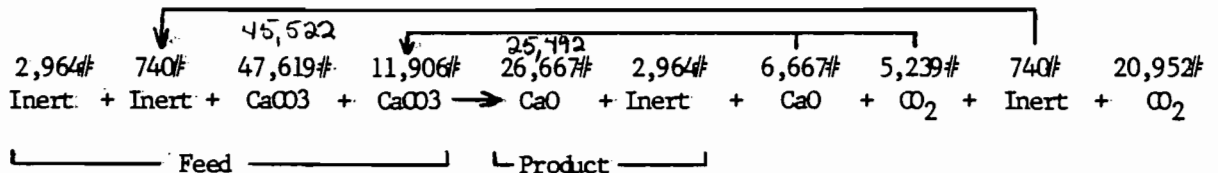

7. Therefore, Product Rate:

$$26,667 \text{ lb/hr} = 13.33 \text{ tons/hr CaO} = 320 \text{ tons/days} \\
 319.92$$

B. Particulate Matter

Maximum and actual emissions based upon NSPS of 0.13 gr/dscf when liquid fossil fuel is burned. Based on No. 4 lime kiln operation:

$$26,300 \text{ dscfm} \times 60 \times 0.13 \div 7,000 = 29.31 \text{ lb/hr}$$

NSPS

Florida process weight regulation: Rate = $63,229 \text{ lb/hr} \div 2,000 = 31.61 \text{ tons/hr}$
 $63,225$

$$E = 17.31 \text{ p}^{0.16} = 30.1 \text{ lb/hr}$$

NSPS is more stringent.

$$\text{Actual emissions} = 29.3 \text{ lb/hr} \times 24 \times 7 \times 51 \div 2,000 = 125.5 \text{ tons/yr}$$

8760 128.3

Potential emissions from AP-42, Table 10.1.2-1 (untreated) = 45 lb/ton of air dried unbleached pulp (ADUP). From No. 4 recovery boiler application, unbleached pulp = $150,000 \div 3,000 = 50 \text{ tons/hr}$

$$50 \text{ tons/hr} \times 45 \text{ lb/ton} = 2,250 \text{ lb/hr} = 9,855 \text{ tons/yr}$$

C. Sulfur Dioxide

Maximum and actual emissions from AP-42, Table 10.1.2-1, with scrubber = 0.2 lb/ton ADUP

$$50 \text{ tons/hr} \times 0.2 = 10 \text{ lb/hr}$$

$$\text{Actual emissions} = 10 \times 24 \times 7 \times 51 \div 2,000 = 42.8 \text{ tons/yr}$$

8760 43.8

Potential emissions from AP-42 without scrubber: 0.3 lb/ton

$$50 \times 0.3 = 15 \text{ lb/hr} = 65.7 \text{ tons/yr}$$

D. Nitrogen Oxides

From TAPPI Conference paper, using largest emission rate for oil firing factor = $0.92 \text{ lb}/10^6 \text{ Btu}$

$$\text{Heat input (maximum)} = 102 \times 10^6 \text{ Btu/hr} \times 0.92 = 93.8 \text{ lb/hr}$$

$$\text{Actual emissions} = 93.8 \times 24 \times 7 \times 51 \div 2,000 = 402 \text{ tons/yr}$$

$$\text{Potential emissions} = 93.8 \text{ lb/hr} = 410.8 \text{ tons/yr}$$

E. VOC

From TAPPI Conference paper, use highest reported emission rate after scrubber, 1.8 lb/ton line produced.

$$\text{Maximum emissions} = 320 \text{ tons/day} \div 24 \times 1.8 = 24 \text{ lb/hr}$$

$$\text{Actual emissions} = 320 \times 1.8 \times 7 \times 51 \div 2,000 = 102.3 \text{ tons/yr}$$

For potential emissions, use highest factor before scrubber, 2.05 lb/ton

$$320 \times 2.05 \div 24 = 27.3 \text{ lb/hr} = 119.7 \text{ tons/yr}$$

F. Carbon Monoxide

From AP-42, factor is 10 lb/ton ADUP both before and after scrubber.

$$\text{Maximum emissions} = 50 \times 10 = 500 \text{ lb/hr}$$

$$\text{Actual emissions} = 500 \times 24 \times 7 \times 51 \div 2,000 = 2,142 \text{ tons/yr}$$

$$\text{Potential emissions} = 500 \times 8,760 \div 2,000 = 2,190 \text{ tons/yr}$$

G. Total Reduced Sulfur

Maximum emissions: Federal NSPS = 8 ppm, dry basis

$$\text{MW H}_2\text{S} = 34, 8 \text{ ppm} = 11,125 \text{ ug/m}^3$$

$$26,300 \text{ dscfm} \times (0.3048)^3 \text{ m}^3/\text{ft}^3 \times 60 \times 11,125 \times 10^{-6} \div 454 = 1.1 \text{ lb/hr}$$

$$\text{Actual emissions} = 1.1 \text{ lb/hr} \times 24 \times 7 \times 51 \div 2,000 = 4.71 \text{ ton/yr}$$

For potential emissions, use AP-42 factor for H₂S and reduced sulfur compounds for untreated emissions:

$$50 \text{ tons/hr} \times 0.75 = 37.5 \text{ lb/hr} = 164.3 \text{ tons/yr}$$

#6 Fuel Oil: Max. 166 Bbls/hr. @ 102 x 10⁶ Btu/hr.

A. Particulate:

B. SO₂:

C. NO_x:

D. CO:

E. TSS:

Absorbed
by
scrubbing

24,485

9. An application fee of \$20, unless exempted by Section 17-4.05(3), F.A.C. The check should be made payable to the Department of Environmental Regulation.
10. With an application for operation permit, attach a Certificate of Completion of Construction indicating that the source was constructed as shown in the construction permit.

SECTION VI: BEST AVAILABLE CONTROL TECHNOLOGY

- A. Are standards of performance for new stationary sources pursuant to 40 C.F.R. Part 60 applicable to the source?
 Yes No

Contaminant	Rate or Concentration
Particulate Matter	0.13 gr/dscf when burning liquid fuel
Total Reduced Sulfur	8 ppm by volume (dry basis)

- B. Has EPA declared the best available control technology for this class of sources (If yes, attach copy) Yes No

Contaminant	Rate or Concentration
Particulate Matter	0.21 gr/dscm (0.091 gr/dscf) @ 10% O ₂
Total Reduced Sulfur	8 ppm @ 10 percent O ₂

- C. What emission levels do you propose as best available control technology?

Contaminant	Rate or Concentration
Particulate Matter	0.13 gr/dscf when burning liquid fuel
Total Reduced Sulfur	8 ppm by volume (dry basis)
All other pollutants	Proper kiln design and operation

- D. Describe the existing control and treatment technology (if any).

1. Control Device/System: See Item E.
2. Operating Principles:
3. Efficiency: *
4. Capital Costs:
5. Useful Life:
6. Operating Costs:
7. Energy:
8. Maintenance Cost:
9. Emissions:

Contaminant	Rate or Concentration

*Explain method of determining D 3 above.

10. Stack Parameters

- a. Height: _____ ft.
- b. Diameter: _____ ft.
- c. Flow Rate: _____ ACFM
- d. Temperature: _____ °F
- e. Velocity: _____ FPS

E. Describe the control and treatment technology available (As many types as applicable, use additional pages if necessary).

1. Particulate Matter/TRS/SO₂

- a. Control Device: Venturi Scrubber with caustic scrubbing water
- b. Operating Principles: Gases are passed through throat where high velocities occur and scrubbing solution is introduced. Droplets disperse and impact and scrub particulate and gases. Mist eliminator section generally follows.
- c. Efficiency*: 99+ percent
- d. Capital Cost: \$300,000
- e. Useful Life: 5 to 10 years
- f. Operating Cost: \$150,000/year (includes depreciation)
- g. Energy*: 100 kw
- h. Maintenance Cost: \$50,000/year
- i. Availability of construction materials and process chemicals: Good.
- j. Applicability to manufacturing processes: Excellent.
- k. Ability to construct with control device, install in available space, and operate within proposed levels: Good. Has demonstrated compliance with NSPS.

2.

- a. Control Device:
- b. Operating Principles:
- c. Efficiency*:
- d. Capital Cost:
- e. Useful Life:
- f. Operating Cost:
- g. Energy**:
- h. Maintenance Costs:
- i. Availability of construction materials and process chemicals:
- j. Applicability to manufacturing processes:
- k. Ability to construct with control device, install in available space, and operate within proposed levels:

*Explain method of determining efficiency.

**Energy to be reported in units of electrical power - KWH design rate.

3.

- a. Control Device:
- b. Operating Principles:
- c. Efficiency*:
- d. Capital Cost:
- e. Life:
- f. Operating Cost:
- g. Energy:
- h. Maintenance Cost:

*Explain method of determining efficiency above.

- i. Availability of construction materials and process chemicals:
 - j. Applicability to manufacturing processes:
 - k. Ability to construct with control device, install in available space and operate within proposed levels:
- 4.
- a. Control Device
 - b. Operating Principles:
 - c. Efficiency*:
 - d. Capital Cost:
 - e. Life:
 - f. Operating Cost:
 - g. Energy:
 - h. Maintenance Cost:
 - i. Availability of construction materials and process chemicals:
 - j. Applicability to manufacturing processes:
 - k. Ability to construct with control device, install in available space, and operate within proposed levels:

F. Describe the control technology selected: See Item E, F, and Attachment B.

- 1. Control Device:
- 2. Efficiency*:
- 3. Capital Cost:
- 4. Life:
- 5. Operating Cost:
- 6. Energy:
- 7. Maintenance Cost:
- 8. Manufacturer:
- 9. Other locations where employed on similar processes:
 - a.
 - (1) Company:
 - (2) Mailing Address:
 - (3) City:
 - (4) State:
 - (5) Environmental Manager:
 - (6) Telephone No.:

*Explain method of determining efficiency above.

- (7) Emissions*:

Contaminant	Rate or Concentration
See Attachment B	

- (8) Process Rate*:

b.

- (1) Company:
- (2) Mailing Address:
- (3) City:
- (4) State:

*Applicant must provide this information when available. Should this information not be available, applicant must state the reason(s) why.

(5) Environmental Manager:

(6) Telephone No.:

(7) Emissions*:

Contaminant	Rate or Concentration
_____	_____
_____	_____
_____	_____

(8) Process Rate*:

10. Reason for selection and description of systems:

See following pages.

*Applicant must provide this information when available. Should this information not be available, applicant must state the reason(s) why.

6/1/81

Particulate emissions from most lime kilns at pulp mills are controlled by venturi scrubbers, with pressure drops ranging from 10 inches (in) to 25 in H₂O. A few kilns utilize wet impingement scrubbers, but these generally obtain lower efficiencies. ESP's have been reported to be utilized in Sweden and on a retrofit installation in the United States. Fabric filters cannot be used because of the high moisture content, 25 to 35 percent, in the the exhaust gases. Because of the proven operation of the venturi scrubber in general, and at G-P's Palatka mill in specific (see Attachment B), the venturi scrubber was chosen as BACT. The scrubber will be identical to the one presently in operation at G-P.

Only three BACT determinations are known to have been made to date on lime kilns in the Kraft pulp mill industry. One of 0.21 g/dscm at 10 percent O₂, which is equivalent to 0.091 gr/dscf. This is below the NSPS level of 0.13 gr/dscf. A venturi scrubber with 97 percent efficiency was utilized. In the second, only a mass emission loading was given, with a venturi scrubber with 28 to 30 in H₂O pressure drop and 99.8 percent efficiency specified. In the third, an emission level of 0.12 gr/dscf when burning oil was specified. A venturi scrubber was again chosen as the control technique.

The existing No. 4 lime kiln at G-P presently employs a venturi scrubber with 26 in H₂O pressure drop. The vendor has guaranteed 99.7 percent efficiency on this unit, and calculations show a 98.7 percent efficiency based on AP-42 uncontrolled emission factors. Test data for this scrubber show that the NSPS level of 0.13 gr/dscf has been achieved the majority of the time. However, several individual tests resulted in levels up to 0.20 gr/dscf. Based on the historical test data for this unit at G-P and because the scrubber efficiency is nominally greater than 99 percent, this same scrubber with 26 in pressure drop is chosen as BACT and the NSPS level of 0.13 gr/dscf is proposed as an emission limit.

Because of the extremely low estimated SO₂ emissions from the lime kiln, no add-on SO₂ controls or further reduction in SO₂ levels is deemed appropriate. The maximum estimated SO₂ emission rate is proposed as BACT, considering the effects of SO₂ removal in the kiln and caustic scrubber water.

Little information is available concerning NO_x control techniques for lime kilns at Kraft pulp mills. In the recent NCASI paper (see Combination Boiler application), no correlation was found between NO_x emissions and type of fuel burned (oil or gas). However, a correlation between combustion zone temperature or burned lime temperature and NO_x was found. This is not an unexpected result. As combustion zone temperature increased, so did NO_x emissions in lb/10⁶ Btu heat input. This correlation was only investigated for a gas-fired unit. It was theorized that controlling the excess air level and firing rate could reduce combustion temperature and therefore NO_x emissions. Based on this limited data, good firing and operational practices are proposed as BACT for the lime kiln for NO_x. No feasible add-on controls are known to exist for NO_x.

Similarly, little information exists on VOC or CO emissions or control techniques. The NCASI paper demonstrated that VOC emissions from lime kilns are likely due to organics contained in the water used in the process. A wet scrubber was found to reduce VOC emissions slightly in

6/1/81

two cases and increase emissions slightly in one case. BACT for both VOC and CO emissions are proposed as good firing and operational practices consistent with product quality.

As described in the preamble to the final NSPS for Kraft pulp mills (Federal Register, Vol. 43, No. 37, February 23, 1978), the NSPS limit for TRS is based on operation at one lime kiln in the United States. This kiln was the only kiln using a combination of efficient mud washing, good lime kiln process operation, and caustic scrubbing. Due to the limited and site specific data utilized to promulgate the NSPS, these control techniques for TRS emissions are considered to represent BACT, with a BACT limit equal to the Federal NSPS of 8 ppm by volume dry basis. This limit is equivalent to approximately 1 lb/hr of TRS emissions. The proposed BACT for the lime kiln is also supported by the final guideline document for TRS emissions from existing Kraft pulp mills. In addition, in the only two BACT determinations for TRS from lime kilns known to date, the NSPS level of 8 ppm was determined to be BACT in both cases.

REFERENCES

1. Dallons, V.J., and Simon, C. Volatile Organic Compound Emissions From Pacific Northwest Pulp and Paper Industry Combustion Sources. NCASI paper presented at 1981 TAPPI Environmental Conference, New Orleans, La.
2. Environmental Specialists. October 1978. Operation and Maintenance of Particulate Control Devices in Kraft Pulp Mill and Crushed Stone Industries, PEDC. EPA-600/2-78-210.
3. Final Guideline Document: Control of TRJ Emissions from Existing Kraft Pulp Mills. U.S. EPA, EPA-450/2-78-003b, 1978.
4. Hood, K.T., and Miner, R.A. Nitrogen Oxide Emissions from Combustion Services in the Pulp and Paper Industry. Paper presented at 1981 TAPPI Environmental Conference, New Orleans, La.
5. NO_x Emissions from Combustion Services in the Pulp and Paper Industry. Hood, K.T. and Miner, R.A. NCASI. Paper presented at 1981 TAPPI Environmental Conference, New Orleans, La.
6. Operation and Maintenance of Particulate Control Devices in Kraft Pulp Mill and Crushed Stone Industries, PEDC. Environmental Specialists. EPA-600/2-78-210, October 1978.
7. U.S. Environmental Protection Agency. 1978. Final Guideline Document: Control of TRS Emissions from Existing Kraft Pulp Mills. EPA-450/2-78-003b.
8. Volatile Organic Compound Emissions from Pacific Northwest Pulp and Paper Industry Combustion Sources. Dallons, V.J. and Simon, C. NCASI. Paper presented at 1981 TAPPI Environmental Conference, New Orleans, La.
9. Compilation of BACT/LAER Determinations, Revised. PEDCo Environmental Specialists, Inc. May 1980.

ATTACHMENT B

LIME KILN BACT INFORMATION

Efficiency of scrubber required

Maximum emissions at NSPS = 29.31 lb/hr (Attachment A)

Potential emissions = 2,250 lb/hr (based on AP-42)

Required efficiency = $(2,250 - 29.31) \div 2,250 \times 100 = 98.7\%$

For this scrubber, Zurn has guaranteed outlet at 28.8 lb/hr

Guaranteed efficiency = $(2,250 - 28.8) \div 2,250 \times 100 = 98.7\%$

Based on design grain loadings (gr/dscf)

Guaranteed efficiency = $(45.69 - 0.11) \div 45.69 \times 100 = 99.7\%$

PARTICULATE TEST RESULTS--LIME KILN NO. 4 SCRUBBER

Date	Process Weight (tons/hr)	Allowable Emission (lb/hr)	Actual Emission (lb/hr)	Flow Rate (dscfm)	Grain Loading (gr/dscf)
05/76	20.18	23.3	16.6	--	--
	19.52	22.7	17.2	--	--
	21.16	23.8	14.7	--	--
12/13/76	20.03	23.0	19.8	--	--
12/15/76	14.19	18.3	10.4	--	--
12/29/76	20.39	23.3	8.3	--	--
	21.33	23.9	8.9	--	--
06/08/77	39.45	31.2	11.9	--	--
	35.76	30.7	16.4	--	--
06/09/77	34.86	30.6	13.2	--	--
02/78	28.42	28.6	18.4	25,161	0.085
	29.72	29.4	13.9	24,775	0.065
	27.31	27.9	15.2	24,491	0.072
06/78	28.58	28.7	24.9	22,058	0.132
	25.90	27.0	20.6	19,215	0.125
	26.37	27.3	19.3	14,754	0.153
02/79	32.41	30.2	20.5	23,262	0.103
	32.41	30.2	19.6	22,241	0.103
	32.41	30.2	22.7	17,755	0.149
06/79	--	--	--	20,673	--
	30.21	29.7	18.6	20,670	0.105
	40.53	31.3	11.7	21,334	0.064
12/79	40.53	31.3	42.4	24,079	0.205
	40.53	31.3	19.6	23,701	0.096
	49.33	32.3	17.4	22,208	0.091
06/80	--	--	--	24,833	--
	31.75	30.1	28.1	23,401	0.140
	34.48	30.5	29.5	22,043	0.156
12/80	34.48	30.5	26.3	21,895	0.140
	37.40	30.9	30.8	26,262	0.137
	33.09	30.3	19.8	23,219	0.099

BACT/LAER CLEARINGHOUSE REPORT

10.1

SOURCE TYPE/SIZE: SEMICHEMICAL/KRAFT PULP MILL: 2194 TAD/D

NAME/ADDRESS: INTERNATIONAL PAPER COMPANY, PO BOX 160707, MOBILE, ALABAMA 36616

DETERMINATION DATA: CONDITIONAL/FINAL/PENDING for BACT LAER on NEW/MODIFIED SOURCE
 KEY DATES: Application-Recd. _____, Completed _____; Determination-Proposed _____, Final _____

BY: (Agency) U.S. EPA REGION VI Person _____ Phone _____

AFFECTED FACILITIES Power boilers(2)contd.	THROUGHPUT CAPACITY	EMISSION RATE, -UNCONTROLLED*	EMISSION LIMITS (Basis)**	CONTROL STRATEGY DESCRIPTION Equipment type, etc.	Eff. %
		CO	1. 130 lb/hr, and 0.17 lb/10 ⁶ Btu, -1 lb/ton coal,		
			2 lb/ton wood and 210 lb/10 ³ bbl oil.		
Lime Kiln		SO ₂	29.9 lb/h (B)	Fires 0.7% S oil max. natural suppression by quicklime absorption, and caustic solu- tion in TSP scrubber	
		CO	700 lb/h (B)	Good process controls	

SOURCE OPERATION: BATCH/CONTINUOUS: _____ hrs/yr; % by Season _____
 W Sp Su F

NOTES: _____

* Specify pollutant (PM, SO₂, NO_x, HC, CO or other) and mass emission rate
 ** Basis symbols: Use B = BACT, N = NSPS, S = SIP, A = Achieved-in-Practice (AIP)

BACT/LAER CLEARINGHOUSE REPORT

10.1

SOURCE TYPE/SIZE: SEMICHEMICAL/KRAFT PULP MILL: 2194 TAD/D

NAME/ADDRESS: INTERNATIONAL PAPER COMPANY, PO BOX 160707, MOBILE, ALABAMA 36616

DETERMINATION DATA: CONDITIONAL/FINAL/PENDING for BACT/LAER on NEW/MODIFIED SOURCE
 KEY DATES: Application-Recd. _____, Completed _____; Determination-Proposed _____, Final _____

BY: (Agency) U.S. EPA REGION VI Person _____ Phone _____

AFFECTED FACILITIES Line kiln (contd)	THROUGHPUT CAPACITY	EMISSION RATE* -UNCONTROLLED	EMISSION LIMITS (Basis)**	CONTROL STRATEGY DESCRIPTION Equipment type, etc.	Eff. %
		PM	61.1 lb/h (B)	Venturi scrubber with 28-30" pressure drop.	99.8
		TRS	8 ppmv dry, at 10% O ₂ (N)	Good process controls and incineration	
Disolving Tanks (2)		PM	11.3 lb/h ea, and 0.1 g/kg black liquor solids (N)	Water/fume impingement wet scrubber	99.8
		TRS	5 ppmv, dry, at 8% O ₂ (N)	Good process controls.	
Line Slaker		PM	2 lb/h (B)	Water/fume impingement wet scrubber	99.5

SOURCE OPERATION: BATCH/CONTINUOUS: _____ hrs/yr; % by Season _____
 W Sp Su F

NOTES: _____

* Specify pollutant (PM, SO₂, NO_x, HC, CO or other) and mass emission rate
 ** Basis symbols: Use B = BACT, N = NSPS, S = SIP, A = Achieved-in-Practice (AIP)

BACT/LAER CLEARINGHOUSE REPORT

SOURCE TYPE/SIZE: KRAFT PULP MILL

PULPING CAPACITY 1034 TONS/DAY

NAME/ADDRESS: BOISE CASCADE, P.O. BOX 500, WALLULA, WA 99363

DETERMINATION IS: CONDITIONAL/FINAL/PENDING: DATE OF ISSUE: 2/24/78 BASIS:* BACT¹/LAER/BACT²
FOR NEW/MODIFIED SOURCE

BY EPA REGION X LARRY SIMS AND PAUL BOYS (206) 442-1106
(Agency) (Person) (Phone)

PERMIT PARAMETERS: AFFECTED FACILITIES	THROUGHPUT CAPACITY, weight rate	POLLUTANT(S) EMITTED	EMISSION LIMIT(S) AND BASIS FOR**	CONTROL STRATEGY DESCRIPTION	
				Equipment type, etc.	Eff.,%
Recovery boiler (No. 2)	238 ADT/day feed or 738,000 ^a	TSP	0.44 gr/scf/476 (N) lb/day	ESP	99.5
		SO ₂	160 ppm/5424 lb/day (B)	Impinger type wet scrubber	95
		Opacity	35% (N)		
Lime kiln	544 tons/day or 847 ADT	TSP (gas)	0.067 gr/scf/466 (B) lb/day	Venturi scrubber	

NOTES: ^a Pounds black liquor dry solids/day; ADT means Air Dried Tons.
Where no NSP requirement, state standards apply for opacity - 20%

* Circle one. BACT-1 indicates determination made under pre-1977 amendments; BACT-2 indicates post-1977 amendments to CAA.

** Basis symbols: Use B = BACT, N = NSPS, S = SIP, L = LAER, P = PSD Increment

463

BACT/LAER CLEARINGHOUSE REPORT

SOURCE TYPE/SIZE: KRAFT PULP MILL

PULPING CAPACITY 1034 TONS/DAY

NAME/ADDRESS: BOISE CASCADE, P.O. BOX 500, WALLULA, WA 99363

DETERMINATION IS: CONDITIONAL/FINAL/PENDING: DATE OF ISSUE: 2/24/78 BASIS: * BACT¹/LAER/BACT² FOR NEW/MODIFIED SOURCE

BY EPA REGION X (Agency) LARRY SIMS AND PAUL BOYS (Person) (206) 442-1106 (Phone)

PERMIT PARAMETERS: AFFECTED FACILITIES	THROUGHPUT CAPACITY, weight rate	POLLUTANT(S) EMITTED	EMISSION LIMIT(S) AND BASIS FOR**	CONTROL STRATEGY DESCRIPTION	
				Equipment type, etc.	Eff.,%
Lime kiln (continued)		TSP (oil)	0.12 gr/scf/906 (B)		
			1b/day		
		Opacity	20% (S)		
		SO ₂	5 ppm/19 lb/day (B)		
No.2 Dissolver vent	253 ADT	TSP	71 lb/day (N)	Chemico-type scrubber	
		Opacity	20% (S)		
Decker hood	200 ADT	TSP	0.01 ADT/2 lb/day (B)		
		Opacity	20% (S)		

NOTES:

* Circle one. BACT-1 indicates determination made under pre-1977 amendments; BACT-2 indicates post-1977 amendments to CAA.

** Basis symbols: Use B = BACT, N = NSPS, S = SIP, L = LAER, P = PSD Increment

464



a step ahead of tomorrow

Page 4 of
Date July 2, 1974
Proposal No. AP-826

VENTURI SCRUBBER

1. DESIGN INLET CONDITIONS

A. Volume	<u>85,000</u>	<u>CFM</u>
B. Temperature	<u>450</u>	<u>°F.</u>
C. Humidity	<u>0.3495</u>	<u>#W.V./#D.G.</u>
D. Dust Loading	<u>45.69</u>	<u>Grs/SCFD</u>
E. Density	<u>0.0377</u>	<u>#/Ft.³</u>

2. DESIGN EXIT CONDITIONS

A. Volume	<u>65,520</u>	<u>CFM</u>
B. Temperature	<u>172</u>	<u>°F.</u>
C. Humidity	<u>0.4596</u>	<u>#W.V./#D.G.</u>
D. Dust Loading	<u>0.1096</u>	<u>Grs/SCFD</u>
E. Density	<u>0.0529</u>	<u>#/Ft.³</u>

3. PRESSURE DROP ALLOWANCES

A. Kiln	<u>1.5</u>	<u>"W.G.</u>
B. Duct Work	<u>1</u>	<u>"W.G.</u>
C. Venturi Throat	<u>26</u>	<u>"W.G.</u>
D. Separator	<u>1.5</u>	<u>"W.G.</u>
E. TOTAL	<u>30</u>	<u>"W.G.</u>

4. WATER REQUIREMENTS

A. Scrubbing Water	<u>1080</u>	<u>GPM</u>
B. Water Evaporated	<u>31</u>	<u>GPM</u>
C. Bleed-Off at <u>5</u> % Solids	<u>496</u>	<u>GPM</u>
D. Make-Up Water	<u>527</u>	<u>GPM</u>
E. Water Recirculation	<u>553</u>	<u>GPM</u>

5. MATERIALS OF CONSTRUCTION

A. Venturi Throat	<u>3/16" 316 L Stainless Steel</u>
B. Flooded Elbow	<u>3/16" 316 L Stainless Steel</u>
C. Separator	<u> </u>
D. Duct Work	<u>1/8" 316 L Stainless Steel</u>
E. Stack	<u> </u>

6. PREDICTED PERFORMANCE

Please see enclosed guarantee

7. It is recognized that the performance of the equipment covered in this proposal cannot be exactly predicted for every possible operating condition. In consequence, any predicted performance data submitted are intended to show probable operating results which may be closely approximated but which cannot be guaranteed except as expressly stated in the guarantee clause or clauses in this proposal.
8. Any performance curves submitted are for the PURCHASER'S convenience and the performance indicated thereon is not offered by Zurn Ind. Inc., Air Systems Div., nor to be construed by the PURCHASER, as a proposal of contract obligation.

July 2, 1974

PERFORMANCE GUARANTEE

Based upon the designed conditions shown in the venturi specification sheet, Zurn Air Systems guarantees that the outlet particulate emissions from its venturi scrubbing system will not exceed 28.8 lbs/hr, which is less than the allowable emission for the stated process under the Florida Air Pollution Code. This is based upon an expected maximum kila feed rate of 712 tons per day.

This guarantee is based upon a 26" w.g. pressure drop across the venturi throat and an inlet grain loading of no more than 45.69 grains per SCFD of a which a maximum of 7 1/2% by weight is assumed to be soda fume as sodium carbonate.

Based upon a kila feed rate of 75% of the expected maximum of 712 tons per day, the allowable emission is:

$$E = 3.59 p^{0.62}$$

$$E = 3.59 \times 22.25^{0.62}$$

$$E = 24.57 \text{ lb/hr particulate emission}$$

Assuming the inlet dust loading to the scrubber also decreases by approximately 75%, Zurn Air Systems will guarantee that the emission from its scrubber system will not exceed the 24.57 lbs/hr. maximum allowable emission rate. This based upon a 26" w.g. pressure drop at the venturi throat and a soda fume content in the dust of approximately 7 1/2% by weight as sodium carbonate.

Sampling and testing procedures to be used in determining the emission from the system will be in accordance with the Florida Department of Pollution Control Requirements.

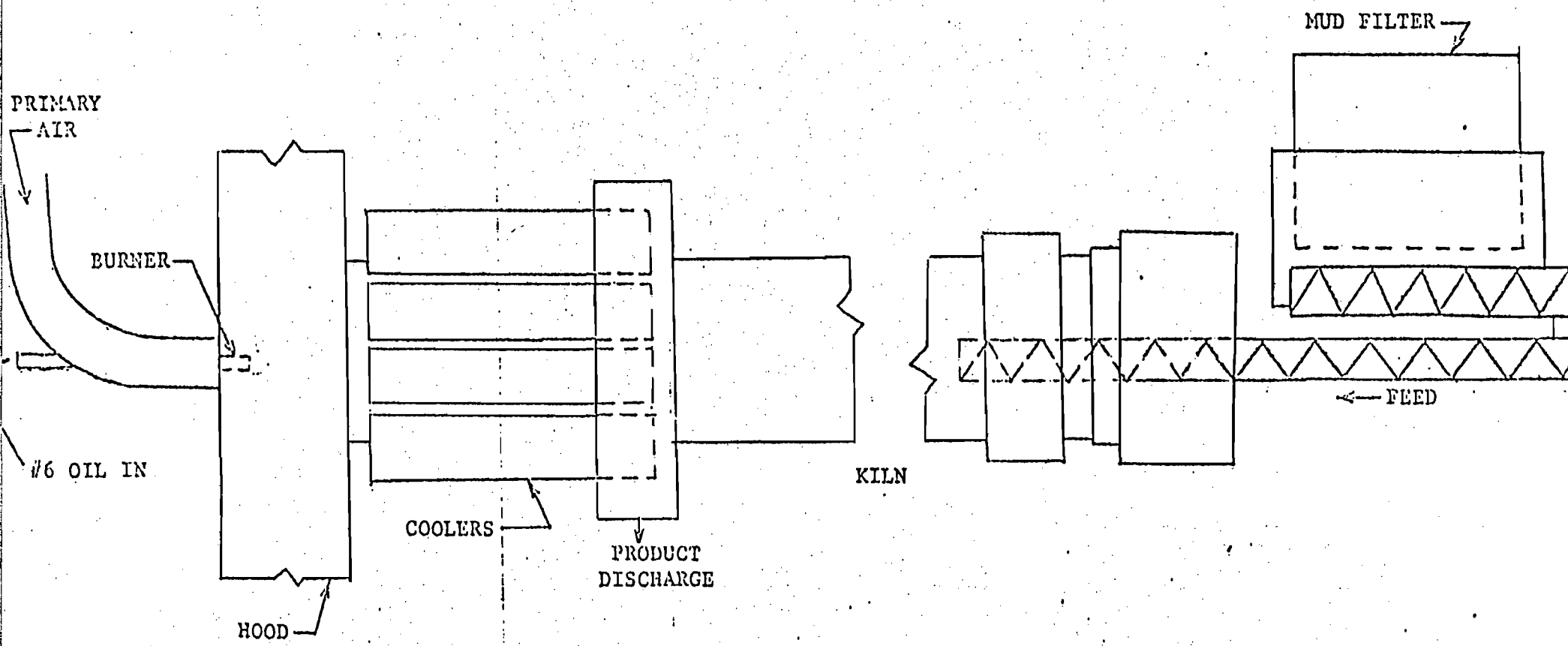
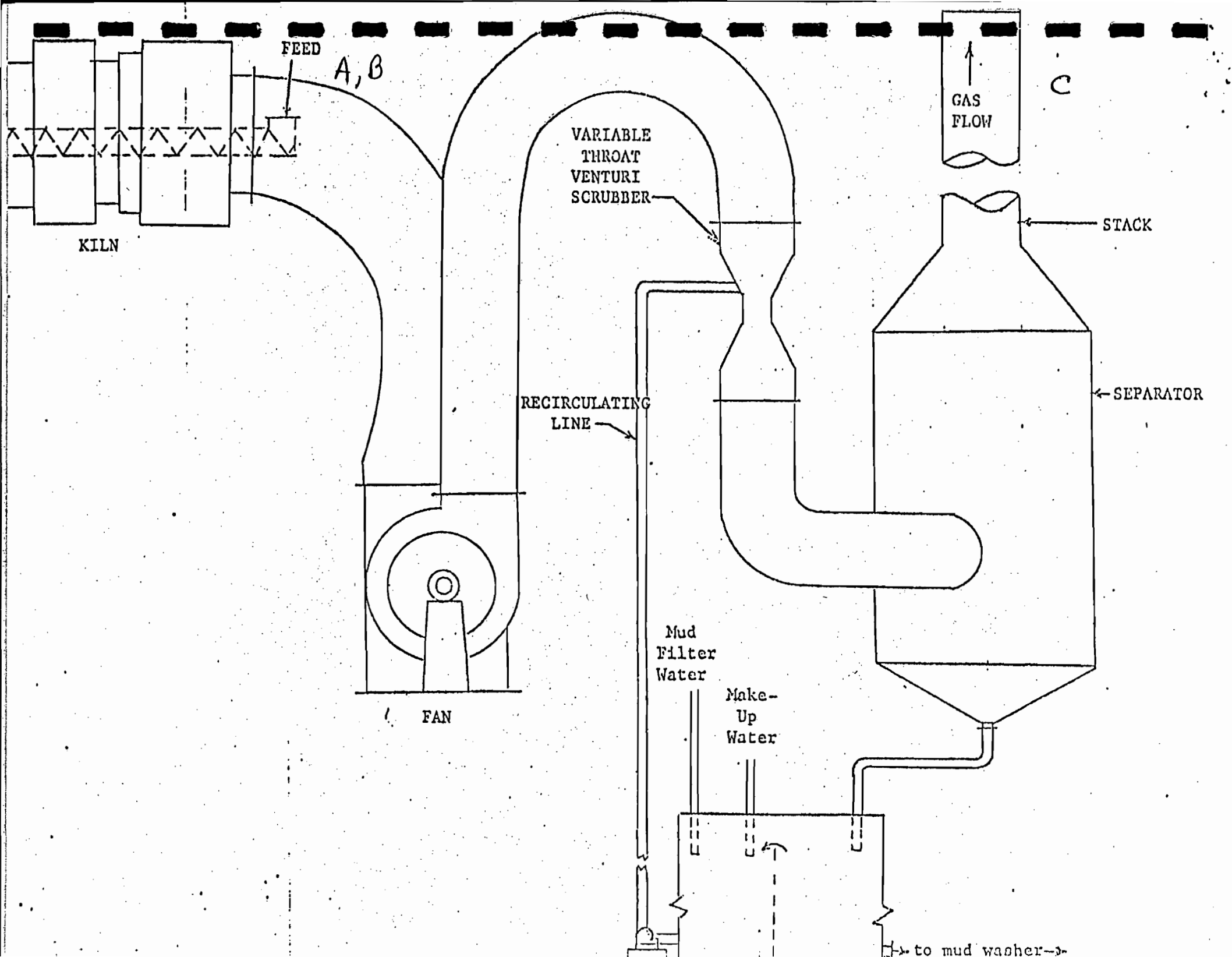

FIGURE I



SECTION VII - PREVENTION OF SIGNIFICANT DETERIORATION

Items A - C, See No. 5 Combination Boiler Application

A. Company Monitored Data

1. _____ no sites _____ TSP _____ () SO₂* _____ Wind spd/dir
 Period of monitoring _____ / _____ / _____ to _____ / _____ / _____
 month day year month day year

Other data recorded _____

Attach all data or statistical summaries to this application.

2. Instrumentation, Field and Laboratory

- a) Was instrumentation EPA referenced or its equivalent? _____ Yes _____ No
- b) Was instrumentation calibrated in accordance with Department procedures? _____ Yes _____ No _____ Unknown

B. Meteorological Data Used for Air Quality Modeling

1. _____ Year(s) of data from _____ / _____ / _____ to _____ / _____ / _____
 month day year month day year

2. Surface data obtained from (location) _____

3. Upper air (mixing height) data obtained from (location) _____

4. Stability wind rose (STAR) data obtained from (location) _____

C. Computer Models Used

- 1. _____ Modified? If yes, attach description.
- 2. _____ Modified? If yes, attach description.
- 3. _____ Modified? If yes, attach description.
- 4. _____ Modified? If yes, attach description.

Attach copies of all final model runs showing input data, receptor locations, and principle output tables.

D. Applicants Maximum Allowable Emission Data

Pollutant	Emission Rate
TSP	See Section III.C. _____ grams/sec
SO ₂	See Section III.C. _____ grams/sec

E. Emission Data Used in Modeling

Attach list of emission sources. Emission data required is source name, description on point source (on NEDS point number), UTM coordinates, stack data, allowable emissions, and normal operating time. See PSD report.

F. Attach all other information supportive to the PSD review.

*Specify bubbler (B) or continuous (C).

G. Discuss the social and economic impact of the selected technology versus other applicable technologies (i.e., jobs, payroll, production, taxes, energy, etc.). Include assessment of the environmental impact of the sources.

The selected technologies should have a positive economic and social impact due to increased jobs and taxes.

H. Attach scientific, engineering, and technical material, reports, publications, journals, and other competent relevant information describing the theory and application of the requested best available control technology.

APPENDIX B

CALCULATION OF CONTEMPORANEOUS EMISSION REDUCTIONS

APPENDIX B

CALCULATION OF CONTEMPORANEOUS EMISSION REDUCTIONS

Recovery Boilers 1, 2, and 3

Pulp Production

- No. 1: 1976 Black Liquor Solids production (BLS) = 340 TPD
 $340 \div 3,000 \text{ lbs BLS/ton pulp} \times 365 \times 2,000 = 82,733 \text{ TPY pulp}$
- No. 2: 1976 BLS production = 486 TPD
 $486 \div 3,000 \times 365 \times 2,000 = 118,243 \text{ TPY pulp}$
- No. 3: 1976 BLS production = 471 TPD
 $471 \div 3,000 \times 365 \times 2,000 = 114,594 \text{ TPY pulp}$

Emissions

- Particulate AP-42 emission factor = 8 lb/ton pulp
 SO₂ AP-42 emission factor = 5 lb/ton pulp
 H₂S AP-42 emission factor = 12 lb/ton pulp
 Reduced S AP-42 emission factor = 1 lb/ton pulp

Boiler	Emissions (TPY)		
	TSP	SO ₂	H ₂ S+RS = TRS
1	331	207	538
2	473	296	767
3	458	286	745

Smelt Tanks 1, 2, and 3

Pulp Production

- No. 1: 1976 Black Liquor Solids production (BLS) = 340 TPD
 $340 \div 3,000 \text{ lbs BLS/ton Pulp} \times 365 \times 2,000 = 82,733 \text{ TPY pulp}$
- No. 2: 1976 BLS production = 486 TPD
 $486 \div 3,000 \times 365 \times 2,000 = 118,243 \text{ TPY pulp}$
- No. 3: 1976 BLS production = 471 TPD
 $471 \div 3,000 \times 365 \times 2,000 = 114,594 \text{ TPY pulp}$

Emissions

Particulate factor = 0.25 lb/ton pulp
SO₂ factor = 0.1 lb/ton pulp
H₂S factor = 0.04 lb/ton pulp
RS factor = 0.4 lb/ton pulp

<u>Smelt Tank</u>	<u>Emissions (TPY)</u>		
	<u>TSP</u>	<u>SO₂</u>	<u>H₂S+RS = TRS</u>
1	10	4	18
2	15	6	26
3	14	6	25