



AIR HYGIENE, INC.

Testing Solutions for a Better World

RECEIVED

MAY 20 2011

BUREAU OF
AIR REGULATION

**EMISSION COMPLIANCE TEST
FOR THE
MITSUBISHI, MODEL 501G, UNIT 3C
PREPARED FOR
FLORIDA POWER AND LIGHT
AT THE
WEST COUNTY ENERGY CENTER
LOXAHATCHEE, FLORIDA
APRIL 7, 2011**



Corporate Headquarters

5634 S. 122nd E. Ave. Suite F
Tulsa, OK 74146



AIR HYGIENE, INC.

(918) 307-8865 or (888) 461-8778
www.airhygiene.com

Remote Testing Offices

Las Vegas, NV 89156
Ft. Worth, TX 76028
Humble, TX 77338
Shreveport, LA 71115
Miami, FL 33101
Philadelphia, PA 19136

EMISSION COMPLIANCE TEST
FOR THE
MITSUBISHI, MODEL 501G, UNIT 3C
PREPARED FOR
FLORIDA POWER AND LIGHT
AT THE
WEST COUNTY ENERGY CENTER
LOXAHATCHEE, FLORIDA
APRIL 7, 2011

Prepared and Reviewed by:



Mars Sharief, QSTI, Director of Specialty Testing

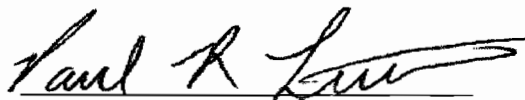

Paul Little, QSTI, Director of Customer Service

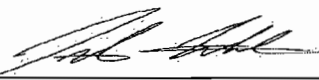

Jake Fahlenkamp, QSTI, Director of Quality Assurance

Table of Contents

1.0	INTRODUCTION	1
1.1	TEST PURPOSE AND OBJECTIVES	1
1.2	SUMMARY OF TEST PROGRAM	1
1.2.1	Participating Organizations	1
1.2.2	Industry	1
1.2.3	Air Permit and Federal Requirements	1
1.2.4	Plant Location	1
1.2.5	Equipment Tested	1
1.2.6	Emission Points	2
1.2.7	Pollutants Measured	2
1.2.8	Date of Emission Test	2
1.3	KEY PERSONNEL	2
2.0	SUMMARY OF TEST RESULTS	2
3.0	SOURCE OPERATION	4
3.1	PROCESS DESCRIPTION	4
3.2	SAMPLING LOCATION	4
4.0	SAMPLING AND ANALYTICAL PROCEDURES	5
4.1	TEST METHODS	5
4.2	INSTRUMENT CONFIGURATION AND OPERATIONS FOR GAS ANALYSIS	5

APPENDICES

Appendix A	Test Results and Calculations
Appendix B	Emission Data Records
Appendix C	Calibration Gas Certifications
Appendix D	Quality Assurance and Quality Control Data
Appendix E	Fuel Analysis Records
Appendix F	Stratification Test Data

**Emissions Compliance Test
Mitsubishi, Model 501G, Unit 3C
Florida Power and Light
West County Energy Center
Loxahatchee, Florida
April 7, 2011**

1.0 INTRODUCTION

Air Hygiene International, Inc. (Air Hygiene) has completed the emissions testing study for nitrogen oxides (NO_x), carbon monoxide (CO), volatile organic compounds (VOC), ammonia (NH₃), opacity, carbon dioxide (CO₂), and oxygen (O₂) from the exhaust of the Mitsubishi, Model 501G, Unit 3C for Florida Power and Light at the West County Energy Center near Loxahatchee, Florida. This report details the background, results, process description, and the sampling/analysis methodology of the stack sampling survey conducted on April 7, 2011.

1.1 TEST PURPOSE AND OBJECTIVES

The purpose of the test was to conduct an initial compliance emission test to document levels of selected pollutants at one test load (Fuel Oil). The information will be used to confirm compliance with the operating permit issued by the Florida Department of Environmental Protection (FDEP). The specific objective was to determine the emission concentration of NO_x, CO, VOC, NH₃, opacity, CO₂, and O₂ from the exhaust of Florida Power and Light's Mitsubishi, Model 501G, Unit 3C firing Fuel Oil of total capacity.

1.2 SUMMARY OF TEST PROGRAM

The following list details pertinent information related to this specific project:

- 1.2.1 Participating Organizations
 - Florida Department of Environmental Protection (FDEP)
 - Florida Power and Light
 - Black and Veatch
 - Air Hygiene
- 1.2.2 Industry
 - Electric Utility / Electric Services
- 1.2.3 Air Permit and Federal Requirements
 - Permit Number: PSD-FL-396
 - Emission Unit Identification (ID): 015
- 1.2.4 Plant Location
 - West County Energy Center near Loxahatchee, Florida
- 1.2.5 Equipment Tested
 - Mitsubishi, Model 501G, Unit 3C

- 1.2.6 Emission Points
 - Exhaust from the Mitsubishi, Model 501G, Unit 3C
 - For all gases, 12 sample points in the exhaust duct from the Mitsubishi, Model 501G, Unit 3C, determined after conducting a stratification test (refer to Appendix F)
 - For all NH₃ testing, 24 sampling points in the exhaust duct from the Mitsubishi, Model 501G, Unit 3C (refer to Appendix A)
 - For opacity, one sample visual observation point from the exit of the exhaust duct to the atmosphere from the Mitsubishi, Model 501G, Unit 3C
- 1.2.7 Pollutants Measured
 - NO_x
 - CO
 - VOC
 - NH₃
 - Opacity
 - CO₂
 - O₂
- 1.2.8 Date of Emission Test
 - April 7, 2011

1.3 KEY PERSONNEL

Florida Power and Light:	John Mirino	305-242-3895
Florida Power and Light:	David Fawcett	561-904-4907
Black and Veatch:	Bill Stevenson	913-458-8549
Air Hygiene:	Jake Fahlenkamp	918-307-8865
Air Hygiene:	Mukund Venkitachalam	918-307-8865

2.0 SUMMARY OF TEST RESULTS

Results from the sampling conducted on Florida Power and Light's Mitsubishi, Model 501G, Unit 3C located at the West County Energy Center on April 7, 2011 are summarized in the following table.

**TABLE 2.1
SUMMARY OF MITSUBISHI, 501G, UNIT 3C RESULTS**

Parameter	Fuel Oil Load	Permit Limits
Date (mm/dd/yy)	04/07/11	--
Start Time (hh:mm:ss)	12:00:18	--
End Time (hh:mm:ss)	16:38:48	--
Run Duration (min / run)	76	--
Bar. Pressure (in. Hg)	30.12	--
Amb. Temp. (°F)	83	--
Rel. Humidity (%)	59	--
Spec. Humidity (lb water / lb air)	0.014031	--
Ammonia Injection Rate (lb/hr)	489.5	--
Turbine Fuel Flow (gal/hr)	15,671	--
Total Fuel Flow (SCFH)	2,095	--
Stack Flow (RM19) (SCFH)	53,610,608	--
Stack Moisture (% Method 4)	8.7	--
Heat Input (MMBtu/hr)	2,056	2,117
Power Output (megawatts)	213.5	--
NOx (ppmvd)	7.67	--
NOx (ppm@15%O ₂)	6.08	8.0
NOx (ppm@15%O ₂ &ISO)	6.56	--
NOx (lb/hr)	49.11	82.4
NOx (ton/year) at 500 hr/year	12.28	--
NOx (lb/MMBtu)	0.024	--
CO (ppmvd)	7.49	--
CO (ppm@15%O ₂)	5.93	8
CO (ppm@15%O ₂ &ISO)	6.41	--
CO (lb/hr)	29.18	42.0
CO (ton/year) at 500 hr/year	7.30	--
CO (lb/MMBtu)	0.014	--
VOC (ppmvd)	1.08	--
VOC (ppm@15%O ₂)	0.86	6
VOC (ppm@15%O ₂ &ISO)	0.92	--
VOC (lb/hr)	2.40	19.6
VOC (ton/year) at 500 hr/year	0.60	--
VOC (lb/MMBtu)	0.001	--
Sulfur (wt%)	0.0008	0.0015
NH ₃ (ppmvd)	1.25	--
NH ₃ (ppm@15%O ₂)	0.99	5
Opacity (%)	0	10
CO ₂ (%)	5.44	--
O ₂ (%)	13.45	--

The results of all measured pollutant emissions were below the required limits. All testing was performed without any real or apparent errors. All testing was conducted according to the approved testing protocol. Total hydrocarbons (THC) were report as VOC.

3.0 SOURCE OPERATION

3.1 PROCESS DESCRIPTION

Florida Power and Light (FPL) owns and operates the West County Energy Center (West County) located at 20505 State Road 80 in Loxahatchee, Florida. West County is a nominal 3,750 megawatt (MW) greenfield power plant and consists of three combined cycle units (Unit 1, 2 and 3). Each combined cycle unit consists of: three nominal 250 MW Mitsubishi Model 501G combustion turbine-electrical generator (CTGs) sets with evaporative inlet cooling systems; three supplementary-fired heat recovery steam generators (HRSGs) with selective catalytic reduction (SCR) reactors; one nominal 428 million British thermal units per hour (MMBtu/hour) based on low heat value (LHV) natural gas-fired duct burner (DB) located within each of the three HRSG's; and a common nominal 500 MW steam turbine-electrical generator (STG). The total nominal generating capacity of each of the "3 on 1" combined cycle unit is approximately 1,250 MW.

Each CTG has a nominal heat input rate of 2,333 MMBtu/hr when firing natural gas and 2,117 MMBtu/hr when firing distillate fuel oil (based on a compressor inlet air temperature of 59 degrees Fahrenheit (°F), the lower heating value (LHV) of each fuel, and 100 percent load), includes an automated gas turbine control system, and has dual-fuel capability of firing natural gas as the primary fuel or ultra-low sulfur distillate (ULSD) fuel oil as a restricted alternate fuel. Each HRSG recovers exhaust, heat energy from each of the CTGs. Each Unit delivers steam to each STG. The efficient combustion of natural gas and restricted firing of ULSD fuel oil minimizes the emissions of carbon monoxide (CO), particulate matter (PM), sulfuric acid mist (H₂SO₄), sulfur dioxide (SO₂) and volatile organic compounds (VOCs). Dry Low-NOx (DLN) combustors for gas firing and water injection for oil firing reduce nitrogen oxides (NOx) emissions. A selective catalyst reduction (SCR) system further reduces NOx emissions.

3.2 SAMPLING LOCATION

The 501G stack is circular and measures 21.9 feet (ft) (263 inches) in diameter at the test ports which are approximately 138 ft above grade level with an exit elevation of approximately 150 ft above grade level. The test ports are located approximately 44.3 ft (531 inches) downstream and approximately 12 ft (144 inches) upstream from the nearest disturbances. All exhaust samples for gaseous emissions were continuously drawn from the exhaust system at the sample ports from 12 points (three points per port) determined after conducting a stratification test (Appendix F). During the stratification test three points were traversed from each of the four ports. The probe was allowed to remain at a point for two times the system response time. For NH₃ testing, an initial velocity traverse was performed across the stack at base load from 24 total points. All NH₃ sampling occurred from the same 24 points by leaving the probe at each for an equal amount of time. All opacity observations were made by viewing the point where the exhaust system exited to the atmosphere at the top of the exhaust stack.

4.0 SAMPLING AND ANALYTICAL PROCEDURES

4.1 TEST METHODS

The emission test on the Mitsubishi, Model 501G, Unit 3C at the West County Energy Center was performed following United States Environmental Protection Agency (EPA) methods described by the Code of Federal Regulations (CFR). Table 4.1 outlines the specific methods performed on April 7, 2011.

**TABLE 4.1
SUMMARY OF SAMPLING METHODS**

Pollutant or Parameter	Sampling Method	Analysis Method
Sample Point Location	EPA Method 1	Equal Area Method
Stack Flow Rate	EPA Method 2	Pitot
Oxygen	EPA Method 3a	Paramagnetic Cell
Carbon Dioxide	EPA Method 3a	Nondispersive Infrared Analyzer
Nitrogen Oxides	EPA Method 7e	Chemiluminescent Analyzer
Opacity	EPA Method 9	Visual Observation
Carbon Monoxide	EPA Method 10	Nondispersive Infrared Analyzer
Stack Flow Rate	EPA Method 19	Dry Oxygen F Factor
Total Hydrocarbons	EPA Method 25a	Flame Ionization Detector
Ammonia Slip	EPA CTM-027	Ion Chromatography M350.3
Sulfur Content Analysis	ASTM D 5453	Fuel Gas Sample and Laboratory Analysis

4.2 INSTRUMENT CONFIGURATION AND OPERATIONS FOR GAS ANALYSIS

The sampling and analysis procedures used during these tests conform with the methods outlined in the Code of Federal Regulations (CFR), Title 40, Part 60, Appendix A, Methods 1, 2, 3a, 7e, 9, 10, 19, 25a, and Conditional Test Method (CTM)-027.

Figure 4.1 depicts the sample system used for the NO_x, CO, THC, CO₂, and O₂ tests. A stainless steel probe was inserted into the sample ports of the stack to extract gas measurements from the emission stream at twelve points in the stack. The gas sample was continuously pulled through the probe and transported, via heat-traced Teflon® tubing, to a stainless steel minimum-contact condenser designed to dry the sample. Transportation of the sample, through Teflon® tubing, continued into the sample manifold within the mobile laboratory via a stainless steel/Teflon® diaphragm pump. From the manifold, the sample was partitioned to the NO_x, CO, CO₂, and O₂ analyzers through rotameters that controlled the flow rate of the sample. Exhaust samples were routed to the THC analyzer prior to gas conditioning.

Figure 4.1 shows that the sample system was also equipped with a separate path through which a calibration gas could be delivered to the probe and back through the entire sampling system. This allowed for convenient performance of system bias checks as required by the testing methods.

All instruments were housed in an air-conditioned, trailer-mounted mobile laboratory. Gaseous calibration standards were provided in aluminum cylinders with the concentrations certified by the vendor. EPA Protocol No. 1 was used to determine the cylinder concentrations where applicable (i.e. NO_x calibration gases).

Table 4.2 provides a description of the analyzers used for the instrument portion of the tests. All data from the continuous monitoring instruments were recorded on a Logic Beach Portable Data Logging System Hyperlogger which retrieves calibrated electronic data from each instrument every one second and reports an average of the collected data every 30 seconds. Data records can be found in Appendix A and B of this report.

Figure 4.2 represents the sample system used for the wet chemistry tests (NH₃). A heated stainless steel probe with an inconel liner and stainless steel nozzle was inserted into the sample ports of the stack to extract gas measurements from the emission stream through a filter and glass impinger train. Flow rates are monitored with oil filled manometers and total sample volumes are measured with a dry gas meter.

Three test runs of approximately 75 minutes each were conducted on the Mitsubishi, Model 501G, Unit 3C at the maximum test load for NO_x, CO, THC, CO₂, NH₃, opacity, and O₂.

The stack gas analysis for O₂ and CO₂ concentrations was performed in accordance with procedures set forth in EPA Method 3a. The O₂ analyzer uses a paramagnetic cell detector and the CO₂ analyzer uses a continuous nondispersive infrared analyzer.

EPA Method 7e was used to determine concentrations of NO_x. A chemiluminescent analyzer was used to determine the nitrogen oxides concentration in the gas stream. A NO₂ in nitrogen certified gas cylinder was used to verify at least a 90 percent NO₂ conversion on the day of the test.

CO emission concentrations were quantified in accordance with procedures set forth in EPA Method 10. A continuous nondispersive infrared (NDIR) analyzer was used for this purpose.

THC emission concentrations were quantified in accordance with procedures set forth in EPA Method 25a. A continuous flame ionization (FID) analyzer was used for this purpose. THC emission concentrations were reported as VOC.

**TABLE 4.2
ANALYTICAL INSTRUMENTATION**

Parameter	Model and Manufacturer	Range	Sensitivity	Detection Principle
NO _x	THERMO 42i-HL	User may select up to 5,000 ppm	0.1 ppm	Thermal reduction of NO ₂ to NO. Chemiluminescence of reaction of NO with O ₃ . Detection by PMT. Inherently linear for listed ranges.
CO	THERMO 48i	User may select up to 5,000 ppm	0.1 ppm	Infrared absorption, gas filter correlation detector, microprocessor based linearization.
CO ₂	THERMO 410i	0-20%	0.1%	Non-dispersive infrared.
THC	THERMO 51C	User may select up to 10,000 ppm	0.1 ppm	Flame Ionization Detector.
O ₂	THERMO 42i-HL	0-25%	0.1%	Paramagnetic cell, inherently linear.

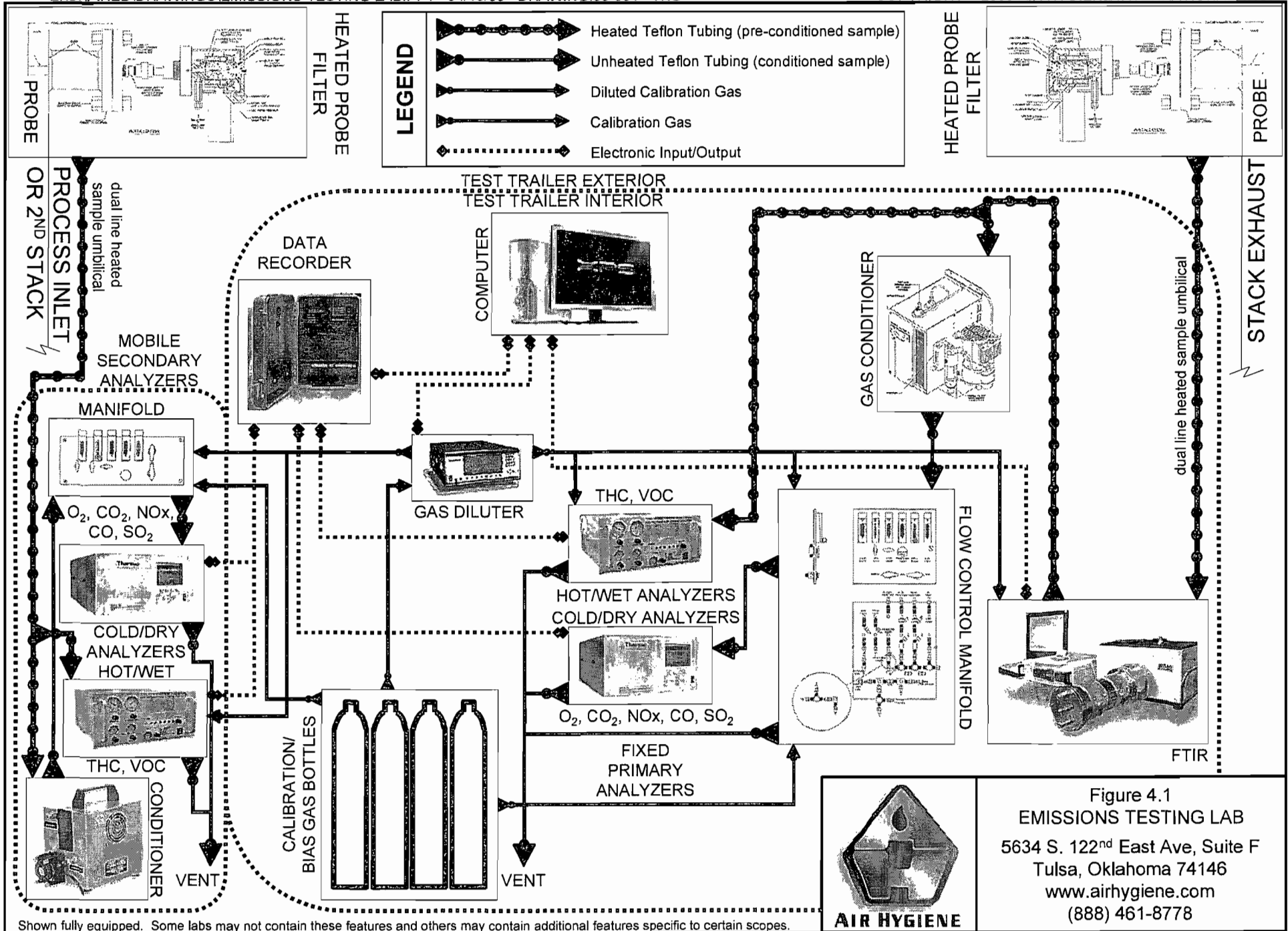

Shown fully equipped. Some labs may not contain these features and others may contain additional features specific to certain scopes.



Figure 4.1
 EMISSIONS TESTING LAB
 5634 S. 122nd East Ave, Suite F
 Tulsa, Oklahoma 74146
 www.airhygiene.com
 (888) 461-8778

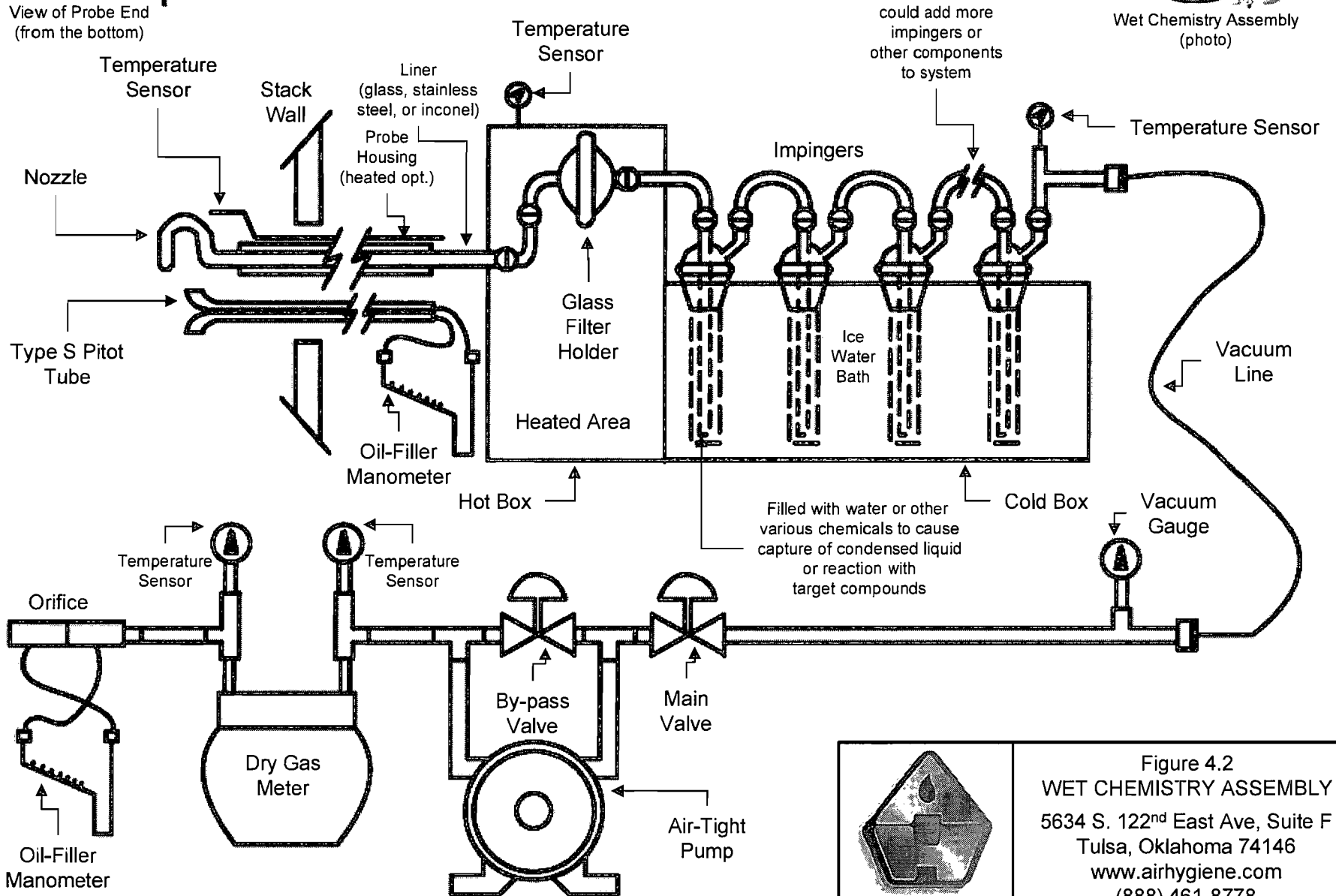
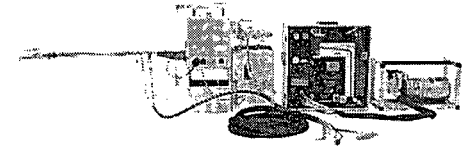
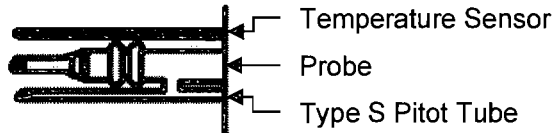

Figure 4.2
WET CHEMISTRY ASSEMBLY
 5634 S. 122nd East Ave, Suite F
 Tulsa, Oklahoma 74146
www.airhygiene.com
 (888) 461-8778

APPENDIX A
TEST RESULTS AND CALCULATIONS

**TABLE A.1:
EMISSIONS TESTING SCHEDULE**

Unit	Load	Test Type	Run	Date	Start	Stop	Time Sync
3C	Fuel Oil	Stratification Test	1	04/07/11	10:48:18	11:39:18	DAHS
3C	Fuel Oil	Compliance	1	04/07/11	12:00:18	13:18:48	DAHS
3C	Fuel Oil	Compliance	2	04/07/11	13:50:18	15:03:48	DAHS
3C	Fuel Oil	Compliance	3	04/07/11	15:25:18	16:38:48	DAHS
3C	Fuel Oil	Preliminaries	Fuel Oil-V1	04/07/11	11:00:00	11:30:00	DAHS
3C	Fuel Oil	Ammonia	Fuel Oil-1	04/07/11	13:00:00	14:20:00	DAHS
3C	Fuel Oil	Ammonia	Fuel Oil-2	04/07/11	14:55:00	16:10:00	DAHS
3C	Fuel Oil	Ammonia	Fuel Oil-3	04/07/11	16:22:00	17:45:00	DAHS
3C	Fuel Oil	Opacity	1	04/07/11	13:00:00	14:00:00	EST
3C	Fuel Oil	Opacity	2	04/07/11	14:00:00	15:00:00	EST
3C	Fuel Oil	Opacity	3	04/07/11	15:00:00	16:00:00	EST

Note: DAHS Time (EST minus 1hr)

TABLE A.2
MITSUBISHI, 501G, UNIT 3C FUEL OIL LOAD DATA SUMMARY

Parameter	Fuel Oil Load, Run - 1	Fuel Oil Load, Run - 2	Fuel Oil Load, Run - 3	Average
Date (mm/dd/yy)	04/07/11	04/07/11	04/07/11	04/07/11
Start Time (hh:mm:ss)	12:00:18	13:50:18	15:25:18	12:00:18
End Time (hh:mm:ss)	13:18:48	15:03:48	16:38:48	16:38:48
Run Duration (min / run)	79	74	74	76
Bar. Pressure (in. Hg)	30.13	30.12	30.10	30.12
Amb. Temp. (°F)	83	82	83	83
Rel. Humidity (%)	59	62	56	59
Spec. Humidity (lb water / lb air)	0.014186	0.014443	0.013463	0.014031
Ammonia Injection Rate (lb/hr)	497.3	486.7	484.5	489.5
Turbine Fuel Flow (gal/hr)	15,612	15,725	15,677	15,671
Total Fuel Flow (SCFH)	2,087	2,102	2,096	2,095
Stack Flow (RM19) (SCFH)	54,267,453	53,486,196	53,078,175	53,610,608
Stack Moisture (% Method 4)	8.9	9.0	8.1	8.7
Heat Input (MMBtu/hr)	2048	2063	2056	2056
Power Output (megawatts)	214.2	213.7	212.8	213.5
NOx (ppmvd)	7.56	7.82	7.63	7.67
NOx (ppm@15%O ₂)	6.08	6.16	5.98	6.08
NOx (ppm@15%O ₂ &ISO)	6.58	6.72	6.39	6.56
NOx (lb/hr)	48.99	49.96	48.37	49.11
NOx (ton/year) at 500 hr/year	12.25	12.49	12.09	12.28
NOx (lb/MMBtu)	0.024	0.024	0.024	0.024
CO (ppmvd)	7.17	7.45	7.85	7.49
CO (ppm@15%O ₂)	5.77	5.87	6.16	5.93
CO (ppm@15%O ₂ &ISO)	6.25	6.40	6.57	6.41
CO (lb/hr)	28.29	28.97	30.28	29.18
CO (ton/year) at 500 hr/year	7.07	7.24	7.57	7.30
CO (lb/MMBtu)	0.014	0.014	0.015	0.014
VOC (ppmvd)	1.32	0.93	0.98	1.08
VOC (ppm@15%O ₂)	1.06	0.73	0.77	0.86
VOC (ppm@15%O ₂ &ISO)	1.15	0.80	0.82	0.92
VOC (lb/hr)	2.98	2.06	2.17	2.40
VOC (ton/year) at 500 hr/year	0.74	0.52	0.54	0.60
VOC (lb/MMBtu)	0.001	0.001	0.001	0.00
Sulfur (wt%)	0.0008	0.0008	0.0008	0.0008
NH ₃ (ppmvd)	1.42	1.57	0.75	1.25
NH ₃ (ppm@15%O ₂)	1.14	1.23	0.59	0.99
Opacity (%)	0	0	0	0
CO ₂ (%)	5.37	5.48	5.46	5.44
O ₂ (%)	13.57	13.41	13.38	13.45

TEST RESULTS

**NO_x, CO, VOC, CO₂, and O₂ Emissions
Fuel Oil Load**

Florida Power and Light
 April 7, 2011
 Mitsubishi, 501G, Unit 3C
 West County Energy Center

Fuel Data

Fuel Fd factor	9,292	SCF exh/MMBtu
Fuel Heating Value (LHV)	981,251	Btu/SCF fuel
Turbine Fuel Flow	15,612	gal/hr

Weather Data

Barometric Pressure	30.13
Relative Humidity	59
Ambient Temperature	83
Specific Humidity	0.014186

Unit Data

Unit Load	214.2	megawatts
Heat Input	2,048	MMBtu/hr
Combustor Inlet Pressure	259	psig
Ammonia Injection Rate	497	lb/hr
Meas. Stack Moisture	8.9	%
Stack Exhaust Flow (M19)	54,267,453	SCFH

Data from: Run 1 NH3

Fuel Oil Load, Run - 1

Date/Time (mm/dd/yy hh:mm:ss)	Elapsed Time (seconds)	O ₂ (%)	NOx (ppmvd)	CO (ppmvd)	VOC (ppmvw)	CO ₂ (%)
04/07/11 12:00:18	18450	13.48	5.77	8.08	1.13	5.37
04/07/11 12:00:48	18480	13.51	6.02	7.88	1.02	5.37
04/07/11 12:01:18	18510	13.54	6.10	8.28	1.01	5.39
04/07/11 12:01:48	18540	13.55	6.48	8.36	0.99	5.38
04/07/11 12:02:18	18570	13.56	6.88	8.35	0.93	5.40
04/07/11 12:02:48	18600	13.56	6.91	7.95	0.91	5.41
04/07/11 12:03:18	18630	13.55	7.02	7.42	0.89	5.41
04/07/11 12:03:48	18660	13.55	7.06	7.04	0.83	5.43
04/07/11 12:04:18	18690	13.57	7.03	7.52	0.82	5.40
04/07/11 12:04:48	18720	13.58	6.85	8.27	0.82	5.41
04/07/11 12:05:18	18750	13.57	6.73	8.15	0.78	5.42
04/07/11 12:05:48	18780	13.56	6.77	7.52	0.79	5.42
04/07/11 12:06:18	18810	13.56	6.81	7.32	0.82	5.44
04/07/11 12:06:48	18840	13.57	6.51	7.40	0.75	5.42
04/07/11 12:07:18	18870	13.60	6.12	7.87	0.72	5.43
04/07/11 12:07:48	18900	13.60	5.94	8.46	0.73	5.41
04/07/11 12:08:18	18930	13.59	5.79	8.57	0.69	5.43
04/07/11 12:08:48	18960	13.56	5.80	8.14	0.70	5.44
04/07/11 12:09:18	18990	13.57	6.07	7.33	0.72	5.44
04/07/11 12:09:48	19020	13.58	6.26	7.33	0.69	5.45
04/07/11 12:10:18	19050	13.58	6.12	7.54	0.68	5.43
04/07/11 12:10:48	19080	13.58	5.96	8.10	0.70	5.44
04/07/11 12:11:18	19110	13.57	5.76	7.82	0.68	5.44
04/07/11 12:11:48	19140	13.57	5.75	7.58	0.67	5.45
04/07/11 12:12:18	19170	13.57	6.06	7.39	0.68	5.45
04/07/11 12:12:48	19200	13.57	6.08	7.33	0.65	5.45
04/07/11 12:13:18	19230	13.58	6.15	7.56	0.67	5.46
04/07/11 12:13:48	19260	13.58	6.15	7.56	0.67	5.44
04/07/11 12:14:18	19290	13.59	6.11	7.45	0.63	5.45
04/07/11 12:14:48	19320	13.59	6.10	7.84	0.64	5.44
04/07/11 12:20:48	19680	13.63	7.77	7.55	5.66	5.40
04/07/11 12:21:18	19710	13.62	7.93	7.38	3.61	5.44
04/07/11 12:21:48	19740	13.60	7.90	7.12	3.18	5.45
04/07/11 12:22:18	19770	13.58	7.67	6.70	2.61	5.46
04/07/11 12:22:48	19800	13.57	7.80	6.31	2.40	5.48
04/07/11 12:23:18	19830	13.57	7.71	6.37	1.99	5.47
04/07/11 12:23:48	19860	13.58	7.54	6.70	1.68	5.48
04/07/11 12:24:18	19890	13.61	6.99	7.62	1.45	5.45
04/07/11 12:24:48	19920	13.62	6.75	7.74	1.34	5.45
04/07/11 12:25:18	19950	13.61	6.57	7.86	1.29	5.45
04/07/11 12:25:48	19980	13.60	6.73	7.63	1.30	5.45
04/07/11 12:26:18	20010	13.61	6.84	7.28	1.21	5.47
04/07/11 12:26:48	20040	13.61	6.34	7.23	1.16	5.46
04/07/11 12:27:18	20070	13.59	6.48	7.30	1.20	5.48
04/07/11 12:27:48	20100	13.57	6.58	7.08	1.14	5.49
04/07/11 12:28:18	20130	13.58	6.75	6.41	1.09	5.49
04/07/11 12:28:48	20160	13.58	6.73	6.67	1.08	5.49
04/07/11 12:29:18	20190	13.59	6.57	7.23	1.04	5.48
04/07/11 12:29:48	20220	13.59	6.39	7.17	1.04	5.50

Florida Power and Light
April 7, 2011
Mitsubishi, 501G, Unit 3C
West County Energy Center

Fuel Data

Fuel Fd factor	9,292	SCF exh/MMBtu
Fuel Heating Value (LHV)	981,251	Btu/SCF fuel
Turbine Fuel Flow	15,612	gal/hr

Weather Data

Barometric Pressure	30.13
Relative Humidity	59
Ambient Temperature	83
Specific Humidity	0.014186

Unit Data

Unit Load	214.2	megawatts
Heat Input	2,048	MMBtu/hr
Combustor Inlet Pressure	259	psig
Ammonia Injection Rate	497	lb/hr
Meas. Stack Moisture	8.9	%
Stack Exhaust Flow (M19)	54,267,453	SCFH

Data from: Run 1 NH3

Fuel Oil Load, Run - 1

Date/Time (mm/dd/yy hh:mm:ss)	Elapsed Time (seconds)	O ₂ (%)	NO _x (ppmvd)	CO (ppmvd)	VOC (ppmvw)	CO ₂ (%)
04/07/11 12:30:18	20250	13.60	6.35	7.14	1.03	5.48
04/07/11 12:30:48	20280	13.60	6.35	7.49	1.00	5.48
04/07/11 12:31:18	20310	13.59	6.33	7.30	0.99	5.50
04/07/11 12:31:48	20340	13.60	6.24	7.08	1.01	5.48
04/07/11 12:32:18	20370	13.60	6.04	6.87	0.98	5.49
04/07/11 12:32:48	20400	13.61	5.97	6.92	0.96	5.49
04/07/11 12:33:18	20430	13.62	5.91	7.04	0.93	5.49
04/07/11 12:33:48	20460	13.62	5.95	7.13	0.91	5.49
04/07/11 12:34:18	20490	13.63	5.93	7.34	0.95	5.49
04/07/11 12:34:48	20520	13.61	5.92	7.16	0.98	5.51
04/07/11 12:35:18	20550	13.60	5.99	6.65	0.94	5.51
04/07/11 12:43:18	21030	13.64	9.20	6.53	0.87	5.47
04/07/11 12:43:48	21060	13.61	9.33	6.28	0.85	5.49
04/07/11 12:44:18	21090	13.58	9.57	5.83	0.89	5.51
04/07/11 12:44:48	21120	13.58	9.86	5.51	0.88	5.53
04/07/11 12:45:18	21150	13.56	9.75	5.63	0.84	5.53
04/07/11 12:45:48	21180	13.57	9.41	5.86	0.85	5.54
04/07/11 12:46:18	21210	13.57	8.97	6.04	0.85	5.54
04/07/11 12:46:48	21240	13.61	8.87	6.34	0.82	5.51
04/07/11 12:47:18	21270	13.61	8.84	7.38	0.83	5.52
04/07/11 12:47:48	21300	13.60	9.07	6.85	0.87	5.51
04/07/11 12:48:18	21330	13.61	9.76	6.26	0.82	5.53
04/07/11 12:48:48	21360	13.61	9.86	6.91	0.82	5.51
04/07/11 12:49:18	21390	13.59	9.66	6.72	0.82	5.53
04/07/11 12:49:48	21420	13.57	9.55	6.18	0.79	5.55
04/07/11 12:50:18	21450	13.60	9.39	6.55	0.80	5.53
04/07/11 12:50:48	21480	13.60	8.44	6.81	0.82	5.54
04/07/11 12:51:18	21510	13.61	7.61	6.86	0.86	5.52
04/07/11 12:51:48	21540	13.61	7.48	7.09	0.81	5.52
04/07/11 12:52:18	21570	13.62	7.42	6.94	0.76	5.53
04/07/11 12:52:48	21600	13.60	7.64	6.52	0.77	5.54
04/07/11 12:53:18	21630	13.60	8.00	6.16	0.79	5.55
04/07/11 12:53:48	21660	13.59	8.16	6.44	0.76	5.54
04/07/11 12:54:18	21690	13.57	8.12	6.48	0.77	5.57
04/07/11 12:54:48	21720	13.58	7.99	6.19	0.79	5.55
04/07/11 12:55:18	21750	13.62	7.58	6.57	0.75	5.55
04/07/11 12:55:48	21780	13.63	7.30	7.34	0.75	5.53
04/07/11 12:56:18	21810	13.63	7.04	7.83	0.75	5.54
04/07/11 12:56:48	21840	13.59	7.04	7.07	0.71	5.57
04/07/11 12:57:18	21870	13.57	7.39	6.21	0.72	5.56
04/07/11 12:57:48	21900	13.59	7.55	7.07	0.75	5.56
04/07/11 13:04:18	22290	13.58	8.84	6.28	4.93	5.56
04/07/11 13:04:48	22320	13.58	8.73	7.32	4.04	5.56
04/07/11 13:05:18	22350	13.55	8.47	7.68	3.59	5.58
04/07/11 13:05:48	22380	13.56	8.51	7.18	2.80	5.60
04/07/11 13:06:18	22410	13.58	8.68	7.24	2.27	5.57
04/07/11 13:06:48	22440	13.58	9.04	7.40	2.12	5.56
04/07/11 13:07:18	22470	13.55	9.11	7.22	2.00	5.59
04/07/11 13:07:48	22500	13.57	9.44	6.81	1.68	5.57

Florida Power and Light
 April 7, 2011
 Mitsubishi, 501G, Unit 3C
 West County Energy Center

Fuel Data

Fuel Fd factor	9,292	SCF exh/MMBtu
Fuel Heating Value (LHV)	981,251	Btu/SCF fuel
Turbine Fuel Flow	15,612	gal/hr

Weather Data

Barometric Pressure	30.13
Relative Humidity	59
Ambient Temperature	83
Specific Humidity	0.014186

Unit Data

Unit Load	214.2	megawatts
Heat Input	2,048	MMBtu/hr
Combustor Inlet Pressure	259	psig
Ammonia Injection Rate	497	lb/hr
Meas. Stack Moisture	8.9	%
Stack Exhaust Flow (M19)	54,267,453	SCFH

Data from: Run 1 NH3

Fuel Oil Load, Run - 1

Date/Time (mm/dd/yy hh:mm:ss)	Elapsed Time (seconds)	O ₂ (%)	NOx (ppmvd)	CO (ppmvd)	VOC (ppmvw)	CO ₂ (%)
04/07/11 13:08:18	22530	13.61	9.72	7.23	1.46	5.58
04/07/11 13:08:48	22560	13.59	9.63	8.20	1.47	5.56
04/07/11 13:09:18	22590	13.54	9.51	7.93	1.39	5.60
04/07/11 13:09:48	22620	13.54	9.67	6.86	1.35	5.60
04/07/11 13:10:18	22650	13.54	9.60	7.23	1.40	5.61
04/07/11 13:10:48	22680	13.51	9.40	6.51	1.31	5.64
04/07/11 13:11:18	22710	13.53	9.02	6.33	2.05	5.63
04/07/11 13:11:48	22740	13.54	8.50	7.29	1.79	5.63
04/07/11 13:12:18	22770	13.58	7.92	7.72	1.37	5.59
04/07/11 13:12:48	22800	13.60	7.83	8.84	1.27	5.58
04/07/11 13:13:18	22830	13.59	7.98	8.41	1.29	5.59
04/07/11 13:13:48	22860	13.56	8.62	6.90	1.27	5.61
04/07/11 13:14:18	22890	13.54	9.28	7.13	1.17	5.62
04/07/11 13:14:48	22920	13.54	9.53	7.43	1.18	5.62
04/07/11 13:15:18	22950	13.54	9.43	6.70	1.17	5.62
04/07/11 13:15:48	22980	13.55	9.12	6.70	1.09	5.61
04/07/11 13:16:18	23010	13.57	8.56	7.12	1.10	5.61
04/07/11 13:16:48	23040	13.58	8.09	7.44	1.08	5.58
04/07/11 13:17:18	23070	13.56	7.65	7.66	1.03	5.61
04/07/11 13:17:48	23100	13.53	7.74	6.74	1.04	5.62
04/07/11 13:18:18	23130	13.54	7.99	6.14	1.03	5.63
04/07/11 13:18:48	23160	13.57	8.12	6.98	0.98	5.61
RAW AVERAGE		13.58	7.58	7.17	1.21	5.51

Bias	O ₂	NOx	CO	VOC	CO ₂
	(%)	(ppmvd)	(ppmvd)	(ppmvw)	(%)
Serial Number:	INST-N2-0001	INST-N2-0001	INST-CO-0015	INST-TH-0012	INST-C2-0009
Initial Zero	0.01	0.03	-0.33	-0.07	-0.01
Final Zero	0.01	0.03	-0.19	-0.07	0.18
Avg. Zero	0.01	0.03	-0.26	-0.07	0.09
Initial UpScale	12.12	12.14	12.31	3.08	8.99
Final UpScale	12.10	12.10	12.23	3.35	9.17
Avg. UpScale	12.11	12.12	12.27	3.22	9.08
Upscale Cal Gas	12.10	12.10	12.10	3.10	8.91

EMISSIONS DATA	O ₂	NOx	CO	VOC	CO ₂
Corrected Raw Average (ppm/% dry basis)	13.57	7.56	7.17	1.32	5.37
Concentration (ppm@ 15%O ₂)	N/A	6.08	5.77	1.06	N/A
Concentration (ppm@ 15%O ₂ & ISO)	N/A	6.58	6.25	1.15	N/A
Emission Rate (lb/hr)	N/A	48.99	28.29	2.98	N/A
Emission Rate (tons/year) at 500 hr/yr	N/A	12.25	7.07	0.74	N/A
Emission Rate (lb/MMBtu)	N/A	0.024	0.014	0.001	N/A

Florida Power and Light
 April 7, 2011
 Mitsubishi, 501G, Unit 3C
 West County Energy Center

Fuel Data

Fuel Fd factor	9,292	SCF exh/MMBtu
Fuel Heating Value (LHV)	981,251	Btu/SCF fuel
Turbine Fuel Flow	15,725	gal/hr

Weather Data

Barometric Pressure	30.12
Relative Humidity	62
Ambient Temperature	82
Specific Humidity	0.014443

Unit Data

Unit Load	213.7	megawatts
Heat Input	2,063	MMBtu/hr
Combustor Inlet Pressure	258	psig
Ammonia Injection Rate	487	lb/hr
Meas. Stack Moisture	9.0	%
Stack Exhaust Flow (M19)	53,486,196	SCFH

Data from: Run 2 NH3

Fuel Oil Load, Run - 2

Date/Time (mm/dd/yy hh:mm:ss)	Elapsed Time (seconds)	O ₂ (%)	NOx (ppmvd)	CO (ppmvd)	VOC (ppmvw)	CO ₂ (%)
04/07/11 13:50:18	25050	13.49	8.77	13.00	0.76	5.67
04/07/11 13:50:48	25080	13.49	9.00	11.46	0.78	5.69
04/07/11 13:51:18	25110	13.50	9.13	7.91	0.75	5.68
04/07/11 13:51:48	25140	13.49	8.94	7.05	0.77	5.70
04/07/11 13:52:18	25170	13.48	8.44	7.15	0.80	5.69
04/07/11 13:52:48	25200	13.50	8.26	7.54	0.78	5.68
04/07/11 13:53:18	25230	13.53	8.14	7.58	0.78	5.68
04/07/11 13:53:48	25260	13.52	8.34	7.62	0.81	5.66
04/07/11 13:54:18	25290	13.49	8.65	7.50	0.80	5.70
04/07/11 13:54:48	25320	13.47	9.09	6.92	0.77	5.70
04/07/11 13:55:18	25350	13.52	9.37	7.92	0.81	5.69
04/07/11 13:55:48	25380	13.51	9.42	8.00	0.83	5.68
04/07/11 13:56:18	25410	13.50	9.41	7.05	0.79	5.69
04/07/11 13:56:48	25440	13.52	9.29	7.42	0.76	5.67
04/07/11 13:57:18	25470	13.51	9.20	7.37	0.79	5.69
04/07/11 13:57:48	25500	13.49	9.32	6.80	0.77	5.70
04/07/11 13:58:18	25530	13.49	9.52	6.76	0.74	5.71
04/07/11 13:58:48	25560	13.49	9.63	7.26	0.75	5.70
04/07/11 13:59:18	25590	13.51	9.45	7.42	0.75	5.69
04/07/11 13:59:48	25620	13.50	8.97	7.34	0.72	5.71
04/07/11 14:00:18	25650	13.50	8.64	6.89	0.73	5.69
04/07/11 14:00:48	25680	13.51	8.42	6.90	0.75	5.71
04/07/11 14:01:18	25710	13.51	8.40	6.99	0.72	5.68
04/07/11 14:01:48	25740	13.51	8.29	7.27	0.72	5.70
04/07/11 14:02:18	25770	14.02	8.33	6.90	0.91	5.32
04/07/11 14:02:48	25800	13.49	8.45	6.46	0.69	5.70
04/07/11 14:03:18	25830	13.49	8.64	6.51	0.71	5.73
04/07/11 14:03:48	25860	13.49	8.83	6.33	0.69	5.71
04/07/11 14:04:18	25890	13.50	8.74	6.87	0.65	5.72
04/07/11 14:04:48	25920	13.49	8.42	7.08	0.65	5.71
04/07/11 14:09:18	26190	13.48	10.14	6.28	0.68	5.72
04/07/11 14:09:48	26220	13.47	10.34	6.75	0.68	5.74
04/07/11 14:10:18	26250	13.48	10.26	6.90	0.66	5.73
04/07/11 14:10:48	26280	13.48	9.77	6.68	0.66	5.73
04/07/11 14:11:18	26310	13.50	9.42	7.14	0.66	5.74
04/07/11 14:11:48	26340	13.49	9.01	7.35	0.62	5.73
04/07/11 14:12:18	26370	13.46	8.91	6.89	0.65	5.76
04/07/11 14:12:48	26400	13.45	9.14	6.30	0.68	5.75
04/07/11 14:13:18	26430	13.47	9.37	6.70	0.64	5.76
04/07/11 14:13:48	26460	13.46	9.34	7.14	0.64	5.74
04/07/11 14:14:18	26490	13.44	9.10	6.60	0.66	5.78
04/07/11 14:14:48	26520	13.45	8.85	6.33	0.63	5.78
04/07/11 14:15:18	26550	13.50	8.60	6.82	0.72	5.75
04/07/11 14:15:48	26580	13.52	8.40	8.55	0.72	5.72
04/07/11 14:16:18	26610	13.51	8.36	9.38	0.67	5.72
04/07/11 14:16:48	26640	13.48	8.79	8.03	0.67	5.76
04/07/11 14:17:18	26670	13.47	8.78	7.02	0.68	5.76
04/07/11 14:17:48	26700	13.46	8.69	6.81	0.64	5.78
04/07/11 14:18:18	26730	13.44	8.53	7.03	0.64	5.78

Florida Power and Light
 April 7, 2011
 Mitsubishi, 501G, Unit 3C
 West County Energy Center

Fuel Data

Fuel Fd factor	9,292	SCF exh/MMBtu
Fuel Heating Value (LHV)	981,251	Btu/SCF fuel
Turbine Fuel Flow	15,725	gal/hr

Weather Data

Barometric Pressure	30.12
Relative Humidity	62
Ambient Temperature	82
Specific Humidity	0.014443

Unit Data

Unit Load	213.7	megawatts
Heat Input	2,063	MMBtu/hr
Combustor Inlet Pressure	258	psig
Ammonia Injection Rate	487	lb/hr
Meas. Stack Moisture	9.0	%
Stack Exhaust Flow (M19)	53,486,196	SCFH

Data from: Run 2 NH3

Fuel Oil Load, Run - 2

Date/Time (mm/dd/yy hh:mm:ss)	Elapsed Time (seconds)	O ₂ (%)	NOx (ppmvd)	CO (ppmvd)	VOC (ppmvw)	CO ₂ (%)
04/07/11 14:18:48	26760	13.47	8.51	7.09	0.68	5.77
04/07/11 14:19:18	26790	13.49	8.48	7.59	0.65	5.75
04/07/11 14:19:48	26820	13.45	8.38	7.59	0.62	5.78
04/07/11 14:20:18	26850	13.47	8.28	6.85	0.65	5.78
04/07/11 14:20:48	26880	13.47	8.44	7.11	0.66	5.76
04/07/11 14:21:18	26910	13.48	8.65	7.24	0.68	5.76
04/07/11 14:21:48	26940	13.46	8.43	7.13	0.68	5.77
04/07/11 14:22:18	26970	13.49	8.11	7.36	0.65	5.77
04/07/11 14:22:48	27000	13.49	7.98	7.53	0.62	5.76
04/07/11 14:23:18	27030	13.50	7.95	7.03	0.65	5.76
04/07/11 14:23:48	27060	13.49	7.98	6.77	0.69	5.77
04/07/11 14:29:18	27390	13.54	6.68	6.85	0.90	5.75
04/07/11 14:29:48	27420	13.54	6.83	7.55	0.84	5.73
04/07/11 14:30:18	27450	13.54	6.70	7.62	0.85	5.76
04/07/11 14:30:48	27480	13.51	6.66	7.21	0.79	5.76
04/07/11 14:31:18	27510	13.51	6.82	7.17	0.76	5.78
04/07/11 14:31:48	27540	13.51	6.96	7.26	0.76	5.77
04/07/11 14:32:18	27570	13.51	6.98	7.28	0.75	5.76
04/07/11 14:32:48	27600	13.51	6.97	7.40	0.70	5.78
04/07/11 14:33:18	27630	13.51	6.83	7.27	0.71	5.77
04/07/11 14:33:48	27660	13.51	6.76	7.49	0.72	5.79
04/07/11 14:34:18	27690	13.51	6.85	7.78	0.69	5.77
04/07/11 14:34:48	27720	13.51	6.78	7.48	0.71	5.78
04/07/11 14:35:18	27750	13.52	6.66	7.53	0.70	5.77
04/07/11 14:35:48	27780	13.52	6.71	7.71	0.67	5.77
04/07/11 14:36:18	27810	13.51	6.62	7.29	0.71	5.78
04/07/11 14:36:48	27840	13.50	6.18	7.17	0.72	5.78
04/07/11 14:37:18	27870	13.51	6.18	7.00	0.69	5.81
04/07/11 14:37:48	27900	13.50	6.09	7.40	0.69	5.79
04/07/11 14:38:18	27930	13.51	6.08	7.38	0.71	5.81
04/07/11 14:38:48	27960	13.51	6.05	7.43	0.67	5.79
04/07/11 14:39:18	27990	13.50	5.89	7.64	0.66	5.80
04/07/11 14:39:48	28020	13.49	5.85	7.24	0.69	5.81
04/07/11 14:40:18	28050	13.49	5.92	6.79	0.68	5.80
04/07/11 14:40:48	28080	13.49	6.17	7.07	0.67	5.80
04/07/11 14:41:18	28110	13.49	6.00	7.42	0.75	5.78
04/07/11 14:41:48	28140	13.51	5.93	7.21	0.70	5.79
04/07/11 14:42:18	28170	13.51	5.86	7.31	0.69	5.78
04/07/11 14:42:48	28200	13.51	5.89	7.42	0.71	5.80
04/07/11 14:43:18	28230	13.51	6.02	7.38	0.69	5.78
04/07/11 14:43:48	28260	13.50	6.07	7.72	0.68	5.79
04/07/11 14:49:18	28590	13.51	7.66	8.69	2.89	5.78
04/07/11 14:49:48	28620	13.48	7.83	7.56	1.97	5.82
04/07/11 14:50:18	28650	13.48	8.20	7.01	1.96	5.81
04/07/11 14:50:48	28680	13.47	8.47	7.39	1.84	5.84
04/07/11 14:51:18	28710	13.47	8.47	7.03	2.09	5.83
04/07/11 14:51:48	28740	13.49	8.42	6.98	2.03	5.83
04/07/11 14:52:18	28770	13.52	7.98	7.23	1.90	5.80
04/07/11 14:52:48	28800	13.51	7.49	8.17	1.57	5.81

Florida Power and Light
April 7, 2011
Mitsubishi, 501G, Unit 3C
West County Energy Center

Fuel Data

Fuel Fd factor	9,292	SCF exh/MMBtu
Fuel Heating Value (LHV)	981,251	Btu/SCF fuel
Turbine Fuel Flow	15,725	gal/hr

Weather Data

Barometric Pressure	30.12
Relative Humidity	62
Ambient Temperature	82
Specific Humidity	0.014443

Unit Data

Unit Load	213.7	megawatts
Heat Input	2,063	MMBtu/hr
Combustor Inlet Pressure	258	psig
Ammonia Injection Rate	487	lb/hr
Meas. Stack Moisture	9.0	%
Stack Exhaust Flow (M19)	53,486,196	SCFH

Data from: Run 2 NH3

Fuel Oil Load, Run - 2

Date/Time (mm/dd/yy hh:mm:ss)	Elapsed Time (seconds)	O ₂ (%)	NO _x (ppmvd)	CO (ppmvd)	VOC (ppmvw)	CO ₂ (%)
04/07/11 14:53:18	28830	13.60	7.24	7.72	1.53	5.76
04/07/11 14:53:48	28860	13.65	7.19	7.07	1.66	5.70
04/07/11 14:54:18	28890	13.72	7.31	6.71	1.37	5.67
04/07/11 14:54:48	28920	13.74	7.48	7.06	1.12	5.64
04/07/11 14:55:18	28950	13.70	7.35	6.94	1.06	5.68
04/07/11 14:55:48	28980	13.67	7.36	7.11	1.06	5.69
04/07/11 14:56:18	29010	13.64	7.39	7.24	1.03	5.72
04/07/11 14:56:48	29040	13.78	7.33	6.96	1.10	5.63
04/07/11 14:57:18	29070	13.79	6.31	7.14	1.11	5.61
04/07/11 14:57:48	29100	13.79	5.87	7.39	1.06	5.61
04/07/11 14:58:18	29130	13.81	5.75	7.65	1.08	5.58
04/07/11 14:58:48	29160	13.82	5.69	7.33	1.10	5.59
04/07/11 14:59:18	29190	13.85	5.83	6.93	1.04	5.56
04/07/11 14:59:48	29220	13.78	5.92	6.67	1.02	5.61
04/07/11 15:00:18	29250	13.76	6.01	7.05	1.04	5.61
04/07/11 15:00:48	29280	15.14	5.86	7.60	1.43	5.03
04/07/11 15:01:18	29310	13.93	5.60	6.58	0.97	5.05
04/07/11 15:01:48	29340	13.71	5.38	7.15	1.00	5.67
04/07/11 15:02:18	29370	13.72	5.71	6.92	0.98	5.67
04/07/11 15:02:48	29400	13.73	5.88	6.76	0.93	5.65
04/07/11 15:03:18	29430	13.74	5.81	7.22	0.93	5.66
04/07/11 15:03:48	29460	13.72	5.57	8.06	0.94	5.65
RAW AVERAGE		13.56	7.72	7.31	0.87	5.72

Bias	Serial Number:	O ₂	NO _x	CO	VOC	CO ₂
		(%)	(ppmvd)	(ppmvd)	(ppmvw)	(%)
	INST-N2-0001	0.01	0.03	-0.19	-0.07	0.18
	INST-N2-0001	0.56	0.04	-0.40	0.07	0.40
	INST-CO-0015	0.29	0.04	-0.30	0.00	0.29
	INST-TH-0012	12.10	12.10	12.23	3.35	9.17
	INST-C2-0009	12.42	11.76	11.87	3.08	9.06
		12.26	11.93	12.05	3.22	9.12
	Upscale Cal Gas	12.10	12.10	12.10	3.10	8.91

EMISSIONS DATA	O ₂	NO _x	CO	VOC	CO ₂
Corrected Raw Average (ppm/% dry basis)	13.41	7.82	7.45	0.93	5.48
Concentration (ppm@ 15%O ₂)	N/A	6.16	5.87	0.73	N/A
Concentration (ppm@ 15%O ₂ & ISO)	N/A	6.72	6.40	0.80	N/A
Emission Rate (lb/hr)	N/A	49.96	28.97	2.06	N/A
Emission Rate (tons/year) at 500 hr/yr	N/A	12.49	7.24	0.52	N/A
Emission Rate (lb/MMBtu)	N/A	0.024	0.014	0.001	N/A

Florida Power and Light
 April 7, 2011
 Mitsubishi, 501G, Unit 3C
 West County Energy Center

Fuel Data

Fuel Fd factor	9,292	SCF exh/MMBtu
Fuel Heating Value (LHV)	981,251	Btu/SCF fuel
Turbine Fuel Flow	15,677	gal/hr

Weather Data

Barometric Pressure	30.10
Relative Humidity	56
Ambient Temperature	83
Specific Humidity	0.013463

Unit Data

Unit Load	212.8	megawatts
Heat Input	2,056	MMBtu/hr
Combustor Inlet Pressure	258	psig
Ammonia Injection Rate	484	lb/hr
Meas. Stack Moisture	8.1	%
Stack Exhaust Flow (M19)	53,078,175	SCFH

Data from: Run 3 NH3

Fuel Oil Load, Run - 3

Date/Time (mm/dd/yy hh:mm:ss)	Elapsed Time (seconds)	O ₂ (%)	NOx (ppmvd)	CO (ppmvd)	VOC (ppmvw)	CO ₂ (%)
04/07/11 15:25:18	30750	13.75	6.45	6.89	1.15	5.61
04/07/11 15:25:48	30780	13.76	6.34	7.26	1.12	5.64
04/07/11 15:26:18	30810	13.75	6.22	7.75	1.10	5.63
04/07/11 15:26:48	30840	13.74	6.15	7.47	1.06	5.66
04/07/11 15:27:18	30870	13.75	6.36	6.96	1.01	5.65
04/07/11 15:27:48	30900	13.75	6.57	6.98	1.03	5.65
04/07/11 15:28:18	30930	13.76	6.44	7.47	0.98	5.65
04/07/11 15:28:48	30960	13.76	6.25	7.58	0.95	5.64
04/07/11 15:29:18	30990	13.76	6.40	7.27	0.96	5.67
04/07/11 15:29:48	31020	13.75	6.48	6.89	0.92	5.65
04/07/11 15:30:18	31050	13.76	6.66	7.01	0.92	5.67
04/07/11 15:30:48	31080	13.76	6.62	7.30	0.93	5.65
04/07/11 15:31:18	31110	13.75	6.62	7.50	0.88	5.68
04/07/11 15:31:48	31140	13.78	6.67	7.29	0.88	5.65
04/07/11 15:32:18	31170	13.94	6.55	7.34	0.96	5.58
04/07/11 15:32:48	31200	14.08	5.97	7.45	0.94	5.44
04/07/11 15:33:18	31230	14.07	5.55	7.41	0.92	5.45
04/07/11 15:33:48	31260	14.04	5.50	7.31	0.93	5.47
04/07/11 15:34:18	31290	14.02	5.55	7.21	0.90	5.48
04/07/11 15:34:48	31320	14.04	5.63	7.12	0.88	5.48
04/07/11 15:35:18	31350	14.01	5.46	7.06	0.90	5.49
04/07/11 15:35:48	31380	14.02	5.52	6.76	0.88	5.51
04/07/11 15:36:18	31410	14.04	5.48	6.95	0.89	5.48
04/07/11 15:36:48	31440	14.15	5.33	7.94	0.94	5.41
04/07/11 15:37:18	31470	14.09	5.13	8.38	0.91	5.45
04/07/11 15:37:48	31500	14.07	5.07	7.82	0.90	5.45
04/07/11 15:38:18	31530	14.13	5.30	7.28	0.93	5.44
04/07/11 15:38:48	31560	14.10	5.48	8.05	0.90	5.42
04/07/11 15:39:18	31590	14.10	5.52	8.34	0.89	5.45
04/07/11 15:39:48	31620	14.06	5.62	7.70	0.90	5.45
04/07/11 15:44:18	31890	13.52	7.12	9.26	2.07	5.85
04/07/11 15:44:48	31920	13.50	7.29	9.65	2.68	5.88
04/07/11 15:45:18	31950	13.47	7.65	8.60	2.54	5.89
04/07/11 15:45:48	31980	13.45	8.32	7.12	2.30	5.91
04/07/11 15:46:18	32010	13.46	8.75	7.43	1.91	5.92
04/07/11 15:46:48	32040	13.45	8.73	7.25	1.56	5.92
04/07/11 15:47:18	32070	13.45	8.60	7.32	1.59	5.94
04/07/11 15:47:48	32100	13.43	8.14	7.39	1.46	5.93
04/07/11 15:48:18	32130	13.43	7.79	6.88	1.12	5.96
04/07/11 15:48:48	32160	13.45	7.47	6.86	1.02	5.93
04/07/11 15:49:18	32190	13.50	7.06	8.47	0.98	5.89
04/07/11 15:49:48	32220	13.47	6.72	9.77	0.93	5.89
04/07/11 15:50:18	32250	13.45	6.75	8.39	0.93	5.94
04/07/11 15:50:48	32280	13.44	7.01	7.44	0.92	5.95
04/07/11 15:51:18	32310	13.42	7.16	8.12	0.87	5.95
04/07/11 15:51:48	32340	13.44	7.32	8.01	0.88	5.96
04/07/11 15:52:18	32370	13.52	7.43	8.33	0.91	5.89
04/07/11 15:52:48	32400	13.47	6.26	9.15	0.84	5.92
04/07/11 15:53:18	32430	13.45	5.90	8.61	0.85	5.92

Florida Power and Light
April 7, 2011
Mitsubishi, 501G, Unit 3C
West County Energy Center

Fuel Data

Fuel Fd factor	9,292	SCF exh/MMBtu
Fuel Heating Value (LHV)	981,251	Btu/SCF fuel
Turbine Fuel Flow	15,677	gal/hr

Weather Data

Barometric Pressure	30.10
Relative Humidity	56
Ambient Temperature	83
Specific Humidity	0.013463

Unit Data

Unit Load	212.8	megawatts
Heat Input	2,056	MMBtu/hr
Combustor Inlet Pressure	258	psig
Ammonia Injection Rate	484	lb/hr
Meas. Stack Moisture	8.1	%
Stack Exhaust Flow (M19)	53,078,175	SCFH

Data from: Run 3 NH3

Fuel Oil Load, Run - 3

Date/Time (mm/dd/yy hh:mm:ss)	Elapsed Time (seconds)	O ₂ (%)	NOx (ppmvd)	CO (ppmvd)	VOC (ppmvw)	CO ₂ (%)
04/07/11 15:53:48	32460	13.43	6.22	7.88	0.86	5.96
04/07/11 15:54:18	32490	13.45	6.42	7.50	0.81	5.96
04/07/11 15:54:48	32520	13.43	6.41	7.93	0.82	5.97
04/07/11 15:55:18	32550	13.44	6.34	7.81	0.82	5.98
04/07/11 15:55:48	32580	13.42	6.22	7.81	0.78	5.98
04/07/11 15:56:18	32610	13.43	6.06	7.62	0.80	5.99
04/07/11 15:56:48	32640	13.44	5.91	7.88	0.84	5.96
04/07/11 15:57:18	32670	13.47	5.79	8.54	0.78	5.96
04/07/11 15:57:48	32700	13.47	5.63	9.18	0.79	5.94
04/07/11 15:58:18	32730	13.45	5.77	8.71	0.79	5.96
04/07/11 15:58:48	32760	13.44	5.96	8.06	0.76	5.98
04/07/11 16:05:18	33150	13.49	8.10	7.71	0.71	5.92
04/07/11 16:05:48	33180	13.50	7.70	7.99	0.71	5.90
04/07/11 16:06:18	33210	13.50	7.68	8.48	0.67	5.92
04/07/11 16:06:48	33240	13.48	8.11	7.99	0.66	5.93
04/07/11 16:07:18	33270	13.45	8.86	7.25	0.68	5.95
04/07/11 16:07:48	33300	13.44	9.62	6.94	0.67	5.97
04/07/11 16:08:18	33330	13.45	9.90	7.09	0.65	5.95
04/07/11 16:08:48	33360	13.46	9.76	7.21	0.67	5.96
04/07/11 16:09:18	33390	13.44	9.41	7.60	0.66	5.95
04/07/11 16:09:48	33420	13.43	9.06	6.80	0.62	5.97
04/07/11 16:10:18	33450	13.46	8.96	6.76	0.63	5.95
04/07/11 16:10:48	33480	13.47	8.69	7.48	0.65	5.95
04/07/11 16:11:18	33510	13.46	7.66	7.59	0.63	5.96
04/07/11 16:11:48	33540	13.45	7.59	7.33	0.63	5.96
04/07/11 16:12:18	33570	13.45	7.92	6.87	0.64	5.98
04/07/11 16:12:48	33600	13.45	8.23	6.83	0.60	5.96
04/07/11 16:13:18	33630	13.55	8.15	7.23	0.64	5.92
04/07/11 16:13:48	33660	13.64	7.91	7.40	0.69	5.84
04/07/11 16:14:18	33690	13.74	7.67	6.85	0.70	5.79
04/07/11 16:14:48	33720	13.78	7.58	6.74	0.70	5.73
04/07/11 16:15:18	33750	13.79	7.49	6.70	0.73	5.73
04/07/11 16:15:48	33780	14.05	7.55	6.40	0.78	5.58
04/07/11 16:16:18	33810	14.12	7.10	6.03	0.77	5.48
04/07/11 16:16:48	33840	14.16	6.78	6.55	0.82	5.47
04/07/11 16:17:18	33870	14.17	6.46	7.49	0.81	5.44
04/07/11 16:17:48	33900	14.14	6.20	7.78	0.76	5.47
04/07/11 16:18:18	33930	14.12	6.34	6.57	0.78	5.48
04/07/11 16:18:48	33960	14.14	6.55	6.32	0.77	5.48
04/07/11 16:19:18	33990	14.19	6.60	6.71	0.77	5.45
04/07/11 16:19:48	34020	14.19	6.76	7.19	0.77	5.45
04/07/11 16:24:18	34290	13.71	8.17	7.53	0.75	5.81
04/07/11 16:24:48	34320	13.70	8.06	7.54	0.78	5.81
04/07/11 16:25:18	34350	13.68	8.35	7.26	0.75	5.81
04/07/11 16:25:48	34380	13.61	8.67	6.77	0.76	5.88
04/07/11 16:26:18	34410	13.58	8.96	6.10	0.75	5.89
04/07/11 16:26:48	34440	13.60	9.03	6.45	0.72	5.90
04/07/11 16:27:18	34470	13.59	8.60	6.97	0.75	5.89
04/07/11 16:27:48	34500	13.60	8.24	7.74	0.75	5.91

Florida Power and Light
 April 7, 2011
 Mitsubishi, 501G, Unit 3C
 West County Energy Center

Fuel Data

Fuel Fd factor	9,292	SCF exh/MMBtu
Fuel Heating Value (LHV)	981,251	Btu/SCF fuel
Turbine Fuel Flow	15,677	gal/hr

Weather Data

Barometric Pressure	30.10
Relative Humidity	56
Ambient Temperature	83
Specific Humidity	0.013463

Unit Data

Unit Load	212.8	megawatts
Heat Input	2,056	MMBtu/hr
Combustor Inlet Pressure	258	psig
Ammonia Injection Rate	484	lb/hr
Meas. Stack Moisture	8.1	%
Stack Exhaust Flow (M19)	53,078,175	SCFH

Data from: Run 3 NH3

Fuel Oil Load, Run - 3

Date/Time (mm/dd/yy hh:mm:ss)	Elapsed Time (seconds)	O ₂ (%)	NOx (ppmvd)	CO (ppmvd)	VOC (ppmvw)	CO ₂ (%)
04/07/11 16:28:18	34530	13.65	8.00	9.15	0.73	5.85
04/07/11 16:28:48	34560	13.63	8.05	9.81	0.76	5.87
04/07/11 16:29:18	34590	13.61	8.68	8.38	0.75	5.89
04/07/11 16:29:48	34620	13.59	9.17	7.20	0.72	5.93
04/07/11 16:30:18	34650	13.78	9.37	6.88	0.78	5.80
04/07/11 16:30:48	34680	13.72	9.11	6.94	0.74	5.81
04/07/11 16:31:18	34710	13.74	8.90	7.60	0.72	5.80
04/07/11 16:31:48	34740	13.73	8.66	8.08	0.74	5.78
04/07/11 16:32:18	34770	13.75	8.66	7.56	0.72	5.80
04/07/11 16:32:48	34800	13.76	8.95	6.66	0.68	5.79
04/07/11 16:33:18	34830	13.75	9.15	7.21	0.70	5.78
04/07/11 16:33:48	34860	13.76	9.05	8.05	0.69	5.78
04/07/11 16:34:18	34890	13.74	8.82	7.79	0.66	5.79
04/07/11 16:34:48	34920	13.73	8.69	7.16	0.66	5.80
04/07/11 16:35:18	34950	13.83	8.61	6.95	0.70	5.75
04/07/11 16:35:48	34980	13.88	8.50	6.60	0.67	5.71
04/07/11 16:36:18	35010	13.90	8.24	6.71	0.68	5.68
04/07/11 16:36:48	35040	13.90	7.94	7.68	0.67	5.69
04/07/11 16:37:18	35070	13.90	7.63	7.58	0.64	5.69
04/07/11 16:37:48	35100	13.86	7.78	7.15	0.63	5.73
04/07/11 16:38:18	35130	13.86	8.17	6.26	0.66	5.72
04/07/11 16:38:48	35160	13.87	8.47	6.30	0.65	5.72
RAW AVERAGE		13.70	7.33	7.49	0.88	5.77

RAW AVERAGE

	O ₂ (%)	NOx (ppmvd)	CO (ppmvd)	VOC (ppmvw)	CO ₂ (%)
Serial Number:	INST-N2-0001	INST-N2-0001	INST-CO-0015	INST-TH-0012	INST-C2-0009
Initial Zero	0.56	0.04	-0.40	0.07	0.40
Final Zero	0.89	0.00	-0.42	-0.10	0.58
Avg. Zero	0.73	0.02	-0.41	-0.02	0.49
Bias					
Initial UpScale	12.42	11.76	11.87	3.08	9.06
Final UpScale	12.51	11.48	11.66	3.04	9.13
Avg. UpScale	12.47	11.62	11.77	3.06	9.10
Upscale Cal Gas	12.10	12.10	12.10	3.10	8.91

EMISSIONS DATA	O ₂	NOx	CO	VOC	CO ₂
Corrected Raw Average (ppm/% dry basis)	13.38	7.63	7.85	0.98	5.46
Concentration (ppm@ 15%O ₂)	N/A	5.98	6.16	0.77	N/A
Concentration (ppm@ 15%O ₂ & ISO)	N/A	6.39	6.57	0.82	N/A
Emission Rate (lb/hr)	N/A	48.37	30.28	2.17	N/A
Emission Rate (tons/year) at 500 hr/yr	N/A	12.09	7.57	0.54	N/A
Emission Rate (lb/MMBtu)	N/A	0.024	0.015	0.001	N/A

TEST RESULTS

**NH₃ Emissions
Fuel Oil Load**

CTM 027 (AMMONIA) SOURCE SAMPLING TITLE PAGE

Source Information	
Plant Name	West County Energy Center
Sampling Location	Unit 3C
Fuel Type	Oil, Distillate

Test Information			
Project #		bv-10-westcounty.fl-comp#2	
Operator		MV	
Date for Preliminary Run	(mm/dd/yy)	04/07/11	
Standard Temperature		68	°F
Standard Pressure		29.92	in Hg
Required Sample Vol.	indust. spec.	35	scf
Run Duration	chk Subpart	60	minutes
Unit Number		3C	
Base Run Number		Fuel Oil	
Number of Ports Available		4	
Number of Ports Used		4	
Port Inside Diameter		6.00	in
Stack Shape		Circular	

Test Equipment Information					
Run		1	2	3	
Test Date	(mm/dd/yy)	04/07/11	04/07/11	04/07/11	
Load	% or w/DB	Fuel Oil	Fuel Oil	Fuel Oil	
Fuel F-Factor		9292.34	9292.34	9292.34	dscf/MMBtu
Meter Box Number	from ACS	SAMP-CP-0010	SAMP-CP-0010	SAMP-CP-0010	
Meter Calibration Factor	(Y)	0.991	0.991	0.991	
Orifice Meter Coefficient	(ΔH_{or})	1.745	1.745	1.745	in H ₂ O
Pitot Identification	from ACS	SAMP-HP-0001	SAMP-HP-0001	SAMP-HP-0001	
Pitot Tube Coefficient	(C _p)	0.840	0.840	0.840	
Nozzle Number	from ACS	18	18	18	
Nozzle Diameter	(D _n)	0.230	0.230	0.230	in
Probe Number	from ACS	SAMP-HP-0001	SAMP-HP-0001	SAMP-HP-0001	
Probe Length		120.0	120.0	120.0	in
(SS, Glass) Liner Material	from list	inconel	inconel	inconel	
Sample Case / Oven Number	from ACS	SAMP-BH-0025	SAMP-BH-0025	SAMP-BH-0025	
Impinger Case Number	from ACS	SAMP-BC-0021	SAMP-BC-0019	SAMP-BC-0021	

Testing Company Information	
Company Name	Air Hygiene International, Inc. (Tulsa, Oklahoma)
Address	5634 S. 122nd East Avenue, Suite F
City, State Zip	Tulsa, Oklahoma 74146
Project Manager	Jake Fahlenkamp
Phone Number	(918) 307-8865
Fax Number	(918) 307-9131

METHOD 1 - SAMPLE AND VELOCITY TRAVERSES FOR CIRCULAR SOURCES

Plant Name	West County Energy Center	Date	04/07/11
Sampling Location	Unit 3C	Stack Type	Circular
Operator	MV	Ports Available	4
Project #	bv-10-westcounty.fl-comp#2	Ports Used	4
Stack Size	Large (>24 inch diameter)	Port ID (inches)	6.00

Circular Stack or Duct Diameter			
Distance to Far Wall of Stack	(L _{fw})	282.38	in
Distance to Near Wall of Stack	(L _{nw})	19.00	in
Diameter of Stack	(D)	263.38	in
Area of Stack	(A _s)	378.35	ft ²

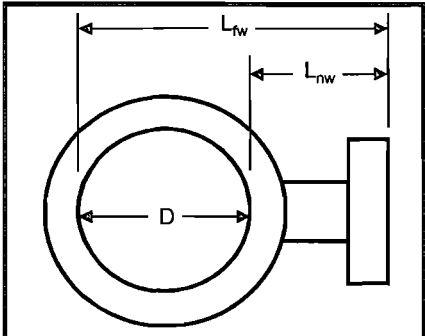

Distance from Port to Disturbances			
Distance Upstream	(A)	144.00	in
Diameters Upstream	(A _D)	0.55	diameters
Distance Downstream	(B)	531.75	in
Diameters Downstream	(B _D)	2.02	diameters

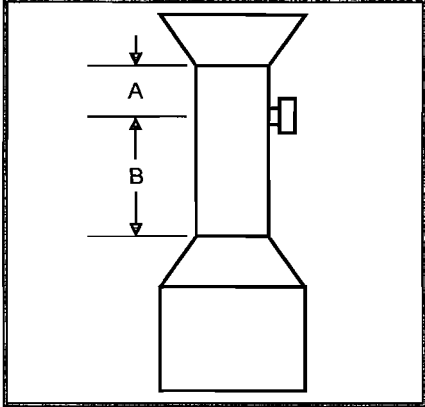

Number of Traverse Points Required			
Diameters to Flow Disturbance		Minimum Number of ¹ Traverse Points	
Down Stream	Up Stream	Particulate Points	Velocity Points
2.00-4.99	0.50-1.24	24	16
5.00-5.99	1.25-1.49	20	16
6.00-6.99	1.50-1.74	16	12
7.00-7.99	1.75-1.99	12	12
>= 8.00	>=2.00	8 or 12 ²	8 or 12 ²
Upstream Spec		24	16
Downstream Spec		24	16
Traverse Pts Required		24	16

¹ Check Minimum Number of Points for the Upstream and Downstream conditions, then use the largest.
² 8 for Circular Stacks 12 to 24 inches
 12 for Circular Stacks over 24 inches

Number of Traverse Points Used			
4	Ports by	6	Across
24	Pts Used	24	Required

Method 1 Tra 12 Point PM Tra Velocity

Location of Traverse Points in Circular Stacks										
Traverse Point Number	(Fraction of Stack Dimension from Inside Wall to Traverse Point)									
	Number of Traverse Points Across the Stack									
	2	4	6	8	10	12	14	16	18	
1	.146	.087	.044	.032	.026	.021	.018	.016	.014	
2	.854	.250	.146	.105	.082	.067	.057	.049	.044	
3		.750	.296	.194	.146	.118	.099	.085	.075	
4		.933	.704	.323	.226	.177	.146	.125	.109	
5			.854	.677	.342	.250	.201	.169	.146	
6			.956	.808	.658	.356	.269	.220	.188	
7				.895	.774	.644	.366	.283	.236	
8				.968	.854	.750	.634	.375	.296	
9					.918	.823	.731	.625	.382	
10					.974	.882	.799	.717	.618	
11						.933	.854	.780	.704	
12						.979	.901	.831	.764	

Traverse Point Locations			
Traverse Point Number	Fraction of Stack Diameter	Distance from Inside Wall	Distance Including Reference Length
		in	in
1	0.021	5 4/8	24 4/8
2	0.067	17 5/8	36 5/8
3	0.118	31 1/8	50 1/8
4	0.177	46 5/8	65 5/8
5	0.250	65 7/8	84 7/8
6	0.356	93 6/8	112 6/8
7			
8			
9			

METHOD 2 - DETERMINATION OF STACK GAS VELOCITY AND VOLUMETRIC FLOW RATE

Plant Name	West County Energy Center			
Sampling Location	Unit 3C			
Operator	MV			
Project #	bv-10-westcounty.fl-comp#2			
Pitot Leak Check	x	PreTest	x	PostTest

Stack Dimensions			
Area of Stack	(A _s)	378.35	ft ²
Diameter of Stack	(D)	263.38	in

Pressures			
Barometric Pressure	(P _b)	30.10	in Hg
Static Pressure	(P _{static})	0.75	in H ₂ O
Absolute Stack Pressure	(P _s)	30.16	in Hg

Stack Gas Composition			
Composition Data:		Actual Composition	
Carbon Dioxide Concentration	(%CO ₂)	5.44	%vd
Oxygen Concentration	(%O ₂)	13.45	%vd
Carbon Monoxide Concentration	(ppmCO)	7.49	ppmvd
Nitrogen Concentration	(%N ₂)	81.11	%vd
Stack Moisture Content	(B _{ws})	8.68	%
Stack Dry Molecular Weight	(M _d)	29.41	lb/lb-mole
Stack Wet Molecular Weight	(M _w)	28.42	lb/lb-mole

Results			
Avg Stack Gas Velocity	(V _s)	53.07	ft/sec
Avg Stack Dry Std Flow Rate	(Q _{sd})	47,708,581	dscf/hr
Avg Stack Dry Std Flow Rate	(Q _{sd})	795,143	dscf/min
Avg Stack Wet Flow Rate	(Q _{aw})	1,204,814	acfm
Avg Stack Wet Std Flow Rate	(Q _{sw})	52,243,300	ascf/hr

40 CFR 60, Method 2G, Section 8.11.1 (but applies to all Method 2 type static pressure measurements):
 If a Type S probe is used for this measurement, position the probe at or between any traverse point(s) and rotate the probe until a null differential pressure reading is obtained. Disconnect the tubing from one of the pressure ports; read and record the ΔP. For pressure devices with one-directional scales, if a deflection in the positive direction is noted with the negative side disconnected, then the static pressure is positive. Likewise, if a deflection in the positive direction is noted with the positive side disconnected, then the static pressure is negative.

Stack Cross Section Schematic	

Date	04/07/11		
Stack Type	Circular		
Ports Available	4		
Pitot Identification	SAMP-HP-0001		
Pitot Coefficient	0.840		

Velocity Traverse Data				
Run Number		Fuel Oil-V1		
Run Time	11:00	Start	11:30	End
Traverse Point	Velocity Head (Δp)	Null Angle (N _a)	Stack Temp (t _s)	Local Velocity (V _{sn})
	in H ₂ O	deg	°F	ft/sec
A-1	0.65	0	271	53.47
A-2	0.63	0	274	52.75
A-3	0.60	0	272	51.41
A-4	0.64	0	270	53.02
A-5	0.62	0	269	52.15
A-6	0.55	0	267	49.05
B-1	0.55	0	281	49.52
B-2	0.60	0	280	51.69
B-3	0.65	0	279	53.76
B-4	0.65	0	278	53.73
B-5	0.66	0	278	54.14
B-6	0.65	0	277	53.69
C-1	0.70	0	285	56.02
C-2	0.68	0	282	55.10
C-3	0.60	0	281	51.73
C-4	0.61	0	280	52.12
C-5	0.75	0	278	57.71
C-6	0.77	0	274	58.32
D-1	0.60	0	286	51.90
D-2	0.60	0	278	51.62
D-3	0.62	0	276	52.40
D-4	0.63	0	275	52.79
D-5	0.62	0	275	52.37
D-6	0.65	0	266	53.29
Average	0.64	0	276	= Square roots of Δp
	0.80			

METHOD 3a - DETERMINATION OF DRY MOLECULAR WEIGHT BY ANALYZER

Plant Name	West County Energy Center	Date	04/07/11		
Sampling Location	Unit 3C	Operator	MV		
Project #	bv-10-westcounty.fl-comp#2	# of Ports Used	1 (gas probe)		
Fuel Type	Oil, Distillate	Min. Fuel Factor	1.260	Max. Fuel Factor	1.413

Gas Analysis Data								
Run Number	Fuel Oil-1		Run Start Time		13:00	Run Stop Time		14:20
Sample Analysis Time	CO ₂ Conc.	O ₂ Conc.	CO Conc.	N ₂ Conc.	Dry Molecular Weight	Calculated Fuel Factor	Excess Air	Fuel Factor in Range
	(%CO ₂)	(%O ₂)	(ppmCO)	(%N ₂)	(M _d)	(F _o) _{avg}	(%EA) _{avg}	
hh:mm	%	%	ppm	%	lb/lb-mole		%	
01:20	5.4	13.6	7.2	81.1	29.40	1.365	173.3	YES

Gas Analysis Data								
Run Number	Fuel Oil-2		Run Start Time		14:55	Run Stop Time		16:10
Sample Analysis Time	CO ₂ Conc.	O ₂ Conc.	CO Conc.	N ₂ Conc.	Dry Molecular Weight	Calculated Fuel Factor	Excess Air	Fuel Factor in Range
	(%CO ₂)	(%O ₂)	(ppmCO)	(%N ₂)	(M _d)	(F _o) _{avg}	(%EA) _{avg}	
hh:mm	%	%	ppm	%	lb/lb-mole		%	
01:15	5.5	13.4	7.5	81.1	29.41	1.367	167.6	YES

Gas Analysis Data								
Run Number	Fuel Oil-3		Run Start Time		16:22	Run Stop Time		17:45
Sample Analysis Time	CO ₂ Conc.	O ₂ Conc.	CO Conc.	N ₂ Conc.	Dry Molecular Weight	Calculated Fuel Factor	Excess Air	Fuel Factor in Range
	(%CO ₂)	(%O ₂)	(ppmCO)	(%N ₂)	(M _d)	(F _o) _{avg}	(%EA) _{avg}	
hh:mm	%	%	ppm	%	lb/lb-mole		%	
01:23	5.5	13.4	7.9	81.2	29.41	1.377	166.3	YES

METHOD 4 - DETERMINATION OF MOISTURE CONTENT IN STACK GASES

Plant Name	West County Energy Center	Date	04/07/11
Sampling Location	Unit 3C	Operator	MV
Project #	bv-10-westcounty.fl-comp#2	Ports Used	4

Moisture Content Data								
Run Number	Fuel Oil-1		Run Start Time		13:00	Run Stop Time		14:20
Meter Box Number	SAMP-CP-0010				Meter Cal Factor	(Y)	0.991	
Total Meter Volume	(V _m)	39.270	dcf	Barometric Pressure	(P _b)	30.10	in Hg	
Average Stack Temp	(t _s) _{avg}	246	°F	Stack Static Pressure	(P _{static})	0.75	in H ₂ O	
Average Meter Temp	(t _m) _{avg}	81	°F	Avg Orifice Pressure	(ΔH) _{avg}	1.19	in H ₂ O	
	Impinger 1	Impinger 2	Impinger 3	Impinger 4	Impinger 5	Impinger 6	Impinger 7	Impinger 8
	(g)	(g)	(g)	(g)				
Contents	H ₂ SO ₄	H ₂ SO ₄	-	Sil Gel				
Final Value	(V _i),(W _i)	808.70	762.10	611.10	828.10			
Initial Value	(V _i),(W _i)	748.20	752.70	608.10	821.20			
Net Value	(V _n),(W _n)	60.5	9.4	3.0	6.9			
Results								
Total Weight	(W _i)	79.80	g	Water Vol Weighed	(V _{wsg(std)})	3.763	scf	
Std Meter Volume	(V _{m(std)})	38.312	dscf	Sat. Moisture Content	(B _{ws(svp)})	100.00	%	
Calc Moisture Content	(B _{ws(calc)})	8.94	%	Final Moisture Content	(B _{ws})	8.94	%	

Moisture Content Data								
Run Number	Fuel Oil-2		Run Start Time		14:55	Run Stop Time		16:10
Meter Box Number	SAMP-CP-0010				Meter Cal Factor	(Y)	0.991	
Total Meter Volume	(V _m)	40.950	dcf	Barometric Pressure	(P _b)	30.12	in Hg	
Average Stack Temp	(t _s) _{avg}	245	°F	Stack Static Pressure	(P _{static})	0.72	in H ₂ O	
Average Meter Temp	(t _m) _{avg}	84	°F	Avg Orifice Pressure	(ΔH) _{avg}	1.43	in H ₂ O	
	Impinger 1	Impinger 2	Impinger 3	Impinger 4	Impinger 5	Impinger 6	Impinger 7	Impinger 8
	(g)	(g)	(g)	(g)				
Contents	H ₂ SO ₄	H ₂ SO ₄	-	Sil Gel				
Final Value	(V _i),(W _i)	810.60	777.40	617.90	867.00			
Initial Value	(V _i),(W _i)	747.30	768.70	614.50	858.70			
Net Value	(V _n),(W _n)	63.3	8.7	3.4	8.3			
Results								
Total Weight	(W _i)	83.70	g	Water Vol Weighed	(V _{wsg(std)})	3.946	scf	
Std Meter Volume	(V _{m(std)})	39.759	dscf	Sat. Moisture Content	(B _{ws(svp)})	100.00	%	
Calc Moisture Content	(B _{ws(calc)})	9.03	%	Final Moisture Content	(B _{ws})	9.03	%	

Moisture Content Data								
Run Number	Fuel Oil-3		Run Start Time		16:22	Run Stop Time		17:45
Meter Box Number	SAMP-CP-0010				Meter Cal Factor	(Y)	0.991	
Total Meter Volume	(V _m)	40.510	dcf	Barometric Pressure	(P _b)	30.08	in Hg	
Average Stack Temp	(t _s) _{avg}	245	°F	Stack Static Pressure	(P _{static})	0.71	in H ₂ O	
Average Meter Temp	(t _m) _{avg}	84	°F	Avg Orifice Pressure	(ΔH) _{avg}	1.39	in H ₂ O	
	Impinger 1	Impinger 2	Impinger 3	Impinger 4	Impinger 5	Impinger 6	Impinger 7	Impinger 8
	(g)	(g)	(g)	(g)				
Contents	H ₂ SO ₄	H ₂ SO ₄	-	Sil Gel				
Final Value	(V _i),(W _i)	804.10	760.10	609.20	826.20			
Initial Value	(V _i),(W _i)	742.20	748.90	609.20	826.20			
Net Value	(V _n),(W _n)	61.9	11.2	0.0	0.0			
Results								
Total Weight	(W _i)	73.10	g	Water Vol Weighed	(V _{wsg(std)})	3.447	scf	
Std Meter Volume	(V _{m(std)})	39.331	dscf	Sat. Moisture Content	(B _{ws(svp)})	100.00	%	
Calc Moisture Content	(B _{ws(calc)})	8.06	%	Final Moisture Content	(B _{ws})	8.06	%	

CTM 027 (AMMONIA) SOURCE SAMPLING TITLE PAGE ISOKINETIC SAMPLING DATA

Plant Name	West County Energy Center
Sampling Location	Unit 3C
Project #	bv-10-westcounty.fl-comp#2

Date	04/07/11
Operator	MV
Run Number	Fuel Oil-1

Ideal Nozzle Diameter and IsoKinetic Factor Setup			
Pitot Coefficient	(C _p)	0.840	
Average Stack Temp	(t _s)	245.5	"F
Average Meter Temp	(t _m)	81.1	
Orifice Meter Coefficient	(K _o)	1.745	in H ₂ O
Square Root ΔP	(ΔP ^{1/2} _{avg})	0.80	in H ₂ O
Stack Moisture Content	(B _w)	8.94	%
Stack Dry Molecular Weight	(M _d)	29.40	lb/lb-mole
Estimated Orifice Flow Rate	(Q _o)	0.75	acfm
ΔP to ΔH Isokinetic Factor	(K)	1.92	

Leak Checks					
Train	Pre	0.000	ft ³ /min@	15.0	in Hg
PASS	Post	0.000	ft ³ /min@	15.0	in Hg
Pitot	Pre (+)	5.0	in H ₂ O for	30.0	sec
	Pre (-)	5.0	in H ₂ O for	30.0	sec
PASS	Post (+)	5.0	in H ₂ O for	30.0	sec
	Post (-)	5.0	in H ₂ O for	30.0	sec

Sampling Equipment			
Meter Box Number	SAMP-CP-0010		
Meter Cal Factor	(Y)	0.991	
Nozzle Number	I8		
Average Nozzle Diameter	(D _{no})	0.2300	in
Suggested Nozzle Diameter	(D _{no})	0.2268	in
Probe Number	SAMP-HP-0001		in
Probe Length	120		in
Liner Material	Inconel		
Sample Case / Oven Number	SAMP-BH-0025		
Impinger Case Number	SAMP-BC-0021		

Pressures			
Barometric Pressure	(P _b)	30.10	in Hg
Stack Static Pressure	(P _{static})	0.75	in H ₂ O
Absolute Stack Pressure	(P _s)	30.16	in Hg
Absolute Meter Pressure	(P _m)	30.23	in Hg

Nozzle Measurements				
Pre	0.230	0.230	0.230	PASS
Post	0.230	0.230	0.230	PASS

Run Time			
Start	13:00	End	14:20

Weights	Imp 1	Imp 2	Imp 3	Imp 4	Imp 5	Imp 6	Imp 7	Imp 8
Pre	748.2	752.7	608.1	821.2				
Post	808.7	762.1	811.1	828.1				

Wash Volumes					ml

Traverse Point #	Sampling Time (θ)	Timer Time	Dry Gas Meter Reading (V _m)	Velocity Head (Δp)	Desired Orifice ΔH (ΔH _d)	Actual Orifice ΔH (ΔH _a)	Stack Temp (t _s)	Probe Temp (248±25°F)	Filter Temp (248±25°F)	Impinger Exit Temp (568°F)	Cond. Temp (5-°F)	CPM Filter Temp (-2-°F)	Meter Inlet Temp (t _m)	Meter Outlet Temp (t _{mo})	Pump Vacuum	Square Root ΔP (ΔP ^{1/2})	Local Stack Velocity (v _{sh})	Cumul. Meter Volume (V _m) _{tot}	Cumul. Percent IsoKinetic (I)	Est-Run Meter Volume (V _m) _{est}
	min	hh:mm:ss	ft ³	in H ₂ O	in H ₂ O	in H ₂ O	°F	°F	°F	°F	°F	°F	°F	°F	in Hg	√(in H ₂ O)	ft/sec	dscf	%	dscf
A-1	0.0	00:00:00	142.450	0.65	1.251	1.20	245	234	244	67			79	75	3.5	0.81	52.55	1.871	107.0	40.112
A-2	2.5	00:02:30	144.150	0.63	1.212	1.20	246	233	248	68			78	74	3.0	0.79	51.77	3.287	108.1	39.440
A-3	5.0	00:05:00	145.790	0.60	1.155	1.10	242	235	241	67			79	76	3.0	0.77	50.38	4.809	104.5	38.470
A-4	7.5	00:07:30	147.340	0.64	1.232	1.20	241	235	240	63			84	75	3.0	0.80	51.99	6.482	105.3	38.892
A-5	10.0	00:10:00	149.050	0.62	1.193	1.20	243	236	241	64			83	75	3.0	0.79	51.25	8.157	106.2	39.153
A-6	12.5	00:12:30	150.760	0.55	1.058	1.10	241	235	242	64			82	76	3.0	0.74	48.20	9.704	106.4	38.817
B-1	15.0	00:15:00	152.340	0.55	1.058	1.10	249	240	248	65			83	76	2.0	0.74	48.47	11.201	106.1	38.404
B-2	17.5	00:17:30	153.870	0.60	1.155	1.10	245	241	247	66			83	76	2.0	0.77	50.48	12.942	107.5	38.827
B-3	20.0	00:20:00	155.650	0.65	1.251	1.20	244	242	246	67			84	76	2.5	0.81	52.51	14.575	107.1	38.867
B-4	22.5	00:22:30	157.320	0.85	1.251	1.20	243	242	248	66			83	77	2.5	0.81	52.47	16.139	106.4	38.735
B-5	25.0	00:25:00	158.920	0.66	1.270	1.20	244	243	249	67			83	76	2.5	0.81	52.91	17.637	105.5	38.480
B-6	27.5	00:27:30	160.450	0.65	1.251	1.20	245	242	248	68			84	76	2.5	0.81	52.55	19.181	104.9	38.363
C-1	30.0	00:30:00	162.030	0.70	1.347	1.30	252	232	239	68			84	78	3.0	0.84	54.80	20.831	104.7	38.457
C-2	32.5	00:32:30	163.720	0.68	1.309	1.30	251	238	237	67			86	77	3.0	0.82	53.97	22.450	104.5	38.485
C-3	35.0	00:35:00	165.380	0.60	1.155	1.10	249	240	237	65			89	78	2.5	0.77	50.63	23.974	104.3	38.359
C-4	37.5	00:37:30	166.950	0.61	1.174	1.10	247	242	238	66			88	79	2.5	0.78	50.98	25.625	104.7	38.438
C-5	40.0	00:40:00	168.650	0.75	1.443	1.40	245	233	237	67			88	78	3.5	0.87	56.44	27.376	104.6	38.649
C-6	42.5	00:42:30	170.450	0.77	1.482	1.40	243	233	238	68			89	79	3.5	0.88	57.11	29.066	104.3	38.754
D-1	45.0	00:45:00	172.190	0.60	1.155	1.10	249	235	242	68			86	80	2.5	0.77	50.63	30.553	104.1	38.593
D-2	47.5	00:47:30	173.720	0.60	1.155	1.10	248	237	241	65			87	80	2.5	0.77	50.59	32.078	104.0	38.493
D-3	50.0	00:50:00	175.290	0.62	1.193	1.10	246	239	244	64			88	81	2.5	0.79	51.36	33.667	104.0	38.477
D-4	52.5	00:52:30	176.930	0.63	1.212	1.20	246	233	240	64			87	80	2.5	0.79	51.77	35.260	104.0	38.466
D-5	55.0	00:55:00	178.570	0.62	1.193	1.20	245	236	235	65			89	80	2.5	0.79	51.32	36.754	103.7	38.352
D-6	57.5	00:57:30	180.110	0.85	1.251	1.20	243	237	237	66			89	81	2.5	0.81	52.47	38.313	103.6	38.313
Last Pt	60.0	01:00:00	181.720																	
Final Val	60.0	01:00:00	181.720																	
Average Values				0.64		1.19	246	237	242	66			85	77	3.5	0.80	51.98	38.313	103.6	

CTM 027 (AMMONIA) SOURCE SAMPLING TITLE PAGE ISOKINETIC SAMPLING DATA

Plant Name	West County Energy Center
Sampling Location	Unit 3C
Project #	bv-10-westcounty.fl-comp#2

Date	04/07/11
Operator	MV
Run Number	Fuel Oil-2

Ideal Nozzle Diameter and IsoKinetic Factor Setup			
Pitot Coefficient	(C _p)	0.840	
Average Stack Temp	(t _s)	244.5	*F
Average Meter Temp	(t _m)	84.4	
Orifice Meter Coefficient	(K)	1.745	in H ₂ O
Square Root ΔP	(ΔP ^{0.5})	0.86	in H ₂ O
Stack Moisture Content	(B _w)	9.03	%
Stack Dry Molecular Weight	(M _d)	29.41	lb/lb-mole
Estimated Orifice Flow Rate	(Q _m)	0.64	acfm
ΔP to ΔH Isokinetic Factor	(K)	1.94	

Leak Checks					
Train	Pre	0.000	R ³ /min@	15.0	in Hg
PASS	Post	0.000	R ³ /min@	15.0	in Hg
Pitot	Pre (+)	5.0	in H ₂ O for	30.0	sec
	Pre (-)	5.0	in H ₂ O for	30.0	sec
	Post (+)	5.0	in H ₂ O for	30.0	sec
	Post (-)	5.0	in H ₂ O for	30.0	sec

Sampling Equipment			
Meter Box Number	SAMP-CP-0010		
Meter Cal Factor	(Y)	0.991	
Nozzle Number	18		
Average Nozzle Diameter	(D _n)	0.2300	in
Suggested Nozzle Diameter	(D _s)	0.2048	in
Probe Number	SAMP-HP-0001		in
Probe Length	120		in
Liner Material	Inconel		
Sample Case / Oven Number	SAMP-BH-0025		
Impinger Case Number	SAMP-BC-0019		

Nozzle Measurements				
Pre	0.230	0.230	0.230	PASS
Post	0.230	0.230	0.230	PASS

Pressures			
Barometric Pressure	(P _b)	30.12	in Hg
Stack Static Pressure	(P _{static})	0.72	in H ₂ O
Absolute Stack Pressure	(P _a)	30.17	in Hg
Absolute Meter Pressure	(P _m)	30.25	in Hg

Run Time			
Start	14:55	End	16:10

Weights	Imp 1	Imp 2	Imp 3	Imp 4	Imp 5	Imp 6	Imp 7	Imp 8
Pre	747.3	768.7	614.5	858.7				
Post	810.6	777.4	617.9	867.0				

Wash Volumes					ml
					ml

Traverse Point #	Sampling Time (h)	Timer Time	Dry Gas Meter Reading (V _m)	Velocity Head (ΔP)	Desired Orifice ΔH (ΔH _d)	Actual Orifice ΔH (ΔH _a)	Stack Temp (t _s)	Probe Temp (248±25°F)	Filter Temp (248±25°F)	Impinger Exit Temp (≤68°F)	Cond. Temp (≤-°F)	CPM Filter Temp (-±-°F)	Meter Inlet Temp (t _m)	Meter Outlet Temp (t _m)	Pump Vacuum	Square Root ΔP (ΔP ^{0.5})	Local Stack Velocity (v _s)	Cumul. Meter Volume (V _m) _{std}	Cumul. Percent IsoKinetic (I)	Est-Run Meter Volume (V _m) _{std}	
	min	hh:mm:ss	R ³	in H ₂ O	in H ₂ O	in H ₂ O	*F	*F	*F	*F	*F	*F	*F	*F	in Hg	√(in H ₂ O)	ft/sec	dsf	%	dsf	
A-1	0.0	00:00:00	182.050	0.66	1.277	1.30	249	233	243	68			86	80	3.0	0.81	53.08	1.654	105.5	39.704	
A-2	2.5	00:02:30	183.750	0.70	1.355	1.30	248	234	245	67			85	81	3.0	0.84	54.63	3.318	104.2	39.821	
A-3	5.0	00:05:00	185.460	0.70	1.355	1.30	249	237	244	68			86	80	3.0	0.84	54.67	4.973	103.6	39.782	
A-4	7.5	00:07:30	187.160	0.69	1.336	1.30	248	236	245	67			87	81	3.0	0.83	54.24	6.546	102.3	39.278	
A-5	10.0	00:10:00	188.780	0.71	1.374	1.40	247	238	241	68			86	80	3.0	0.84	54.98	8.191	102.0	39.319	
A-6	12.5	00:12:30	190.470	0.62	1.200	1.20	235	233	244	68			87	80	3.0	0.79	50.94	9.737	101.8	38.948	
B-1	15.0	00:15:00	192.060	0.75	1.452	1.40	249	238	239	67			88	81	3.0	0.87	56.59	11.504	102.4	39.441	
B-2	17.5	00:17:30	193.880	0.78	1.510	1.50	248	237	240	67			89	82	3.0	0.88	57.67	13.219	102.1	39.657	
B-3	20.0	00:20:00	195.650	0.77	1.490	1.50	245	236	241	67			88	81	3.0	0.88	57.17	14.889	101.7	39.704	
B-4	22.5	00:22:30	197.370	0.78	1.510	1.50	244	235	240	68			89	82	3.5	0.88	57.50	16.504	101.6	39.850	
B-5	25.0	00:25:00	199.140	0.83	1.607	1.60	245	237	242	67			88	81	3.5	0.91	59.36	18.343	101.3	40.021	
B-6	27.5	00:27:30	200.930	0.88	1.703	1.70	244	236	241	68			87	82	3.5	0.94	61.08	20.091	100.8	40.183	
C-1	30.0	00:30:00	202.730	0.80	1.548	1.50	245	246	240	68			89	81	3.5	0.89	58.28	21.857	100.9	40.351	
C-2	32.5	00:32:30	204.550	0.85	1.645	1.60	244	243	241	67			88	82	3.5	0.92	60.03	23.700	101.1	40.629	
C-3	35.0	00:35:00	208.450	0.87	1.684	1.70	245	247	238	68			89	81	3.5	0.93	60.77	25.428	100.7	40.685	
C-4	37.5	00:37:30	208.230	0.88	1.703	1.70	243	239	250	67			88	82	3.5	0.94	61.03	27.097	100.2	40.646	
C-5	40.0	00:40:00	209.950	0.87	1.684	1.70	248	241	247	65			87	81	3.5	0.93	60.82	28.789	99.8	40.643	
C-6	42.5	00:42:30	211.690	0.81	1.568	1.60	245	243	248	66			88	83	3.5	0.90	58.64	30.631	100.2	40.841	
D-1	45.0	00:45:00	213.590	0.61	1.181	1.20	244	247	249	67			85	81	3.0	0.78	50.85	32.285	100.6	40.781	
D-2	47.5	00:47:30	215.290	0.57	1.103	1.10	243	236	244	60			89	81	2.0	0.75	49.12	33.952	101.3	40.742	
D-3	50.0	00:50:00	217.010	0.60	1.161	1.20	242	231	228	58			89	81	2.0	0.77	50.36	35.250	100.7	40.286	
D-4	52.5	00:52:30	218.350	0.67	1.297	1.30	241	227	223	58			89	81	2.5	0.82	53.18	36.895	100.3	40.031	
D-5	55.0	00:55:00	219.840	0.68	1.316	1.30	241	228	232	58			89	81	2.5	0.82	53.58	38.353	100.5	40.021	
D-6	57.5	00:57:30	221.550	0.72	1.394	1.40	239	231	228	58			89	81	2.5	0.85	55.05	39.759	99.9	39.759	
Last Pt	60.0	01:00:00	223.000																		
Final Val	60.0	01:00:00	223.000												Max Vac	3.5			39.759	99.9	
Average Values				0.74		1.43	245	237	241	65			88	81		0.86	55.98				

CTM 027 (AMMONIA) SOURCE SAMPLING TITLE PAGE ISOKINETIC SAMPLING DATA

Plant Name	West County Energy Center		
Sampling Location	Unit 3C		
Project #	bv-10-westcounty.fl-comp#2		

Date	04/07/11
Operator	MV
Run Number	Fuel Oil-3

Ideal Nozzle Diameter and IsoKinetic Factor Setup			
Pitot Coefficient	(C _p)	0.840	
Average Stack Temp	(t _s)	245.3	*F
Average Meter Temp	(t _m)	83.6	
Orifice Meter Coefficient	(K _o)	1.745	in H ₂ O
Square Root ΔP	(ΔP) ^{1/2} _{avg}	0.85	in H ₂ O
Stack Moisture Content	(B _{ws})	8.06	%
Stack Dry Molecular Weight	(M _d)	29.41	lb/lb-mole
Estimated Orifice Flow Rate	(Q _o)	0.66	acfm
ΔP to ΔH Isokinetic Factor	(K)	1.96	

Leak Checks					
Train	Pre	0.000	ft ³ /min@	15.0	in Hg
PASS	Post	0.000	ft ³ /min@	15.0	in Hg
Pitot	Pre (+)	5.0	in H ₂ O for	30.0	sec
	Pre (-)	5.0	in H ₂ O for	30.0	sec
PASS	Post (+)	5.0	in H ₂ O for	30.0	sec
	Post (-)	5.0	in H ₂ O for	30.0	sec

Sampling Equipment			
Meter Box Number	SAMP-CP-0010		
Meter Cal Factor	(Y)	0.991	
Nozzle Number	I8		
Average Nozzle Diameter	(D _{no})	0.2300	in
Suggested Nozzle Diameter	(D _{no})	0.2097	in
Probe Number	SAMP-HP-0001		
Probe Length	120		
Liner Material	Inconel		
Sample Case / Oven Number	SAMP-BH-0025		
Impinger Case Number	SAMP-BC-0021		

Pressures			
Barometric Pressure	(P _b)	30.08	in Hg
Stack Static Pressure	(P _{static})	0.71	in H ₂ O
Absolute Stack Pressure	(P _s)	30.13	in Hg
Absolute Meter Pressure	(P _m)	30.21	in Hg

Nozzle Measurements				
Pre	0.230	0.230	0.230	PASS
Post	0.230	0.230	0.230	PASS

Run Time			
Start	16:22	End	17:45

Weights	Imp 1	Imp 2	Imp 3	Imp 4	Imp 5	Imp 6	Imp 7	Imp 8
Pre	742.2	748.9	609.2	826.2				
Post	804.1	760.1	609.2	826.2				

Wash Volumes					mi
					mi

Traverse Point #	Sampling Time (θ)	Timer Time	Dry Gas Meter Reading (V _m)	Velocity Head (Δp)	Desired Orifice ΔH (ΔH _d)	Actual Orifice ΔH (ΔH _a)	Stack Temp (t _s)	Probe Temp (248±25°F)	Filter Temp (248±25°F)	Impinger Exit Temp (568°F)	Cond. Temp (±°F)	CPM Filter Temp (±°F)	Meter Inlet Temp (t _m)	Meter Outlet Temp (t _{mo})	Pump Vacuum	Square Root ΔP (ΔP ^{1/2})	Local Stack Velocity (v _s)	Cumul. Meter Volume (V _{m,isd})	Cumul. Percent IsoKinetic (I)	Est-Run Meter Volume (V _{m,isd})
	min	hh:mm:ss	ft ³	in H ₂ O	in H ₂ O	in H ₂ O	*F	*F	*F	*F	*F	*F	*F	*F	in Hg	√(in H ₂ O)	ft/sec	dscf	%	dscf
A-1	0.0	00:00:00	223.870	0.61	1.198	1.10	246	234	236	67			84	81	2.0	0.78	50.86	1.478	97.0	35.469
A-2	2.5	00:02:30	225.390	0.62	1.218	1.20	243	233	244	68			85	81	2.0	0.79	51.17	3.110	101.8	37.322
A-3	5.0	00:05:00	227.070	0.84	1.257	1.20	245	236	247	63			86	80	3.0	0.80	52.06	4.743	102.7	37.940
A-4	7.5	00:07:30	228.750	0.69	1.355	1.30	247	238	245	64			87	81	3.0	0.83	54.13	6.372	102.2	38.233
A-5	10.0	00:10:00	230.430	0.69	1.355	1.30	244	239	241	65			88	82	3.0	0.83	54.02	7.999	101.8	38.395
A-6	12.5	00:12:30	232.110	0.61	1.198	1.20	246	242	245	59			87	81	2.5	0.78	50.86	9.599	102.3	38.397
B-1	15.0	00:15:00	233.760	0.62	1.218	1.20	245	235	235	62			86	81	2.5	0.79	51.24	11.055	101.3	37.904
B-2	17.5	00:17:30	235.280	0.74	1.454	1.40	247	237	238	64			87	80	3.0	0.86	56.06	12.833	102.0	38.498
B-3	20.0	00:20:00	237.090	0.75	1.473	1.50	248	239	242	65			88	81	3.0	0.87	56.48	14.462	101.4	38.564
B-4	22.5	00:22:30	238.770	0.72	1.414	1.40	243	237	229	58			87	82	2.5	0.85	55.14	16.090	101.0	38.616
B-5	25.0	00:25:00	240.450	0.67	1.316	1.30	247	239	232	59			88	81	2.5	0.82	53.34	17.699	101.0	38.616
B-6	27.5	00:27:30	242.110	0.61	1.198	1.20	246	241	235	58			87	82	2.5	0.78	50.86	19.366	101.7	38.731
C-1	30.0	00:30:00	243.830	0.78	1.532	1.50	245	234	230	66			85	81	2.5	0.88	57.47	20.960	101.0	38.696
C-2	32.5	00:32:30	245.470	0.79	1.552	1.50	248	232	229	61			87	81	2.5	0.89	57.97	22.668	100.9	38.860
C-3	35.0	00:35:00	247.230	0.81	1.591	1.60	249	234	230	60			88	82	2.5	0.90	58.74	24.325	100.4	38.921
C-4	37.5	00:37:30	248.940	0.82	1.611	1.60	245	233	234	62			87	81	2.5	0.91	58.93	25.956	99.9	38.934
C-5	40.0	00:40:00	250.620	0.84	1.650	1.60	246	237	238	63			88	82	3.0	0.92	59.69	27.710	99.8	39.120
C-6	42.5	00:42:30	252.430	0.84	1.650	1.60	247	239	241	60			87	81	3.0	0.92	59.73	29.341	99.3	39.121
D-1	45.0	00:45:00	254.110	0.71	1.395	1.40	246	234	225	68			84	81	2.0	0.84	54.87	30.869	99.0	38.992
D-2	47.5	00:47:30	255.680	0.69	1.355	1.30	245	236	228	65			83	80	2.0	0.83	54.06	32.506	99.1	39.007
D-3	50.0	00:50:00	257.360	0.77	1.500	1.50	247	238	229	67			84	81	2.5	0.88	57.19	34.238	99.2	39.129
D-4	52.5	00:52:30	259.140	0.75	1.473	1.50	246	240	231	65			84	81	2.5	0.87	56.40	35.980	99.4	39.251
D-5	55.0	00:55:00	260.930	0.77	1.513	1.50	238	233	244	60			87	81	2.5	0.88	56.82	37.621	99.2	39.256
D-6	57.5	00:57:30	262.620	0.71	1.395	1.40	239	237	245	61			88	80	2.5	0.84	54.60	39.331	99.4	39.331
Last Pt	60.0	01:00:00	264.380																	
Final Val	60.0		264.380												Max Vac		Final Values	39.331	99.4	
Average Values				0.72		1.39	245	237	236	63			86	81	3.0	0.85	55.11			

SAMPLE RECOVERY AND INTEGRITY DATA SHEET

Plant Name	West County Energy Center	Date	04/07/11
Sampling Location	Unit 3C	Operator	MV
Project #	bv-10-westcounty.fl-comp#2		

Run History Data				
Run Number	Fuel Oil-1	Fuel Oil-2	Fuel Oil-3	
Run Start Time	13:00	14:55	16:22	(hh:mm)
Run Stop Time	14:20	16:10	17:45	(hh:mm)
Train Prepared By	MV	MV	MV	
Train Recovered By	MV	MV	MV	
Recovery Date	04/07/11	04/07/11	04/07/11	(mm/dd/yy)
Relinquished By	MV	MV	MV	
Received By	MV	MV	MV	
Relinquished Date	04/07/11	04/07/11	04/07/11	(mm/dd/yy)
Relinquished Time	14:20	16:10	17:45	(hh:mm)

Equipment Identification Numbers			
Impinger Case	SAMP-BH-0025	SAMP-BH-0025	SAMP-BH-0025
Sample Box	SAMP-BC-0021	SAMP-BC-0019	SAMP-BC-0021

Sample Blank Taken YES

Moisture Content Data					
Impingers 1, 2, and 3 - Liquid Weight					
Final Weight	(W _f)	2181.9	2205.9	2173.4	g
Initial Weight	(W _i)	2109.0	2130.5	2100.3	g
Net Weight	(W _n)	72.9	75.4	73.1	g
Comments					
Impinger 4 - Silica Gel Weight					
Final Weight	(W _f)	828.1	867.0	826.2	g
Initial Weight	(W _i)	821.2	858.7	826.2	g
Net Weight	(W _n)	6.9	8.3	0.0	g
Comments					
Total Water Collected					
Total Weight	(W _c)	79.8	83.7	73.1	g
Total Volume	(V _c)	79.9	83.9	73.2	ml

CTM 027 (AMMONIA) - RESULTS

Plant Name	West County Energy Center
Sampling Location	Unit 3C
Project #	bv-10-westcounty.fl-comp#2

Historical Data	Fuel Oil-1	Fuel Oil-2	Fuel Oil-3	Average	Units
Run Start Time	13:00	14:55	16:22		hh:mm
Run Stop Time	14:20	16:10	17:45		hh:mm
Test Date	04/07/11	04/07/11	04/07/11		mm/dd/yy
Meter Calibration Factor	0.991	0.991	0.991		
Pitot Tube Coefficient	0.840	0.840	0.840		
Average Nozzle Diameter	0.230	0.230	0.230		in
Stack Test Data	Fuel Oil-1	Fuel Oil-2	Fuel Oil-3	Average	Units
Initial Meter Volume	142.450	182.050	223.870		ft ³
Final Meter Volume	181.720	223.000	264.380		ft ³
Total Meter Volume	39.270	40.950	40.510	40.243	ft ³
Total Sampling Time	60.00	60.00	60.00	60.00	min
Average Meter Temperature	81.13	84.42	83.65	83.06	°F
Average Stack Temperature	245.50	244.54	245.33	245.13	°F
Barometric Pressure	30.10	30.12	30.08	30.10	in Hg
Stack Static Pressure	0.75	0.72	0.71	0.73	in H ₂ O
Absolute Stack Pressure	30.16	30.17	30.13	30.15	in Hg
Average Orifice Pressure Drop	1.19	1.43	1.39	1.33	in H ₂ O
Absolute Meter Pressure	30.23	30.25	30.21	30.23	in Hg
Avg Square Root Pitot Pressure	0.80	0.86	0.85	0.83	√(in H ₂ O)
Moisture Content Data	Fuel Oil-1	Fuel Oil-2	Fuel Oil-3	Average	Units
Impinger Water Weight Gain	72.90	75.40	73.10	73.80	g
Silica Gel Weight Gain	6.90	8.30	0.00	5.07	g
Total Water Volume Collected	79.94	83.85	73.23	79.01	ml
Standard Water Vapor Volume	3.76	3.95	3.45	3.72	scf
Standard Meter Volume	38.3	39.8	39.3	39.1	dscf
Calculated Stack Moisture	8.94	9.03	8.06	8.68	%
Saturated Stack Moisture	100.00	100.00	100.00	100.00	%
Reported Stack Moisture Content	8.94	9.03	8.06	8.68	%

CTM 027 (AMMONIA) - RESULTS

Plant Name	West County Energy Center
Sampling Location	Unit 3C
Project #	bv-10-westcounty.fl-comp#2

Gas Analysis Data	Fuel Oil-1	Fuel Oil-2	Fuel Oil-3	Average	Units
Carbon Dioxide Content	5.4	5.5	5.5	5.4	%
Oxygen Content	13.6	13.4	13.4	13.5	%
Carbon Monoxide Content	7.2	7.5	7.9	7.5	ppm
Nitrogen Content	81.1	81.1	81.2	81.1	%
Stack Dry Molecular Weight	29.40	29.41	29.41	29.41	lb/lb-mole
Stack Wet Molecular Weight	28.38	28.38	28.49	28.42	lb/lb-mole
Calculated Fuel Factor	1.365	1.367	1.377	1.369	
Fuel F-Factor	9292.34	9292.34	9292.34	9292.34	dscf/MMBtu
Percent Excess Air	173.3	167.6	166.3	169.1	%
Volumetric Flow Rate Data	Fuel Oil-1	Fuel Oil-2	Fuel Oil-3	Average	Units
Average Stack Gas Velocity	51.98	55.98	55.11	54.36	ft/sec
Stack Cross-Sectional Area	378.35	378.35	378.35	378.35	ft ²
Actual Stack Flow Rate	1,180,060	1,270,894	1,251,108	1,234,020	acfm
Wet Standard Stack Flow Rate	53,406	57,629	56,592	55,876	wkscfh
Dry Standard Stack Flow Rate	48,630,312	52,425,620	52,032,322	51,029,418	dscfh
Percent of Isokinetic Rate	103.6	99.9	99.4	101.0	%
Ammonia Analysis (CTM-027)	Fuel Oil-1	Fuel Oil-2	Fuel Oil-3	Average	Units
Sample Number (Front Half)	02	04	06		
Sample Number (Back Half)	03	05	07		
Lab Log Number (Front Half)	U3C-R1-1	U3C-R2-1	U3C-R3-1		
Lab Log Number (Back Half)	U3C-R1-2	U3C-R2-2	U3C-R3-2		
Front Half Results (C _f)	7.8000	8.9360	4.2390	6.9917	mg/l
Back Half Results (C _b)	0.0000	0.0000	0.0000	0.0000	mg/l
Practical Quantitation Limit	0.1000	0.1000	0.1000	0.1000	mg/l
Blank Results	0.0000	0.0000	0.0000	0.0000	mg/l
Front Half Sample Volume	150	150	150	150	ml
Back Half Sample Volume	150	150	150	150	ml
Volume of NH ₃	0.00154	0.00176	0.00084	0.00138	L
NH ₃ Concentration	1.42	1.57	0.75	1.25	ppmvd
NH ₃ Concentration	1.14	1.23	0.59	0.99	ppm@15%O ₂

TEST RESULTS

**Opacity
Fuel Oil Load**

Company: Florida Power and Light Equipment: Mitsubishi 501G, Unit U3C Fuel Oil Location: West County Energy Center Date: April 7, 2011 Project #: bv-10-westcounty.fl-comp#2						Run 1	Average Opacity: 0.00 % Maximum Opacity: 0 % 6 Minute Average: 0.00 % 6 Minute Maximum: 0.00 % Max Time w/ Opacity: 0.00 minutes				
TIME (min)	OPACITY (%)	6 MIN AVG.	TIME (min)	OPACITY (%)	6 MIN AVG.	TIME (min)	OPACITY (%)	6 MIN AVG.	TIME (min)	OPACITY (%)	6 MIN AVG.
0.00	0	N/A	15.00	0	0.00	30.00	0	0.00	45.00	0	0.00
0.25	0	N/A	15.25	0	0.00	30.25	0	0.00	45.25	0	0.00
0.50	0	N/A	15.50	0	0.00	30.50	0	0.00	45.50	0	0.00
0.75	0	N/A	15.75	0	0.00	30.75	0	0.00	45.75	0	0.00
1.00	0	N/A	16.00	0	0.00	31.00	0	0.00	46.00	0	0.00
1.25	0	N/A	16.25	0	0.00	31.25	0	0.00	46.25	0	0.00
1.50	0	N/A	16.50	0	0.00	31.50	0	0.00	46.50	0	0.00
1.75	0	N/A	16.75	0	0.00	31.75	0	0.00	46.75	0	0.00
2.00	0	N/A	17.00	0	0.00	32.00	0	0.00	47.00	0	0.00
2.25	0	N/A	17.25	0	0.00	32.25	0	0.00	47.25	0	0.00
2.50	0	N/A	17.50	0	0.00	32.50	0	0.00	47.50	0	0.00
2.75	0	N/A	17.75	0	0.00	32.75	0	0.00	47.75	0	0.00
3.00	0	N/A	18.00	0	0.00	33.00	0	0.00	48.00	0	0.00
3.25	0	N/A	18.25	0	0.00	33.25	0	0.00	48.25	0	0.00
3.50	0	N/A	18.50	0	0.00	33.50	0	0.00	48.50	0	0.00
3.75	0	N/A	18.75	0	0.00	33.75	0	0.00	48.75	0	0.00
4.00	0	N/A	19.00	0	0.00	34.00	0	0.00	49.00	0	0.00
4.25	0	N/A	19.25	0	0.00	34.25	0	0.00	49.25	0	0.00
4.50	0	N/A	19.50	0	0.00	34.50	0	0.00	49.50	0	0.00
4.75	0	N/A	19.75	0	0.00	34.75	0	0.00	49.75	0	0.00
5.00	0	N/A	20.00	0	0.00	35.00	0	0.00	50.00	0	0.00
5.25	0	N/A	20.25	0	0.00	35.25	0	0.00	50.25	0	0.00
5.50	0	N/A	20.50	0	0.00	35.50	0	0.00	50.50	0	0.00
5.75	0	0.00	20.75	0	0.00	35.75	0	0.00	50.75	0	0.00
6.00	0	0.00	21.00	0	0.00	36.00	0	0.00	51.00	0	0.00
6.25	0	0.00	21.25	0	0.00	36.25	0	0.00	51.25	0	0.00
6.50	0	0.00	21.50	0	0.00	36.50	0	0.00	51.50	0	0.00
6.75	0	0.00	21.75	0	0.00	36.75	0	0.00	51.75	0	0.00
7.00	0	0.00	22.00	0	0.00	37.00	0	0.00	52.00	0	0.00
7.25	0	0.00	22.25	0	0.00	37.25	0	0.00	52.25	0	0.00
7.50	0	0.00	22.50	0	0.00	37.50	0	0.00	52.50	0	0.00
7.75	0	0.00	22.75	0	0.00	37.75	0	0.00	52.75	0	0.00
8.00	0	0.00	23.00	0	0.00	38.00	0	0.00	53.00	0	0.00
8.25	0	0.00	23.25	0	0.00	38.25	0	0.00	53.25	0	0.00
8.50	0	0.00	23.50	0	0.00	38.50	0	0.00	53.50	0	0.00
8.75	0	0.00	23.75	0	0.00	38.75	0	0.00	53.75	0	0.00
9.00	0	0.00	24.00	0	0.00	39.00	0	0.00	54.00	0	0.00
9.25	0	0.00	24.25	0	0.00	39.25	0	0.00	54.25	0	0.00
9.50	0	0.00	24.50	0	0.00	39.50	0	0.00	54.50	0	0.00
9.75	0	0.00	24.75	0	0.00	39.75	0	0.00	54.75	0	0.00
10.00	0	0.00	25.00	0	0.00	40.00	0	0.00	55.00	0	0.00
10.25	0	0.00	25.25	0	0.00	40.25	0	0.00	55.25	0	0.00
10.50	0	0.00	25.50	0	0.00	40.50	0	0.00	55.50	0	0.00
10.75	0	0.00	25.75	0	0.00	40.75	0	0.00	55.75	0	0.00
11.00	0	0.00	26.00	0	0.00	41.00	0	0.00	56.00	0	0.00
11.25	0	0.00	26.25	0	0.00	41.25	0	0.00	56.25	0	0.00
11.50	0	0.00	26.50	0	0.00	41.50	0	0.00	56.50	0	0.00
11.75	0	0.00	26.75	0	0.00	41.75	0	0.00	56.75	0	0.00
12.00	0	0.00	27.00	0	0.00	42.00	0	0.00	57.00	0	0.00
12.25	0	0.00	27.25	0	0.00	42.25	0	0.00	57.25	0	0.00
12.50	0	0.00	27.50	0	0.00	42.50	0	0.00	57.50	0	0.00
12.75	0	0.00	27.75	0	0.00	42.75	0	0.00	57.75	0	0.00
13.00	0	0.00	28.00	0	0.00	43.00	0	0.00	58.00	0	0.00
13.25	0	0.00	28.25	0	0.00	43.25	0	0.00	58.25	0	0.00
13.50	0	0.00	28.50	0	0.00	43.50	0	0.00	58.50	0	0.00
13.75	0	0.00	28.75	0	0.00	43.75	0	0.00	58.75	0	0.00
14.00	0	0.00	29.00	0	0.00	44.00	0	0.00	59.00	0	0.00
14.25	0	0.00	29.25	0	0.00	44.25	0	0.00	59.25	0	0.00
14.50	0	0.00	29.50	0	0.00	44.50	0	0.00	59.50	0	0.00
14.75	0	0.00	29.75	0	0.00	44.75	0	0.00	59.75	0	0.00

Company: Florida Power and Light
Equipment: Mitsubishi 501G, Unit U3C Fuel Oil
Location: West County Energy Center
Date: April 7, 2011
Project #: bv-10-westcounty.fl-comp#2

Run 2

Average Opacity: 0.00 %
Maximum Opacity: 0 %
6 Minute Average: 0.00 %
6 Minute Maximum: 0.00 %
Max Time w/ Opacity: 0.00 minutes

TIME (min)	OPACITY (%)	6 MIN AVG.	TIME (min)	OPACITY (%)	6 MIN AVG.	TIME (min)	OPACITY (%)	6 MIN AVG.	TIME (min)	OPACITY (%)	6 MIN AVG.
0.00	0	N/A	15.00	0	0.00	30.00	0	0.00	45.00	0	0.00
0.25	0	N/A	15.25	0	0.00	30.25	0	0.00	45.25	0	0.00
0.50	0	N/A	15.50	0	0.00	30.50	0	0.00	45.50	0	0.00
0.75	0	N/A	15.75	0	0.00	30.75	0	0.00	45.75	0	0.00
1.00	0	N/A	16.00	0	0.00	31.00	0	0.00	46.00	0	0.00
1.25	0	N/A	16.25	0	0.00	31.25	0	0.00	46.25	0	0.00
1.50	0	N/A	16.50	0	0.00	31.50	0	0.00	46.50	0	0.00
1.75	0	N/A	16.75	0	0.00	31.75	0	0.00	46.75	0	0.00
2.00	0	N/A	17.00	0	0.00	32.00	0	0.00	47.00	0	0.00
2.25	0	N/A	17.25	0	0.00	32.25	0	0.00	47.25	0	0.00
2.50	0	N/A	17.50	0	0.00	32.50	0	0.00	47.50	0	0.00
2.75	0	N/A	17.75	0	0.00	32.75	0	0.00	47.75	0	0.00
3.00	0	N/A	18.00	0	0.00	33.00	0	0.00	48.00	0	0.00
3.25	0	N/A	18.25	0	0.00	33.25	0	0.00	48.25	0	0.00
3.50	0	N/A	18.50	0	0.00	33.50	0	0.00	48.50	0	0.00
3.75	0	N/A	18.75	0	0.00	33.75	0	0.00	48.75	0	0.00
4.00	0	N/A	19.00	0	0.00	34.00	0	0.00	49.00	0	0.00
4.25	0	N/A	19.25	0	0.00	34.25	0	0.00	49.25	0	0.00
4.50	0	N/A	19.50	0	0.00	34.50	0	0.00	49.50	0	0.00
4.75	0	N/A	19.75	0	0.00	34.75	0	0.00	49.75	0	0.00
5.00	0	N/A	20.00	0	0.00	35.00	0	0.00	50.00	0	0.00
5.25	0	N/A	20.25	0	0.00	35.25	0	0.00	50.25	0	0.00
5.50	0	N/A	20.50	0	0.00	35.50	0	0.00	50.50	0	0.00
5.75	0	0.00	20.75	0	0.00	35.75	0	0.00	50.75	0	0.00
6.00	0	0.00	21.00	0	0.00	36.00	0	0.00	51.00	0	0.00
6.25	0	0.00	21.25	0	0.00	36.25	0	0.00	51.25	0	0.00
6.50	0	0.00	21.50	0	0.00	36.50	0	0.00	51.50	0	0.00
6.75	0	0.00	21.75	0	0.00	36.75	0	0.00	51.75	0	0.00
7.00	0	0.00	22.00	0	0.00	37.00	0	0.00	52.00	0	0.00
7.25	0	0.00	22.25	0	0.00	37.25	0	0.00	52.25	0	0.00
7.50	0	0.00	22.50	0	0.00	37.50	0	0.00	52.50	0	0.00
7.75	0	0.00	22.75	0	0.00	37.75	0	0.00	52.75	0	0.00
8.00	0	0.00	23.00	0	0.00	38.00	0	0.00	53.00	0	0.00
8.25	0	0.00	23.25	0	0.00	38.25	0	0.00	53.25	0	0.00
8.50	0	0.00	23.50	0	0.00	38.50	0	0.00	53.50	0	0.00
8.75	0	0.00	23.75	0	0.00	38.75	0	0.00	53.75	0	0.00
9.00	0	0.00	24.00	0	0.00	39.00	0	0.00	54.00	0	0.00
9.25	0	0.00	24.25	0	0.00	39.25	0	0.00	54.25	0	0.00
9.50	0	0.00	24.50	0	0.00	39.50	0	0.00	54.50	0	0.00
9.75	0	0.00	24.75	0	0.00	39.75	0	0.00	54.75	0	0.00
10.00	0	0.00	25.00	0	0.00	40.00	0	0.00	55.00	0	0.00
10.25	0	0.00	25.25	0	0.00	40.25	0	0.00	55.25	0	0.00
10.50	0	0.00	25.50	0	0.00	40.50	0	0.00	55.50	0	0.00
10.75	0	0.00	25.75	0	0.00	40.75	0	0.00	55.75	0	0.00
11.00	0	0.00	26.00	0	0.00	41.00	0	0.00	56.00	0	0.00
11.25	0	0.00	26.25	0	0.00	41.25	0	0.00	56.25	0	0.00
11.50	0	0.00	26.50	0	0.00	41.50	0	0.00	56.50	0	0.00
11.75	0	0.00	26.75	0	0.00	41.75	0	0.00	56.75	0	0.00
12.00	0	0.00	27.00	0	0.00	42.00	0	0.00	57.00	0	0.00
12.25	0	0.00	27.25	0	0.00	42.25	0	0.00	57.25	0	0.00
12.50	0	0.00	27.50	0	0.00	42.50	0	0.00	57.50	0	0.00
12.75	0	0.00	27.75	0	0.00	42.75	0	0.00	57.75	0	0.00
13.00	0	0.00	28.00	0	0.00	43.00	0	0.00	58.00	0	0.00
13.25	0	0.00	28.25	0	0.00	43.25	0	0.00	58.25	0	0.00
13.50	0	0.00	28.50	0	0.00	43.50	0	0.00	58.50	0	0.00
13.75	0	0.00	28.75	0	0.00	43.75	0	0.00	58.75	0	0.00
14.00	0	0.00	29.00	0	0.00	44.00	0	0.00	59.00	0	0.00
14.25	0	0.00	29.25	0	0.00	44.25	0	0.00	59.25	0	0.00
14.50	0	0.00	29.50	0	0.00	44.50	0	0.00	59.50	0	0.00
14.75	0	0.00	29.75	0	0.00	44.75	0	0.00	59.75	0	0.00

Company: Florida Power and Light
Equipment: Mitsubishi 501G, Unit U3C Fuel Oil
Location: West County Energy Center
Date: April 7, 2011
Project #: bv-10-westcounty.fl-comp#2

Run 3

Average Opacity: 0.00 %
Maximum Opacity: 0 %
6 Minute Average: 0.00 %
6 Minute Maximum: 0.00 %
Max Time w/ Opacity: 0.00 minutes

TIME (min)	OPACITY (%)	6 MIN AVG.	TIME (min)	OPACITY (%)	6 MIN AVG.	TIME (min)	OPACITY (%)	6 MIN AVG.	TIME (min)	OPACITY (%)	6 MIN AVG.
0.00	0	N/A	15.00	0	0.00	30.00	0	0.00	45.00	0	0.00
0.25	0	N/A	15.25	0	0.00	30.25	0	0.00	45.25	0	0.00
0.50	0	N/A	15.50	0	0.00	30.50	0	0.00	45.50	0	0.00
0.75	0	N/A	15.75	0	0.00	30.75	0	0.00	45.75	0	0.00
1.00	0	N/A	16.00	0	0.00	31.00	0	0.00	46.00	0	0.00
1.25	0	N/A	16.25	0	0.00	31.25	0	0.00	46.25	0	0.00
1.50	0	N/A	16.50	0	0.00	31.50	0	0.00	46.50	0	0.00
1.75	0	N/A	16.75	0	0.00	31.75	0	0.00	46.75	0	0.00
2.00	0	N/A	17.00	0	0.00	32.00	0	0.00	47.00	0	0.00
2.25	0	N/A	17.25	0	0.00	32.25	0	0.00	47.25	0	0.00
2.50	0	N/A	17.50	0	0.00	32.50	0	0.00	47.50	0	0.00
2.75	0	N/A	17.75	0	0.00	32.75	0	0.00	47.75	0	0.00
3.00	0	N/A	18.00	0	0.00	33.00	0	0.00	48.00	0	0.00
3.25	0	N/A	18.25	0	0.00	33.25	0	0.00	48.25	0	0.00
3.50	0	N/A	18.50	0	0.00	33.50	0	0.00	48.50	0	0.00
3.75	0	N/A	18.75	0	0.00	33.75	0	0.00	48.75	0	0.00
4.00	0	N/A	19.00	0	0.00	34.00	0	0.00	49.00	0	0.00
4.25	0	N/A	19.25	0	0.00	34.25	0	0.00	49.25	0	0.00
4.50	0	N/A	19.50	0	0.00	34.50	0	0.00	49.50	0	0.00
4.75	0	N/A	19.75	0	0.00	34.75	0	0.00	49.75	0	0.00
5.00	0	N/A	20.00	0	0.00	35.00	0	0.00	50.00	0	0.00
5.25	0	N/A	20.25	0	0.00	35.25	0	0.00	50.25	0	0.00
5.50	0	N/A	20.50	0	0.00	35.50	0	0.00	50.50	0	0.00
5.75	0	0.00	20.75	0	0.00	35.75	0	0.00	50.75	0	0.00
6.00	0	0.00	21.00	0	0.00	36.00	0	0.00	51.00	0	0.00
6.25	0	0.00	21.25	0	0.00	36.25	0	0.00	51.25	0	0.00
6.50	0	0.00	21.50	0	0.00	36.50	0	0.00	51.50	0	0.00
6.75	0	0.00	21.75	0	0.00	36.75	0	0.00	51.75	0	0.00
7.00	0	0.00	22.00	0	0.00	37.00	0	0.00	52.00	0	0.00
7.25	0	0.00	22.25	0	0.00	37.25	0	0.00	52.25	0	0.00
7.50	0	0.00	22.50	0	0.00	37.50	0	0.00	52.50	0	0.00
7.75	0	0.00	22.75	0	0.00	37.75	0	0.00	52.75	0	0.00
8.00	0	0.00	23.00	0	0.00	38.00	0	0.00	53.00	0	0.00
8.25	0	0.00	23.25	0	0.00	38.25	0	0.00	53.25	0	0.00
8.50	0	0.00	23.50	0	0.00	38.50	0	0.00	53.50	0	0.00
8.75	0	0.00	23.75	0	0.00	38.75	0	0.00	53.75	0	0.00
9.00	0	0.00	24.00	0	0.00	39.00	0	0.00	54.00	0	0.00
9.25	0	0.00	24.25	0	0.00	39.25	0	0.00	54.25	0	0.00
9.50	0	0.00	24.50	0	0.00	39.50	0	0.00	54.50	0	0.00
9.75	0	0.00	24.75	0	0.00	39.75	0	0.00	54.75	0	0.00
10.00	0	0.00	25.00	0	0.00	40.00	0	0.00	55.00	0	0.00
10.25	0	0.00	25.25	0	0.00	40.25	0	0.00	55.25	0	0.00
10.50	0	0.00	25.50	0	0.00	40.50	0	0.00	55.50	0	0.00
10.75	0	0.00	25.75	0	0.00	40.75	0	0.00	55.75	0	0.00
11.00	0	0.00	26.00	0	0.00	41.00	0	0.00	56.00	0	0.00
11.25	0	0.00	26.25	0	0.00	41.25	0	0.00	56.25	0	0.00
11.50	0	0.00	26.50	0	0.00	41.50	0	0.00	56.50	0	0.00
11.75	0	0.00	26.75	0	0.00	41.75	0	0.00	56.75	0	0.00
12.00	0	0.00	27.00	0	0.00	42.00	0	0.00	57.00	0	0.00
12.25	0	0.00	27.25	0	0.00	42.25	0	0.00	57.25	0	0.00
12.50	0	0.00	27.50	0	0.00	42.50	0	0.00	57.50	0	0.00
12.75	0	0.00	27.75	0	0.00	42.75	0	0.00	57.75	0	0.00
13.00	0	0.00	28.00	0	0.00	43.00	0	0.00	58.00	0	0.00
13.25	0	0.00	28.25	0	0.00	43.25	0	0.00	58.25	0	0.00
13.50	0	0.00	28.50	0	0.00	43.50	0	0.00	58.50	0	0.00
13.75	0	0.00	28.75	0	0.00	43.75	0	0.00	58.75	0	0.00
14.00	0	0.00	29.00	0	0.00	44.00	0	0.00	59.00	0	0.00
14.25	0	0.00	29.25	0	0.00	44.25	0	0.00	59.25	0	0.00
14.50	0	0.00	29.50	0	0.00	44.50	0	0.00	59.50	0	0.00
14.75	0	0.00	29.75	0	0.00	44.75	0	0.00	59.75	0	0.00

Company: Florida Power and Light
Equipment: Mitsubishi 501G, Unit U3C Fuel Oil
Location: West County Energy Center
Date: April 7, 2011
Project #: bv-10-westcounty.fl-comp#2

Run 1

Average Opacity: 0.00 %
Maximum Opacity: 0 %
6 Minute Average: 0.00 %
6 Minute Maximum: 0.00 %
Max Time w/ Opacity: 0.00 minutes

OPACITY READINGS (15 second intervals)

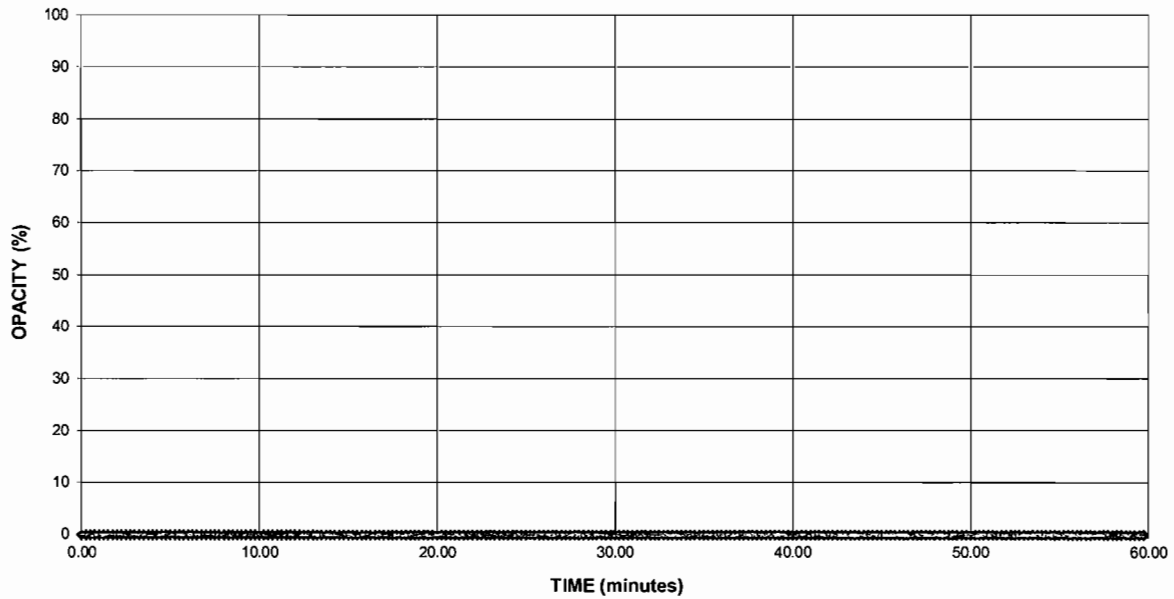

OPACITY RESULTS (6 minute averages)

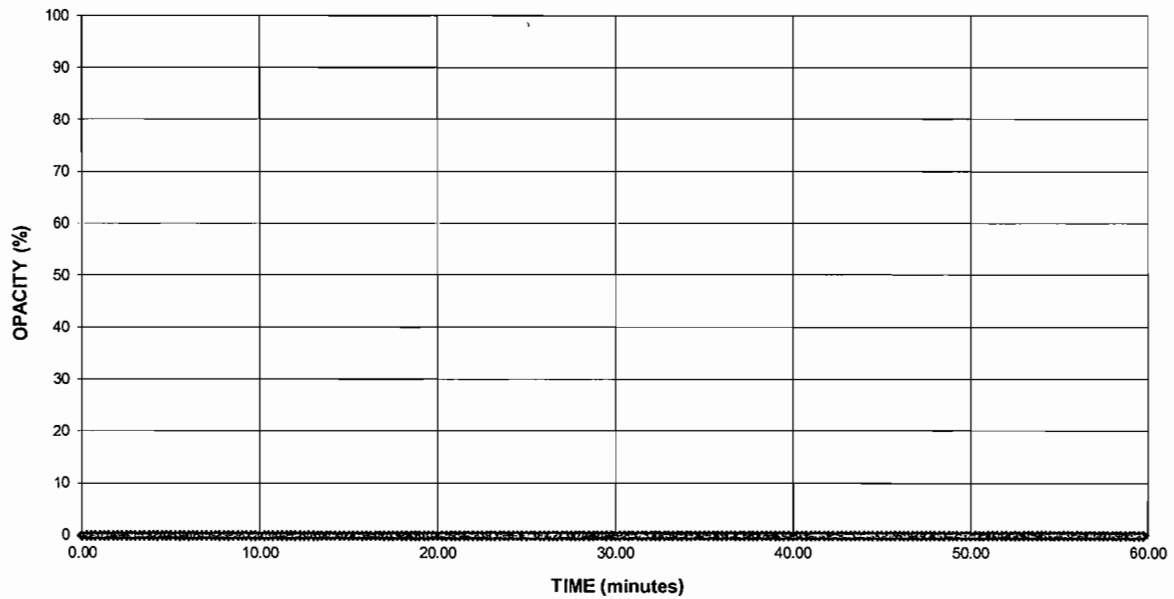

Company: Florida Power and Light
Equipment: Mitsubishi 501G, Unit U3C Fuel Oil
Location: West County Energy Center
Date: April 7, 2011
Project #: bv-10-westcounty.fl-comp#2

Run 2

Average Opacity: 0.00 %
Maximum Opacity: 0 %
6 Minute Average: 0.00 %
6 Minute Maximum: 0.00 %
Max Time w/ Opacity: 0.00 minutes

OPACITY READINGS (15 second intervals)

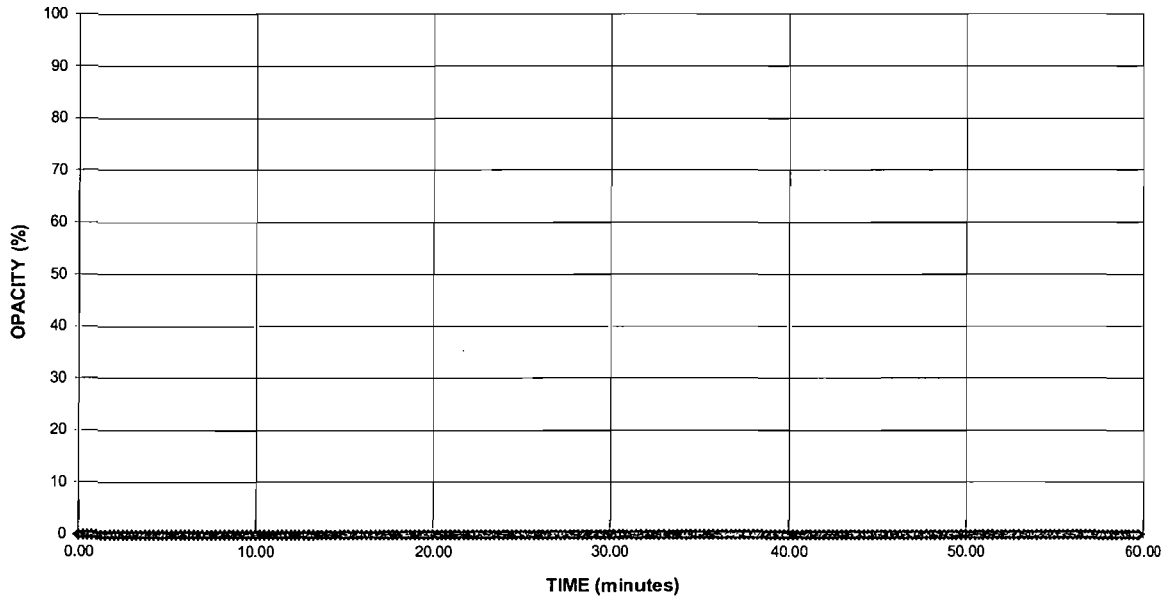

OPACITY RESULTS (6 minute averages)

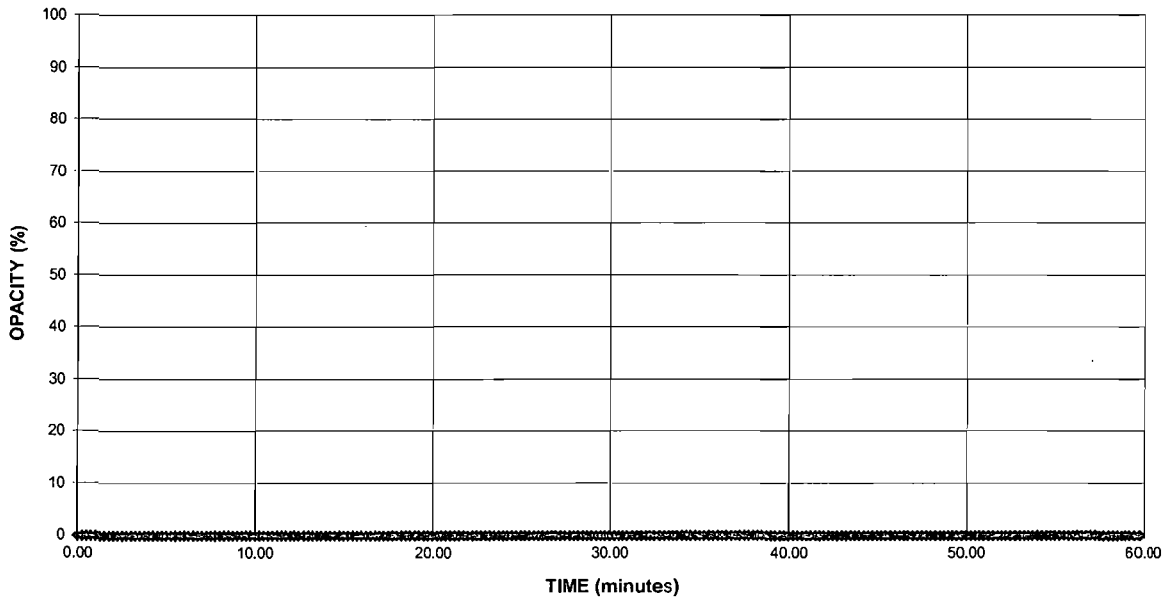

Company: Florida Power and Light
Equipment: Mitsubishi 501G, Unit U3C Fuel Oil
Location: West County Energy Center
Date: April 7, 2011
Project #: bv-10-westcounty.fl-comp#2

Run 3

Average Opacity: 0.00 %
Maximum Opacity: 0 %
6 Minute Average: 0.00 %
6 Minute Maximum: 0.00 %
Max Time w/ Opacity: 0.00 minutes

OPACITY READINGS (15 second intervals)

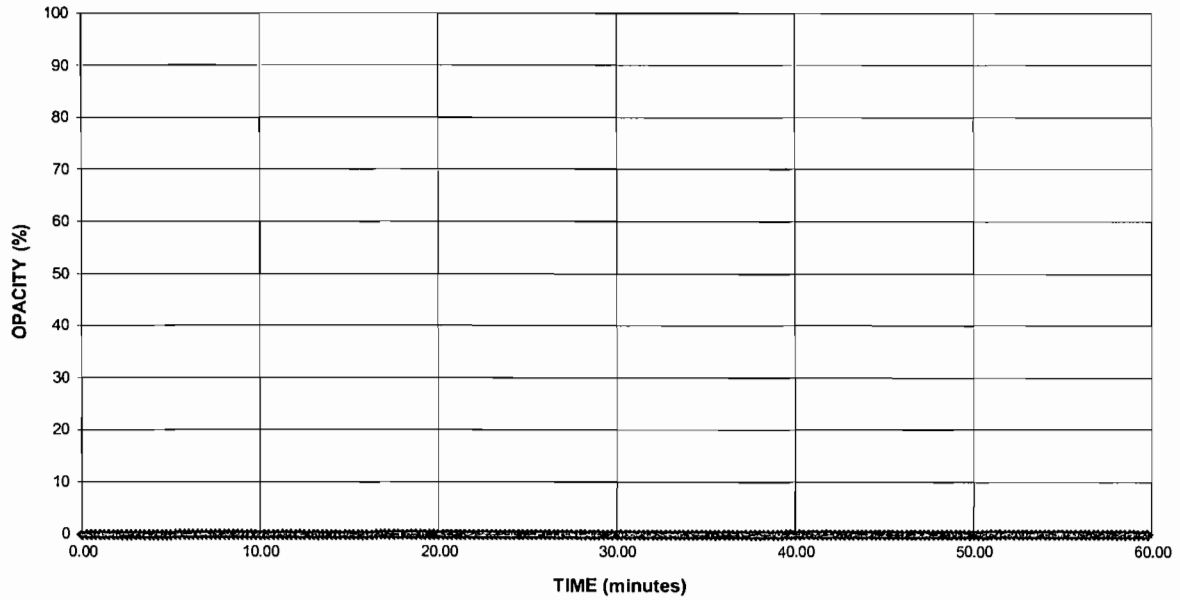

OPACITY RESULTS (6 minute averages)

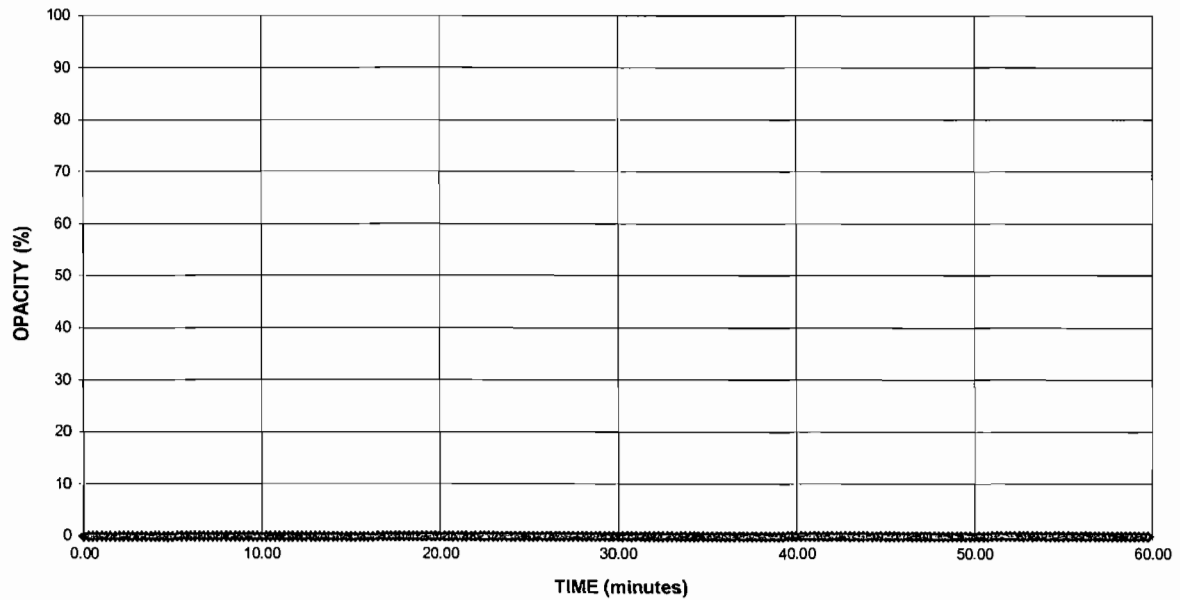

Method Used (Circle One) Method 9 203A 203B Other: _____

VISUAL EMISSIONS OBSERVATION FORM

Company Name FLORIDA POWER AND LIGHT
 Facility Name WEST LONNLY ENERGY CENTER
 Street Address 20505 STATE ROAD 80
 City LOXAHATCHEE State FL Zip 33470

Form Number _____ Page 1 of 2
 Continued on Form Number _____

Process FUEL OIL Unit # 3C Operating Mode BASE
 Control Equipment HRSG Operating Mode BASE

Observation Date 4-7-11 Time Zone EDT Start Time 13:00 End Time 14:00

Describe Emission Point
SOUTHERN MOST STACK IN GROUP OF 3 ON BLOCK 3

Min	Sec	0	15	30	45	Comments
-----	-----	---	----	----	----	----------

Height of Emiss. Pt. Start 150 ft. End SAME Height of Emiss. Pt. Rel. to Observer Start 150 ft. End SAME
 Distance to Emiss. Pt. Start 300 ft. End SAME Direction to Emiss. Pt. (Degrees) Start 340° End SAME

1	0	0	0	0	
2	0	0	0	0	
3	0	0	0	0	
4	0	0	0	0	
5	0	0	0	0	
6	0	0	0	0	
7	0	0	0	0	
8	0	0	0	0	
9	0	0	0	0	
10	0	0	0	0	
11	0	0	0	0	
12	0	0	0	0	
13	0	0	0	0	
14	0	0	0	0	
15	0	0	0	0	
16	0	0	0	0	
17	0	0	0	0	
18	0	0	0	0	
19	0	0	0	0	
20	0	0	0	0	
21	0	0	0	0	
22	0	0	0	0	
23	0	0	0	0	
24	0	0	0	0	
25	0	0	0	0	
26	0	0	0	0	
27	0	0	0	0	
28	0	0	0	0	
29	0	0	0	0	
30	0	0	0	0	

Vertical Angle to Obs. Pt. Start 16° End SAME Direction to Obs. Pt. (Degrees) Start 340° End SAME
 Distance and Direction to Observation Point from Emission Point Start 0' 0" End SAME

Describe Emissions Start N/A End SAME Water Droplet Plume Start NONE End SAME
 Emission Color Start N/A End SAME

Describe Plume Background Start PARTICULAR SKY / SAME Broken
 Background Color Start WHITE/BLUE End SAME Sky Conditions Start SCATTERED End SAME
 Wind Speed Start 14 mph End SAME Wind Direction Start ESE End SAME
 Ambient Temp Start 82° End SAME Wet Bulb Temp 68° RH Percent 62%

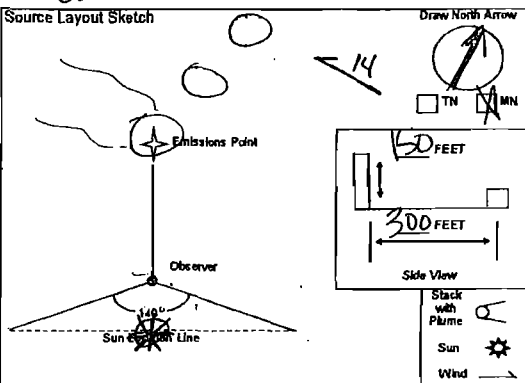

Latitude 26° 41' 18" N Longitude 80° 22' 34" W Declination _____

Observer's Name (Print) SIDNEY GASTON
 Observer's Signature _____ Date 4-7-11
 Organization FLORIDA AIR HYGIENE
 Certified By MARTY HUGHES, ETA Date 10-11-10

Additional Information _____

Method Used (Circle One)
 Method 9 203A 203B Other: _____

VISUAL EMISSIONS OBSERVATION FORM

Form Number _____ Page 2 of 2

Company Name
FLORIDA POWER AND LIGHT

Facility Name
WEST COUNTY ENERGY CENTER

Street Address
20505 STATE ROAD 80

City State Zip
LOLAHATCHEE FL 33410

Continued on Form Number _____

Process
FUEL OIL Unit **3C** Operating Mode **BASE**

Control Equipment
HRSG Operating Mode **BASE**

Observation Date
4-7-11 Time Zone **EDT** Start Time **13:00** End Time **14:00**

Describe Emissions Point
SOUTHERN MOST STACK IN GROUP OF 3 ON BLOCK 3 (C)

Height of Emiss. Pt. Start **150 FT** End **SAME** Height of Emiss. Pt. Rel. to Observer Start **150 FT** End **SAME**

Distance to Emiss. Pt. Start **300 FT** End **SAME** Direction to Emiss. Pt. (Degrees) Start **340°** End **SAME**

No.	Sec.				Comments
	0	15	30	45	
1	0	0	0	0	
2	0	0	0	0	
3	0	0	0	0	
4	0	0	0	0	
5	0	0	0	0	
6	0	0	0	0	
7	0	0	0	0	
8	0	0	0	0	
9	0	0	0	0	
10	0	0	0	0	
11	0	0	0	0	
12	0	0	0	0	
13	0	0	0	0	
14	0	0	0	0	
15	0	0	0	0	
16	0	0	0	0	
17	0	0	0	0	
18	0	0	0	0	
19	0	0	0	0	
20	0	0	0	0	
21	0	0	0	0	
22	0	0	0	0	
23	0	0	0	0	
24	0	0	0	0	
25	0	0	0	0	
26	0	0	0	0	
27	0	0	0	0	
28	0	0	0	0	
29	0	0	0	0	
30	0	0	0	0	

Vertical Angle to Obs. Pt. Start **110°** End **SAME** Direction to Obs. Pt. (Degrees) Start **340°** End **SAME**

Distance and Direction to Observation Point from Emission Point Start **0' 0"** End **SAME**

Describe Emissions
 Start **N/A** End **SAME** Water Droplet Plume Start **NONE** End **SAME**

Describe Plume Background
 Start **PARTLY CLOUDY SKY** Sky Conditions Start **SCATTERED** End **BROKEN**

Background Color Start **WHITE/BLUE** End **SAME** Wind Speed Start **14 mph** End **SAME** Wind Direction Start **E SE** End **SAME**

Ambient Temp. Start **82°** End **SAME** Wet Bulb Temp. Start **68°** End **SAME** RH Percent Start **62%** End **70%**

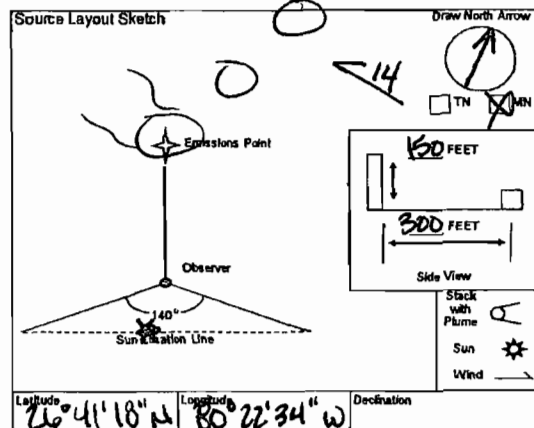

Observer's Name (Print)
SIDNEY GASTON

Observer's Signature
[Signature] Date **4-7-11**

Organization
AIR HYGIENE

Certified By
ETA Date **10-19-10**

Additional Information

Method Used (Circle One) Method 9 203A 203B Other: _____

VISUAL EMISSIONS OBSERVATION FORM

Form Number _____ Page 1 of 2

Company Name FLORIDA POWER AND LIGHT
 Facility Name WEST COUNTY ENERGY CENTER
 Street Address 20505 STATE ROAD 80
 City LOXAHATCHEE State FL Zip 32470

Continued on Form Number _____

Process FUEL OIL Unit # 3C Operating Mode BASE
 Control Equipment HRSG Operating Mode BASE

Observation Date 4-7-11 Time Zone EDT Start Time 14:00 End Time 14:30

Describe Emissions Point
SOUTHERNMOST STACK IN GROUP OF 3 ON BLOCK 3 (C)
 Height of Emiss. Pt. Start 150 End SAME Height of Emiss. Pt. Rel. to Observer Start 150 End SAME
 Distance to Emiss. Pt. Start 300 End SAME Direction to Emiss. Pt. (Degrees) Start 340 End SAME

No.	Sec.	Time				Comments
		0	15	30	45	

Vertical Angle to Obs. Pt. Start 16° End SAME Direction to Obs. Pt. (Degrees) Start 340° End _____
 Distance and Direction to Observation Point from Emission Point Start 0' 0" End SAME

1	0	0	0	0	
2	0	0	0	0	
3	0	0	0	0	
4	0	0	0	0	
5	0	0	0	0	
6	0	0	0	0	
7	0	0	0	0	
8	0	0	0	0	
9	0	0	0	0	
10	0	0	0	0	
11	0	0	0	0	
12	0	0	0	0	
13	0	0	0	0	
14	0	0	0	0	
15	0	0	0	0	
16	0	0	0	0	
17	0	0	0	0	
18	0	0	0	0	
19	0	0	0	0	
20	0	0	0	0	
21	0	0	0	0	
22	0	0	0	0	
23	0	0	0	0	
24	0	0	0	0	
25	0	0	0	0	
26	0	0	0	0	
27	0	0	0	0	
28	0	0	0	0	
29	0	0	0	0	
30	0	0	0	0	

Describe Emissions Start N/A End SAME Water Droplet Plume Start NONE End NONE
 Emission Color Start N/A End SAME

Describe Plume Background Start CLOUDY SKY End SAME Sky Conditions Start SCATTERED End SAME
 Background Color Start WHITE/BLUE End SAME Wind Speed Start 16 mph End 13 mph Wind Direction Start ESE End SAME
 Ambient Temp. Start 80° End 83° Wet Bulb Temp. 68 RH Percent 100%

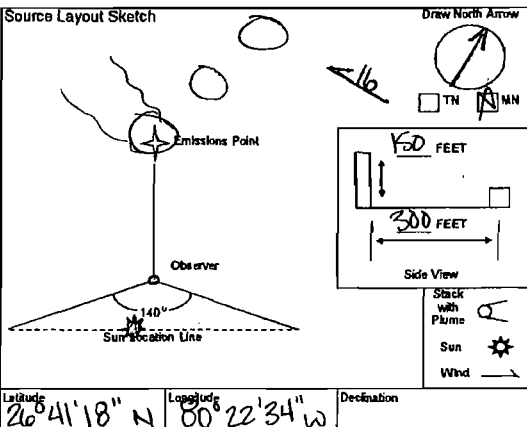

Observer's Name (Print) SIDNEY GASTON

Additional Information _____

Observer's Signature _____ Date 4-7-11

Organization AIR HYGIENE

Certified By ETA Date 10-19-10

Method Used (Circle One) Method 9 203A 203B Other: _____

VISUAL EMISSIONS OBSERVATION FORM

Form Number _____ Page 2 of 2

Company Name FLORIDA POWER AND LIGHT
 Facility Name WEST COUNTY ENERGY CENTER
 Street Address LOSOS STATE ROAD 80
 City LOXAHATCHEE State FL Zip 33470

Continued on Form Number _____

Process FUEL OIL Unit # 3C Operating Mode BASE
 Control Equipment HRS9 Operating Mode BASE

Observation Date 4-7-11 Time Zone EDT Start Time 14:30 End Time 15:00

Describe Emissions Point
SOUTHERNMOST STACK IN
GROUP OF 3 ON BLOCK 3 (C)
 Height of Emiss. Pt. Start 150 FT End SAME Height of Emiss. Pt. Rel. to Observer Start 150 FT End SAME
 Distance to Emiss. Pt. Start 30 FT End SAME Direction to Emiss. Pt. (Degrees) Start 340° End SAME

No.	Sec	0	15	30	45	Comments
-----	-----	---	----	----	----	----------

Vertical Angle to Obs. Pt. Start 16° End SAME Direction to Obs. Pt. (Degrees) Start 340° End SAME
 Distance and Direction to Observation Point from Emission Point Start 0' 0" End SAME

1	0	0	0	0	
2	0	0	0	0	
3	0	0	0	0	
4	0	0	0	0	
5	0	0	0	0	
6	0	0	0	0	
7	0	0	0	0	
8	0	0	0	0	
9	0	0	0	0	
10	0	0	0	0	
11	0	0	0	0	
12	0	0	0	0	
13	0	0	0	0	
14	0	0	0	0	
15	0	0	0	0	
16	0	0	0	0	
17	0	0	0	0	
18	0	0	0	0	
19	0	0	0	0	
20	0	0	0	0	
21	0	0	0	0	
22	0	0	0	0	
23	0	0	0	0	
24	0	0	0	0	
25	0	0	0	0	
26	0	0	0	0	
27	0	0	0	0	
28	0	0	0	0	
29	0	0	0	0	
30	0	0	0	0	

Describe Emissions
 Start N/A End SAME Water Droplet Plume Start NONE End SAME
 Emission Color Start N/A End SAME

Describe Plume Background
 Start CLOUDY SKY End SAME Sky Conditions Start SCATTERED End SAME
 Background Color Start WHITE/BLUE End SAME
 Wind Speed Start 11 mph End 13 mph Wind Direction Start ESE End SAME
 Ambient Temp. Start 80° End 83° Wet Bulb Temp. 68° RH Percent 106%

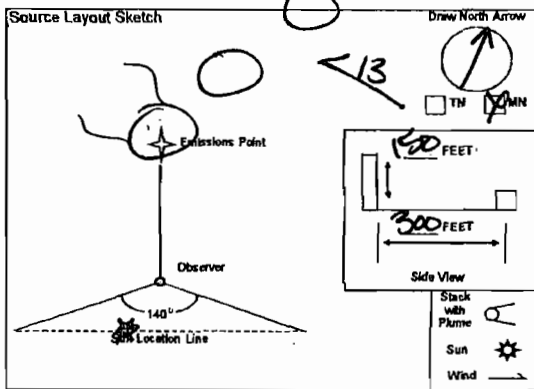

Latitude 26° 41' 18" N Longitude 80° 22' 34" W Declination _____

Observer's Name (Print) SIDNEY GASTON
 Observer's Signature [Signature] Date 4-7-11
 Organization AIR HYGIENE
 Certified By ETA Date 10-9-10

Additional Information _____

Method Used (Circle One)
 Method 9 203A 203B Other: _____

VISUAL EMISSIONS OBSERVATION FORM

Form Number _____ Page 1 of 2

Company Name
FLORIDA POWER AND LIGHT

Facility Name
WEST COUNTY ENERGY CENTER

Street Address
20505 STATE ROAD 80

City
LOUHAATCHEE FL 33470

Continued on Form Number _____

Process
FUEL OIL Unit # **3C** Operating Mode **BASE**

Control Equipment
HPSG Operating Mode **BASE**

Observation Date
4-7-11 Time Zone
EDT Start Time
15:00 End Time
15:00

Describe Emissions Point
SOUTHERNMOST STACK IN GROUP OF 3 ON BLOCK 3 (C)

Height of Emiss. Pt. Start **150 FT** End **SAME** Height of Emiss. Pt. Rel. to Observer Start **150 FT** End **SAME**

Distance to Emiss. Pt. Start **300 FT** End **SAME** Direction to Emiss. Pt. (Degrees) Start **340°** End **SAME**

Min.	Sec	0	15	30	45	Comments
------	-----	---	----	----	----	----------

Vertical Angle to Obs. Pt. Start **16°** End **SAME** Direction to Obs. Pt. (Degrees) Start **340°** End _____

Distance and Direction to Observation Point from Emission Point Start **0° 0'** End **SAME**

1	0	0	0	0	
2	0	0	0	0	
3	0	0	0	0	
4	0	0	0	0	
5	0	0	0	0	
6	0	0	0	0	
7	0	0	0	0	
8	0	0	0	0	
9	0	0	0	0	
10	0	0	0	0	
11	0	0	0	0	
12	0	0	0	0	
13	0	0	0	0	
14	0	0	0	0	
15	0	0	0	0	
16	0	0	0	0	
17	0	0	0	0	
18	0	0	0	0	
19	0	0	0	0	
20	0	0	0	0	
21	0	0	0	0	
22	0	0	0	0	
23	0	0	0	0	
24	0	0	0	0	
25	0	0	0	0	
26	0	0	0	0	
27	0	0	0	0	
28	0	0	0	0	
29	0	0	0	0	
30	0	0	0	0	

Describe Emissions Start **N/A** End **SAME** Water Droplet Plume Start **NONE** End **NONE**

Describe Plume Background Start **CLOUDY SKY** Sky Conditions Start **SCATTERED** End _____

Background Color Start **WHITE/BLUE** End _____ Wind Speed Start **13 mph** End **SAME** Wind Direction Start **ESE** End **SAME**

Ambient Temp. Start **85°** End _____ Wet Bulb Temp. **68%** RH Percent **60%**

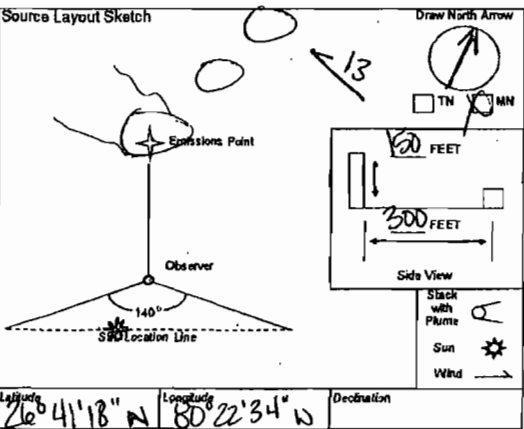

Observer's Name (Print)
SIDNEY GASTON

Observer's Signature
[Signature] Date
4-7-11

Organization
FLORIDA AIR HYGIENE

Certified By
MARY HUGHES, ETA Date
10-19-10

Additional Information

Method Used (Circle One)
 Method 9 203A 203B Other: _____

Company Name
FLORIDA POWER AND LIGHT

Facility Name
WEST COUNTY ENERGY CENTER

Street Address
20505 STATE ROAD 80

City
LOXAHATCHEE State **FL** Zip **33470**

Process
FUEL OIL Unit # **2C** Operating Mode **BASE**

Control Equipment
FRSG Operating Mode **BASE**

Describe Emissions Point
SOUTHERN MOST STACK IN GROUP OF 3 ON BLOCK 3 (C)

Height of Emiss. Pt. Start **150 ft** End **SAME** Height of Emiss. Pt. Rel. to Observer Start **150 ft** End **SAME**

Distance to Emiss. Pt. Start **500 ft** End **SAME** Direction to Emiss. Pt. (Degrees) Start **340°** End **SAME**

Vertical Angle to Obs. Pt. Start **16°** End **SAME** Direction to Obs. Pt. (Degrees) Start **340°** End **SAME**

Distance and Direction to Observation Point from Emission Point Start **0°** End **SAME**

Describe Emissions
Start **N/A** End **SAME** Water Droplet Plume Start **NONE** End **SAME**

Describe Plume Background
Start **CLOUDY SKY** End **SAME** Sky Conditions Start **SCATTERED** End **SAME**

Background Color Start **WHITE** End **SAME** Wind Speed Start **13 mph** End **13 mph** Wind Direction Start **ESE** End **SAME**

Ambient Temp. Start **83°** End **SAME** Wet Bulb Temp. Start **68°** End **68°** RH Percent **60%**

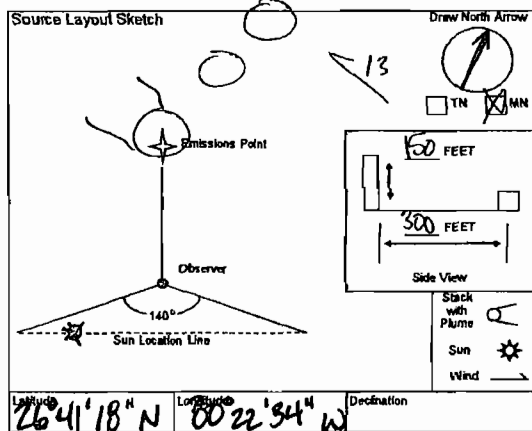

Additional Information

VISUAL EMISSIONS OBSERVATION FORM

Form Number _____ Page **2** of **2**

Continued on Form Number _____

Observation Date	Time Zone	Start Time	End Time	Comments	
4-7-11	EDT	15:30	16:00		
Min.	Sec.	0	15	30	45
1	0	0	0	0	
2	0	0	0	0	
3	0	0	0	0	
4	0	0	0	0	
5	0	0	0	0	
6	0	0	0	0	
7	0	0	0	0	
8	0	0	0	0	
9	0	0	0	0	
10	0	0	0	0	
11	0	0	0	0	
12	0	0	0	0	
13	0	0	0	0	
14	0	0	0	0	
15	0	0	0	0	
16	0	0	0	0	
17	0	0	0	0	
18	0	0	0	0	
19	0	0	0	0	
20	0	0	0	0	
21	0	0	0	0	
22	0	0	0	0	
23	0	0	0	0	
24	0	0	0	0	
25	0	0	0	0	
26	0	0	0	0	
27	0	0	0	0	
28	0	0	0	0	
29	0	0	0	0	
30	0	0	0	0	

Observer's Name (Print)
SIDNEY GASTON

Observer's Signature
[Signature] Date **4-7-11**

Organization
AIR HYGIENE

Certified By
EPA Date **10-19-10**

CALCULATIONS

EXAMPLE CALCULATIONS (INFORMATION)

Specific Humidity (RH_{sp})

Note: RH_{sp} (gr/lb) calculated using temperature, relative humidity, and barometric pressure with psychrometric chart, psychrometric calculator, or built in psychrometric algorithm.

$$RH_{sp} \text{ (lb/lb)} = \left[\left(\frac{\text{gr}}{\text{lb}} \right) \times \frac{\text{lb}}{7000 \text{ gr}} \right]$$

$$RH_{sp} = \frac{99.30 \text{ gr}}{\text{lb}} \times \frac{1 \text{ lb}}{7000 \text{ gr}} = 0.014186 \frac{\text{lb H}_2\text{O}}{\text{lb Air}}$$

Combustor Inlet Pressure / Compressor Discharge Pressure (CIP / CDP)

(corrected from gauge to atmospheric pres. and conv. to mm Hg.)

Note: CIP / CDP (psig) is a value obtained from the source operator.

$$CIP / CDP = \left[(\text{psig} + P) \times \frac{51.71493 \text{ mmHg}}{1 \text{ psi}} \right]$$

$$CIP / CDP = [259.0 \text{ psig} + 14.7985] \times \frac{51.71493 \text{ mmHg}}{1 \text{ psia}} = 14,162 \text{ mmHg (abs)}$$

Heat Rate (MMBtu/hr)

$$\text{Heat Rate} = \frac{981,251.22 \text{ Btu}}{\text{SCF}} \times \frac{2,087.04 \text{ SCF}}{\text{hr}} \times \frac{\text{MMBtu}}{10^6 \text{ Btu}} = \frac{2,047.91 \text{ MMBtu}}{\text{hr}}$$

Note: Lack of significant figures may cause rounding errors between actual calculations and example calculations.

EXAMPLE CALCULATIONS (CALIBRATION)

Analyzer Calibration Error

RM 7E, (12-17-09), 12.2 Analyzer Calibration Error. For non-dilution systems, use Equation 7E-1 to calculate the analyzer calibration error for the low-, mid-, and high-level calibration gases. (calc for NOx analyzer mid gas, if applicable)

$$\Delta CE = \left(\frac{C_{Dir} - C_F}{CS} \right) \times 100$$

Eq. 7E-1

$$ACE = \frac{12.50 \text{ ppm} - 12.10 \text{ ppm}}{23.60 \text{ ppm}} \times 100 = 1.69 \%$$

Calibration Error and Estimated Point, RM 25A, THC Analyzer

RM 25A, (12-17-09), 8.4 Calibration Error Test. Immediately prior to the test series (within 2 hours of the start of the test), introduce zero gas and high-level calibration gas at the calibration valve assembly. Adjust the analyzer output to the appropriate levels, if necessary. Calculate the predicted response for the low-level and mid-level gases based on a linear response line between the zero and high-level response. Then introduce low-level and mid-level calibration gases successively to the measurement system. ... These differences must be less than 5 percent of the respective calibration gas value. (calc for THC analyzer mid gas, if applicable)

$$E_p = \frac{C_{Dir(H)} - C_{Dir(L)}}{C_{V(H)} - C_{V(L)}} \times C_{Dir(M)} + C_{Dir(Z)}$$

Eq. of a line
y=mx+b

$$E_p = \frac{8.49 \text{ ppm} - 0.02 \text{ ppm}}{8.46 \text{ ppm} - 0.00 \text{ ppm}} \times 4.76 \text{ ppm} + 0.02 = 4.77 \text{ ppm}$$

$$\Delta CE = \left(\frac{C_{Dir} - C_F}{CS} \right) \times 100$$

Eq. 7E-1

$$ACE_{THC} = \frac{4.97 \text{ ppm} - 4.77 \text{ ppm}}{4.76 \text{ ppm}} \times 100 = 4.24 \%$$

Note: Lack of significant figures may cause rounding errors between actual calculations and example calculations.

EXAMPLE CALCULATIONS (BIAS, DRIFT, AND CORRECTED RAW AVERAGE)

System Bias

RM 7E, (12-17-09), 12.3 System Bias. For non-dilution systems, use Equation 7E-2 to calculate the system bias separately for the low-level and upscale calibration gases. (calc for NOx analyzer upscale gas, Run 1 initial bias, if applicable)

$$SB = \left(\frac{C_s - C_{Dr}}{CS} \right) \times 100 \quad \text{Eq. 7E-2} \quad SB = \frac{12.14 \text{ ppm} - 12.50 \text{ ppm}}{23.60 \text{ ppm}} \times 100 = -1.53 \%$$

Drift Assessment

RM 7E, (12-17-09), 12.5 Drift Assessment. Use Equation 7E-4 to separately calculate the low-level and upscale drift over each test run. (calc for NOx analyzer upscale drift, Run 1, if applicable)

$$D = |SB_{Run2} - SB_1| \quad \text{Eq. 7E-4} \quad D = | -1.69 \% - -1.53 \% | = 0.17 \%$$

Alternative Drift and Bias

RM 7E, (12-17-09), 13.2 / 13.3 System Bias and Drift. Alternatively, the results are acceptable if |Cs - Cdir| is ≤ 0.5 ppmv or if |Cs - Cv| is ≤ 0.5 ppmv (as applicable). (calc for NOx analyzer initial upscale, Run 1, if applicable)

$$SB / D_{Alt} = |C_s - C_{Dir}| \quad \text{Eq. Section 13.2 and 13.3} \quad SB / D_{Alt} = | 12.14 \text{ ppm} - 12.50 \text{ ppm} | = 0.36 \text{ ppm}$$

Bias Adjusted Average

RM 7E, (12-17-09), 12.6 Effluent Gas Concentration. For each test run, calculate Cavg, the arithmetic average of all valid NOx concentration values (e.g., 1-minute averages). Then adjust the value of Cavg for bias, using Equation 7E-5b. (calc for NOx analyzer, Run 1, if applicable)

$$C_{Gas} = (C_{Avg} - C_o) \times \left(\frac{C_{Std}}{C_M - C_o} \right) \quad \text{Eq. 7E-5b} \quad C_{Gas} = \left(7.58 \text{ ppm} - 0.03 \text{ ppm} \right) \times \left(\frac{12.10 \text{ ppm}}{12.12 \text{ ppm} - 0.03 \text{ ppm}} \right) = 7.56 \text{ ppm}$$

EXAMPLE CALCULATIONS (RUNS)

Stack Exhaust Flow (Qs) - RM19

$$Q_s = \left(\frac{FFactor \times Q_j \times LHV}{1,000,000} \right) \times \left(\frac{20.9\%}{20.9\% - C_{Gas(O_2)}} \right) \quad Q_s = \frac{9,292.34 \text{ SCF}}{\text{MMBtu}} \times \frac{2,087.04 \text{ SCF}}{\text{hr}} \times \frac{981,251.22 \text{ Btu}}{\text{SCF}} \times \frac{\text{MMBtu}}{10^6 \text{ Btu}} \times \left[\frac{20.90\%}{20.9\% - 13.6\%} \right] = 54,267,453.07 \text{ SCFH}$$

Diluent-Corrected Pollutant Concentration, O₂ Based

RM 20, (11-26-02), 7.3.1 Correction of Pollutant Concentration Using O₂ Concentration. Calculate the O₂ corrected pollutant concentration, as follows: (calc for NOx gas, Run 1, if applicable)

$$C_{adj} = C_{Gas(T_{avg})} \times \left(\frac{20.9\% - AdjFactor}{20.9\% - C_{Gas(O_2)}} \right) \quad \text{Eq. 20-4} \quad C_{adj} = 7.56 \text{ ppm} \times \left(\frac{20.9\% - 15.00\%}{20.9\% - 13.57\%} \right) = 6.08 \text{ ppm@15\%O}_2$$

Diluent-Corrected Pollutant Concentration Corrected to ISO Conditions

40CFR60.335(b)(1), Conversion for conc. at ISO Conditions (68°F, 1 atm). Calculate, as follows: (calc for NOx@15% with Run 1 data, if applicable)

$$C_{ISO} = C_{Adj} \times \sqrt{\frac{P_r}{P_o}} \times e^{(19 \times (H_o - 0.00633) \cdot j)} \times \left(\frac{288}{T_a} \right)^{1.53} \quad C_{ISO} = 6.08 \text{ ppm@15\%O}_2 \times \sqrt{\frac{259.0 \text{ psig} + 14.69232 \text{ psi}}{259.0 \text{ psig} + 14.7985 \text{ psi}}} \times \left(\frac{288 \text{ K}}{301 \text{ K}} \right)^{1.53} = 6.58 \text{ ppm@15\% and ISO}$$

Note: Lack of significant figures may cause rounding errors between actual calculations and example calculations.

EXAMPLE CALCULATIONS (RUNS)

Emissions Rate (lb/hr)

Calculation for pound per hour emission rate. Calculate, as follows: (calc for NOx gas Run 1, if applicable)

$$E_{lb/hr} = \frac{C_{Gas}}{10^6} \times \frac{Q_s \times MWF}{G} \qquad E_{lb/hr} = \frac{7.56 \text{ ppm}}{10^6 \text{ ppm/part}} \times \frac{54,267,453 \text{ SCFH} \times 46.01 \text{ lb/lb-mol}}{385.23 \text{ SCF/lb-mol}} = \frac{48.99 \text{ lb}}{\text{hr}}$$

Emissions Rate (ton/year)

Calculation for tons per year emission rate based on 500 hours per year. Calculate, as follows: (calc for NOx gas Run 1, if applicable)

$$E_{2013} = \frac{E_{lb/hr} \times \text{hr}_{year}}{2000} \qquad E_{ton/yr} = \frac{48.99 \text{ lb}}{\text{hr}} \times \frac{500 \text{ hr}}{\text{year}} \times \frac{\text{ton}}{2000 \text{ lb}} = \frac{12.25 \text{ ton}}{\text{year}}$$

Emissions Rate (lb/MMBtu)

RM 19, (12-17-09), 12.2 Emission Rates of PM, SO₂, and NOx. Select from the following sections the applicable procedure to compute the PM, SO₂, or NOx emission rate (E) in ng/J (lb/million Btu). (calc for NOx gas Run 1, if applicable)

Oxygen Based

12.2.1 Oxygen-Based F Factor, Dry Basis. When measurements are on a dry basis for both O₂ (%O₂d) and pollutant (Cd) concentrations, use the following equation:

$$E_{lb/MMBtu} = \frac{C_{Gas} \times F_d \text{ Factor} \times Conv_c \times 20.9\%}{20.9\% - C_{Gas(O_2)}} \qquad \text{Eq. 19-1}$$

$$E_{lb/MMBtu} = \frac{7.56 \text{ ppm} \times 9,292.34 \text{ SCF/MMBtu} \times 0.0000001194 \text{ lb/ppm} \cdot \text{ft}^3 \times 20.9\%}{20.9\% - 13.57\%} = \frac{0.024 \text{ lb}}{\text{MMBtu}}$$

Conversion Constant

Conv_c for NOx

$$Conv_c (\text{lb} / \text{ppm} \cdot \text{ft}^3) = \frac{MWF}{10^6} \qquad Conv_c = \frac{46.01 \text{ lb}}{\text{lb} \cdot \text{mole}} \times \frac{\text{lb} \cdot \text{mole}}{385.23 \text{ SCF}} = \frac{0.0000001194 \text{ lb}}{\text{ppm} \cdot \text{ft}^3}$$

Note: Lack of significant figures may cause rounding errors between actual calculations and example calculations.

RM 7E, (08-15-06), 12.1 Nomenclature. The terms used in the equations are defined as follows:

ACE = Analyzer calibration error, percent of calibration span.
B_{WS} = Moisture content of sample gas as measured by Method 4 or other approved method, percent/100.
C_{avg} = Average unadjusted gas concentration indicated by data recorder for the test run.
C_D = Pollutant concentration adjusted to dry conditions.
C_{Dt} = Measured concentration of a calibration gas (low, mid, or high) when introduced in direct calibration mode.
C_{gas} = Average effluent gas concentration adjusted for bias.
C_{HA} = Average of initial and final system calibration bias (or 2-point system calibration error) check responses for the upscale calibration gas.
C_{MA} = Actual concentration of the upscale calibration gas, ppmv.
C_{LO} = Average of the initial and final system calibration bias (or 2-point system calibration error) check responses from the low-level (or zero) calibration gas.
C_S = Measured concentration of a calibration gas (low, mid, or high) when introduced in system calibration mode.
C_{SS} = Concentration of NOx measured in the spiked sample.
C_{spike} = Concentration of NOx in the undiluted spike gas.
C_{calc} = Calculated concentration of NOx in the spike gas diluted in the sample.
C_V = Manufacturer certified concentration of a calibration gas (low, mid, or high).
C_W = Pollutant concentration measured under moist sample conditions, wet basis.
CS = Calibration span.
D = Drift assessment, percent of calibration span.
E_p = The predicted response for the low-level and mid-level gases based on a linear response line between the zero and high-level response.
Eff_{NO2} = NO₂ to NO converter efficiency, percent.
H = High calibration gas, designator.
L = Low calibration gas, designator.
M = Mid calibration gas, designator.
NOFinal = The average NO concentration observed with the analyzer in the NO mode during the converter efficiency test in Section 16.2.2.
NOxCorr = The NOx concentration corrected for the converter efficiency.
NOxFinal = The final NOx concentration observed during the converter efficiency test in Section 16.2.2.
NOxPeak = The highest NOx concentration observed during the converter efficiency test in Section 16.2.2.
Q_{spike} = Flow rate of spike gas introduced in system calibration mode, L/min.
Q_{Total} = Total sample flow rate during the spike test, L/min.
R = Spike recovery, percent.
SB = System bias, percent of calibration span.
SB_i = Pre-run system bias, percent of calibration span.
SB_f = Post-run system bias, percent of calibration span.
SB / D_{ab} = Alternative absolute difference criteria to pass bias and/or drift checks.
SCE = System calibration error, percent of calibration span.
SCE_i = Pre-run system calibration error, percent of calibration span.
SCE_{final} = Post-run system calibration error, percent of calibration span.
Z = Zero calibration gas, designator.

40CFR60.355(b)(1), (09-20-06), Nomenclature. The terms used in the equations are defined as follows:

P_i = reference combustor inlet absolute pressure at 101.3 kilopascals ambient pressure, mm Hg
P_a = observed combustor inlet absolute pressure at test, mm Hg
H_a = observed humidity of ambient air, g H₂O/g air
e = transcendental constant, 2.718
T_a = ambient temperature, K

Small Engine and FTIR Nomenclature. The terms used in the equations are defined as follows:

bhp = brake horsepower
hp = horsepower
Q_{sys} = system flow (lpm)
Q_m = matrix spike flow (lpm)

RM 19, (07-29-06), 12.1 Nomenclature. The terms used in the equations are defined as follows:

AdjFactor = Percent oxygen or carbon dioxide adjustment applied to a target pollutant
 B_{wa} = Moisture fraction of ambient air, percent.
 Btu = British thermal unit
 $\%_C$ = Concentration of carbon from an ultimate analysis of fuel, weight percent.
 $\%_{CO_2d}, \%_{CO_2w}$ = Concentration of carbon dioxide on a dry and wet basis, respectively, percent.
 CIP / CDP = Combustor inlet pressure / compressor discharge pressure (mm Hg); note, some manufactures reference as PCD.
 E = Pollutant emission rate, ng/J (lb/million Btu).
 E_a = Average pollutant rate for the specified performance test period, ng/J (lb/million Btu).
 E_{ao}, E_{ai} = Average pollutant rate of the control device, outlet and inlet, respectively, for the performance test period, ng/J (lb/million Btu).
 E_{st} = Pollutant rate from the steam generating unit, ng/J (lb/million Btu).
 E_{so} = Pollutant emission rate from the steam generating unit, ng/J (lb/million Btu).
 E_{ci} = Pollutant rate in combined effluent, ng/J (lb/million Btu).
 E_{co} = Pollutant emission rate in combined effluent, ng/J (lb/million Btu).
 E_d = Average pollutant rate for each sampling period (e.g., 24-hr Method 6B sample or 24-hr fuel sample) or for each fuel lot (e.g., amount of fuel bunkered), ng/J (lb/million Btu).
 E_{di} = Average inlet SO₂ rate for each sampling period d, ng/J (lb/million Btu).
 E_g = Pollutant rate from gas turbine, ng/J (lb/million Btu).
 E_{ga} = Daily geometric average pollutant rate, ng/J (lb/million Btu) or ppm corrected to 7 percent O₂.
 E_{p}, E_{p} = Matched pair hourly arithmetic average pollutant rate, outlet and inlet, respectively, ng/J (lb/million Btu) or ppm corrected to 7 percent O₂.
 E_h = Hourly average pollutant, ng/J (lb/million Btu).
 E_{ha} = Hourly arithmetic average pollutant rate for hour "j," ng/J (lb/million Btu) or ppm corrected to 7 percent O₂.
 EXP = Natural logarithmic base (2.718) raised to the value enclosed by brackets.
 F_c = Ratio of the volume of carbon dioxide produced to the gross calorific value of the fuel from Method 19
 F_d, F_w, F_c = Volumes of combustion components per unit of heat content, scm/J (scf/million Btu).
 ft^3 = cubic feet
 G = ideal gas conversion factor
 (385.23 SCF/lb-mol at 68 deg F & 14.696 psia)
 GCM = gross Btu per SCF (constant, compound based)
 GCV = Gross calorific value of the fuel consistent with the ultimate analysis, kJ/kg (Btu/lb).
 GCV_p, GCV_r = Gross calorific value for the product and raw fuel lots, respectively, dry basis, kJ/kg (Btu/lb).
 $\%_H$ = Concentration of hydrogen from an ultimate analysis of fuel, weight percent.
 H_b = Heat input rate to the steam generating unit from fuels fired in the steam generating unit, J/hr (million Btu/hr).
 H_g = Heat input rate to gas turbine from all fuels fired in the gas turbine, J/hr (million Btu/hr).
 $\%_{H_2O}$ = Concentration of water from an ultimate analysis of fuel, weight percent.
 H_t = Total numbers of hours in the performance test period (e.g., 720 hours for 30-day performance test period).
 K = volume of combustion component per pound of component (constant)
 K = Conversion factor, 10^{-3} (kJ/J)/(%) [10^6 Btu/million Btu].
 $K_C = (9.57 \text{ scm/kg})/\% [(1.53 \text{ scf/lb})/\%]$
 $K_{CO} = (2.0 \text{ scm/kg})/\% [(0.321 \text{ scf/lb})/\%]$
 $K_{H_2O} = (22.7 \text{ scm/kg})/\% [(3.64 \text{ scf/lb})/\%]$
 $K_{N_2} = (34.74 \text{ scm/kg})/\% [(5.57 \text{ scf/lb})/\%]$
 $K_N = (0.86 \text{ scm/kg})/\% [(0.14 \text{ scf/lb})/\%]$
 $K_O = (2.85 \text{ scm/kg})/\% [(0.46 \text{ scf/lb})/\%]$
 $K_S = (3.54 \text{ scm/kg})/\% [(0.57 \text{ scf/lb})/\%]$
 $K_{stair} = 2 \times 10^4 \text{ Btu/hr}/\% \text{-MMBtu}$
 $K_w = (1.30 \text{ scm/kg})/\% [(0.21 \text{ scf/lb})/\%]$
 lb = pound
 ln = Natural log of indicated value.
 L_p, L_r = Weight of the product and raw fuel lots, respectively, metric ton (ton).
 $\%_N$ = Concentration of nitrogen from an ultimate analysis of fuel, weight percent.
 M_w = mole percent
 mol = mole
 MW = molecular weight (lb/lb-mol)
 MW_{AIR} = molecular weight of air (28.9625 lb/lb-mole)³
 NCM = net Btu per SCF (constant based on compound)
 $\%_O$ = Concentration of oxygen from an ultimate analysis of fuel, weight percent.
 $\%_{O_2d}, \%_{O_2w}$ = Concentration of oxygen on a dry and wet basis, respectively, percent.
 P_a = barometric pressure, in Hg
 P_s = Potential SO₂ emissions, percent.
 $\%_S$ = Sulfur content of as-fired fuel lot, dry basis, weight percent.
 S_d = Standard deviation of the hourly average pollutant rates for each performance test period, ng/J (lb/million Btu).
 $\%_{Sf}$ = Concentration of sulfur from an ultimate analysis of fuel, weight percent.
 $S(wt\%)$ = weight percent of sulfur, per lab analysis by appropriate ASTM standard
 S_i = Standard deviation of the hourly average inlet pollutant rates for each performance test period, ng/J (lb/million Btu).
 S_e = Standard deviation of the hourly average emission rates for each performance test period, ng/J (lb/million Btu).
 $\%S_p, \%S_r$ = Sulfur content of the product and raw fuel lots respectively, dry basis, weight percent.
 SCF = standard cubic feet
 SH = specific humidity, pounds of water per pound of air
 $t_{0.95}$ = Values shown in Table 19-3 for the indicated number of data points n.
 T_{amb} = ambient temperature, °F
 W/D Factor = 1.0236 = conv. at 14.696 psia and
 68 deg F (ref. Civil Eng. Ref. Manual, 7th Ed.)
 X_{CO_2} = CO₂ Correction factor, percent.
 X_k = Fraction of total heat input from each type of fuel k.

Calculations, Formulas, and Constants

The following information supports the spreadsheets for this testing project.

Given Data:

Ideal Gas Conversion Factor = 385.23 SCF/lb-mol at 68 deg F & 14.696 psia

Fuel Heating Value is based upon Air Hygiene's fuel gas calculation sheet. All calculations are based upon a correction to 68 deg F & 14.696 psia

High Heating Values (HHV) are used for the Fuel Heating Value, F-Factor, and Fuel Flow Data per EPA requirements.

ASTM D 3588

Molecular Weight of NOx (lb/lb-mole) = 46.01
 Molecular Weight of CO (lb/lb-mole) = 28.00
 Molecular Weight of SO₂ (lb/lb-mole) = 64.00
 Molecular Weight of THC (propane) (lb/lb-mole) = 44.00
 Molecular Weight of VOC (methane) (lb/lb-mole) = 16.00
 Molecular Weight of NH₃ (lb/lb-mole) = 17.03
 Molecular Weight of HCHO (lb/lb-mole) = 30.03

40CFR60, App. A, RM 19, Table 19-1

Conversion Constant for NOx = 0.0000001194351
 Conversion Constant for CO = 0.0000000726839
 Conversion Constant for SO₂ = 0.0000001661345
 Conversion Constant for THC = 0.0000001142175
 Conversion Constant for VOC (methane) = 0.0000000415336
 Conversion Constant for NH₃ = 0.0000000442074
 Conversion Constant for HCHO = 0.0000000779534
 NOTE: units are lb/ppm*hr³

Formulas:

1. Corrected Raw Average (C_{Gas}), 40CFR60, App. A, RM 7E, Eq. 7E-5 (08/15/06)

$$C_{Gas} = (C_{Avg} - C_D) \times \left(\frac{C_{MA}}{C_M - C_D} \right)$$

2. Correction to % O₂, 40CFR60, App. A, RM 20, Eq. 20-5 (11/26/02)

$$C_{adj} = C_{Gas(O_2)} \times \left(\frac{20.9\% - AdjFactor}{20.9\% - C_{Gas(O_2)}} \right)$$

3. Correction to % O₂ and ISO Conditions

$$C_{ISO} = C_{adj} \times \sqrt{\frac{P_r}{P_o}} \times e^{(12 \times (H_o - 0.00653))} \times \left(\frac{288}{T_o} \right)^{1.53}$$

4. Method 19 stack exhaust flow (scfh)

$$Q_s = \left(\frac{FFactor \times Q_f \times HHV}{1,000,000} \right) \times \left(\frac{20.9\%}{20.9\% - C_{Gas(O_2)}} \right)$$

5. Emission Rate in lb/hr

$$E_{lb/hr} = \frac{C_{Gas}}{10^6} \times \frac{Q_s \times MW}{G}$$

6. Emission Rate in tons per year

$$E_{ton/yr} = \frac{E_{lb/hr} \times hr_{year}}{2000}$$

7. Emission Concentration in lb/MMBtu (O₂ based)

$$E_{lb/MMBtu} = \frac{C_{Gas} \times F_d Factor \times Conv_c \times 20.9\%}{20.9\% - C_{Gas(O_2)}}$$

8. Emission Concentration in g/hp*hr

$$E_{g/hp-hr} = \frac{E_{lb/hr} \times 453.6}{mmv \times 1314.022} \text{ or } \frac{E_{lb/hr} \times 453.6}{hp}$$

RATA SHEET CALCULATIONS

d = Reference Method Data - CEMS Data

S_d = Standard Deviation

CC = Confident Coefficient

n = number of runs

t_{0.025} = 2.5 percent confidence coefficient T-values

RA = relative accuracy

ARA = alternative relative accuracy

BAF = Bias adjustment factor

n	t	n	t	n	t
2	12.706	7	2.447	12	2.201
3	4.303	8	2.365	13	2.179
4	3.182	9	2.306	14	2.160
5	2.776	10	2.262	15	2.145
6	2.571	11	2.228	16	2.131

1. Difference

$$d = \sum_{i=1}^n d_i$$

2. Standard Deviation

$$S_d = \sqrt{\frac{\sum_{i=1}^n d_i^2 - \frac{\left(\sum_{i=1}^n d_i \right)^2}{n}}{n-1}}$$

3. Confident Coefficient

$$CC = t_{0.025} \times \frac{S_d}{\sqrt{n}}$$

4. Relative Accuracy

$$RA = \frac{|d_{avg}| + |CC|}{RM_{avg}} \times 100$$

5. Alternative Relative Accuracy

$$ARA = \frac{|d_{avg}| + |CC|}{AS} \times 100$$

5. Bias Adjustment Factor

$$BAF = 1 + \left(\frac{|d_{avg}|}{CEM_{avg}} \right)$$

EXAMPLE CALCULATIONS (Reference Method 1 - Circular Stack)

Diameter of Stack (in.)

$$D(\text{in.}) = L_{fw} - L_{mv}$$

$$D(\text{in.}) = 282.38 \text{ in.} - 19.00 \text{ in.} = 263.38 \text{ in.}$$

Stack Diameters Downstream

$$B_D(\text{dia.}) = \frac{B}{D}$$

$$B_D(\text{dia.}) = \frac{531.75 \text{ in.}}{263.38 \text{ in.}} = 2.02 \text{ diameters}$$

Area of Stack (ft²)

$$A_s(\text{ft}^2) = \pi \times \left(\frac{D}{2 \times 12} \right)^2$$

$$A_s(\text{ft}^2) = 3.14 \times \left(\frac{263.38 \text{ in.}}{2 \times 12 \text{ in./ft}} \right)^2 = 378.35 \text{ ft}^2$$

Stack Diameters Upstream

$$A_D(\text{dia.}) = \frac{A}{D}$$

$$A_D(\text{dia.}) = \frac{144.00 \text{ in.}}{263.38 \text{ in.}} = 0.55 \text{ diameters}$$

Note: Lack of significant figures may cause rounding errors between actual calculations and example calculations.

EXAMPLE CALCULATIONS (Reference Method 3a) [Values from Run 1 test]

Carbon Monoxide Concentration (%)

$$\%CO = \frac{ppmCO}{10,000}$$

$$\%CO (\%) = \frac{7.17 \text{ ppm}}{10,000 \text{ ppm/\%}} = 0.000717 \%$$

Nitrogen Concentration (%)

$$\%N_2 = 100 - \%CO_2 - \%O_2 - \%CO$$

$$\%N_2 (\%) = 100 - 5.37 \% - 13.57 \% - 7.17 / 10,000 \% = 81.06 \%$$

Stack Dry Molecular Weight (lb/lb-mole)

$$M_d (\text{lb} / \text{lb} - \text{mole}) = \sum \left(\frac{MW_{comp}}{100} \times \%component \right)$$

$$M_d (\text{lb/lb-mol}) = \left(\frac{44 \text{ lb/lb-mol}}{100} \times 5.37 \% \right) +$$

$$\left(\frac{32 \text{ lb/lb-mol}}{100} \times 13.57 \% \right) + \left(\frac{28 \text{ lb/lb-mol}}{100} \times \left[\frac{7.17}{10,000} + 81.06 \right] \right) = \frac{29.40 \text{ lb}}{\text{lb-mol}}$$

Stack Wet Molecular Weight (lb/lb-mole)

$$M_s (\text{lb} / \text{lb} - \text{mole}) = \left[M_d \times \left(1 - \frac{B_{WS}}{100} \right) \right] + \left[MW_{H_2O} \times \frac{B_{WS}}{100} \right]$$

$$M_s (\text{lb/lb-mol}) = \left\{ \frac{29.40 \text{ lb}}{\text{lb-mol}} \times \left(1 - \frac{8.94 \%}{100} \right) \right\} + \left\{ \frac{18 \text{ lb}}{\text{lb-mol}} \times \frac{8.94 \%}{100} \right\} = \frac{28.38 \text{ lb}}{\text{lb-mol}}$$

Average Calculated Fuel Factor (F_o)

$$F_{o(avg)} = \frac{[20.9 - (\%O_2)_{avg} - (0.5 \times (\%CO)_{avg})]}{(\%CO_2)_{avg} + (\%CO)_{avg}}$$

$$F_{o(avg)} = \frac{20.9\% - 13.57\% - (0.5 \times 0.001\%)}{5.37\% + 0.001\%} = 1.360$$

Average Excess Air (%)

$$\%EA_{avg} (\%) = \frac{100 \times [(\%O_2)_{avg} - (0.5 \times (\%CO)_{avg})]}{(0.264 \times (N_2)_{avg}) - [(\%O_2)_{avg} - (0.5 \times (\%CO)_{avg})]}$$

$$(\%EA)_{AVG} = \frac{100 \times \{ 13.57 \% - (0.5 \times 0.001 \%) \}}{(0.264 \times 81.06 \%) - \{ 13.57 \% - (0.5 \times 0.001 \%) \}} = 173.32 \%$$

Note: Lack of significant figures may cause rounding errors between actual calculations and example calculations.

EXAMPLE CALCULATIONS (Reference Method 2) [Values from Run 1 test]

Absolute Stack Pressure (in. Hg)

$$P_s (\text{in. Hg}) = P_b + \frac{P_{\text{static}}}{13.6}$$

$$P_s (\text{in. Hg}) = 30.10 \text{ in. Hg} + \frac{0.75 \text{ in. H}_2\text{O}}{13.6 \text{ in. H}_2\text{O/in. Hg}} = 30.16 \text{ in. Hg}$$

Average Stack Gas Velocity (ft/sec)

$$v_s (\text{ft/sec}) = K_p \times C_p \times (\sqrt{\Delta p})_{\text{avg}} \times \sqrt{\frac{(t_s)_{\text{avg}} + T_u}{P_s \times M_s}}$$

v_{sl} (ft/sec) =

$$\left(\frac{85.49 \text{ ft (lb/lb-mol)(in. Hg)}}{\text{sec (}^\circ\text{R)(in. H}_2\text{O)}} \right)^{1/2} \times 0.84 \times 0.80 \text{ in. H}_2\text{O}^{1/2} \times \sqrt{\frac{245.50 + 460^\circ\text{R}}{30.16 \text{ in. Hg} \times 28.38 \text{ lb/lb-mol}}} = \frac{51.9 \text{ ft}}{\text{sec}}$$

Average Stack Dry Standard Flow Rate (dscfh)

$$Q_{sd} (\text{dscfh}) = \frac{60 \times 60 \times \left(1 - \frac{B_{\text{wv}}}{100}\right) \times v_s \times A_s \times T_{std} \times P_s}{(t_s + T_u) \times P_{std}}$$

$$Q_{sd} (\text{dscf/hr}) = \frac{3600 \text{ sec}}{\text{hr}} \times \left(1 - \frac{8.94 \%}{100}\right) \times \frac{51.98 \text{ ft}}{\text{sec}} \times 378.35 \text{ ft}^2 \times \frac{68.00 + 460^\circ\text{R}}{245.50 + 460^\circ\text{R}} \times \frac{30.16 \text{ in. Hg}}{29.92 \text{ in. Hg}} = \frac{48,630,312.26 \text{ dscf}}{\text{hr}}$$

Average Stack Wet Flow Rate (acfm)

$$Q_{aw} (\text{acfm}) = 60 \times v_s \times A_s$$

$$Q_{aw} (\text{acf/min}) = \frac{60 \text{ sec}}{\text{min}} \times \frac{51.98 \text{ ft}}{\text{sec}} \times 378.35 \text{ ft}^2 = \frac{1,180,059.75 \text{ acf}}{\text{min}}$$

Average Stack Wet Standard Flow Rate (ascfh)

$$Q_{sw} (\text{ascfh}) = \frac{60 \times Q_{aw} \times T_{std} \times P_s}{(t_s + T_u) \times P_{std}}$$

$$Q_{sw} (\text{ascf/hr}) = \frac{60 \text{ min}}{\text{hr}} \times \frac{1,180,059.75 \text{ acf}}{\text{min}} \times \frac{68.00 + 460^\circ\text{R}}{245.50 + 460^\circ\text{R}} \times \frac{30.16 \text{ in. Hg}}{29.92 \text{ in. Hg}} = \frac{53,406,241.16 \text{ ascf}}{\text{hr}}$$

Note: Lack of significant figures may cause rounding errors between actual calculations and example calculations.

EXAMPLE CALCULATIONS (Reference Method 4) [Values from Run 1 test]

Water Volume Weighed (scf)

$$V_{wsg(std)} (scf) = W_t \times K_s$$

$$V_{wsg(std)} = 79.80 \text{ g} \times 0.04715 \text{ ft}^3/\text{g} = 3.760 \text{ scf}$$

Standard Meter Volume (dscf)

$$V_{m(std)} (dscf) = \frac{K_1 \times Y \times V_m \times \left(P_b + \frac{\Delta H_{avg}}{13.6} \right)}{(t_m)_{avg} + T_u}$$

$$V_{m(std)} = \frac{17.65 \text{ }^\circ\text{R}}{\text{in. Hg}} \times 0.99 \times 39.27 \text{ dcf} \times \left(30.10 \text{ in. Hg} + \frac{1.19 \text{ in. H}_2\text{O}}{13.6 \text{ in. H}_2\text{O / in. Hg}} \right) = 38.31 \text{ dscf}$$

$$81.13 \text{ }^\circ\text{F} + 460 \text{ }^\circ\text{R}$$

Calculated Moisture Content (%)

$$B_{ws(calc)} (\%) = 100 \times \frac{V_{wsg(std)}}{V_{wsg(std)} + V_{m(std)}}$$

$$B_{ws(calc)} = 100 \times \frac{3.76 \text{ dscf}}{3.76 \text{ dscf} + 38.31 \text{ dscf}} = 8.94 \%$$

Saturated Moisture Content (%)

$$B_{ws(svp)} (\%) = 100 \times \frac{10^{\frac{6.691 - \frac{3144}{t_s(svp) + 390.86}}{P_b + \frac{P_{static}}{13.6}}}}{\leq 100}$$

$$B_{ws(svp)} = 100 \times \frac{10^{\left(6.691 - \frac{3144}{245.50 \text{ }^\circ\text{F} + 390.86} \right)}}{30.10 \text{ in. Hg} + \frac{0.75 \text{ in. H}_2\text{O}}{13.6 \text{ in. H}_2\text{O / in. Hg}}} \leq 100 = 100.00 \%$$

Note: Lack of significant figures may cause rounding errors between actual calculations and example calculations.

EXAMPLE CALCULATIONS (Isokinetic Sampling) [Values from Run 1 test]

Desired Orifice (in. H₂O) (first point)

$$\Delta H_d(\text{in. H}_2\text{O}) = K \times \Delta p$$

$$\Delta H_d(\text{in. H}_2\text{O}) = 1.92 \times$$

$$0.65 \text{ in. H}_2\text{O} = 1.25 \text{ in. H}_2\text{O}$$

Absolute Meter Pressure (in. Hg)

$$P_m(\text{in. Hg}) = P_b + \frac{\Delta H @}{13.6}$$

$$P_m(\text{in. Hg}) = 30.10 \text{ in. Hg} + \frac{1.75 \text{ in. H}_2\text{O}}{13.6 \text{ in. H}_2\text{O/in. Hg}} = 30.23 \text{ in. Hg}$$

Recommended Nozzle Diameter (in.)

$$D_m(\text{in.}) = \sqrt{\frac{C_n \times Q_m \times P_m}{(t_m + T_u) \times C_p} \times \left[\frac{1 - \frac{B_{wm}}{100}}{1 - \frac{B_{ws}}{100}} \right] \times \sqrt{(t_s + T_u) \times \left[\frac{M_d \times \left(1 - \frac{B_{ws}}{100} \right) + \left(18 \times \frac{B_{ws}}{100} \right)}{P_s \times \Delta p_{avg}} \right]}}$$

$$D_{ni}(\text{in.}) = \frac{0.03575 (\text{lb-mole} \cdot \text{°R} \cdot \text{in. H}_2\text{O})^{1/2} \cdot \text{min} \cdot \text{in.}^2}{\text{acf} \cdot \text{in. Hg}^{3/4} \cdot \text{lb}^{1/2}} \times 0.75 \text{ acf} \times 30.23 \text{ in. Hg} \times \left(\frac{1 - 0.00 \%}{100} \right) \times \left(\frac{81.13 \text{ °F} + 460 \text{°R}}{1 - \frac{8.94 \%}{100}} \right) \times \left(\frac{29.40 \text{ lb}}{\text{lb-mole}} \times \left(1 - \frac{8.94 \%}{100} \right) + \left(\frac{18 \text{ lb}}{\text{lb-mol}} \times \frac{8.94 \%}{100} \right) \right) \times \left(\frac{245.50 \text{ °F} + 460 \text{°R}}{30.16 \text{ in. Hg} \times 0.80 \text{ in. H}_2\text{O}} \right) = 0.230 \text{ in.}$$

ΔP to ΔH Isokinetic Factor

$$K = C_k \times C_p^2 \times \Delta H @ \times D_{no}^4 \times \left[\frac{M_d \times \left(1 - \frac{B_{wm}}{100} \right) + \left(18 \times \frac{B_{wm}}{100} \right)}{M_d \times \left(1 - \frac{B_{ws}}{100} \right) + \left(18 \times \frac{B_{ws}}{100} \right)} \right] \times \left(\frac{1 - \frac{B_{ws}}{100}}{1 - \frac{B_{wm}}{100}} \right) \times \left(\frac{t_m + T_u}{t_s + T_u} \right) \times \frac{P_s}{P_m}$$

$$K = \frac{849.8}{\text{in. H}_2\text{O} \cdot \text{in.}^4} \times 0.84^2 \times 1.75 \text{ in. H}_2\text{O} \times 0.23^4 \times \left(\frac{1 - \frac{8.94 \%}{100}}{1 - \frac{0.00 \%}{100}} \right)^2 \times \frac{81.13 \text{ °F} + 460 \text{°R}}{245.50 \text{ °F} + 460 \text{°R}} \times \left(\frac{29.40 \text{ lb}}{\text{lb-mole}} \times \left(1 - \frac{0.00 \%}{100} \right) + \left(\frac{18 \text{ lb}}{\text{lb-mol}} \times \frac{0.00 \%}{100} \right) \right) \times \left(\frac{29.40 \text{ lb}}{\text{lb-mole}} \times \left(1 - \frac{8.94 \%}{100} \right) + \left(\frac{18 \text{ lb}}{\text{lb-mol}} \times \frac{8.94 \%}{100} \right) \right) \times \frac{30.16 \text{ in. Hg}}{30.23 \text{ in. Hg}} = 1.92$$

Cumulative Percent Isokinetic (%) (first point)

$$I(\%) = \frac{K_s \times ((t_s)_{avg} + T_u) \times V_{m(std)}}{\left(\Theta \times (v_{s(t)})_{avg} \times P_s \times \pi \times \left(\frac{D_{no}}{2} \times \frac{1}{12} \right)^2 \right) \times \left(1 - \frac{B_{ws}}{100} \right)}$$

$$I(\%) = \frac{0.0945 \text{ min} \cdot \text{in. Hg}}{\text{sec} \cdot \text{°R}} \times (245.00 \text{ °F} + 460 \text{°R}) \times 1.67 \text{ dscf} \div \left(2.50 \text{ min} \times \frac{52.55 \text{ ft}}{\text{sec}} \times 30.16 \text{ in. Hg} \times 3.14 \times \left(\frac{0.23 \text{ in.}}{2} \times \frac{\text{ft.}}{12 \text{ in.}} \right)^2 \times \left(1 - \frac{8.94 \%}{100} \right) \right) = 106.99 \%$$

Note: Lack of significant figures may cause rounding errors between actual calculations and example calculations.

EXAMPLE CALCULATIONS (CTM-027 Ammonia Analysis) [Values from Run 1 test]

Dry Gas Meter Volume (L)

$$(V_m)_{dstdL} (L_{dstd}) = (V_m)_{dscf} \times 28.31685$$

$$V_m (L) = 38.31 \text{ dscf} \times 28.31685 \text{ L/dscf} = 1084.87 \text{ L}$$

Volume of NH₃ (L)

$$V_a (L) = \frac{N \times S}{MW \times 1000} \times 22.4$$

$$V_a (L) = \frac{7.80 \text{ mg}}{L} \times \frac{150.00 \text{ ml}}{1} \times \frac{L}{1000 \text{ ml}} \times \frac{22.4 \text{ L ideal gas}}{\text{g-mol substance}} \times \frac{\text{g-mol NH}_3}{17.03 \text{ g}} \times \frac{\text{g}}{1000 \text{ mg}} +$$

$$\left(\frac{0.00 \text{ mg}}{L} \times \frac{150.00 \text{ ml}}{1} \times \frac{L}{1000 \text{ ml}} \times \frac{22.4 \text{ L ideal gas}}{\text{g-mol substance}} \times \frac{\text{g-mol NH}_3}{17.03 \text{ g}} \times \frac{\text{g}}{1000 \text{ mg}} \right) = 0.00154 \text{ L}$$

NH₃ Concentration (ppmvd)

$$C_{NH_3} (\text{ppmvd}) = \frac{V_{a(\text{front})} + V_{a(\text{back})}}{(V_m)_{dstdL}} \times 10^6$$

$$C_{NH_3} (\text{ppmvd}) = \frac{0.00 \text{ L}}{1084.87 \text{ L}} \times 10^6 = 1.42 \text{ ppmvd}$$

NH₃ Concentration (ppmvd@15%O₂)

$$C_{adj} = C_{Gas(\text{Target})} \times \left(\frac{20.9\% - AdjFactor}{20.9\% - C_{Gas(O_2)}} \right)$$

$$C_{adj} = 1.42 \text{ ppmvd} \times \left(\frac{20.9\% - 15.00\%}{20.9\% - 13.6\%} \right) = 1.14 \text{ ppmvd@15\%O}_2$$

Note: Lack of significant figures may cause rounding errors between actual calculations and example calculations.

Nomenclature

- %CO = carbon monoxide concentration (%)
- %CO₂ = carbon dioxide concentration (%)
- %N₂ = nitrogen concentration (%)
- %O₂ = oxygen concentration (%)
- %O_{2,wet} = Oxygen content of gas stream, % by volume of wet gas. (Note: The oxygen percentage used in Method 201A, Equation 3 is on a wet gas basis. That means that since oxygen is typically measured on a dry gas basis, the measured percent O₂ must be multiplied by the quantity (1 - B_{ws}) to convert to the actual volume fraction. Therefore, %O_{2,wet} = (1 - B_{ws}) * %O_{2,dry})
- (%EA)_{avg} = average excess air (%)
- (F_o)_{avg} = average calculated fuel factor
- $[(\Delta p)^{0.5}]_{avg}$ = Average of square roots of the velocity pressures measured during the preliminary traverse, inches W.C.
- μ = Gas viscosity, micropoise
- 12.0 = Constant calculated as 60 percent of 20.5 square inch cross-sectional area of combined cyclone head, square inches
- 17.03 = mg/milliequivalents for ammonium ion
- 22.4 = liters of ideal gas per mol of substance at 0°C and 1 atm (ref. Civil Engineering Reference Manual, 7th ed. - Michael R. Lindeburg)
- 5.02×10^4 = constant derived from the molecular weight and correcting standard temperature and pressure (ref. Bay Area Air Quality Management District, Source Test Procedure ST-1B, Ammonia Integrated Sampling, Adopted January 20, 1982, Regulation 7-303)
- A = distance upstream (in.)
- A_D = stack diameters upstream (dia.)
- A_n = Area of nozzle, square feet
- A_s = area of stack (ft²)
- B = distance downstream (in.)
- B_D = stack diameters downstream (dia.)
- b_f = Average blockage factor calculated in Equation 26, dimensionless
- B_{wm} = meter moisture content (%)
- B_{ws} = stack moisture content (%)
- C = Cunningham correction factor for particle diameter, D_p, and calculated using the actual stack gas temperature, dimensionless
- C₁ = -150.3162 (micropoise)
- C₂ = 18.0614 (micropoise/K^{0.5}) = 13.4622 (micropoise/R^{0.5})
- C₃ = 1.19183×10^6 (micropoise/K²) = 3.86153×10^6 (micropoise/R²)
- C₄ = 0.591123 (micropoise)
- C₅ = 91.9723 (micropoise)
- C₆ = 4.91705×10^{-5} (micropoise/K²) = 1.51761×10^{-5} (micropoise/R²)
- C_a = Acetone blank concentration, mg/mg
- C_b = Concentration of NH₃ ion in the back half of train (breakthrough)
- C_f = Concentration of NH₃ ion in the front half of train (main catch)
- C_{fPM10} = Conc. of filterable PM₁₀, gr/dscf
- C_{fPM2.5} = Conc. of filterable PM_{2.5}, gr/dscf
- C_k = K Factor Constant, 849.8

Nomenclature

- C_n = nozzle diameter constant, 0.03575
- C_p' = Coefficient for the pitot used in the preliminary traverse, dimensionless
- C_p = Pitot coefficient for the combined cyclone pitot, dimensionless
- C_{cpm} = Concentration of the condensable PM in the stack gas, dry basis, corrected to standard conditions, milligrams/dry standard cubic foot.
- C_r = Re-estimated Cunningham correction factor for particle diameter equivalent to the actual cut size diameter and calculated using the actual stack gas temperature, dimensionless
- D_{50} = Particle cut diameter, micrometers
- $D_{50(N+1)}$ = D_{50} value for cyclone IV calculated during the N+1 iterative step, micrometers
- D_{50-1} = Re-calculated particle cut diameters based on re-estimated C_r , micrometers
- D_{50LL} = Cut diameter for cyclone I corresponding to the 2.25 micrometer cut diameter for cyclone IV, micrometer
- D_{50N} = D_{50} value for cyclone IV calculated during the Nth iterative step, micrometers
- D_{50T} = Cyclone I cut diameter corresponding to the middle of the overlap zone shown in Method 201A, Figure 10 of Section 17, micrometers
- D_e = equivalent stack diameter (in.)
- $\Delta H@ = \Delta H @ 0.75$ scfm (in. H₂O)
- ΔH_{avg} = average orifice pressure (in. H₂O)
- D_n = Inner diameter of sampling nozzle mounted on Cyclone I, inches
- D_{na} = actual nozzle diameter (in.)
- D_p = Physical particle size, micrometers
- Δp = velocity head (in. H₂O)
- Δp_1 = velocity head at first current traverse point (in. H₂O)
- $\Delta p'_1$ = velocity head at first preliminary traverse point (in. H₂O)
- Δp_{avg} = average pitot tube differential pressure (in. H₂O)
- Δp_n = velocity head at subsequent current traverse point (in. H₂O)
- Δp_{RM2} = method 2 velocity head (in. H₂O)
- D_s = diameter of stack (in.)
- F_d = fuel f-factor (dscf/MMBtu)
- f_{O_2} = stack gas fraction of O₂, by volume, dry basis
- I = Percent isokinetic sampling, dimensionless
- K_1 = standard volume correction, 17.65°R/in. Hg
- K_4 = isokinetic conversion constant, 0.0945min·in·Hg/sec·°R
- K_5 = water mass to std water vapor, 0.04715 ft³/g
- K_p = 85.49, ((ft/sec)/(pounds/mole · °R))
- L = length of stack (in.)
- L_{fw} = distance to far wall of stack (in.)
- L_{nw} = distance to near wall of stack (in.) [reference]
- $m_{\#x}$ = weight measurements (g)
- M_1 = Milligrams of PM collected on the filter, less than or equal to 2.5 micrometers
- M_2 = Milligrams of PM recovered from Container #2 (acetone blank corrected), greater than 10 micrometers
- M_3 = Milligrams of PM recovered from Container #3 (acetone blank corrected), less than or equal to 10 and greater than 2.5 micrometers

Nomenclature

- M_4 = Milligrams of PM recovered from Container #4 (acetone blank corrected), less than or equal to 2.5 micrometers
- m_a = Mass of residue of acetone after evaporation, mg
- m_c = Mass of the NH_4^+ added to sample to form ammonium sulfate, mg
- m_{cpm} = Mass of the total condensable PM, mg
- M_d = Molecular weight of dry gas, pounds/pound mole
- m_{fb} = Mass of total CPM in field train recovery blank, mg
- m_{fx} = final weight, avg of last two measurements (g)
- mg = Milligram
- mg/L = Milligram per liter
- m_i = Mass of inorganic CPM, mg
- m_{ib} = Mass of inorganic CPM in field train recovery blank, mg
- M_n = total particulates (mg)
- m_o = Mass of organic CPM, mg
- m_{ob} = Mass of organic CPM in field train blank, mg
- m_r = Mass of dried sample from inorganic fraction, mg
- m_{tx} = tare weight (g)
- MW = molecular weight (lb/lb-mole)
- M_w = Molecular weight of wet gas, pounds/pound mole
- N = Normality of ammonium hydroxide titrant
- N_a = null angle (deg.)
- N_{re} = Reynolds number, dimensionless
- N_{tp} = Number of iterative steps or total traverse points
- $P_b = P_{\text{bar}}$ = barometric pressure (in. Hg)
- P_{bar} = barometric pressure (in. Hg)
- ppmCO = carbon monoxide concentration (ppm)
- ppmv = Parts per million by volume
- ppmw = Parts per million by weight
- P_s = absolute stack pressure (in. Hg)
- P_{static} = static pressure (in. H_2O)
- P_{std} = standard pressure, 29.92 in. Hg
- Θ = total sampling time (min)
- Q_{aw} = average stack wet flow rate (ascf/min)
- Q_1 = Sampling rate for cyclone I to achieve specified D_{50}
- Q_m = estimated orifice flow rate, 0.750 acfm, else V_m/Q from previous run
- Q_s = Sampling rate for cyclone I to achieve specified D_{50}
- $Q_{\text{s(std)}}$ = total cyclone flow rate at standard conditions (dscf/min)
- Q_{sd} = dry standard stack flow rate (dscfm)
- Q_{sST} = Dry gas sampling rate through the sampling assembly, dscfm
- Q_{sw} = wet standard stack flow rate (ascfm)
- R_{max} = Nozzle/stack velocity ratio parameter, dimensionless
- R_{min} = Nozzle/stack velocity ratio parameter, dimensionless
- t_1 = Sampling time at point 1, min
- t_m = average gas meter temperature ($^{\circ}\text{F}$)

Nomenclature

- t_m = average meter temperature ($^{\circ}\text{F}$)
- T_m = Meter box and orifice gas temperature, $^{\circ}\text{R}$
- t_n = Sampling time at point n, min
- t_r = Total projected run time, min
- T_s = Absolute stack gas temperature, $^{\circ}\text{R}$
- T_{std} = standard temperature, 68°F , 528°R
- T_u = absolute temperature offset, 460°R
- V_a = Volume of acetone blank, ml
- V_{aw} = Volume of acetone used in sample recovery wash, ml
- V_b = Volume of aliquot taken for IC analysis, ml
- V_c = Quantity of water captured in impingers and silica gel, ml
- V_f = final impinger volume (ml)
- V_i = initial impinger volume (ml)
- V_{ic} = Volume of impinger contents sample, ml
- V_m = Dry gas meter volume sampled, acf
- $V_{m(\text{std})}$ = standard meter volume (dscf)
- v_{max} = Maximum gas velocity calculated from Equations 18 or 19, ft/sec
- v_{max} = maximum nozzle velocity (ft/sec)
- V_{mf} = final dry gas meter reading (dcf)
- V_{mi} = initial dry gas meter reading (dcf)
- v_{min} = Minimum gas velocity calculated from Method 201A, Equations 16 or 17, ft/sec
- V_{ms} = Dry gas meter volume sampled, corrected to standard conditions, dscf
- v_n = Sample gas velocity in the nozzle, ft/sec
- v_{org} = organics wash volume (ml)
- V_p = Volume of water added during train purge
- v_s = average stack gas velocity (ft/sec)
- v_{sl} = local velocity (ft/sec)
- V_t = total impinger volume (ml) = $;(V_f - V_i)$
- V_t = Volume of NH_4OH titrant, ml
- $V_{w(\text{std})}$ = volume of water vapor in gas sample at standard conditions (scf)
- v_x = blank volume (ml)
- W = width of stack (in.)
- $W_{2,3,4}$ = Weight of PM recovered from Containers #2, #3, and #4, mg
- W_a = Weight of blank residue in acetone used to recover samples, mg
- W_f = final impinger weight (g)
- W_i = initial impinger weight (g)
- W_t = total impinger weight (g) = $;(W_f - W_i)$
- w_x = blank weight of solids (g)
- Y = meter calibration factor (a.k.a gamma)
- Z = Ratio between estimated cyclone IV D_{50} values, dimensionless
- γ = Dry gas meter gamma value, dimensionless
- ΔH = Meter box orifice pressure drop, inches W.C.
- $\Delta H@$ = Pressure drop across orifice at flow rate of 0.75 scfm at standard conditions, inches W.C.
(Note: Specific to each orifice and meter box.)

Nomenclature

- Δp_1 = Velocity pressure measured at point 1, inches W.C.
- Δp_{avg} = Average velocity pressure, inches W.C.
- Δp_m = Observed velocity pressure using S-type pitot tube in preliminary traverse, inches W.C.
- Δp_{max} = Maximum velocity pressure, inches W.C.
- Δp_{min} = Minimum velocity pressure, inches W.C.
- Δp_n = Velocity pressure measured at point n during the test run, inches W.C.
- Δp_s = Velocity pressure calculated in Method 201a, Equation 25, inches W.C.
- Δp_{s1} = Velocity pressure adjusted for combined cyclone pitot tube, inches W.C.
- Δp_{s2} = Velocity pressure corrected for blockage, inches W.C.
- θ = Total run time, min
- ρ_a = Density of acetone, mg/ml (see label on bottle)
- Σ_n = total number of sampling points

APPENDIX B
UNIT OPERATION PARAMETERS

Florida Power and Light

Air Permit # :	PSD-FL-396
Plant Name or Location:	West County Energy Center
Date:	April 7, 2011
Project Number:	bv-10-westcounty.fl-comp#2
Manufacturer & Equipment:	Mitsubishi
Model:	501G
Unit Number:	3C
Test Load:	Fuel Oil
Tester(s) / Test Unit(s):	JF/MV/SG/TS/CM/206

	UNITS	RUN		
		1	2	3
Start Time	hh:mm:ss	12:00:18	13:50:18	15:25:18
End Time	hh:mm:ss	13:18:48	15:03:48	16:38:48
Bar. Pressure	in. Hg	30.13	30.12	30.10
Amb. Temp.	°F	83	82	83
Rel. Humidity	%	59	62	56
Spec. Humidity	lb water / lb air	0.014186	0.014443	0.013463
Comb. Inlet Pres.	psig	259.0	258.4	257.8
Ammonia Injection Rate	lb/hr	497.3	486.7	484.5
Turbine Fuel Flow	gal/hr	15,612	15,725	15,677
Total Fuel Flow	SCFH	2,087	2,102	2,096
Stack Moisture	% Method 4	8.9	9.0	8.1
Heat Input	MMBtu/hr	2047.9	2062.7	2056.4
Power Output	megawatts	214.2	213.7	212.8

UNIT OPERATION PARAMETERS

Fuel Oil Load

Unit 3 Emissions Testing

	Combustor Inlet Pressure C psig	CT C Load MW	Ammonia Mass Flow CT C PPH	CT C Fuel Oil Flow lb/hr
07-Apr-11 12:00:00	259.36	214.45	494.60	111183.71
07-Apr-11 12:01:00	259.23	214.38	509.34	111596.32
07-Apr-11 12:02:00	259.08	214.54	510.34	111406.82
07-Apr-11 12:03:00	258.94	214.05	509.05	111092.66
07-Apr-11 12:04:00	258.81	213.84	508.74	111422.42
07-Apr-11 12:05:00	258.75	214.22	508.87	111286.16
07-Apr-11 12:06:00	258.76	213.05	508.23	111017.56
07-Apr-11 12:07:00	258.86	213.72	509.02	111540.27
07-Apr-11 12:08:00	258.89	214.35	508.93	110828.92
07-Apr-11 12:09:00	258.90	213.98	507.82	111112.43
07-Apr-11 12:10:00	259.13	213.78	507.35	111342.49
07-Apr-11 12:11:00	259.31	214.70	507.60	111467.69
07-Apr-11 12:12:00	259.24	214.27	507.17	111183.05
07-Apr-11 12:13:00	258.97	214.76	506.82	111087.22
07-Apr-11 12:14:00	258.95	213.69	506.29	111115.40
07-Apr-11 12:15:00	259.04	213.60	505.77	111281.84
07-Apr-11 12:16:00	259.09	214.10	505.41	111232.46
07-Apr-11 12:17:00	259.16	213.74	506.23	110854.02
07-Apr-11 12:18:00	259.36	214.88	505.47	111196.69
07-Apr-11 12:19:00	259.06	213.84	505.35	111657.63
07-Apr-11 12:20:00	259.10	213.51	505.41	110832.68
07-Apr-11 12:21:00	259.43	215.06	505.70	110766.05
07-Apr-11 12:22:00	259.40	214.85	505.15	111363.99
07-Apr-11 12:23:00	259.28	214.51	505.48	111135.81
07-Apr-11 12:24:00	259.34	214.44	506.07	111051.47
07-Apr-11 12:25:00	259.32	214.68	506.23	111276.36
07-Apr-11 12:26:00	259.11	214.48	507.05	111204.44
07-Apr-11 12:27:00	259.13	213.84	296.45	110870.92
07-Apr-11 12:28:00	259.05	213.93	282.58	111186.19
07-Apr-11 12:29:00	259.16	213.87	407.54	111129.94
07-Apr-11 12:30:00	259.04	214.60	520.68	110863.84
07-Apr-11 12:31:00	258.86	214.32	537.42	110818.97
07-Apr-11 12:32:00	258.98	213.92	517.80	111241.14
07-Apr-11 12:33:00	258.95	213.69	504.82	111250.41
07-Apr-11 12:34:00	259.10	214.97	523.74	110936.99
07-Apr-11 12:35:00	259.15	213.96	503.17	110992.78
07-Apr-11 12:36:00	259.18	214.71	506.58	111183.90
07-Apr-11 12:37:00	259.09	214.18	525.15	110763.99
07-Apr-11 12:38:00	258.90	214.34	494.19	111140.39
07-Apr-11 12:39:00	258.70	214.42	490.07	111353.37
07-Apr-11 12:40:00	259.03	213.42	465.58	110748.80
07-Apr-11 12:41:00	259.26	214.85	485.67	110840.02
07-Apr-11 12:42:00	259.55	214.39	493.07	111095.47
07-Apr-11 12:43:00	259.47	214.79	508.87	111032.98
07-Apr-11 12:44:00	259.16	214.33	504.88	110291.42
07-Apr-11 12:45:00	259.19	214.58	525.73	110444.10
07-Apr-11 12:46:00	258.85	213.74	501.06	111009.91
07-Apr-11 12:47:00	259.14	213.90	471.51	110847.86
07-Apr-11 12:48:00	259.17	213.81	479.44	110752.41
07-Apr-11 12:49:00	259.24	214.12	480.32	110865.09
07-Apr-11 12:50:00	259.49	215.31	483.49	110663.50
07-Apr-11 12:51:00	259.38	214.30	521.44	110627.52
07-Apr-11 12:52:00	259.55	213.90	498.53	110895.77
07-Apr-11 12:53:00	259.65	214.27	479.21	110731.84
07-Apr-11 12:54:00	259.48	215.51	503.35	110601.89
07-Apr-11 12:55:00	259.25	215.06	533.49	110960.06
07-Apr-11 12:56:00	259.24	215.12	515.75	110999.58
07-Apr-11 12:57:00	259.17	214.54	516.98	110516.63
07-Apr-11 12:58:00	259.11	214.67	503.41	110673.77
07-Apr-11 12:59:00	259.28	214.51	495.60	110189.56
07-Apr-11 13:00:00	259.24	214.24	491.25	109870.95
07-Apr-11 13:01:00	259.13	214.10	480.91	110580.08
07-Apr-11 13:02:00	259.05	213.87	511.63	110688.41
07-Apr-11 13:03:00	258.90	214.79	512.57	110158.53
07-Apr-11 13:04:00	258.83	213.87	516.22	110667.23
07-Apr-11 13:05:00	258.67	213.69	514.69	110551.03
07-Apr-11 13:06:00	258.70	214.01	499.00	110170.56
07-Apr-11 13:07:00	258.75	213.78	511.57	110275.45
07-Apr-11 13:08:00	258.79	213.63	507.29	110788.77
07-Apr-11 13:09:00	258.96	214.33	495.89	110551.81
07-Apr-11 13:10:00	258.75	213.47	516.39	110385.42
07-Apr-11 13:11:00	258.71	214.30	512.81	110701.38
07-Apr-11 13:12:00	258.78	214.24	508.99	110397.72
07-Apr-11 13:13:00	258.60	214.00	492.07	110081.52
07-Apr-11 13:14:00	258.54	213.37	508.81	110516.75
07-Apr-11 13:15:00	258.40	213.63	486.78	110168.91
07-Apr-11 13:16:00	258.53	213.84	464.17	110155.31
07-Apr-11 13:17:00	258.29	213.63	511.05	110291.94
07-Apr-11 13:18:00	258.41	212.50	491.31	109865.87
Average	259.05	214.19	497.35	110859.81

Unit 3 Emissions Testing

	Combustor Inlet Pressure C psig	CT C Load MW	Ammonia Mass Flow CT C PPH	CT C Fuel Oil Flow lb/hr
07-Apr-11 13:50:00	257.63	212.62	516.16	111280.34
07-Apr-11 13:51:00	257.77	212.13	515.22	111104.95
07-Apr-11 13:52:00	257.93	212.71	493.48	111294.16
07-Apr-11 13:53:00	258.30	213.45	481.97	111396.18
07-Apr-11 13:54:00	257.95	213.10	507.17	111442.91
07-Apr-11 13:55:00	258.01	213.14	493.01	111281.86
07-Apr-11 13:56:00	258.06	212.77	502.35	111315.20
07-Apr-11 13:57:00	258.00	213.23	476.03	111458.98
07-Apr-11 13:58:00	258.14	213.05	503.47	111454.48
07-Apr-11 13:59:00	258.35	212.65	489.90	111380.00
07-Apr-11 14:00:00	258.22	213.81	472.16	111646.71
07-Apr-11 14:01:00	258.14	213.66	468.46	111610.68
07-Apr-11 14:02:00	258.22	212.99	480.73	111354.30
07-Apr-11 14:03:00	257.89	213.57	474.09	111683.63
07-Apr-11 14:04:00	257.96	213.10	486.31	111402.45
07-Apr-11 14:05:00	257.31	212.38	476.97	111274.16
07-Apr-11 14:06:00	258.30	213.12	429.33	111432.55
07-Apr-11 14:07:00	258.18	213.75	434.32	111516.36
07-Apr-11 14:08:00	258.96	213.29	447.31	111538.39
07-Apr-11 14:09:00	258.73	214.64	469.22	111965.67
07-Apr-11 14:10:00	258.56	213.60	477.88	111900.14
07-Apr-11 14:11:00	257.64	213.26	506.17	111591.02
07-Apr-11 14:12:00	258.31	213.45	467.05	111357.19
07-Apr-11 14:13:00	258.37	213.48	457.94	111568.21
07-Apr-11 14:14:00	258.39	214.06	476.62	111836.45
07-Apr-11 14:15:00	258.59	214.09	489.43	111955.96
07-Apr-11 14:16:00	258.54	213.81	534.78	111529.34
07-Apr-11 14:17:00	258.42	213.29	520.15	111592.91
07-Apr-11 14:18:00	258.48	213.90	495.83	111787.31
07-Apr-11 14:19:00	258.59	213.60	504.70	111561.20
07-Apr-11 14:20:00	258.87	213.93	462.17	111946.46
07-Apr-11 14:21:00	258.71	214.18	504.64	111876.98
07-Apr-11 14:22:00	258.73	213.82	511.63	111779.52
07-Apr-11 14:23:00	258.43	214.30	479.85	111797.16
07-Apr-11 14:24:00	258.42	213.51	489.84	111533.81
07-Apr-11 14:25:00	258.40	213.45	462.17	111740.02
07-Apr-11 14:26:00	258.43	213.38	448.77	111824.77
07-Apr-11 14:27:00	258.58	214.12	463.81	111737.43
07-Apr-11 14:28:00	258.36	213.87	474.80	111865.98
07-Apr-11 14:29:00	258.77	212.26	467.22	111087.36
07-Apr-11 14:30:00	258.92	213.48	469.63	111701.20
07-Apr-11 14:31:00	258.89	214.76	476.62	112087.04
07-Apr-11 14:32:00	259.10	214.94	520.74	112029.97
07-Apr-11 14:33:00	258.58	214.85	513.98	111981.89
07-Apr-11 14:34:00	258.79	214.09	513.22	111710.71
07-Apr-11 14:35:00	258.63	214.18	493.60	111784.88
07-Apr-11 14:36:00	258.75	214.70	496.95	111939.82
07-Apr-11 14:37:00	258.70	214.18	512.34	111738.83
07-Apr-11 14:38:00	258.78	214.09	510.34	111802.30
07-Apr-11 14:39:00	258.89	214.48	474.74	111934.72
07-Apr-11 14:40:00	258.69	214.27	473.57	111843.55
07-Apr-11 14:41:00	258.65	213.69	472.51	111833.11
07-Apr-11 14:42:00	258.27	214.76	467.40	111979.22
07-Apr-11 14:43:00	258.49	212.90	512.69	111229.73
07-Apr-11 14:44:00	258.68	213.90	465.64	111765.73
07-Apr-11 14:45:00	258.67	214.36	474.62	112007.57
07-Apr-11 14:46:00	258.65	213.78	511.46	111731.21
07-Apr-11 14:47:00	258.78	213.81	488.08	111783.34
07-Apr-11 14:48:00	258.82	213.96	513.04	111886.54
07-Apr-11 14:49:00	258.73	214.18	516.98	111838.02
07-Apr-11 14:50:00	258.76	213.75	506.05	111930.02
07-Apr-11 14:51:00	258.35	213.23	513.57	111831.99
07-Apr-11 14:52:00	258.12	213.75	510.22	111803.29
07-Apr-11 14:53:00	258.33	213.35	475.15	111443.39
07-Apr-11 14:54:00	258.27	213.74	462.17	111618.92
07-Apr-11 14:55:00	258.18	213.11	460.64	111497.34
07-Apr-11 14:56:00	258.51	213.84	455.18	111659.92
07-Apr-11 14:57:00	258.52	213.78	477.15	111591.22
07-Apr-11 14:58:00	258.51	214.04	468.57	111912.96
07-Apr-11 14:59:00	258.54	214.06	520.74	111753.34
07-Apr-11 15:00:00	258.51	213.93	511.16	111689.93
07-Apr-11 15:01:00	258.49	212.90	474.92	111622.09
07-Apr-11 15:02:00	258.33	213.96	502.82	111604.56
07-Apr-11 15:03:00	258.06	213.26	487.84	111722.41
Average	258.43	213.66	486.72	111662.08

Unit 3 Emissions Testing

	Combustor Inlet Pressure C psig	CT C Load MW	Ammonia Mass Flow CT C PPH	CT C Fuel Oil Flow lb/hr
07-Apr-11 15:25:00	257.72	213.02	518.68	111270.61
07-Apr-11 15:26:00	257.83	212.62	513.87	111286.99
07-Apr-11 15:27:00	258.01	212.68	477.80	111284.17
07-Apr-11 15:28:00	258.10	213.87	464.17	111663.44
07-Apr-11 15:29:00	258.05	213.17	508.52	111367.26
07-Apr-11 15:30:00	258.10	212.87	497.77	111246.21
07-Apr-11 15:31:00	258.19	212.87	489.66	111594.45
07-Apr-11 15:32:00	258.13	212.91	497.36	111530.01
07-Apr-11 15:33:00	258.06	213.02	511.63	111507.35
07-Apr-11 15:34:00	258.08	213.38	515.10	111442.41
07-Apr-11 15:35:00	258.09	212.77	510.93	111287.95
07-Apr-11 15:36:00	258.08	212.62	494.89	111444.79
07-Apr-11 15:37:00	257.99	213.32	493.95	111381.99
07-Apr-11 15:38:00	258.00	212.90	485.08	111463.81
07-Apr-11 15:39:00	257.95	213.38	498.47	111427.64
07-Apr-11 15:40:00	257.83	213.51	467.05	111566.45
07-Apr-11 15:41:00	257.61	212.84	477.91	111302.17
07-Apr-11 15:42:00	257.47	211.74	500.24	111233.52
07-Apr-11 15:43:00	257.83	212.87	468.04	111231.34
07-Apr-11 15:44:00	257.85	212.19	465.34	111367.69
07-Apr-11 15:45:00	257.70	212.50	472.33	111284.64
07-Apr-11 15:46:00	257.43	212.96	498.83	111384.79
07-Apr-11 15:47:00	257.07	212.52	488.08	111244.73
07-Apr-11 15:48:00	256.96	211.72	455.18	110964.23
07-Apr-11 15:49:00	257.34	211.95	447.42	110803.96
07-Apr-11 15:50:00	257.43	212.79	470.51	111225.06
07-Apr-11 15:51:00	257.53	212.74	496.01	111379.75
07-Apr-11 15:52:00	257.47	211.95	512.63	110985.64
07-Apr-11 15:53:00	257.50	212.19	498.42	111133.45
07-Apr-11 15:54:00	257.60	212.67	503.64	111220.48
07-Apr-11 15:55:00	257.51	212.35	507.52	111231.20
07-Apr-11 15:56:00	257.39	212.19	508.46	111184.33
07-Apr-11 15:57:00	257.32	211.55	500.94	111096.93
07-Apr-11 15:58:00	257.47	212.35	508.11	110961.77
07-Apr-11 15:59:00	257.52	212.99	488.43	111313.78
07-Apr-11 16:00:00	257.60	212.62	471.33	111157.55
07-Apr-11 16:01:00	257.45	212.51	475.45	111094.24
07-Apr-11 16:02:00	257.57	212.84	476.42	111483.77
07-Apr-11 16:03:00	257.56	212.06	517.39	110989.37
07-Apr-11 16:04:00	257.54	212.62	472.27	111272.43
07-Apr-11 16:05:00	257.65	212.74	487.20	111367.11
07-Apr-11 16:06:00	257.47	212.62	491.95	111017.97
07-Apr-11 16:07:00	257.59	213.08	499.65	111330.16
07-Apr-11 16:08:00	257.68	212.04	469.16	111049.07
07-Apr-11 16:09:00	257.79	212.53	461.76	111218.62
07-Apr-11 16:10:00	257.94	212.99	479.50	111468.90
07-Apr-11 16:11:00	257.65	212.50	472.04	111320.40
07-Apr-11 16:12:00	257.94	212.56	491.31	111212.89
07-Apr-11 16:13:00	258.07	213.43	480.97	111517.63
07-Apr-11 16:14:00	257.96	213.51	470.75	111400.48
07-Apr-11 16:15:00	257.72	213.45	478.79	111475.30
07-Apr-11 16:16:00	257.58	212.56	466.93	111441.18
07-Apr-11 16:17:00	257.70	212.10	458.41	110989.12
07-Apr-11 16:18:00	257.24	212.83	432.74	111423.34
07-Apr-11 16:19:00	257.83	213.06	442.25	111302.53
07-Apr-11 16:20:00	257.90	212.12	443.02	110929.98
07-Apr-11 16:21:00	257.23	212.56	452.53	111211.69
07-Apr-11 16:22:00	258.21	212.96	466.34	111203.30
07-Apr-11 16:23:00	258.31	214.24	479.97	111704.37
07-Apr-11 16:24:00	258.08	213.42	481.67	111556.77
07-Apr-11 16:25:00	258.38	213.54	519.98	111642.44
07-Apr-11 16:26:00	257.95	213.39	501.41	111477.11
07-Apr-11 16:27:00	258.13	213.38	470.45	111637.53
07-Apr-11 16:28:00	257.99	212.94	500.59	111336.47
07-Apr-11 16:29:00	258.04	212.93	499.36	111483.28
07-Apr-11 16:30:00	257.87	213.45	490.07	111480.29
07-Apr-11 16:31:00	257.68	213.35	484.96	111460.34
07-Apr-11 16:32:00	257.81	213.45	499.59	111353.27
07-Apr-11 16:33:00	257.93	212.26	471.39	111434.66
07-Apr-11 16:34:00	257.94	213.14	492.60	111428.43
07-Apr-11 16:35:00	257.69	212.77	495.36	111559.73
07-Apr-11 16:36:00	257.68	212.74	470.45	111346.69
07-Apr-11 16:37:00	257.60	212.53	484.55	111199.27
07-Apr-11 16:38:00	257.65	212.47	437.44	111223.66
Average	257.75	212.79	484.47	111317.79

APPENDIX C
CALIBRATION GAS CERTIFICATIONS

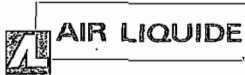

Air Liquide America
Specialty Gases LLC



RATA CLASS

Dual-Analyzed Calibration Standard

1290 COMBERMERE STREET, TROY, MI 48083

Phone: 248-589-2950

Fax: 248-589-2134

CERTIFICATE OF ACCURACY: EPA Protocol Gas

Assay Laboratory

AIR LIQUIDE AMERICA SPECIALTY GASES LLC
1290 COMBERMERE STREET
TROY, MI 48083

P.O. No.: ALAS-55510

Project No.: 05-86523-002

Customer

AIR LIQUIDE AMERICA L.P.
AIR HYGIENE
1319 NORTH PEORIA AVE
TULSA OK 74106

ANALYTICAL INFORMATION

This certification was performed according to EPA Traceability Protocol For Assay & Certification of Gaseous Calibration Standards; Procedure G-1; September, 1997.

Cylinder Number: ALM019345 Certification Date: 05Apr2010 Exp. Date: 04Apr2013
Cylinder Pressure***: 2000 PSIG

COMPONENT	CERTIFIED CONCENTRATION (Moles)	ANALYTICAL ACCURACY**	TRACEABILITY
CARBON DIOXIDE	8.91 %	+/- 1%	Direct NIST and VSL
OXYGEN	12.1 %	+/- 1%	Direct NIST and VSL
NITROGEN	BALANCE		

*** Do not use when cylinder pressure is below 150 psig.

** Analytical accuracy is based on the requirements of EPA Protocol Procedure G1, September 1997.

REFERENCE STANDARD

TYPE/SRM NO.	EXPIRATION DATE	CYLINDER NUMBER	CONCENTRATION	COMPONENT
NTRM 2300	01Nov2010	1D002807	23.04 %	CARBON DIOXIDE
NTRM 2350	01Dec2011	K016398	23.20 %	OXYGEN

INSTRUMENTATION

INSTRUMENT/MODEL/SERIAL#	DATE LAST CALIBRATED	ANALYTICAL PRINCIPLE
PIR/2000/609015	01Apr2010	NDIR
CAI/110P/VO3018	17Mar2010	PARAMAGNETIC

ANALYZER READINGS

(Z=Zero Gas R=Reference Gas T=Test Gas r=Correlation Coefficient)

First Triad Analysis

Second Triad Analysis

Calibration Curve

CARBON DIOXIDE

Date: 09Apr2010	Response Unit: MV	
Z1 = 0.00000	R1 = 100.0000	T1 = 56.20000
R2 = 100.0000	Z2 = 0.00000	T2 = 56.16000
Z3 = 0.00000	T3 = 56.24000	R3 = 100.1500
Avg. Concentration: 8.916 %		

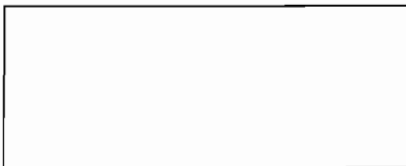

Concentration = A + Bx + Cx ² + Dx ³ + Ex ⁴	
r = 0.999989193	
Constants:	A = -0.00227705
B = 0.142642211	C = -0.0004667
D = 0.0000133988	E = 0

OXYGEN

Date: 09Apr2010	Response Unit: %	
Z1 = 0.00000	R1 = 23.20000	T1 = 12.11000
R2 = 23.20000	Z2 = 0.00000	T2 = 12.10000
Z3 = 0.00000	T3 = 12.09000	R3 = 23.19000
Avg. Concentration: 12.08 %		

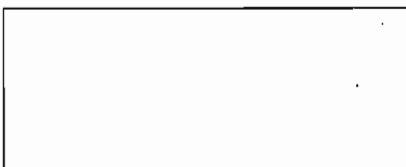

Concentration = A + Bx + Cx ² + Dx ³ + Ex ⁴	
r = 0.999996852	
Constants:	A = -0.0380151
B = 1.001181055	C = 0
D = 0	E = 0

APPROVED BY: _____

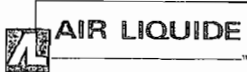

Air Liquide America
Specialty Gases LLC



RATA CLASS

Dual-Analyzed Calibration Standard

1290 COMBERMERE STREET, TROY, MI 48083

Phone: 248-589-2950

Fax: 248-589-2134

CERTIFICATE OF ACCURACY: EPA Protocol Gas

Assay Laboratory

AIR LIQUIDE AMERICA SPECIALTY GASES LLC
1290 COMBERMERE STREET
TROY, MI 48083

P.O. No.: ALAS-56936

Project No.: 05-88735-006

Customer

AIR LIQUIDE AMERICA L.P.
AIR HYGIENE
1319 NORTH PEORIA AVE
TULSA OK 74106

ANALYTICAL INFORMATION

This certification was performed according to EPA Traceability Protocol For Assay & Certification of Gaseous Calibration Standards; Procedure G-1; September, 1997.

Cylinder Number: ALM004185 Certification Date: 21Jun2010 Exp. Date: 20Jun2013
Cylinder Pressure***: 2000 PSIG

COMPONENT	CERTIFIED CONCENTRATION (Moles)	ANALYTICAL ACCURACY**	TRACEABILITY
CARBON DIOXIDE	19.1 %	+/- 1%	Direct NIST and VSL
OXYGEN	21.1 %	+/- 1%	Direct NIST and VSL
NITROGEN	BALANCE		

*** Do not use when cylinder pressure is below 150 psig.

** Analytical accuracy is based on the requirements of EPA Protocol Procedure G1, September 1997.

REFERENCE STANDARD

TYPE/SRM NO.	EXPIRATION DATE	CYLINDER NUMBER	CONCENTRATION	COMPONENT
NTRM 2300	01Nov2010	1D002807	23.04 %	CARBON DIOXIDE
NTRM 2350	01Dec2011	K016398	23.20 %	OXYGEN

INSTRUMENTATION

INSTRUMENT/MODEL/SERIAL#	DATE LAST CALIBRATED	ANALYTICAL PRINCIPLE
PIR/2000/609015	07Jun2010	NDIR
CAI/110P/V03018	11Jun2010	PARAMAGNETIC

ANALYZER READINGS

(Z=Zero Gas R=Reference Gas T=Test Gas r=Correlation Coefficient)

First Triad Analysis

Second Triad Analysis

Calibration Curve

CARBON DIOXIDE

Date: 21Jun2010	Response Unit: MV	
Z1=0.00000	R1=100.0000	T1=90.42000
R2=100.0000	Z2=0.00000	T2=90.50000
Z3=0.00000	T3=90.50000	R3=100.0000
Avg. Concentration: 19.07 %		



Concentration = A + Bx + Cx ² + Dx ³ + Ex ⁴	
r = 0.999986	
Constants:	A = -0.00585731
	B = 0.131066552 C = -0.0001375
	D = 1.12705E-05 E = 0

OXYGEN

Date: 21Jun2010	Response Unit: %	
Z1=0.00000	R1=23.20000	T1=21.15000
R2=23.20000	Z2=0.00000	T2=21.15000
Z3=0.00000	T3=21.15000	R3=23.20000
Avg. Concentration: 21.14 %		



Concentration = A + Bx + Cx ² + Dx ³ + Ex ⁴	
r = 0.999999	
Constants:	A = -0.00484606
	B = 0.999830474 C = 0
	D = 0 E = 0

Special Notes:

PART# AH095

APPROVED BY:

JEFF CROTEAU

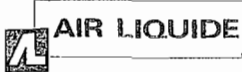

Air Liquide America
Specialty Gases LLC



RATA CLASS

Dual-Analyzed Calibration Standard

1290 COMBERMERE STREET, TROY, MI 48083

Phone: 248-589-2950

Fax: 248-589-2134

CERTIFICATE OF ACCURACY: Interference Free™ Multi-Component EPA Protocol Gas

Assay Laboratory

AIR LIQUIDE AMERICA SPECIALTY GASES LLC
1290 COMBERMERE STREET
TROY, MI 48083

P.O. No.: ALASG-55510
Project No.: 05-86916-005

Customer

AIR LIQUIDE AMERICA L.P.
AIR HYGIENE
1319 NORTH PEORIA AVE
TULSA OK 74106

P

ANALYTICAL INFORMATION

This certification was performed according to EPA Traceability Protocol For Assay & Certification of Gaseous Calibration Standards; Procedure G-1; September, 1997.

Cylinder Number: **AAL13310** Certification Date: **22Apr2010** Exp. Date: **21Apr2012**
Cylinder Pressure***: **2015 PSIG**

COMPONENT	CERTIFIED CONCENTRATION (Moles)	ACCURACY**	TRACEABILITY
CARBON MONOXIDE	12.1 PPM	+/- 1%	Direct NIST and VSL
NITRIC OXIDE	12.1 PPM	+/- 1%	Direct NIST and VSL
NITROGEN - OXYGEN FREE	BALANCE		
TOTAL OXIDES OF NITROGEN	12.1 PPM		Reference Value Only

*** Do not use when cylinder pressure is below 150 psig.

*** Analytical accuracy is based on the requirements of EPA Protocol Procedure G1, September, 1997.

REFERENCE STANDARD

TYPE/SRM NO.	EXPIRATION DATE	CYLINDER NUMBER	CONCENTRATION	COMPONENT
NTRM 2629	02Oct2010	KAL003188	25.21 PPM	CARBON MONOXIDE
	01Jun2010	KAL004325	20.36 PPM	NITRIC OXIDE

INSTRUMENTATION

INSTRUMENT/MODEL/SERIAL#	DATE LAST CALIBRATED	ANALYTICAL PRINCIPLE
FTIR//0928621	02Apr2010	FTIR
ECO PHYSICS/CLD 84M/84M0359	19Apr2010	CHEM

ANALYZER READINGS

(Z=Zero Gas R=Reference Gas T=Test Gas r=Correlation Coefficient)

First Triad Analysis

Second Triad Analysis

Calibration Curve

CARBON MONOXIDE

Date: 14Apr2010 Response Unit: PPM
Z1=-0.05307 R1=25.30663 T1=12.10338
R2=25.31267 Z2=-0.05306 T2=12.12388
Z3=-0.03830 T3=12.14423 R3=25.34334
Avg. Concentration: 12.09 PPM

Date: 21Apr2010 Response Unit: PPM
Z1=-0.06291 R1=25.26965 T1=12.17129
R2=25.30621 Z2=-0.02751 T2=12.19590
Z3=0.02191 T3=12.19939 R3=25.34779
Avg. Concentration: 12.15 PPM

Concentration = A + Bx + Cx² + Dx³ + Ex⁴
r = 9.99986E-1
Constants: A = 0.00000E+0
B = 8.81389E-1 C = 5.84000E-4
D = 1.00000E-6 E = 0.00000E+0

NITRIC OXIDE

Date: 14Apr2010 Response Unit: MV
Z1=0.00000 R1=20.33000 T1=12.05000
R2=20.35000 Z2=0.00000 T2=12.05000
Z3=0.00000 T3=12.05000 R3=20.34000
Avg. Concentration: 12.11 PPM

Date: 21Apr2010 Response Unit: MV
Z1=0.00000 R1=20.29000 T1=11.96000
R2=20.28000 Z2=0.00000 T2=11.96000
Z3=0.00000 T3=11.96000 R3=20.29000
Avg. Concentration: 12.04 PPM

Concentration = A + Bx + Cx² + Dx³ + Ex⁴
r = 0.999989
Constants: A = 0.052499
B = 0.998591 C = 0.000000
D = 0.000000 E = 0.000000

Special Notes: AH072 Lot Number: 0586916005

APPROVED BY:

Rob. McCrandall



Air Liquide America
Specialty Gases LLC



RATA CLASS

Dual-Analyzed Calibration Standard

1290 COMBERMERE STREET, TROY, MI 48083

Phone: 248-589-2950

Fax: 248-589-2134

CERTIFICATE OF ACCURACY: Interference Free™ Multi-Component EPA Protocol Gas

Assay Laboratory

AIR LIQUIDE AMERICA SPECIALTY GASES LLC
1290 COMBERMERE STREET
TROY, MI 48083

P.O. No.: ALAS-56465

Project No.: 05-87288-002

Customer

AIR LIQUIDE AMERICA L.P.
AIR HYGIENE
1319 NORTH PEORIA AVE
TULSA, OK 74106

ANALYTICAL INFORMATION

This certification was performed according to EPA Traceability Protocol For Assay & Certification of Gaseous Calibration Standards; Procedure G-1; September, 1997.

Cylinder Number: **CC173507** Certification Date: **07May2010** Exp. Date: **06May2012**
Cylinder Pressure***: **2015 PSIG**

COMPONENT	CERTIFIED CONCENTRATION (Moles)	ACCURACY**	TRACEABILITY
CARBON MONOXIDE	23.2 PPM	+/- 1%	Direct NIST and VSL
NITRIC OXIDE	23.4 PPM	+/- 1%	Direct NIST and VSL
NITROGEN - OXYGEN FREE	BALANCE		
TOTAL OXIDES OF NITROGEN	23.6 PPM		Reference Value Only

*** Do not use when cylinder pressure is below 150 psig.

** Analytical accuracy is based on the requirements of EPA Protocol Procedure G1, September 1997.

REFERENCE STANDARD

TYPE/SRM NO.	EXPIRATION DATE	CYLINDER NUMBER	CONCENTRATION	COMPONENT
NTRM 2636	02Oct2011	KAL003744	240.8 PPM	CARBON MONOXIDE
NTRM 1684 1	15Oct2012	KAL004434	95.84 PPM	NITRIC OXIDE

INSTRUMENTATION

INSTRUMENT/MODEL/SERIAL#	DATE LAST CALIBRATED	ANALYTICAL PRINCIPLE
FTIR//0928621	30Apr2010	FTIR
FTIR//0928621	09Apr2010	FTIR

ANALYZER READINGS

(Z=Zero Gas R=Reference Gas T=Test Gas r=Correlation Coefficient)

First Triad Analysis

CARBON MONOXIDE

Date: 30Apr2010 Response Unit: PPM
Z1=-0.00481 R1=241.9239 T1=23.39141
R2=242.0561 Z2=-0.00195 T2=23.42998
Z3=0.23106 T3=23.44974 R3=242.2529
Avg. Concentration: 23.23 PPM

Second Triad Analysis

Date: 07May2010 Response Unit: PPM
Z1=-0.00417 R1=240.9105 T1=23.18030
R2=241.2416 Z2=0.00845 T2=23.21160
Z3=0.28117 T3=23.35798 R3=241.2466
Avg. Concentration: 23.13 PPM

Calibration Curve

Concentration = A + Bx + Cx² + Dx³ + Ex⁴
r = 9.99985E-1
Constants: A = 0.00000E+0
B = 5.06495E-1 C = 1.93000E-4
D = 0.00000E+0 E = 0.00000E+0

NITRIC OXIDE

Date: 30Apr2010 Response Unit: PPM
Z1=-0.03952 R1=95.90178 T1=23.28269
R2=95.91071 Z2=-0.02811 T2=23.36449
Z3=-0.00286 T3=23.37331 R3=96.05732
Avg. Concentration: 23.33 PPM

Date: 07May2010 Response Unit: PPM
Z1=-0.13287 R1=94.53774 T1=23.24871
R2=95.07222 Z2=-0.00119 T2=23.38911
Z3=0.07275 T3=23.45024 R3=95.38034
Avg. Concentration: 23.53 PPM

Concentration = A + Bx + Cx² + Dx³ + Ex⁴
r = 9.99985E-1
Constants: A = 0.00000E+0
B = 9.98166E-1 C = 2.95000E-4
D = 0.00000E+0 E = 0.00000E+0

Special Notes: AH074 Lot Number: 0587288002

APPROVED BY:

Rob McCrandall

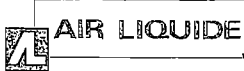

Air Liquide America
Specialty Gases LLC



RATA CLASS

Dual-Analyzed Calibration Standard

1290 COMBERMERE STREET, TROY, MI 48083

Phone: 248-589-2950

Fax: 248-589-2134

CERTIFICATE OF ACCURACY: EPA Protocol Gas

Assay Laboratory

AIR LIQUIDE AMERICA SPECIALTY GASES LLC
1290 COMBERMERE STREET
TROY, MI 48083

P.O. No.: 9092010

Project No.: 05-80747-007

Customer

AIR LIQUIDE AMERICA L.P.

801 W NORTH CARRIER PKWY
GRAND PRAIRIE TX 75050-1003

ANALYTICAL INFORMATION

This certification was performed according to EPA Traceability Protocol For Assay & Certification of Gaseous Calibration Standards; Procedure G-1; September, 1997.

Cylinder Number: AAL687 Certification Date: 12Oct2009 Exp. Date: 11Oct2012
Cylinder Pressure***: 2000 PSIG

<u>COMPONENT</u>	<u>CERTIFIED CONCENTRATION (Moles)</u>	<u>ANALYTICAL ACCURACY**</u>	<u>TRACEABILITY</u>
METHANE	3.10 PPM	+/- 1%	Direct NIST and VSL
NITROGEN	BALANCE		

*** Do not use when cylinder pressure is below 150 psig.

** Analytical accuracy is based on the requirements of EPA Protocol Procedure G1, September 1997.

REFERENCE STANDARD

<u>TYPE/SRM NO.</u>	<u>EXPIRATION DATE</u>	<u>CYLINDER NUMBER</u>	<u>CONCENTRATION</u>	<u>COMPONENT</u>
NTRM 1659 10	02Oct2013	ALM058053	9.920 PPM	METHANE

INSTRUMENTATION

<u>INSTRUMENT/MODEL/SERIAL#</u>	<u>DATE LAST CALIBRATED</u>	<u>ANALYTICAL PRINCIPLE</u>
VARIAN/3400/7506	17Sep2009	TCD/FID

ANALYZER READINGS

(Z=Zero Gas R=Reference Gas T=Test Gas r=Correlation Coefficient)

First Triad Analysis

Second Triad Analysis

Calibration Curve

METHANE

Date:	Response Unit: AREA		
12Oct2009	Z1=0.00000	R1=91476.00	T1=28119.00
	R2=91405.00	Z2=0.00000	T2=28109.00
	Z3=0.00000	T3=28107.00	R3=91478.00
Avg. Concentration:	3.100	PPM	

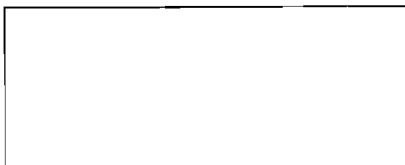

Concentration = A + Bx + Cx ² + Dx ³ + Ex ⁴	
r = 0.99999124	
Constants:	A = 0.04550378
B = 0.000107911	C = 0
D = 0	E = 0

APPROVED BY:

ROBERT LESNIAK



AIR LIQUIDE

CERTIFICATION OF ANALYSIS

Interference Free Multi-Component EPA Protocol Gases

Note: Analytical uncertainty and NIST traceability are in compliance with EPA-600/R-97/121 Section 2.2, Procedure G-1

Cylinder S/N: CC113394

Customer: AIR HYGIENE
Location: TULSA, OK

Shipping Order Number: 33119767
Transfer Number: 33119767
Lot Number: SFS131210
Valve: CGA 350
Cylinder Pressure*: 2000 PSIG
*Cylinder should not be used when gas pressure is below 150 psig

P.O. Number: 9032901
Item Number: SGZCAH002

Assay Date: 24-Apr-2009

Expiration Date: 24-Apr-2012

Table with 3 columns: Components, Requested Concentration, Assay Concentration. Rows for Nitrogen and Methane.

Reference Standard(s) Employed For Analysis

Table with 9 columns: Certified Concentration and Uncertainty, Component, Balance, Cyl. No., SRM/PRM/Mix No., Exp. Date, Sample No., Type. Row for Methane.

Analytical Data

Analytical data table for Methane, including Analyzer Information, Zero, Reference, Candidate, Result, Evaluation, and Mean Analytical Result.

Analyst: [Signature] Eric Barron

Approved by: [Signature] Jason Unger

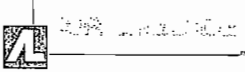

Air Liquide America
Specialty Gases LLC



RATA CLASS

Dual-Analyzed Calibration Standard

1290 COMBERMERE STREET, TROY, MI 48083

Phone: 248-589-2950

Fax: 248-589-2134

CERTIFICATE OF ACCURACY: EPA Protocol Gas

Assay Laboratory

AIR LIQUIDE AMERICA SPECIALTY GASES LLC
1290 COMBERMERE STREET
TROY, MI 48083

P.O. No.: 9081310

Project No.: 05-79607-014

Customer

AIR LIQUIDE AMERICA L.P.
AIR HYGIENE
1319 NORTH PEORIA AVE
TULSA OK 74106

ANALYTICAL INFORMATION

This certification was performed according to EPA Traceability Protocol For Assay & Certification of Gaseous Calibration Standards; Procedure G-1; September, 1997.

Cylinder Number: ALM004952 Certification Date: 08Sep2009 Exp. Date: 07Sep2012
Cylinder Pressure***: 1875 PSIG

<u>COMPONENT</u>	<u>CERTIFIED CONCENTRATION (Moles)</u>	<u>ANALYTICAL ACCURACY**</u>	<u>TRACEABILITY</u>
METHANE	8.46 PPM	+/- 1%	Direct NIST and VSL
NITROGEN	BALANCE		

*** Do not use when cylinder pressure is below 150 psig.

** Analytical accuracy is based on the requirements of EPA Protocol Procedure G1, September 1997.

REFERENCE STANDARD

<u>TYPE/SRM NO.</u>	<u>EXPIRATION DATE</u>	<u>CYLINDER NUMBER</u>	<u>CONCENTRATION</u>	<u>COMPONENT</u>
NTRM 2751	01Nov2010	K022940	100.2 PPM	METHANE

INSTRUMENTATION

<u>INSTRUMENT/MODEL/SERIAL#</u>	<u>DATE LAST CALIBRATED</u>	<u>ANALYTICAL PRINCIPLE</u>
VARIAN/3400/7506	17Aug2009	TCD/FID

ANALYZER READINGS

(Z=Zero Gas R=Reference Gas T=Test Gas r=Correlation Coefficient)

First Triad Analysis

Second Triad Analysis

Calibration Curve

METHANE

Date:	Response	Unit:AREA
08Sep2009	Z1=0.00000	R1=900184.0 T1=74841.00
	R2=899931.0	Z2=0.00000 T2=74878.00
	Z3=0.00000	T3=75055.00 R3=898275.0
Avg. Concentration:	8.460	PPM

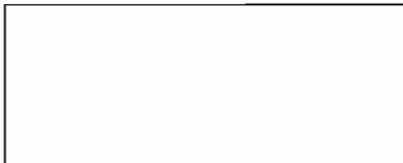

Concentration = A + Bx + Cx ² + Dx ³ + Ex ⁴	
r = 0.999995113	
Constants:	A = 0.11264489
B = 0.000109556	C = 0
D = 0	E = 0

APPROVED BY:

ROBERT LESNIAK

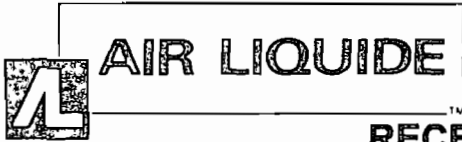

RECERTIFICATION OF ANALYSIS

Interference Free Multi-Component EPA Protocol Gases

Note: Analytical uncertainty and NIST traceability are in compliance with EPA-600/R-97/121
Section 2.2, Procedure G-1

Cylinder S/N: CC124363

Customer: AIR HYGIENE
Location: TULSA, OK

Shipping Order Number: 33119767
Transfer Number: 33119767
Lot Number: SFS131619
Valve: CGA 660
Cylinder Pressure: 2000 PSIG
*Cylinder should not be used when gas pressure is below 150 psig

P.O. Number: 9032901
Item Number: SGZCAH032

Assay Date: 29-Apr-2009

Expiration Date: 29-Apr-2011

Components	Requested Concentration	Assay Concentration
Nitrogen	Balance	Balance
Nitrogen Dioxide	45-50 ppm	47.6 ± 1.2 ppm

Reference Standard(s) Employed For Analysis

Certified Concentration and Uncertainty	Component	Balance	Cyl. No.	SRM/PRM/Mix No.	Exp. Date	Sample No.	Type
51.4 ± 1.2 ppm	Nitrogen Dioxide	Nitrogen	EB0009973	SFS119543	12-Jul-2010	BI	GMIS

Analytical Data

Component: Nitrogen Dioxide		FIRST TRIAD ANALYSIS 29-Jan-2009			SECOND TRIAD ANALYSIS 29-Apr-2009			Units
Analyzer Information		INITIAL ASSAY			Zero	Trial 1	Trial 2	Trial 3
Analyzer Type:	Fourier Transform IR				Reference	51.223	51.248	51.247
Manufacturer:	MKS Instruments				Candidate	47.290	47.394	47.422
Model Number:	2031				Result	47.45	47.54	47.56
Serial Number:	10387278				Evaluation	Valid	Valid	Valid
MPR Last Calibrated:	29-Apr-2009	Evaluation	Valid	Valid	Valid			
Analytical Principle:	FTIR	Mean Analytical Result: 47.78 ppm			Mean Analytical Result: 47.52 ppm			

Analyst:  Tan Ngo

Approved by:  Thuan Tran

APPENDIX D
QUALITY ASSURANCE AND QUALITY CONTROL DATA

QA/QC PROGRAM

Air Hygiene ensures the quality and validity of its emission measurement and reporting procedures through a rigorous quality assurance (QA) program. The program is developed and administered by an internal QA team and encompasses five major areas:

1. QA reviews of reports, laboratory work, and field testing
2. Equipment calibration and maintenance
3. Chain-of-custody
4. Training
5. Knowledge of current test methods

Each of these areas is discussed individually below.

QA Reviews

Air Hygiene's review procedure includes review of each source test report, along with laboratory and fieldwork, by the QA Team. The most important review is the one that takes place before a test program begins. The QA Team works closely with technical division personnel to prepare and review test protocols. Test protocol review includes selection of appropriate test procedures, evaluation of interferences or other restrictions that might preclude use of standard test procedures, and evaluation and/or development of alternate procedures.

Equipment Calibration and Maintenance

The equipment used to conduct the emission measurements is maintained according to the manufacturer's instructions to ensure proper operation. In addition to the maintenance program, calibrations are carried out on each measurement device according to the schedule outlined by the Environmental Protection Agency. Quality control checks are also conducted in the field for each test program.

Chain-of-Custody

Air Hygiene maintains full chain-of-custody documentation on all samples and data sheets. In addition to normal documentation of changes between field sample custodians, laboratory personnel, and field test personnel, Air Hygiene documents every individual who handles any test component in the field (e.g., probe wash, impinger loading and recovery, filter loading and recovery, etc.). Samples are stored in a locked area to which only Air Hygiene personnel have access. Field data sheets are secured at Air Hygiene's offices upon return from the field.

Training

Personnel's training is essential to ensure quality testing. Air Hygiene has formal and informal training programs, which include:

1. Attendance at EPA-sponsored training courses
2. Enrollment in EPA correspondence courses
3. A requirement for all technicians to read and understand Air Hygiene's QA manual
4. In-house training and QA meetings on a regular basis
5. Maintenance of training records

Knowledge of Current Test Methods

With the constant updating of standard test methods and the wide variety of emerging test procedures, it is essential that any qualified source tester keep abreast of new developments. Air Hygiene subscribes to services, which provide updates on EPA reference methods, rules, and regulations. Additionally, source test personnel regularly attend and present papers at testing and emission-related seminars and conferences. Air Hygiene personnel maintain membership in the Air and Waste Management Association and the American Industrial Hygiene Association.

COMBUSTION TESTING QUALITY ASSURANCE ACTIVITIES

A number of quality assurance activities were undertaken before, during, and after this testing project. This section of the report combined with the documentation in Appendix C describes each of those activities.

Each instrument's response was checked and adjusted in the field prior to the collection of data via multi-point calibration. The instrument's linearity was checked by adjusting its zero and span responses to zero nitrogen and an upscale calibration gas in the range of the expected concentrations. The instrument response was then challenged with other calibration gases of known concentration and accepted as being linear if the response of the other calibration gases agreed within plus or minus two percent of the range of predicted values. NO₂ to NO conversion was checked via direct connect with an EPA Protocol certified concentration of NO₂ in a balance of nitrogen. Conversion was verified to be between 90 and 110 percent.

After each test run, the analyzers were checked for zero and span drift. This allowed each test run to be bracketed by calibrations and documents the precision of the data just collected. The criterion for acceptable data is that the instrument drift is no more than three percent of the full-scale response. The quality assurance worksheets in the following pages summarize all multipoint calibration checks and zero to span checks performed during the tests. These worksheets (as prepared from the data records of Appendix A) show that no drifts in excess of three percent occurred in the zero to span checks following each test run.

The sampling systems were leak checked by demonstrating that a vacuum greater than 10 in Hg could be held for at least one minute with a decline of less than one inch of Hg. A leak test was conducted after the sample system was set up and before the system was dismantled. This test was conducted to ensure that ambient air had not diluted the sample. Any leakage detected prior to the tests would be repaired and another leak check conducted before testing commenced. No leaks were found during the pre or post-test leak checks.

The absence of leaks in the sampling system was also verified by a sampling system bias check. The sampling system's integrity was tested by comparing the responses of the analyzers to the calibration gases introduced via two paths. The first path was directly into the analyzer and the second path via the sample system at the sample probe. Any difference in the instrument responses by these two methods was attributed to sampling system bias or leakage. The criterion for acceptance is agreement within five percent of the span of the analyzer.

The control gases used to calibrate the instruments were analyzed and certified by the compressed gas vendors to plus or minus one percent accuracy for all gases. EPA Protocol No. 1 was used, where applicable to assign the concentration values traceable to the National Institute of Standards and Technology (NIST), Standard Reference Materials (SRM's). The gas calibration sheets as prepared by the vendor are contained in Appendix C.

Air Hygiene collected and reported the enclosed test data in accordance with the procedures and quality assurance activities described in this test report. Air Hygiene makes no warranty as to the suitability of the test methods. Air Hygiene also assumes no liability relating to the interpretation and use of the test data.

INSTRUMENTAL ANALYSIS QUALITY ASSURANCE DATA

Date: April 7, 2011
Company: Florida Power and Light
Location: Loxahatchee, Florida
Techs: JRF/MV

Sample System Leak Check

Date	Sample System	Leak Rate (l/min)
April 7, 2011	1	0

Calibration Date: April 7, 2011
 Client: Florida Power and Light

NOx Span (ppm) = 23.60

THERMO 42i-HL (NOx Analyzer)				
Certified Concentration (ppm)	Instrument Response (ppm)	Calibration Error (%)	Absolute Conc. (ppm)	Pass or Fail (±2%, ≤0.5ppm)
0.00	0.12	0.51	0.12	YES (%)
12.10	12.50	1.69	0.40	YES (%)
23.60	23.42	-0.76	0.18	YES (%)
Linearity = 1.012				

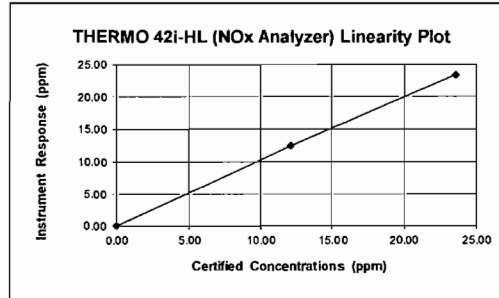

CO Span (ppm) = 23.20

THERMO 48i (CO Analyzer)				
Certified Concentration (ppm)	Instrument Response (ppm)	Calibration Error (%)	Absolute Conc. (ppm)	Pass or Fail (±2%, ≤0.5ppm)
0.00	0.04	0.17	0.04	YES (%)
12.10	12.23	0.56	0.13	YES (%)
23.20	23.35	0.65	0.15	YES (%)
Linearity = 0.995				

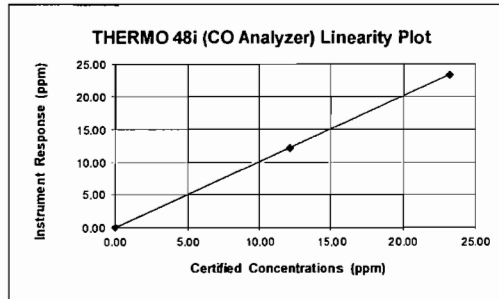

O₂ Span (%) = 21.10

THERMO 42i-HL (O ₂ Analyzer)				
Certified Concentration (%)	Instrument Response (%)	Calibration Error (%)	Absolute Conc. (%)	Pass or Fail (±2%, ≤0.5%)
0.00	0.02	0.09	0.02	YES (%)
12.10	12.30	0.95	0.20	YES (%)
21.10	21.52	1.99	0.42	YES (%)
Linearity = 0.982				

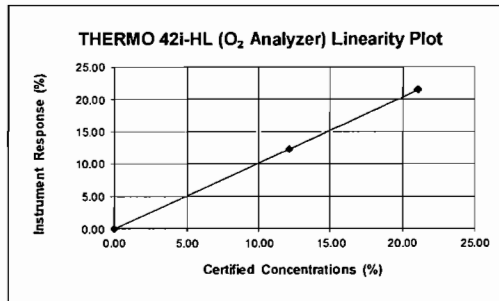

THC Range (ppm) = 10

THERMO 51C-HT (THC Analyzer)				
Certified Concentration (ppm)	Instrument Response (ppm)	Calibration Error (%)	Estimated Point (ppm)	Pass or Fail (±2.5%) ¹
0.00	-0.02	-0.20	N/A	YES
3.10	3.13	1.02	3.10	YES
4.76	4.97	4.24	4.77	YES
8.46	8.49	0.30	N/A	YES
Linearity = 1.007				

¹zero/high based on 2% of span/low/mid based on 5% of concentration

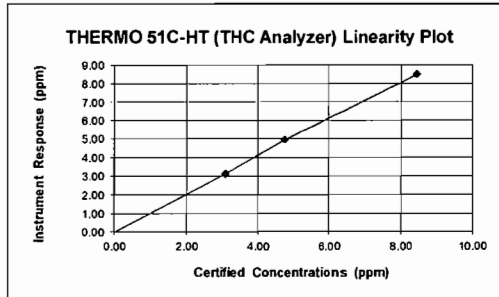

CO₂ Span (%) = 19.10

THERMO 410i (CO ₂ Analyzer)				
Certified Concentration (%)	Instrument Response (%)	Calibration Error (%)	Absolute Conc. (%)	Pass or Fail (±2%, ≤0.5%)
0.00	0.04	0.21	0.04	YES (%)
8.91	9.04	0.68	0.13	YES (%)
19.10	19.24	0.73	0.14	YES (%)
Linearity = 0.995				

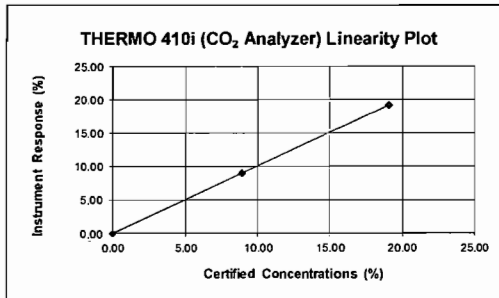

NOx Converter Efficiency

Date: April 7, 2011

Analyzer: INST-N2-0001

RM 7E, (12-17-09), Sections 7.1.4; 8.2.4.1; 12.7; and 13.5 Introduce NO₂ to the analyzer and record the NOx concentration displayed. ... Calculate the converter efficiency using Equation 7E-7. The specification for converter efficiency must be met. ... Air Hygiene also references ALT-0013 for specific NO₂ concentration (40-60 ppm) and EPA Traceability Protocol requirements (±2%).

Audit Gas:	NO ₂ Concentration (C _v), ppmvd	47.60
Converter Efficiency Calculations:		
	Analyzer Reading, NO Channel, ppmvd	1.95
	Analyzer Reading, NOx Channel, ppmvd	47.27
	Analyzer Reading, NO ₂ Channel (C _{Dir(NO2)}), ppmvd	45.32
	Converter Efficiency, %	95.21

RM 7E, (08-15-06), 13.5 NO₂ to NO Conversion Efficiency Test (as applicable). The NO₂ to NO conversion efficiency, calculated according to Equation 7E-7 or Equation 7E-9, must be greater than or equal to 90 percent.

$$Eff_{NO_2} = \left(\frac{C_{Dir}}{C_v} \right) \times 100 \quad \text{Eq. 7E-7} = \frac{45.32 \text{ ppmvd}}{47.60 \text{ ppmvd}} \times 100 = 95.21\%$$

Date/Time mm/dd/yy hh:mm:ss	Elapsed Time Seconds	NOx ppmvd	NO ppmvd
04/07/11 10:13:18	12030	18.43	7.62
04/07/11 10:13:48	12060	42.50	2.54
04/07/11 10:14:18	12090	45.99	2.07
04/07/11 10:14:48	12120	46.47	2.05
04/07/11 10:15:18	12150	46.76	2.04
04/07/11 10:15:48	12180	46.93	2.00
04/07/11 10:16:18	12210	47.07	1.98
04/07/11 10:16:48	12240	47.20	1.97
04/07/11 10:17:18	12270	47.27	1.95
04/07/11 10:17:48	12300	45.26	4.60

DRIFT AND BIAS CHECK			
Strat Test Pre and Post QA/QC Check	O2	CO	NOx
Initial Zero	0.01	0.08	0.06
Final Zero	0.01	-0.33	0.03
Avg. Zero	0.01	-0.13	0.05
Initial UpScale	12.19	12.21	12.10
Final UpScale	12.12	12.31	12.14
Avg. UpScale	12.16	12.26	12.12
Sys Resp (Zero)	0.02	0.04	0.12
Sys Resp (Upscale)	12.30	12.23	12.50
Upscale Cal Gas	12.10	12.10	12.10
Initial Zero Bias	-0.05%	0.17%	-0.25%
Final Zero Bias	-0.05%	-1.59%	-0.38%
Zero Drift	0.00%	1.77%	0.13%
Initial Upscale Bias	-0.52%	-0.09%	-1.69%
Final Upscale Bias	-0.85%	0.34%	-1.53%
Upscale Drift	0.33%	0.43%	0.17%
Alternative Specification Abs Diff	Initial Zero	0.01	0.04
	Final Zero	0.01	0.37
	Initial Upscale	0.11	0.02
	Final Upscale	0.18	0.08
Calibration Span	21.10	23.20	23.60
3% of Range (drift)	0.63	0.70	0.71
5% of Range (bias)	1.06	1.16	1.18

Response Time (min)	1.0	1.7	1.7
Sys. Response (min)	1.7		

Date/Time	O2	CO	NOx	
mm/dd/yy hh:mm:ss	%	ppm	ppm	
04/07/11 08:11:28	13.55	12.54	8.77	
04/07/11 08:11:38	13.56	12.72	8.79	
04/07/11 08:11:48	13.56	12.93	8.55	
04/07/11 08:11:58	13.58	13.19	8.53	
04/07/11 08:12:08	9.21	13.35	8.39	
04/07/11 08:12:18	10.96	13.47	7.62	
04/07/11 08:12:28	12.14	11.41	5.00	x
04/07/11 08:12:38	12.18	5.94	2.44	
04/07/11 08:12:48	12.17	2.26	0.69	
04/07/11 08:12:58	12.19	1.07	0.20	x
04/07/11 08:13:08	12.18	0.26	0.00	x
04/07/11 08:13:18	12.19	0.21	-0.12	
04/07/11 08:13:28	12.18	0.17	-0.16	
04/07/11 08:13:38	12.19	0.15	-0.10	
04/07/11 08:13:48	12.18	0.12	-0.07	
04/07/11 08:13:58	12.18	0.11	-0.19	
04/07/11 08:14:08	12.18	0.10	-0.10	
04/07/11 08:14:18	12.20	0.10	-0.07	
04/07/11 08:14:28	12.19	0.10	-0.04	x
04/07/11 08:14:38	12.19	0.09	-0.09	
04/07/11 08:14:48	12.18	0.09	-0.09	
04/07/11 08:14:58	9.86	0.07	-0.04	
04/07/11 08:15:08	0.78	0.12	0.78	
04/07/11 08:15:18	0.12	0.13	3.88	x
04/07/11 08:15:28	0.07	2.13	7.39	
04/07/11 08:15:38	0.07	7.54	10.06	
04/07/11 08:15:48	0.06	11.12	11.46	
04/07/11 08:15:58	0.05	11.71	11.85	x
04/07/11 08:16:08	0.04	12.08	11.97	
04/07/11 08:16:18	0.05	12.12	12.11	
04/07/11 08:16:28	0.04	12.15	12.03	
04/07/11 08:16:38	0.04	12.16	12.03	
04/07/11 08:16:48	0.03	12.17	12.11	
04/07/11 08:16:58	0.04	12.19	11.98	
04/07/11 08:17:08	0.03	12.20	11.92	

INJECTIONS

DRIFT AND BIAS CHECK						
Fuel Oil Load, Run - 1	O ₂	NOx	CO	VOC	CO ₂	
Raw Average	13.58	7.58	7.17	1.21	5.51	
Corrected Average	13.57	7.56	7.17	1.32	5.37	
Initial Zero	0.01	0.03	-0.33	-0.07	-0.01	
Final Zero	0.01	0.03	-0.19	-0.07	0.18	
Avg. Zero	0.01	0.03	-0.26	-0.07	0.09	
Initial UpScale	12.12	12.14	12.31	3.08	8.99	
Final UpScale	12.10	12.10	12.23	3.35	9.17	
Avg. UpScale	12.11	12.12	12.27	3.22	9.08	
Sys Resp (Zero)	0.02	0.12	0.04	-0.02	0.04	
Sys Resp (Upscale)	12.30	12.50	12.23	3.13	9.04	
Upscale Cal Gas	12.10	12.10	12.10	3.10	8.91	
Initial Zero Bias	-0.05%	-0.38%	-1.59%	-0.50%	-0.26%	
Final Zero Bias	-0.05%	-0.38%	-0.99%	-0.50%	0.73%	
Zero Drift	0.00%	0.00%	0.60%	0.00%	0.99%	
Initial Upscale Bias	-0.85%	-1.53%	0.34%	-0.50%	-0.26%	
Final Upscale Bias	-0.95%	-1.69%	0.00%	2.20%	0.68%	
Upscale Drift	0.09%	0.17%	0.34%	2.70%	0.94%	
Alternative Specification Abs Diff	Initial Zero	0.01	0.09	0.37	--	0.05
	Final Zero	0.01	0.09	0.23	--	0.14
	Initial Upscale	0.18	0.36	0.08	--	0.05
	Final Upscale	0.20	0.40	0.00	--	0.13
Calibration Span	21.10	23.60	23.20	10.00	19.10	
3% of Cal. Span (drift)	0.63	0.71	0.70	0.30	0.57	
5% of Cal. Span (bias)	1.06	1.18	1.16	0.50	0.96	

DRIFT AND BIAS CHECK						
Fuel Oil Load, Run - 2	O ₂	NOx	CO	VOC	CO ₂	
Raw Average	13.56	7.72	7.31	0.87	5.72	
Corrected Average	13.41	7.82	7.45	0.93	5.48	
Initial Zero	0.01	0.03	-0.19	-0.07	0.18	
Final Zero	0.56	0.04	-0.40	0.07	0.40	
Avg. Zero	0.29	0.04	-0.30	0.00	0.29	
Initial UpScale	12.10	12.10	12.23	3.35	9.17	
Final UpScale	12.42	11.76	11.87	3.08	9.06	
Avg. UpScale	12.26	11.93	12.05	3.22	9.12	
Sys Resp (Zero)	0.02	0.12	0.04	-0.02	0.04	
Sys Resp (Upscale)	12.30	12.50	12.23	3.13	9.04	
Upscale Cal Gas	12.10	12.10	12.10	3.10	8.91	
Initial Zero Bias	-0.05%	-0.38%	-0.99%	-0.50%	0.73%	
Final Zero Bias	2.56%	-0.34%	-1.90%	0.90%	1.88%	
Zero Drift	2.61%	0.04%	0.91%	1.40%	1.15%	
Initial Upscale Bias	-0.95%	-1.69%	0.00%	2.20%	0.68%	
Final Upscale Bias	0.57%	-3.14%	-1.55%	-0.50%	0.10%	
Upscale Drift	1.52%	1.44%	1.55%	2.70%	0.58%	
Alternative Specification Abs Diff	Initial Zero	0.01	0.09	0.23	--	0.14
	Final Zero	0.54	0.08	0.44	--	0.36
	Initial Upscale	0.20	0.40	0.00	--	0.13
	Final Upscale	0.12	0.74	0.36	--	0.02
Calibration Span	21.10	23.60	23.20	10.00	19.10	
3% of Cal. Span (drift)	0.63	0.71	0.70	0.30	0.57	
5% of Cal. Span (bias)	1.06	1.18	1.16	0.50	0.96	

DRIFT AND BIAS CHECK						
Fuel Oil Load, Run - 3	O ₂	NOx	CO	VOC	CO ₂	
Raw Average	13.70	7.33	7.49	0.88	5.77	
Corrected Average	13.38	7.63	7.85	0.98	5.46	
Initial Zero	0.56	0.04	-0.40	0.07	0.40	
Final Zero	0.89	0.00	-0.42	-0.10	0.58	
Avg. Zero	0.73	0.02	-0.41	-0.02	0.49	
Initial UpScale	12.42	11.76	11.87	3.08	9.06	
Final UpScale	12.51	11.48	11.66	3.04	9.13	
Avg. UpScale	12.47	11.62	11.77	3.06	9.10	
Sys Resp (Zero)	0.02	0.12	0.04	-0.02	0.04	
Sys Resp (Upscale)	12.30	12.50	12.23	3.13	9.04	
Upscale Cal Gas	12.10	12.10	12.10	3.10	8.91	
Initial Zero Bias	2.56%	-0.34%	-1.90%	0.90%	1.88%	
Final Zero Bias	4.12%	-0.51%	-1.98%	-0.80%	2.83%	
Zero Drift	1.56%	0.17%	0.09%	1.70%	0.94%	
Initial Upscale Bias	0.57%	-3.14%	-1.55%	-0.50%	0.10%	
Final Upscale Bias	1.00%	-4.32%	-2.46%	-0.90%	0.47%	
Upscale Drift	0.43%	1.19%	0.91%	0.40%	0.37%	
Alternative Specification Abs Diff	Initial Zero	0.54	0.08	0.44	--	0.36
	Final Zero	0.87	0.12	0.46	--	0.54
	Initial Upscale	0.12	0.74	0.36	--	0.02
	Final Upscale	0.21	1.02	0.57	--	0.09
Calibration Span	21.10	23.60	23.20	10.00	19.10	
3% of Cal. Span (drift)	0.63	0.71	0.70	0.30	0.57	
5% of Cal. Span (bias)	1.06	1.18	1.16	0.50	0.96	

METERING SYSTEM DRY GAS METER CALIBRATION SHEET

EPA Reference Method

Metering System Pre-Test Calibration

Air Hygiene Asset ID: samp-cp-0010

Filename: C:\Users\jfaehlenk\AppData\Local\Microsoft\Windows\Temporary Internet Files\Content.Outlook\K5ZODGNTC\SAMP-CP-0010 Calibration 3-4-11.xls\3-4-11 (5 point)

Make: Thermo Environmental
 Model #: MST-C1
 Serial #: 90693

Date: 03/04/11
 Barometric Pressure: 29.85 (in. Hg)
 Theoretical Critical Vacuum: 14.08 (in. Hg)

DRY GAS METER READINGS						
ΔH (in. H2O)	Time (min)	Volume			Initial Temperature	
		Initial (ft³)	Final (ft³)	Total (ft³)	Inlet (°F)	Outlet (°F)
0.78	17.00	91.440	100.260	8.820	84.0	79.0
1.10	12.00	100.260	107.390	7.130	77.0	77.0
1.40	10.00	107.390	114.280	6.890	75.0	75.0
2.30	10.00	114.280	123.040	8.760	75.0	75.0
3.50	10.00	123.040	133.620	10.580	75.0	74.0

Final Temperature		Orifice Serial# (number)	K' Orifice Coefficient (see above)	Actual Vacuum (in. Hg)	Ambient Temperature		
Inlet (°F)	Outlet (°F)				Initial (°F)	Final (°F)	Average (°F)
77.0	77.0	15	0.3865	16.0	69.6	70.0	69.8
75.0	75.0	17	0.4454	16.0	70.0	70.0	70.0
75.0	75.0	19	0.5196	16.0	70.0	70.2	70.1
75.0	74.0	25	0.6642	15.5	70.2	70.2	70.2
77.0	74.0	30	0.8090	14.5	70.0	69.8	69.9

RESULTS				
DRY GAS METER		ORIFICE		
VOLUME CORRECTED	VOLUME CORRECTED	VOLUME CORRECTED	VOLUME CORRECTED	VOLUME NOMINAL
Vm(std) (ft³)	Vm(std) (liters)	Vcr(std) (ft³)	Vcr(std) (liters)	Vcr (ft³)
8.629	244.37	8.521	241.3	8.573
7.023	198.90	6.930	196.3	6.975
6.805	192.71	6.737	190.8	6.782
8.675	245.66	8.610	243.8	8.670
10.503	297.44	10.490	297.1	10.557

DRY GAS METER CALIBRATION FACTOR Y		ORIFICE CALIBRATION FACTOR ΔH@		
Variation (number)	Value (number)	Value (in. H2O)	Value (mm H2O)	Variation (in. H2O)
-0.004	0.987	1.710	43.43	-0.035
-0.004	0.987	1.823	46.31	0.078
-0.001	0.990	1.709	43.40	-0.037
0.001	0.993	1.720	43.68	-0.025
0.008	0.999	1.765	44.82	0.019
AVERAGE:	0.991	1.745	44.33	PASSED

Notes:

For Calibration Factor Y, the ratio of the reading of the calibration meter to the dry gas meter, acceptable tolerance of individual values from the average is +/- 0.02. For Orifice Calibration Factor ΔH@, the orifice differential pressure in inches of H₂O that equates to 0.75 cfm of air at 68 °F and 29.92 inches of Hg, acceptable tolerance of individual values from the average is +/- 0.2. For valid test results, the Actual Vacuum should be 1 to 2 in. Hg greater than the Theoretical Critical Vacuum shown above. The Critical Orifice Coefficient, K', must be entered in English units, (ft)³*(deg R)^{0.5}/((in.Hg)*(min)).

SIGNATURE: _____

Craig McCarty

DATE: 03/04/11 03/04/11

METERING SYSTEM THERMOCOUPLE CALIBRATION SHEET

EPA Reference Method

Metering System Pre-Test Calibration

Air Hygiene Asset ID: samp-cp-0010

Filename: C:\Users\jahrenkamp\AppData\Local\Microsoft\Windows\Temporary Internet Files\Content.Outlook\5ZODGNTC[SAMP-CP-0010 Calibration 3-4-11.xls]3-4-11 (5 point)

Make: Thermo Environmental

Date:

Model #: MST-C1

Barometric Pressure: 29.85 (in. Hg)

Serial #: 90693

Temperature (ASTM cal): 67.90 (°F)

Thermocouple	100 (°F)		600 (°F)		1200 (°F)	
	Reading	% Error	Reading	% Error	Reading	% Error
Stack	99.00	0.50	600.00	0.00	1197.00	0.25
Probe	100.00	0.00	601.00	0.17	1197.00	0.25
Filter	100.00	0.00	601.00	0.17	1197.00	0.25
Dryer	99.00	0.50	600.00	0.00	1197.00	0.25
Aux.	99.00	0.50	600.00	0.00	1197.00	0.25

Note: Calibrated against an ALTEK Thermocouple Source Series 22, direct temperature output calibrated to ASTM and IPTS standards as outlined in ALTEK Data Sheet 22.

Thermocouple	67.90 (°F)	
	Reading	(±°F)
DGM In	68.0	0.10
DGM Out	68.0	0.10

Note: Calibrated against ASTM Reference Thermometer.

SIGNATURE: Craig McCarty

DATE: 03/04/11 03/04/11

Standard for Calibration of Console Thermocouple Systems

40 CFR, Part 60

Appendix A, Method 5

10.3.2 The temperature data recorded in the field shall be considered valid. If, during calibration, the absolute temperature measured with the sensor being calibrated and the reference sensor **agree within 1.5 percent**, the temperature data taken in the field shall be considered valid.

Standard for Calibration of Individual Thermocouples

EMC, ALT-011: After each test run series, check the accuracy (and, hence, the calibration) of each thermocouple system at ambient temperature, or any other temperature, within the range specified by the manufacturer, using a reference thermometer (either ASTM reference thermometer or a thermometer that has been calibrated against an ASTM reference thermometer). The temperatures of the thermocouple and reference thermometers shall **agree to within ±2°F**.

PROBE (STACK), HOTBOX (FILTER), AND GOOSENECK (EXIT) THERMOCOUPLE CALIBRATION SHEET

EPA Reference Method

Metering System Pre-Test Calibration

Air Hygiene Asset ID(s): Probe: samp-hp-0052 Hotbox: samp-bh-0014 Gooseneck: samp-ad-0034

Filename: C:\Users\jfehlenk\mp\AppData\Local\Microsoft\Windows\Temporary Internet Files\Content.Outlook\5ZODGNTC\SAMP-CP-0010 Calibration 3-4-11.xls]3-4-11 (5 point)

Barometric Pressure: 29.85

Thermo-couples	Temps		Signature	Date	
		(°F)			
Stack	Ref	68.00	<i>Craig McCarty</i>	03/04/11	03/04/11
	Read	68.00			
	±°F	0.00			
Filter	Ref	68.00	<i>Craig McCarty</i>	03/04/11	03/04/11
	Read	68.00			
	±°F	0.00			
Exit	Ref	68.00	<i>Craig McCarty</i>	03/04/11	03/04/11
	Read	68.00			
	±°F	0.00			

Note: Calibrated against ASTM Reference Thermometer.

Standard for Calibration of Individual Thermocouples

EMC, ALT-011: After each test run series, check the accuracy (and, hence, the calibration) of each thermocouple system at ambient temperature, or any other temperature, within the range specified by the manufacturer, using a reference thermometer (either ASTM reference thermometer or a thermometer that has been calibrated against an ASTM reference thermometer). The temperatures of the thermocouple and reference thermometers shall agree to within ±2°F.

NOZZLE CALIBRATION SHEET

NOZZLE SET IDENTIFICATION: SAMP-NS-0001
CALIBRATION DATE: April 22, 2010
CALIPER NUMBER: SAMP-DC-0011
NAME OF CALIBRATOR: Jake Fahlenkamp

NOZZLE I.D.	DIAMETER	AVERAGE DIAMETER	EPA Method 5, Sec. 10.1 Criteria
I#4	0.109	0.108	PASS
	0.108		
	0.106		
I#6	0.174	0.175	PASS
	0.176		
	0.175		
I#8	0.234	0.232	PASS
	0.231		
	0.232		
I#10	0.311	0.309	PASS
	0.309		
	0.308		
I#12	0.357	0.357	PASS
	0.357		
	0.356		
I#14	0.433	0.434	PASS
	0.436		
	0.434		
I#16	0.488	0.489	PASS
	0.491		
	0.489		

METERING SYSTEM DRY GAS METER CALIBRATION SHEET

EPA Reference Method

Metering System Post-Test Calibration

Air Hygiene Assett ID: samp-cp-0010

Filename: C:\Users\Pandu\Desktop\Westcounty 3A finished work\{SAMP-CP-0010 Calibration 3-4-11-PS.xlsm}4-26-2011 3 pts

Make: Thermo Environmental

Date: 04/26/11

Model #: MST-C1

Barometric Pressure: 29.93 (in. Hg)

Serial #: 90693

Theoretical Critical Vacuum: 14.12 (in. Hg)

DRY GAS METER READINGS						
ΔH (in. H ₂ O)	Time (min)	Volume			Initial Temperature	
		Initial (ft ³)	Final (ft ³)	Total (ft ³)	Inlet (°F)	Outlet (°F)
1.40	10.00	571.100	577.935	6.835	84.0	84.0
1.40	10.00	577.935	584.760	6.825	86.0	84.0
1.40	10.00	584.760	591.580	6.820	88.0	85.0

Final Temperature		Orifice Serial# (number)	K' Orifice Coefficient (see above)	Actual Vacuum (in. Hg)	Ambient Temperature		
Inlet (°F)	Outlet (°F)				Initial (°F)	Final (°F)	Average (°F)
86.0	84.0	19	0.5196	16.0	79.2	79.1	79.2
88.0	85.0	19	0.5196	16.0	79.1	79.0	79.1
89.0	86.0	19	0.5196	16.0	79.0	79.0	79.0

RESULTS				
DRY GAS METER		ORIFICE		
VOLUME CORRECTED	VOLUME CORRECTED	VOLUME CORRECTED	VOLUME CORRECTED	VOLUME NOMINAL
Vm(std) (ft ³)	Vm(std) (liters)	Vcr(std) (ft ³)	Vcr(std) (liters)	Vcr (ft ³)
6.650	188.33	6.698	189.7	6.840
6.625	187.63	6.698	189.7	6.839
6.605	187.06	6.699	189.7	6.839
DRY GAS METER CALIBRATION FACTOR Y		ORIFICE CALIBRATION FACTOR ΔH@		
Variation (number)	Value (number)	Value (in. H ₂ O)	Value (mm H ₂ O)	Variation (in. H ₂ O)
-0.004	1.007	1.704	43.29	0.002
0.000	1.011	1.703	43.24	0.000
0.003	1.014	1.699	43.16	-0.003
AVERAGE:	1.011	1.702	43.23	PASSED
LAST 5-PT:	0.991	1.745	PASSED	5-PT Date:
% DIFF:	2.0%	2.5%		03/04/11

40 CFR - CHAPTER I - PART 60

Appendix A, Method 5

10.3.2 Calibration After Use

After each field use, the calibration of the metering system shall be checked by performing three calibration runs at a single, intermediate orifice setting (based on the previous field test)....Calculate the average value of the DGM calibration factor. If the value has changed by more than 5 percent, recalibrate the meter over the full range of orifice settings, as detailed in Section 10.3.1.

10.3.3 Acceptable Variation in Calibration
If the DGM coefficient values obtained before and after a test series differ by more than 5 percent, the test series shall either be voided, or calculations for the test series shall be performed using whichever meter coefficient value (i.e., before or after) gives the lower value of total sample volume.

Notes: For Calibration Factor Y, the ratio of the reading of the calibration meter to the dry gas meter, acceptable tolerance of individual values from the average is +/- 0.02. For Orifice Calibration Factor ΔH@, the orifice differential pressure in inches of H₂O that equates to 0.75 cfm of air at 68 °F and 29.92 inches of Hg, acceptable tolerance of individual values from the average is +/- 0.2. For valid test results, the Actual Vacuum should be 1 to 2 in. Hg greater than the Theoretical Critical Vacuum shown above. The Critical Orifice Coefficient, K', must be entered in English units, (ft)³*(deg R)^{0.5}/((in.Hg)*(min)).

SIGNATURE

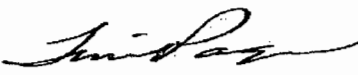

tim page

DATE: 04/26/11 04/26/11

VISIBLE EMISSIONS EVALUATOR

This is to certify that

SIDNEY GASTON

met the specifications of Federal Reference Method 9 and qualifies as a visible emissions evaluator. Maximum deviation on white and black smoke did not exceed 7.5% opacity and no single error exceeding 15% opacity was incurred during the certification test conducted by Eastern Technical Associates of Raleigh, NC. This certificate is valid for six months from date of issue.

10/20/2010 DATE OF SCHOOL	390521 CERT NUMBER	TULSA, OK SCHOOL LOCATION
4/21/2011 CERTIFICATION EXP DATE		GAS748176 STUDENT ID NUMBER
<i>Jody Monk</i> Director of Training		

EASTERN TECHNICAL ASSOCIATES

SIDNEY GASTON

GAS748176 STUDENT ID NUMBER

met the specifications of Federal Reference Method 9 and qualifies as a visible emissions evaluator. Maximum deviation on white and black smoke did not exceed 7.5% opacity and no single error exceeding 15% opacity was incurred during the certification test conducted by Eastern Technical Associates of Raleigh, NC. This certificate is valid for six months from date of issue and expires on the date below.

TULSA, OK SCHOOL LOCATION	10/20/2010 DATE OF SCHOOL	390521 CERT NUMBER
TULF10 LAST LECTURE	4/21/2011 CERTIFICATION EXP DATE	BEARER

Customer Support
Debbie Scalise

debbie@smokeschool.com

Want to know when we will
be in your area? Join our
emailing list at
www.smokeschool.com

919-878-3188

APPENDIX E
FUEL ANALYSIS RECORDS



HOUSTON LABORATORIES
 8820 INTERCHANGE DRIVE
 HOUSTON, TEXAS 77054
 PHONE (713) 660-0901

Certificate of Analysis

Number: 1030-2011040294-001A

Albert Septiano
 Air Hygiene
 5634 S. 122nd East Ave.
 Suite F
 Tulsa OK 74146

May 11, 2011

Sample ID:	Unit 3C	Sampled By:	
Project Name :		Sample Of:	Liquid
Project Number :		Sample Date:	04/07/2011
Project Location:	Tulsa, OK.	Sample Condition:	
Sample Point:		PO / Ref. No:	

ANALYTICAL DATA

Test	Method	Result	Unit	Detection Limit	Lab Tech.	Date Analyzed
Heat of Combustion	ASTM-D-240	19685	Gross BTU / lb		EM	04/26/11
Heat of Combustion	ASTM-D-240	18473	Net BTU/lb		EM	04/26/11
Heat of Combustion	ASTM-D-240	NR	Gross BTU/Gal		EM	04/26/11
Heat of Combustion	ASTM-D-240	NR	Net BTU/Gal		EM	04/26/11
API Gravity @ 60 °F	ASTM-D-5002	37.02			BAC	04/15/11
Specific Gravity @ 60/60 °F	ASTM-D-5002	0.8397			BAC	04/15/11
Density @ 60 °F	ASTM-D-5002	0.8389	g/ml		BAC	04/15/11
Sulfur in Liq. Hydrocarbon by UV	ASTM-D-5453	0.0008	wt %		EM	04/26/11

Comments: NR= No result
 Sample On: 04/07/2011

Hydrocarbon Laboratory Manager

Quality Assurance: The above analyses are performed in accordance with ASTM, UOP or GPA guidelines for quality assurance, unless otherwise stated.



HOUSTON LABORATORIES
8820 INTERCHANGE DRIVE
HOUSTON, TEXAS 77054
PHONE (713) 660-0901

Certificate of Analysis

Number: 1030-2011040294-001B

Albert Septiano
Air Hygiene
5634 S. 122nd East Ave.
Suite F
Tulsa OK 74146

May 03, 2011

Sample ID: Unit 3C
Project Name :
Project Number :
Project Location: Tulsa, OK.
Sample Point:

Sampled By:
Sample Of:
Sample Date: 04/07/2011
Sample Condition:
PO / Ref. No:

ANALYTICAL DATA

Test	Method	Result	Unit	Detection Limit	Lab Tech.	Date Analyzed
Wt% of Carbon	ASTM-D-5291	85.82	wt%	0.30	EM	05/03/11
Wt% of Hydrogen	ASTM-D-5291	14.18	wt%	0.30	EM	05/03/11
Wt% of Nitrogen	ASTM-D-5291	<0.30	wt%	0.30	EM	05/03/11

Comments:

Sample On: 04/07/2011

Hydrocarbon Laboratory Manager

Quality Assurance: The above analyses are performed in accordance with ASTM, UOP or GPA guidelines for quality assurance, unless otherwise stated.

SAMPLE DESCRIPTION AND CHAIN OF CUSTODY RECORD



Air Hygiene International, Inc.
 5634 S. 122nd East Ave, Suite F
 Tulsa, Oklahoma 74146
 (888) 461-8778
 www.airhygiene.com

Project Number:		bv-10-westcounty.fl-comp#2			Laboratory Analysis Requested:		
Person Taking Samples:		JRF					
Sample Number	Location	Date	Volume	Analysis Method			
				ASTM D 920	ASTM D 5002	ASTM D 5453	00
01	Unit 3C	4/8		X	X	X	
02	Unit 3B	4/10		X	X	X	
email to: jake@airhygiene.com							
Sulfur reported in gr/100 dscf, wt%, and ppmw							
Report LHV and HHV							
Retinquished by: (Signature)		Date: 4/14/11	Time: 9:00	Received by: (Signature)		Date: 4/15/11	Time:
Retinquished by: (Signature)		Date:	Time:	Received by: (Signature)		Date:	Time:

Client: Florida Power and Light
Location: West County Energy Center
Date: April 7, 2011
Project #: bv-10-westcounty.fl-comp#2

Fuel Oil - Fuel Analysis

Characteristics of Fuel Gas	
Molecular Weight of oil =	15.360 lb/lb-mole
Btu per lb. of oil =	19,685.00 gross (HHV)
Btu per lb. of oil =	18,473.000 net (LHV)
Density of fuel oil ² =	53.1181 lb/cu. ft
Density of fuel oil ² =	7.1009 lb/gal
Specific Gravity =	0.8526 @ 68 deg F

Standardized to 68 deg F and 14.696 psia

Component	Wt%
carbon	85.82
oxygen	0.00
hydrogen	14.18
nitrogen	0.00
helium	0.00
sulfur	0.00
Total	100.00

Fuel Oil HHV Conv.	
HHV (Btu/lb)	19,685.00
HHV (Btu/SCF)	1,045,630

Fuel Oil LHV Conv.	
LHV (Btu/lb)	18,473.00
LHV (Btu/SCF)	981,251

F-Factor (SCF dry exhaust per MMBtu [HHV]) = 9,292.34 (Based on EPA RM-19) at 68 deg F and 14.696 psia
--

F-Factor Calculation:

$$F\text{-Factor} = 1,000,000 * ((3.64 * \%H) + (1.53 * \%C) + (0.57 * \%S) + (0.14 * \%N) - (0.46 * \%O)) / GCV$$

GCV = Gross Btu per lb. of gas (HHV)

%H, %C, %S, %N, & %O are percent weight values calculated from fuel analysis and have units of (scf/lb)%

Density of fuel oil based on lab analysis or specific gravity multiplied by density of water at 68 deg F and 14.696 psia.

References:

- ¹ ASTM D 3588
- ² Civil Engineering Reference Manual, 7th ed. - Michael R. Lindeburg
- ³ Mark's Standard Handbook for Mechanical Engineers, 10th ed. - Eugene A. Avallone, Theodore Baumeister III
- ⁴ Introduction to Fluid Mechanics, 3rd ed. - William S. Janna
- ⁵ GPA Reference Bulletin 181-86, revised 1986, reprinted 1995

APPENDIX F
STRATIFICATION TEST DATA

Source Information	
Company	Florida Power and Light
Plant Name	West County Energy Center
Equipment	Mitsubishi 501G
Location	Loxahatchee, Florida

Test Information	
Date	04/07/11
Project #	bv-10-westcounty.fl-comp#2
Unit Number	3C
Load	Fuel Oil
Number of Ports Available	4
Number of Ports Used	4

Stack and Test Type	
<input type="radio"/> Isokinetic Traverse (Wet Chemistry Testing) <input type="radio"/> Velocity Traverse (Flow and Flow RATA Test) <input checked="" type="radio"/> Stratification Traverse (Compliance Test) <input type="checkbox"/> RM 20 <input type="radio"/> Stratification Traverse (RATA) <input type="checkbox"/> Part 60 <input type="checkbox"/> Part 75	Circular Stack

METHOD 1 - STRATIFICATION TEST FOR A CIRCULAR SOURCE

Company	Florida Power and Light	Date	04/07/11
Plant Name	West County Energy Center	Project #	bv-10-westcounty.fl-comp#2
Equipment	Mitsubishi 501G	# of Ports Available	4
Location	Loxahatchee, Florida	# of Ports Used	4

Circular Stack or Duct Diameter			
Distance to Far Wall of Stack	(L _{fw})	282.38	in.
Distance to Near Wall of Stack	(L _{nw})	19.00	in.
Diameter of Stack	(D)	263.38	in.
Area of Stack	(A _s)	378.35	ft ²

Distance from Disturbances to Port			
Distance Upstream	(A)	144.00	in.
Diameters Upstream	(A _D)	0.55	diameters
Distance Downstream	(B)	531.75	in.
Diameters Downstream	(B _D)	2.02	diameters

Number of Traverse Points Required					
Diameters to Flow Disturbance		Minimum Number of ¹ Traverse Points		Minimum Number of Traverse Points	
Down (B _D)	Up (A _D)	Particulate	Velocity	Comp Stratification	
Stream	Stream	Points	Points	Criteria	Points
2.00-4.99	0.50-1.24	24	16	RM 7E 8.1.2	12 RM1 pts
5.00-5.99	1.25-1.49	20	16	At 7E 8.1.2	3 points
6.00-6.99	1.50-1.74	16	12	12 points	
7.00-7.99	1.75-1.99	12	12	12 points	
>= 8.00	>= 2.00	8 or 12 ²	8 or 12 ²	Minimum Number of Traverse Points	
Upstream Spec		24	16	RATA Stratification	
Downstream Spec		24	16	RATA Stratification	
Traverse Pts Required		24	16	Criteria	Points
				Part 75/60	12 RM1 pts
				75 abv (a)	3 points
				75 abv (b)	6 points

¹ Check Minimum Number of Points for the Upstream and Downstream conditions, then use the largest.
² 8 for Circular Stacks 12 to 24 inches
 12 for Circular Stacks over 24 inches

Number of Traverse Points Used				
4	Ports by	3	Pts / port	Stratification Traverse
12	Pts Used	12	Required	(Compliance Test)

Traverse Point Locations			
Traverse Point Number	Percent of Stack Diameter	Distance from Inside Wall	Distance Including Reference Length
	%	in.	in.
1	4.4%	11 5/8	30 5/8
2	14.6%	38 4/8	57 4/8
3	29.6%	78	97
4			
5			
6			
7			
8			
9			
10			
11			
12			
13			
14			
15			
16			
17			
18			
19			
20			
21			
22			
23			
24			

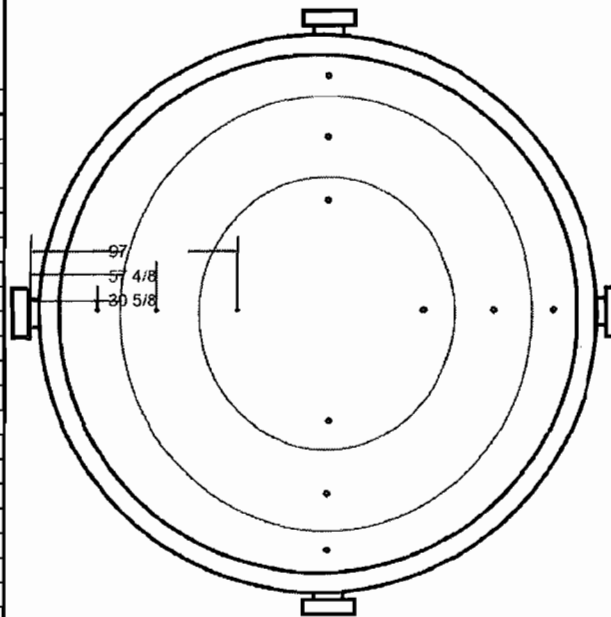
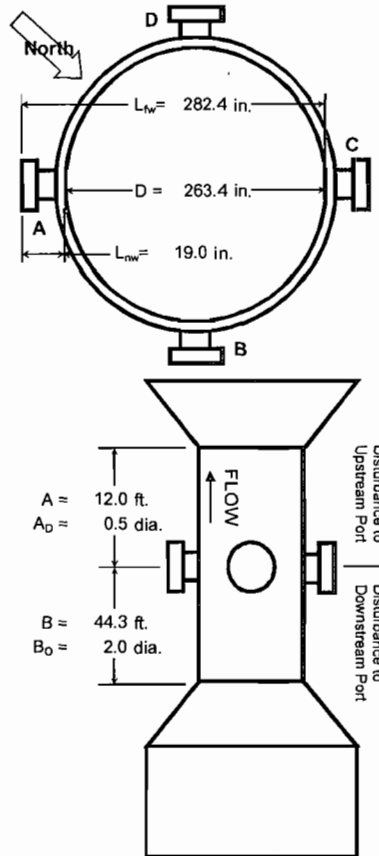

STRATIFICATION TRAVERSE (COMPLIANCE TEST) RESULTS

Company	Florida Power and Light		Date	04/07/11
Plant Name	West County Energy Center		Project #	bv-10-westcounty.fl-comp#2
Equipment	Mitsubishi 501G		# of Ports Available	4
Location	Loxahatchee, Florida		# of Ports Used	4

Stack Dimensions				Traverse Data			
Diameter or Length of Stack	(D)	263.38	in.	4	Ports by	3	Pts / port
Width of Stack	(W)		in.	12	Pts Used	12	Required
Area of Stack	(A _s)	378.35	ft ²	Run Start	10:48:18	Run End	11:39:18

Traverse Point	Time Per Point	Point Start Time	Point Stop Time (Reading)	O2	Percent Difference	CO	Percent Difference	NOx	Percent Difference
	min.	hh:mm:ss	hh:mm:ss	%	%	ppm	%	ppm	%
D-3	3.50	10:48:18	10:51:48	13.89	0.04%	6.98	1.70%	8.67	19.97%
D-2	3.50	10:51:48	10:55:18	13.88	0.11%	6.84	3.67%	8.68	20.11%
D-1	4.00	10:55:18	10:59:18	13.88	0.11%	6.83	3.81%	7.95	10.01%
C-3	7.00	10:59:18	11:06:18	13.90	0.04%	6.35	10.57%	8.88	22.88%
C-2	3.50	11:06:18	11:09:48	13.90	0.04%	6.69	5.79%	7.51	3.92%
C-1	3.50	11:09:48	11:13:18	13.89	0.04%	6.23	12.26%	7.26	0.46%
B-3	6.00	11:13:18	11:19:18	13.90	0.04%	7.20	1.40%	7.62	5.44%
B-2	3.50	11:19:18	11:22:48	13.89	0.04%	7.98	12.38%	6.02	16.70%
B-1	3.50	11:22:48	11:26:18	13.88	0.11%	6.37	10.29%	5.70	21.13%
A-3	6.00	11:26:18	11:32:18	13.92	0.18%	7.55	6.33%	6.96	3.69%
A-2	3.50	11:32:18	11:35:48	13.91	0.11%	8.31	17.03%	5.74	20.57%
A-1	3.50	11:35:48	11:39:18	13.90	0.04%	7.88	10.97%	5.73	20.71%
Average				13.90		7.10		7.23	

STRAT TEST DETERMINED SAMPLE POINTS FOR CIRCULAR STACK

Company	Florida Power and Light	Date	04/07/11
Plant Name	West County Energy Center	Project #	bv-10-westcounty.fl-comp#2
Equipment	Mitsubishi 501G	# of Ports Available	4
Location	Loxahatchee, Florida	# of Ports Used	4

Stack Dimensions				Traverse Data			
Diameter or Length of Stack	(D)	263.38	in.	4	Ports by	3	Pts / port
Width of Stack	(W)		in.	12	Pts Used	12	Required
Area of Stack	(A _s)	378.35	ft ²	Run Start	10:48:18	Run End	11:39:18

40 CFR 60, Appendix A, Method 7E Criteria					
Stratification Results		Traverse Point Number	Percent of Stack Diameter	Distance from Inside Wall	Distance Including Reference Length
Maximum Percent Difference	22.88 % for NOx				
Maximum Pollutant Conc. Diff.	1.65 ppm for NOx				
Maximum Diluent Conc. Diff.	0.02 % for O2				
Stack Diameter	263.38 in.		%	in.	in.
Stratification Conclusions		1			
Maximum % Diff.	Percent Diff. >10% Failed Stratification Test	2			
Maximum Conc. Diff.	Conc. Diff. > 0.5%	3			
Stack Diameter	D > 93.6 in.				

Use RM 1 Measurement Points and Sample Full Stack

Test Type	<input type="checkbox"/> Moisture, for MW	<input type="checkbox"/>
	<input type="checkbox"/> Moisture, for wet-to-dry	<input type="checkbox"/> 6.5.6(b)(2) alt. points do not apply
	<input type="checkbox"/> Gas	

