

energy center

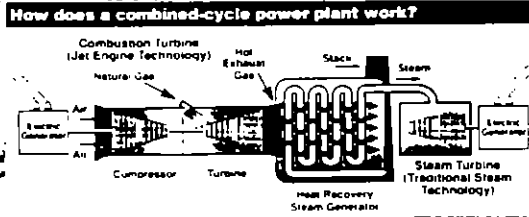

Sufficiency Responses



COMMENTS



From: Barbara_P_Linkiewicz@fpl.com
Sent: Tuesday, June 07, 2005 5:12 PM
To: Kosky, Ken
Cc: Rachel_Godino@fpl.com; John_Gnecco@fpl.com
Subject: West County Energy Center - DEP SED comments

Here are the first sufficiency questions. Steve sent these to us as he has received them. Pls work with Rachel to number and assign responsibility for answering them. Thanks, Barbara

----- Forwarded by Barbara P Linkiewicz/GC/FPL on 06/07/2005 06:11 PM -----

"Palmer, Steven"
<Steven.Palmer@dep.s
Barbara_P_Linkiewicz@fpl.com
tate.fl.us>
Center - DEP SED comments
06/07/2005 12:42 PM

To:
cc:
Subject: West County Energy

Barbara,

Attached are the comments received to date from our district office.

Steve Palmer
Siting Coordination Office

----- Message from "Gray, Tim" <Tim.Gray@dep.state.fl.us> on Mon, 6 Jun 2005 10:34:03 -0400 -----

To: "Oven, Hamilton" <Hamilton.Oven@dep.state.fl.us>

cc: "Palmer, Steven" <Steven.Palmer@dep.state.fl.us>

Subject: More FPL West County Comments

<<West County PPSC>> <<West Country Power Plant>>
Timothy A. Gray Water Resource Management and Environmental Planning Florida
Department of Environmental Protection Southeast District 400 North Congress
Avenue, Suite 200 West Palm Beach, Florida 33401
(561) 681-6708
SC 226-6708
Tim.Gray@dep.state.fl.us

----- Message from "Lurix, Joe" <Joe.Lurix@dep.state.fl.us> on Tue, 3 May 2005 10:29:01 -0400 -----

To: "Gray, Tim" <Tim.Gray@dep.state.fl.us>

cc: "Patino, Jorge" <Jorge.Patino@dep.state.fl.us>, "Wierzbicki, Paul" <Paul.Wierzbicki@dep.state.fl.us>, "Forrest, William" <William.Forrest@dep.state.fl.us>

Subject: West County PPSC

Application as submitted deosn't affect SW or tanks.

1FDEP-1

Joe Lurix
Environmental Manager
Solid Waste and Tank Programs
561/681-6668
SC 226-6668
SED/FDEP
400 North Congress Avenue, Suite 200
West Palm Beach, FL 33401

----- Message from "Offord, Bruce" <Bruce.Offord@dep.state.fl.us> on Fri, 15 Apr 2005 14:39:19 -0400 -----

To: "Graziani, Darrel" <Darrel.Graziani@dep.state.fl.us>

cc: "Tallam, Laxmana" <Laxmana.Tallam@dep.state.fl.us>, "Gray, Tim" <Tim.Gray@dep.state.fl.us>

Subject: West Country Power Plant

2FDEP-1

Have review their application as it applies to mobile source impacts and have found that they have addressed those air quality concerns. The project will generate minimum traffic impacts and will not degrade the level of service (LOS) of the impacted roadways to less than LOS "D" (page 4-16). Air quality impacts generally do not become a concern until you reach LOS "E" or "F".

In my review I did note two items that might need to be addressed:

Page 2-32 The text states that we are in an attainment area for ozone, that should be corrected to indicate that we are in an ozone maintenance area

2FDEP-2

Page 2-33 The text states that FDEP has not adopted the Federal one hour ozone and PM2.5 AAQS, it is my understanding that we had

2FDEP-3

Bruce

----- Message from "Gray, Tim" <Tim.Gray@dep.state.fl.us> on Mon, 6 Jun 2005 10:31:43 -0400 -----

To: "Oven, Hamilton"
<Hamilton.Oven@dep.state.fl.us>

cc: "Palmer, Steven"
<Steven.Palmer@dep.state.fl.us>

Subject: FPL West County Energy Center Comments

FPL West County comments,

<<West County Facility - SCA Comments>> <<Power Plant Review , West County Energy Center>>

Timothy A. Gray
Water Resource Management and Environmental Planning Florida Department of Environmental Protection Southeast District 400 North Congress Avenue, Suite 200 West Palm Beach, Florida 33401
(561) 681-6708
SC 226-6708
Tim.Gray@dep.state.fl.us

----- Message from "Graziani, Darrel" <Darrel.Graziani@dep.state.fl.us> on Thu, 26 May 2005 17:21:19 -0400 -----

To: "Gray, Tim" <Tim.Gray@dep.state.fl.us>, "Linero, Alvaro"
<Alvaro.Linero@dep.state.fl.us>

Subject: West County Facility - SCA Comments

Tim & Al,

Based on review of the application I would offer the following comments as part of the Site Certification Application review:

Site Certification Application

The South Florida Water Management has three pump stations in the area near the proposed site that do not appear to have been included within the inventory of existing air pollutant sources. These sources will impact both increment and NAAQS modeling. (Page 2-33).

3FDEP-1

The generators and fuel heaters (Page 3-8) should be subject to BACT.

3FDEP-2

The proposed BACT level of 2.5 ppmvd @15% oxygen is not consistent with recent projects.

3FDEP-3

3FDEP-4

Based on review it appears that FPL committed to impacts below 50% of the available increment Class II increments. A brief review of the modeling noted Class II consumption modeling for PM10 and only for the 24-hour averaging period. Because there may only be an insignificant amount of Class II Increment available (Sugar Mills, Pump Stations, Biomass Facilities) it doesn't appear that they demonstrated compliance with the development order. (Page 5-30)

PSD Application

Combined Cycle Units

3FDEP-5

Page 9, Since they have asked for the exclusions of emissions during start-up, shutdown, and malfunction it seems appropriate that the facility be subject to a emissions cap on all pollutants subject to an emissions limiting standard.

3FDEP-6

Page 21 - They have asked for a VE limit in-leu of PM testing. Since this is a BACT pollutant I would expect at least initial and renewal testing.

3FDEP-7

Page 21 - They have asked for block 24 hour averages for Nox & CO and that this excludes start-up shutdown and malfunctions. We would request that a longer averaging period (30-day rolling average) also be included within the BACT that addresses SSM. We are have significant trouble enforcing the excess emissions rule and this could answer the compliance problems. Want CEMS for CO & NOx.

3FDEP-8

Page 23 - Yes to the need for a CO Monitor. Include appropriate language that annual RAT can be used as the compliance test or Method 10.

Cooling Tower

3FDEP-9

Page 21 - Method of Compliance should be the solid concentrations The higher the more emissions.

PSD Report

3FDEP-10

The report addresses emission units not covered in the application (4.2 million gal tanks, aux boiler, process heater, Emergency generators) They should complete the application.

3FDEP-11

PSD Page 2-6 says Major HAP Source. Not addressed in the application and raises other questions regarding MACT.

3FDEP-12

PSD Page 2-6 Testing for Formaldehyde and the standard referenced are not addressed in the application

3FDEP-13

PSD Page 2-7 Emergency Generators are MACT and should be addressed in the application and capped to avoid MACT limits

3FDEP-14

PSD Page 2-8 Aux Boiler is subject to a MACT of 400 PPM (CO) and it would be reasonable to think that BACT would be less. The unit is also an NSPS Unit. They are restricting heat input to 99.77 (~ 100) is this Db or Dc under NSPS? The difference is the a NOx CEMS.

3FDEP-15

PSD Page 2-8 Process Heaters MACT & NSPS (Dc)

3FDEP-16

PSD Page 2-9 Excess Emissions. They have requested Nox limits of 2.5 and 10. And the annual emissions reported are associated with these numbers but do not include the excess emissions requested. It seems appropriate that the source accept a longterm average (30 days) that includes the excess emissions. Compliance will be easier based on my experience and less excess emissions reports.

3FDEP-17

PSD Page 3-12 They did not demonstrate compliance with the 50% PBC Criteria.

3FDEP-18

PSD Pages 4-16 and 4-17, the generic exemption criteria does not apply to NSPS or MACT units. The permit needs to address the units through the requested operating restrictions. For the generators this would be hours of operation to avoid the MACT limits. For the boiler and heaters this would include the emission limits and operating restrictions.

Please call to discuss.

Thanks

Darrel

VE BACT - For Gas firing is a VE necessary.

3FDEP-19

----- Message from "Wierzbicki, Paul" <Paul.Wierzbicki@dep.state.fl.us> on Mon, 9 May 2005 13:50:40 -0400 -----

To: "Gray, Tim" <Tim.Gray@dep.state.fl.us>

cc: "Shugar, Kim" <Kim.Shugar@dep.state.fl.us>, "Patino, Jorge" <Jorge.Patino@dep.state.fl.us>, "Lurix, Joe" <Joe.Lurix@dep.state.fl.us>, "Winston, Kathy" <Kathy.Winston@dep.state.fl.us>

Subject: Power Plant Review , West County Energy Center

I have reviewed the document entitled "Site Certification Application West County Energy Center", dated and received at DEP on April 14, 2005 and have the following comments within the scope of the Waste Cleanup Section:

1. What environmental assessments have been conducted or will be conducted in order to determine whether soil, sediments, groundwater, or surface waters have been adversely affected (contaminated) by current or past operations? Part of the environmental assessment must include, among other things, the details of historical and current pesticide usage, identification, including detailed, scaled maps, of current and historical fertilizer and pesticide / herbicide mixing areas (if any), locations of canals and surface water bodies, locations of any above-ground, underground or temporary storage tanks, farming equipment maintenance and storage, petroleum product storage, on-site landfill / solid waste disposal areas, locations and types of any water production wells (potable, pesticide make-up, irrigation, etc.), locations and types of surface water pumps and associated fuel tanks, etc. What soil, sediment, surface water and groundwater cleanup concentrations would be proposed? Are there monitoring wells available for sampling of groundwater? If so, does the facility sample and monitor groundwater from these wells? Please provide a list of the monitored parameters and the results from the sampling and enclose a map depicting these groundwater monitoring wells.

4FDEP-1

2. Page 3-15 indicates that cooling tower blowdown along with other wastewaters will be disposed of using an UIC injection well. If not already done so, the UIC Section should review those portions for any comments they may have.

4FDEP-2

3. Beginning on Page 3-13 Please be advised that hazardous waste determinations are required for wastes and most wastewaters generated in accordance with Title 40 Code of Federal Regulations (C.F.R.) Part 261, as referenced in Chapter 62-730, F.A.C. In addition to any industrial waste treatment and monitoring requirements, all waste streams must be characterized for proper hazardous waste management in accordance with 40 C.F.R. Part 261, including wastes collected in sumps, laboratory wastes and material from solids settling basins . Page 4-4 has a chart and description of waste streams. The chart and a description needs to be included that indicates which waste stream would be hazardous, whether it is based on process knowledge or will be based on analytical testing, and if hazardous, additional information regarding how the facility would manage the storage and treatment of such wastes in accordance with Chapter 62-730, F.A.C., which references portions of Title 40 C.F.R. Parts 260-271, would be required.

4FDEP-3

4FDEP-4

4. Any land clearing or construction debris must be characterized for proper disposal. Potentially hazardous materials must be properly managed in accordance with Chapter 62-730, F.A.C. In addition, any solid wastes or other non-hazardous debris must be managed in accordance with Chapter 62-701, F.A.C.

4FDEP-5

5. Petroleum and hazardous materials storage tanks and emergency generators for planned facilities must be constructed to comply with the current requirements of Chapter 62-761 and / or 62-762, F.A.C. As an example, secondary containment should be planned for all areas where petroleum or hazardous materials discharges could affect soils, sediments, surface or ground waters.

4FDEP-6

6. A staging area, with controlled access, should be planned in order to safely store raw material paints, adhesives, fuels, solvents, etc. that will be used during construction. All containers need to be properly labeled. The project developers should consider developing a written construction Contingency Plan in the event of a natural disaster, spill, fire or environmental release of hazardous materials stored / handled for the project construction. Also, it should be clearly stated that in the event hazardous materials or other non-compliance issues are discovered during project construction, the Department would expect the owner/operator to promptly correct these issues.

4FDEP-7

7. Is a meeting being planned to discuss the application with the applicant? If so, please include me in the meeting so that these concerns can be addressed.

If you have any questions, please call me at 56/681-6677, Suncom 226-6677.

Thank you for the chance to comment.

#050315

Paul Alan Wierzbicki, P.G.
Waste Cleanup Supervisor
Florida Department of Environmental Protection Southeast District 400 North
Congress Ave., Suite 200 West Palm Beach, FL 33401
Telephone: 561/681-6677, Suncom 226-6677
Fax: 561/681-6770, Suncom Fax: 226-6770

Memorandum

Florida Department of Environmental Protection

Steve Palmer, Power Plant Siting Office

FROM: Scott M. Sheplak *sm8*
Bureau of Air Regulation

DATE: June 13, 2005

FP&L - West County Energy Center
Palm Beach County
Sufficiency Review

0990646-001-AC
PSD-FL-354
PA05-47

We have completed our initial sufficiency review for the subject application. Below please find the additional information we need to process the air, prevention of significant deterioration (PSD), part of the application:

Air Permit Application Review Comments

The application states that FP&L is applying for the option to select from three turbine manufacturers. Has FP&L selected a turbine manufacturer?

5FDEP-1

Please submit air pollutant information on the "lb./hour" and "ppm" values during hot, warm and cold start-up conditions for the combustion turbines. Information directly submitted from the turbine manufacturer is preferred.

5FDEP-2

In your best available control technology (BACT) evaluation please revise the economic analyses to provide the cost effectiveness for lowering NOx emissions in ppm to 1.5 in the form of an updated Table 4-2. The most stringent NOx limit nationwide for a combined cycle power plant permit is now less than 2.0 ppm averaged over a one hour period. Please note that two years ago EPA Region IX rejected a BACT proposed of 2.5 from GE7FA units (see letter dated May 2, 2003 from EPA Region IX to Ms. Nancy Wrona, Director, Air Quality Division Arizona Department of Environmental Quality) and the Department has recently determined a BACT of 2.0 ppm for the same air shed (Miami-Dade, Broward & Palm Beach counties). Table 4-2 currently shows the cost effectiveness for a NOx ppm value of 2.5. If you are not proposing to meet the most stringent level, e.g., 1.5 ppm, then cost effectiveness should be calculated at 2.0 ppm for purposes of the analyses. For your information, the department is currently evaluating an application from the Florida Municipal Power Agency for the Treasure Coast Energy Center site in which a NOx limit of 2.0 ppm was proposed. Please note that this proposed site near Ft. Pierce is north of the Miami-Dade, Broward & Palm Beach air shed and further from the Everglades National Park than yours. Based on available information, a BACT limit for NOx of 2.0 ppm or lower with a one hour averaging period appears to now be technically achievable and cost effective.

5FDEP-3

Please explain why higher CO emission limits are proposed for the GE7FB units. These units are much like GE7FA units with greater compression and higher firing temperature. While the greater pressure and temperature account for more NOx into the SCR system, less CO would be expected. A GE7FB unit should behave like running a GE7FA unit in a peaking mode. Please provide the economic analysis for the oxidation catalysts including the cost effectiveness in units of dollars per ton (\$/ton).

5FDEP-4

Air Modeling Review Comments

On page 2.5 of the application, it states that "for the purpose of the air quality analyses, the 22-cell cooling tower design would envelope the 24-cell design given the slightly lower exit velocity and smaller dimensions of the 24-cell tower design." In the previous sentence, it is stated that the 24-cell design has a "slight greater velocity." Does the 24-cell design have a lower or a greater exit velocity?

5FDEP-5

In the text of the application, specifically on page 6-8, it is stated that a generic emission rate of 20 g/s per second was used for this project. However, in the modeling, 3.33 g/s was used for the G-Class and 2.5 g/s for the GE 7FA. Please clarify the generic emission rate that was used in the modeling and calculations for this project.

5FDEP-6

Was ancillary equipment that emits PSD pollutants included in the modeling analyses?

5FDEP-7

The following related comment regarding the land development approval was received from the Palm Beach County Local Air Program:

5FDEP-8

The Palm Beach County Local Air Program believes that the modeling should include an increment analysis for all PSD pollutants, regardless of whether the predicted impacts are above or below the Class II Significant Impact Level. The County does not believe that the increment consumption commitment can be made without determining the amount of available increment in the Class II area for each pollutant. Please clarify the commitment and confirm the modeling requirements (including the source inventory) with Palm Beach County.

Other Comments

The generators and fuel heaters described in the applications are not exempt from permitting since the project is subject to PSD review and the units are avoiding MACT requirements. The selected units should meet BACT limits and the operating restrictions detailed in the application will need to be incorporated in the permit. Please revise the PSD application and include the appropriate information for each unit.

5FDEP-9

On page 20 of the PSD application form "yes" has been checked that the pollutants are synthetically limited. The pollutants that are subject to BACT are not synthetically limited. Please revise the application form as needed and submit updated pages.

5FDEP-10

On page 21 of the PSD application it is stated that the 24-hour block averages for NO_x & CO emissions, exclude start-up, shutdown and malfunctions (SSM). The Department may consider a longer averaging period, e.g., 30-day rolling average within the BACT that addresses SSM. Please include such an average within the BACT evaluation. 5FDEP-11

On page 23 please note that the Department is considering the need for a CO monitor. 5FDEP-12

The PSD report addresses emissions units not covered in the application, e.g., 4.2 million gallon tanks, auxiliary boiler, process heater, emergency generators, etc. Please revise the application form to include these units. 5FDEP-13

The PSD report, page 2-6, states that the facility is a Major HAP Source. This is not addressed in the application and raises other questions regarding MACT applicability. Please re-address the HAP emissions and MACT requirements within the application form. If a case-by-case MACT determinations is required, please include a MACT evaluation. 5FDEP-14

The PSD report page 2-6 references testing for formaldehyde and the MACT standard. Please revise the application form to reflect the standard and the test requirements. 5FDEP-15

The PSD report, page 2-7 implies that the emergency generators are exempt from the MACT based on operating limitations. Please include these limitations within the permit application if you want to escape the MACT requirements. 5FDEP-16

The PSD report, page 2-8, implies that the auxiliary boiler is subject to a MACT of 400 ppm for CO and it would be reasonable to think that BACT would be less. The unit is also an NSPS Unit and it appears that you are requesting a federally enforceable operating limit of 99.77 mmBtu/hr for purposes of avoiding the requirements of 40 CFR Part 60, Subpart Db. Within the revised application form please clarify the intent and the request. 5FDEP-17

The PSD report, page 2-8 implies that the process heaters exempt from the MACT based on operating limitations. Please include these limitations within the permit application if you want to escape the MACT requirements. 5FDEP-18

The PSD report, pages 4-16 and 4-17, implies that the generic exemption criteria applies to several of the units discussed above. Please note that the exemptions do not apply to units subject to BACT, NSPS or NESHAP requirements. Please revise the application form to address the units and any requested operating restrictions. For the generators this would be hours of operation to avoid the MACT limits. For the boiler and heaters this would include the emission limits and operating restrictions. 5FDEP-19

Please document consultation to-date with the EPA, the Federal Land Manager, and the U.S. Fish and Wildlife Service regarding any applicable provisions of the Endangered Species Act. We encourage your early contact with these agencies. 5FDEP-20

Sufficiency Review
0990646-001-AC
PSD-FL-354

5FDEP-21

We did not receive any comments from the National Park Service or EPA Region 4. We will pass these on if and when received. Either agency might submit comments during the sufficiency review or during the normal comment period.

The DEP contacts for the air (PSD) permit application are Debbie Nelson, 850/921-9537 for modeling issues and Scott M. Sheplak, 850/921-9532 on all other matters.

copy to: Al Linero, NSR Program Administrator



GOLDER ASSOCIATES INC.

JUN 3 2005

GAINESVILLE

FLORIDA DEPARTMENT OF STATE
Glenda E. Hood
Secretary of State
DIVISION OF HISTORICAL RESOURCES

Mr. Kennard F. Kosky
Golder Associates, Inc.
6241 NW 23rd Street, Suite 500
Gainesville, Florida 32653-5600

May 26, 2005

RE: DHR Project File Number: 2005-4384
Received by DHR May 6, 2005
Florida Department of Environmental Protection
FPL West County Energy Center Site Certification Application
Palm Beach County

Dear Mr. Kosky:

Our office received and reviewed the referenced project in accordance with Chapters 267 and 403, *Florida Statutes*, and implementing state regulations, for possible impact to historic properties listed, or eligible for listing, in the *National Register of Historic Places (NRHP)*, or otherwise of historical, architectural or archaeological value. The State Historic Preservation Officer is to advise and assist state and federal agencies when identifying historic properties, assessing effects upon them, and considering alternatives to avoid or minimize adverse effects.

Based on the information provided, it is the opinion of this office that the proposed project will have no effect on historic properties.

FDHR-1

However, if fortuitous finds or unexpected discoveries, such as prehistoric or historic artifacts, including pottery or ceramics, stone tools or metal implements, or other physical remains that could be associated with Native American cultures, or early colonial or American settlement are encountered at any time within the project site area, the project should cease all activities involving subsurface disturbance in the immediate vicinity of such discoveries. The applicant, or other designee, should contact the Florida Department of State, Division of Historical Resources, Review and Compliance Section at (850) 245-6333 or (800) 847-7278, as well as the appropriate permitting agency office. Project activities should not resume without verbal and/or written authorization from the Division of Historical Resources.

FDHR-2

If you have any questions concerning our comments, please contact Scott Edwards, Historic Preservationist, by electronic mail sedwards@dos.state.fl.us, or at 850-245-6333 or 800-847-7278.

Sincerely,

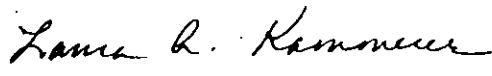
for 
Frederick P. Gaske, Director, and
State Historic Preservation Officer

500 S. Bronough Street • Tallahassee, FL 32399-0250 • <http://www.flheritage.com>

Director's Office
(850) 245-6300 • FAX: 245-6436

Archaeological Research
(850) 245-6444 • FAX: 245-6436

Historic Preservation
(850) 245-6333 • FAX: 245-6437

Historical Museums
(850) 245-6400 • FAX: 245-6433

Southeast Regional Office
(954) 467-4990 • FAX: 467-4991

Northeast Regional Office
(904) 825-5045 • FAX: 825-5044

Central Florida Regional Office
(813) 272-3843 • FAX: 272-2340

1
2
3
4
5
6
7
8
9
10
11
12
13
14
15
16
17
18
19
20
21
22
23
24
25

LAN 04-06

June 13, 2005

Mr. Steven Palmer, P.E.
Siting Coordination Office
Florida Department of Environmental Protection, MS 48
2600 Blair Stone Road
Tallahassee, FL 32399-2400

Dear Mr. Palmer:

**Subject: FPL West County Energy Center, PA05-47
Site Certification Application - First Sufficiency Review**

South Florida Water Management District (SFWMD) staff has reviewed the Site Certification Application (SCA) submitted by the Florida Power & Light Company (FPL) for the above subject project, as required by Sections 403.501-518, F.S., and Rule 62-17, F.A.C. As a result of that review, we have identified the following outstanding issues/sufficiency questions which must be addressed in order for the SFWMD to complete its review of this project. Please include the following questions/comments in your sufficiency letter on this project.

CANAL RIGHT OF WAY OCCUPANCY ISSUES

SFWMD staff cannot support the proposed location of the water pipeline intake structure on the south side of the L-10/L-12 Canal, as illustrated in Figure 3.5.0-1, as it imposes an unnecessary burden on the SFWMD for which an alternative is readily available. In addition, the proposed design shown in Figure 3.5.0-1 is contrary to the SFWMD's Basis of Review, as set forth in Volume V, Criteria Manual for Use of Works of the District (Rule 40E-6, F.A.C.). However, SFWMD staff does support the alternative location/design, as illustrated in Figure 3.5.0-2, on the north side of the L-10/L-12 Canal, which is simpler and less intrusive. Comments applicable to both Figures 3.5.0-1 and 3.5.0-2 are listed below, followed by comments that specifically pertain to each of the two figures.

Comments Applicable to Both Figure 3.5.0-1 and Figure 3.5.0-2

- (1) The sketches provided need to be supported with recent aerial photography of the proposed site. SFWMD-1
- (2) The drawings must show the SFWMD right-of-way lines on both the plan and profile view. SFWMD-2

Mr. Steven Palmer, P.E.
June 13, 2005
Page 2

- (3) The proposed design must employ rip-rap or alternative erosion control measures on canal side-slopes acceptable to the SFWMD. SFWMD-3
- (4) Any temporary construction related activities or techniques need to be covered in the proposal as well as a sequence of work, a time schedule, and an analysis of headloss in the channel due to constrictions imposed by temporary structures (particularly if sheet piling or coffer dams extending into the channel are proposed). SFWMD-4

Comments Applicable to Figure 3.5.0-1

- (5) The sketches need to be drawn to scale or have all dimensions shown. SFWMD-5
- (6) The drawings need to depict the subaqueous water lines which run from the southerly intake structure under the canal northerly on Section A-A. SFWMD-6
- (7) For subaqueous crossings, it will be necessary to submit an existing certified canal cross-section at the centerline of the proposed crossing. Soundings should be taken at 10' intervals from top of bank to top of bank and be plotted on standard cross-section paper, using NGVD as datum and the same horizontal and vertical scale (preferably 1"=10'). The drawings must be signed and sealed by a Florida-registered professional engineer. The cross-sections shall have superimposed upon them the design section for the canal. Available information for this site indicates that the canal design section for this location consists of a 20' bottom width at (-)19.2 bottom elevation with 1 vertical on 2 horizontal sideslopes. SFWMD-7
- (8) The subaqueous installation must be set a minimum of 2' below the canal design section or existing section, whichever produces the lowest installation. SFWMD-8
- (9) The portion of the proposed crossing that is buried within the right-of-way and sideslopes must be buried a minimum of 36" below the existing ground. SFWMD-9
- (10) If any security fencing is proposed, it must be included in the drawing. SFWMD-10
- (11) Any electrical service to the pump station must be shown. SFWMD-11
- (12) If a stand-by generator is proposed at the site, the details of the fuel containment enclosure need to be added to the drawing. SFWMD-12
- (13) It appears that access along the SFWMD's southerly right-of-way is proposed for future operation and maintenance of the pump station. If so, the following information must be provided. SFWMD-13

- (a) An 8-1/2" X 11" drawing that is either drawn to scale or fully-dimensioned that depicts the following:
 - (1) The SFWMD right-of-way lines;
 - (2) The location of the access route tied into a well-known landmark(s); and
 - (3) The precise location of ingress and egress.

- (b) A narrative addressing:
 - (1) The length and time that the proposed use of the right-of-way is being requested;
 - (2) Other alternate routes that are available and an explanation as to why they cannot be used;
 - (3) The type and size of vehicles proposed to be used within the right-of-way and frequency (round trips per day) that each type of vehicle would be using the right-of-way;
 - (4) Posting of financial insurance in the form of a bond or other surety in an amount satisfactory to the SFWMD; and
 - (5) Providing the SFWMD with a Certificate of Insurance to the limits and amounts specified by the SFWMD.

As a point of information, the SFWMD will allow temporary access for construction. However, the SFWMD does not grant permanent access along its rights-of-way. Consequently, if the SFWMD was to grant access along the right-of-way, it will be necessary for FPL to periodically request an extension of the expiration date. Please note that the SFWMD does not guarantee this request will be approved.

- (14) SFWMD criteria does not allow for the construction of permanent pumping facilities within the canal right-of-way (please refer to Section H "Pump Connections" on page 105 of the SFWMD's Basis of Review/Criteria Manual). SFWMD-14

Comments Applicable to Figure 3.5.0-2

- (15) The drawings need to depict the invert elevation of the proposed 8-36" pipes, ground elevations, etc. SFWMD-15

- (16) In order to prevent the discharge of aquatic weeds into the SFWMD's canal system, all culverts 36" in diameter or larger must be equipped with a skimmer or baffle which effectively precludes the discharge of aquatic weeds into the SFWMD's canal system. The skimmer or baffle must be designed to be effective through a range of water surface conditions. SFWMD-16

CONSUMPTIVE USE ISSUES

- (17) In Section 3.0 of the SCA, the demand from the L-10/L-12 canal for the cooling towers and process water is shown on the water mass balance chart as 15.20 million gallons per day (MGD) with the maximum demand as 19.5 MGD. When water from the Upper Floridan Aquifer (UFA) is used as an emergency supply, the total average demand is 15.24 MGD and the maximum demand is 19.48 MGD. Please clarify and revise, as necessary. SFWMD-17
- (18) Please submit a water conservation plan, pursuant to Section 2.4.1 of the Basis of Review (BOR) for Water Use Permit Applications. SFWMD-18
- (19) Pursuant to Section 2.2.1 of the BOR, the applicant must demonstrate legal control over the project site. Pursuant to Section 2.1.2 of the BOR, the applicant must demonstrate legal control over the proposed facilities. Please submit the appropriate documentation. SFWMD-19
- (20) In Section 2.0 of the SCA, potable water supply wells are shown on Figure 2.3.3-1. In Appendix 10.1.8, Figure 6 shows the location of other Surficial Aquifer Wells. Other wells that do exist, some of which are located on adjacent Palm Beach Aggregates property, are not shown and were not included in the modeling. Please submit revised modeling that includes these wells. SFWMD-20
- (21) Monitoring, irrigation, and public water supply wells are located on property that is proposed for the plant site. If these wells are not going to be used for the proposed project, they must be properly plugged and abandoned, pursuant to Rule 40E-3.531, F.A.C. SFWMD-21
- (22) Page 2 of Appendix 10.1.8 states that the proposed exploratory well will be converted into a Floridan Aquifer system dual-zone monitoring well for the four proposed Deep Injection Wells (DIW) in the Boulder Zone. Page 7 of the SCA states that there will be at least three dual-zone monitoring wells to fulfill the spatial requirements between injection wells, in accordance with Rule 62-528.425(1)(g)(4), F.A.C. The SCA proposes to use Upper Floridan Aquifer (UFA) wells as emergency back-up water supply wells when extreme drought precludes the use of surface water from L-10/L-12 canal. The intervals for the monitoring zones (pages 7 and 16) of the dual-zone monitoring wells are described at approximately 1,950 feet bls, or just above the base of the Underground Source of Drinking Water (USDW), and between 2,000 and 2200 feet bls, or in the first transmissive zone below the USDW, as determined by the exploratory well. These intervals are in the Lower Floridan Aquifer (LFA). In the Modeling Section (Appendix 10.7), the SCA states that water from the LFA is not suitable due to high chlorides. However, SFWMD-22

modeling to determine impacts of the emergency withdrawals was done for the UFA, between 750 and 1350 feet bls and for LFA PZ-1 between 1500 and 1650 bls. The site map for the facility (Chapter 3, Sheet 3) does not show any UFA well sites. The proposed UFA wells are not described in the construction details, which only describe the drilling and testing of the Deep Injection Wells (Section 4.1.5) and exploratory well (Appendix 10.1.8). Please clarify and revise, as necessary.

SFWMD-23

- (23) Pursuant to Section 1.7.5.2 of the BOR, modeling parameters must be derived from approved aquifer performance tests (APT) or specific capacity tests located within one-mile of the proposed project (SFWMD, Part B Water Use Management System Design And Evaluation Aids, Part II Aquifer Performance Test). If the location of the nearest site where aquifer characteristics were measured is greater than one-mile, the average of the nearest three test sites is acceptable, provided that two of the three values are within one standard deviation of the mean. The parameters used for both the Surficial Aquifer modeling and the Upper and Lower Floridan Aquifer modeling do not meet this criteria. Please re-run the model for both aquifers when the appropriate parameters are obtained. Please submit a copy of the software (disk) to the SFWMD so that staff can verify the model.

SFWMD-24

- (24) The proposed Floridan Aquifer well may be withdrawing from the UFA from the same zone as that of 10 Aquifer Storage and Recovery (ASR) wells proposed as part of the future adjacent Comprehensive Everglades Restoration Plan (CERP) C-51 and Southern L-8 Reservoir Project. The 10 ASR wells are proposed to be sited along the L-8 canal, approximately 3,000' east of the project site. During extreme drought conditions, when the FPL plant will need an emergency back-up water supply source, the CERP ASR wells will be withdrawing stored water. Consequently, the proposed emergency backup Floridan well withdrawals for the power plant project are likely to adversely impact the SFWMD's ability to implement the ASR component of the proposed CERP project. Has FPL evaluated any alternatives to the UFA for the proposed emergency backup withdrawals? Potential alternative water supply sources include the Surficial Aquifer and the Lower Floridan Aquifer (LFA). In the vicinity of the project site, the lower production zone of the Surficial Aquifer is transmissive and is not being utilized to any great extent. In addition, some of the existing Surficial Aquifer wells in the vicinity associated with the rock mining activities may no longer be necessary and may be abandoned. Use of the LFA would likely require a reverse osmosis (RO) treatment plant.

Please note that water withdrawals from the L-10/L-12 canal are restricted when the water level in Lake Okeechobee drops below 11', as stated in the Upper East Coast Water Supply Plan (UECWSP). Consequently, the SFWMD will only allow the use of groundwater when the water level in Lake Okeechobee drops below 11'.

Mr. Steven Palmer, P.E.
June 13, 2005
Page 6

SFWMD-25

- (25) Prior to the initiation of any construction activities, the details of the proposed dewatering activities must be submitted for review and approval by SFWMD staff (due to resource concerns from saline connate water and off-site discharges). Submittal of a turbidity monitoring plan will also be required.

EVERGLADES WORKS OF THE DISTRICT ISSUES

SFWMD-26

- (26) The project site is located within the Everglades Agricultural Area (EAA), as defined by Rule 40E-63.104(2), F.A.C. The project site is currently part of an Everglades Works of the District (EWOD) Permit (No. 50-00062-E), issued to Palm Beach Aggregates by the SFWMD on May 13, 1993. The EWOD Permit is currently undergoing modification to add acreage from a neighboring basin. The EWOD Permit includes a Best Management Practices (BMP) Plan whose purpose is to reduce phosphorus in the runoff from a single drainage basin within the permit. The EWOD Permit also includes a Water Quality Monitoring Plan for phosphorus sampling at one water control structure that ultimately discharges off-site into the C-51 (West Palm Beach) Canal. However, this structure is currently reported to be non-operational. Consequently, flows and phosphorus loads are being reported as "zero".

Pursuant to Rule 40E-63.110(1), F.A.C., an EWOD Permit is required by lands in the EAA that release water that ultimately makes use of, connects to, is released to, or is discharged to the Works of the District within the Everglades. Should all storm water runoff be retained on-site, as indicated in the SCA, the EWOD Permit requirements will not be applicable to this project. However, if the proposed storm water management plan is modified to include any off-site discharges, a re-evaluation of the applicability of Rule 40E-63, F.A.C., will be necessary.

If you have any questions concerning the above, please give me a call at (561) 682-6862.

Sincerely,

James J. Golden, AICP
Senior Planner
Environmental Resource Regulation

/jjg

c: See Attached Distribution List

Mr. Steven Palmer, P.E.
June 13, 2005
Page 7

bc: Bob Brown
Damon Meiers
Claudia Kugler
Pam Sievers
Carmen Bedregal
Marta Edwards
Keith Smith
Jim Jackson
P.K. Sharma
Scott Burns
Tom Colios
Donna Moscone
Peter Cocotos
John Morgan
Larry Gerry
Mike Voich
Peter Kwiatkowski
Jeff Giddings
Jayantha Obeysekera
Bob Howard
Tom Fratz
Laura Lythgoe
Beverly Miller
Fred Rapach

1
2
3
4
5
6
7
8
9
10
11
12
13
14
15
16
17
18
19
20
21
22
23
24
25



Florida Department of Transportation

JEB BUSH
GOVERNOR

605 Suwannee Street
Tallahassee, FL 32399-0450

JOSÉ ABREU
SECRETARY

June 13, 2005

Mr. Hamilton S. Oven, P.E., Administrator
Siting Coordination Office
Division of Air Resources Management
Department of Environmental Protection
2600 Blair Stone Road, MS 48
Tallahassee, Florida 32399-2400

Re: Florida Power and Light West County Energy Center Power Plant Siting Application
PA No. 05-47
DEP Case No. 05-0745
DOAH Case No. 05-1493EPP

Dear Mr. Oven:

The Florida Department of Transportation has reviewed the subject application and has found the following additional transportation related information is needed:

- An engineering diagram of the access of the PBA road to State Road 80. FDOT-1
- A description with accompanying engineering diagrams of proposed improvements necessary at that intersection to assure the safety of vehicles (especially trucks) turning in and out of the site. FDOT-2
- A description with accompanying engineering diagrams of the water supply pipeline crossing of State Road 80 right of way. FDOT-3

If you have any questions, please call me at 414-5387 or Sandra Whitmire, Siting Coordinator, at 414-4812. Thank you.

Sincerely,

Sheauching Yu
Assistant General Counsel

cc: Douglas S. Roberts, Esq., Hopping, Green & Sams
Larry Hymowitz, District 4
Sandra Whitmire

www.dot.state.fl.us



1
2
3
4
5
6
7
8
9
10
11
12
13
14
15
16
17
18
19
20
21
22
23
24
25



GOLDER ASSOCIATES INC.

JUN 3 2005

GAINESVILLE

FLORIDA DEPARTMENT OF STATE
Glenda E. Hood
Secretary of State
DIVISION OF HISTORICAL RESOURCES

Mr. Kennard F. Kosky
Golder Associates, Inc.
6241 NW 23rd Street, Suite 500
Gainesville, Florida 32653-5600

May 26, 2005

RE: DHR Project File Number: 2005-4384
Received by DHR May 6, 2005
Florida Department of Environmental Protection
FPL West County Energy Center Site Certification Application
Palm Beach County

Dear Mr. Kosky:

Our office received and reviewed the referenced project in accordance with Chapters 267 and 403, *Florida Statutes*, and implementing state regulations, for possible impact to historic properties listed, or eligible for listing, in the *National Register of Historic Places (NRHP)*, or otherwise of historical, architectural or archaeological value. The State Historic Preservation Officer is to advise and assist state and federal agencies when identifying historic properties, assessing effects upon them, and considering alternatives to avoid or minimize adverse effects.

Based on the information provided, it is the opinion of this office that the proposed project will have no effect on historic properties. DHR-1

However, if fortuitous finds or unexpected discoveries, such as prehistoric or historic artifacts, including pottery or ceramics, stone tools or metal implements, or other physical remains that could be associated with Native American cultures, or early colonial or American settlement are encountered at any time within the project site area, the project should cease all activities involving subsurface disturbance in the immediate vicinity of such discoveries. The applicant, or other designee, should contact the Florida Department of State, Division of Historical Resources, Review and Compliance Section at (850) 245-6333 or (800) 847-7278, as well as the appropriate permitting agency office. Project activities should not resume without verbal and/or written authorization from the Division of Historical Resources. DHR-2

If you have any questions concerning our comments, please contact Scott Edwards, Historic Preservationist, by electronic mail sedwards@dos.state.fl.us, or at 850-245-6333 or 800-847-7278.

Sincerely,

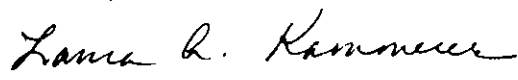
for 
Frederick P. Gaské, Director, and
State Historic Preservation Officer

500 S. Bronough Street • Tallahassee, FL 32399-0250 • <http://www.flheritage.com>

Director's Office
(850) 245-6300 • FAX: 245-6436

Archaeological Research
(850) 245-6444 • FAX: 245-6436

Historic Preservation
(850) 245-6333 • FAX: 245-6437

Historical Museums
(850) 245-6400 • FAX: 245-6433

Southeast Regional Office
(954) 467-4990 • FAX: 467-4991

Northeast Regional Office
(904) 825-5045 • FAX: 825-5044

Central Florida Regional Office
(813) 272-3843 • FAX: 272-2340

FDEP RESPONSES

1FDEP: Florida Department of Environmental Protection, Solid Waste and Tank Programs, Southeast District, Joe Lurix

1FDEP Comment: Application as submitted doesn't affect SW or tanks.

Response: The comment is correct and acknowledged.

2FDEP: Florida Department of Environmental Protection, Southeast District, Bruce Offord

2FDEP Comment 1: Have review their application as it applies to mobile source impacts and have found that they have addressed those air quality concerns. The project will generate minimum traffic impacts and will not degrade the level of service (LOS) of the impacted roadways to less than LOS "D" (page 4-16). Air quality impacts generally do not become a concern until you reach LOS "E" or "F".

Response 1: The comment is correct and acknowledged.

2FDEP Comment 2: The text states that we are in an attainment area for ozone, that should be corrected to indicate that we are in an ozone maintenance area

Response 2: Palm Beach County is part of an air quality maintenance area (AQMA) that includes Miami-Dade, Broward, and Palm Beach Counties pursuant to Rule 62-204.340(4)a.3., of the Florida Administrative Code (F.A.C.). The entire state is in compliance with the ambient air quality standards (AAQS) pursuant to Rule 62-204.340(1)(a)F.A.C. (July 1, 2005). There are no applicable AQMA requirements for the Project since pursuant to Rule 62-296.570(2) the emissions of NO_x and VOC from the Project will be more stringent than the Reasonably Available Control Technology (RACT) requirements.

2FDEP Comment 3: The text states that FDEP has not adopted the Federal one hour ozone and PM_{2.5} AAQS, it is my understanding that we had.

Response 3: The FDEP has not yet officially promulgated the 1-hour ozone and PM_{2.5} AAQS [Rule 62-204.240(2) and (4) F.A.C. July 1, 2005]. FDEP will be adopting the 1-hour ozone and PM_{2.5} AAQS and developing rules based on the finalization of regulations to be promulgated by the EPA. Monitoring data suggests that Palm Beach County will be in compliance with the proposed rules adopting the new AAQS.

3FDEP: Florida Department of Environmental Protection, Southeast District, Darrel Graziani, P.E.

(NOTE: Many of the comments in 3FDEP were similar to and included in the comments of the Bureau of Air Regulation, 5FDEP. The FDEP Bureau of Air Regulation is the administrative section that will issue the Air Construction and PSD Permit. As a result, many of the responses for 3FDEP are contained in Sufficiency Section 5FDEP and are referenced as such.)

3FDEP Comment 1: The South Florida Water Management has three pump stations in the area near the proposed site that do not appear to have been included within the inventory of existing air pollutant sources. These sources will impact both increment and NAAQS modeling. (Page 2-33).

Response 1: Please refer to the response to 5FDEP-8, which explains the sources evaluated and includes the SFWMD pump stations.

3FDEP Comment 2: The generators and fuel heaters (Page 3-8) should be subject to BACT.

Response 2: Comment acknowledged. Proposed Best Available Control Technology (BACT) for the emergency generators and fuel heaters were discussed in Subsections 4.3.7 and 4.3.8, of the Air Construction and PSD Application, respectively.

3FDEP Comment 3: The proposed BACT level of 2.5 ppmvd @15% oxygen is not consistent with recent projects.

Response 3: The proposed BACT level of 2.5 ppmvd @ 15-percent oxygen is consistent with FDEP's most recent BACT determination for this type of project. On June 13, 2005, the Progress Energy's Hines Energy Center Power Block 4 received the final BACT determination from the FDEP that limited NO_x emissions to 2.5 ppmvd corrected to 15-percent oxygen when firing natural gas for a nominal 500-MW combined cycle unit. The combustion turbines proposed for the West County Energy Center, while similar, would require even more NO_x control than the Hines Power Block 4 Project using GE Frame 7FA turbines. The GE Frame 7FB and the Siemens and MHI Frame G turbines have higher initial NO_x emissions and require greater NO_x control using SCR. Please also refer to the response for 5FDEP-3.

3FDEP Comment 4: Based on review it appears that FPL committed to impacts below 50% of the available increment Class II increments. A brief review of the modeling noted Class II consumption modeling for PM10 and only for the 24-hour averaging period. Because there may only be an insignificant amount of Class II Increment available (Sugar Mills, Pump Stations, Biomass Facilities) it doesn't appear that they demonstrated compliance with the development order. (Page 5-30)

Response 4: Please refer to the response for 5FDEP-8.

3FDEP Comment 5: Page 9 - Since they have asked for the exclusions of emissions during start-up, shutdown, and malfunction it seems appropriate that the facility be subject to an emissions cap on all pollutants subject to an emissions limiting standard.

Response 5: Please refer to the response to 5FDEP-2 and 5FDEP-11.

3FDEP Comment 6: Page 21 - They have asked for a VE limit in-lieu of PM testing. Since this is a BACT pollutant I would expect at least initial and renewal testing.

Response 6: The requested VE limit is consistent with the BACT determinations for the Martin Unit 8, Manatee Unit 3, Turkey Point Unit 5, and Hines Power Block 4. The PM emissions from the combustion turbines proposed for the Project are low (i.e., less than 0.005 lb/MMBtu). In addition, turbines have a high flow rate (>1 million acfm) and the PM loading is extremely small, making PM testing difficult and uncertain. Indeed, GE has indicated that the combustion process does not produce PM emission and any measurement of PM emissions is an artifact of the sampling and ambient air impurities. (Please refer to the GE letter contained in Appendix A of the Air Construction and PSD Application.) Given the available information, a VE limit is an appropriate BACT limit for the Project.

3FDEP Comment 7: Page 21 - They have asked for block 24 hour averages for NO_x & CO and that this excludes start-up shutdown and malfunctions. We would request that a longer averaging period (30-day rolling average) also be included within the BACT that addresses SSM. We are have significant trouble enforcing the excess emissions rule and this could answer the compliance problems. Want CEMS for CO & NO_x.

Response 7: Please refer to the response to 5FDEP-11.

3FDEP Comment 8: Page 23 - Yes to the need for a CO Monitor. Include appropriate language that annual RATA can be used as the compliance test or Method 10.

Response 8: Please refer to the response to 5FDEP-12.

3FDEP Comment 9: Page 21 - Method of Compliance should be the solid concentrations The higher the more emissions.

Response 9: While higher concentration of total dissolved solids (TDS) in the cooling tower circulating water does result in higher PM emissions, it does not produce higher PM₁₀ emissions. The high PM emissions are a result of using the secondary source of water (Upper Floridan), which will

only likely occur over a 90-day period every 5 to 10 years. PM emissions have no air quality consequence. As provided in Table 2-3 and discussed in detail in Appendix A, titled "PM and PM₁₀ Emission Rate Calculations for Cooling Tower" (refer to the Air Construction and PSD Application), the highest potential PM₁₀ emissions occur with a TDS of 4,000 ppm. The control for limiting potential emissions from the cooling tower is the design specification for limiting the drift rate. A design drift rate of 0.0005 percent has been proposed and is consistent with previous BACT determinations. Limiting TDS concentrations will not limit PM₁₀ emissions.

3FDEP Comment 10: The report addresses emission units not covered in the application (4.2 million gal tanks, aux boiler, process heater, Emergency generators) They should complete the application.

Response 10: Please refer to the response to 5FDEP-13.

3FDEP Comment 11: PSD Page 2-6 says Major HAP Source. Not addressed in the application and raises other questions regarding MACT.

Response 11: Please refer to the response to 5FDEP-14.

3FDEP Comment 12: PSD Page 2-6 Testing for Formaldehyde and the standard referenced are not addressed in the application.

Response 12: Please refer to the response to 5FDEP-15.

3FDEP Comment 13: PSD Page 2-7 Emergency Generators are MACT and should be addressed in the application and capped to avoid MACT limits.

Response 13: Please refer to the response 5FDEP-16.

3FDEP Comment 14: PSD Page 2-8 Aux Boiler is subject to a MACT of 400 PPM (CO) and it would be reasonable to think that BACT would be less. The unit is also an NSPS Unit. They are restricting heat input to 99.77 (~ 100) is this Db or Dc under NSPS? The difference is the a NOx CEMS.

Response 14: Please refer to the response to 5FDEP-17.

3FDEP Comment 15: PSD Page 2-8 Process Heaters MACT & NSPS (Dc).

Response 15: Please refer to the response to 5FDEP-18.

3FDEP Comment 16: PSD Page 2-9 Excess Emissions. They have requested NO_x limits of 2.5 and 10. And the annual emissions reported are associated with these numbers but do not include the excess emissions requested. It seems appropriate that the source accept a longterm average (30 days) that includes the excess emissions. Compliance will be easier based on my experience and less excess emissions reports.

Response 16: Please see the response to 5FDEP-11.

3FDEP Comment 17: PSD Page 3-12. They did not demonstrate compliance with the 50% PBC Criteria.

Response 17: Please see response to 5FDEP-8.

3FDEP Comment 18: PSD Pages 4-16 and 4-17. The generic exemption criteria does not apply to NSPS or MACT units. The permit needs to address the units through the requested operating restrictions. For the generators this would be hours of operation to avoid the MACT limits. For the boiler and heaters this would include the emission ~~emission~~ limits and operating restrictions.

Response 18: Please refer to the response to 5FDEP-19.

3FDEP Comment 19: VE BACT - For Gas firing is a VE necessary.

Response 19: Comment acknowledged. A VE limit has been proposed as BACT for PM. Please refer to Table 4-1 in the Air Construction and PSD Application.

4FDEP: Florida Department of Environmental Protection, Waste / Waste Cleanup Section, Southeast District, Paul A. Wierzbicki, P.G.

4FDEP Comment 1a: What environmental assessments have been conducted or will be conducted in order to determine whether soil, sediments, groundwater, or surface waters have been adversely affected (contaminated) by current or past operations? Part of the environmental assessment must include, among other things, the details of historical and current pesticide usage, identification, including detailed, scaled maps, of current and historical fertilizer and pesticide / herbicide mixing areas (if any), locations of canals and surface water bodies, locations of any above-ground, underground or temporary storage tanks, farming equipment maintenance and storage, petroleum product storage, on-site landfill / solid waste disposal areas, locations and types of any water production wells (potable, pesticide make-up, irrigation, etc.), locations and types of surface water pumps and associated fuel tanks, etc.

What soil, sediment, surface water and groundwater cleanup concentrations would be proposed? Are there monitoring wells available for sampling of groundwater? If so, does the facility sample and monitor groundwater from these wells? Please provide a list of the monitored parameters and the results from the sampling and enclose a map depicting these groundwater monitoring wells.

Response 1a: FPL contracted with Golder Associates Inc. (Golder) to conduct a Phase 1 Environmental Site Assessment of the project Site, including collection of soil samples in the vicinity of the Power Block. FPL can make this information available to the commentor for review, if requested. In summary, the Golder assessment concluded that there were no recognized environmental conditions at the Site.

Until 2004, the entire Site was owned by Palm Beach Aggregates, Inc. (PBA). The northern 100 acres of the Site was purchased by FPL in 2004 with the remaining portion of the 220 acres optioned for purchase by FPL. All organic materials and overburden soils [15 to 20 feet (ft) in total thickness] were excavated by PBA prior to the hydraulic placement of fill materials from the adjacent ponds being developed by PBA. The fill material is clean sand and shell. The Site is devoid of vegetation and is approximately 15 ft above the surrounding area.

4FDEP Comment 1b: What soil, sediment, surface water and groundwater cleanup concentrations would be proposed?

Response 1b: No conditions exist at the Site requiring cleanup; and therefore, no comparison to cleanup concentrations is necessary.

4FDEP Comment 1c: Are there monitoring wells available for sampling of groundwater? If so, does the facility sample and monitor groundwater from these wells? Please provide a list of the monitored parameters and the results from the sampling and enclose a map depicting these groundwater monitoring wells.

Response 1c: There are no monitoring wells on the project Site.

4FDEP Comment 2: Page 3-15 indicates that cooling tower blowdown along with other wastewaters will be disposed of using an UIC injection well. If not already done so, the UIC Section should review those portions for any comments they may have.

Response 2: Mr. Joe May, UIC Program Manager, Water Facilities Administration, Southeast District, received a copy of the SCA and an application for an exploratory well. FPL received comments from Mr. May on a pending application for an exploratory well. This exploratory well is being permitted separately from the SCA process to obtain information for the UIC injection well. FPL submitted a response to the comments on the exploratory well on July 12, 2005.

4FDEP Comment 3: Beginning on Page 3-13...Please be advised that hazardous waste determinations are required for wastes and most wastewaters generated in accordance with Title 40 Code of Federal Regulations (C.F.R.) Part 261, as referenced in Chapter 62-730, F.A.C. In addition to any industrial waste treatment and monitoring requirements, all waste streams must be characterized for proper hazardous waste management in accordance with 40 C.F.R. Part 261, including wastes collected in sumps, laboratory wastes and material from solids settling basins. Page 4-4 has a chart and description of waste streams. The chart and a description needs to be included that indicates which waste stream would be hazardous, whether it is based on process knowledge or will be based on analytical testing, and if hazardous, additional information regarding how the facility would manage the storage and treatment of such wastes in accordance with Chapter 62-730, F.A.C., which references portions of Title 40 C.F.R. Parts 260-271, would be required.

Response 3: Comment acknowledged. Waste and wastewater generated at the Site will be properly characterized based on process knowledge or analytical tests to ensure proper waste management and disposal. The second column of Table 3.6.0-1 includes the basis for characterization (process knowledge or analytical testing) for each waste stream.

A designated Hazardous Waste Storage Area will be created during construction. Any drums placed in the Hazardous Waste Storage Area will be properly labeled and dated. Satellite Accumulation Drum Areas may also be used at the project Site.

4FDEP Comment 4: Any land clearing or construction debris must be characterized for proper disposal. Potentially hazardous materials must be properly managed in accordance with Chapter 62-730, F.A.C. In addition, any solid wastes or other non-hazardous debris must be managed in accordance with Chapter 62-701, F.A.C.

Response 4: Comment acknowledged. There will be no land clearing debris, as the Site only contains sand and shell and is devoid of vegetation. Construction debris will be handled as described in Table 3.7.0-1 of the SCA.

4FDEP Comment 5: Petroleum and hazardous materials storage tanks and emergency generators for planned facilities must be constructed to comply with the current requirements of Chapter 62-761 and/or 62-762, F.A.C. As an example, secondary containment should be planned for all areas where petroleum or hazardous materials discharges could affect soils, sediments, surface or ground waters.

Response 5: Comment acknowledged. All hazardous materials storage tanks, including those for petroleum storage, will be constructed to comply with the requirements of Chapter 62-762, Above Ground Storage Tank Systems, including for example secondary containment and tank registrations. No tanks subject to Chapter 62-761, F.A.C. (Under Ground Storage Tanks) are planned.

4FDEP Comment 6a: A staging area, with controlled access, should be planned in order to safely store raw material paints, adhesives, fuels, solvents, etc. that will be used during construction.

Response 6a: Comment acknowledged. Materials used during construction will be stored safely. For example, flammable materials will be stored in flammable materials cabinets.

4FDEP Comment 6b: All containers need to be properly labeled.

Response 6b: Comment acknowledged. All drums and other storage containers will be properly labeled.

4FDEP Comment 6c: A staging area, with controlled access, should be planned in order to safely store raw material paints, adhesives, fuels, solvents, etc. that will be used during construction. All containers need to be properly labeled. The project developers should consider developing a written construction Contingency Plan in the event of a natural disaster, spill, fire or environmental release of hazardous materials stored / handled for the project construction.

Response 6c: Comment acknowledged. FPL will require the contractor to develop and implement an environmental control program for the construction activities at the Site that includes an environmental control plan, and appropriate Emergency Action, Oil Spill Response, Spill Prevention Control and Countermeasures, and Stormwater Pollution Prevention Plans.

4FDEP Comment 6d: Also, it should be clearly stated that in the event hazardous materials or other non-compliance issues are discovered during project construction, the Department would expect the owner/operator to promptly correct these issues.

Response 6d: Comment acknowledged. In the event that non-compliance issues arise, FPL will promptly address the issues and, when appropriate, work with the responsible parties to ensure the issues are promptly corrected.

4FDEP Comment 7: Is a meeting being planned to discuss the application with the applicant? If so, please include me in the meeting so that these concerns can be addressed.

Response 7: Comment acknowledged. A meeting is not planned, but FPL is available for a meeting at your convenience.

5FDEP: Florida Department of Environmental Protection, Bureau of Air Regulation, Southeast District, Scott M. Sheplak, P.E.

5FDEP Comment 1: The application states that FP&L is applying for the option to select from three turbine manufacturers. Has FP&L selected a turbine manufacturer?

Response 1: A turbine manufacturer has not been selected. FPL is evaluating manufacturers and will provide information to FDEP when a selection is made.

5FDEP Comment 2: Please submit air pollutant information on the "lb./hour" and "ppm" values during hot, warm and cold start-up conditions for the combustion turbines. Information directly submitted from the turbine manufacturer is preferred.

Response 2: Hot, warm, and cold startup conditions are dictated by the combined limitations of the heat recovery steam generator (HRSG), steam electric turbine, and the combustion turbine (CT). The CT, HRSG, and steam electric turbine have not been selected; but estimates of hot, warm, and cold startup conditions have been estimated based on available information from the CT manufacturers. Information from the three combustion turbine manufacturers was requested for emissions at operating conditions representing startup, independent of the steam cycle. Emissions information was received from MHI and Siemens for NO_x and CO, and from GE for NO_x. This information was used to estimate emissions for combined cycle startup conditions based on typical plant configurations for the G-Class turbine 3-on-1 configuration and the F-Class turbine 4-on-1 configuration.

During startup, emission concentrations (in ppm) from the combustion turbine increase rapidly to a peak level at or just above no load conditions, and then decrease quickly as the load on the combustion turbine is increased. For the G-Class turbines, NO_x emissions peak at approximately 55 ppm and CO emissions peak at 2,500 ppm. For the 7FB turbine, NO_x peaks at 143 ppm (CO data has not been received). Peak emissions on a lb/hr rate basis for the G Class turbines are 228 lb/hr of NO_x and 6,676 lb/hr for CO. The peak NO_x emission rate for the 7FB turbine is approximately 970 lb/hr.

Please note that combined cycle startups, especially 3-on-1 and 4-on-1 configurations, are significantly more complicated than simple cycle startups and 2-on-1 combined cycle configurations. While the peak concentration noted above would not be significantly different for each combustion turbine, the duration a turbine remains at a given load is only an estimate and may change based on the HRSG and steam electric turbine requirements, final design, and operating protocols. The

GE Frame 7FB turbine under consideration is a new version that has no combined cycle installations, nor is there a combined cycle 4-on-1 GE Frame 7FB plant in service at this time. Accordingly, the combined cycle estimates are based on startup cycle profiles that we have seen from similar GE Frame 7FA installations adjusted for the differences GE has provided for the Frame 7FB relative to the Frame 7FA. The G-Class installation in a 3-on-1 configuration has also never been constructed; although, the manufacturers have provided estimated startup timelines. The estimated emissions during startups presented below are based on the definition of a startup being from initial emissions to emissions compliance (e.g., SCR in operation).

Cold Startup, G Class: The G-Class turbine configuration would require all three turbines to set at a 20-percent CT hold point for a short period of time, corresponding to the peak emissions rates of 575 lb/hr of NO_x and 14,700 lb/hr of CO. The total startup period would be approximately 5.5 hours and emit 1,300 lb of NO_x and 32,700 lb of CO. The maximum period any CT has excess emissions is about 4.2 hours.

Cold Startup, F Class: The 7FB turbine configuration would require two turbines to fire, hold, and ramp up simultaneously, corresponding to a peak emissions rate of 1,950 lb/hr of NO_x. The total startup period would be approximately 7.5 hours and emit 9,800 lbs of NO_x. The maximum period any CT has excess emissions is about 5.3 hours.

Warm Startup, G Class: The G-Class turbine configuration allows each turbine to ramp up independently with the first turbine bringing up the STG. Accordingly, the peak emissions rates of 228 lb/hr of NO_x and 6,676 lb/hr of CO, are the same as the simple cycle numbers above (excludes emissions for turbines in compliance). The total startup period would be approximately 4.25 hours and emit 575 lb of NO_x and 16,040 lb of CO. The maximum period any CT has excess emissions is about 2.4 hours.

Warm Startup, F Class: The 7FB turbine configuration would require two turbines to fire, hold, and ramp up simultaneously, corresponding to a peak emissions rate of 1950 lb/hr of NO_x, same as a cold start (but shorter hold periods). The total startup period would be approximately 5.1 hours and emit 6,200 lb of NO_x. The maximum period any CT has excess emissions is about 3.3 hours.

Hot Startup, G Class: The G-Class turbine configuration allows each turbine to ramp up independently with the first turbine bringing up the STG. Accordingly, the peak emissions rates of

228 lb/hr of NO_x and 6,676 lb/hr of CO, are the same as the simple cycle numbers above (excludes emissions for turbines in compliance). The total startup period would be approximately 3.5 hours and emit 521 lb of NO_x and 14,200 lb of CO. The maximum period any CT has excess emissions is about 2 hours.

Hot Startup, F Class: The 7FB turbine configuration would require two turbines to fire, hold, and ramp up simultaneously, corresponding to a peak emissions rate of 1,950 lb/hr of NO_x, same as a cold or warm start (but shorter hold periods). The total startup period would be approximately 4.5 hours and emit 3,500 lb of NO_x. The maximum period any CT has excess emissions is less than 2 hours.

5FDEP Comment 3: In your best available control technology (BACT) evaluation please revise the economic analyses to provide the cost effectiveness for lowering NO_x emissions in ppm to 1.5 in the form of an updated Table 4-2. The most stringent NO_x limit nationwide for a combined cycle power plant permit is now less than 2.0 ppm averaged over a one hour period. Please note that two years ago EPA Region IX rejected a BACT proposed of 2.5 from GE7FA units (see letter dated May 2, 2003, from EPA Region IX to Ms. Nancy Wrona, Director, Air Quality Division Arizona Department of Environmental Quality) and the Department has recently determined a BACT of 2.0 ppm for the same air shed (Miami-Dade, Broward & Palm Beach counties). Table 4-2 currently shows the cost effectiveness for a NO_x ppm value of 2.5. If you are not proposing to meet the most stringent level, e.g., 1.5 ppm, then cost effectiveness should be calculated at 2.0 ppm for purposes of the analyses. For your information, the department is currently evaluating an application from the Florida Municipal Power Agency for the Treasure Coast Energy Center site in which a NO_x limit of 2.0 ppm was proposed. Please note that this proposed site near Ft. Pierce is north of the Miami-Dade, Broward & Palm Beach air shed and further from the Everglades National Park than yours. Based on available information, a BACT limit for NO_x of 2.0 ppm or lower with a one hour averaging period appears to now be technically achievable and most effective.

Response 3: The proposed best available control technology (BACT) level of 2.5 ppmvd NO_x is consistent with FDEP's most recent BACT determination for this type of project. It is FPL's understanding, that the projects referenced in the EPA Region IX letter dated May 2, 2003, were never issued PSD Permits and never constructed. Regarding FPL's Turkey Point Unit 5 Project, the NO_x limits of 2 ppmvd corrected to 15-percent O₂ when firing natural gas and 8 ppmvd corrected to 15-percent O₂ when firing ultra low-sulfur distillate oil were proposed by FPL recognizing the close proximity to the Everglades National Park. Indeed, the Department recognized this in the recent issuance of the BACT determination for the Hines Energy Center Power Block 4. In the BACT determination, the Department stated: "The FPL facility is (nearly) adjacent to the Everglades National Park (ENP), and as such, the most stringent emission limits are appropriate."

On June 13, 2005, the Department issued the final BACT determination for Hines Energy Center Power Block 4 that limited NO_x emissions to 2.5 ppmvd corrected to 15-percent O₂ when firing natural gas for a nominal 500-MW combined cycle unit. The combustion turbines proposed for the West County Energy Center, while similar, would require even more NO_x control than the Hines Power Block 4 Project in that the GE Frame 7FB and the Siemens and MHI Frame G turbines have higher initial NO_x emissions.

The BACT evaluation has been revised to include cost effectiveness for lowering NO_x emissions from 2.5 to 2.0 ppmvd corrected to 15-percent O₂. (Note: The cost-effectiveness calculations are being submitted separately to FDEP Bureau of Air Regulation with a copy to the FDEP Southeast District.) The SCR incremental cost effectiveness of lower NO_x emissions from 2.5 to 2.0 ppmvd corrected to 15-percent O₂ based on CT model is as follows:

- GE7FA - \$4,449 per ton NO_x removed
- GE7FB - \$10,225 per ton NO_x removed
- Frame G - \$20,896 per ton NO_x removed

In addition, 2.0 ppmvd corrected to 15-percent O₂ for FA, FB, and Frame G machines represent 80-, 91-, and 93-percent reduction from baseline CT emissions, respectively. Greater control efficiencies require significantly more catalyst and increase the uncertainty of compliance especially at very low NO_x levels. It should be noted that recent Hines Power Block 4 Project was issued a BACT determination of 2.5 ppmvd corrected by 15-percent O₂ for GE Frame 7FA turbines. The incremental cost effectiveness for the GE Frame 7FB and Frame G turbines are clearly higher than the GE Frame 7FA.

5FDEP Comment 4: Please explain why higher CO emission limits are proposed for the GE7FB units. These units are much like GE7FA units with greater compression and higher firing temperature. While the greater pressure and temperature account for more NO_x into the SCR system, less CO would be expected. A GE7FB unit should behave like running a GE7FA unit in a peaking mode. Please provide the economic analysis for the oxidation catalysts including the cost effectiveness in units of dollars per ton (\$/ton).

Response 4: The information provided on the CO emissions for the GE Frame 7FB combustion turbine were based on guarantees provided by GE. The GE Frame 7FB is a new combustion turbine with a lack of operating performance to establish guarantees similar to the GE Frame 7FA turbines. The economic analysis for an oxidation catalyst for the GE Frame 7FB turbine was summarized in Table 4-3 and provided in detail in Table B-20 of the Air Construction and PSD Application

(Appendix 10.1.5 of the PSD). The cost effectiveness for a CO catalyst on a GE Frame 7FB turbine was estimated to be \$3,234 per ton of CO removed.

5FDEP Comment 5: On page 2.5 of the application, it states that "for the purpose of the air quality analyses, the 22-cell cooling tower design would envelope the 24-cell design given the slightly lower exit velocity and smaller dimensions of the 24-cell tower design." In the previous sentence, it is stated that the 24-cell design has a "slight greater velocity." Does the 24-cell design have a lower or a greater exit velocity?

Response 5: As discussed on page 2-5, the 24-cell tower design has a slightly greater exit velocity for each cell (about 3.3 percent) than that for the 22-cell tower design. For the purpose of the air quality modeling analyses, the 22-cell cooling tower design, which has a lower exit velocity but the same PM and PM₁₀ emissions as those for the 24-cell tower design, would produce higher impacts than those for the 24-cell design.

5FDEP Comment 6: In the text of the application, specifically on page 6-8, it is stated that a generic emission rate of 20 g/s per second was used for this project. However, in the modeling, 3.33 g/s was used for the G-Class and 2.5 g/s for the GE 7F A. Please clarify the generic emission rate that was used in the modeling and calculations for this project.

Response 6: As indicated on page 6-8 of the PSD Report (Appendix 10.1.5), the air quality impacts due to emissions from the stacks were initially estimated using an emission rate of 79.365 pounds per hour (lb/hr) or 10 grams per second (g/s) for each power block of 1,100 MW. For the Project with a nominal 2,200-MW generating capacity, the modeled emission rate was 20 g/s, which was evenly distributed over the number of combustion turbines (CTs). For the Project with GE 7FA CTs, eight CTs are required. Therefore, each CT was modeled with an emission rate of 2.5 g/s (i.e., 20 g/s divided by 8). Similarly, for the Project with G-Class CTs, six CTs are required. Therefore, each CT was modeled with an emission rate of 3.33 g/s (i.e., 20 g/s divided by 6).

The modeling results then produced relative concentrations, referred to as generic pollutant impacts, as a function of the modeled emission rate. Maximum air quality impacts for specific pollutants were determined by multiplying the maximum pollutant-specific emission rate in lb/hr (g/s) by the maximum predicted generic impact divided by the modeled emission rate (e.g., 158.73 lb/hr (20 g/s) for 2,200 MW).

5FDEP Comment 7: Was ancillary equipment that emits PSD pollutants included in the modeling analyses?

Response 7: Yes, the mechanical draft cooling towers were included in the modeling analysis. The emergency generators, gas heaters, and start-up boilers for the G turbine were not included in the modeling analysis since these minor sources will not be operated with the CTs or operated infrequently.

5FDEP Comment 8: The following related comment regarding the land development approval was received from the Palm Beach County Local Air Program:

The Palm Beach County Local Air Program believes that the modeling should include an increment analysis for all PSD pollutants, regardless of whether the predicted impacts are above or below the Class II Significant Impact Level. The County does not believe that the increment consumption commitment can be made without determining the amount of available increment in the Class II area for each pollutant. Please clarify the commitment and confirm the modeling requirements (including the source inventory) with Palm Beach County.

Response 8: The Palm Beach County Health Department (PBCHD) has requested that Prevention of Significant Deterioration (PSD) Class II increment consumption analysis be conducted for all applicable pollutants and averaging times to meet the Palm Beach County Land Development Approval Requirement that the available PSD increment consumption will be limited to 50 percent including impacts from all sources. The condition states:

“Upon submittal of an air permit application to the FDEP; the property owner(s) shall submit to PBCHD a multi-source NAAQS and Class II PSD increment analysis for criteria pollutant, for the entire project at build out. The increment analyses shall include all the contributions from other sources significantly impacting the site if the predicted increase in impacts for these pollutants is above the significant impact level for a Class II established by EPA. Approval for this project is contingent upon predicted impacts from the multi-source Class II increment analysis demonstrating consumption of no more than 50 percent of the available increment (total aggregate from all sources). This condition shall be included in the air permit application to FDEP. The applicant shall seek further approval from the ULDC and the Board of County Commissioners if a higher percent of the increment is consumed.”

For the West County Energy Center, the maximum air quality impacts were presented in the SCA (see SCA Chapter 5 and Appendix 10.1.5, PSD Report) and were predicted to be less than the

significant impact levels as defined by the U.S. Environmental Protection Agency (EPA) and FDEP for all pollutants and averaging periods except for PM₁₀ for the 24-hour averaging period. As a result, cumulative source impact analyses were required to demonstrate compliance with the 24-hour average PM₁₀ AAQS and PSD Class II Increments. These analyses showed that the maximum 24-hour average PM₁₀ concentrations were less than 50 percent of the available PSD Class II increment.

Based on comments made by the PBCHD, additional cumulative impact analyses have been conducted for PM₁₀ (annual averaging period), sulfur dioxide (SO₂) (3-hour, 24-hour and annual averaging period), and nitrogen dioxide (NO₂) (annual averaging period) to demonstrate that the available PSD increment consumption will be limited to 50 percent even though the air quality impacts of these pollutants for the project are below the significant impact levels.

The air modeling approach used for these analyses was the same as that presented in the Air Permit and PSD Application (SCA Appendix 10.1.5) to address the compliance with the 24-hour average PM₁₀ PSD Class II increment. Concentrations were predicted using the ISCST3 dispersion model (Version 02035) and 5 years of hourly surface weather observations and twice-daily upper air soundings from the National Weather Service (NWS) office located at the at the Palm Beach International (PBI) Airport from 1987 through 1991.

Separate modeling analyses were performed for the GE Frame 7F Class CTs and the Frame G-Class CTs for the proposed project (nominal capacity of 2,200 MW and ultimate site capacity of 3,300 MW). In an effort to obtain the maximum PM₁₀ (annual average), SO₂, and NO₂ impacts in these PSD Class II increment consumption analyses, the operating condition for the project which produced the maximum impacts for each pollutant identified in Appendix 10.1.5 of the SCA (refer to Tables 6-6, 6-7, 6-13, 6-14) was used in the cumulative impact modeling. As a result, the following operating cases were selected:

1. GE Frame 7F Class CTs

- 2,200 MW
 - PM₁₀ (annual average): Natural Gas-firing, 60% Load, 59°F air inlet temperature;
 - SO₂: Natural Gas-firing, 100% Load, 95°F air inlet temperature; and
 - NO₂: Oil-firing, 60% Load, 59°F air inlet temperature.

- 3,300 MW
 - PM₁₀ (annual average): Natural Gas-firing, 60% Load, 59°F air inlet temperature;
 - SO₂: Natural Gas-firing, 100% Load, 95°F air inlet temperature; and
 - NO₂: Oil-firing, 60% Load, 59°F air inlet temperature.
- 2. Frame G Class CTs
 - 2,200 MW
 - PM₁₀ (annual average): Oil-firing, 75% Load, 59°F air inlet temperature;
 - SO₂: Natural Gas-firing, 100% Load, 95°F air inlet temperature; and
 - NO₂: Oil-firing, 75% Load, 59°F air inlet temperature.
 - 3,300 MW
 - PM₁₀ (annual average): Oil-firing, 75% Load, 59°F air inlet temperature;
 - SO₂: Natural Gas-firing, 100% Load, 95°F air inlet temperature; and
 - NO₂: Oil-firing, 75% Load, 59°F air inlet temperature.

Since the annual average PM₁₀ impacts as well as the SO₂ and NO₂ impacts from the Project were predicted to be less than the significant impact levels, a significant impact area (SIA) and the radius of SIA are not applicable. For the purpose of this study, a modeling area was assumed to extend out to 10 kilometers (km), which is the maximum distance at which the Project's impacts were determined to be significant for the PM₁₀ concentrations for the 24-hour averaging period.

Facilities located within the 10-km modeling area were modeled explicitly. Facilities located within the modeling area plus 50 km were considered to be in the screening area. Each facility in the screening area was evaluated using the "North Carolina screening technique" to determine whether the facility would be included in the modeling. Based on this technique, facilities whose annual emissions (i.e., tons per year) are less than the threshold quantity, Q, are eliminated from the modeling analysis. Q is equal to 20 x (D-RMA), where D is the distance, in km, from the facility to the project site and RMA is the radius of the modeling area or 10 km.

Background SO₂ and NO_x sources used in the PSD Class II analyses were obtained from FDEP and were supplemented with current and available historical information. The PBCDH was contacted to obtain information regarding the SFWMD pump stations and the Hubbard Construction Company in Palm Beach County. The PM₁₀ source inventory included in Appendix 10.1.5 of the SCA was also supplemented with information obtained from the PBCHD and included in the analysis.

The receptor grid used in the modeling analyses extended beyond the property out to 10 km. Receptors were located at the following intervals and distances from the origin:

- Every 100 meters (m) from the plant property to 2,000 m;
- Every 250 m from 2,250 m to 3,000 m; and
- Every 500 m from 3,500 m to 10,000 m.

The results of the modeling determined that maximum PM₁₀, SO₂, and NO_x concentrations due to the proposed 2,200- and 3,300-MW Project and other PSD increment-affecting sources are less than 37 percent of the allowable increment levels. The results indicate that the Project (2,200 MW) as well as the ultimate capacity (3,300 MW) will meet the requirements of the Palm Beach County Land Development Approval that limits the PSD Class II increment consumption to no more than 50 percent of the available increment (total aggregate from all sources). The supporting technical tables for the modeling analysis are being submitted separately to the FDEP Bureau of Air Regulation with copies to the FDEP Southeast District and PBCHD.

5FDEP Comment 9: The generators and fuel heaters described in the applications are not exempt from permitting since the project is subject to PSD review and the units are avoiding MACT requirements. The selected units should meet BACT limits and the operating restrictions detailed in the application will need to be incorporated in the permit. Please revise the PSD application and include the appropriate information for each unit.

Response 9: : The generators and fuel heaters described in the application are not exempt from permitting since the project is subject to PSD review and the units are not subject to MACT requirements. Therefore, the applicable portion of the application forms have been completed to include these units. These portions of the application forms are being submitted separately to the FDEP Bureau of Air Regulation with a copy to the FDEP Southeast District.

5FDEP Comment 10: On page 20 of the PSD application form "yes" has been checked that the pollutants are synthetically limited. The pollutants that are subject to BACT are not synthetically limited. Please revise the application form as needed and submit updated pages.

Response 10: Pursuant to FDEP Form No. 62-210.900(1) – Instructions, applicants are required to check yes “if the potential emissions of the pollutant addressed in Field 1 are limited by virtue of a federally enforceable restriction, assumed by the applicant, on hours of operation or on the type of material combusted...”. For the proposed Project, a federally enforceable restriction has been required for oil firing of 500 hours per year. This limits the potential emissions of the Project. It

appears that checking "yes" is correct based on the Department's instructions. Please indicate if this is not correct and the forms will be provided.

5FDEP Comment 11: On page 21 of the PSD application it is stated that the 24-hour block averages for NOx & CO emissions, exclude start-up, shutdown and malfunctions (SSM). The Department may consider a longer averaging period, e.g., 30-day rolling average within the BACT that addresses SSM. Please include such an average within the BACT evaluation.

Response 11: FPL has proposed block 24-hour averages for continuous compliance when the units are within the operating range. An excess emissions condition for periods of cold start-up of the steam turbine and CT/HRSG systems, as well as shutdown, has been proposed. The 24-hour block average and excess emission condition have been acceptable to FDEP for the Martin Unit 8, Manatee Unit 3, and Turkey Point Unit 5 Projects. A 30-day rolling average limitation is not practical as it is uncertain during any 30-day period if conditions exist where excess emissions occur due to a startup or shutdown. The number of unit startups per year will vary depending on unit dispatching maintenance requirements, forced outages, and other system factors. However, the units are expected to operate as baseload units and, as such, will have limited startups and shutdowns. Typical maintenance requirements would consist of about one cold startup/shutdown per year.

In addition, it is also not practical to propose a BACT limit that includes startup and shutdown. During such conditions, excess emissions are a result of either not having the proper operating temperature to operate the SCR or a function of the combustion turbine operating conditions. These conditions are controlled by automated systems and outside the operating parameters of the control systems (i.e., SCR or combustion). However, emissions during startups and shutdowns will be minimized based on operating practices and manufacturer recommendations. The startup and shutdown sequences are controlled through the digital control systems (DCS) to ensure that equipment is not damaged as a result of thermal stress, while minimizing emissions.

5FDEP Comment 12: On page 23 please note that the Department is considering the need for a CO monitor.

Response 12: Comment acknowledged. A CO continuous emissions monitor was anticipated and included in the requested CO emission limits proposed as BACT. Please refer to Table 4-1 in the Air Construction and PSD Application (Appendix 10.1.5 of the SCA), which indicated the use of a CO CEM for continuous compliance (24-hour block average).

5FDEP Comment 13: The PSD report addresses emissions units not covered in the application, e.g., 4.2 million gallon tanks, auxiliary boiler, process heater, emergency generators, etc. Please revise the application form to include these units.

Response 13: Appropriate portions of the FDEP application form for the auxiliary boiler, process heater, and emergency generators are being submitted separately to the FDEP Bureau of Air Regulation with a copy to the FDEP Southeast District. The 4.2-million-gallon diesel fuel tanks are insignificant sources and not subject to NSPS requirements and, as such, application forms are not submitted. The tanks will be included in the initial Title V application as insignificant emission units. Previous projects (e.g., Martin Unit 8 and Turkey Point Unit 5) were handled in this manner.

5FDEP Comment 14: The PSD report, page 2-6, states that the facility is a Major HAP Source. This is not addressed in the application and raises other questions regarding MACT applicability. Please re-address the HAP emissions and MACT requirements within the application form. If a case-by-case MACT determination is required, please include a MACT evaluation.

Response 14: The MACT standard in 40 CFR, Subpart YYYY, is potentially applicable to the West County Energy Center. The West County Energy Center will be a major source of HAP emissions since emissions are projected to exceed 10 tons per year (TPY) of a single HAP and exceed 25 TPY for all HAPs. Since ultra low-sulfur light oil is proposed to be fired in each CT for up to 500 hr/yr, the proposed CTs are defined as "stationary diffusion flame oil-fired combustion turbines" under the Subpart YYYY requirements and would have the potential for an aggregate total potential of 1,000 hours of oil firing during any calendar year. Actual applicability of Subpart YYYY is based on actual oil fuel used in a calendar year. The proposed West County Energy Center will be required to demonstrate compliance with the combustion turbine MACT of 91-ppbvd formaldehyde corrected to 15-percent O₂ if the aggregate 1,000 hr/yr is exceeded (40 CFR Part 63, Section 63.6120, Table 3).

The application forms have been updated to include the requirements of 40 CFR 63 Subpart YYYY and are being submitted separately to FDEP Bureau of Air Regulation with a copy to the FDEP Southeast District.

5FDEP Comment 15: The PSD report page 2-6 references testing for formaldehyde and the MACT standard. Please revise the application form to reflect the standard and the test requirements.

Response 15: Formaldehyde testing, per 40 CFR 63 Subpart YYYY, has been added to the application form for the CTs (see response to 5FDEP-14).

5FDEP Comment 16: The PSD report, page 2-7 implies that the emergency generators are exempt from the MACT based on operating limitations. Please include these limitations within the permit application if you want to escape the MACT requirements.

Response 16: Appropriate portions of the FDEP application form for the emergency generator, including operating limitations, have been added to the application (see response for 5FDEP-13).

5FDEP Comment 17: The PSD report, page 2-8, implies that the auxiliary boiler is subject to a MACT of 400 ppm for CO and it would be reasonable to think that BACT would be less. The unit is also an NSPS Unit and it appears that you are requesting a federally enforceable operating limit of 99.77 mmBtu/hr for purposes of avoiding the requirements of 40 CFR Part 60, Subpart Db. Within the revised application form please clarify the intent and the request.

Response 17: If the facility is determined to be a major source of HAPs based on actual emissions (see 5FDEP-14 Response), then the auxiliary boiler will be subject to a MACT limit of 400 ppm for CO as a "limited use gaseous fuel" unit. The proposed auxiliary boiler is estimated to have a CO concentration of 251 ppmvd, which is well below the MACT standard. A limit of 99.77 MMBtu/hr is being requested to avoid the requirements of 40 CFR Part 60, Subpart Db. The appropriate portions of the application form for the auxiliary boiler have been added to the application (see response for 5FDEP-13).

5FDEP Comment 18: The PSD report, page 2-8 implies that the process heaters exempt from the MACT based on operating limitations. Please include these limitations within the permit application if you want to escape the MACT requirements.

Response 18: The Project will include two 10-MMBtu/hr indirect process heaters for the purpose of heating the natural gas supply to the CTs. If the facility is determined to be a major source of HAPs, based on actual emissions (see 5FDEP-14 Response), then the heaters will be subject to 40 CFR 63, Subpart DDDDD. The natural gas heater is defined as a small gaseous fuel unit and is not subject to the initial notification or any requirements of the Subpart DDDDD pursuant to 40 CFR 63.7506(c). In addition, there are no alternative controls for these small combustion units (i.e., 10 MMBtu/hr or less). The appropriate portions of the application form for the process heaters have been added to the application (see response for 5FDEP-13).

5FDEP Comment 19: The PSD report, pages 4-16 and 4-17, implies that the generic exemption criteria applies to several of the units discussed above. Please note that the exemptions do not apply to units subject to BACT, NSPS or NESHAP requirements. Please revise the application form to address the units and any requested operating restrictions. For the generators this would be hours of operation

to avoid the MACT limits. For the boiler and heaters this would include the emission limits and operating restrictions.

Response 19: Comment acknowledged. Appropriate portions of the FDEP application form for the auxiliary boiler, process heater, and emergency generators have been added to the application (see response for 5FDEP-13).

5FDEP Comment 20: Please document consultation to-date with the EPA, the Federal Land Manager, and the U.S. Fish and Wildlife Service regarding any applicable provisions of the Endangered Species Act. We encourage your early contact with these agencies.

Response 20: FDEP acknowledged in its preliminary determination of the PSD permit for the FPL Turkey Point Project that state PSD permits are not generally reviewed for adherence with the federal Endangered Species Act. However, FPL's SCA and the Air Construction and PSD Permit Application discuss the presence and impacts to wildlife, including endangered species, from the West County Energy Center. The Site itself consists solely of cleared lands following mining reclamation with no suitable onsite wildlife habitat. Indeed, the ecological surveys of the Site determined that there were no threatened or endangered species on the Site. Subsections 2.3.5 and 2.3.6 of the SCA address the presence of vegetation and wildlife in the vicinity of the Site and document the presence of wildlife in the Site vicinity. SCA Subsection 4.4 5.1 and Section 5.8 address impacts to wildlife from project construction and operation, with the bottom line conclusion that the Project will have no adverse impacts to wildlife, including endangered species. The Air Construction and PSD Permit Application also demonstrates the Project will comply with all applicable AAQS, which were established in part to protect public welfare including wildlife. Sections 7.2 and 7.3 of the PSD Permit report contain the analysis showing the Project's air emissions will not have any adverse effect on wildlife at or near the Project Site, including within the nearest PSD Class I area.

The air quality impacts from the emissions of the West County Energy Center have been shown to have no adverse effect to vegetation or wildlife, including endangered species in the vicinity of the Site. Preparation of the SCA and PSD permit application involved review of wildlife and endangered species information collected in the field and from public sources including the Florida Natural Areas Inventory, FCREPA reports, and other sources. Staff of the Florida Fish and Wildlife Conservation Commission have also been consulted. To date, no direct contact has been made with EPA, USFWS, or the Federal Land Manager on this subject; but FPL understands copies of its Air Construction and

5FDEP Comment 21: We did not receive any comments from the National Park Service or EPA Region 4. We will pass these on if and when received. Either agency might submit comments during the sufficiency review or during the normal comment period.

Response 21: Comment acknowledged. FPL will address comments when they are received.

SFWMD RESPONSES

SFWMD: South Florida Water Management District, Environmental Resource Regulation, James J. Golden, AICP

SFWMD Comment 1: The sketches provided need to be supported with recent aerial photography of the proposed site.

Response 1: Attachment SFWMD-1 provides an aerial photograph of the Site showing the proposed inlet structure located on the north bank of the L12 Canal.

SFWMD Comment 2: The drawings must show the SFWMD right-of-way lines on both the plan and profile view.

Response 2: Attachment SFWMD-2 provides the survey and drawings requested. The survey was developed using information obtained from SFWMD on the legal description for the SFWMD right-of-way for the L12 Canal. FPL hired a surveyor to place the legal description on the drawings requested in the comment. When the legal description was surveyed, there was a misalignment. A drawing of State Road 80 right-of-way was obtained from the Florida Department of Transportation (FDOT). The right-of-way for the L12 Canal was then plotted on the FPL-generated drawings in Attachment SFWMD-2. SFWMD needs to verify the L12 Canal right-of-way. Please note that the inlet structure located on the north bank of L12 Canal and shown in the drawings contained in Attachment SFWMD-2 is proposed for the Project. The intake structure on the south bank of the L12 Canal will not be used for the Project as described in the responses to SFWMD-5 through SFWMD-14.

SFWMD Comment 3: The proposed design must employ rip-rap or alternative erosion control measures on canal side-slopes acceptable to the SFWMD.

Response 3: Comment acknowledged. The design will employ rip-rap or other alternative erosion control measures acceptable to the SFWMD. FPL will provide design details when finalized.

SFWMD Comment 4: Any temporary construction related activities or techniques need to be covered in the proposal as well as a sequence of work, a time schedule, and an analysis of headloss in the channel due to constrictions imposed by temporary structures (particularly if sheet piling or coffer dams extending into the channel are proposed).

Response 4: Comment acknowledged. Details of construction activities and techniques will be provided after a contractor/engineer is retained and a design detail developed.

Comments Applicable to Figure 3.5.0-1 (Nos. 5 through 14)

SFWMD Comment 5: The sketches need to be drawn to scale or have all dimensions shown.

Response 5: The intake option shown in Figure 3.5.0-1 will not be used and the information requested will no longer apply.

SFWMD Comment 6: The drawings need to depict the subaqueous water lines which run from the southerly intake structure under the canal northerly on Section A-A.

Response 6: The intake option shown in Figure 3.5.0-1 will not be used and the information requested will no longer apply.

SFWMD Comment 7: For subaqueous crossings, it will be necessary to submit an existing certified canal cross-section at the centerline of the proposed crossing. Soundings should be taken at 10' intervals from top of bank to top of bank and be plotted on standard cross-section paper, using NGVD as datum and the same horizontal and vertical scale (preferably 1"=10'). The drawings must be signed and sealed by a Florida-registered professional engineer. The cross-sections shall have superimposed upon them the design section for the canal. Available information for this site indicates that the canal design section for this location consists of a 20' bottom width at (-)19.2 bottom elevation with 1 vertical on 2 horizontal sideslopes.

Response 7: The intake option shown in Figure 3.5.0-1 will not be used and the information requested will no longer apply.

SFWMD Comment 8: The subaqueous installation must be set a minimum of 2' below the canal design section or existing section, whichever produces the lowest installation.

Response 8: The intake option shown in Figure 3.5.0-1 will not be used and the information requested will no longer apply.

SFWMD Comment 9: The portion of the proposed crossing that is buried within the right-of-way and sideslopes must be buried a minimum of 36" below the existing ground.

Response 9: The intake option shown in Figure 3.5.0-1 will not be used and the information requested will no longer apply.

SFWMD Comment 10: If any security fencing is proposed, it must be included in the drawing.

Response 10: The intake option shown in Figure 3.5.0-1 will not be used and the information requested will no longer apply.

SFWMD Comment 11: Any electrical service to the pump station must be shown.

Response 11: The intake option shown in Figure 3.5.0-1 will not be used and the information requested will no longer apply.

SFWMD Comment 12: If a stand-by generator is proposed at the site, the details of the fuel containment enclosure need to be added to the drawing.

Response 12: The intake option shown in Figure 3.5.0-1 will not be used and the information requested will no longer apply.

SFWMD Comment 13: It appears that access along the SFWMD's southerly right-of-way is proposed for future operation and maintenance of the pump station. If so, the following information must be provided.

- (a) An 8-1/2" X 11" drawing that is either drawn to scale or fully-dimensioned that depicts the following:
 - (1) The SFWMD right-of-way lines;
 - (2) The location of the access route tied into a well-known landmark(s); and
 - (3) The precise location of ingress and egress.
- (b) A narrative addressing:
 - (1) The length and time that the proposed use of the right-of-way is being requested;
 - (2) Other alternate routes that are available and an explanation as to why they cannot be used;
 - (3) The type and size of vehicles proposed to be used within the right-of-way and frequency (round trips per day) that each type of vehicle would be using the right-of-way;
 - (4) Posting of financial insurance in the form of a bond or other surety in an amount satisfactory to the SFWMD; and
 - (5) Providing the SFWMD with a Certificate of Insurance to the limits and amounts specified by the SFWMD.

As a point of information, the SFWMD will allow temporary access for construction. However, the SFWMD does not grant permanent access along its rights-of-way. Consequently, if the SFWMD was to grant access along the right-of-way, it will be necessary for FPL to periodically request an extension of the expiration date. Please note that the SFWMD does not guarantee this request will be approved.

Response 13: The intake option shown in Figure 3.5.0-1 will not be used and the information requested will no longer apply.

SFWMD Comment 14: SFWMD criteria does not allow for the construction of permanent pumping facilities within the canal right-of-way (please refer to Section H "Pump Connections" on page 105 of the SFWMD's Basis of Review/Criteria Manual).

Response 14: The intake option shown in Figure 3.5.0-1 will not be used and the information requested will no longer apply.

Comments Applicable to Figure 3.5.0-2 (Nos. 15 through 16)

SFWMD Comment 15: The drawings need to depict the invert elevation of the proposed 8-36" pipes, ground elevations, etc.

Response 15: Refer to Attachment SFWMD 2, which presents drawings showing the invert elevations of the inlet pipes.

SFWMD Comment 16: In order to prevent the discharge of aquatic weeds into the SFWMD's canal system, all culverts 36" in diameter or larger must be equipped with a skimmer or baffle which effectively precludes the discharge of aquatic weeds into the SFWMD's canal system. The skimmer or baffle must be designed to be effective through a range of water surface conditions.

Response 16: The inlet structure will only be used to withdraw water from the canal. No discharge will be made through the inlet structure to the canal system. A skimmer or baffle will not be necessary.

CONSUMPTIVE USE ISSUES

SFWMD Comment 17: In Section 3.0 of the SCA, the demand from the L-10/L-12 canal for the cooling towers and process water is shown on the water mass balance chart as 15.20 million gallons per day (MGD) with the maximum demand as 19.5 MGD. When water from the Upper Floridan Aquifer (UFA) is used as an emergency supply, the total average demand is 15.24 MGD and the maximum demand is 19.48 MGD. Please clarify and revise, as necessary.

Response 17: The difference between the numbers is due to truncation/round off when converting from gallons per minute (gpm) to million gallons per day (MGD). Also, note 4 in Figure 3.5.0-4 should read "Flows are based on 6 cycles of concentration in CT." Replacement pages for these figures are included as Attachment SFWMD-17.

SFWMD Comment 18: Please submit a water conservation plan, pursuant to Section 2.4.1 of the Basis of Review (BOR) for Water Use Permit Applications.

Response 18: The water conservation plan components, pursuant to Section 2.4.1 of the Basis of Review (BOR) document, are discussed in Section 2.0 of the Water Supply Alternatives Analysis (SCA Appendix 10.8). This section discusses water conservation design measures, leak detection and repair procedures, employee awareness programs and the time frames for implementation. This application is for a new permit. Section 2.4.1A of the BOR states that for new permittees, the water audit is not required until 2 years after the permit is issued. An updated water conservation plan will be submitted as a post-certification condition.

SFWMD Comment 19: Pursuant to Section 2.2.1 of the BOR, the applicant must demonstrate legal control over the project site. Pursuant to Section 2.1.2 of the BOR, the applicant must demonstrate legal control over the proposed facilities. Please submit the appropriate documentation.

Response 19: FPL purchased the northern 100 acres of Site (see Attachment SFWMD 19). This parcel of land identified as Parcel A in Figure 2.1.6-1a of the SCA will contain the two 1,100 MW units proposed as the Project. The remaining 120 acres are under option (see Attachment SFWMD 19) and will be purchased as Parcels B and C shown in Figures 2.1.6-1b and 2.1.6-1c of the SCA.

SFWMD Comment 20: In Section 2.0 of the SCA, potable water supply wells are shown on Figure 2.3.3-1. In Appendix 10.1.8, Figure 6 shows the location of other Surficial Aquifer Wells. Other wells that do exist, some of which are located on adjacent Palm Beach Aggregates property, are not shown and were not included in the modeling. Please submit revised modeling that includes these wells.

Response 20: The well information shown in Figure 2.3.3-1 of the SCA, while labeled potable water supply wells, included all wells obtained from the SFWMD's DBHYDRO database. These wells are used primarily for monitoring; the figure title should not have referred to potable wells. Table 2.3.3-2 in the SCA provides a listing of all water use permits within 5 miles of the Site including wells located on Palm Beach Aggregates property. The information in this table was obtained from the SFWMD, and it includes all water use designations and all water sources (surface water and groundwater). No existing water use permit with 5 miles of the Site designates the Upper Floridan aquifer as the source. Table 2.3.3-2 provides a location reference to the section, township, and range. Therefore, the public land survey system (PLSS) grid was included in Figure 2.3.3-1 for reference. Figure 6 in Appendix 10.1.8 of the SCA shows all surficial aquifer monitoring and supply wells within the UIC Program area of review. Figure 6 has been updated to provide reference to the well inventory contained in Table 3 of Appendix 10.1.8 of the SCA (Table 3 and the updated Figure 6 are presented in Attachment SFWMD-20). The information provided in Figure 6 and Table 3 was

obtained from the SFWMD's DBHYDRO database and the SFWMD's regulatory database. The water supply wells shown in this figure include the wells on the adjacent Palm Beach Aggregates property, which are also included in Table 2.3.3-2 of the SCA.

The wells on the Palm Beach Aggregates property were not included in the surficial aquifer modeling, because they are outside the cone of depression defined by the 0.1-foot (ft) drawdown contour for the proposed withdrawal from the water table aquifer (see SFWMD BOR document Section 1.7.5.2, page 25). The location of the WCEC surficial aquifer supply well is shown on Figure 3.2.0-3 (Item 28, "potable supply well") in Section 3 of the SCA. Table 5 in Appendix 10.7 of the SCA shows that the maximum radial distance to the 0.1-ft drawdown is 1,350 ft (pumping 35,000 gpd, lowest K = 10 ft/day, 90-day transient simulation with no surface recharge). The nearest well on the Palm Beach Aggregates property is approximately ½ mile (2,640 ft) from the WCEC surficial aquifer supply well. These wells were not included in the Floridan aquifer modeling because there is no significant interaction between the surficial aquifer and the Upper Floridan aquifer.

SFWMD Comment 21: Monitoring, irrigation, and public water supply wells are located on property that is proposed for the plant site. If these wells are not going to be used for the proposed project, they must be properly plugged and abandoned, pursuant to Rule 40E-3.531, F.A.C.

Response 21: Table 3 and Figure 6 (included in the SCA) were revised to include cross references between the Figure and the Table and are included in Attachment SFWMD-20.

FPL received the SFWMD figure labeled "Site Map" and the SFWMD figure labeled "Wells" showing Palm Beach Aggregates (PBA) groundwater wells and has enclosed those with this response as Attachment SFWMD-21.

FPL has confirmed, through review of the Site Map and Well information provided by SFWMD and coordinates information in Table 3 (see Attachment SFWMD-20) that there are no wells on the Site. The most westerly well (depicted on Figure 6 in Attachment SFWMD-20) is identified as PBA W-2 on the figure labeled "Site Map" in Attachment SFWMD-21 and as 50-06150-W in Table 3 and on the figure labeled "Wells" in Attachment SFWMD-21. Due to scaling and minor shifts in latitude and longitude plotting, it may appear that these wells are on the FPL property. However, based on plotting of the coordinates obtained from SFWMD and listed in Table 3 (see Attachment SFWMD-20), this well is located on the PBA haul road and is east of the FPL property boundary. The location of this well has also been confirmed through discussions with PBA consultants. There

are no monitoring, irrigation, or public water supply wells located on the Site. Also please refer to the response for SFWMD-20.

SFWMD Comment 22: Page 2 of Appendix 10.1.8 states that the proposed exploratory well will be converted into a Floridan Aquifer system dual-zone monitoring well for the four proposed Deep Injection Wells (DIW) in the Boulder Zone. Page 7 of the SCA states that there will be at least three dual-zone monitoring wells to fulfill the spatial requirements between injection wells, in accordance with Rule 62-528.425(1)(g)(4), F.A.C. The SCA proposes to use Upper Floridan Aquifer (UFA) wells as emergency back-up water supply wells when extreme drought precludes the use of surface water from L-10/L-12 canal. The intervals for the monitoring zones (pages 7 and 16) of the dual-zone monitoring wells are described at approximately 1,950 feet bls, or just above the base of the Underground Source of Drinking Water (USDW), and between 2,000 and 2200 feet bls, or in the first transmissive zone below the USDW, as determined by the exploratory well. These intervals are in the Lower Floridan Aquifer (LFA). In the Modeling Section (Appendix 10.7), the SCA states that water from the LFA is not suitable due to high chlorides. However, modeling to determine impacts of the emergency withdrawals was done for the UFA, between 750 and 1350 feet bls and for LFA PZ-1 between 1500 and 1650 bls. The site map for the facility (Chapter 3, Sheet 3) does not show any UFA well sites. The proposed UFA wells are not described in the construction details, which only describe the drilling and testing of the Deep Injection Wells (Section 4.1.5) and exploratory well (Appendix 10.1.8). Please clarify and revise, as necessary.

Response 22: The exploratory well will be converted to a dual-zone monitoring well to provide monitoring for the northern most DIW. Other monitoring wells are proposed for subsequent DIWs and identified as I.D. Number 34, Monitor Wells, as shown on Figure 3.2.0-4 of the SCA.

The modeling did not assume withdrawals from the LFA PZ-1 between 1,500 and 1,650 ft-bgs. Model Layer 3 (LFA PZ-1) was represented in the model as a source bed with leakance; not as a production zone. As discussed in the Groundwater Modeling Analysis (SCA Appendix 10.7, bottom of page 3), all withdrawals were from the UFA (Model Layer 2).

Upper Floridan Aquifer (UFA) wells are identified in Chapter 3, Figure 3.2.0-4, Plot Plan. These are I.D Number 31, Groundwater Wells, Backup Production Wells. The most northerly UFA well is located just south of I.D. Number 35, Exploratory/Dual Zone Monitoring Well (immediately south of the large stormwater pond-I.D. Number 27), adjacent to the proposed I.D. Number 19, Underground Injection Well(s), 1-unit capacity. Another Groundwater Backup Production Well is located approximately 2,000 ft due south.

The construction details for the UFA have not been finalized. The design will be finalized after a production test (see response to Comment SFWMD-23). A typical design for the UFA for backup water supply production wells is provided in Attachment SFWMD-22.

SFWMD Comment 23: Pursuant to Section 1.7.5.2 of the BOR, modeling parameters must be derived from approved aquifer performance tests (APT) or specific capacity tests located within one-mile of the proposed project (SFWMD, Part B Water Use Management System Design and Evaluation Aids, Part II Aquifer Performance Test). If the location of the nearest Site where aquifer characteristics were measured is greater than one-mile, the average of the nearest three test Sites is acceptable, provided that two of the three values are within one standard deviation of the mean. The parameters used for both the Surficial Aquifer modeling and the Upper and Lower Floridan Aquifer modeling do not meet this criteria. Please re-run the model for both aquifers when the appropriate parameters are obtained. Please submit a copy of the software (disk) to the SFWMD so that staff can verify the model.

Response 23: Section 1.7.5.2 of the BOR also states that "The use of numeric models such as Modflow without calibration is acceptable under the following configurations: (1) the model represents the aquifer or aquifer system as no more than two layers; (2) each layer uses a single value for transmissivity/permeability and storage/storativity, and a single value is used for leakance between the layers; (3) the simulation time is 90 days with no recharge; and (4) surface water features are not represented. The modeling will include separate runs using the highest and lowest measured values of transmissivity/permeability, storage/storativity, and leakance from the region, **based on published data and** [emphasis added] pump test values calculated as described above. The selected high and low aquifer values will be approved provided they significantly overestimate the withdrawal impacts that would occur on the Site."

The transient surficial aquifer model discussed in Attachment 10.7 of the SCA meets all four conditions listed above. To estimate the range of aquifer hydraulic conductivity, the surficial aquifer modeling used published data from: 1) the USGS, 2) previous modeling studies conducted by the District, **and** 3) Site-specific slug-test data. The published data and the Site-specific results were consistent; and the modeling results included separate runs using high and low aquifer values (please refer to Appendix 10.7, page 2 for references used to perform the modeling analyses). Furthermore, comparing the steady-state model results to the transient model results, one can see clearly that the transient model, which does not include surface water boundary features that confine the cone of depression, significantly overestimates the offsite drawdowns that would occur. The applicant believes the aquifer parameters used were appropriate for evaluating the potential impacts to the surficial aquifer system and consistent with the SFWMD requirements for such modeling.

The Floridan aquifer model presented in Appendix 10.7 of the SCA also used published data and previous modeling studies to establish a range of values for the aquifer parameters (Table 1); and the modeling results included 11 separate runs using high, medium, and low parameter values (i.e., the results included a sensitivity evaluation, Table 2). (Please refer to Appendix 10.7, page 2 for

references used to perform the modeling analyses.) While the model was not configured exactly as specified in the BOR due to the hydrogeologic conditions believed to exist at the Site, for all intents and purposes it meets the stated SFWMD requirements. The model used one layer for the production zone aquifer (i.e., the Upper Floridan aquifer) and two source beds (this is the only variation from configuration specified above). The surficial aquifer source bed, which is located above the production zone, was included to verify that there would be no significant drawdowns in this system. This was done because these wells will be used during drought conditions. The LFA PZ-1 source bed, which is located below the production zone, was included because regional data show that leakage from below is likely to be greater than leakage from above, and water quality below the production zone decreases rapidly with depth. Each layer used a single value for transmissivity/permeability, storage/storativity and leakage. The simulation was run for 90 days with no recharge and surface water features were not represented. The applicant believes the model configuration and the aquifer parameters used were appropriate and consistent with SFWMD BOR requirements for evaluating the potential impacts to the Floridan aquifer system.

Notwithstanding, the applicant is willing to install a test/production well and conduct an aquifer performance test and/or specific capacity test to verify aquifer parameters at the Site. This testing should be done after the UIC exploratory monitoring well is constructed. This will allow the UIC exploratory/monitoring well to be used during the aquifer performance test to estimate leakage from below the UFA. After the APT is complete, the models will be rerun using the updated aquifer parameters.

SFWMD Comment 24: The proposed Floridan Aquifer well may be withdrawing from the UFA from the same zone as that of 10 Aquifer Storage and Recovery (ASR) wells proposed as part of the future adjacent Comprehensive Everglades Restoration Plan (CERP) C-51 and Southern L-8 Reservoir Project. The 10 ASR wells are proposed to be sited along the L-8 canal, approximately 3,000' east of the project site. During extreme drought conditions, when the FPL plant will need an emergency back-up water supply source, the CERP ASR wells will be withdrawing stored water. Consequently, the proposed emergency backup Floridan well withdrawals for the power plant project are likely to adversely impact the SFWMD's ability to implement the ASR component of the proposed CERP project. Has FPL evaluated any alternatives to the UFA for the proposed emergency backup withdrawals? Potential alternative water supply sources include the Surficial Aquifer and the Lower Floridan Aquifer (LFA). In the vicinity of the project site, the lower production zone of the Surficial Aquifer is transmissive and is not being utilized to any great extent. In addition, some of the existing Surficial Aquifer wells in the vicinity associated with the rock mining activities may no longer be necessary and may be abandoned. Use of the LFA would likely require a reverse osmosis (RO) treatment plant.

Please note that water withdrawals from the L-10/L-12 canal are restricted when the water level in Lake Okeechobee drops below 11', as stated in the Upper East Coast Water Supply Plan (UECWSP).

Consequently, the SFWMD will only allow the use of groundwater when the water level in Lake Okeechobee drops below 11'.

Response 24: During the initial development of the Site, FPL sought approval from SFWMD that the use of water from the L10/L12 Canal was viable as a primary water source for the Project. FPL received a confirmatory letter to that regard from Mr. Henry Dean, Executive Director, in June 2004 that indicated the SFWMD staff would recommend approval of the Project's application to the Governing Board when appropriate information is submitted. Since that time, FPL has been developing plans for the Project that would also provide a backup cooling water supply during period(s) of drought when water levels in Lake Okeechobee drop below 11 ft. The most viable backup water source was determined to be the Upper Floridan aquifer.

Both the surficial aquifer and the Lower Floridan aquifer were evaluated as alternatives for the emergency backup supply (see the Water Supply Alternatives Analysis, SCA Appendix 10.8). The surficial aquifer is not suitable for the backup supply for several reasons. First, because the transmissivity is low, this aquifer can not efficiently produce the quantity of water required (over 14 million gallons per day). Second, the surficial aquifer and the surface water systems are interconnected. Consequently, even if adequate water could be pumped efficiently, removing significant quantities from the surficial aquifer during drought conditions would likely exacerbate already low water levels and flows in the surface water system. On the other hand, pumping from the Upper Floridan aquifer for limited durations will have no significant impact on the surface water system as described in Subsection 5.3.2 of the SCA and supported by the UFA modeling (SCA Appendix 10.7). The Lower Floridan aquifer contains highly mineralized water. Water from the Lower Floridan aquifer would require significantly greater treatment before it could be used by the power plant. This would add significant costs for a high-volume water treatment system that likely would be required for only short durations once every few years. As discussed above, the Upper Floridan aquifer wells would be used only when directed to do so by SFWMD.

The proposed emergency backup Floridan well withdrawals for the power plant should not adversely impact the SFWMD's ability to implement the ASR component of the proposed CERP project. The purpose of the ASR component is to store water in the aquifer during high-flow periods and to withdraw water for use during low-flow conditions. The backup Floridan wells will only be used when SFWMD directs FPL to withdraw from the backup wells to conserve surface water resources for other uses. The added flexibility provided by the backup wells will enhance water resource management by allowing surface waters to be used when the resource is abundant. This ensures that

surface waters are available for their highest and best use when supplies are limited, and provides a reliable source of water for power generation, which is also in the public interest.

SFWMD Comment 25: Prior to the initiation of any construction activities, the details of the proposed dewatering activities must be submitted for review and approval by SFWMD staff (due to resource concerns from saline connate water and off-site discharges). Submittal of a turbidity monitoring plan will also be required.

Response 25: Comment acknowledged. Prior to construction, details of any dewatering activities will be provided for the inlet structure and facilities.

SFWMD Comment 26: The project site is located within the Everglades Agricultural Area (EAA), as defined by Rule 40E-63.104(2), F.A.C. The project site is currently part of an Everglades Works of the District (EWOD) Permit (No. 50-00062-E), issued to Palm Beach Aggregates by the SFWMD on May 13, 1993. The EWOD Permit is currently undergoing modification to add acreage from a neighboring basin. The EWOD Permit includes a Best Management Practices (BMP) Plan whose purpose is to reduce phosphorus in the runoff from a single drainage basin within the permit. The EWOD Permit also includes a Water Quality Monitoring Plan for phosphorus sampling at one water control structure that ultimately discharges off-site into the C-51 (West Palm Beach) Canal. However, this structure is currently reported to be non-operational. Consequently, flows and phosphorus loads are being reported as "zero".

Pursuant to Rule 40E-63.110(1), F.A.C., an EWOD Permit is required by lands in the EAA that release water that ultimately makes use of, connects to, is released to, or is discharged to the Works of the District within the Everglades. Should all storm water runoff be retained on-site, as indicated in the SCA, the EWOD Permit requirements will not be applicable to this project. However, if the proposed storm water management plan is modified to include any off-site discharges, a re-evaluation of the applicability of Rule 40E-63, F.A.C., will be necessary.

Response 26: Comment acknowledged.

ATTACHMENT SFWMD-1

AERIAL PHOTOGRAPH

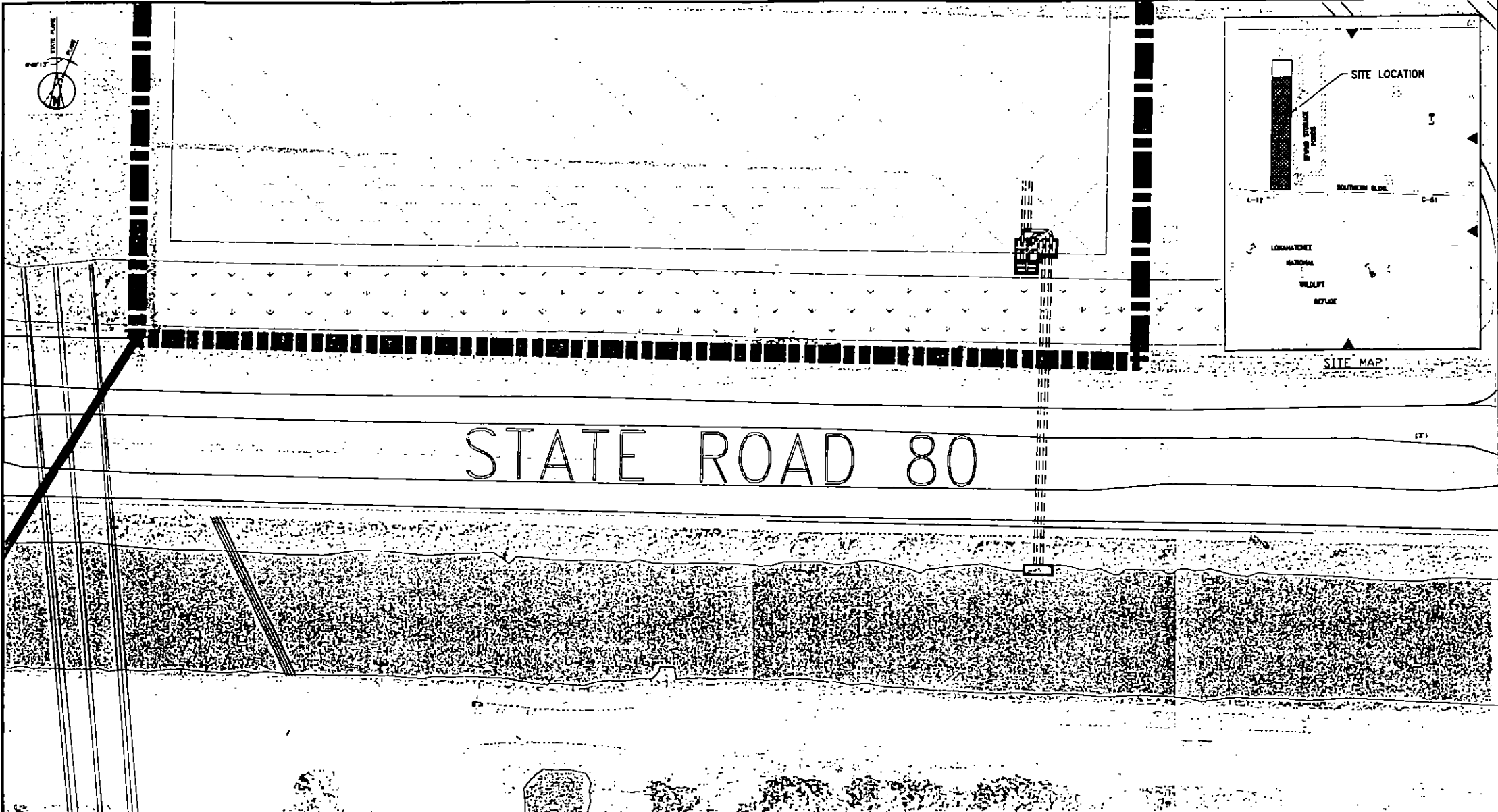

07-29-05 ISSUED FOR USE						SCALE	DISCIPLINE	PLANT/UNIT					
REV	DATE	REVISION DESCRIPTION				BY	CH	COR	APR	PGD	ORG	1"=100'	CS
						DRAWING SIZE	CAD FILE NAME	TITLE			AERIAL PHOTO WITH		
						B(11"x17")	N/A	INLET STRUCTURE & UNDERGROUD PIPING					
						DRAWING NUMBER	WC-IS-001-A		SHEET	REV	1 OF 1 0		

ATTACHMENT SFWMD-2

**SURVEY DRAWINGS/PROFILES
SHOWING RIGHT-OF-WAY**

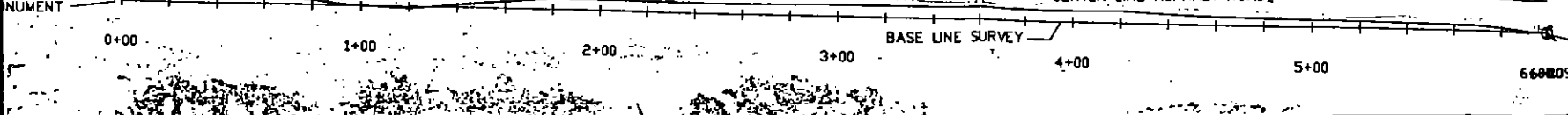
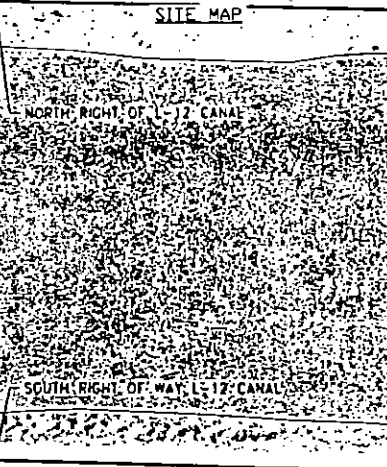
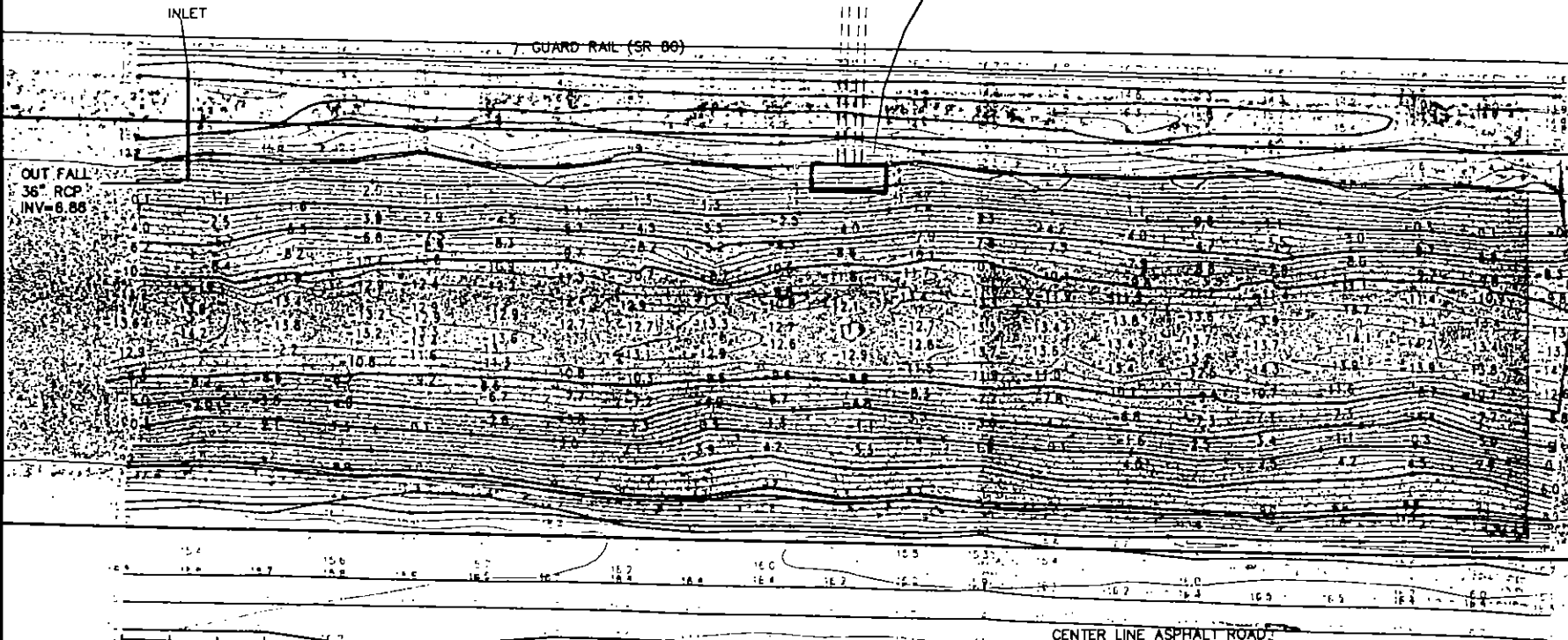
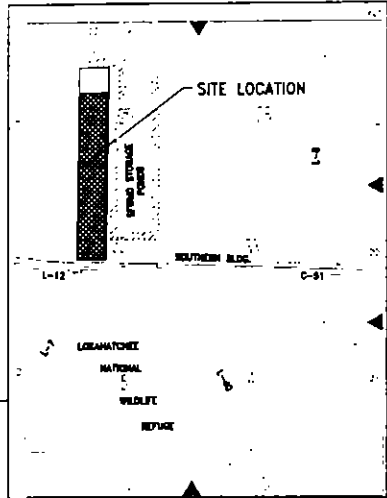
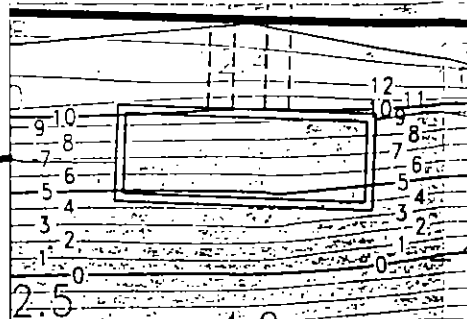
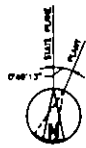

SET 4"x4" CONCRETE MONUMENT
 N 855007.89
 E 860907.55
 ELEV= 16.83

NOTES:
 1. RIGHT OF WAY LINES SHOWN TO BE VERIFIED BY SFWMD.

REV	DATE	ISSUED FOR USE	REVISION DESCRIPTION	GMG BY	CH	TDJ COR	PGD APR	ORG

	SCALE 1"=50'	DISCIPLINE CS	PLANT/UNIT WCEC
	DRAWING SIZE B(11"x17")	CAD FILE NAME N/A	TITLE AERIAL PHOTO WITH INLET STRUCTURE & UNDERGROUND PIPING
DRAWING NUMBER WC-IS-001	SHEET 1 OF 1	REV 0	

WEST ENERGY CENTER TOPOGRAPHIC SURVEY/HYDROGRAPHIC SURVEY L-12 CANAL

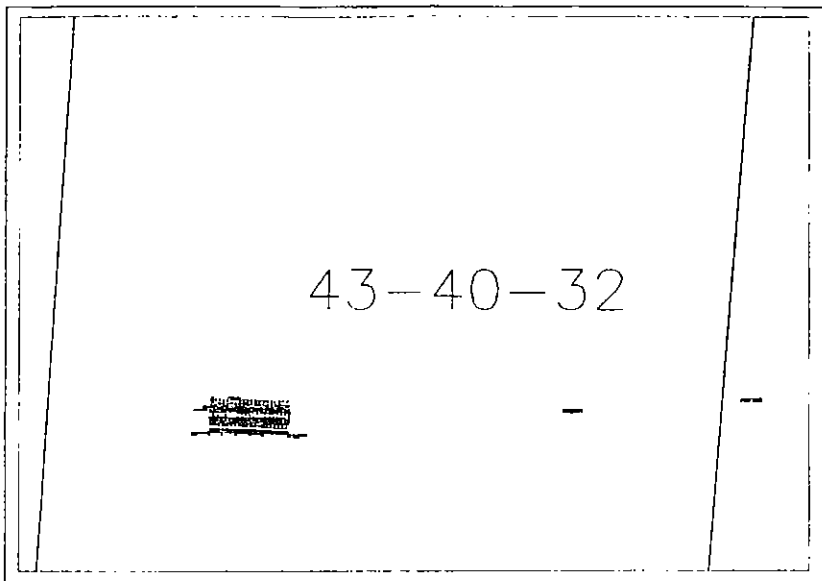

43-40-32

LOCATION MAP

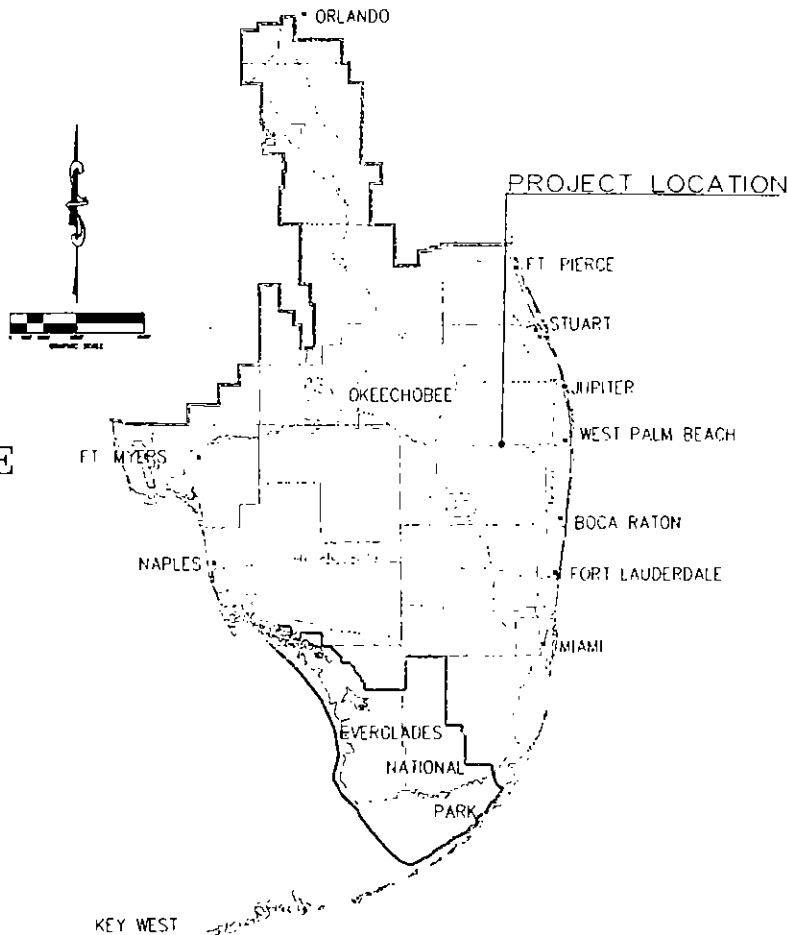

NOT TO SCALE

LEGEND	
● 7.03	SPOT ELEVATION
⊙	DISK IN CONCRETE MONUMENT
E	EASTING
E.L.	ELEVATION
FND	FOUND
INV	INVERT
I.R.C.	IRON ROD & CAP
L.B.	LICENSED BUSINESS
N	NORTHING
N.G.V.D.	NATIONAL GEODETIC VERTICAL DATUM
PK&D	PARKER KALON MAIL & DISK
P.B.Co	PALM BEACH COUNTY
RGE	RANGE
S.F.W.M.D.	SOUTH FLORIDA WATER MANAGEMENT DISTRICT
SEC	SECTION
TWP	TOWNSHIP
TYP	TYPICAL

A PORTION SEC 32 TWP 40S RNGE 43E

SURVEY NOTES

1. THIS TOPOGRAPHIC/HYDROGRAPHIC SURVEY WAS PERFORMED JULY 18 2005
2. NOT VALID WITHOUT THE SIGNATURE AND THE ORIGINAL RAISED SEAL OF A FLORIDA LICENSED SURVEYOR AND MAPPER
3. ADDITIONS OR DELETIONS TO SURVEY MAPS OR REPORTS BY OTHER THAN THE SIGNING PARTY OR PARTIES IS PROHIBITED WITHOUT WRITTEN CONSENT OF THE SIGNING PARTY OR PARTIES
4. ELEVATIONS SHOWN HEREON ARE BASED ON THE NORTH NATIONAL GEODETIC VERTICAL DATUM, 1925 (NGVD) SPECIFICALLY BASED ON NGS CONTROL MONUMENT AD8208 PUBLISHED ELEVATION 9.98 FEET
5. ELEVATIONS ARE BASED ON BENCHMARKS SUPPLIED BY THE NATIONAL GEODITIC SURVEY DATA BASE AND ARE LISTED BELOW LOCAL SITE CONTROL WAS ESTABLISHED USING REDUMAT STATIC GPS TECHNIQUES
6. SOUNDINGS WERE OBTAINED USING AN ODOM ECHOTRAC 3200 MK II DUAL FREQUENCY SURVEY GRADE FATHOMETER OPERATING AT 200 KHZ AND 24 KHZ. VESSEL POSITIONING WAS OBTAINED UTILIZING A DIFFERENTIAL GLOBAL POSITIONING SYSTEM (DGPS) AND TOPOGRAPHIC ELEVATIONS WERE OBTAINED EMPLOYING REAL TIME KINEMATIC GLOBAL POSITING (RTK GPS) METHODOLOGIES COMBINED WITH DIFFERENTIAL LEVELING TECHNIQUES
7. STATE PLANE COORDINATES SHOWN HEREON ARE IN FEET AND RELATIVE TO THE NORTH AMERICAN DATUM OF 1983 (NAD 83) AND ARE BASED ON THE TRANSVERSE MERCATOR PROJECTION FLORIDA WEST ZONE (0902)
8. THIS SURVEY DOES NOT IDENTIFY THE LIMITS OR EXTENT OF POTENTIAL JURISDICTIONAL BOUNDARIES
9. UNDER GROUND UTILITIES WERE NOT LOCATED AS PART OF THIS SURVEY AND SHOULD FIELD VERIFIED PRIOR TO CONSTRUCTION
10. ELEVATIONS SHOWN WITHIN THE L-12 WERE SORTED TO A FIFTEEN FOOT SEPERATION FOR GRAPHICAL PUPOSES
11. THE L-12 CANAL RIGHT OF WAY WAS PROVIDED DIGITALLY FROM THE SOUTHWEST FLORIDA WATER MANAGEMENT DISTRICT AND IS PROVIDED FOR GRAPHICAL PURPOSES ONLY NIETHER A BOUNDARY NOR A RIGHTOF WAY SURVEY WAS PERFORMED AS PART OF THIS SURVEY.

INDEX OF SHEETS

SHEET 1	COVER SHEET AND LOCATION MAP
SHEETS 2 THROUGH 5	PLAN SHEETS
SHEETS 6 THROUGH 10	CROSS SECTIONS

CERTIFICATION

I HEREBY CERTIFY THAT THIS TOPOGRAPHIC/HYDROGRAPHIC SURVEY WAS MADE UNDER MY RESPONSIBLE CHARGE AND MEETS THE APPLICABLE MINIMUM TECHNICAL STANDARDS FOR SURVEYS AS SET FORTH BY THE FLORIDA BOARD OF LAND SURVEYORS IN CHAPTER 61G17-6, FLORIDA ADMINISTRATIVE CODE, PURSUANT TO SECTION 472.027, FLORIDA STATE STATUES

APRIL 18, 2005
DATE OF LAST FIELD WORK

TIMOTHY L. GENDREAU
PROFESSIONAL SURVEYOR & MAPPER
FLORIDA CERTIFICATION NUMBER 5767

SURVEYING AND MAPPING

2500 HWY 30TH PLACE, PALM BEACH, FL 33409
Phone: (561) 977-1111 Fax: (561) 977-1076
Lic. No. 5841

SEA

DRAWN: T.L.C.
CHECKED: T.L.C.
DATE: 7/23/05
JOB NO. 3738
SHEET NO. 1 OF 8

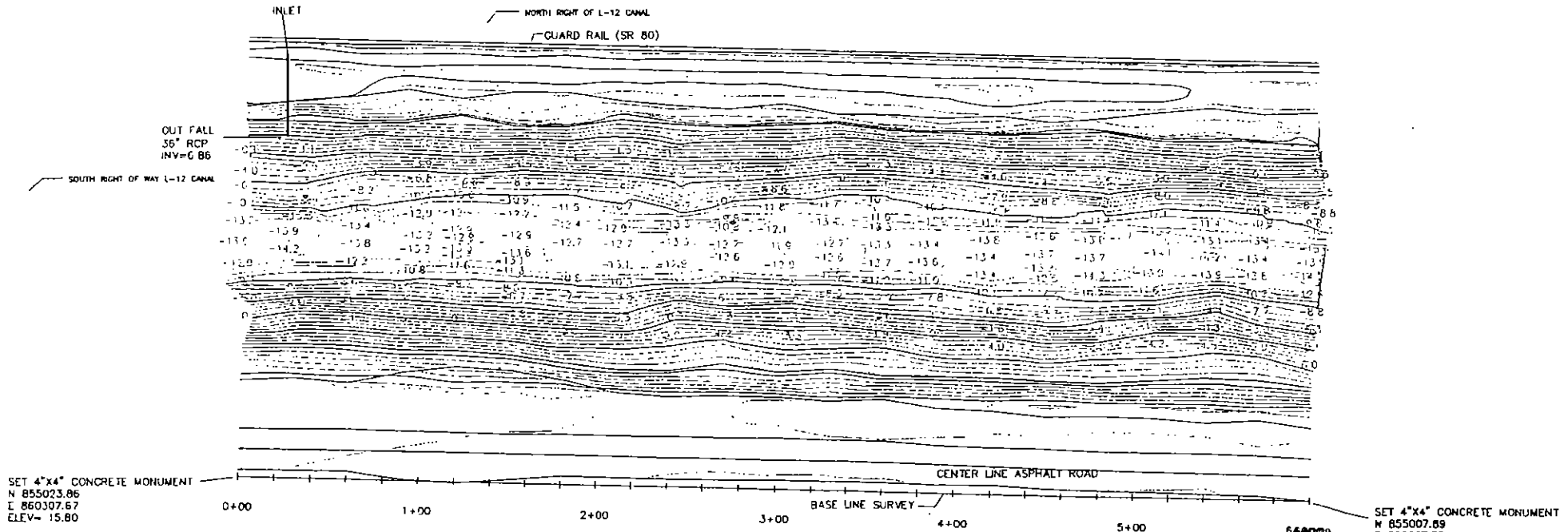

REVISIONS:

DATE: 7/23/05
 DRAWN: T.L.C.
 CHECKED: T.L.C.

WEST ENERGY CENTER
 TOPOGRAPHIC SURVEY
 AND HYDROGRAPHIC SURVEY
 PALM BEACH COUNTY, FLORIDA

SURVEYING AND MAPPING
 3302 NW 50th PLACE, POMPANO BEACH, FL 33061
 Phone: (561) 979-8071 Fax: (561) 974-8078
 L.B. NO. 5481



DATE: 7/23/05
 JOB NO. 5738
 SHEET NO. OF

WEST ENERGY CENTER
TOPOGRAPHIC SURVEY
AND HYDROGRAPHIC SURVEY
PALM BEACH COUNTY, FLORIDA

SURVEYING AND MAPPING
1300 NW 20TH PLACE, PALM BEACH BEACH, FL 33481
PHONE (561) 978-8071 FAX (561) 934-8078
LIC. NO. 5981

SEA
SURVEYING

DRAWN: T.L.C. CHECKED: T.L.C. DATE: 7/23/00 JOB NO.: 3726 SHEET NO.: 29

REVISIONS:

HORIZONTAL SCALE 1"=20'
VERTICAL SCALE 1"=10'

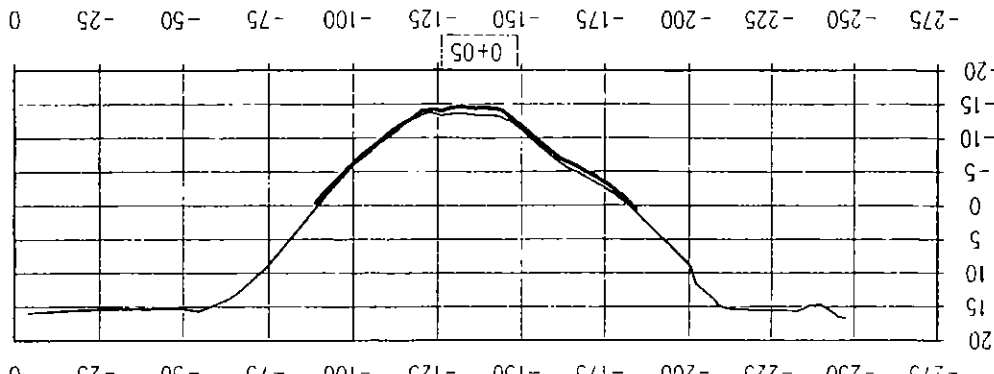
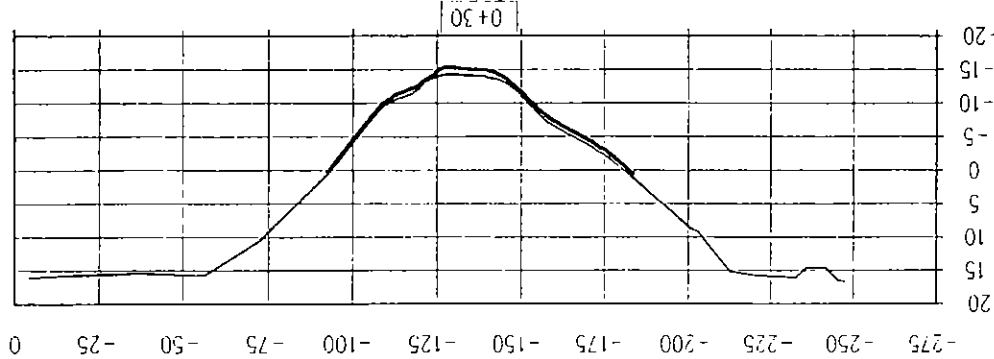
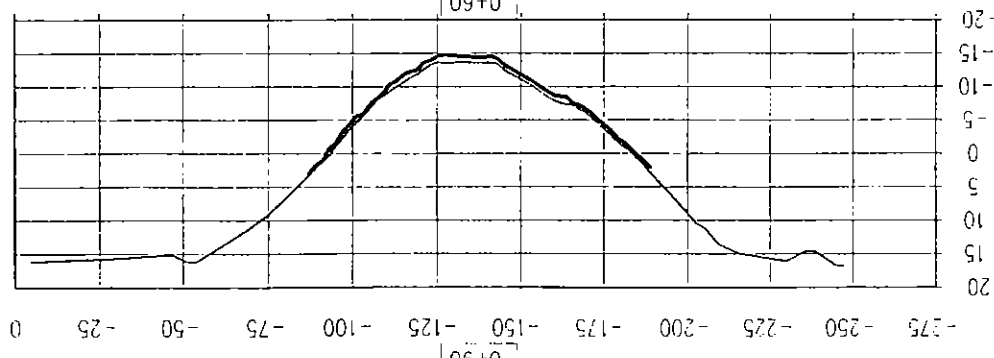
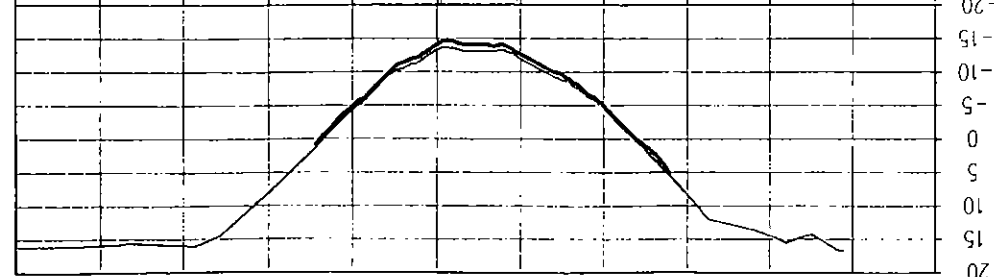
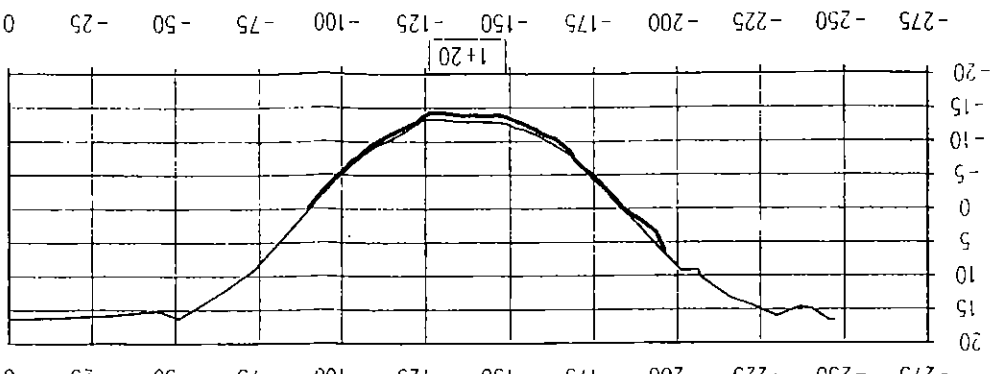
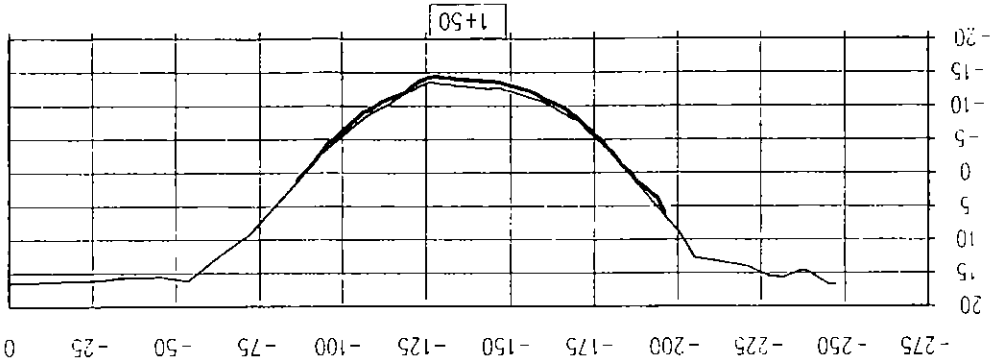
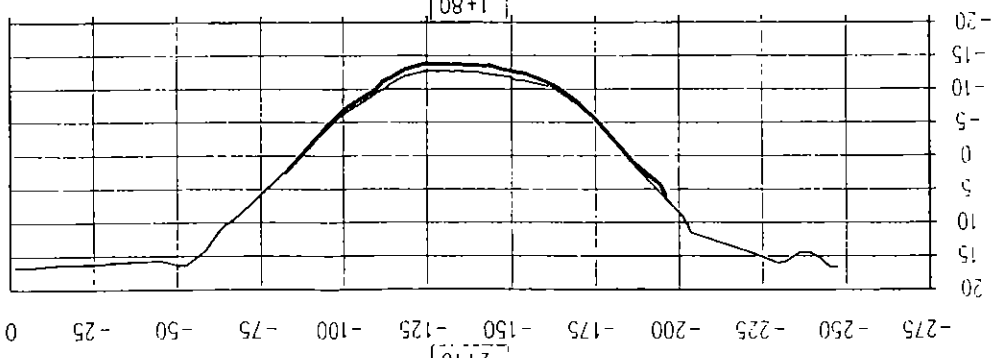
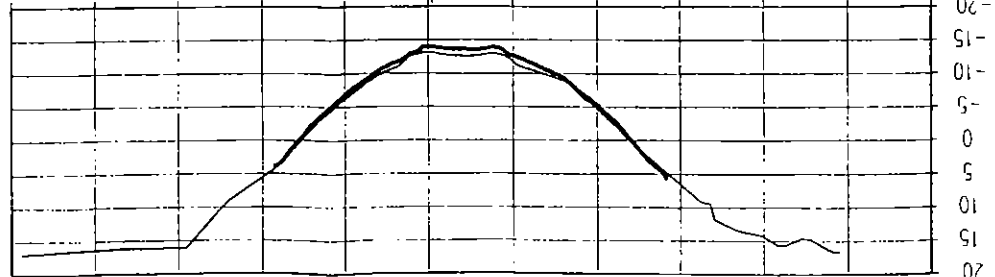

SHEET NO. 3738
 JOB NO. 7/23/05
 DATE: T.L.G.
 CHECKED: T.L.G.
 DRAWN: T.L.G.

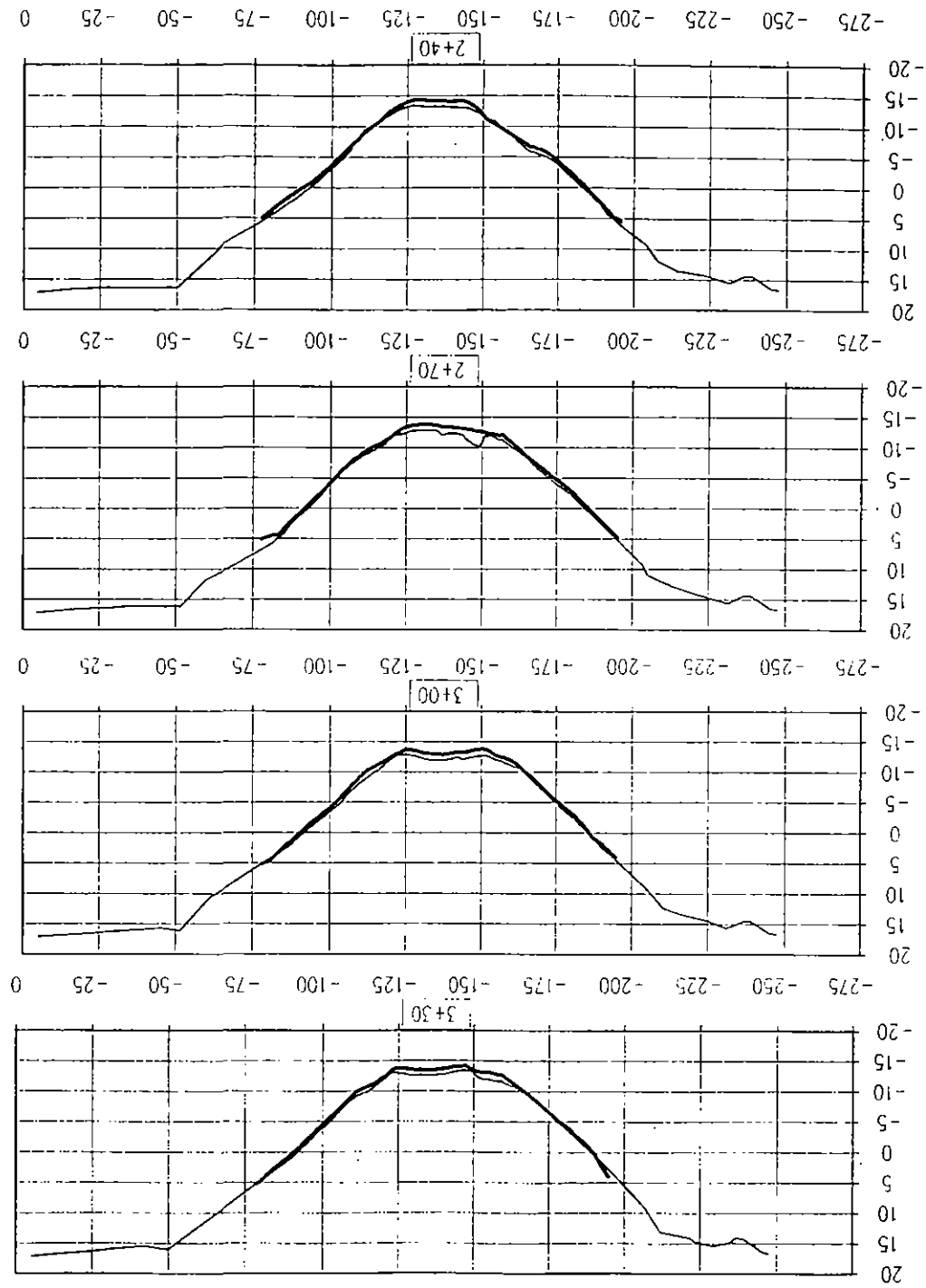
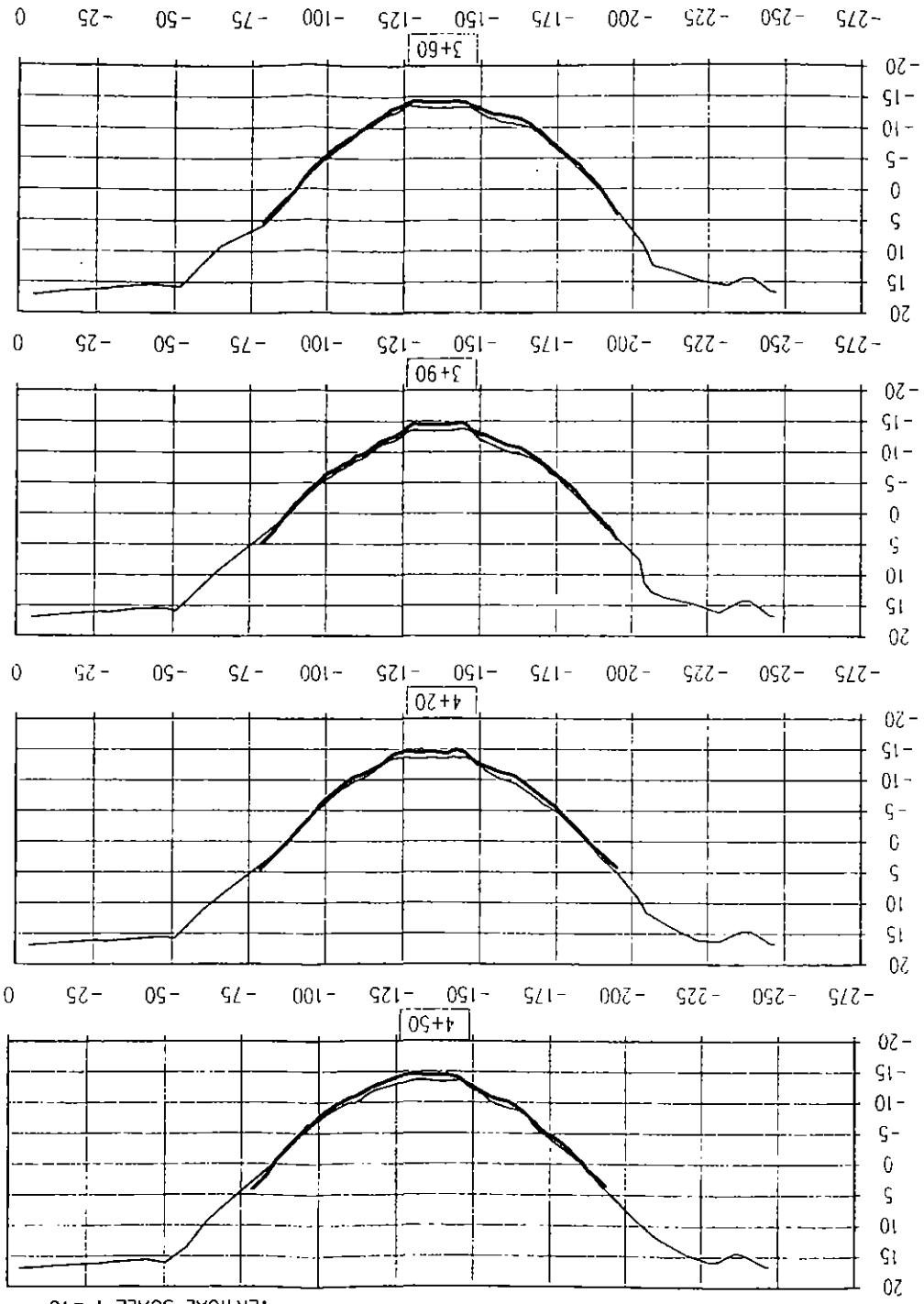
 SURVEYING AND MAPPING
 1300 NW 20th Road, Pompano Beach, FL 33069
 Phone: (954) 976-8071 Fax: (954) 954-8071
 L.S. No. 5681
 WEST ENERGY CENTER
 TOPOGRAPHIC SURVEY
 AND HYDROGRAPHIC SURVEY
 PALM BEACH COUNTY, FLORIDA
 DATE: 7/23/05
 DRAWN: T.L.G.
 CHECKED: T.L.G.
 SHEET NO. 3738

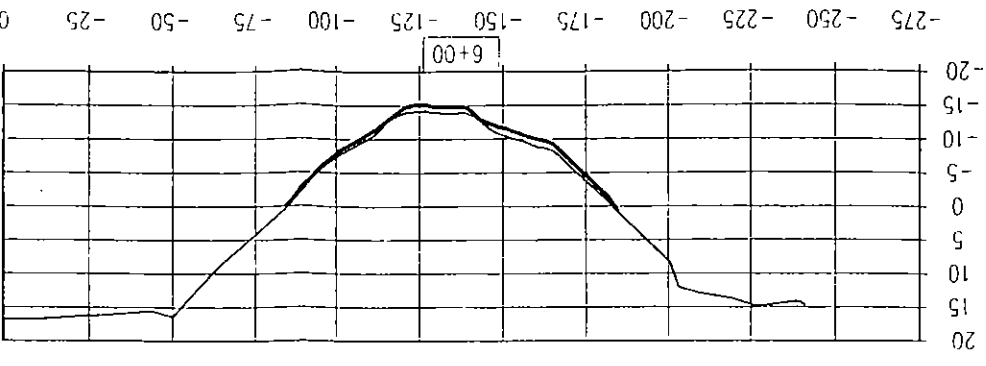

HORIZONTAL SCALE 1"=20
VERTICAL SCALE 1"=10'

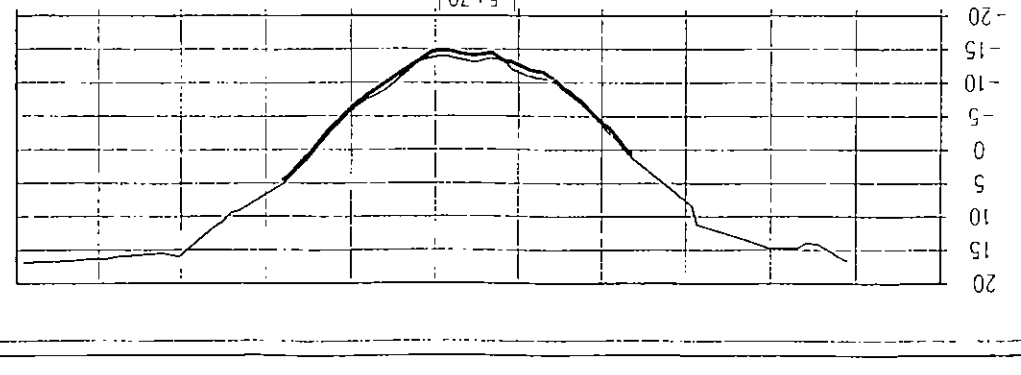
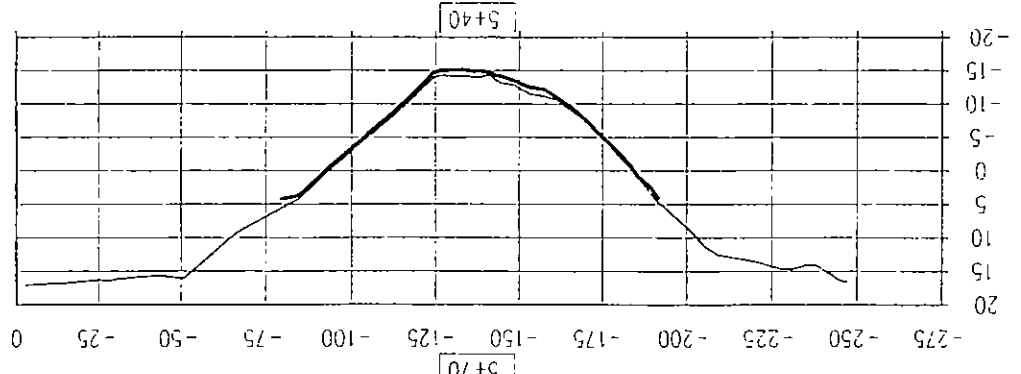
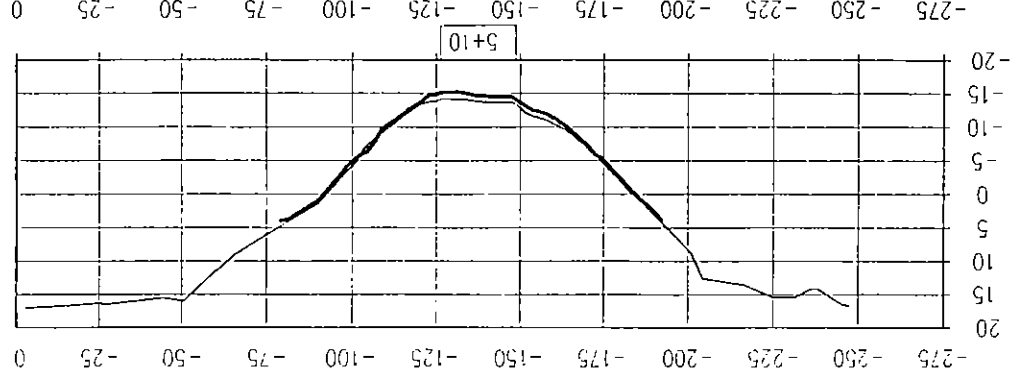
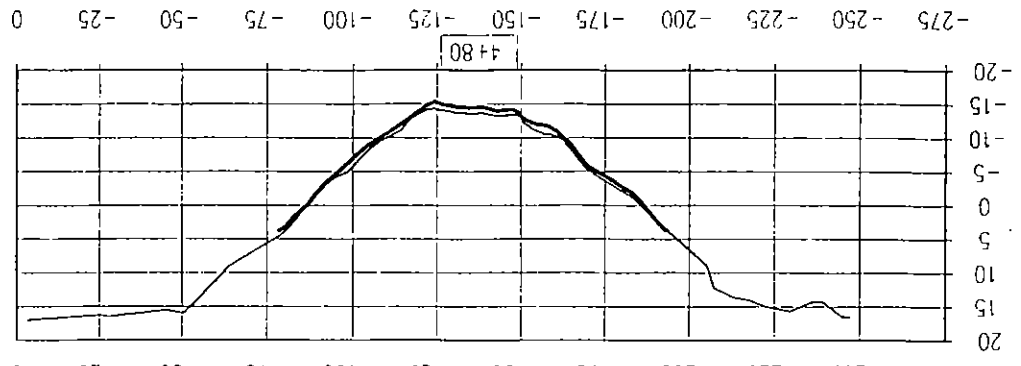

HORIZONTAL SCALE 1"=20'
 VERTICAL SCALE 1"=10'



SHEET NO. 373A JOB NO. 7/23/00 DATE: 7/23/00 T.L.C. CHECKED: T.L.C. DRAWN: 	SURVEYING AND MAPPING 2301 W. 30TH PLACE, POKER FLORIDA 33081 Phone: (954) 978-1071 Fax: (954) 978-1078 Lic. No. 5981	WEST ENERGY CENTER TOPOGRAPHIC SURVEY AND HYDROGRAPHIC SURVEY PALM BEACH COUNTY, FLORIDA	WEST ENERGY CENTER 2301 W. 30TH PLACE, POKER FLORIDA 33081 Phone: (954) 978-1071 Fax: (954) 978-1078 Lic. No. 5981	REVISIONS: _____ _____ _____
--	--	---	---	---------------------------------------

NORTH SIDE OF CANAL
RIGHT OF WAY

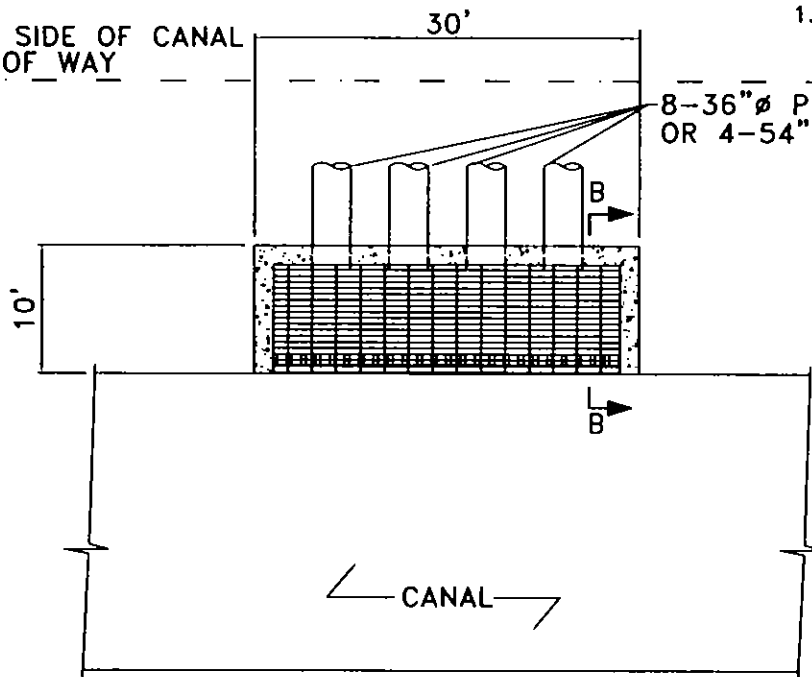

NOTES:

1. ACCESS TO STRUCTURE, COFFER DAM STRUCTURE, & EROSION DETAILS LATER.

PLAN VIEW ALTERNATE INLET STRUCTURE

NORTH SIDE OF CANAL
RIGHT OF WAY

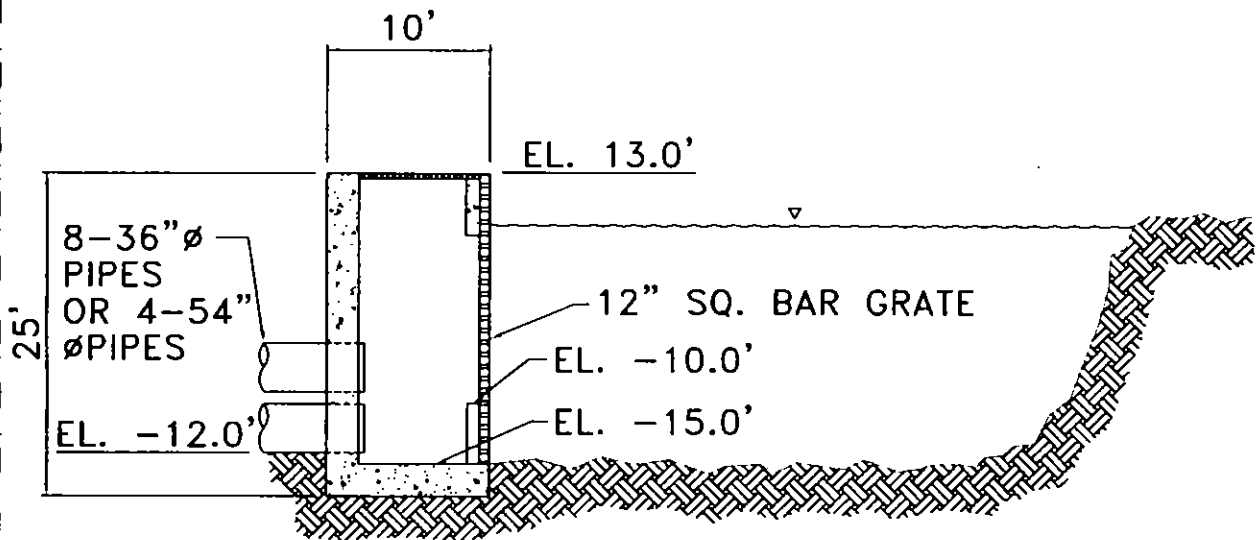

SECTION B-B

0 08/01/05 ISSUED FOR USE		GMC		TDJ		PCD		DRAWING NUMBER		SHEET		REV	
REV	DATE	REVISION DESCRIPTION		BY	CH	COR	APR	ORG	SCA-006	1 OF 1	0		
				SYSTEM N/A		DISCIPLINE CS		PLANT/UNIT WCEC					
				SCALE NTS		CWD FILE NAME IS-05.DWG		TITLE ALTERNATE INLET STRUCTURE PLAN, SECTIONS & DETAILS					
				DRAWING SIZE A (8.5X11)		FPL ARCHIVE NAME N/A							

ATTACHMENT SFWMD-17

UPDATED SCA FIGURES 3.5.0-3

AND 3.5.0-4

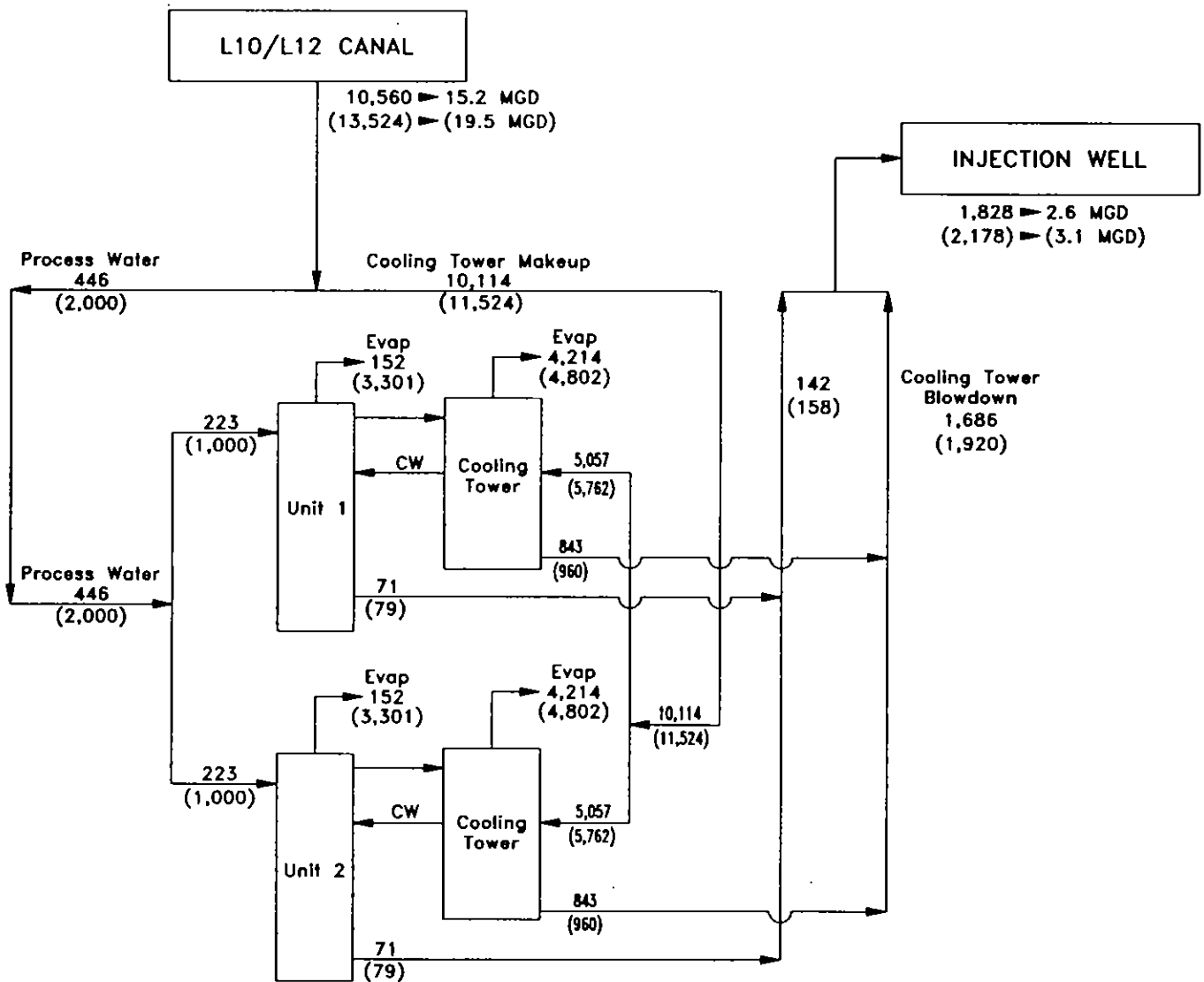

NOTES:

1. FLOWS ARE IN GALLONS PER MINUTE (GPM).
2. FLOWS SHOWN WITH NO () ARE BASE ON AVERAGE DAILY WATER USE.
3. NUMBERS IN () ARE PEAK INTERMITTENT FLOWS.
4. FLOWS ARE BASED ON 6 CONC. IN CT.

	SYSTEM	n/a	DISCIPLINE	CS	PLANT/UNIT	WCEC -- FIGURE 3.5.0-3a
	SCALE	n/a	CAD FILE NAME	WMB.DWG	TITLE	WATER MASS BALANCE FOR WCEC
	DRAWING SIZE	A (8.5X11)	FPL ARCHIVE NAME	n/a		PRIMARY SOURCE (SURFACE WATER) TWO 1,100-MW UNITS

0	02-14-05	ISSUED FOR USE	GMC			TJW	PCBL	0437649/4/4.2SCA/WaterBalance(CB-007-S)	SHEET	1 of 1	REV	1
REV	DATE	REVISION DESCRIPTION	BY	CH	COR	APR	ORC					

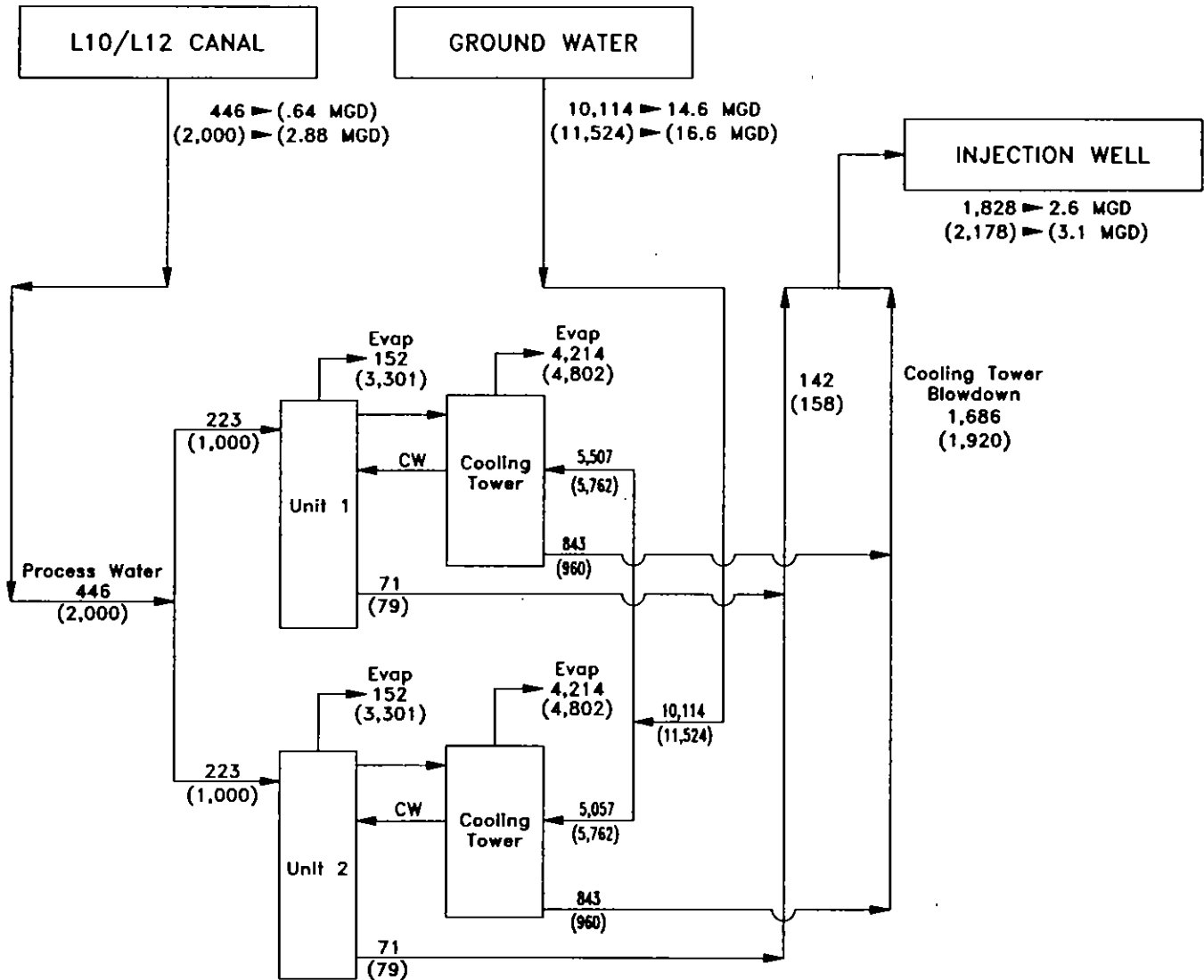

NOTES:

1. FLOWS ARE IN GALLONS PER MINUTE (UNO).
2. FLOWS SHOWN WITH NO () ARE BASE ON AVERAGE DAILY WATER USE.
3. NUMBERS IN () ARE PEAK INTERMITTENT FLOWS.
4. FLOWS ARE BASED ON 6 CONC. IN CT.

	SYSTEM n/a	DISCIPLINE CS	PLANT/UNIT WCEC -- FIGURE 3.5.0-4 a
	SCALE n/a	CAD FILE NAME WMB.DWG	TITLE WATER BALANCE FOR WCEC SECONDARY SOURCE (BACKUP)-- GROUNDWATER-TWO 1,100-MW UNITS
	DRAWING SIZE A (8.5X11)	FPL ARCHIVE NAME n/a	

1	3/17/05	ISSUED FOR USE	CMC	TDJ	PCBL	DRAWING NUMBER 0437649/4/4.2SCA/WaterBalance(CB-008-G)	SHEET 1 of 1	REV 2
REV	DATE	REVISION DESCRIPTION	BY	CH	COR	APR	ORG	

ATTACHMENT SFWMD-19

PROPERTY OWNERSHIP DOCUMENTS



Prepared By and Return To:

Pamela M. Rauch, Esq.
Florida Power & Light Company
700 Universe Blvd. (LAW/JB)
Juno Beach, FL 33408-0420

CFN 20040624179
OR BK 17717 PG 0238
RECORDED 11/02/2004 14:33:07
Palm Beach County, Florida
AMT 18,000,000.00
Doc Stamp 126,000.00
(This space reserved for recording information of Court
Pg 0238 - 240; 13pgs)

#89
Return To

SOUTHEAST GUARANTY & TITLE, INC.
1645 PALM BEACH LAKES BLVD., SUITE 160
WEST PALM BEACH, FLORIDA 33401

2308-009

SPECIAL WARRANTY DEED

This Special Warranty Deed made on the 1st day of November, 2004, by and between PALM BEACH AGGREGATES, INC., a Florida corporation, having its mailing address at 20125 State Road 80, Loxahatchee, Florida 33470 ATTN: Enrique Tomeu ("Grantor") and FLORIDA POWER & LIGHT COMPANY, a Florida corporation whose mailing address is 700 Universe Boulevard, Juno Beach, Florida, ATTN: Corporate Real Estate ("Grantee").

WITNESSETH:

Grantor, in consideration of Ten Dollars (\$10.00) and other good and valuable consideration, to it paid by Grantee, the receipt of which is hereby acknowledged, hereby grants, sells, and conveys to Grantee, its successors and assigns forever all of that certain land situated and located in Palm Beach County, Florida and more particularly described as follows:

See Exhibit "A" attached hereto and by this reference made a part hereof for the description of the land conveyed hereby.

Subject to taxes and special assessments for the year 2004 and all subsequent years, to zoning restrictions and other requirements imposed by governmental authority, and to easements, reservations and restrictions of record.

TO HAVE AND TO HOLD in fee simple forever.

AND Grantor hereby binds itself and its successors to warrant the title as against all acts of the Grantor herein and no other, subject only to the matters set forth above.

IN WITNESS WHEREOF, Grantor has caused this instrument to be signed by its duly authorized officer on the date first above written.

Executed in the presence of:

[Signature]
Signature
Print Name: DAVID M. TASCIA
[Signature]
Signature
Print Name: THOMAS A. HANSEN

PALM BEACH AGGREGATES, INC., a
Florida corporation
By: [Signature]
Printed Name: ENRIQUE TOMEU
Its: PRESIDENT

(This space reserved for recording information)

STATE OF FLORIDA)
)ss
COUNTY OF PALM BEACH)

On this 1 day of November, 2004, before me, the undersigned notary public, personally appeared ERIQUE TOMEU, as PRESIDENT of Palm Beach Aggregates, Inc., a Florida corporation, personally known to me to be the person who subscribed to the foregoing instrument and acknowledged that he executed the same on behalf of said corporation and that he was duly authorized to do so.

In Witness Whereof, I hereunto set my hand and official seal.

(seal)

Thomas A. Hanson
Notary Public, State of Florida

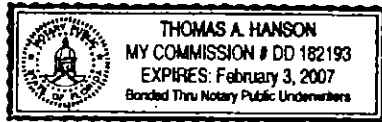

(This space reserved for recording information)

Exhibit "A"
To Special Warranty Deed
Legal Description

PARCEL A DESCRIPTION

A parcel of land lying in Section 29, Township 43 South, Range 40 East, Palm Beach County, Florida, described as follows:

Commencing at the Northwest corner of said Section 29, Township 43 South, Range 40 East, Thence South $88^{\circ} 52' 46''$ East 745.00 feet along the North line of said Section 29 to the East line of Florida Power & Light Company 500 Kv transmission line corridor as recorded in Official Record Book 2222, Page 1696, Public Records of Palm Beach County, Florida. Thence South $0^{\circ} 49' 13''$ West 589.00' along said East line, which is the same West line of the Florida Power & Light Company's Corbett Substation to the Southwest corner of said Corbett Substation and the Point of Beginning, thence South $88^{\circ} 52' 46''$ East 1200.00 feet along the South line of said Corbett Substation and its Easterly extension to a point on a line parallel with the West line of Section 29, Township 43 South, Range 40 East, thence South $0^{\circ} 49' 13''$ West 3630.04 feet along said parallel line to a point on a line parallel with the North line of said Section 29, thence North $88^{\circ} 52' 46''$ West 1200.00 feet along said line parallel with the North line of Section 29, to the East line of the Florida Power & Light Co. 500 Kv transmission line corridor, thence North $0^{\circ} 49' 13''$ East 3630.04 feet along said F P & L Co. East line to the Point of Beginning.

After recording return to:
Orin Shakerdge, Esq.
Florida Power & Light
700 Universe Blvd.
Juno Beach, FL 33408

Memorandum of Option

In consideration of \$10.00 and other valuable consideration, the receipt and sufficiently of which is hereby acknowledged, Palm Beach Aggregates, Inc., a Florida corporation, ("Seller") whose address is 20125 SE 80, P.O. Box 700, Loxahatchee, Florida 33470, does hereby grant to Florida Power & Light Company, ("Purchaser") whose address is 700 Universe Blvd., Juno Beach, Florida 33408, the right and option to purchase the property described on Exhibit "A," attached hereto and incorporated by reference herein.

This option shall expire on the 13th day of August, 2006.

13th The provisions set forth in a written option agreement between the parties dated the day of August, 2003, are hereby incorporated in this memorandum.

WITNESS our hand(s) and seal(s) this 3rd day of October, 2003.

Witness for Seller:

By: Venessa Sario
Name: VENESSA SARIO
By: Loures M. M. M. M.
Name: Loures M. M. M. M.

Seller:
Palm Beach Aggregates, Inc.
a Florida corporation
By: [Signature]
Name: Enrique A. Gomez
Its: President

Witness for Purchaser:

By: Jeanne K. Gorsuch
Name: Jeanne K. Gorsuch
By: [Signature]
Name: [Signature]

Purchaser:
Florida Power & Light Company
a Florida corporation
By: [Signature]
Name: ARMANDO J OLIVERA
Its: PRESIDENT

Elsa M. Akin

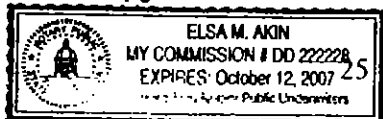

SELLER'S ACKNOWLEDGMENT

STATE OF FLORIDA)
)
COUNTY OF PALM BEACH)

I, Melissa Rentas, do hereby certify that Enrique A. Torres, the President of Palm Beach Aggregates, Inc. personally appeared before me this day and acknowledged the due execution of the foregoing instrument.

Witness my hand and official seal, this the 8th day of October, 2003.

Melissa S. Rentas
Notary Public for: _____
My commission expires _____



PURCHASER'S ACKNOWLEDGMENT

STATE OF FLORIDA)
)
COUNTY OF PALM BEACH)

I, Elsa Akin, do hereby certify that Armando J. Olivera, the _____ of Florida Power & Light Company personally appeared before me this day and acknowledged the due execution of the foregoing instrument.

Witness my hand and official seal, this the 3rd day of October, 2003.

Elsa M. Akin
Notary Public for: _____
My commission expires: _____

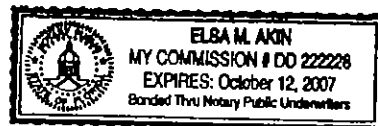

EXHIBIT A

Legal Description

Part of Parcel I in Sections 29 and 32, Township 43 South, Range 40 East, Palm Beach County, Florida described as follows: Commencing at the Northwest corner of Section 29, Township 43 South, Range 40 East, Palm Beach County, Florida, thence South 88°52'46" East 745.00 feet along the North line of Section 29 to the East right-of-way line of the Florida Power & Light Company corridor as recorded in O.R.B. 2222, Page 1696, thence South 0°49'13" West 589.00 feet along a line parallel with the West line of said Section 29, along the East right-of-way line of the aforementioned Florida Power & Light Company corridor to the Southwest corner of the East 900 feet of the West 1645 feet of the North 589 feet of said Section 29 and the point of beginning of Parcel II, thence South 88°52'46" East 1200.00 feet along the South line of the East 900 feet of the West 1645 feet of the North 589 feet of said Section 29 and its Easterly extension, thence South 0°49'13" West 4658.85 feet along a line parallel with East right-of-way line of the Florida Power & Light company corridor, to the North line of Section 32, Township 43 South, Range 40 East, thence South 0°56'55" West 3378.92 feet along a line parallel with the East right-of-way line of the aforesaid Florida Power & Light Company corridor to the North right-of-way line of State Road 80 thence North 88°28'14" West 1100.09 feet along said right-of-way line of State Road 80, to the East right-of-way line of the Florida Power & Light Company corridor, thence North 0°56'55" East 880.76 feet along a line parallel with said West line of Section 32, Township 43 South, Range 40 East, thence North 89°03'05" West 100.00 feet at right angles to the preceding course, then North 0° 56' 55" East 2501.94 feet along the East right-of-way line of Florida Power & Light company corridor to the South line of Section 29, Township 43 South, Range 40 East, thence North 0°49'13" East 4647.51' feet along said right-of-way line to the Point of Beginning.

PARCEL Containing Approximately 220 acres.

ATTACHMENT SFWMD-20

SURFICIAL WELL INVENTORY –
UPDATED FIGURE 6 AND TABLE 3

TABLE 3
 PERMITTED SURFICIAL AQUIFER WELL INVENTORY
 AND SURFICIAL MONITORING WELL INVENTORY
 WITHIN 1-MILE RADIUS OF THE SITE

WEST COUNTY ENERGY CENTER
 LOXAHATCHEE, FLORIDA

PERMITTED SURFICIAL AQUIFER WELLS																						
Map ID	PERMIT NO.	APP NO.	PERMIT TYPE	PROJECT NAME	LAND USE CODE	ACRES SERVED	FACILITY ID	FACILITY NAME	PUMP TYPE	DIAMETER	PUMP DEPTH	PUMP CAPACITY	X COORD ¹	Y COORD ¹	WELL DEPTH	CASING DEPTH	SOURCE	WATER USE	SEC	TWP	RGE	
1	50-03276-W	940104-10	GP	FBI SO LAW ENFORCEMENT TRAINING FACILITY	PWS	26.71	3936	1	CEN	2.00	0.00	55	858137	854862	78	75	Surficial Aquifer System	PWS	31	43.0	40.0	
2	50-03458-W	010816-4	GP	WEST PALM BEACH FIELD STATION	LAN	5.00	111208	S-5A-1	CEN	1.50	0.00	20	862184	854824	40	0	Surficial Aquifer System	PWS	32	43.0	10.0	
3	50-03458-W	010816-4	GP	WEST PALM BEACH FIELD STATION	LAN	5.00	111209	S-5A-2	CEN	1.50	0.00	20	860580	854973	40	0	Surficial Aquifer System	PWS	32	43.0	40.0	
4	50-03458-W	010816-4	GP	WEST PALM BEACH FIELD STATION	LAN	5.00	111210	S-5A-3	CEN	1.50	0.00	0	861542	854952	40	0	Surficial Aquifer System	PWS	32	43.0	40.0	
5	50-03458-W	010816-4	GP	WEST PALM BEACH FIELD STATION	LAN	5.00	111211	S-5A-4	CEN	1.50	0.00	0	861051	854931	40	0	Surficial Aquifer System	PWS	32	43.0	40.0	
6	50-04360-W	990628-5	GP	RESEARCH AND EVALUATION FACILITY	LAN	17.59	30683	6	CEN	2.00	0.00	30	859437	864500	40	0	Surficial Aquifer System	IRR	19	43.0	40.0	
7	50-04685-W	031021-8	GP	TEMPORARY CONCRETE BATCH PLANT	IND	1.00	101756	1	CEN	4.00	45.00	0	861700	856500	50	40	Surficial Aquifer System	IND	32	43.0	40.0	
8	50-06150-W	040317-1	GP	PALM BEACH AGGREGATES	PWS	3200.00	139370	W-2	CEN	4.00	0.00	50	860851	856819	50	30	Surficial Aquifer System	PWS	32	43.0	40.0	
9	50-06150-W	040317-1	GP	PALM BEACH AGGREGATES	PWS	3200.00	139377	W-3	CEN	4.00	0.00	50	861169	866155	50	30	Surficial Aquifer System	PWS	20	43.0	40.0	
10	50-06150-W	040317-1	GP	PALM BEACH AGGREGATES	PWS	3200.00	148765	W-5	CEN	2.00	0.00	80	860426	856873	100	90	Surficial Aquifer System	PWS	32	43.0	40.0	
11	50-06150-W	040317-1	GP	PALM BEACH AGGREGATES	PWS	3200.00	139369	W-1	CEN	4.00	0.00	50	861423	863932	50	30	Surficial Aquifer System	PWS	29	43.0	40.0	
12	50-06583-W	040804-11	GP	ADONEL CONCRETE BATCH PLANT	IND	5.26	157332	W-1	CEN	2.00	0.00	10	861978	856085	50	40	Surficial Aquifer System	PWS	32	43.0	40.0	

SURFICIAL MONITORING WELLS											
Map ID	STATION	AGENCY	STRATA	LATITUDE	LONGITUDE	X COORD ¹	Y COORD ¹	BASIN	SECTION	TOWNSHIP	RANGE
13	ENR001W1	WMD	90	264100	802233	859960	854585	CA1	32	43	40
14	ENR001W2	WMD	53	264100	802233	859960	854585	CA1	32	43	40
15	G-2235-G	USGS	24	264101	802209	862137	854697	CA1	0	48	43

¹ State Plane Coordinates (Florida East, 1983)

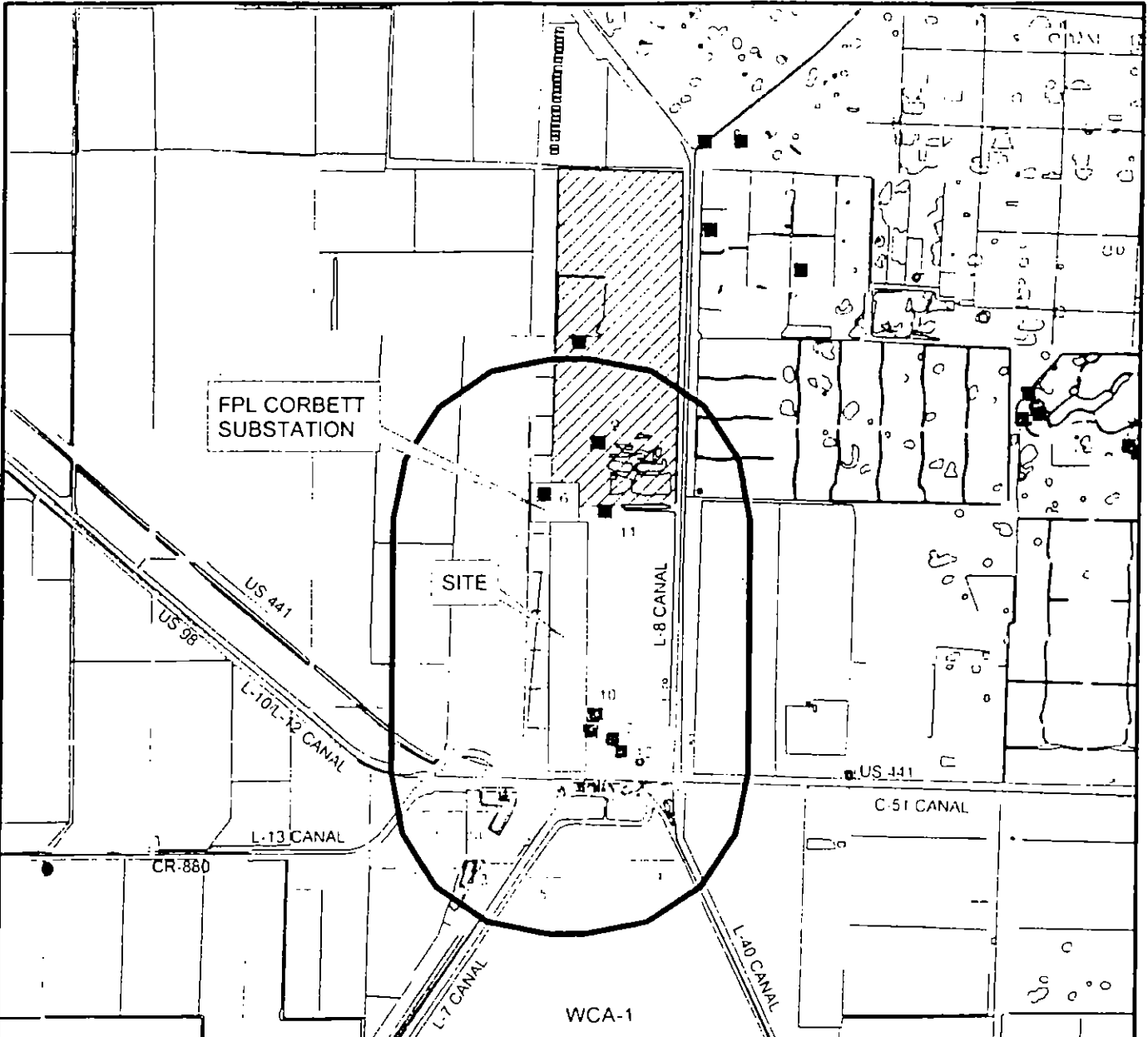

Legend

- Surficial Monitoring Well
- Permitted Surficial Aquifer Well
- 1-Mile Buffer
- ▨ Palm Beach Aggregates Quarry
- Roads
- Canals



SCALE AS SHOWN
 DATE 7/7/2005
 DESIGN JWT
 GIS JWT

TITLE
**AREA OF REVIEW
 SURFICIAL WELL INVENTORY**

FILE No 0437649A011.mxd
 PROJECT No 043-7649 REV 0

CHECK
 REVIEW

WEST COUNTY ENERGY CENTER FIGURE 6

ATTACHMENT SFWMD-21

SFWMD-GENERATED WELL INFORMATION

Wells

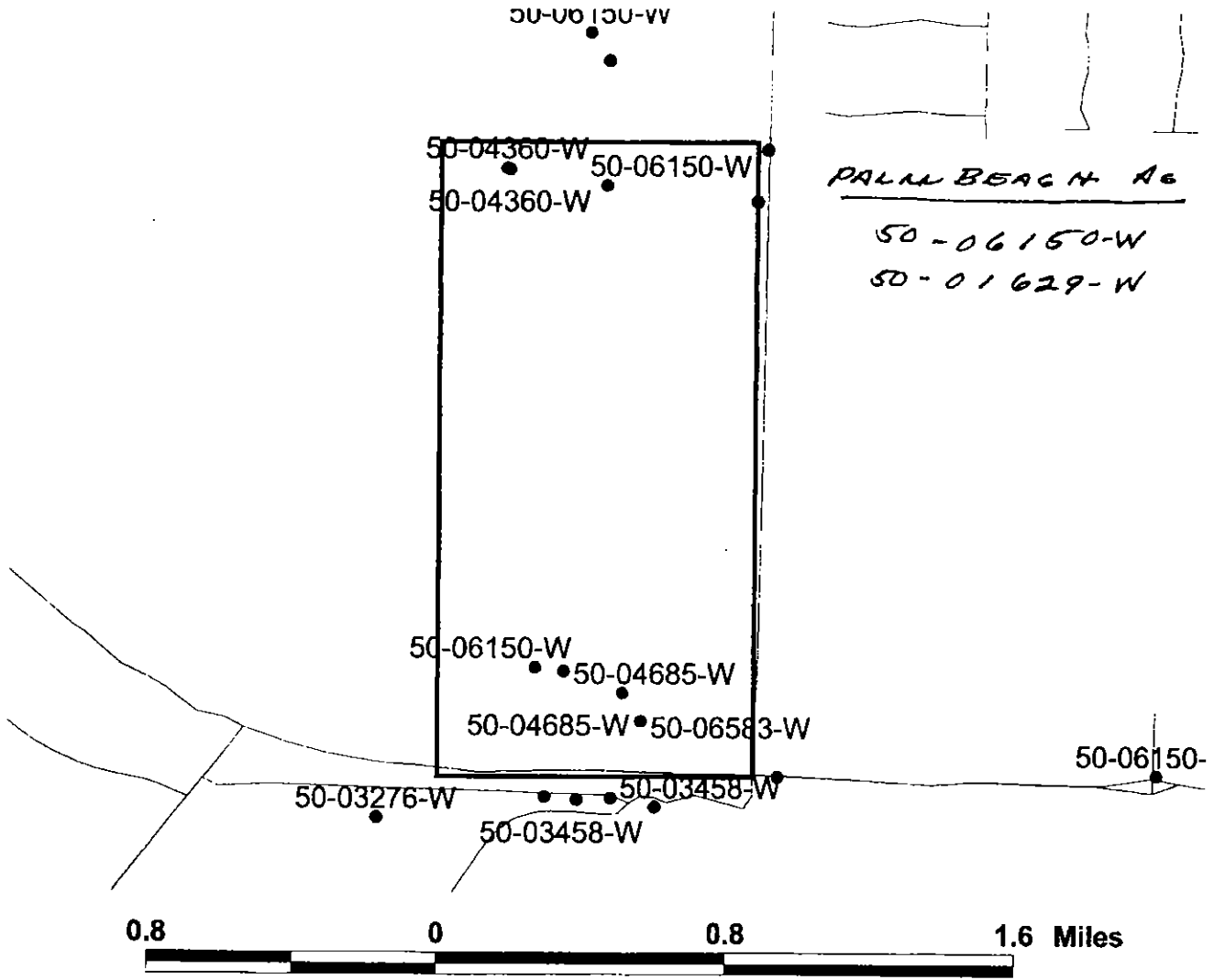

- WU GW Salt Wells, Palm Beach
- WU GW PWS Wells, Palm Beach
- WU GW Wells, Palm Beach
- ▭ Detailed Roads
- ▭ County Boundaries

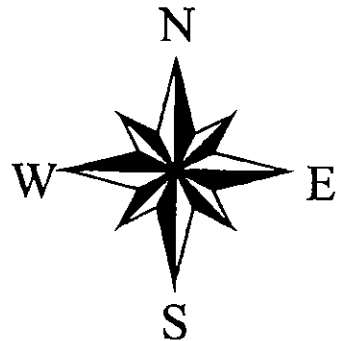

Site Map

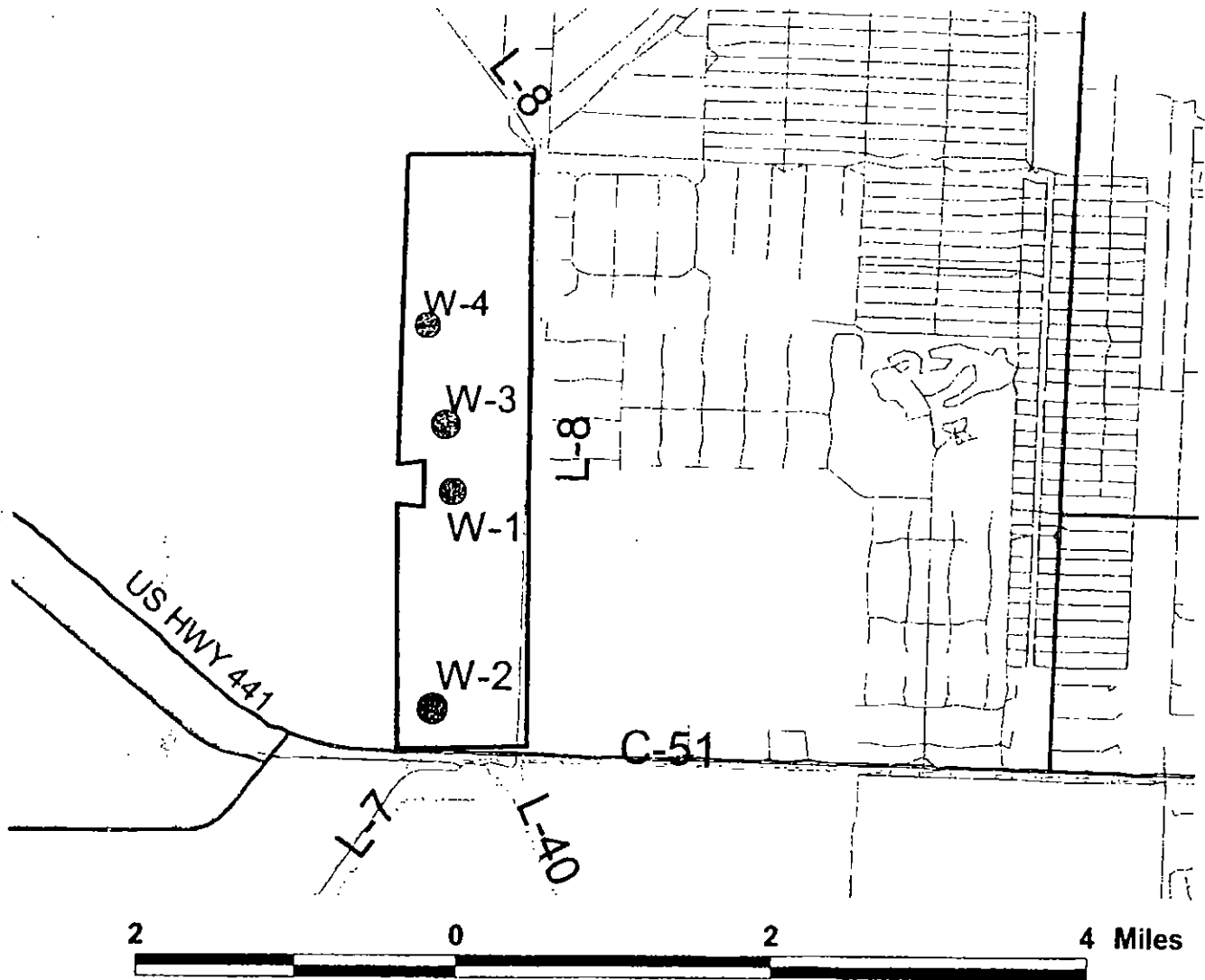

- Detailed Roads
- Major Canals
- State Roads
- County Boundaries

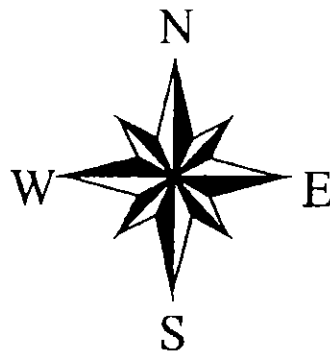

Exhibit 4

ATTACHMENT SFWMD-22

**BACKUP PRODUCTION WELL
TYPICAL CONSTRUCTION DETAILS**

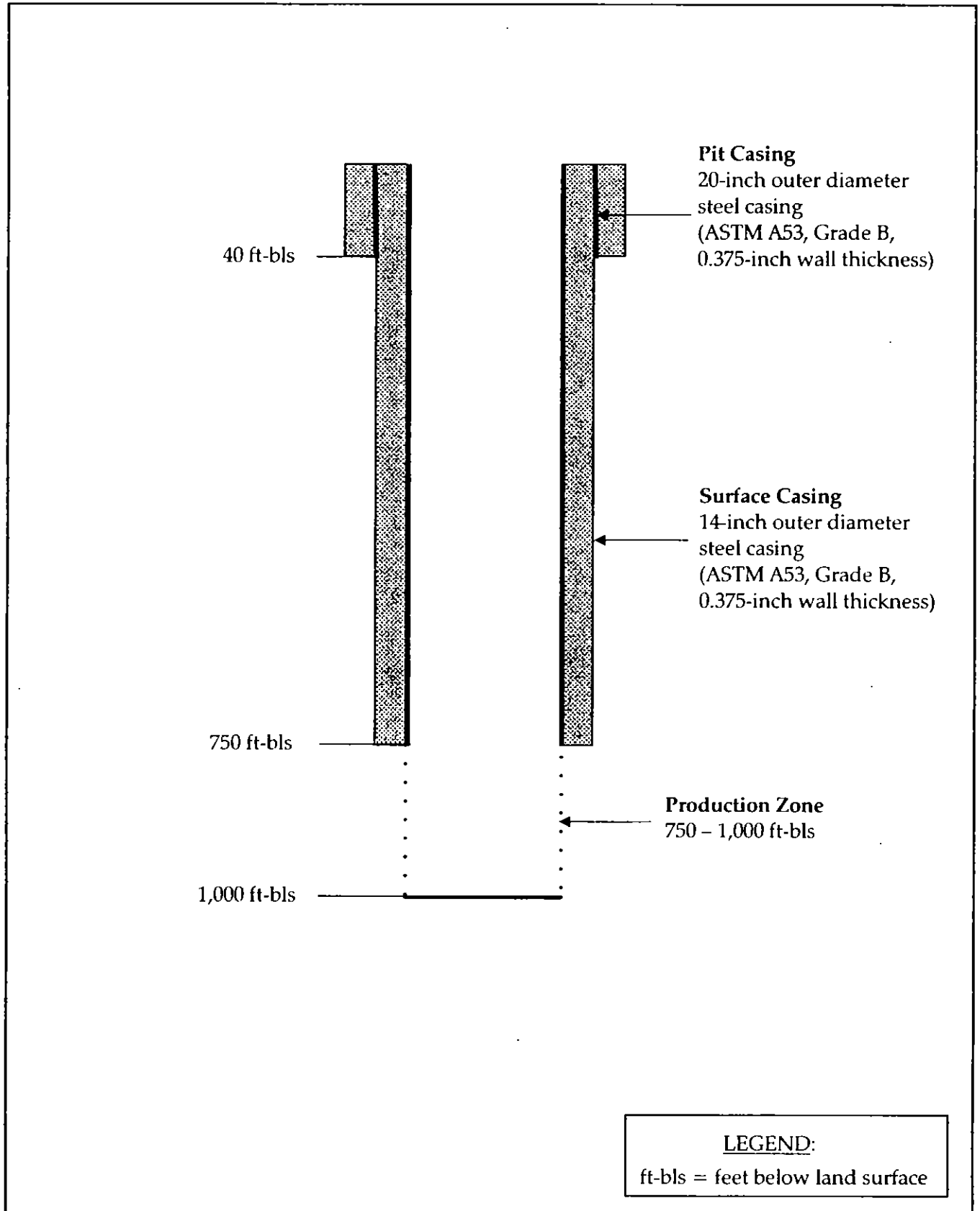

Figure 4.
Upper Floridan Aquifer Production Well
Construction Details (Typical)
FPL West County Energy Center, Palm Beach County, Florida
Source: Golder, 2005.



FDOT: Florida Department of Transportation, Sheauching Yu, Esq.

FDOT Comment 1: An engineering diagram of the access of the PBA road to State Road 80.

Response 1: Improvements to State Road 80 at PBA are already in place. These improvements have been previously approved by FDOT and constructed by Palm Beach Aggregates, Inc. (PBA). These improvements included west-bound and east-bound deceleration lanes for PBA trucks entering the property. PBA was also required to construct an east-bound acceleration lane for trucks leaving the property. PBA is required by Palm Beach County to maintain these improvements.

FDOT Comment 2: A description with accompanying engineering diagrams of proposed improvements necessary at that intersection to assure the safety of vehicles (especially trucks) turning in and out of the site.

Response 2: No additional improvements are warranted during operation. During construction, traffic control using traffic management specialist(s) or other safety measures designed in cooperation with FDOT will be used at the intersection of PBA Road and State Road 80 during the morning arrivals and afternoon departures of construction traffic (refer to SCA Subsection 4.6.2) when peak construction activity is occurring. During operation, the traffic impacts will be minimal since only about 20 employees will be working on shifts along with infrequent deliveries (refer to SCA Subsection 5.9.1).

FDOT Comment 3: A description with accompanying engineering diagrams of the water supply pipeline crossing of State Road 80 right of way.

Response 3: Attachment FDOT-3 provides two drawings of the water supply pipeline. An aerial diagram showing the inlet structure and underground piping is provided. Plan and section views show the dimensions and elevations of the piping. The piping will be installed using jack and bore construction techniques or similar technology. FPL will provide detailed construction drawings to FDOT for the inlet piping as a post-Certification condition.

ATTACHMENT FDOT-3

ENGINEERING DIAGRAMS

SHOWING WATER SUPPLY PIPELINE

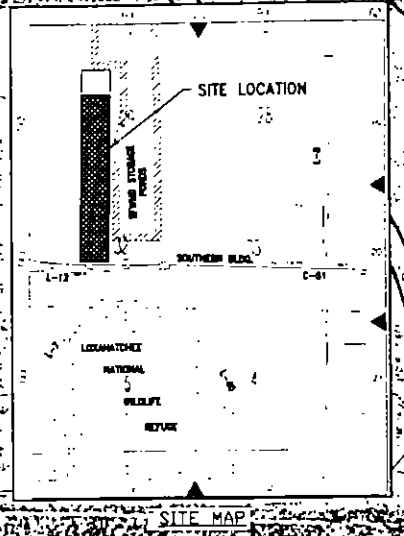
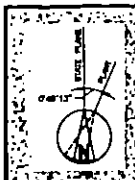

STATE ROAD 80

0 07-29-09 ISSUED FOR USE																					
REV	DATE	REVISION DESCRIPTION										GMG		TDJ	P						
		BY	CH	CON	APR	ORG															



SCALE	1"=100'	DISCIPLINE	CS	PLANT/UNIT	WCEC	
DRAWING SIZE	B(11"x17")	CAD FILE NAME	N/A	TITLE		
				AERIAL PHOTO WITH		
				INLET STRUCTURE & UNDERGROUND PIPING		
DRAWING NUMBER				WC-IS-001-A	SHEET	1 OF 1
					REV	0

NORTH SIDE OF CANAL
RIGHT OF WAY

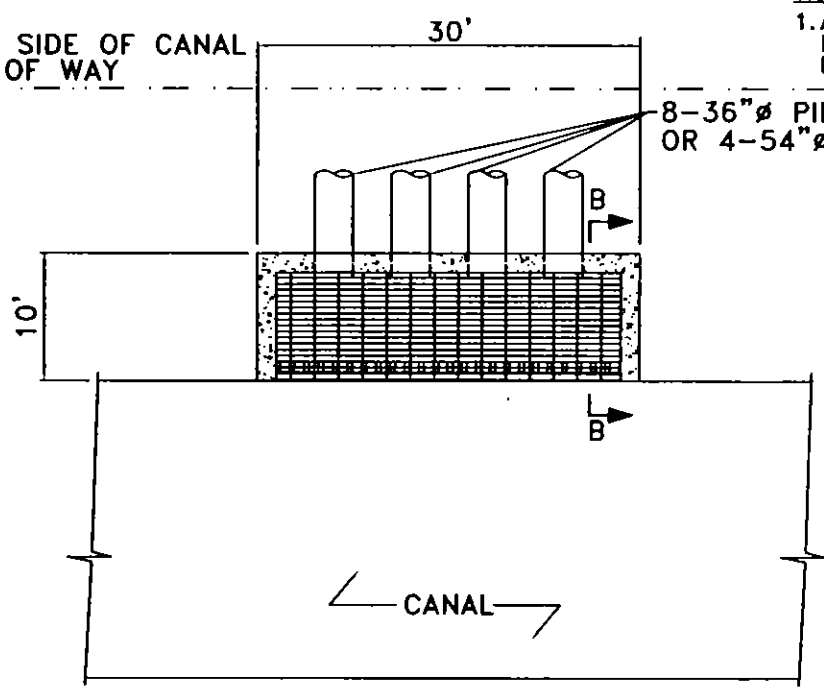

NOTES:
1. ACCESS TO STRUCTURE, COFFER
DAM STRUCTURE, & EROSION
DETAILS LATER.

PLAN VIEW ALTERNATE INLET STRUCTURE

NORTH SIDE OF CANAL
RIGHT OF WAY

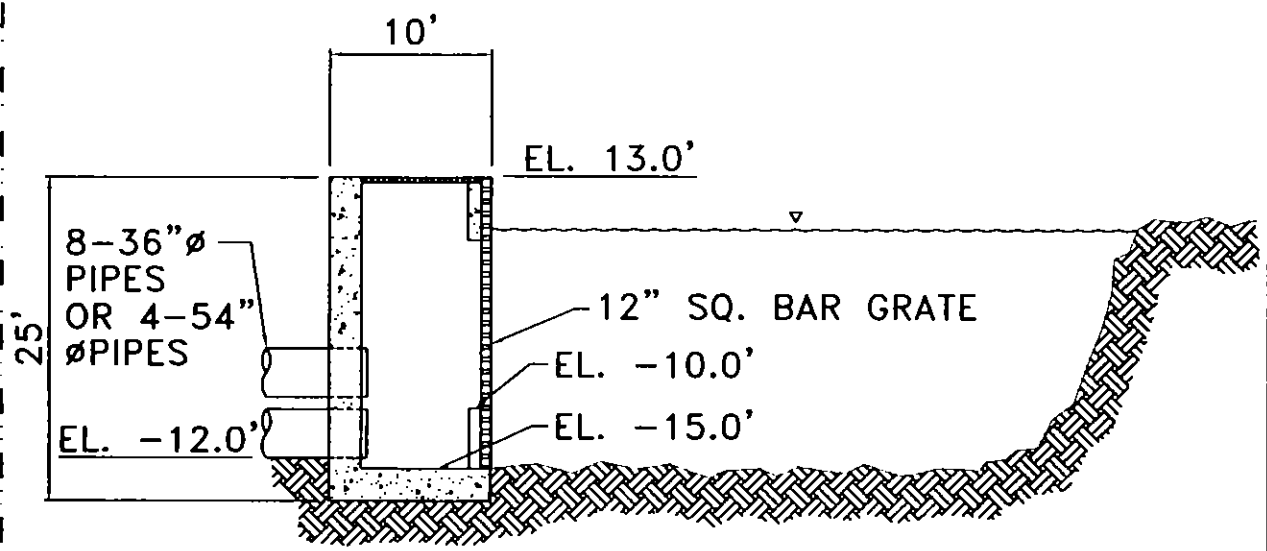

SECTION B-B

0 08/01/01/ISSUED FOR USE		CWC		TJL		PGD		DRAWING NUMBER		SYSTEM		DISCIPLINE		PLAN/AMT	
REV	DATE	BY	CH	COR	APR	ORG					N/A	CS	WCEC		
										SCALE		CWD FILE NAME		TITLE	
										NTS		S-05.DWG		ALTERNATE INLET STRUCTURE PLAN, SECTIONS & DETAILS	
										DRAWING SIZE		FPL ARCHIVE NAME			
										A (8.5X11)		N/A			
										SCA-006		SHEET		REV	
												1 OF 1		0	

FDHR: Florida Department of State, Division of Historical Resources, Frederick P. Gaske

FDHR Comment 1: Based on the information provided, it is the opinion of this office that the proposed project will have no effect on historic properties.

Response 1: Comment acknowledged.

FDHR Comment 2: However, if fortuitous finds or unexpected discoveries, such as prehistoric or historic artifacts, including pottery or ceramics, stone tools or metal implements, or other physical remains that could be associated with Native American cultures, or early colonial or American settlement are encountered at any time within the project site area, the project should cease all activities involving subsurface disturbance in the immediate vicinity of such discoveries. The applicant, or other designee, should contact the Florida Department of State, Division of Historical Resources, Review and Compliance Section at (850) 245-6333 or (800) 847-7278, as well as the appropriate permitting agency office. Project activities should not be resumed without verbal and/or written authorization from the Division of Historical Resources.

Response 2: Comment acknowledged.