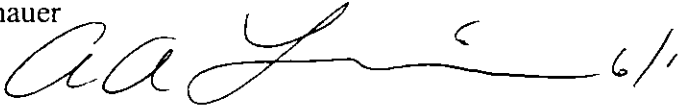

Memorandum

Florida Department of Environmental Protection

TO: Trina L. Vielhauer
FROM: A.A. Linero  6/15
DATE: June 15, 2006
SUBJECT: OUC Stanton Unit B – Nominal 285 MW coal-fueled ICC
DEP File No. 0950137-010-AC (PSD-FL-373, and PA 81-14SA3)

Attached is the draft permit package for OUC Stanton Unit B. The project consists of a nominal 285 MW coal-fueled integrated gasification combined cycle (IGCC) electric utility steam generating unit.

There are four large coal-fueled IGCC units in the world for electrical power service. This is the second coal-fueled IGCC in Florida and the first in the United States based on air-blown gasification of low rank subbituminous coal that comprises a great portion of the fossil fuel resources available in this country.

The applicant did not supply some information that would have been useful to me in my evaluation. However, the project is in the Front End Engineering and Design (FEED) phase and I believe the details will be forthcoming as FEED progresses. Given my experience in conducting BACT determinations, I was able to gather a great deal of information regarding the possibilities of pollution control for this important project.

While several of the BACT determinations are more stringent than proposed by the applicant, they are explained and buttressed in the accompanying technical evaluation. The project has several demonstration components including the gasifier, SCR, the oxidation catalyst that I included, and the Hg control systems for the proposed configuration. Therefore, I recommend using our authority under 403.061(18), F.S. to forego some of the final details prior to issuance of the draft permit. This will also provide time to stabilize the operation before applying the oxidation catalyst that I believe is cost-effective and necessary.

OUC's agreement to entirely offset NO_x emissions from Unit B by reduction from Units 1 and 2 will provide additional flexibility and the time to achieve applicant and DOE goals regarding the SCR demonstration that is required under the Cooperative Agreement with DOE.

Emission limits and details are neatly summarized in the attached public notice, the draft permit and further elaborated in the technical evaluation.

Modeled impacts on ambient air quality are minimal and below significant impact levels that would otherwise require detailed modeling. The forthcoming EIS under preparation by the Oak Ridge National Laboratory (ORNL) for DOE will address the impacts in a multi-disciplinary manner. The EIS will include the ESA consultation process with the Fish and Wildlife Service that typically falls on the coordinating federal government agency.

I recommend your approval of the attached package for public distribution.

AAL/aal

Attachments

P.E. CERTIFICATION STATEMENT

PERMITTEE

OUC/Southern Power Company-Orlando Gasification LLC
5100 South Alafaya Trail
Orlando, Florida 32831

Curtis H. Stanton Energy Center Unit B
DEP File No. 0950137-010-AC
Permit No. PSD-FL-373

PROJECT DESCRIPTION

Stanton Unit B will be fueled by synthetic gas (syngas) and/or natural gas. Subbituminous coal will be fed to an air-blown transport gasification system to produce syngas at high temperature and high pressure. The following additional components are included: a syngas cleanup system; a natural gas and syngas-fired General Electric 7FA+e combustion turbine-electrical generator (CT); a duct burner within a supplementary-fired heat recovery steam generator (HRSG); a steam turbine-electrical generator (STG); an exhaust stack; and a multi-point ground flare. The project is jointly funded by the United States Department of Energy Clean Coal Initiative II.

The high pressure and pre-combustion treatment of the syngas facilitates air pollution control by minimizing the volume of gas processed. The syngas cleanup system includes: high temperature and high pressure ash removal; ammonia removal and recovery for internal use or sale; mercury (Hg) removal through an activated carbon bed filter; and sulfur removal and recovery for sale.

Treatment during combustion includes diluent nitrogen (N₂) in the syngas to reduce NO_x and good combustion in the CT and duct burner to reduce CO and VOC. Post combustion treatment consists of demonstration of a selective catalytic reduction (SCR) for NO_x control. The Department's BACT determination requires the installation/demonstration of oxidation catalyst for further control of CO, VOC, and hazardous air pollutants (HAP). The Department also requires continuous emissions monitoring systems (CEMS) for NO_x, SO₂, CO and Hg.

OUC has agreed to a cap on NO_x emissions from Units 1 and 2 to permanently offset the maximum emissions of 1006 tons per year (TPY) from Unit B. Therefore a BACT determination for NO_x was not required. In my opinion, BACT for this project would have required NO_x emission limits of 2 and 5 ppmvd when firing natural gas and syngas respectively. The actual emissions from Unit B are expected to be less than the decrease from Units 1 and 2 and will be better known during and after the SCR demonstration.

The following table is a summary of emissions expected while operating Stanton Unit B. Values given in terms of parts per million by volume, dry are corrected to 15% oxygen (ppmvd @15%O₂).

Pollutant	Emissions (TPY)	Emission Limits (ppmvd)		Measurement Basis	Limit Basis
		Syngas	Natural Gas		
NO _x	-19 (net)	20 (24-hr)	5 (30-day)	CEMS	Avoid PSD
CO	128	4.1	4.1	24-hr CEMS	BACT
VOC	40	2.4	2.4	Stack Test	BACT
SO ₂	109	1.8 (24-hr)	2 gr S/100 scf	CEMS/fuel specification	BACT
NH ₃	~ 100 (slip)	5	5	Stack Test	Avoid Opacity
Opacity	--	10% Opacity		Visible Emissions (VE)	BACT
PM/PM ₁₀	< 189/179	Opacity, Comply w/CO, SO ₂		As Above	BACT
SAM	24	Opacity, Comply w/SO ₂		As Above	BACT
Hg	0.01	7.7 × 10 ⁻⁶ lb/MWH		12-month CEMS	<< NSPS Da

According to the applicant and as verified by the Department, maximum predicted air quality impacts due to worst case emissions from the proposed new project are less than the significant impact levels applicable to the PSD Class II areas (everywhere except the Chassahowitzka Wilderness Area) and the nearest PSD Class I Chassahowitzka National Wilderness Area. Therefore, multi-source (PSD Increment) modeling was not required. Based on the required analyses, the Department has reasonable assurance that the proposed project will not cause or contribute to a violation of any state or federal ambient air quality standard.

I HEREBY CERTIFY that the air pollution control engineering features described in the above referenced application and subject to the proposed permit conditions provide reasonable assurance of compliance with applicable provisions of Chapter 403, Florida Statutes, and Florida Administrative Code Chapters 62-4 and 62-204 through 62-297. However, I have not evaluated and I do not certify aspects of the proposal to conduct such a large scale-up of the gasifier(s) or other aspects outside of my area of expertise (including but not limited to the electrical, mechanical, structural, hydrological, and geological features). Note that less than the typical level of detail was required given the demonstration nature of the project. Per 403.061(18), F.S., my employer, the Florida DEP has the power and the duty to encourage and conduct studies, investigations, and research relating to pollution and its causes, effects, prevention, abatement, and control.

Alvaro A. Linero, P.E.

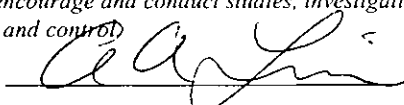

Date: June 15, 2006

Registration Number: 26032

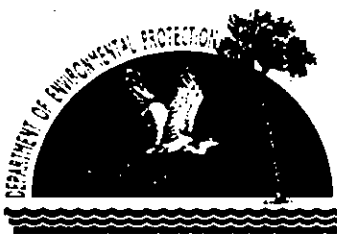

Department of Environmental Protection

Jeb Bush
Governor

Twin Towers Office Building
2600 Blair Stone Road
Tallahassee, Florida 32399-2400
Telephone: (850) 488-0114 FAX: (850) 922-6979

Colleen M. Castille
Secretary

June 16, 2006

CERTIFIED MAIL - RETURN RECEIPT REQUESTED

Mr. Frederick F. Haddad Jr., V.P. Power Resources
Orlando Utilities Commission (OUC)
Post Office Box 3193
Orlando, Florida 32802

Re: Curtis H. Stanton Energy Center Unit B
Integrated Coal Gasification and Combined Cycle
DEP File No. 0950137-010-AC (PSD-FL-373, PA 81-14SA3)

Dear Mr. Haddad:

Enclosed is the Department's preliminary determination to issue a permit pursuant to the rules for the Prevention of Significant Deterioration of Air Quality (PSD) to OUC and Southern Company – Orlando Gasification LLC to construct a nominal 285 megawatt integrated coal gasification and combined cycle unit at the Curtis H. Stanton Energy Center in Orange County. The documents include: the "Intent to Issue PSD Permit;" the "Public Notice of Intent to Issue PSD Permit;" the Department's "Technical Evaluation and Preliminary Determination" including a draft determination of Best Available Control Technology; and the Draft Permit.

The Public Notice must be published one time only in a newspaper of general circulation in the area affected, pursuant to Chapter 50, Florida Statutes. According to Paragraph 62-17.135(1)(c), F.A.C. the applicant shall have published the notice no later than 10 days (i.e. by May 22, 2006) after the preliminary determination has been issued.

Please submit any other written comments you wish to have considered concerning the Department's proposed action to Mr. Alvaro A. Linero, Program P.E., Administrator, South Permitting at the above letterhead address. If you have any questions, please call Debbie Nelson at 850/921-9537 (meteorologist), Cindy Mulkey at 850/921-8968 (review engineer) or Mr. Linero at 850/921-9523.

Sincerely,

Trina L. Vielhauer, Chief,
Bureau of Air Regulation

TLV/aal/cm

Enclosures

In the Matter of an
Application for Permit by:

OUC/Southern Power Company-Orlando Gasification LLC
5100 South Alafaya Trail
Orlando, Florida 32831

Authorized Representative:

Mr. Frederick F. Haddad, Jr., V.P. Power Resources

DEP File No. 0950137-010-AC
Draft Permit No. PSD-FL-373
Siting Case No. PA 81-14SA3
Curtis H. Stanton Energy Center Unit B
Integrated Gasification Combined Cycle
Orange County, Florida

INTENT TO ISSUE PSD PERMIT

The Department of Environmental Protection (Department) gives notice of its intent to issue a permit pursuant to the rules for the Prevention of Significant Deterioration of Air Quality (PSD Permit), copy of DRAFT Permit attached, for the proposed project as detailed in the application specified above and the attached Technical Evaluation and Preliminary Determination for the reasons stated below.

The applicant, Orlando Utilities Commission/Southern Power Company-Orlando Gasification LLC, applied on February 21, 2006 to the Department for a PSD permit to construct a nominal 285 megawatt coal-fueled integrated gasification combined cycle (IGCC) unit at the existing Curtis H. Stanton Energy Center near Orlando, Orange County.

The Department has permitting jurisdiction under the provisions of Chapter 403, Florida Statutes (F.S.), Florida Administrative Code (F.A.C.) Chapters 62-4, 62-210, and 62-212. Per 403.061(18), F.S., the Department has the power and the duty to encourage and conduct studies, investigations, and research relating to pollution and its causes, effects, prevention, abatement, and control. The above actions are not exempt from permitting procedures. The Department has determined that a PSD construction permit is required.

The Department intends to issue this PSD permit based on the belief that reasonable assurances have been provided to indicate that operation of these emissions units will not adversely impact air quality, and the emissions units will comply with all appropriate provisions of Chapters 62-4, 62-204, 62-210, 62-212, 62-296 and 62-297, F.A.C.

Pursuant to Section 403.815, F.S., and Rule 62-110.106(7)(a)1., F.A.C., you (the applicant) are required to publish at your own expense the enclosed Public Notice of Intent to Issue PSD Permit. The notice shall be published one time only in the legal advertisement section of a newspaper of general circulation in the area affected. Rule 62-110.106(7)(b), F.A.C., requires that the applicant cause the notice to be published as soon as possible after notification by the Department of its intended action. For the purpose of these rules, "publication in a newspaper of general circulation in the area affected" means publication in a newspaper meeting the requirements of Sections 50.011 and 50.031, F.S., in the county where the activity is to take place. If you are uncertain that a newspaper meets these requirements, please contact the Department at the address or telephone number listed below. The applicant shall provide proof of publication to the Department's Bureau of Air Regulation, at 2600 Blair Stone Road, Mail Station #5505, Tallahassee, Florida 32399-2400 (Telephone: 850/488-0114; Fax 850/ 922-6979). You must provide proof of publication within seven days of publication, pursuant to Rule 62-110.106(5), F.A.C. No permitting action for which published notice is required shall be granted until proof of publication of notice is made by furnishing a uniform affidavit in substantially the form prescribed in section 50.051, F.S. to the office of the Department issuing the permit. Failure to publish the notice and provide proof of publication may result in the denial of the permit pursuant to Rules 62-110.106(9) & (11), F.A.C.

The Department will issue the final permit with the attached conditions unless a response received in accordance with the following procedures results in a different decision or significant change of terms or conditions.

The Department will accept written comments and requests for public meetings concerning the proposed permit issuance action for a period of 30 (thirty) days from the date of publication of the enclosed Public Notice of Intent to Issue PSD Permit. Written comments should be provided to the Department's Bureau of Air Regulation at 2600 Blair Stone Road, Mail Station #5505, Tallahassee, FL 32399-2400. Any written comments filed shall be made available for public inspection. If comments received result in a significant change in the proposed agency action, the Department shall revise the proposed permit and require, if applicable, another Public Notice.

The Department will issue the permit with the attached conditions unless a timely petition for an administrative hearing is filed pursuant to sections 120.569 and 120.57 F.S., before the deadline for filing a petition. The procedures for petitioning for a hearing are set forth below.

This PSD permitting action is being coordinated with a certification under the Power Plant Siting Act (Sections 403.501-519, F.S.). If a petition for an administrative hearing on the Department's Intent to Issue is filed by a substantially affected person, that hearing shall be consolidated with the certification hearing, as provided under Section 403.507(3).

A person whose substantial interests are affected by the proposed permitting decision may petition for an administrative proceeding (hearing) under sections 120.569 and 120.57 of the Florida Statutes. The petition must contain the information set forth below and must be filed (received) in the Office of General Counsel of the Department at 3900 Commonwealth Boulevard, Mail Station #35, Tallahassee, Florida, 32399-3000. Petitions filed by the permit applicant or any of the parties listed below must be filed within fourteen days of receipt of this notice of intent. Petitions filed by any persons other than those entitled to written notice under section 120.60(3) of the Florida Statutes must be filed within fourteen days of publication of the public notice or within fourteen days of receipt of this notice of intent, whichever occurs first. Under section 120.60(3), however, any person who asked the Department for notice of agency action may file a petition within fourteen days of receipt of that notice, regardless of the date of publication. A petitioner shall mail a copy of the petition to the applicant at the address indicated above at the time of filing. The failure of any person to file a petition within the appropriate time period shall constitute a waiver of that person's right to request an administrative determination (hearing) under sections 120.569 and 120.57 F.S., or to intervene in this proceeding and participate as a party to it. Any subsequent intervention will be only at the approval of the presiding officer upon the filing of a motion in compliance with Rule 28-106.205 of the Florida Administrative Code.

A petition that disputes the material facts on which the Department's action is based must contain the following information: (a) The name and address of each agency affected and each agency's file or identification number, if known; (b) The name, address, and telephone number of the petitioner, the name, address, and telephone number of the petitioner's representative, if any, which shall be the address for service purposes during the course of the proceeding; and an explanation of how the petitioner's substantial interests will be affected by the agency determination; (c) A statement of how and when petitioner received notice of the agency action or proposed action; (d) A statement of all disputed issues of material fact. If there are none, the petition must so indicate; (e) A concise statement of the ultimate facts alleged, including the specific facts the petitioner contends warrant reversal or modification of the agency's proposed action; (f) A statement of the specific rules or statutes the petitioner contends require reversal or modification of the agency's proposed action; and (g) A statement of the relief sought by the petitioner, stating precisely the action petitioner wishes the agency to take with respect to the agency's proposed action.

A petition that does not dispute the material facts upon which the Department's action is based shall state that no such facts are in dispute and otherwise shall contain the same information as set forth above, as required by Rule 28-106.301.

Because the administrative hearing process is designed to formulate final agency action, the filing of a petition means that the Department's final action may be different from the position taken by it in this notice. Persons whose substantial interests will be affected by any such final decision of the Department on the application have the right to petition to become a party to the proceeding, in accordance with the requirements set forth above. Mediation is not available in this proceeding.

In addition to the above, a person subject to regulation has a right to apply for a variance from or waiver of the requirements of particular rules, on certain conditions, under Section 120.542 F.S. The relief provided by this state statute applies only to state rules, not statutes, and not to any federal regulatory requirements. Applying for a variance or waiver does not substitute or extend the time for filing a petition for an administrative hearing or exercising any other right that a person may have in relation to the action proposed in this notice of intent.

The application for a variance or waiver is made by filing a petition with the Office of General Counsel of the Department, 3900 Commonwealth Boulevard, Mail Station #35, Tallahassee, Florida 32399-3000. The petition must specify the following information: (a) The name, address, and telephone number of the petitioner; (b) The name, address, and telephone number of the attorney or qualified representative of the petitioner, if any; (c) Each rule or portion of a rule from which a variance or waiver is requested; (d) The citation to the statute underlying

(implemented by) the rule identified in (c) above; (e) The type of action requested; (f) The specific facts that would justify a variance or waiver for the petitioner; (g) The reason why the variance or waiver would serve the purposes of the underlying statute (implemented by the rule); and (h) A statement whether the variance or waiver is permanent or temporary and, if temporary, a statement of the dates showing the duration of the variance or waiver requested.

The Department will grant a variance or waiver when the petition demonstrates both that the application of the rule would create a substantial hardship or violate principles of fairness, as each of those terms is defined in Section 120.542(2) F.S., and that the purpose of the underlying statute will be or has been achieved by other means by the petitioner.

Persons subject to regulation pursuant to any federally delegated or approved air program should be aware that Florida is specifically not authorized to issue variances or waivers from any requirements of any such federally delegated or approved program. The requirements of the program remain fully enforceable by the Administrator of the EPA and by any person under the Clean Air Act unless and until the Administrator separately approves any variance or waiver in accordance with the procedures of the federal program.

Executed in Tallahassee, Florida.

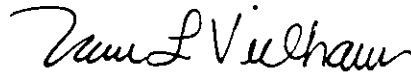

Trina L. Vielhauer, Chief
Bureau of Air Regulation

CERTIFICATE OF SERVICE

The undersigned duly designated deputy agency clerk hereby certifies that this Intent to Issue PSD Permit (including the Public Notice, Technical Evaluation and Preliminary Determination, and the DRAFT permit) was sent by certified mail (*) and copies were mailed by U.S. Mail or by electronic mail before the close of business on 6/16/06 to the persons listed:

Frederick F. Haddad, Fr., OUC*
Denise M. Stalls, OUC*
Mayor Buddy Dyer, Orlando*
Mayor Richard T. Crotty, Orange County*
Lori Cuniff, Orange County*
Gregg Worley, U.S. EPA Region 4, Atlanta GA
John Bunyak, National Park Service, Denver CO
Len Kozlov, DEP CD
Thomas W. Davis, P.E. ECT, Inc.
Hamilton Oven, DEP Siting Office

Clerk Stamp

FILING AND ACKNOWLEDGMENT FILED, on this date, pursuant to §120.52, Florida Statutes, with the designated Department Clerk, receipt of which is hereby acknowledged.

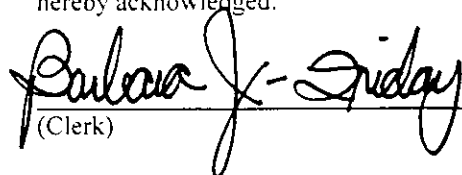
 6/16/06
(Clerk) (Date)

SENDER: COMPLETE THIS SECTION		COMPLETE THIS SECTION ON DELIVERY	
<ul style="list-style-type: none"> Complete items 1, 2, and 3. Also complete item 4 if Restricted Delivery is desired. Print your name and address on the reverse so that we can return the card to you. Attach this card to the back of the mailpiece, or on the front if space permits. 		A. Signature <input checked="" type="checkbox"/> <i>[Signature]</i> <input type="checkbox"/> Agent <input type="checkbox"/> Addressee	
1. Article Addressed to:		B. Received by (Printed Name) <i>William Sandoval</i>	
Mr. Frederick F. Haddad Jr., V.P. Power Resources Orlando Utilities Commission (OUC) Post Office Box 3193 Orlando, Florida 32802		C. Date of Delivery JUN 20 2006	
2. Article Number (Transfer from service label)		D. Is delivery address different from item 1? <input type="checkbox"/> Yes If YES, enter delivery address below: <input type="checkbox"/> No	
7000 1670 0013 3110 0314		3. Service Type <input checked="" type="checkbox"/> Certified Mail <input type="checkbox"/> Express Mail <input type="checkbox"/> Registered <input type="checkbox"/> Return Receipt for Merchandise <input type="checkbox"/> Insured Mail <input type="checkbox"/> C.O.D.	
PS Form 3811, February 2004		4. Restricted Delivery? (Extra Fee) <input type="checkbox"/> Yes	
Domestic Return Receipt		102595-02-M-1540	

U.S. Postal Service CERTIFIED MAIL RECEIPT (Domestic Mail Only; No Insurance Coverage Provided)	
OFFICIAL USE	
Postage \$	Postmark Here
Certified Fee	
Return Receipt Fee (Endorsement Required)	
Restricted Delivery Fee (Endorsement Required)	
Mr. Frederick F. Haddad Jr., V.P. Power Resources Orlando Utilities Commission (OUC) Post Office Box 3193 Orlando, Florida 32802	
PS Form 3800, May 2000 See Reverse for Instructions	

U.S. Postal Service CERTIFIED MAIL RECEIPT (Domestic Mail Only; No Insurance Coverage Provided)	
OFFICIAL USE	
Postage \$	Postmark Here
Certified Fee	
Return Receipt Fee (Endorsement Required)	
Restricted Delivery Fee (Endorsement Required)	
Mayor Buddy Dyer City of Orlando, Florida 400 S. Orange Avenue Post Office Box 4990 Orlando, Florida 32802-4990	
PS Form 3800, May 2000 See Reverse for Instructions	

SENDER: COMPLETE THIS SECTION		COMPLETE THIS SECTION ON DELIVERY	
<ul style="list-style-type: none"> Complete items 1, 2, and 3. Also complete item 4 if Restricted Delivery is desired. Print your name and address on the reverse so that we can return the card to you. Attach this card to the back of the mailpiece, or on the front if space permits. 		A. Signature <input checked="" type="checkbox"/> <i>[Signature]</i> <input type="checkbox"/> Agent <input type="checkbox"/> Addressee	
1. Article Addressed to:		B. Received by (Printed Name) <i>William Sandoval</i>	
Mayor Buddy Dyer City of Orlando, Florida 400 S. Orange Avenue Post Office Box 4990 Orlando, Florida 32802-4990		C. Date of Delivery JUN 20 2006	
2. Article Number (Transfer from service label)		D. Is delivery address different from item 1? <input type="checkbox"/> Yes If YES, enter delivery address below: <input type="checkbox"/> No	
7000 1670 0013 3110 0307		3. Service Type <input checked="" type="checkbox"/> Certified Mail <input type="checkbox"/> Express Mail <input type="checkbox"/> Registered <input type="checkbox"/> Return Receipt for Merchandise <input type="checkbox"/> Insured Mail <input type="checkbox"/> C.O.D.	
PS Form 3811, February 2004		4. Restricted Delivery? (Extra Fee) <input type="checkbox"/> Yes	
Domestic Return Receipt		102595-02-M-1540	

SENDER: COMPLETE THIS SECTION

- Complete items 1, 2, and 3. Also complete item 4 if Restricted Delivery is desired.
- Print your name and address on the reverse so that we can return the card to you.
- Attach this card to the back of the mailpiece, or on the front if space permits.

1. Article Addressed to:

Ms. Lori Cuniff, Manager
 Orange County
 Environmental Protection Division
 800 Mercy Drive, Suite 4
 Orlando, FL 32808

2. Article Number
 (Transfer from service label)

7000 1670 0013 3110 0291

PS Form 3811, February 2004

Domestic Return Receipt

102595-02-M-1540

COMPLETE THIS SECTION ON DELIVERY

A. Signature Agent
 Terrri Brunson Addressee

B. Received by (Printed Name) Agent
Terrri Brunson C. Date of Delivery Addressee
 6-28-06

D. Is delivery address different from item 1? Yes
 If YES, enter delivery address below: No

3. Service Type
 Certified Mail Express Mail
 Registered Return Receipt for Merchandise
 Insured Mail C.O.D.

4. Restricted Delivery? (Extra Fee) Yes

**U.S. Postal Service
 CERTIFIED MAIL RECEIPT**
 (Domestic Mail Only; No Insurance Coverage Provided)

Postage	\$	Postmark Here
Certified Fee		
Return Receipt Fee (Endorsement Required)		
Restricted Delivery Fee (Endorsement Required)		

1 Ms. Lori Cuniff, Manager
 Orange County
 Environmental Protection Division
 800 Mercy Drive, Suite 4
 Orlando, FL 32808

PS Form 3800, May 2000

See Reverse for Instructions

**U.S. Postal Service
 CERTIFIED MAIL RECEIPT**
 (Domestic Mail Only; No Insurance Coverage Provided)

Postage	\$	Postmark Here
Certified Fee		
Return Receipt Fee (Endorsement Required)		
Restricted Delivery Fee (Endorsement Required)		

Mayor Richard T. Crotty
 Orange County, Florida
 201 S. Rosalind Ave., 5th Floor
 Orlando, FL 32801

PS Form 3800, May 2000

See Reverse for Instructions

SENDER: COMPLETE THIS SECTION

- Complete items 1, 2, and 3. Also complete item 4 if Restricted Delivery is desired.
- Print your name and address on the reverse so that we can return the card to you.
- Attach this card to the back of the mailpiece, or on the front if space permits.

1. Article Addressed to:

Mayor Richard T. Crotty
 Orange County, Florida
 201 S. Rosalind Ave., 5th Floor
 Orlando, FL 32801

2. Article Number
 (Transfer from service label)

7000 1670 0013 3110 0284

PS Form 3811, February 2004

Domestic Return Receipt

102595-02-M-1540

COMPLETE THIS SECTION ON DELIVERY

A. Signature Agent
 R. Crotty Addressee

B. Received by (Printed Name) Agent
R. Crotty C. Date of Delivery Addressee

D. Is delivery address different from item 1? Yes
 If YES, enter delivery address below: No

JUN 20 2006

3. Service Type
 Certified Mail Express Mail
 Registered Return Receipt for Merchandise
 Insured Mail C.O.D.

4. Restricted Delivery? (Extra Fee) Yes

SENDER: COMPLETE THIS SECTION	COMPLETE THIS SECTION ON DELIVERY
<ul style="list-style-type: none"> Complete items 1, 2, and 3. Also complete item 4 if Restricted Delivery is desired. Print your name and address on the reverse so that we can return the card to you. Attach this card to the back of the mailpiece, or on the front if space permits. 	<p>A. Signature X <i>Neil Lopez</i> <input type="checkbox"/> Agent <input type="checkbox"/> Addressee</p> <p>B. Received by (Printed Name) _____ C. Date of Delivery JUN 20 2005</p> <p>D. Is delivery address different from item 1? <input type="checkbox"/> Yes If YES, enter delivery address below: <input type="checkbox"/> No</p>
<p>1. Article Addressed to:</p> <p>Ms. Denise M. Stalls, V.P. Environmental Affairs Orlando Utilities Commission (OUC) Post Office Box 3193 Orlando, Florida 32802</p>	<p>3. Service Type <input checked="" type="checkbox"/> Certified Mail <input type="checkbox"/> Express Mail <input type="checkbox"/> Registered <input type="checkbox"/> Return Receipt for Merchandise <input type="checkbox"/> Insured Mail <input type="checkbox"/> C.O.D.</p> <p>4. Restricted Delivery? (Extra Fee) <input type="checkbox"/> Yes</p>
<p>2. Article Number (Transfer from service label) 7000 1670 0013 3110 0321</p>	
PS Form 3811, February 2004	Domestic Return Receipt
	102595-02-M-1540

U.S. Postal Service
CERTIFIED MAIL RECEIPT
(Domestic Mail Only; No Insurance Coverage Provided)

7000 1670 0013 3110 0321

Postage	\$	Postmark Here
Certified Fee		
Return Receipt Fee (Endorsement Required)		
Restricted Delivery Fee (Endorsement Required)		

1	Ms. Denise M. Stalls, V.P.
Se	Environmental Affairs
St	Orlando Utilities Commission (OUC)
Cit	Post Office Box 3193
	Orlando, Florida 32802

PS Form 3800, May 2000
See Reverse for Instructions

PUBLIC NOTICE OF INTENT TO ISSUE PSD PERMIT

STATE OF FLORIDA
DEPARTMENT OF ENVIRONMENTAL PROTECTION
DEP File No. 0950137-010-AC, PSD-FL-373, and PA 81-14SA3

OUC Curtis H. Stanton Energy Center Unit B
Integrated Gasification Combined Cycle

Orange County

The Department of Environmental Protection (Department) gives notice of its intent to issue a permit under the requirements for the Prevention of Significant Deterioration (PSD Permit) of Air Quality to Orlando Utilities Commission/Southern Power Company-Orlando Gasification LLC (OUC/SPS-OG). The permit is to construct a nominal 285 megawatt (MW) coal-fueled integrated gasification combined cycle (IGCC) to be known as Unit B at the Curtis H. Stanton Energy Center near Orlando, Orange County. A Best Available Control Technology (BACT) determination was required for emissions of carbon monoxide (CO), particulate matter (PM/PM₁₀), sulfur dioxide (SO₂), sulfuric acid mist (SAM), and volatile organic compounds (VOC) pursuant to Rule 62-212.400(10)(c), Florida Administrative Code (F.A.C.). The applicant's name and address are Orlando Utilities Commission/Southern Power Company-Orlando Gasification LLC 5100 South Alafaya Trail, Orlando, Florida 32831.

Stanton Unit B will be fueled by synthetic gas (syngas) and/or natural gas. Subbituminous coal will be fed to an air-blown transport gasification system to produce syngas at high temperature and high pressure. The following additional components are included: a syngas cleanup system; a natural gas and syngas-fired General Electric 7FA+e combustion turbine-electrical generator (CT); a duct burner within a supplementary-fired heat recovery steam generator (HRSG); a steam turbine-electrical generator (STG); an exhaust stack; and a multi-point ground flare.

The project was selected by the Department of Energy for funding under Round 2 of the Clean Coal Power Initiative. There are four large coal-fueled IGCC units in the world for electrical power service. This is the second coal-fueled IGCC in Florida and the first in the United States based on air-blown gasification of low rank subbituminous coal that comprises a great portion of the fossil fuel resources available in this country. Per 403.061(18), F.S., the Department has the power and the duty to encourage and conduct studies, investigations, and research relating to pollution and its causes, effects, prevention, abatement, and control.

The high pressure and pre-combustion treatment of the syngas facilitates air pollution control by minimizing the volume of gas processed. The syngas cleanup system includes: high temperature and high pressure ash removal; ammonia removal and recovery for internal use or sale; mercury (Hg) removal through an activated carbon bed filter; and sulfur removal and recovery for sale.

Treatment during combustion includes diluent nitrogen (N₂) in the syngas to reduce NO_x and good combustion in the CT and duct burner to reduce CO and VOC. Post combustion treatment consists of demonstration of a selective catalytic reduction (SCR) for NO_x control. The Department's BACT determination requires the installation/demonstration of oxidation catalyst for further control of CO, VOC, and hazardous air pollutants (HAP). The Department also requires continuous emissions monitoring systems (CEMS) for NO_x, SO₂, CO and Hg.

The applicant, OUC/SPS-OG, voluntarily proposed an Hg limit of 7.7×10^{-6} pounds per megawatt-hour (lb/MWH). The value is 36% of the recently promulgated federal requirement of 20×10^{-6} lb/MWH for coal-fueled IGCC units under 40CFR60, Subpart Da — Standards of Performance for Electric Utility Steam Generating Units. The Department has evaluated the proposed carbon adsorption technology and believes that emissions will be significantly less than estimated.

OUC has agreed to a cap on NO_x emissions from Units 1 and 2 to permanently offset the maximum emissions of 1006 tons per year (TPY) from Unit B. Therefore a BACT determination for NO_x was not required for the project. The actual emissions from Unit B will be less than the decrease from Units 1 and 2 and will be more precisely known during and after the SCR demonstration on Unit B.

The following table is a summary of the maximum emissions expected from Stanton Unit B when burning syngas or natural gas and with the natural gas-fired duct burner in operation. Values given in terms of parts per million by volume, dry are corrected to 15% oxygen (ppmvd @15%O₂).

Pollutant	Emissions (TPY)	Emission Limits (ppmvd)		Measurement Basis	Limit Basis
		Syngas	Natural Gas		
NO _x	-19 (net)	20 (24-hr)	5 (30-day)	CEMS	Avoid PSD
CO	128	4.1	4.1	24-hr CEMS	BACT
VOC	40	2.4	2.4	Stack Test	BACT
SO ₂	109	1.8 (24-hr)	2 gr S/100 scf	CEMS/fuel spec	BACT
NH ₃	< 100 (slip)	5	5	Stack Test	Avoid Opacity
Opacity	--	10% Opacity		Visible Emissions (VE)	BACT
PM/PM ₁₀	< 189/179	Opacity, Comply w/CO, SO ₂		As Above	BACT
SAM	24	Opacity, Comply w/SO ₂		As Above	BACT
Hg	0.01	7.7 × 10 ⁻⁶ lb/MWH		12-month CEMS	<< NSPS Da

According to the applicant and as verified by the Department, maximum predicted air quality impacts due to worst case emissions from the proposed new project are less than the significant impact levels applicable to all PSD Class I and II areas and including the nearest PSD Class I Chassahowitzka National Wilderness Area. Therefore, multi-source (PSD Increment) modeling was not required. Based on the required analyses, the Department has reasonable assurance that the proposed project will not cause or contribute to a violation of any state or federal ambient air quality standard.

The Department will issue the FINAL Permit, in accordance with the conditions of the DRAFT Permit, unless a response received in accordance with the following procedures results in a different decision or significant change of terms or conditions.

The Department will accept written comments and requests for a public meeting concerning the proposed permit issuance action for a period of 30 (thirty) days from the date of publication of this Public Notice of Intent to Issue PSD Permit. Written comments or requests for public meetings should be provided to the Department's Bureau of Air Regulation at 2600 Blair Stone Road, Mail Station #5505, Tallahassee, FL 32399-2400 or the e-mail address provided below. Any written comments filed shall be made available for public inspection. If comments received result in a significant change in the proposed agency action, the Department shall revise the proposed permit and require, if applicable, another Public Notice.

The Department will issue the permit with the attached conditions unless a timely petition for an administrative hearing is filed pursuant to Sections 120.569 and 120.57 F.S., before the deadline for filing a petition. The procedures for petitioning for a hearing are set forth below. This PSD permitting action is being coordinated with a certification under the Power Plant Siting Act (Sections 403.501-519, F.S.). If a petition for an administrative hearing on the Department's Intent to Issue is filed by a substantially affected person, that hearing shall be consolidated with the certification hearing, as provided under Section 403.507(3). Mediation is not available in this proceeding.

A person whose substantial interests are affected by the proposed permitting decision may petition for an administrative proceeding (hearing) under sections 120.569 and 120.57 of the Florida Statutes. The petition must contain the information set forth below and must be filed (received) in the Office of General Counsel of the Department at 3900 Commonwealth Boulevard, Mail Station #35, Tallahassee, Florida, 32399-3000. Petitions filed by the permit applicant or any of the parties listed below must be filed within fourteen (14) days of receipt of this notice of intent. Petitions filed by any persons other than those entitled to written notice under section 120.60(3) of the Florida Statutes must be filed within fourteen days of publication of the public notice or within fourteen (14) days of receipt of this notice of intent, whichever occurs first. Under section 120.60(3), however, any person who asked the Department for notice of agency action may file a petition within fourteen days of receipt of that notice, regardless of the date of publication. A petitioner shall mail a copy of the petition to the applicant at the address indicated above at the time of filing. The failure of any person to file a petition within the appropriate time period shall constitute a waiver of that person's right to request an administrative determination (hearing) under sections 120.569 and 120.57 F.S., or to intervene in this proceeding and participate as a party to it. Any subsequent intervention will be only at the approval of the presiding officer upon the filing of a motion in compliance with Rule 28-106.205 of the Florida Administrative Code.

A petition that disputes the material facts on which the Department's action is based must contain the following information: (a) The name and address of each agency affected and each agency's file or identification number, if known; (b) The name, address, and telephone number of the petitioner, the name, address, and telephone number of the petitioner's representative, if any, which shall be the address for service purposes during the course of the proceeding; and an explanation of how the petitioner's substantial interests will be affected by the agency determination; (c) A statement of how and when petitioner received notice of the agency action or proposed action; (d) A statement of all disputed issues of material fact. If there are none, the petition must so indicate; (e) A concise statement of the ultimate facts alleged, including the specific facts the petitioner contends warrant reversal or modification of the agency's proposed action; (f) A statement of the specific rules or statutes the petitioner contends require reversal or modification of the agency's proposed action; and (g) A statement of the relief sought by the petitioner, stating precisely the action petitioner wishes the agency to take with respect to the agency's proposed action.

A petition that does not dispute the material facts upon which the Department's action is based shall state that no such facts are in dispute and otherwise shall contain the same information as set forth above, as required by Rule 28-106.301, F.A.C. Because the administrative hearing process is designed to formulate final agency action, the filing of a petition means that the Department's final action may be different from the position taken by it in this notice. Persons whose substantial interests will be affected by any such final decision of the Department on the application have the right to petition to become a party to the proceeding, in accordance with the requirements set forth above.

A complete project file is available for public inspection during normal business hours, 8:00 a.m. to 5:00 p.m., Monday through Friday, except legal holidays, at:

Department of Environmental Protection
Bureau of Air Regulation
111 S. Magnolia Drive, Suite 4
Tallahassee, Florida, 32301
Telephone: 850/488-0114
Fax: 850/922-6979

Department of Environmental Protection
Central District Office
3319 Maguire Boulevard, Suite 232
Orlando, Florida 32803-3767
Telephone: 407/894-7555
Fax: 407/897-2966

The complete project file includes the application, technical evaluations, Draft Permit, and the information submitted by the responsible official, exclusive of confidential records under Section 403.111, F.S. Interested persons may contact Alvaro A. Linero, P.E., Program Administrator, South Permitting Section, Bureau of Air Regulation at: alvaro.linero@dep.state.fl.us and at 850/921-9523 or call 850/488-0114 for additional information. The application, key correspondence, draft permit and technical evaluation can be accessed at: www.dep.state.fl.us/Air/permitting/construction/oucsouthern.htm

**TECHNICAL EVALUATION
AND
PRELIMINARY DETERMINATION**

OUC & Southern Power Company – Orlando Gasification, LLC
Curtis H. Stanton Energy Center Unit B

285-Megawatt Integrated Gasification Combined Cycle

Orange County

DEP File No. 0950137-010-AC
PSD-FL-373, PA 81-14SA3



Florida Department of Environmental Protection
Division of Air Resource Management
Bureau of Air Regulation
Permitting South

June 16, 2006

1. APPLICATION INFORMATION

1.1. Applicant Name and Address

Orlando Utilities Commission (OUC) and
Southern Power Company – Orlando Gasification LLC
c/o OUC
Post Office Box 3193
Orlando, Florida 32802

Authorized Representative: Frederick F. Haddad, Jr., V.P. Power Resources

1.2. Processing Schedule

February 17, 2006: Received Site Certification Application (SCA) including PSD application.
April 5, 2006: Sent Sufficiency Issues to DEP Siting Coordination Office (SCO).
April 10, 2006: SCA determined to be Insufficient by SCO.
May 8, 2006: Received Sufficiency Responses from Applicant.
May 26, 2006: Sent Status Letter on Sufficiency Responses.
June 16, 2006: Intent to Issue PSD Permit distributed.

1.3. Facility Location

The Orlando Utilities Commission Curtis H. Stanton Energy Center (OUC Stanton Energy Center) is located in Orange County, Southeast of Orlando and North of Highway 528 at 5100 South Alafaya Trail. The OUC Stanton Energy Center presently consists of two fossil fuel-fired steam electrical generating units and a combined cycle unit. Fossil fuel-fired steam electric generating Units 1 and 2 (468 MW each) began operation in 1987 and 1996 while Combined Cycle Unit A (640 MW) began operation in 2003.

The site is located 144 km southeast from the Chassahowitzka National Wildlife Area; the nearest Federal Prevention of Significant Deterioration (PSD) Class I Area. The UTM coordinates for this site are 483.6 km East and 3151.1 North. The location of the OUC Stanton Energy Center is shown in Figure 1.

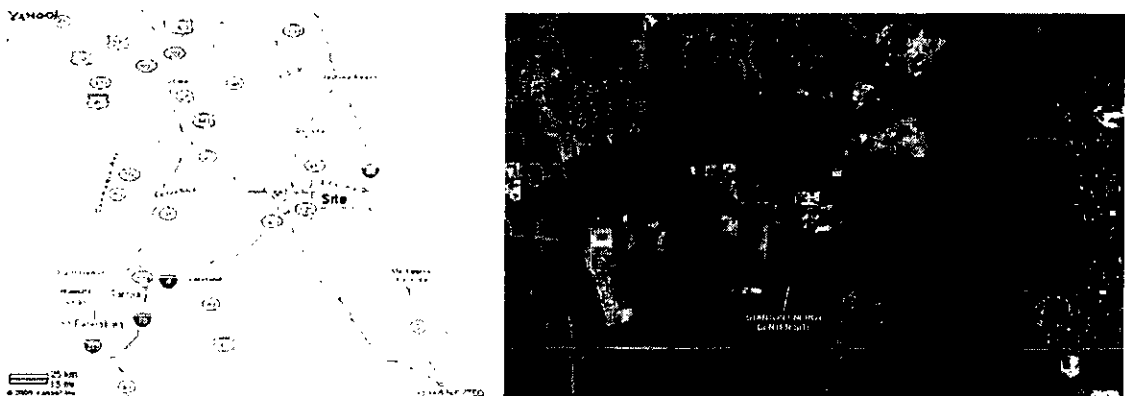

Figure 1. Project Location near Orlando and Aerial View OUC Stanton Energy Center

1.4. Regulatory Categories

Section 111, Clean Air Act, Standards of Performance for New Stationary Sources

The proposed project is subject to:

- 40CFR60, Subpart Da - Standards of Performance for Electric Utility Steam Generating Units for Which Construction is Commenced After September 18, 1978;
- 40CFR60, Subpart KKKK - Standards of Performance for Stationary Combustion Turbines. The draft rule was published February 17, 2005 and has not yet been finalized as of June 16, 2006;
- 40CFR60, Subpart GG - Standards of Performance for Stationary Gas Turbines (until Subpart KKKK is finalized); and
- 40CFR60, Subpart Y - Standards of Performance for Coal Preparation Plants.

Section 112, Clean Air Act, Hazardous Air Pollutants (HAP)

The existing facility is a major source of HAP. The new unit is potentially subject to 40 CFR63, Subpart YYYY - National Emission Standards for Hazardous Air Pollutants for Stationary Combustion Turbines. The applicability of this rule has been stayed for lean premix and diffusion flame gas-fired combustion turbines such as planned for this project.

Title IV, Clean Air Act, Acid Rain Provisions

The facility operates units subject to the Acid Rain provisions of the Clean Air Act.

Title V, Clean Air Act, Permits

The facility is a Title V or "Major Source" of air pollution because the potential emissions of at least one regulated pollutant exceed 100 tons per year or because it is a Major Source of HAP. Regulated pollutants include pollutants such as carbon monoxide (CO), nitrogen oxides (NO_x), particulate matter (PM/PM₁₀), sulfur dioxide (SO₂), and volatile organic compounds (VOC).

Part C, Clean Air Act, Prevention of Significant Deterioration (PSD)

The facility is located in an area that is designated as "attainment", "maintenance", or "unclassifiable" for each pollutant subject to a National Ambient Air Quality Standard. The facility is classified as a "Fossil fuel-fired steam electric plants of more than 250 million British thermal units per hour heat input", which is one of the facility categories with the PSD applicability threshold of 100 tons per year (TPY). Potential emissions of at least one regulated pollutant exceed 100 TPY per year, therefore the facility is classified as a "Major Stationary Source" with respect to Rule 62-212.400 F.A.C.

Siting

The facility was originally certified pursuant to the power plant siting provisions of Chapter 62-17, F.A.C.

Section 403.061(18). The department has the power and the duty to encourage and conduct studies, investigations, and research relating to pollution and its causes, effects, prevention, abatement, and control. Besides serving the power generating need of a municipal utility, the project is the first demonstration of an air-blown integrated gasification combined cycle (IGCC) with a coal-based transport gasifier. It is also the first coal-fueled IGCC project in the United States to demonstrate selective catalytic reduction (SCR) for nitrogen oxides control.

2. PROPOSED PROJECT SUMMARY

2.1. Project Description

The applicant proposes to construct a nominal 285 Megawatt (net) Integrated Gasification and Combined Cycle (IGCC) Unit (Stanton Unit B) and auxiliary equipment. Unit B will consist of: an air-blown coal gasification system that produces synthetic gas (syngas); one syngas and natural gas-fired General Electric 7FA+e combustion turbine-electrical generator (CT); a duct burner within a supplementary-fired heat recovery steam generator (HRSG); a steam turbine-electrical generator (STG); an exhaust stack and a multi-point ground flare.

The project was selected by the Department of Energy for funding under Round 2 of the Clean Coal Power Initiative. According to information from DOE, the total project cost was estimated at \$557,000,000 of which DOE will provide \$235,000,000.

Additional equipment will be included to accomplish:

- coal preparation and feeding equipment;
- process air compression and feed to the gasification system;
- syngas cooling and heat recovery;
- particulate collection; sulfur removal and recovery;
- sour water treatment and ammonia recovery;

Additional project details, as proposed, are described below.

The existing Stanton Coal-fired units and coal storage are seen in the photograph on the left hand side of the following figure. On the right hand side is an artist rendition of the planned Stanton Unit B. The gasification equipment is in the foreground. The associated CT/HRSG arrangement is in front of the two CT/HRSG's that comprise Unit A.

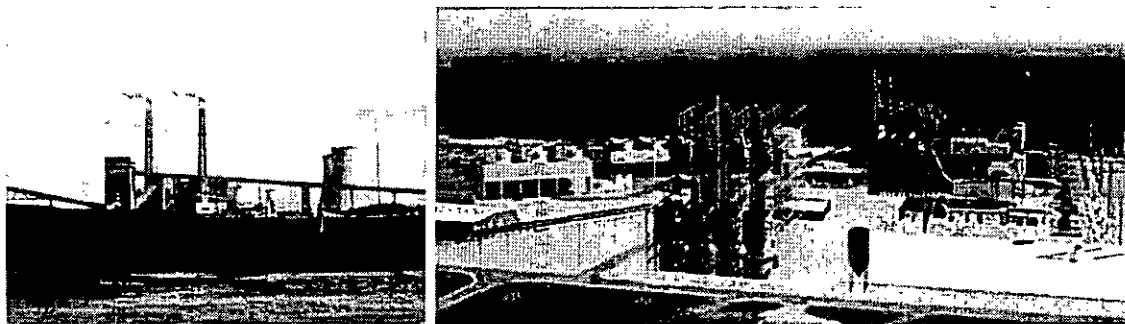

Figure 2. Coal-fired Units 1 & 2 Artist Rendition of Proposed Stanton Unit B.

2.2. Additional Project Features

Fuel

Stanton B will use sub-bituminous coal (typically from the Powder River Basin) or natural gas for up to 8760 hours per year. Though not limited, natural gas will typically be used as startup and backup fuel for the combustion turbines and at any time for the duct burners within the HRSG.

TECHNICAL EVALUATION AND PRELIMINARY DETERMINATION

Generating Capacity

Unit B will have a nominal electrical generating capacity of 285 MW (net) when firing syngas and 310 MW when firing natural gas (duct burners operational).

Air Pollution Controls

- Sulfur dioxide will be limited by use of low sulfur Powder River Basin (PRB) coal, removal of reduced sulfur compounds from the syngas, and recovery of sulfur.
- Particulate matter will be removed from the syngas using high temperature/high pressure (HTHP) filtration. The resultant ash will be sold or disposed.
- Mercury (Hg) will be removed from the syngas in sulfur-impregnated activated carbon beds.
- Nitrogen oxides (NO_x) formation is limited by: removal reduced nitrogen compounds and recovery of ammonia (NH₃) prior to combustion; presence of diluent atmospheric nitrogen (N₂) during combustion; and selective catalytic reduction (SCR) by NH₃ injection following combustion.
- Carbon monoxide (CO) and volatile organic compounds (VOC) will be controlled by high temperature combustion and the Department will require installation of oxidation catalyst.
- Continuous emission monitoring systems (CEMS) will be required for NO_x, SO₂, CO, Hg.

Stack Parameters

The HRSG will have an exhaust stack approximately 205 feet tall and with an exit diameter of 18.5 feet. The following table summarizes the exhaust characteristics at 100 % load and with duct burners on.

Table 1. Exhaust Characteristics of Unit B at 100% Load and Reference Temperature

<u>Fuel</u>	<u>Nominal Heat Input (mmBtu, HHV)</u>	<u>Ref. Ambient Temp., °F</u>	<u>CT Exhaust Temp., °F</u>	<u>Stack Exit Temp., °F</u>	<u>Stack Flow ACFM</u>
CT (Natural Gas)	1,940	20 °F	~1100 °F	194 °F	1,162,800
CT (Coal Syngas)	2,384 ^b	20 °F	~1100 °F	190 °F	1,058,400
DB+NG on CT	2,421	20 °F	~1100 °F	186 °F	1,158,400
DB+Syngas on CT	2,865	70 °F	~1100 °F	191 °F	1,089,800

a. Duct burner (DB) in HRSG will fire only natural gas and operate only in conjunction with CT operation.

3. PROCESS DESCRIPTION

3.1. Principle

IGCC involves the incomplete combustion of fuel or residues in a reducing atmosphere and then combustion of the resultant gas (syngas) in an oxidizing atmosphere with associated heat recovery, chemical production, steam generation, and electrical power production. The term “integrated” relates to varying degrees of interchange of air, steam, condensate, feed water, fuel, electricity, etc. between the key gasification step and the combined cycle (CT/HRSG/STG). [Greater] “integration means recovery of the waste energy available, improvement of the efficiency and, where possible, reduction of the investment cost.”¹

3.2. Gasifier

This project is the large-scale demonstration of an air-blown “Transport Gasifier” in a subbituminous coal-fueled IGCC process. The KBR Transport Gasifier consists of two sections; a short, larger-diameter mixing zone and a longer, smaller diameter riser.

The process flow diagram on the right-hand side of the figure below is from a recent DOE presentation describing their preliminary financial support of the demonstration project.² The diagram on the left-hand side is from a DOE paper describing the operation of the pilot scale transport gasifier at the Power Systems Development Facility (PSDF) in Wilsonville, Alabama.³ For reference, the gasifier was also tested as an oxygen (O₂)-blown gasifier which is why that option is included in the Transport Gasifier diagram.

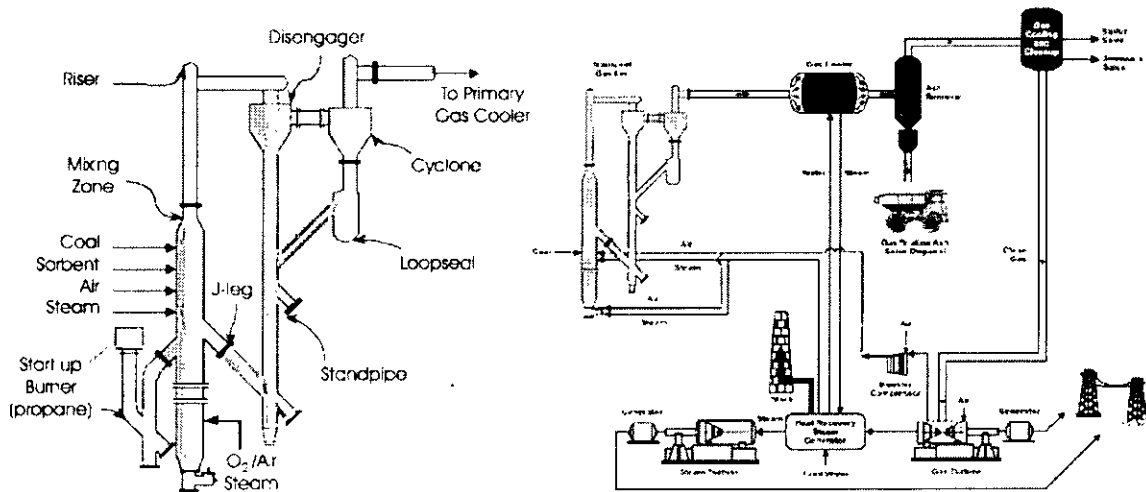
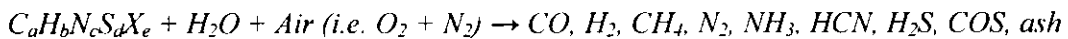

Figure 3. Transport Gasifier and IGCC Process Flow Diagram using Transport Gasifier

PRB coal is reclaimed, crushed, dried, milled, and fed in a dry state (as opposed to slurry) to one or more gasifiers. A multi-staged, intercooled process air compressor (PAC) provides most of the air required by the gasifier. The remainder of the needed air is extracted from the combustion turbine (CT) compressor, cooled and added “interstage” to the PAC. This is an example of integration and is further discussed in the section on CT operation below.

Air is introduced to partially fluidize the bed of coal in the mixing zone and to partially combust it. Steam is required for the partial combustion and conversion to the syngas that is ultimately cleaned and burned in the CT. The partial combustion and gasification proceeds as follows:

Equation 1: The products of partial coal combustion in a gasifier (reducing atmosphere) are:



The subscripts (a, b, etc.) on the left are variable depending on the type of coal. “X” represents miscellaneous species. The proposed air blown gasification process operates at lower temperature (~ 1700 - 1900°F) and is non-slugging compared with higher temperature air-blown or O₂-blown processes.

TECHNICAL EVALUATION AND PRELIMINARY DETERMINATION

Within the extreme reducing conditions in a gasifier, fuel-nitrogen is converted to NH_3 and HCN. The NH_3 concentration in the exit syngas appears to depend on the time-temperature history of the gas in the gasifier.⁴ Longer residence time at high temperature (~1,850 °F or greater) favors removal of NH_3 by:

Equation 2. Thermal decomposition of NH_3 is described by the following global equation:

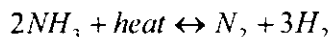

The relatively low operating temperature of the Transport Gasifier results in less NH_3 decomposition compared with higher temperature gasifiers, other factors being equal. As discussed in subsequent sections, this provides more NH_3 for recovery and sale, but can provide more NH_3 to the CT where it can be converted to NO_x .

The process operates below the ash fusion temperatures and is non-slugging. Most of the entrained gasification ash leaving the riser is captured by a disengager and cyclone assembly and recycled back to the gasifier through a standpipe and a non-mechanical "J-valve". This increases the effective solids residence time increasing the carbon conversion.

Gasification is carried out at high pressure. This reduces the syngas volume to a fraction of normal volumes (though not as low as O_2 -blown gasifiers) thus facilitating subsequent processing cleanup. The following process flow block diagram taken from the previously mentioned DOE presentation is useful in the following discussion.

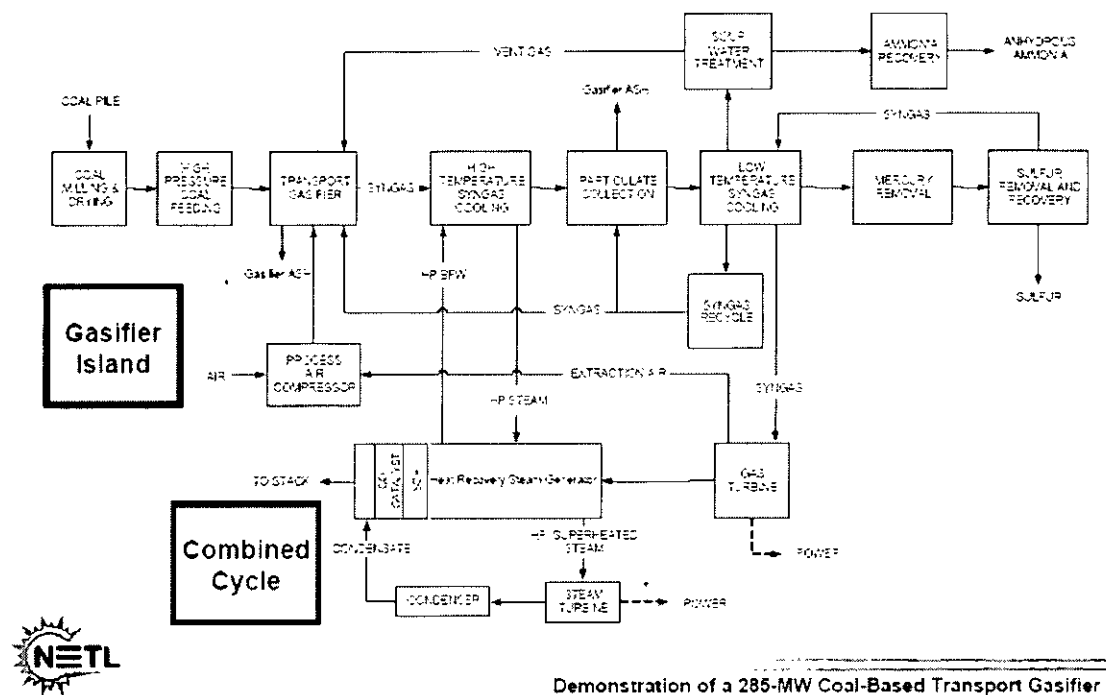

Demonstration of a 285-MW Coal-Based Transport Gasifier

Figure 4. Orlando Utilities Commission/Southern Company Services IGCC Diagram

3.3. Particulate Removal

The hot, sour syngas and the entrained ash that is not captured in the transport gasifier cyclone are partially cooled from ~ 1,730 to ~ 660 °F for heat recovery and further handling. The gas cooler shown in the previous figures operates by raising high pressure and medium pressure steam in an assembly that includes an evaporator, superheater, and economizer with steam drum. Steam and water are interchanged with the HRSG (further integration) that in-turn supplies steam to the steam turbine-electrical generator (STG).

Remaining ash from the partially cooled syngas is removed in the high temperature-high pressure filter system (HTHP) at approximately ~660 °F and 500 pounds per square inch absolute (psia). The HTHP filter consists of ceramic or metallic elements similar to those shown in Figure 5 below.⁵

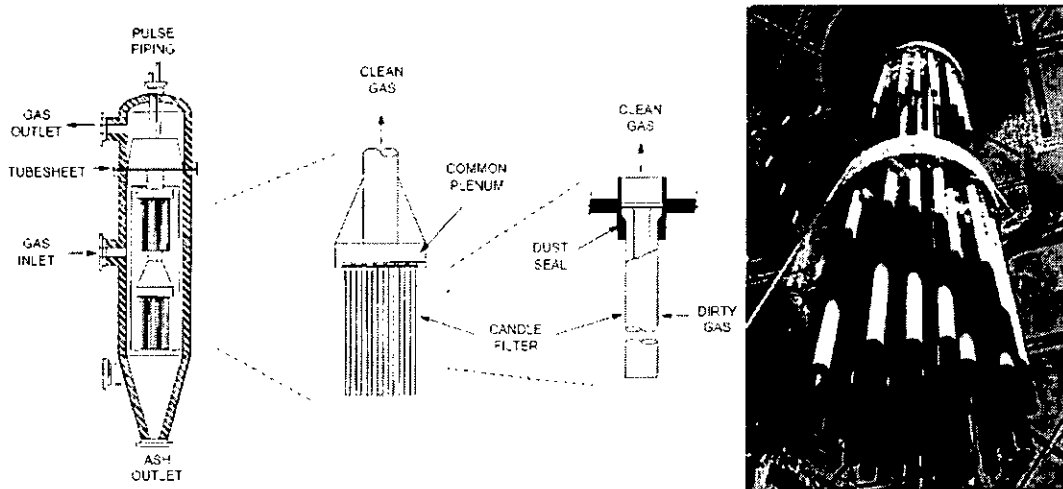

Figure 5. Diagram and Photograph of Siemens-Westinghouse Barrier Filter Components

Ash from the HTHP system and from the gasifier is continuously cooled and removed for possible reuse or disposal. Extensive development of the proposed barrier filters is part of the activities at the PSDF in Wilsonville. Before combusting the syngas in the combustion turbine it is still necessary to reduce nitrogen compounds (NH₃, HCN), sulfur compounds (H₂S and COS), and mercury (Hg).

3.4. Ammonia (NH₃) Removal

After ash removal, the partially cooled (sour) syngas is further cooled to facilitate subsequent cleanup. This cooling is performed in high and medium temperature recuperators that use the heat for subsequent reheating of the cleaned (sweetened) syngas.

This second cooling stage condenses water and reduces NH₃, chlorides, fluorides, and some of the carbon dioxide (CO₂), CO, H₂S, HCN, and COS. A knockout drum and, according to the applicant, an aqueous scrubber is located downstream to further reduce the same constituents. The resulting water stream is combined with the condensed stream from the cooling step and water from the coal preparation system for further treatment in the sour water treatment plant.

The syngas leaves the ammonia removal step at ~300 °F and 485 psia. According to estimates provided by the applicant, syngas NH₃ concentrations are expected to be fairly constant at

TECHNICAL EVALUATION AND PRELIMINARY DETERMINATION

1,700 parts per million by volume (ppmv) at process points between the gasifier exit and ammonia removal steps.

The Department was provided few details regarding the scrubbing to be used in the proposed project. The following figure shows the scrubbing and sulfur compounds removal steps at the TECO Polk Power Station in Florida. It serves as a useful point of reference for parts of this discussion.

3.5. Sour Water Treatment and Ammonia (NH₃) Recovery

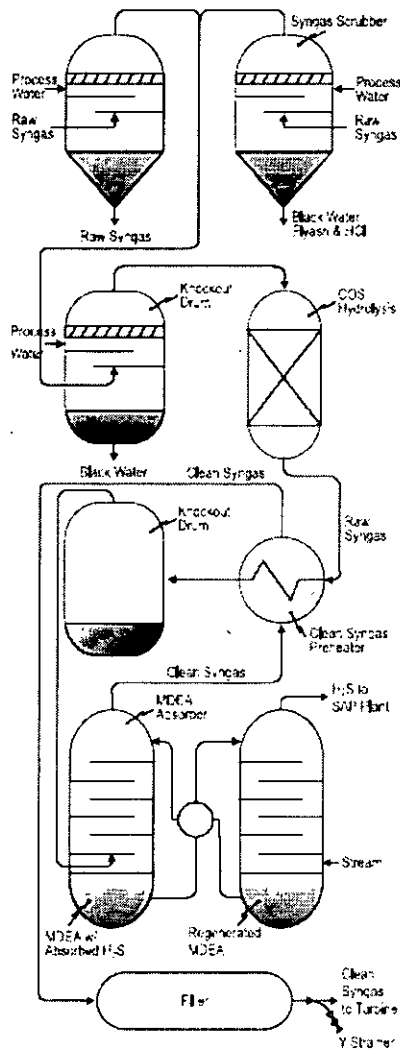

Figure 6. TECO Sour Gas Treatment.

Sour water from the applicant's cooling and ammonia removal step undergoes further treatment including NH₃ recovery for use at the facility or possible sale.

The sour water is heated in a stripped-water recuperator. It flows to a steam heated H₂S stripping column where H₂S, HCN, CO, and CO₂ are released, recompressed, and injected into the oxidation zone of the gasifier.

Water from the H₂S stripper discharges to the steam-heated ammonia stripper to produce an ammonia vapor stream that is condensed and recovered. The water from the bottom of the ammonia stripper passes back to the stripped-water recuperator and is pure enough for plant reuse.

For reference, NH₃ recovery is not typically practiced at the other coal-fueled IGCC processes. For example, sour water (shown as "blackwater" on the left hand side) from the gas cleanup at the TECO IGCC plant is treated and reused to slurry the coal rather than processed for NH₃ recovery.

3.6. Carbonyl Sulfide (COS) Hydrolysis

Syngas from the additional cooling and NH₃ removal step undergoes several more steps prior to combustion. It is further cooled in the syngas recuperator to ~120 °F. It is then necessary to convert carbonyl sulfide (COS) by hydrolysis to H₂S in a reactor such as shown in the figure. This enhances subsequent removal of sulfur compounds downstream.

Equation 3. The hydrolysis reaction occurs in the presence of an alumina-based catalyst.

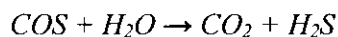

Other catalysts such as titania can be used.

3.7. Mercury (Hg) Removal

After gasifier ash removal, NH₃ removal/recovery and COS hydrolysis, the cooled (and still sour) syngas will be treated for mercury (Hg) removal. According to the applicant, Hg removal will be accomplished in an adsorption column containing sulfur-impregnated activated carbon. The applicant stated that the technology has been demonstrated at the Eastman Chemical Company Plant in Kingsport, Tennessee, which began operations in 1983.

Eastman Chemical operates an O₂-blown coal gasification process similar to the process at TECO Polk Power Station. The resultant syngas is used to make acetyl chemicals rather than combusted for power generation. This facility also employs carbon beds to remove Hg from the syngas prior to sulfur removal.

The photograph on the left hand side of the following figure is of the Calgon Hg removal beds at Kingsport from a presentation by Parsons (with assistance by Eastman).⁷ The one on the right is from a presentation detailing Hg control experiments at TECO Polk Power Station.

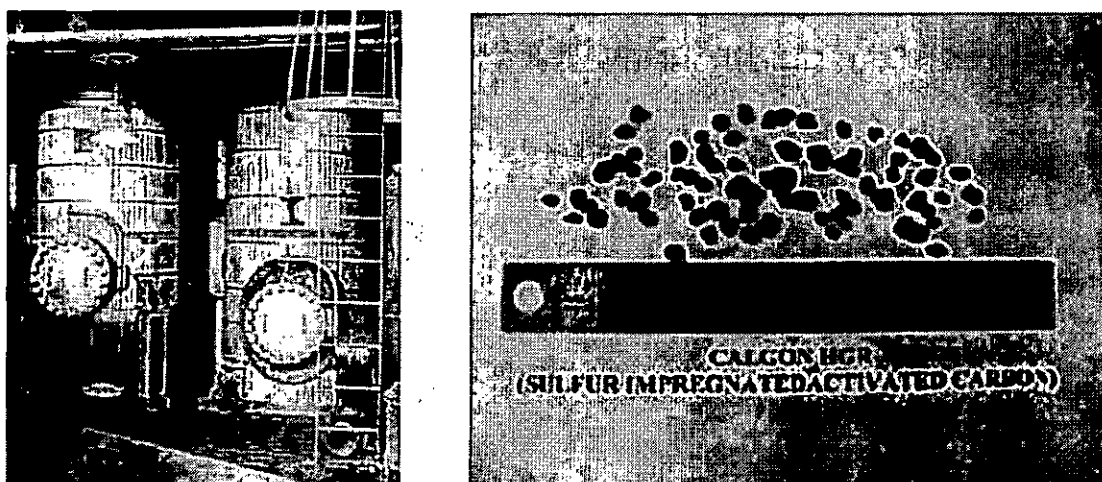

Figure 7. Carbon Removal Beds, Sample of Activated Carbon (Parsons, Eastman, TECO)

According to the mentioned presentation by Parsons:

- Sulfur-impregnated activated carbon beds were used;
- Eastman's Hg removal beds operate at ~ 30°C (86 °F) temperature, 900-1000 psig;
- Contact time is ~ 15-20 seconds contact time (based on total packed volume);
- Hg removal is >90-95% Hg removal (based on Radian International Study); and
- Lifetime of the carbon beds is >12-18 months and is limited by pressure drop and other process steps related to chemical manufacturing, not Hg breakthrough.

The Department's evaluation of the information above and conclusions are given as part of the technology determinations in Section 5 of this report.

3.8. Sulfur (H₂S) Removal and Sulfur Recovery

Sulfur recovery and sale is an objective of the proposed project. The present plan is to use a process known as “CrystaSulf”. In response to Department’s request for a description of CrystaSulf, the applicant provided the following excerpt from a literature reference (but not the actual paper):⁸

“The CrystaSulf sulfur removal technology developed by CrystaTech converts H₂S directly to elemental sulfur using a proprietary non-aqueous hydrocarbon based scrubbing solution. This solution absorbs the H₂S in a conventional bubble-tray absorber, where the H₂S reacts with sulfur dioxide, itself physically absorbed in the scrubbing solution, to form elemental sulfur according to the classic liquid Claus process reaction.”

Equation 4. (Inserted by Department) The liquid phase Claus reaction proceeds as follows:

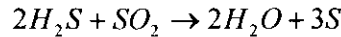

“The CrystaSulf solution has a high solubility for product sulfur, which remains totally dissolved at the process operating temperature.

“Rich solution from the absorber passes to a flash tank, and then the solution flows to a crystallizer, where the temperature is lowered and the solid sulfur crystals form. The crystallizer/filter area is the only area where sulfur solids exist within the process, and they are removed by a filter system. The crystallizer overflows to a surge tank, where a heater raises the solution temperature back to the circulating temperature and ensures that all elemental sulfur is dissolved in the solution. A conventional positive displacement pump transfers the solution back to the absorber.”

The applicant goes on to add:

“With the CrystaSulf system, the maximum theoretical sulfur removal yields a syngas with approximately 4 ppmv H₂S plus some similar amount of carbonyl sulfide (COS) (which is not removed by the CrystaSulf system). Further H₂S reduction is not possible due to the limitation of chemical equilibrium. More detailed information about the process, such as specific operating conditions, is proprietary information to CrystaTech, and SCS is prohibited from disclosing it under a confidentiality agreement between CrystaTech, Inc. and SCS.”

For reference, H₂S removal in TECO’s cleanup scheme is shown as the last step (MDEA absorber) in Figure 6. The separated H₂S steam is then combusted in a sulfuric acid plant (not shown) and the resultant product is sold.

The diagram on the following page was obtained from a report obtained by the Department that CrystaTech submitted to DOE.⁹ Further details about the selected CrystaSulf Technology are given in the SO₂ BACT analysis in Section 5.4 below.

The “sweetened” syngas leaves the H₂S removal and sulfur recovery step at a temperature of approximately 115 °F and pressure of 460 psia.

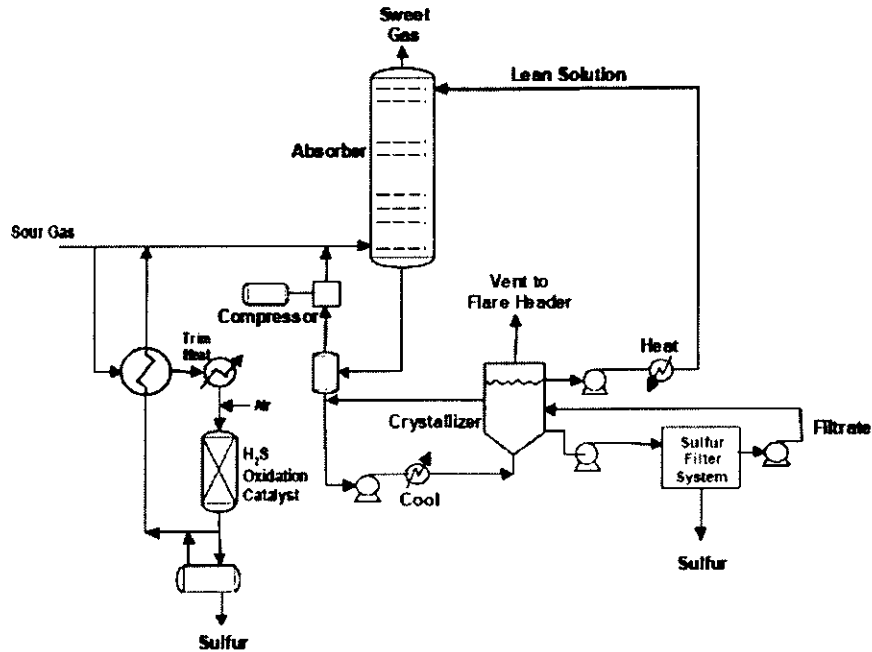

Figure 8. Flow Diagram for Hybrid CrystaSulf Process

3.9. Syngas and Natural Gas Firing in Combustion Turbine

Description of Combustion Turbine

The syngas or back-up natural gas will be fired in a gas turbine also known as a combustion turbine (CT). A gas turbine is an internal combustion engine that operates with rotary rather than reciprocating motion. They are called gas turbines because air is the working medium (as opposed to steam).

The applicant advised that there is a contract with General Electric (GE) to supply a large Model 7FA+e CT for use in the proposed project. Although applicants typically know what model of CT they will use in a given project, final commitments are usually not made until environmental regulatory agencies issue BACT decisions. However, the standard conditions in DOE contracts include a "Sense of the Congress" clause to buy American made products to the extent practicable.

Syngas Delivered for Combustion

Cooled, sweetened, cleaned syngas is reheated to ~550 °F (~450 psia) using heat from the low temperature cooling step for introduction into the CT as fuel. The information in the left hand column in the following table gives the syngas constituents (air-blown case) provided by the applicant to General Electric as the basis of the combustion turbine performance guarantee.¹⁰ The rest of the information is from a Southern Company presentation obtained by the Department. It is a comparison of syngas from air-blown and O₂-blown versions of the KBR Transport Gasifier with natural gas.¹¹ The heating values for all three columns are from the Southern Company presentation. The applicant subsequently advised that the HCl value shown is from the gasifier and prior to the cleanup described in Section 3.4 above.^{12, 13} The Department requested, but did not receive, a revised estimate as of the time this evaluation was completed. The Department added the "<<<" symbol to the HCl estimate.

TECHNICAL EVALUATION AND PRELIMINARY DETERMINATION

Table 2. Exhaust Characteristics of Unit B at 100% Load and Reference Temperature

Constituent	Percent (%) as Delivered to Combustion Turbine		
	Air-Blown	O ₂ -Blown	Natural Gas
Hydrogen (H ₂)	12.1	35.9	
Carbon Monoxide (CO)	23.7	42.2	
Methane (CH ₄)	2.2	3.1	94.0
Carbon Dioxide (CO ₂)	7.0	16.6	1.0
Water (H ₂ O)	1.0	0.9	0.0
Nitrogen (N ₂)	53.9	1.2	1.6
Other (e.g. ethane, etc)	0.1	0.1	3.4
Ammonia (NH ₃)	67 ppmv		
Hydrogen Cyanide (HCN)	79 ppmv		
Fuel Bound Nitrogen (NH ₃ +HCN)	146 ppmv		
Hydrogen Sulfide (H ₂ S)	4 ppmv*		4 ppmv**
Carbonyl Sulfide (COS)	1 ppmv		
Hydrogen Chloride (HCl)	<< 24 ppmv		
Lower heating Value (LHV)	125	253	920
Higher Heating Value (HHV)	135	275	1020

*The application submitted to the Department estimated 12 ppmv of H₂S in the syngas.

** The value of 4 ppmv H₂S cited for natural gas is equivalent to FERC Tariff of 0.25 gr H₂S/100 SCF for suppliers injecting gas into the Florida Gas Transmission grid. The tariff allows up to 10 gr S/100 SCF of sulfur to account for addition of odorants. Thus a customer could (though unlikely) receive as much as 160 ppmv of S within the tariff.

For example, between the period April 19 to May 21, 2006, the natural gas in the 24-inch pipeline passing through Brooker, Florida typically averaged 4-7 ppmv of H₂S (and more than presumed in the table above).¹⁴ A more realistic assumption for maximum natural gas sulfur content and consistent with Department's BACT determinations for controlling SO₂ emissions from natural gas-fueled combustion turbines, is a maximum value of 2 gr S/100 SCF. This equates to 32 ppmv of H₂S.

How the CT Works

Ambient air is drawn into the 18-stage compressor of the GE 7FA+e where it is compressed by a pressure ratio of about 15 times atmospheric pressure. The compressed air is then directed to the combustor section, where the syngas fuel is introduced, ignited, and burned. The combustion section consists of 14 separate can-annular combustors based on the "Multi-Nozzle Quiet Combustor" (MNQC) design. The figure below is photograph from the GE website of a standard "7FA on the half-shell" and includes a diagram of the model for IGCC applications.

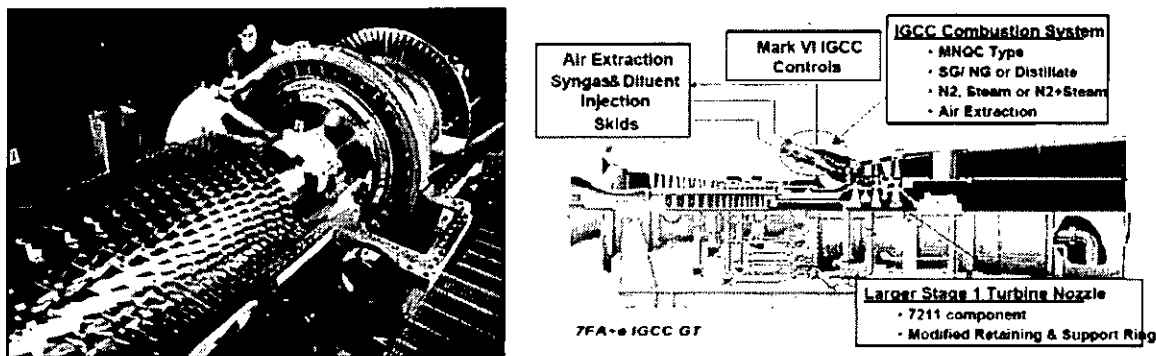

Figure 9 – Natural Gas-fired GE 7FA. GE7FA+e CT with MNQC for Syngas Firing

According to GE, “the CT combustor is the key process orifice for an entire IGCC plant” which means it is what all the resultant syngas gets “pushed through”.¹⁵ The IGCC version of the MNQC combustor requires an increased diameter to process more than five times as much low heating value syngas compared with natural gas.

Typically, the hot combustion gases are then diluted with additional cooling air and directed to the turbine (expansion) section. The exact cooling mechanism for the syngas version may vary somewhat. Energy is recovered in the turbine section in the form of shaft horsepower, of which typically more than 50 percent is required to drive the internal compressor section. The balance of recovered shaft energy is available to drive the external load unit such as an electrical generator. Turbine exhaust gas (TEG) is discharged at a temperature in the range of 1100 °F. The heat content and high excess oxygen are available for further combustion in duct burners and energy recovery to raise steam.

Integration of CT with other Steps

Integration between the CT and the gasifier was introduced in the section on gasifier operation above. This is accomplished by extraction of air from the CT compressor section to the process air compressor (PAC) that supplies the gasification step. The reason this is feasible is that so much syngas, including the atmospheric N₂, is fed through the combustors that the expansion side of the CT can not accommodate all of the air that can be processed in the CT compressor.

The left hand diagram below from GE depicts air extraction to feed an air separation unit (ASU) in an O₂-blown process instead of feeding a PAC. The proposed project will be designed for partial (25%) airside extraction to a PAC.

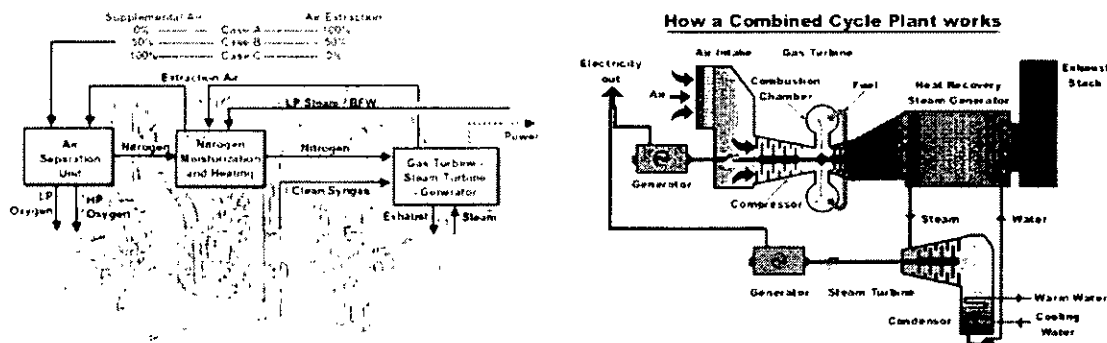

Figure 10. Integrations of CT with Gasifier Oxidant Supply and in Combined Cycle

The second obvious integration is that the CT will operate primarily in combined cycle mode, meaning that the gas turbine drives one electric generator while the exhausted gases are used to raise steam in a heat recovery steam generator (HRSG) to provide much of the steam to drive a steam turbine-electric generator (STG). In combined cycle mode, the thermal efficiency of the 7FA can exceed 50 percent on a higher heating value (HHV) basis when fueled by natural gas. A conventional (non-IGCC) combined cycle diagram is shown on the right hand side in the figure above.

The overall efficiency of IGCC will necessarily be less than the standard combined cycle firing natural gas. This is due to the various transformations of the basic fuel, pressure drops, additional air compression, heat losses through liquid and solid effluents and the basic laws of thermodynamics. The expectation is that the proposed project will achieve overall (net) 40% efficiency on a higher heating value (HHV) basis.

Additional Features

The applicant proposes the following additional features:

- *Evaporative cooling* (also known as “fogging”) is the injection of fine water droplets into the gas turbine compressor inlet air, which reduces the gas temperature through evaporative cooling. Lower compressor inlet temperatures result in greater mass flow rate through the gas turbine with a boost in electrical power production. The emissions performance remains within the normal profile of the gas turbine for the lower compressor inlet temperatures. Fogging is typically practiced at ambient temperatures of 60° F or higher.
- *Duct Burning*: Gas-fired duct burners (DB) can be used in the HRSG to provide additional heat to the turbine exhaust gas and produce even more steam-generated electricity. Duct firing is useful during periods of high-energy demand. The applicant requests unlimited use of duct burning for the unit while firing either natural gas or syngas.

3.10. Potential Emissions

The project will (at least) result in emissions of nitrogen oxides (NO_x), carbon monoxide (CO), particulate matter (PM, PM₁₀), sulfur dioxide (SO₂), sulfuric acid mist (SAM), volatile organic compounds (VOC), lead (Pb) and mercury (Hg). There may also be appreciable emissions of formaldehyde (CH₂O), ammonia (NH₃) and possibly hydrogen chloride (HCl).

The table on the following page summarizes the project emission estimates of key pollutants after:

- Applicant revision of NO_x to account for concurrent reductions elsewhere at the facility;
- Department BACT determinations as discussed in Section 5.
- Inclusion of an NH₃ estimate, due to its use as a reagent to control NO_x.

Included in these estimates are emissions from the combustion turbines, duct burners, flare, coal handling and storage, and cooling tower. Although total HAP emissions are not included in the table, the applicant provided an estimate of 5.1 TPY. The Department believes that total HAP are less than 10 TPY taking into consideration HCl emissions and assuming that efficient scrubbing will be conducted to remove HCl prior to syngas combustion (see section 3.9).

As discussed in the PM control section, the Department believes these emissions will be much less than estimated by the applicant.

TECHNICAL EVALUATION AND PRELIMINARY DETERMINATION

Table 3. Estimated Net Annual Emission Increases From OUC Stanton Plant with IGCC

Pollutant	Emissions TPY	PSD Significant Emission Rate in TPY	PSD Review Required?
NO _x	-19*	40	No
CO	128**	100	Yes
PM	189	25	Yes
PM ₁₀	179	15	Yes
SO ₂	109**	40	Yes
SAM	24	7	Yes
Ozone as VOC	40**	40	Yes
Lead (Pb)	0.03	0.6	No
Mercury (Hg)	0.01	0.1	No
Ammonia (NH ₃)	~ 100 (slip)	Not Applicable	NA

* IGCC Unit emissions will be 1006 TPY NO_x, but will be offset by reductions of 1025 TPY from existing coal-fired Units 1 and 2.

** The applicant estimated values of 654, 162, and 128 TPY for CO, SO₂, and VOC respectively. These were reduced to the values shown by the Department's application of BACT as discussed below.

4. RULE APPLICABILITY

4.1. Federal Regulations

This project may be subject to certain federal provisions regarding air quality as established by the EPA in the Code of Federal Regulations (CFR) and summarized below.

Title 40	Description
Part 52	Subpart A, as Applicable and Subpart K – State of Florida SIP Approvals
Part 60	New Source Performance Standards, 40CFR60 Subparts A, Da, Y, and potentially Subpart KKKK
Part 63	National Emissions Standards for Hazardous Air Pollutants, 40CFR63, potentially Subpart A and Subpart YYYY
Part 70	State Operating Permit Programs
Parts 72,73	Acid Rain – Permits, SO ₂ Allowance System
Parts 75-77	Acid Rain – NO _x Emissions Reduction Program, Excess Emissions

4.2.State Regulations

The project is subject to the applicable environmental laws specified in Section 403 of the Florida Statutes (F.S.). The Florida Statutes authorize the Department of Environmental Protection to establish rules and regulations regarding air quality as part of the Florida Administrative Code (F.A.C.).

TECHNICAL EVALUATION AND PRELIMINARY DETERMINATION

This project is subject to the following rules in the Florida Administrative Code.

Chapter	Description
62-4	Permits
62-17	Electrical Power Plant Siting
62-204	Air Pollution Control – General Provisions
62-210	Stationary Sources of Air Pollution – General Requirements
62-212	Preconstruction Review (including PSD Requirements)
62-213	Operation Permits for Major Sources of Air Pollution
62-296	Stationary Sources - Emission Standards
62-297	Stationary Sources - Emissions Monitoring

4.3. Description of PSD Applicability Requirements

The Department regulates major air pollution sources in accordance with Florida's Prevention of Significant Deterioration (PSD) program, as defined in Rule 62-212.400, F.A.C. A PSD review is only required in areas currently in attainment with the National Ambient Air Quality Standard (AAQS) for a given pollutant or areas designated as "unclassifiable" for the pollutant. A new facility is considered "major" with respect to PSD if the facility emits or has the potential to emit:

- 250 tons per year or more of any regulated air pollutant, or
- 100 tons per year or more of any regulated air pollutant and the facility belongs to one of the facility categories listed in 62-210.200 (definition, Major Stationary Source), F.A.C., or
- 5 tons per year of lead.

For major modifications to existing PSD-major sources, each regulated pollutant is reviewed for PSD applicability based on emissions thresholds known as the Significant Emission Rates (SERs) listed in 62-210.200 (definitions, Significant Emissions Rate) F.A.C. Any pollutant emissions expected to be above the listed Significant Emission Rates are considered to be "significant" and are subject to PSD preconstruction review which includes the application of best available control technology for each PSD pollutant, and an ambient air quality impact analysis as specified in 62-212.400(8) and (10), F.A.C. BACT determinations for this project are required for CO, PM/PM₁₀, SO₂, SAM, and VOC.

The other part of PSD review requires an Air Quality Analysis consisting of: an air dispersion modeling analysis to estimate the resulting ambient air pollutant concentrations; a comparison of modeled concentrations from the project with National Ambient Air Quality Standards and PSD Increments; an analysis of the air quality impacts from the proposed project upon soils, vegetation, wildlife, and visibility (Air Quality Related Values – AQRVs); and an evaluation of the air quality impacts resulting from associated commercial, residential, and industrial growth related to the proposed project.

5. DRAFT DETERMINATION OF BEST AVAILABLE CONTROL TECHNOLOGY (BACT)

5.1. BACT Determination Procedure

BACT is defined in Rule 62-210.200 (definitions), FAC as follows:

“Best Available Control Technology” or “BACT” –

- a. *An emission limitation, including a visible emissions standard, based on the maximum degree of reduction of each pollutant emitted which the Department, on a case by case basis, taking into account:
 1. *Energy, environmental and economic impacts, and other costs;*
 2. *All scientific, engineering, and technical material and other information available to the Department; and*
 3. *The emission limiting standards or BACT determinations of Florida and any other state; determines is achievable through application of production processes and available methods, systems and techniques (including fuel cleaning or treatment or innovative fuel combustion techniques) for control of each such pollutant.**
- b. *If the Department determines that technological or economic limitations on the application of measurement methodology to a particular part of an emissions unit or facility would make the imposition of an emission standard infeasible, a design, equipment, work practice, operational standard or combination thereof, may be prescribed instead to satisfy the requirement for the application of BACT. Such standard shall, to the degree possible, set forth the emissions reductions achievable by implementation of such design, equipment, work practice or operation.*
- c. *Each BACT determination shall include applicable test methods or shall provide for determining compliance with the standard(s) by means which achieve equivalent results.*
- d. *In no event shall application of best available control technology result in emissions of any pollutant which would exceed the emissions allowed by any applicable standard under 40 CFR Parts 60, 61, and 63.*

According to Rule 62-212.400(4), FAC, the applicant must at a minimum provide certain information in the application including:

- a. *A detailed description as to what system of continuous emission reduction is planned for the source or modification, emission estimates, and any other information necessary to determine BACT including a proposed BACT.*

5.2. New Source Performance Standards

On February 27, 2006, the United States Environmental Protection Agency (EPA) revised its regulation 40CFR60, Subpart Da-Standards of Performance for Electric Utility Steam Generating Units for Which Construction is Commenced After September 18, 1978. The revision included designation (based on circumstances) of coal-fueled IGCC units as sources subject to Da and identified key provisions, applicable to coal-fueled IGCC units with duct burners.

TECHNICAL EVALUATION AND PRELIMINARY DETERMINATION

- Heat recovery steam generators (HRSG’s) and the associated stationary combustion turbine(CT’s) burning fuels containing 75 percent (by heat input) or more synthetic-coal gas on a 12-month rolling average are subject to this part and are not subject to 40CFR60, Subpart KKKK- (Proposed) Standards of Performance for Stationary Combustion Turbines.
- Mercury (Hg) emissions from IGCC units are limited to 20×10^{-6} pounds per megawatt-hour gross energy output (lb/MWH_{gross}).
- SO₂ emissions are limited to: sulfur dioxide in excess of either: 1.4 lb/MWH on a 30-day rolling average basis, or 5 percent of the potential combustion concentration (95 percent reduction) on a 30-day rolling average basis.
- NO_x emissions are limited to: 1.0 lb/MWH on a 30-day rolling average basis.

The following table is a summary of the applicable Subpart Da requirements because the unit is a fossil fuel fire electric steam generator. Depending on future EPA final actions on rulemaking, either Subpart GG or Subpart KKKK will apply because the unit will be permitted to burn more than 25% (up to 100%) natural gas in the CT and may actually do so during the first year(s) of operation.

Table 4. Comparison of Applicant’s Original Proposed Emission Limits with Requirements of Various Potentially Applicable Part 60/63 Regulations*

Pollutant	Application Stanton B	Final Subpart Da ¹	Proposed ² Subpart KKKK	Existing ² Subpart GG
NO _x (lb/MWH _{gross})	0.57 (Syngas) ~0.135 (NG) 5 ppmvd (NG)	1.0 (30-day rolling avg.)	0.39	75 ppmvd
SO ₂ (lb/MWH _{gross})	~0.11 (Syngas) ~0.0045 (NG) Pipeline NG ⁵	1.4 or 95% Control (30-day rolling avg.)	0.58	0.8% Sulfur
PM (lb/MWH _{gross})	0.094 (Syngas) ~0.7-0.8 (NG)	0.14	NA	NA
Hg (lb/MWH _{gross})	7.7×10^{-6}	20×10^{-6}	NA	NA
Formaldehyde	0.62 lb/hr (est.) ⁴	Stayed 40 CFR 63 Subpart YYYY limit is 91 ppb ³		

1. 40CFR60, Subpart Da applies if the unit fires more than 75% syngas.
2. Existing 40CFR60, Subpart GG and “proposed” 40CFR60, Subpart KKKK may ultimately apply because the unit is allowed to burn 100% natural gas.
3. “Stayed” 40CFR63, Subpart YYYY may apply depending on the outcome of EPA’s disposition of exemption proposals.
4. The formaldehyde emissions were estimated by the applicant on the basis of AP-42 Test Data for Large Heavy Duty CTs. The “Stayed” 40CFR63, Subpart YYYY value of 91 parts per billion (ppb) would allow roughly 0.37 lb/hr of formaldehyde.
5. Per applicant equates to 0.2 gr.S/100 scf, 0.0006 lb/mmBtu, and 0.0045 lb/MWH_{gross}. Implies << 0.8%S.

TECHNICAL EVALUATION AND PRELIMINARY DETERMINATION

The overall observation is that emission limits as originally proposed by the applicant for Unit 4 will “comfortably” comply with requirements in 40CFR60, Subparts Da, GG, KKKK.

Based on the applicant’s estimates of formaldehyde (CH₂O) emissions, the unit would not comply with the limit of 91 ppb required by “stayed” Subpart YYYY when firing natural gas. Subpart YYYY does not apply when Subpart Da applies to the IGCC unit.

The situation regarding applicability of 40CFR60/63 regulations to CT’s is presently uncertain because various final actions are expected from EPA. This situation is further complicated by the reality that the propose unit will be permitted to operate on natural gas or syngas without limitations in proportion or hours.

The Department requested that EPA review the applicability analysis and provide informal guidance under its authority over the governing Parts 60 and 63 regarding the requirements applicable to the CT for this project.

5.3. NO_x Reductions at Stanton Units 1 and 2

The applicant amended the application by letter received on May 19, 2006 to implement NO_x control measures to reduce emissions from the larger and higher emitting conventional coal-fuel Units 1 and 2.¹⁶ The emissions reduction are sufficient to insure that operation of the new Stanton Unit B will not cause a net increase in annual NO_x emissions greater than 40 TPY. This removes the requirement to conduct a PSD review of ambient air quality impacts from the Stanton Unit B and the requirement for a Best Available Control Technology (BACT) review for NO_x.

The applicant requests an enforceable cap of 8,300 TPY of NO_x applicable to Units 1 and 2. The requirement will be in addition to already applicable PSD/BACT permit limits, Conditions of Certification, and Title IV Acid Rain requirements already in effect. The cap represents a reduction of 1,025 TPY from the average value of 9,325 TPY emitted during calendar years 2004-2005. The procedure for the calculation is described Paragraph 62-212.400.200(34), F.A.C., Baseline Actual Emissions.

(a) For any existing electric utility steam generating unit, baseline actual emissions means the average rate, in tons per year, at which the unit actually emitted the pollutant during any consecutive 24-month period selected by the owner or operator within the 5-year period immediately preceding the date a complete permit application is received by the Department. The Department shall allow the use of a different time period upon a determination that it is more representative of normal source operation.

Confirmation of compliance with the cap is by the continuous emission monitoring systems (CEMS) already in use for compliance with Title IV, Acid Rain, of the Clean Air Act. The CEMS data are reported quarterly on the EPA Clean Air Markets. The summaries have quarterly and annual results for approximately the past ten years and are available at:

www.epa.gov/airmarkets/emissions/prelimarp/index.html

A review of the data for Units 1 and 2 reveals that emissions vary from year-to-year by a level approximately equal to the planned reduction. The Department reviewed the kinds of measures that OUC will need to implement in order to insure compliance with the cap

TECHNICAL EVALUATION AND PRELIMINARY DETERMINATION

The present "cap" (actually the potential to emit) on Units 1 and 2 can be estimated from their respective BACT or Acid Rain limits (0.46 and 0.17 lb/mmBtu), allowable heat input for each unit (4,286 mmBtu/hr), and continuous operation (8,760 hours per year). This equals 11,826 TPY. Thus OUC is accepting a reduction in its existing cap for the two units by 3,526 TPY.

OUC is currently conducting a study to ascertain the optimum methods to effect NO_x reductions from Stanton Units 1 and/or Unit 2. Because this study has not been completed, OUC has not provided the details of the measures it will undertake to permanently bring about the reduction. An air construction permit will be required in the future to implement these projects.

The following types of NO_x controls are being considered for Stanton Unit 1, which presently does not have sophisticated NO_x controls:

- Low-NO_x burners (LNB) whereby NO_x formation is limited by controlling the stoichiometric and temperature profiles of combustion in each burner zone;
- Overfire air (OFA) whereby air is introduced above the main combustion zone where fuel burnout can be completed at a lower temperature;
- Selective non-catalytic reduction (SNCR) that uses a reagent such as ammonia or urea to control destroy NO_x emissions in the exhaust gas; and
- Selective catalytic reduction (SCR). The same reaction as above occurs in the presence of catalyst.

The described measures are being implemented at certain plants in Florida pursuant to: enforcement actions, particularly at the TECO Big Bend Station; voluntary agreements, most notably at Gulf Power Plant Crist in Escambia County; strategies to comply with the Clean Air Interstate Rule (CAIR); and reductions at existing units to avoid emission increases from new projects, such as Seminole Palatka Unit 3.

OUC Unit 2 was originally fitted with the most sophisticated of the mentioned technologies, namely SCR. OUC was a pioneer in the national demonstration of SCR at a new coal-fired conventional unit and has an extensive body of experience in this area. Although the details are under development, the Department has reasonable assurance of:

- the efficacy of the candidate control technologies to reduce emissions;
- enforceability of the netting requirement; and
- incentives for the applicant to comply.

The reductions will provide the applicant some additional flexibility consistent with the demonstration nature of the project and the Department's encouragement of studies, investigations, and research relating to pollution and its causes, effects, prevention, abatement, and control pursuant to 403.061(18), F.S.

In addition to complying with the cap on Units 1 and 2, it is still necessary to review the proposed Stanton B project and insure that it will not increase NO_x emissions by more than the proposed reduction. Additionally the NO_x controls on Stanton Unit B must be examined to insure they are consistent with the control measures needed to set BACT on the other pollutants that will be emitted at levels beyond their respective PSD thresholds.

5.4. NO_x Formation and Control

Although the applicant submitted a request to make permanent and enforceable reductions at the existing Units 1 and 2, the Stanton B NO_x control strategy is discussed because of the interactions with CO and SO₂.

NO_x Formation

NO_x forms in the combustion turbine (CT) as a result of the dissociation of molecules in the combustion air or fuel that contain nitrogen or oxygen atoms. The subsequent recombination of those atoms leads to the formations of at least seven different oxides of nitrogen (NO_x).

Thermal NO_x forms at high temperatures (on the order of 2,600 °F or more) when N₂ and O₂ dissociate and recombine to form NO_x.

Equations 5. The prominent mechanism is described by the following “Zeldovich” reactions:

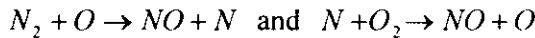

Thermal NO_x forms in the high temperature area of the gas turbine combustor as seen on the left hand side of the figure below. It increases exponentially with increases in flame temperature and linearly with increases in residence time. By maintaining a low fuel ratio (lean combustion), the flame temperature will be lower, thus reducing the potential for NO_x formation. The relationship between flame and firing temperature, output and NO_x formation are depicted in the right side of the figure, which is from a GE discussion on these principles.

In all but the most recent gas turbine combustor designs, the high temperature combustion gases are cooled to an acceptable temperature with dilution air prior to entering the turbine (expansion) section. The sooner this cooling occurs, the lower the thermal NO_x formation. Cooling is also required to protect the first stage nozzle. When this is accomplished by air cooling, the air is injected into the component and is ejected into the combustion gas stream, causing a further drop in combustion gas temperature. This, in turn, lowers achievable thermal efficiency for the unit. The alternative of steam cooling is discussed below.

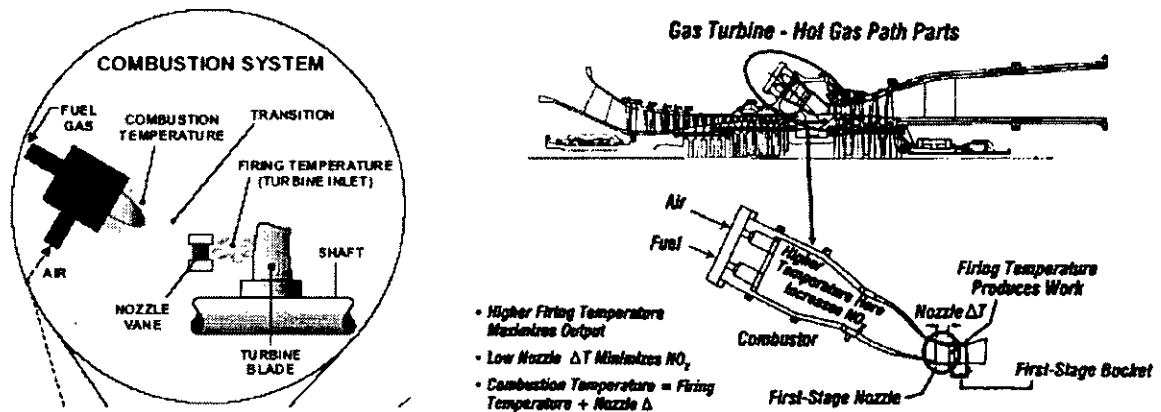

Figure 11. Relation between Combustion and Firing Temperatures and NO_x Formation

Thermal NO_x concentration from the CT (prior to post-combustion control) is estimated by GE at 15 ppmvd when firing syngas and 25 ppmvd when firing natural gas.

Prompt NO_x is formed in the proximity of the flame front as intermediate combustion products. The contribution of prompt to overall NO_x is relatively small in near-stoichiometric combustors and increases for leaner fuel mixtures. This provides a practical limit for NO_x control by lean combustion. Prompt NO_x formation within the CT combustor is believed to be minimal.

Fuel NO_x is formed when fuels containing bound nitrogen or reduced nitrogen compounds (such as NH₃ and HCN) are burned. This phenomenon is not important when the unit fires natural gas or when NH₃ and HCN have been removed in syngas prior to combustion. However the presence of NH₃ and HCN leading to fuel NO_x formation is the critical consideration in the proposed project when firing syngas. HCN oxidizes in various steps to NO, water, carbon dioxide (CO₂) and some CO.

Equation 6. Ammonia can be oxidized by various paths, for example:

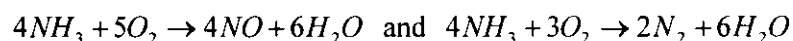

Based on the specification of 146 ppmv of [NH₃ + HCN], GE guaranteed NO_x emissions of 40 ppmvd (15 ppmvd of thermal origin and 25 ppmvd of fuel origin) in the turbine exhaust gas when combusting syngas. The NO_x guarantee when firing natural gas is 25 ppmvd, all of which is of thermal origin.

Descriptions of Available NO_x Strategies and Controls

The following discussion addresses some of the pre-combustion, combustion, and post-combustion measures that can be used to reduce NO_x emissions from the project.

Precombustion Measures to Reduce Fuel NO_x: According to estimates provided by the applicant, syngas NH₃ concentrations are expected to be fairly constant at 1,700 parts per million by volume (ppmv) at process points between the Transport Gasifier exit and ammonia removal steps.¹⁷ There are several obvious measures to consider during gasification and subsequent gas cleanup that can reduce the amount of fuel nitrogen (NH₃ and HCN) presented to the CT and thus NO_x formation. These include:

- Operating the gasifier closer to 1,900 than 1,700 °F and retaining the gas stream at that temperature for a longer period of time. This would increase the thermal decomposition of NH₃ (by Equation 2 in Section 3.2 above) and present less NH₃ to subsequent cleanup and combustion steps.
- More effective scrubbing at the ammonia removal and recovery steps described in Sections 3.4 and 3.5 above. According to information regarding the TECO project, NH₃ concentrations are on the order of 1,800 to 2,000 ppmv prior to removal. TECO apparently removes almost 100% of the NH₃ and HCN (present at in the syngas cleanup) whereas the applicant will remove about 96.5% of these species.

According to the Tampa Electric IGCC Project Performance Summary (2004):¹⁸ *"Fuel-bound nitrogen (in the coal) plays no part in NO_x emissions [at least] from [TECO-design] IGCC systems. The gasifier converts fuel-bound nitrogen to N₂ or compounds such as ammonia, which are readily removed from the syngas before being fed to the combustion turbine. NO_x emissions are due solely to "thermal" NO_x generated as a result of the combustion turbine's elevated firing temperatures. Diluent N₂ lowers NO_x emissions by reducing the heating value of the syngas, which in turn lowers turbine firing temperatures."* [Bracketed comments by Department]

TECHNICAL EVALUATION AND PRELIMINARY DETERMINATION

Although the NH_3 concentrations are roughly equal from the two types of gasifiers, the mass of NH_3 in the syngas from the Stanton B gasifier will be greater than from TECO's gasifier because the former contains ~50% N_2 . Given that the applicant will practice NH_3 recovery internal use while TECO does not, roughly the same mass of NH_3 should reach the combustion turbine given that both processes use very efficient scrubbing in the NH_3 removal step. This is reinforced by the observation that TECO reintroduces NH_3 -laden water through slurried coal into its gasifier.

Another advantage of better syngas scrubbing is concurrent removal of hydrogen chloride (HCl) that was estimated (possibly overestimated) at 24 ppm for CT guarantee purposes.

Catalytic decomposition of NH_3 that operates at lower temperature than the first mechanism described in this section is possible and was described by the mid-1990's in papers such as:

- Qader, et. al. described two processes for decomposition of NH_3 present in coal gases. In the first process, NH_3 undergoes decomposition of one catalysts in the temperature ranges of 1200- 1300 °F and 1500- 1600 °F. In the second process, NH_3 undergoes decomposition on the surface of an alumino-silicate catalyst in the temperature range of 800-1000 °F.¹⁹
- Gangwal, et al of Research Triangle Institute and Stanford Research Institute described, in a paper co-authored by GE, development and demonstration of catalytic approaches for decomposing a significant percentage (up to 90 percent) in of the NH_3 present at temperatures in the range of 1000 to 1,650 °F. The fuel gas used was simulated TECO Polk Power Station syngas.²⁰

The Department is not suggesting that the catalytic routes are economically feasible at this time compared with greater retention time at high temperature or better scrubbing or subsequent control by treating the exhaust gases. However, such routes can theoretically provide a less NH_3 to the scrubbing step and less reduced nitrogen compounds to the CT.

In conclusion, it is clear that it is technically feasible to further reduce fuel nitrogen compounds and thus fuel NO_x . The applicant did not address these possibilities to further reduce fuel NO_x (more efficient NH_3 scrubbing, high temperature or catalytic NH_3 decomposition, or two staged combustion as discussed below). The applicant provided blanket statements with no references in the response to the Department's Sufficiency questions about these matters. Ultimately the applicant provided the foregoing netting analysis.

Temperature Suppression by Diluent in IGCC CT. In conventional natural gas and fuel oil applications, injection of water or steam directly into the combustor lowers the flame temperature and thereby reduces thermal NO_x formation. Water or steam injection increases mass throughput and thereby increases power production, but at lower efficiency (higher heat rate). There is a physical limit to the amount of water or steam that may be injected before flame instability or cold spots in the combustion zone would cause adverse operating conditions for the combustion turbine.

Advanced combustor designs can tolerate large amounts of steam or water without causing flame instability and can typically achieve NO_x emissions in the range of 25 ppmvd when employing wet injection for natural gas. This value then forms the basis for further reduction achievable by other techniques as discussed below. Carbon monoxide (CO) and hydrocarbon (HC) emissions are relatively low for most gas turbines. However steam and (more so) water injection may increase emissions of both of these pollutants.

TECHNICAL EVALUATION AND PRELIMINARY DETERMINATION

In air-blown IGCC applications (when combusting syngas) nitrogen (N_2) from the gasification of coal (i.e. partial combustion) enters the combustors with the syngas. The additional mass suppresses NO_x formation in the manner described above. Again there is a benefit in the additional power produced from the additional mass throughput. The standard IGCC combustor for GE gas turbines (and for Stanton Unit B) is derived from the Multi-Nozzle Quiet Combustor (MNQC) shown on the left hand side of the diagram below.²¹ The version shown is configured for natural gas firing and steam injection.

The diagram on the right hand side of the figure shows the tendency towards lower NO_x concentrations by diluent injection and decreasing heating value. While (H_2O) appears to be more efficient, N_2 is readily available from the syngas in the air-blown applications.

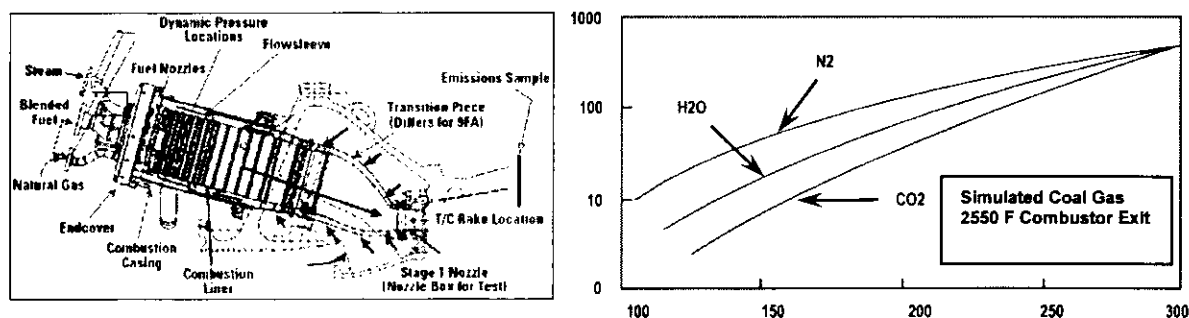

Figure 12. MNQC and Full Load NO_x (ppmvd) Performance vs. Heating Value (Btu/scf)

The GE combustors using TECO's syngas typically produce 15 ppmvd (all of which is thermal NO_x) when relying on N_2 diluent injection alone. Further reduction of NO_x to 10 ± 1 ppmvd is achieved through syngas steam (H_2O) saturation from < 1% to 6% by water vapor raised from waste heat sources.²²

On the other hand, even with N_2 already present in the syngas, the NO_x guarantee provided for the Stanton B is 40 ppmvd (of which 15 ppmvd is thermal NO_x) when combusting syngas. The GE CT's perform equally well with respect to air-blown and O_2 -blown syngas in suppressing thermal NO_x by N_2 diluent based on the information available to the Department.

The difference in overall NO_x emissions between the TECO IGCC and the proposed project relates primarily to the presence of fuel nitrogen compounds and secondarily by the absence of provisions for steam saturation. The first concern, as discussed above, can be controlled by better upstream removal of NH_3 and HCN. The second has not been fully assessed or explained as the project netted out of PSD review for NO_x . The differences in NO_x emission characteristics between the two installations are not simply caused or explained by inherent and uncontrollable characteristics of low temperature air-blown gasification.

Combustion Controls – Dry Low NO_x (DLN). The excess air in lean combustion cools the flame and reduces the rate of thermal NO_x formation. Lean premixing of fuel and air prior to combustion can further reduce NO_x emissions by minimizing localized fuel-rich pockets (and high temperatures) that can occur when trying to achieve lean mixing within the combustion zones. These principles can be applied to firing of natural gas or to syngas. They are incorporated into the General Electric DLN-2.6 can-annular combustor shown on the left hand side of the figure on the following page.

TECHNICAL EVALUATION AND PRELIMINARY DETERMINATION

Each combustor includes six nozzles within which fuel and air have been fully pre-mixed. There are 16 small fuel passages around the circumference of each combustor can known as quaternary fuel pegs. The six nozzles are sequentially ignited as load increases in a manner that maintains lean pre-mixed combustion and flame stability.

The graph on the right hand side is from a GE publication and is a plot of NO_x data from actual installations or possibly a test facility. The combustor emits NO_x at concentrations of 9 ppmvd or less at loads between 50 and 100 percent of capacity, but concentrations as high as 100 ppmvd may occur at less than 50 percent of capacity.

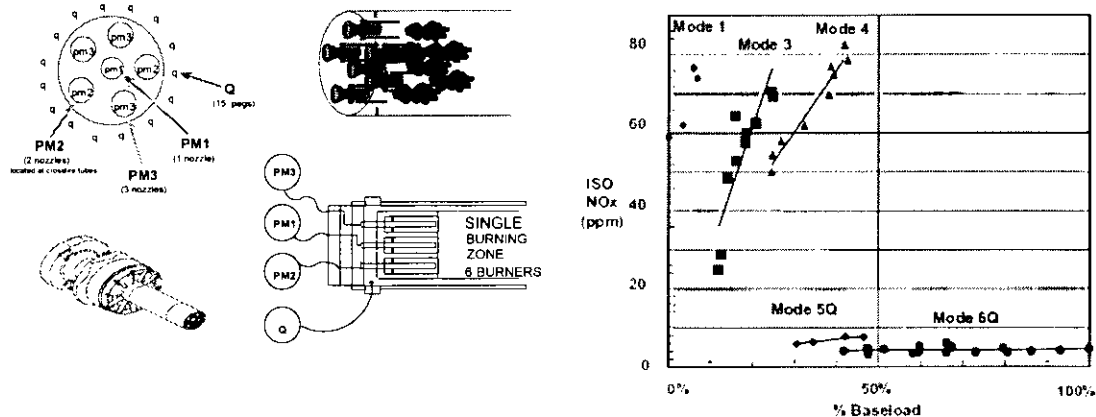

Figure 13 –Fuel Nozzle Arrangement and NO_x Characteristics for DLN-2.6 Combustors.

The applicant selected the updated version of MNQC design over the newer and more common DLN combustors found in most GE natural gas-fueled turbines. The DLN technology is better for the natural gas case. The MNQC yields 25 ppmvd of thermal NO_x compared with 9 ppmvd for the DLN 2.6 combustor when burning natural gas. The MNQC yields 15 ppmvd of thermal when firing syngas.

GE apparently considered a program to develop a fuel-tolerant, lean-pre-mix combustor to achieve ≤ 9 ppm NO_x in IGCC applications.²³ GE has apparently determined for now that “DLN combustors are not appropriate due to hydrogen’s (present in syngas) high flammability and flame speed, which can initiate flashback and combustor failure.”²⁴

The ready availability of N₂ diluent (whether already in the syngas or separately supplied), steam saturation depending upon the application, and the relatively low NO_x characteristics (10-15 ppmvd of thermal NO_x) values are also important considerations in the decision to rely on the MNQC rather than to concentrate on a DLN system. They apparently do not offer the DLN product at this time for this particular syngas application.

Combustion Controls – Staged Combustor. Variations of staged combustion can also be used to destroy much of the NH₃ in the first stage of a specially designed combustor without oxidizing it to NO_x. Then the combustion is completed in oxidizing conditions. The possibility of destroying NH₃ in the first section of a combustor operating on IGCC syngas was described by Sato (1996).²⁵ The indication is that less than 40% of the NH₃ will convert to NO_x versus the complete conversion within more conventional combustors. The NO_x emissions were still significant, but that is largely due to the very high firing temperature (>2,700 °F).

TECHNICAL EVALUATION AND PRELIMINARY DETERMINATION

The Department is not suggesting that this type of combustor is more economical than NH₃ scrubbing of the syngas or post treatment of the CT exhaust. It would add another set of constraints when trying to combust syngas. Such a combustor is apparently not available for this project and might require further research prior to commercial demonstration.

Selective Catalytic Reduction (SCR). Selective catalytic reduction (SCR) is an add-on NO_x control technology that is employed in the exhaust stream following the gas turbine. SCR reduces NO_x emissions by injecting ammonia into the flue gas in the presence of a catalyst.

Equation 7. Ammonia reacts with NO_x in the presence of a catalyst and excess oxygen yielding molecular nitrogen and water according to the following simplified reaction:

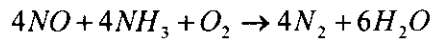

The catalysts used in combined cycle, low temperature applications (conventional SCR), are usually vanadium (V) and titanium oxide (TiO₂) formulations and account for most installations.

In high temperature applications (unlike the present project) V can contribute to ammonia oxidation forming more NO_x or forming nitrogen (N₂) without reducing NO_x.

For high temperature applications (hot SCR up to 1100 °F), such as large frame simple cycle turbines, special formulations or other strategies are required. SCR technology has progressed considerably over the last decade with Tungsten-containing catalysts and zeolite now being used for high temperature applications. SCR units are typically used in combination with diluent or DLN combustion controls.

In the past, sulfur was found to poison the catalyst material. Sulfur-resistant catalyst materials are now available as evidenced by both hot and conventional installations at coal-fired plants. Such improvements have proven effective in resisting sulfur-induced performance degradation with fuel oil in Europe and Japan, where conventional SCR (low temperature) catalyst life in excess of 4 to 6 years has been achieved, while 8 to 10 years catalyst life has been reported with natural gas.

There are several examples of conventional SCR systems operating natural gas-fired combined cycle units in Florida including:

- Kissimmee Utilities Authority Unit 3. 3.5 ppmvd NO_x,
- Progress Energy Hines Block 2. 3.5 ppmvd.
- JEA Brandy Branch. 3.5 ppmvd.
- OUC Stanton Unit A. 3.5 ppmvd.
- TECO Bayside – Seven combustion turbines. 3.5 ppmvd.
- FP&L Manatee Unit 3. 2.5 ppmvd.
- FP&L Martin Unit 8. 2.5 ppmvd.

Higher limits apply for infrequently used backup fuel oil than shown above.

There are several other approved projects now under construction in Florida that require conventional SCR systems. Most recently, DEP issued draft or final permit for Turkey Point Unit 5, FMPA Treasure Coast, and FP&L West County with NO_x limits of 2.0 ppmvd on natural gas. The same NO_x limits apply when using the natural gas-fired duct burners.

The diagram on the left hand side of the figure on the next page (Nooter-Eriksen) below is a diagram of a HRSG. Components 10 and 21 represent the SCR reactor and the ammonia injection grid. The SCR system lies between low and high-pressure steam systems where the temperature requirements for conventional SCR can be met. The photograph on the right hand side is from Stanton Unit A that has an SCR system in the HRSG.

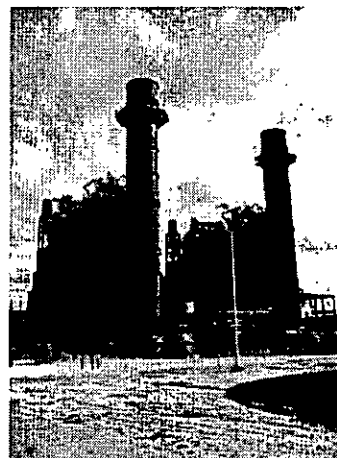
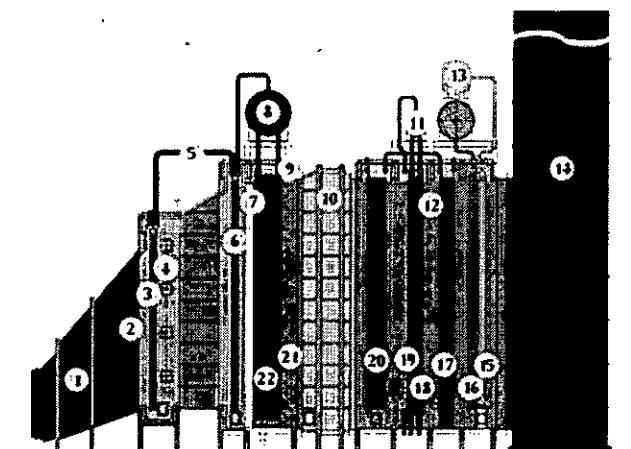
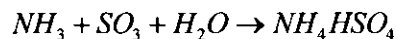

Figure 14 – HRSG Components (10 is SCR)

HRSG and Stack at Stanton Unit B

If the fuel contains significant amounts of sulfur, high levels of ammonia slip can lead to the formation of particulate matter. Unreacted ammonia from SCR process can react with SO_2 and SO_3 at temperatures prevalent in the cooler end of the HRSG, the stack, and beyond.

Equation 8. Ammonium bisulfate is formed in accordance with the following reaction.



Equation 9. Ammonium sulfate is formed per the following reaction.

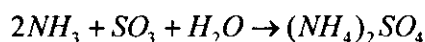

Equation 10. Finally, ammonium bisulfite is formed as follows.

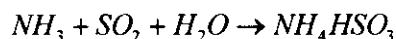

This is not a problem with natural gas or ultra low sulfur distillate fuel oil. The Department also believes this is not a problem for the present project given the low sulfur in the coal, presence of a deep sulfur removal and recovery system, and values presented to GE for the NO_x guarantee. Because the applicant does not plan to achieve very low NO_x emissions it will not be necessary to over-inject ammonia in the exhaust to control NO_x . The absence of significant amounts of NH_3 and SO_2 makes the potential problems more remote.

SCR catalyst is typically augmented or replaced over a period of several years although vendors typically guarantee catalysts for about three years. Following are test results from one project that is cited by EPA Region 9 to show that NO_x emissions less than 2.0 ppmvd @15% O_2 (1-hour basis) are achieved at existing large frame combustion turbine combined cycle units using SCR.²⁶ The units consist of two nominal 180 MW gas combustion turbine-electrical generators with unfired HRSG's, and PA capability.

TECHNICAL EVALUATION AND PRELIMINARY DETERMINATION

Table 5. Test Results for ABB GT-24 with SCR, ANP Blackstone Energy Co., MA²⁷

% Full Load	NO _x , ppmvd @15% O ₂	CO, ppmvd	VOC, ppmvd	NH ₃ ppmvd
50	1.4 – 1.7	0.5 – 0.8	0.2 – 0.4	0.08 – 0.2
75	1.5 – 1.6	< 0.1	0.2 – 0.4	0.02 – 0.06
87	1.4 – 1.7	~ 0 – 0.3	0.1	0.05 – 0.1

It is noteworthy as well that the low NO_x emissions were achieved with minimal NH₃ emissions. It would be reasonable to expect the ammonia emissions to increase over time to the guaranteed value of 2.0 ppmvd.

The Site Mystic Station, Massachusetts is located in an ozone non-attainment area. The project received conditional approval to commence construction in 2000 and started up in 2003.²⁸ It consists of four M501G natural gas-fueled combined cycle units with duct burners. Each unit has a NO_x limit of 2 ppmvd @15% O₂. One month of hour-by-hour NO_x data from Unit 82 is presented in the figure below.

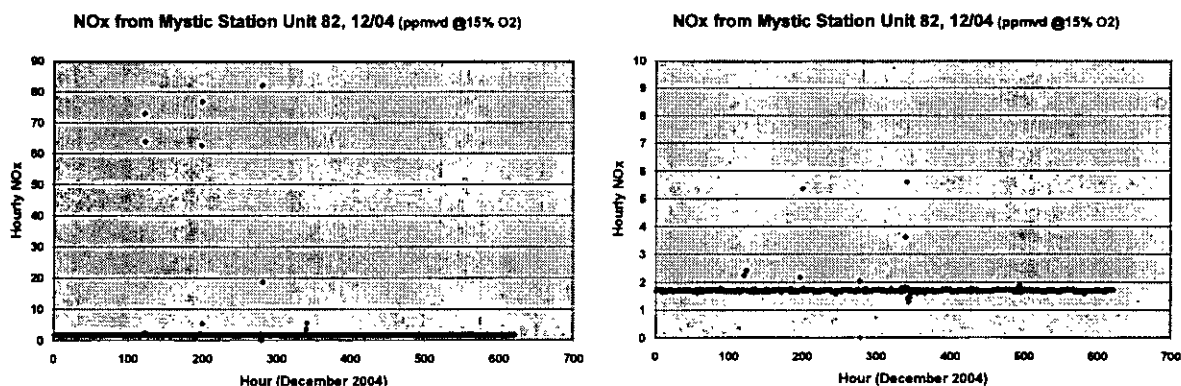

Figure 15. Hourly NO_x Data from Site Mystic Station, Massachusetts. December 2004

Unit 82 operated 620 hours during the month of December 2004, typically at combustion turbine electrical generation rates between 170 and 250 MW. The data on the left comprise all reported hours of operation including thirteen measurements related to startups and shutdowns. The same data on the right, in greater resolution, clearly show that, with the exception of the startup and shutdown values, the unit consistently achieved less than 2 ppmvd NO_x @15% O₂.

It is noteworthy that the range of NO_x concentration into the SCR systems (30-40 ppmvd) after diluent injection into the CTs is approximately equal to the range of values for the proposed project (40 ppmvd syngas and 25 ppmvd for natural gas). It is clear that very low emissions are achievable from the proposed project, though not required.

SCR is a commercially available, demonstrated control technology currently employed on numerous large combined cycle combustion turbine projects permitted with very low NO_x emissions (< 2.5 ppmvd). SCR results in further NO_x reduction of 60 to 95% after initial control by DLN or WI in a combined cycle unit or total control on the order 95 to 99%.

TECHNICAL EVALUATION AND PRELIMINARY DETERMINATION

Applicant's NO_x Proposal

The applicant originally proposed that BACT emission limits for proposed Stanton Unit B will be achieved by the diluent in the syngas in conjunction with SCR while firing syngas and by steam/water injection in conjunction with SCR when firing natural gas.

The applicant proposed the following BACT limits for NO_x:

- Gas Firing: 5.0 ppmvd
- Syngas Firing: 20 ppmvd (Phase I) and as low as 12 ppmvd after 4 years of operation. This initially equates to approximately 0.08 lb/mmBtu and 0.57 lb/MWH_{gross} and then to roughly 0.05 lb/mmBtu and 0.35 lb/MWH_{gross}. Note that there is a big difference between net and gross basis because of the high parasitic loads within IGCC units.

Department's Opinion regarding BACT on NO_x

There have been no coal-fueled IGCC units built in several years. When the previous ones were authorized, SCR was not yet fully embraced for the conventional natural gas-fired units. For example numerous combined cycle projects built in the middle 1990's (contemporaneous with TECO Polk Power Station IGCC project) were approved with NO_x limits in the range of 15 to 25 ppmvd (similar to the TECO's IGCC limits).

In fact emission limits for the largest combined cycle projects in Fort Lauderdale and Indiantown, Florida were permitted with limits of 42 and 25 ppmvd of NO_x respectively. At the time, similar arguments were made regarding the potential formation of particulate matter as described above. As discussed previously, SCR is now in use and accepted as BACT at combined cycle installations. Similar reductions are now possible and viable for IGCC projects.

GE, the owner of the coal-fueled IGCC technology used at TECO, offers an updated reference plant that includes SCR and deep sulfur removal to achieve very low NO_x (and SO₂) limits. The plant was described in mid-2005 at:

www.iea-coal.org.uk/publishor/system/component_view.asp?LogDocId=81264&PhyDocId=5653

Of significance is the list of emission characteristics that include NO_x at 0.02 lb/mmBtu (roughly 5 ppmvd) and SO₂ at 0.01 lb/mmBtu (roughly 2 ppmvd). The reference plant assumes much greater sulfur in the coal than proposed by the present applicant which increases the challenges to achieve low SO₂ and NO_x emissions.

In a subsequent presentation at the Department's Central District Power Generation meeting, GE reaffirmed the characteristics of the reference plant and specifically noted the low NO_x features to the Department's technical representatives.²⁹

Conoco-Phillips, the owner of the coal-fueled technology used at the Wabash, Indiana facility conducted a review of different NO_x and SO₂ control strategies and concluded the following:

"Selexol (for deep sulfur removal to 0.01 lb/mmBtu) with SCR (for NO_x removal to 0.02 lb/mmBtu) incurs a moderate heat rate and capital cost penalty but offers substantial emission improvement." The full (late 2005) presentation is available at:

www.gasification.org/Docs/2005_Papers/29KEEL.pdf

TECHNICAL EVALUATION AND PRELIMINARY DETERMINATION

The main consideration for low NO_x emissions is apparently concurrent deep sulfur removal. This latter requirement is easier to achieve at the present project given the much lower starting point based on low coal sulfur concentration.

In Japan, A 343 MW (net) vacuum residuum (VR)-fueled oxygen-blown IGCC plant started up at the NPC Negishi Refinery in 2003. VR is basically very heavy oil, like refinery asphalt and is one step removed from petroleum. The project has a Chevron-Texaco (now GE) gasifier, syngas cleanup equipment, an MHI F-Class combustion turbine and an MHI SCR system to achieve 2 ppmvd of NO_x and of SO₂@16% O₂. Information about the project is available from MHI. The basic details can be accessed at the following two sites:

www.mhi.co.jp/power/e_power/topics/2003/jul_06.html

www.chevron.com/news/press/2003/2003-07-07.asp

The final example is the 250 MW (gross) air-blown Nakoso Japan coal-fueled air-blown IGCC project now under construction that will start up in 2007. The process used is, like the present application, also aimed at lower rank coals, but operates at higher temperatures. Mitsubishi Heavy Industries (MHI) has single point responsibility for the sponsoring consortium and is the main supplier for (at least) the gasifier, combustion turbine, heat recovery steam generator (HRSG) and SCR system. The SO₂ and NO_x targets for this demonstration project are 8 and 5 ppm @16% O₂. The demonstration project was preceded by pilot gasification on about a 1/9th scale (~ 30 MW_{gross}). The key Japanese experience is shown in the figure below.³⁰

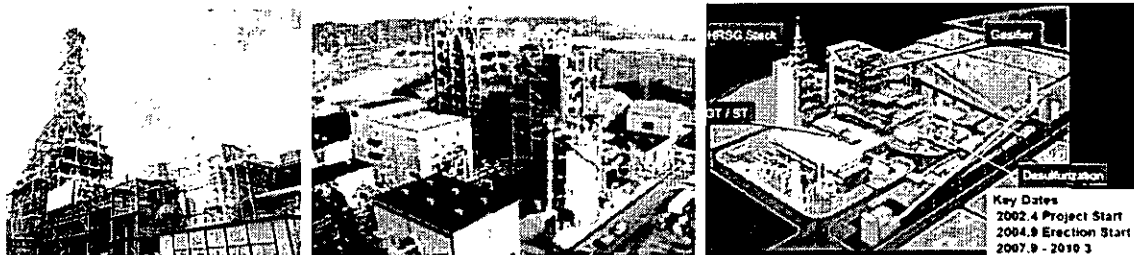

Figure 16. VR IGCC. Pilot & 250 MW Low Rank Coal-fueled, Air Blown, Slagging IGCC

The Department accepts the applicant's proposal of 20 ppmvd NO_x to avoid the requirements of a BACT review pursuant to PSD and provide flexibility within a demonstration project.

This project is required to demonstrate by the terms of the agreements with DOE to demonstrate the efficacy of NO_x control by SCR. The Department recommends an SCR system with sufficient catalyst to achieve 2 and 5 ppmvd (with minimal NH₃ slip) while firing natural gas and syngas respectively. This will insure a valid demonstration of the capabilities of SCR on an air-blown, low temperature, non-slugging, subbituminous coal-fueled IGCC unit with a transport gasifier.

5.5. Sulfur Dioxide (SO₂) and Sulfuric Acid Mist (SAM) Formation and Control

SO₂ and SAM form in the CT and downstream as a result of the oxidation (combustion) of sulfur containing molecules.

Equation 11. Hydrogen sulfide (H₂S) present in the syngas combines with O₂ as follows:

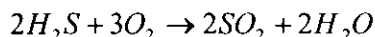

Equation 12. SO₂ is further oxidized depending on the presence of temperature, O₂, and water vapor to yield SAM by the following reactions:



Descriptions of Available SO₂ Controls

SO₂ control processes can be classified into at least four categories: fuel/material sulfur content limitation; adsorption/reaction within the gasifier; absorption during syngas cleanup followed by direct conversion to sulfur or conversion to sulfuric acid; and dry or wet flue gas desulfurization.

Coal sulfur content. Sulfur content in coal can vary greatly. Typical values for coal used in Florida range from roughly 0.6 to 4% depending on: permitted limits; SO₂ Acid Rain strategies; and presence of scrubbers. The applicant selected inherently low sulfur (~0.26%) coal from the Powder River Basin (PRB).

Adsorption/reaction in the gasifier. Referring back to the diagram of the Transport Gasifier (Figure 3), there are provisions for injection of sorbent for in-situ sulfur capture in the gasifier. This approach is not proposed by the applicant on the present project. Basically limestone can be received, stacked, reclaimed, milled and air-fed to the gasifier. This procedure is practiced under oxidizing conditions in circulating fluidized bed (CFB) projects and followed by further polishing elsewhere in the process or post-combustion.

Equation 13. Limestone can be calcined in the gasifier according to:

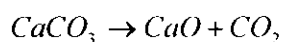

Equation 14. Hydrogen sulfide reacts with lime and limestone within the reducing conditions of the gasifier as follows:

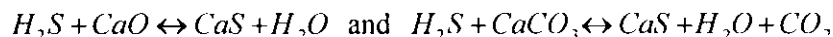

The reactions are reversible and governed by rate constant considerations. Simulations by Southern Company Services (2005) described in a joint paper with DOE, EPRI, and KBR yield a projected reduction in H₂S concentration in the gasifier syngas from 600 to ~100 ppm.³¹ The product is collected with the gasification ash.

In terms of SO₂ emission, this equates to a little more than 0.1 lb/mmBtu compared with the value of 0.015 lb SO₂/mmBtu (~ 0.11 lb SO₂/MWH_{gross}) proposed for this project. This value does not represent the maximum removal possible by this route. The exhaust gas from the HRSG can be further treated, as described in the paper, for SO₂ removal by a flue gas desulfurization (FGD) system or, at least in principle, by the syngas cleanup system.

The post-combustion polishing step described in the paper (Chiyoda CT-121™ FGD Scrubber) would yield SO₂ emissions of approximately 0.01 lb/mmBtu at 90% scrubber efficiency. An emission estimate was not actually given in the paper.

Sulfur removal by Syngas Cleanup. There is a discussion of this step as applied to the proposed project in the process discussion in Section 3.10 above. For reference, complete recovery of the sulfur would yield somewhat less than 10 tons per day (TPD). There are some operational benefits from deep sulfur removal, for example the ability to significantly lower stack operating temperature and improve cycle efficiency. According to TECO:

"Polk's stack dew point is typically between 240 °F and 250 °F. Deep sulfur removal would lower this dew point to the 200 °F range. Each degree that the stack temperature can be lowered represents about 1 mmBtu/hr available to the cycle."³²

Most of the available controls were developed for cleaning natural gas or refinery waste gases which is often done on a large scale basis. The following more general description of sulfur cleanup processes is taken directly from a comprehensive DOE report on Major Environmental Aspects of Gasification-based Power Generation Technologies.³³ While the Department does not agree with everything in the report, the following section describing acid gas cleanup and sulfur removal appears accurate and concise.

"Conventional acid gas removal processes treat the syngas via contact with chemical or physical solvents to capture H₂S and some of the CO₂. Amine solvents, such as MDEA (methyldiethanolamine), react to form a chemical bond between the acid gas and the solvent. Physical solvents, such as Selexol (dimethylether or polyethylene glycol) or Rectisol (cold methanol) remain chemically non-reactive with the gas, which avoids the formation of meta-stable salts that sometimes impacts amine systems. The cleaned gas is sent to the downstream conversion device, such as a combustion turbine. The rich amine (or other solvent) from the absorber is sent to the stripper where it is stripped of acid gases. The amine (or other solvent) from the absorber is recycled and the recovered acid gases are sent to a sulfur recovery process for conversion into by-products.

"Sulfur recovery processes recover sulfur either as sulfuric acid or as elemental sulfur. Sulfuric acid plants convert the H₂S to SO₂ by combustion with air. The SO₂ is oxidized to form SO₃ which is then scrubbed with weak sulfuric acid to make 98% H₂SO₄. The remaining SO₂ and SO₃ are at low enough concentrations to permit discharge to the atmosphere. A sulfuric acid plant typically recovers 99.8% of the H₂S feed.

"For high recovery efficiency, sulfur recovery processes often are comprised of two processes, one for bulk removal, and a second for fine recovery from bulk tail-gas. The most common removal system is the Claus process followed by a tail-gas treating process such as SCOT (Shell Claus Off gas Treatment) process. A Claus sulfur recovery produces elemental sulfur from the H₂S in the syngas in a series of catalytic stages. Part of the H₂S is burned to produce SO₂, which is then reacted with the remaining H₂S to produce elemental sulfur and water. The Claus process removes about 98% of the sulfur in the syngas, and the tail-gas is then sent to a SCOT process for further recovery. The SCOT system is amine-based and can achieve an overall sulfur recovery of 99.8%. High quality elemental sulfur is recovered which can be sold commercially. Other commercially available processes include wet oxidation systems such as Stretford, LO-CAT, and Sulferox."

TECHNICAL EVALUATION AND PRELIMINARY DETERMINATION

For reference, the previously mentioned coal-fueled IGCC chemical facility at Kingsport, TN achieves 99.9% sulfur removal by a process called Rectisol. Recently, several new or previously developed sulfur removal technologies have been evaluated for sulfur removal sometimes in conjunction with CO₂ removal schemes. To summarize, the prospects for deep sulfur removal are good given the already low sulfur in the PRB coal.

Further details regarding CrystaSulf. An initial discussion of CrystaSulf was given in Section 3.10 above as part of the specific process description. In this section CrystaSulf is evaluated as a sulfur removal technique with respect to achieving BACT.

The applicant has selected CrystaSulf as previously described in the process section. Few details were provided by the applicant except that CrystaSulf will reduce H₂S in the gasifier syngas from about 600 to approximately 12 ppm or 98% removal.

According to the applicant's Sufficiency Responses, *"a removal efficiency approaching 99% could be theoretically be achieved applying CrystaSulf. However, CrystaSulf has never been demonstrated in this type of process, and the applicant has not proposed a permit that assumes its maximum theoretical potential."*

Notwithstanding the above statement, the applicant's basis for the performance guarantee for the combustion turbine is 4 ppm of H₂S (equivalent to 99.3% removal) and 1 ppm of COS.³⁴

The Department researched some of the information available about CrystaSulf that is found in the literature. According to CrystaTech's description, CrystaSulf converts the H₂S into dissolved sulfur in the absorber rather than solid sulfur particles. They claim foaming, plugging, and other operational issues associated with similar processes are avoided. They also estimate the economic range of CrystaSulf is in the range of 0.2 to 25 tons TPD of sulfur. In that regard, the expected sulfur production (<10 TPD) from the proposed project falls squarely within this range. According to a CrystaTech paper:³⁵

CrystaSulf is a nonaqueous process that effectively treats gas with too much H₂S to use a scavenger system but too little H₂S to use an amine/Claus approach" (Department note: for example such as used at TECO Polk Power Station)

CrystaSulf was selected for demonstration at a large existing gas conditioning plant at a North Sea terminal that will process between 750 million and 1,600 million standard cubic feet per day (mmscfd) of mildly sour natural gas. For reference this amount of flow is greater than the entire capacity of the Gulfstream Pipeline. The sweetening is accomplished in a two-step process beginning with molecular sieves that produce "offgas" that contains the removed H₂S for further treatment and return to the rest of the stream.

The second step is the CrystaSulf unit that will treat between 13.4 and 134 mmscfd of offgas from the molecular sieves. The cleaned offgas will be returned for distribution with the rest of the stream already treated by the molecular sieve system. Thus CrystaSulf will need to handle a stream with a large flow variation and variable sulfur content with a peak value of 276 ppm H₂S. The product specification is 3.3 ppm H₂S. Typically such specifications are met with a margin of safety. The CrystaSulf system at the North Sea project will certainly need to be designed to meet 99% H₂S removal.

TECHNICAL EVALUATION AND PRELIMINARY DETERMINATION

For comparison, the Stanton Unit B project will consume about 55 to 60 mmscfd of natural gas when syngas is not available but will consume about 300 mmscfd of syngas when it is available. The difference is due to the low heating value of the syngas. The sulfur presented to the CrystaSulf system at Stanton Unit B will have a concentration of approximately 600 ppm and the gas flow and H₂S concentration will be more constant than the North Sea case. Reduction to the range of 4 ppm appears feasible and consistent with the values given by the applicant to GE in conjunction with the CT emission guarantees.

An option to insure a further margin of safety is to inject enough sorbent into the gasifier to bring down the sulfur to levels where CrystaSulf can easily meet the low specifications given to GE. Following are some pictures from CrystaTech's paper available at:

www.crystatech.com/pdf/2005%20GPA%20paper%20-%20CrystaSulf.pdf

The first set of figures show the North Sea Emden facility and a CAD drawing of the presumably installed CrystaSulf plant. CrystaSulf believes the sulfur crystals are of superior quality and included comparative pictures of their non-aqueous product against an aqueous system.

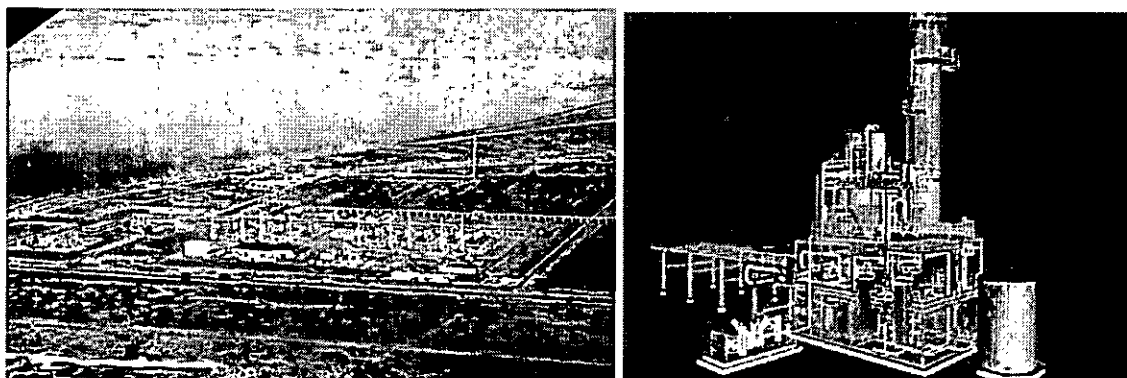

Figure 17. Emden, Germany Norsesea Terminal 2-D CAD of Emden CrystaSulf Plant

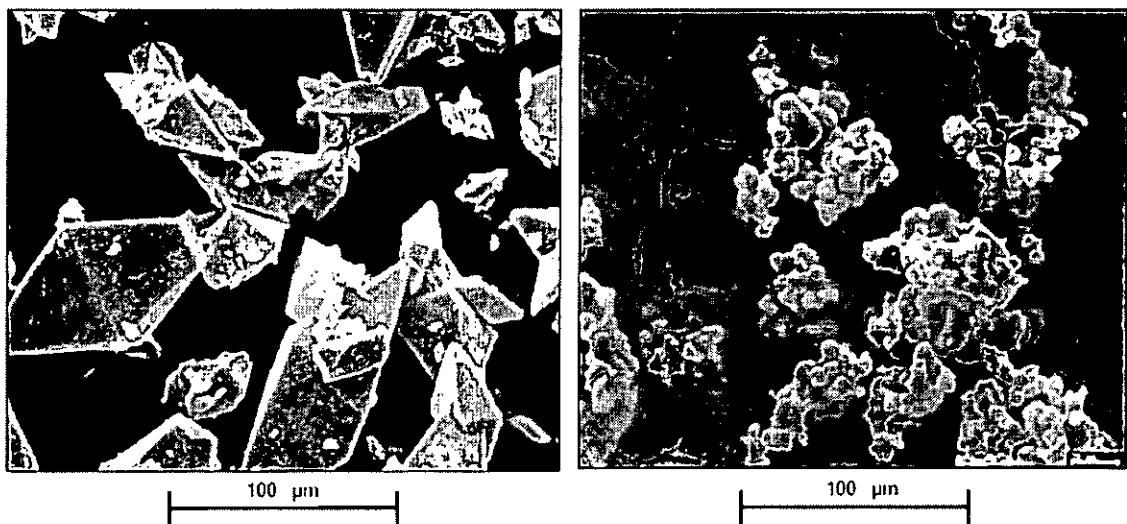

Figure 18. Nonaqueous CrystaSulf Product. Product of Aqueous System (per CrystaTech)

TECHNICAL EVALUATION AND PRELIMINARY DETERMINATION

According to the previously cited SCS/DOE/EPRI/KBR paper, the total estimated cost of CrystaSulf is \$20,000,000 for an air-blown, PRB coal-fueled IGCC plant using KBR Transport Gasifiers with twice the generating capacity as planned Stanton Unit B. Presumably the smaller capacity installation at OUC will cost somewhat more than half the price.

Amine Scrubbing Alternative. SCS/DOE/EPRI/KBR also considered amine scrubbing for a theoretical air-blown coal-fired IGCC process using the KBR Transport Gasifier.³⁶ The cases studied, however, are in conjunction with carbon dioxide removal (CO₂) and compression for disposal. Those cost and energy impacts overwhelm the isolated question of the possible sulfur removal by amine (actually methyl diethanolamine - MDEA) scrubbing.

However it was clear that MDEA also provided deep sulfur removal and that the overall syngas treatment process can substantially reduce ammonia (NH₃) in the syngas to values apparently less than planned for Stanton Unit B.

Stack Gas Cleanup. It is possible to remove sulfur as SO₂ in the exhaust gas (rather than as H₂S in the syngas). However the volume of exhaust gas to be treated is much greater because combustion has been completed and the products are at atmospheric pressure rather than the 30 or more atmospheres under which syngas is processed.

As previously discussed, stack emissions treatment was considered as one of four conceptual designs for gasification of PRB coal using a KBR Transport Gasifier. The simulation was for a stack gas scrubber to be used in conjunction sorbent injection at the gasifier. According to the study, the option gave the best energy efficiency because the syngas does not have to be cooled to near atmospheric temperature for sulfur (and Hg removal). However, the paper concludes that 22 MW less of electrical power is produced from the steam turbine compared with syngas cleanup.

The Department accepts that stack scrubbing may be viable, at least for PRB coal processed as described in the mentioned article.

Applicant's SO₂ Proposal

The applicant proposed that BACT emission limits for Stanton Unit B will be achieved by the low sulfur content of PRB coal in conjunction with the CrystaSulf process to treat the syngas to 12 ppm of H₂S.

The applicant proposed the following BACT limits for SO₂:

- Gas Firing: Use of pipeline natural gas (containing 0.25 gr S/100 scf)
- Syngas Firing: 0.015 lb SO₂/mmBtu. This equates to approximately 0.13 lb/MWH

Department's BACT Determination

According to the applicant, even at these low levels, SO₂ can cause particulate formation and fouling of HRSG surfaces and affect the possibilities for NO_x and CO control by the post combustion catalysts typically used to treat combustion turbine emissions.

The Department believes that at an SO₂ emission rate of 0.01 lb SO₂/mmBtu (~ 8 ppmv sulfur in the syngas, ~1.8 ppmvd SO₂ in the exhaust and ~0.072 lb/MWH_{gross}) such possibilities will be minimized. In addition, this value is the Department BACT determination. There are numerous references to support this position beginning with the GE and Conoco-Phillips presentations that were previously discussed.

More specifically, Bechtel (a key partner of GE in IGCC development), stated:

*Sulfur compounds in the syngas are oxidized to SO₂ in the gas turbine combustor and leave the system in the gas turbine exhaust. SO₂ affects the acid dew point of the exhaust which in turn affects the allowable stack temperature and materials. Also, low sulfur syngas (<20 ppmv total sulfur species) is required to permit operation of a SCR without significant fouling from ammonium sulfate compounds. Achieving very low sulfur syngas typically requires COS hydrolysis combined with acid gas removal using a physical solvent or a mixed solvent.*³⁷

The value of 20 ppmv of sulfur in the syngas cited by Bechtel should be translated to 10 ppmv for the air-blown gasifiers because of the presence of 50% N₂ in the treated stream. The applicant proposes a marginally greater value, equivalent to 12 ppmv but as discussed above can achieve lower values using the CrystaSulf system alone or with some measure of sorbent injection in the gasifier. Furthermore, the applicant's sulfur specification for the combustion turbine guarantee is 4 ppmv (equivalent to ~ 0.005 lb/mmBtu and 0.04 lb/MWH).

The applicant proposal to use pipeline natural gas is acceptable. However the presumption that the gas actually contains <0.25 gr S/100 scf is erroneous because FERC tariff is actually allows 10 gr/100 scf (in consideration of odorant addition) and the natural gas actually available contains more than 0.25 gr S/100 scf.

The Department has consistently issued permits with BACT SO₂ limits 2 gr S/100 scf, for example for the FMPA Treasure Coast project, FP&L Turkey Pt. Unit 5, and draft FP&L West County project. The Department will also set a value of 2 gr S/100 scf for the proposed project. Allowable emissions will be adjusted accordingly, but will not exceed emissions allowed when firing syngas.

5.6. CO and VOC Formation and Control

CO and VOC Formation and Combustor Characteristics

CO and VOC are emitted from combustion turbines due to incomplete fuel combustion. Most combustion turbines incorporate good combustion to minimize emissions of CO and VOC. The obvious control techniques are based upon high temperature, sufficient time, turbulence, and excess air. Additional control can be obtained by installation of oxidation catalyst.

The Department does not have CO and VOC versus load curves for the GE7FA+e. However the applicant has proposed the CO/VOC emissions limits given in the table in following page (shown as variable load). The values are given in terms of ppmvd corrected to 15% oxygen (ppmvd@15% O₂). Additional applicant estimates are included for the 50 and 75% load cases also in terms of ppmvd@15% O₂.

In the final row of the table, the Department included the CO/VOC information provided by the applicant regarding the GE guarantee for the project. According to the applicant's Sufficiency Responses received May 8, 2006 GE provided a guarantee of 25 ppmvd (uncorrected) for the GE7FA+e that uses the syngas version of the diffusion MNQC's rather than the lean premix DLN 2.6 combustor.³⁸

TECHNICAL EVALUATION AND PRELIMINARY DETERMINATION

Table 6. Projected Carbon Monoxide Emissions from OUC Stanton B (70 °F)

Fuel Fired	Syngas CO/VOC Emissions (ppmvd) ⁴		Natural Gas CO/VOC Emissions (ppmvd) ⁴		
	Percent of Full Load	DB Off	DB On ⁵	DB Off	DB On ⁵
Variable ¹		17/5	21/7.8	25/7.7	28/10.1
100 ²		15.8/4.7	20.5/6.9	20.5/6.8	27.2/10.1
75 ²		16.1/4.8		21.2/6.5	
50 ²				23.6/7.6	
75-100 ³		25/1.4		25/1.4	

1. Applicant proposal for BACT.
2. Information given application for different levels of operation and at 70 °F.
3. GE Guarantee. CO and VOC values expressed in terms of ppmvd and ppmvw (wet) and not corrected for O₂.
4. Values in ppmvd@15% O₂, except for final row.
5. Duct burner used only when operating at or near 100% of CT full load.

The Department requested a budgetary capital cost (freight on board, plant gate) from Engelhard to reduce emissions from the values in the table to 5 ppmvd (4.1 ppmvd@15% O₂) for all of the identified modes of operation (natural gas, syngas, duct burners on/off). The estimate was \$605,000 including the catalyst internal frame, gas seals, and catalyst modules.³⁹

Unlike SCR catalyst for NO_x control, oxidation catalyst for CO control is a passive system and requires no reagent. The cost-effectiveness estimated with the assistance of EPA Region 4 personnel was less than \$1,000 per ton removed.⁴⁰ The cost-effectiveness would be even more favorable for a goal of 2 ppmvd.

The following graph from a GE publication (2001) shows the cost-effectiveness of oxidation catalyst for GE 7FA CT's firing natural gas with special focus on those that use DLN combustors.⁴¹ It is useful for the cost effectiveness *trends* to achieve 2 ppmvd for different initial CO concentration levels from the CT. Starting with emissions of 25 ppmvd (as proposed for the present project), the graph suggests cost-effectiveness less than \$2,000 per ton removed for projects in 2001.

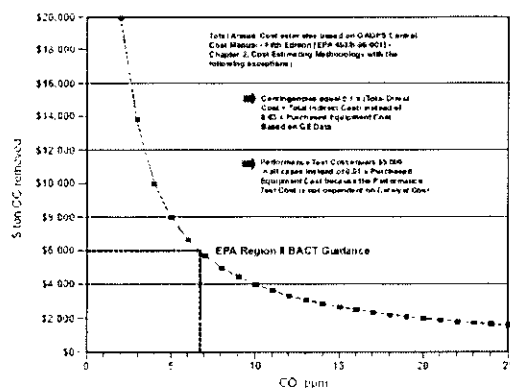

Figure 19. Cost Effectiveness of Oxidation Catalysts

TECHNICAL EVALUATION AND PRELIMINARY DETERMINATION

Notably, Engelhard estimated SO₂ to SO₃ conversion at only 3% whether burning syngas or natural gas and only 5% with the duct burner in use compared with the applicant's claim that an oxidation system would be expected to convert up to 90% of the CT exhaust stream SO₂ to SO₃ and cause an additional shutdown per month due to HRSG fouling.⁴²

The possibility of oxidation catalyst for CO control was apparently considered based on the OUC/Southern Company Services IGCC Diagram (Figure 4 above) from a DOE presentation.

Similarly, the GE 7FA units fired on natural gas have been approved with limits of approximately 1.4 ppmv of VOC. Interestingly, GE guarantees 1.4 ppmv (wet) and uncorrected for loads between 75 and 100%. The values would be even less after correction. However the range proposed by the applicant based on the above table is from 4.7 to 10.1 ppmv @15% of VOC (greater if uncorrected). According to the applicant's proposal the duct burner adds at least 5 ppmv to GE's 75-100% base case for syngas when the duct burner is used. Similarly the applicant's proposal adds more than 8 ppmv to GE's 75-100% base case for natural gas when the duct burner is used.

The co-benefits of VOC reduction further improve the attractiveness and cost-effectiveness of oxidation catalyst for CO control. Furthermore, this would, conservatively speaking, reduce VOC emissions from 128 TPY to the point of marginal PSD and BACT applicability (40 TPY).

Finally, 40CFR63, Subpart YYYYY applicable to stationary gas turbines specifies an emission limit of 91 parts per billion (ppbv) of formaldehyde (CH₂O). The Subpart was stayed for lean premix combustors and for diffusion flame combustors. However that is virtually the entire universe of combustors. The estimated mass emission rates submitted with the application suggest greater CH₂O emissions concentrations than specified in the "stayed" Subpart YYYYY. While not specifically requiring oxidation catalyst to control CH₂O, it is another co-benefit of requiring this strategy for CO control.

Duct Burner Considerations

The presence of a duct burner (refer to Figure 14, Component 4) complicates the evaluation somewhat. Turbine exhaust gas (TEG) enters the HRSG at a relatively high temperature (~1,100 °F) and high excess air. In the design shown in Figure 14, some of the heat is used by a high pressure superheater (Component 3). The gas-fired duct burner (Component 4) restores heat to the TEG prior to entering a second superheater (Component 6). Figure 20 shows an individual burner and an array comprising a duct burner. The hot TEG serves as combustion air for gas introduced into the burner array.

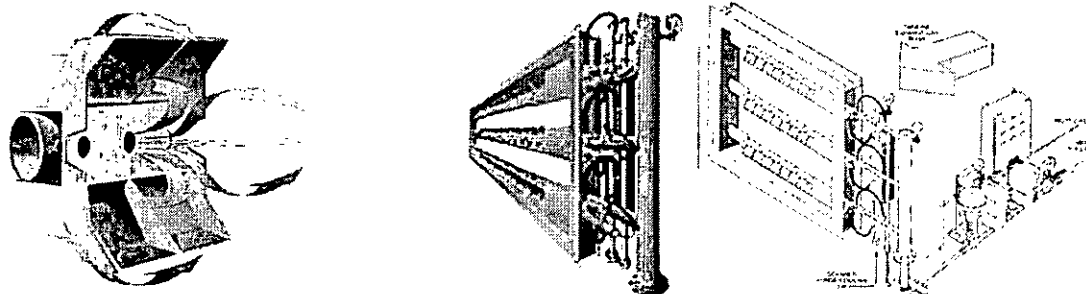

Figure 20 – Individual Burner and Array within Supplementary-Fired HRSG (Coen)

TECHNICAL EVALUATION AND PRELIMINARY DETERMINATION

The ignition temperatures for CO and methane (not counted as VOC) are between 1,100 and 1,200 °F. VOC such as ethane and propane ignite at temperatures less than 900 °F. All of the necessary conditions are present to minimize further CO and VOC concentration increases (if not mass emission increases) when corrected to 15% oxygen.

Department's CO and VOC BACT Proposal

The Department has determined that oxidation catalyst is cost-effective to control CO, VOC and formaldehyde emissions. The applicant was requested to provide information on the cost effectiveness of control all of the pollutants reviewed including CO. The applicant declined to provide any cost-effectiveness calculations based on the claim that the proposed emission limits are the maximum level of control that is "technically feasible". The foregoing analysis refutes that claim for CO and refutes the claim that most of the SO₂ will be oxidized by the oxidation catalyst to SO₃ with additional consequences.

The Department proposes a single set of limits based on achievement of 4.1 ppmvd CO and 2.4 ppmvd VOC whether natural gas or syngas are fired and whether or not the duct burner is used. Any further reduction of the VOC limit would yield annual emissions less than 40 TPY and avoid PSD and BACT applicability.

The Department in accordance with BACT and the objectives of 403.061(18) will require installation of oxidation catalyst during the second year of operation. This will provide time to: stabilize operation of the gasifier; review the performance of the syngas cleanup systems; gain experience with SCR system; and to implement needed changes (e.g. better scrubbing if needed) based on the findings during the first year.

5.7. Ammonia (NH₃) Emissions

The applicant did not propose an NH₃ emission limit or a maximum slip value in conjunction with the SCR system. In section 5.4 above the Department recommended that the SCR system be designed to achieve 2 and 5 ppmvd of NO_x while operating on natural gas and syngas respectively with minimum NH₃ slip in order to conduct a valid demonstration of SCR.

The Department routinely sets NH₃ limits of 5 ppmvd @15% O₂ for projects combined cycle projects that rely on SCR for NO_x control. The same value will be set for Stanton B. However, the Department notes that very low NH₃ emissions are achievable even with very low NO_x emissions by designing a sufficiently robust SCR reactor. The data in Section 5.4 above for the Mystic Station and ANP Blackstone Station in Massachusetts shows that it is possible to simultaneously meet limits of 2 ppmvd NO_x and 2 ppmvd NH₃.

Because of the applicant's belief that there will be a greater number of forced HRSG outages if NO_x emissions are low, the Department recommends that the SCR system also be designed with sufficient catalyst for minimum NH₃ slip (<2 ppmvd). This will make less NH₃ available to participate in the reactions described by Equations 8, 9, and 10 above. At the same time it will provide the opportunity to vary NH₃ (within the slip limit of 5 ppmvd) to discourage the formation of the most damaging of the compounds formed by these reactions. It is less desirable to form ammoniated "acids" than to form neutral ammoniated "salts".

Sufficient catalyst will control slip and will also minimize the potential for fine particulate formation in the exhaust gases and in the environment.

5.8. Particulate Matter (PM/PM₁₀) Control

PM/PM₁₀ Formation and Control Options

PM and PM₁₀ emitted from combustion turbines are typically due to incomplete fuel combustion. They are minimized by use of clean fuels and good combustion. Natural gas and syngas will be the only fuels fired and are efficiently combusted in gas turbines. Clean fuels are necessary to avoid damaging turbine blades and other components already exposed to very high temperature and pressure. Natural gas is an inherently clean fuel and contains no ash.

The syngas will contain a great deal of gasifier ash prior to cleanup in the HTHP (660 °F, 500 psia) filters described in Section 5.3 above. The applicant proposed PM/PM₁₀ limits as BACT of 0.013 and 0.017 lb/mmBtu when firing syngas and natural gas respectively. This suggests that emissions of PM/PM₁₀ are greater for natural gas than syngas.

However, the applicant estimated emissions of 36.3 and 23.3 lb/hr for syngas and natural gas, implying the reverse. The contributors to this apparent contradiction include the greater overall combined cycle efficiency when firing natural gas (~50%) and the power production when firing syngas. The projections are for filterable PM/PM₁₀. The applicant proposed a permitted limit of 36.3 lb/hr to cover all cases and proposed and an opacity of 20%.

The following table is a summary of PM₁₀ emissions provided by General Electric to FP&L from GE 7FA units operating on natural gas.^{43,44} There is great variation in PM₁₀ emissions even though the units are similar if not identical and all relied on the natural gas supply.

Table 7. PM₁₀ Emissions from GE 7FA Units Firing Natural Gas

<u>Fuel</u>	<u>Range (lb/hr)</u>	<u>Average (lb/hr)</u>	<u>~lb/mmBtu</u>
Natural Gas - Front-half (filterable)	0 - 17	4.8	0 - 0.009
Natural Gas - Back-half (condensable)	0 - 15	14	0 - 0.008
Natural Gas Total	1 - 29	7.5	0.0005 - 0.016

All of the values for filterable PM₁₀ are significantly less than proposed by the applicant for Stanton B when firing natural gas. The average value is less than 1/4th of the Stanton Unit B proposal for filterable PM₁₀.

GE's reference plant (as of mid-2005) included a PM estimate of 0.005 lb/mmBtu for front-half filter catch when firing syngas, assuming deep sulfur removal and low NO_x emissions.⁴⁵ It appears that GE expects very low PM emissions when combusting syngas.

The very high combustion temperatures, use of inherently clean natural gas or cleaned syngas, and a relatively low ammonia emission limit will insure that PM/PM₁₀ emissions will be very low and likely less than estimated by the applicant. Rather than set a specific emission limit for PM/PM₁₀ (given the great variance in estimates), the Department will set 10% opacity as BACT in conjunction with the use of clean fuels and high temperature/high excess air combustion.

TECHNICAL EVALUATION AND PRELIMINARY DETERMINATION

The Department proposes a relatively low NH_3 limit of 5 ppmvd @15% O_2 as part of the PM/PM₁₀ BACT determination but recommends that the system be designed to achieve < 2 ppmvd of NH_3 for the reasons given in the next section. The low SO_2 , NO_x , NH_3 , and PM/PM₁₀ strategies give assurances that direct fine particulate emissions and formation in the environment by precursors emitted from the project will be minimized.

Based on 403.061(18), F.S., the Department will require annual testing of front and back-half PM catch to develop a knowledge base for particulate emissions from this process.

5.9. Review of Fouling Potential Information

The applicant submitted a review of the claimed increased HRSG fouling potential by greater oxidation of SO_2 to SO_3 in the presence of oxidation catalyst for CO control. The following graph was submitted in the Sufficiency Responses and credited to GE and EPRI. But it is clear that the SO_3 information on the top of the graph was added to the GE/EPRI graph.

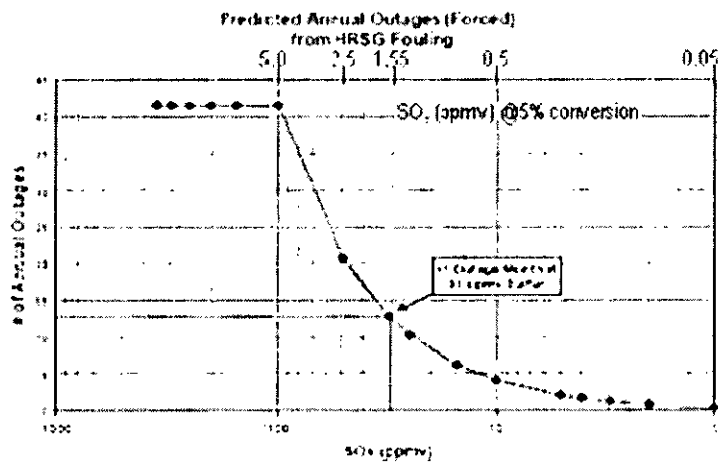

Figure 21. Effect of Ammonium Bisulfate Formation on Plant Availability

The graph contains what appear to be the number of annual forced outages (dependent variable) with respect to SO_x species (independent variable) in the exhaust gas of a combined cycle unit while assuming a constant conversion of 5% of SO_2 to SO_3 . The Department was not provided with the report that is the source of the graph and has not been able to independently evaluate the full context within which the chart was developed. No assumption is given regarding the concurrent NH_3 concentration which is another independent and controllable factor.

With 5% conversion of SO_2 to SO_3 and the applicant's original BACT proposal for SO_2 equivalent to ~3 ppm, the dependent variable ($\text{SO}_x = \text{SO}_2 + \text{SO}_3$) is also equal to ~3 ppm. Thus ~1 shutdown per year was expected by GE or EPRI for this situation at the time the chart was prepared and when they made their assumptions about HRSG design (that may have since varied).

In the applicant's discussion, it appears that SO_3 was used as the independent variable and the same graph was used to infer the number of shutdowns that would occur when there is greater conversion of SO_2 to SO_3 . Actually a different graph would need to be generated for the greater conversion cases or a family of curves developed on the same chart.

Greater conversion to SO₃ possibly implies more sulfate formation, but will necessarily imply less sulfite/bisulfite formation that can be different reasons for HRSG corrosion or shutdowns. The Department does not, for example, accept the inference from the chart that 50% conversion of 3 ppm of SO₂ in the exhaust will cause the same number of shutdowns as 5% conversion of exhaust containing 31 ppm of SO_x.

As previously explained, the conversion by CO catalyst projected in the oxidation catalyst proposal obtained by the Department will be less than claimed by the applicant. The shutdowns should be much less than the number projected by the applicant. The Department concludes that a two catalyst strategy for CO/NO_x control can be accomplished without becoming the cause of excessive HRSG outages. The Department nevertheless appreciates the demonstration nature of the project in general and of the catalyst installations in particular and will provide time to optimize operation of the NO_x control system before installing oxidation catalyst.

5.10. Mercury (Hg) Control

According to the application, emissions of Hg are estimated to be ~20 pounds per year (lb/yr). This value is substantially less than the significant emission rate of 200 lb/year that would otherwise require a BACT determination.

Partitioning of Hg.

As part of an Information Collection Request, EPA conducted Hg speciation tests at the TECO Polk Power and the Wabash River IGCC plants. The results are summarized in a DOE report on the major environmental aspects of coal gasification.⁴⁶ According to the results:

- Most Hg is emitted in the “zero valence” elemental Hg(0) state;
- At least 60% of incoming Hg is emitted with combustion turbine flue gas;
- A significant portion is removed elsewhere; and
- Potential sinks include ash, wastewater, sulfur by-products, H₂S removal loop, etc.

Applicant's Hg Control Strategy

Following is the applicant's description of the Hg removal process to be incorporated into the syngas cleanup system:⁴⁷

“The mercury removal process will consist of an adsorption column containing activated carbon. The carbon is impregnated with sulfur at a concentration of approximately 10 to 15 weight percent. As the syngas flows through the sulfur-impregnated carbon bed, the mercury is adsorbed and reacts with sulfur form mercuric sulfide (HgS).

“This technology has been demonstrated with coal gasification at the Eastman Chemical Company's chemicals from coal plant in Kingsport, Tennessee, which began operations in 1983. A 90- to 95-percent mercury removal has been reported with a bed life of 18 to 24 months.”..... “[T]he mercury emissions were estimated based on a maximum mercury concentration from testing samples of PRB coal and an expected removal rate (90 percent) from the mercury removal system.”

Based on an the applicant's assumption that Hg in the PRB coal is 80 ppb and that 40% of the chemical energy in the coal is converted to net electrical production (i.e. ~ 8,500 Btu/kWH), the Department calculates emissions as follows:

TECHNICAL EVALUATION AND PRELIMINARY DETERMINATION

$(80 \text{ lb Hg}/10^9 \text{ lb coal})(\text{lb coal}/8.8 \times 10^3 \text{ Btu heat in})(1 \text{ Btu in}/0.4 \text{ Btu out})(3.41 \times 10^6 \text{ Btu out}/\text{MWH})(0.1 \text{ lb Hg out}/\text{lb Hg in}) =$
The result is $7.7 \times 10^{-6} \text{ lb Hg}/\text{MWH}$ versus the limit of $20 \times 10^{-6} \text{ lb}/\text{MWH}$ given in 40CFR60, Subpart Da for IGCC units operating on syngas.

The Department has reasonable assurance that the proposed project will comply with the proposed emission rate. Nevertheless, the Department considers it important to document some of its research conducted during the course of reviewing the present project.

TECO Polk Power Station Tests

Chevron-Texaco (previous owners of O₂-blown process used at TECO) tested Hg removal in 2002 on a slipstream at the Polk Power Station.⁴⁸ According to Chevron-Texaco-TECO presentation, the conclusions are as follows:

- Hg can be removed to a level of ~ 0.1 to 0.2 micrograms/normal cubic meter ($\mu\text{g}/\text{Nm}^3$);
- If one considers the normal concentration of mercury in coal of 50 to 100 ppb, then it appears that approximately 98 or 99 percent removal is possible;
- If the period of November 4-15 is considered, then “we are removing over 90 percent of the mercury in the feed to the bed and perhaps 95 percent of the mercury in the gasifier feed”;
- About 50 percent of the mercury in the feed stock typically does not appear in the syngas;
- These results are based on a feed stock to the gasifier that contained 50 percent petroleum coke with essentially no mercury and abnormally high soot recycle, resulting in unusually low mercury content in the synthesis gas; and
- These results should be viewed as a preliminary but extremely encouraging demonstration that Hg can be effectively controlled in an IGCC plant based on the Texaco (now GE) O₂-blown Gasification Process.

The test results at the TECO IGCC suggest that values from 0.8 to $1.5 \times 10^{-6} \text{ lb Hg}/\text{MWH}$ can be achieved, assuming the same Hg content present in the coal that will be used for the present project.

Molecular Sieve Experience on Natural Gas

Mercury is also present in most natural gas streams to varying levels. According to UOP, a supplier of natural gas conditioning systems, the levels in natural gas have ranged from less than detectable to $120 \mu\text{g}/\text{Nm}^3$ of gas.⁴⁹ Hg is known to damage aluminum heat exchangers to the point of catastrophic failure and therefore its removal is necessary under such circumstances.

UOP™ employs molecular sieve Hg adsorbents (HgSIV) within certain existing natural gas dryers. The material contains silver on the outside surface of the molecular sieve pellet or bead. The Hg amalgamates with the silver, and a mercury free, dry gas. In one case, UOP claims reductions of Hg by much more than 99%. This involves reduction of Hg from 25-50 $\mu\text{g}/\text{m}^3$ to less than $0.01 \mu\text{g}/\text{Nm}^3$ on a very large stream of 283 million standard cubic feet (mmscfd). The reference conditions were 64°F and 600 psig.

DOE-Parsons Cost Estimate

According to a DOE-sponsored study by Parsons, “IGCC plants have the potential of removing mercury from the syngas upstream of the gas turbine. Syngas volumes are much smaller at this point”.⁵⁰ “As a result, mercury removal in an IGCC power plant can be expected to be very high in removal effectiveness, low in cost, and reliable in design.”

TECHNICAL EVALUATION AND PRELIMINARY DETERMINATION

Parsons developed cost estimates for Hg removal from a "TECO" style IGCC facility using "Eastman" style control by Calgon Carbon sulfur-impregnated adsorbent.

The main assumptions are:

- A 250 MW (net) O₂-blown plant with GE gasifier and GE 7FA Combustion Turbine;
- 100 ppb Hg in the coal with 90 (one bed) and 99% (two beds) Hg removal from syngas;
- Hg removal located upstream of the acid gas removal system (desulfurization); and
- Low humidity gas, 103°F, 368 psig, and 20-second residence time.

The estimated costs and results are as follows:

- Hg reduction is 131 lb per year and 90% at cost of \$0.25/MWH and \$3,412/lb Hg removed;
- Capital Recovery and Operation & Maintenance (O&M) costs total \$446,000 per year;
- Hg reduction is 143 lb/yr and 99% at cost of \$0.39/MWH and \$4,791/lb removed;
- Capital Recovery and O&M costs total Capital and O&M costs are \$685,000 per year;
- Total Capital Costs (installed) are \$834,000 and \$1,680,000 for 90 and 99% reduction;
- Capital and O&M costs are unaffected by increasing coal Hg concentration; and
- Adsorbent replacement is based on buildups of pressure, water, contaminants (not Hg).

At the 99% removal target, Hg emissions would be easily $< 1 \times 10^{-6}$ lb/MWH.

The Department contacted Calgon Carbon to obtain its own information directly from the provider of the technology that will be used in the proposed project. The Department provided Calgon Carbon with the syngas constitution, temperature and pressure entering and leaving and the Hg treatment step.

Following are key features from Calgon Carbon's submittal:⁵¹

- A budget estimate of \$240,000 (+/- 10%) for each of three - 10 ft diameter adsorbers with 20,000 lbs HGR 12x30 will apply. Bed depth is 6.3 feet. Each absorber is a Model 10 Vapor Phase Adsorber described herein (for installation by others). The single vessel includes internals for carbon bed support, man ways for maintenance access, a top access port for carbon fill / removal and nozzles for process connections.
- Calgon Carbon will furnish the initial fill of Type HGR 12x30 Granular Activated Carbon for Mercury Removal from either product or vent gas.
- The Model 10 Vapor Phase Adsorber has the following capability: 3,000 ACFM nominal system flow rate; 8-12 psi pressure drop; and 12x30 mesh granulated activated carbon.
- Built to "Refinery Specifications".
- If Hg inlet is 23.2 µg/dscm in, the outlet is 0.1 µg/dscm out or ~ 99.6% removal.
- Contact time is 10 seconds (presumably per vessel).

The Department has not yet ascertained whether the configuration is in "series" or "parallel." If it is in series, two vessels (to stay within desired pressure drop assumed by applicant) would likely achieve removal in the 98-99% range suggested by the TECO experiment and the Parsons estimates. Three in series to yield 99.6 removal lies somewhere between Parson's estimate and the UOP molecular sieve estimate for gas conditioning plants.

TECHNICAL EVALUATION AND PRELIMINARY DETERMINATION

This review assumed all Hg in the coal reaches the Hg absorber. That has not yet been shown to occur. The high temperature of the particulate removal step suggests little will end up in the ash; however the high pressure suggests the opposite. Similarly could exit with the sour water in the condensation step. The activated carbon system itself will insure little ends up in the sulfur recovery system. In conclusion, the Department believes Hg removal efficiency values greater than 98% to $< 2 \times 10^{-6}$ lb/MWH (even less emissions when lower Hg coal is used) are achievable within an IGCC process that includes a carbon adsorption system. This is better than the present "conventional wisdom" estimates typically cited of 90 or 95% removal.

6. AIR QUALITY IMPACT ANALYSIS

6.1. Introduction

The proposed project will increase emissions of five pollutants at levels in excess of PSD significant amounts: PM/PM₁₀, CO, SO₂, VOC and SAM. PM₁₀ and SO₂ are criteria pollutants and have national and state ambient air quality standards (AAQS), PSD increments, significant impact levels and de minimis monitoring levels defined for them. CO is a criteria pollutant and has only AAQS, significant impact levels and de minimis monitoring levels defined for it. There are no applicable PSD increments, AAQS, significant impact or de minimis monitoring levels for SAM and VOC. VOC is an ozone precursor and any net increase of 100 tons per year requires an ambient impact analysis including the gathering of preconstruction ambient air quality data.

6.2. Major Stationary Sources in Orange County

The current largest stationary sources of air pollution in Orange County are listed below. The information is from annual operating reports submitted to the Department from 2004 and 2005.

Table 8. Largest Sources of SO₂ in Orange County

<u>Owner</u>	<u>Site Name</u>	<u>Tons per year</u>
Orlando Utilities Commission	Stanton Energy Center (Existing)	8840
OUC/Southern Company	Stanton Unit B IGCC (Proposed)	161/108*
Ranger Construction Industries	Ranger Construction-Winter Garden	9

* Applicant proposal/Department's Draft BACT determination

Table 9. Largest Sources of PM in Orange County

<u>Owner</u>	<u>Site Name</u>	<u>Tons per year</u>
Orlando Utilities Commission	Stanton Energy Center (Existing)	394
Orlando Cogen Limited, L.P.	Orlando Cogen Limited, L.P.	195
OUC/Southern Company	Stanton Unit B IGCC (Proposed)	188*
Walt Disney World Company	Walt Disney World Resort	11

* Applicant estimate based on potential to emit. Department expects < 100 TPY.

TECHNICAL EVALUATION AND PRELIMINARY DETERMINATION

Table 10. Largest Sources of CO in Orange County

<u>Owner</u>	<u>Site Name</u>	<u>Tons per year</u>
Orlando Utilities Commission	Stanton Energy Center (Existing)	721
OUC/Southern Company	Stanton Unit B IGCC (Proposed)	635/150*
FL Gas Transmission Co.	FGTC Station 18	60
Kinder Morgan Energy Partners	Central Florida Pipeline	45

* Applicant proposal/Department's Draft BACT determination

Table 11. Largest Sources of VOC in Orange County

<u>Owner</u>	<u>Site Name</u>	<u>Tons per year</u>
FP Spiralkote Inc	FP Spiralkote	142
Regal Marine Industries	Regal Marine Industries	130
OUC/Southern Company	Stanton Unit B IGCC (Proposed)	129/40*
Orlando Utilities Commission	Stanton Energy Center (Existing)	118
Nina Plastic Bags, Inc.	Nina Plastic Bags	95

* Applicant proposal/Department's Draft BACT determination

Table 12. Largest Sources of NO_x in Orange County

<u>Owner</u>	<u>Site Name</u>	<u>Tons per year</u>
Orlando Utilities Commission	Stanton Energy Center (Existing)	9343
OUC/Southern Company	Stanton Unit B IGCC (Proposed)	1006/-19*
FL Gas Transmission Co.	FGTC Station 18	340
Walt Disney World Company	Walt Disney World Resort	321
Orlando Cogen Limited, L.P.	Orlando Cogen Limited, L.P.	195

* Emissions from Unit B/Net reduction due to permanent reduction from existing Units 1/2

6.3. Air Quality and Monitoring in the Orange County

The Orange County Local Program operates twelve monitors at five sites measuring PM₁₀, PM_{2.5}, ozone (O₃), CO, nitrogen dioxide (NO₂) and SO₂. The 2005 monitoring network is shown in the figure below.

Some of the recent trends in ambient air quality are depicted in the following figure.⁵² A large reduction in maximum 3-hour and 24-hour SO₂ trends is obvious. The main reason for the reduction is FP&L's natural gas repowering project at the residual fuel oil-fired Sanford Power Plant. The benefits of the repowering between 2000 and 2002 overwhelmed the startup of coal-fueled Stanton Unit 2 (with a flue gas desulfurization) that occurred in 1997. The net reduction in combined SO₂ emissions from the two plants is on the order of 20,000 tons per year.

TECHNICAL EVALUATION AND PRELIMINARY DETERMINATION

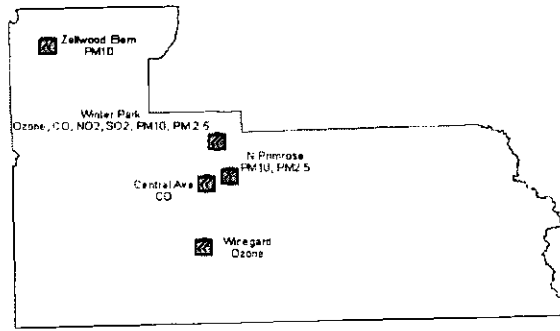

Figure 22. Orange County Ambient Air Monitoring Network

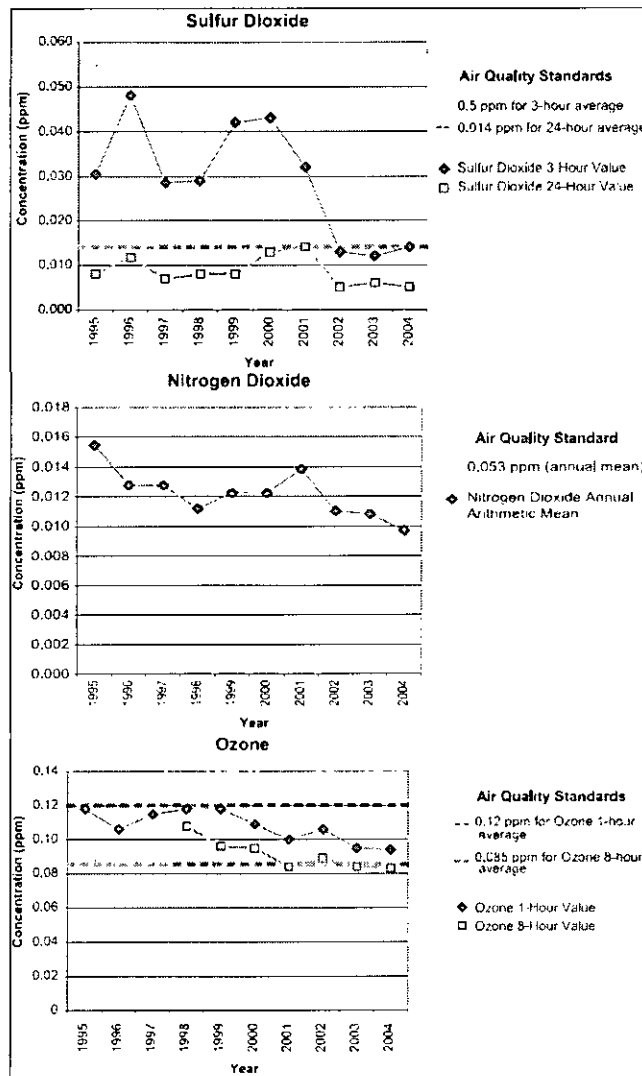

Figure 23. SO₂, NO₂, and Ozone (O₃) Trends in Orange County Florida, 1995-2004.

TECHNICAL EVALUATION AND PRELIMINARY DETERMINATION

A similar trend is noticeable in NO₂, (NO_x indicator pollutant). This again suggests beneficial effects of the Sanford Power Plant repowering project and NO_x emissions reductions even with the Stanton Unit 2 project (that incorporated an SCR system). A trend towards lower ozone is also seen that is partially explained by the reduction in precursors (NO_x). But ozone trends must also reflect VOC emissions, contributions from transportation emissions, the climatological cycles and the presence of meteorological conditions such as hot ambient temperature, solar insolation, high pressure, and relatively low wind speed that contribute to ozone formation and persistence.

Table 13. Ambient Air Quality in Orange County Nearest to Project Site (2005)

Pollutant	Location	Averaging Period	Ambient Concentration				
			High	2nd High	Mean	Standard	Units
PM ₁₀	N Primrose	24-hour	52	34		150 ^a	ug/m ³
		Annual			18	50 ^b	ug/m ³
SO ₂	Winter Park	3-hour	11	9		500 ^a	ppb
		24-hour	4	3		100 ^a	ppb
		Annual			1	20 ^b	ppb
NO ₂	Winter Park	Annual			9	53 ^b	ppb
CO	Central Avenue	1-hour	9	8		35 ^a	ppm
		8-hour	5	3		9 ^a	ppm
Ozone	Winegard	1-hour	0.120	0.114		0.12 ^c	ppm
		8-hour	0.098	0.093		0.08 ^c	ppm
		8-hour	2005 3-yr attainment		0.078	0.08	ppm

* The Mean does not satisfy summary criteria due to missing data.

a - Not to be exceeded more than once per year

b - Arithmetic mean

c - Not to be exceeded on more than an average of one day per year over a three-year period

6.4. Air Quality Impact Analysis

Significant Impact Analysis

- Significant Impact Levels (SILs) are defined for PM/PM₁₀, CO and SO₂. A significant impact analysis is performed on each of these pollutants to determine if a project can cause an increase in ground level concentration greater than the SIL for each pollutant.

In order to conduct a significant impact analysis, the applicant uses the proposed project's emissions at worst load conditions as inputs to the models. The models used in this analysis and any required subsequent modeling analyses are described below. The highest predicted short-term concentrations and highest predicted annual averages predicted by this modeling are compared to the appropriate SILs for the PSD Class I Chassahowitzka National Wildlife Refuge (CNWR) and the PSD Class II Areas (everywhere except the CNWR).

TECHNICAL EVALUATION AND PRELIMINARY DETERMINATION

For the Class II analysis a combination of fence line, near-field and far-field receptors were chosen for predicting maximum concentrations in the vicinity of the project. The fence line receptors consisted of discrete Cartesian receptors spaced at 50-meter intervals around the facility fence line.

The remaining receptor grid consisted of densely spaced Cartesian receptors at 100 meters apart starting at the property line and extending to 3 kilometers. Beyond 3 kilometers, Cartesian receptors with a spacing of 250 meters were used out to 6 kilometers from the facility. From 6 to 15 kilometers, Cartesian receptors with a spacing of 500 meters were used.

According to the application, for the Class I analysis, 2 rings of receptors (each ring had receptors placed at 2 degree intervals for a total of 360 polar receptors) located at the CNWR were used. Each ring was placed at the nearest and furthest edge of the CNWR, approximately 143.7 and 154.6 km respectively. These receptors correspond with receptors provided by the National Park Service.

If this modeling at worst-load conditions shows ground-level increases less than the SILs, the applicant is exempted from conducting any further modeling. If the modeled concentrations from the project exceed the SILs, then additional modeling including emissions from all major facilities or projects in the region (multi-source modeling) is required to determine the proposed project's impacts compared to the AAQS or PSD increments.

The applicant's initial PM/PM₁₀, CO and SO₂ air quality impact analyses for this project indicated that maximum predicted impacts from all pollutants are less than the applicable SILs for the Class II area (i.e. all areas except CNWR). These values are tabulated in the table below and compared with existing ambient air quality measurements from the local ambient monitoring network.

It is obvious that maximum predicted impacts from the project are much less than the respective AAQS and the baseline concentrations in the area. SO₂, PM₁₀ and CO are also less than the respective significant impact levels that would otherwise require more detailed modeling efforts.

Table 14. Maximum Projected Air Quality Impacts from Stanton Unit B IGCC Project for Comparison to the PSD Class II Significant Impact Levels

Pollutant	Averaging Time	Max Predicted Impact (ug/m ³)	Significant Impact Level (ug/m ³)	Baseline Concentrations (ug/m ³)	Ambient Air Standards (ug/m ³)	Significant Impact?
SO ₂	Annual	0.1	1	~3	60	NO
	24-Hour	1	5	~10	260	NO
	3-Hour	3	25	~30	1300	NO
PM ₁₀	Annual	0.4	1	~18	50	NO
	24-Hour	4	5	~52	150	NO
CO	8-Hour	10	500	~6000	10,000	NO
	1-Hour	14	2000	~10000	40,000	NO

TECHNICAL EVALUATION AND PRELIMINARY DETERMINATION

The nearest PSD Class I area is the CNWR located about 144 km to the northwest of the project site. Maximum air quality impacts from the proposed project are summarized in the following table. The results of the initial PM/PM₁₀ and SO₂ air quality impact analyses for this project indicated that maximum predicted impacts from SO₂ and PM₁₀ are less than the applicable SILs for the Class I area. Therefore no further detailed modeling efforts are required for these pollutants.

Table 15. Maximum Air Quality Impacts from the Stanton Unit B IGCC Project for Comparison to the PSD Class I SILs at CNWR

Pollutant	Averaging Time	Max. Predicted Impact at Class I Area (ug/m ³)	Class I Significant Impact Level (ug/m ³)	Significant Impact?
PM ₁₀	Annual	0.003	0.2	NO
	24-hour	0.05	0.3	NO
SO ₂	Annual	0.003	0.1	NO
	24-hour	0.04	0.2	NO
	3-hour	0.1	1	NO

Preconstruction Ambient Monitoring Requirements

A preconstruction monitoring analysis is done for those pollutants with listed de minimis impact levels. These are levels, which, if exceeded, would require pre-construction ambient monitoring. For this analysis, as was done for the significant impact analysis, the applicant uses the proposed project's emissions at worst load conditions as inputs to the models. As shown in the following table, the maximum predicted impacts for all pollutants with listed de minimis impact levels were less than these levels. Therefore, no pre-construction monitoring is required for those pollutants.

There are no ambient standards or *de minimus* air quality levels associated with VOC, which is a precursor for the pollutant ozone. The impacts of VOC emissions on ozone levels are not usually seen locally, but contribute to regional formation of ozone.

Table 16. Maximum Air Quality Impacts for Comparison to the De Minimis Ambient Impact Levels.

Pollutant	Averaging Time	Max Predicted Impact (ug/m ³)	De Minimis Level (ug/m ³)	Baseline Concentrations (ug/m ³)	Impact Greater Than De Minimis?
PM ₁₀	24-hour	4	10	~52	NO
SO ₂	24-hour	1	13	~10	NO
CO	8-hour	10	575	~6000	NO

Projects with VOC emissions greater than 100 tons per year are required to perform an ambient impact analysis for ozone including sophisticated modeling and gathering of preconstruction ambient air quality data.

TECHNICAL EVALUATION AND PRELIMINARY DETERMINATION

The applicant originally estimated annual potential VOC emissions from the project to be 129 TPY. The Department's BACT determination will limit VOC emissions to approximately 40 TPY. This obviates the otherwise applicable requirement to conduct the additional described modeling and monitoring. OUC's proposal to permanently reduce NO_x emissions (the other ozone precursor) from Units 1 and 2 and net out of PSD review for the Stanton B provides an additional reason to forego the ozone modeling.

Such an analysis, if required, could involve very sophisticated and expensive modeling of emissions from the entire region. The key inputs to the model would be traffic, power plants throughout the region, other industrial sources, and meteorology. The uncertainty in those inputs and in the regional ozone model results would be greater than the VOC or net NO_x emissions from this project or the ozone effects.

Based on the preceding discussions, the only additional detailed air quality analysis (inclusive of all sources in the area) required by the PSD regulations for this project is an analysis of impacts on soils, vegetation, visibility, and of past growth-related air quality effects.

Models and Meteorological Data Used in the Foregoing Air Quality Analysis

PSD Class II Area: Both the EPA-approved Industrial Source Complex Short-Term (ISCST3) dispersion model and the AERMOD modeling system was used to evaluate the pollutant emissions from the proposed project in the surrounding Class II Area. The AERMOD modeling system will replace the ISCST3 model November 2006. AERMOD was approved by the EPA November 2005. In the "transition" time period from November 2005 to November 2006, both the ISCST and AERMOD model may be used. This "transition" will allow applicants and the Department to assimilate AERMOD guidance and procedures. The applicant used the AERMOD modeling system for this project. The Department reviewed the modeling submitted by the applicant and used the ISCST model to further verify that the project impacts will not be "Significant."

The ISCST model determines ground-level concentrations of inert gases or small particles emitted into the atmosphere by point, area, and volume sources. It incorporates elements for plume rise, transport by the mean wind, Gaussian dispersion, and pollutant removal mechanisms such as deposition. It allows for the separation of sources, building wake downwash, and various other input/output parameters.

The AERMOD modeling system incorporates air dispersion based on planetary boundary layer turbulence structure and scaling concepts, including the treatment of both surface and elevated sources, and both simple and complex terrain. AERMOD contains two input data processors, AERMET and AERMAP. AERMAP is the terrain processor and AERMET is the meteorological data processor.

A series of specific model features, recommended by the EPA, are referred to as the regulatory options. The applicant and the Department used the EPA recommended regulatory options. Direction-specific downwash parameters were used for all sources for which downwash was considered. The stacks associated with this project all satisfied the good engineering practice (GEP) stack height criteria.

TECHNICAL EVALUATION AND PRELIMINARY DETERMINATION

Meteorological data used in the AERMOD modeling system was processed by AERMET. The AERMET file was submitted to the Department by the applicant. The meteorological data consisted of a concurrent 5-year period of hourly surface weather observations and twice-daily upper air soundings from the National Weather Service at Orlando International Airport and Tampa/Ruskin respectively. The 5-year period of meteorological data was from 1996 through 2000. These airport stations were selected for use in the study because they are most representative of the project site.

Along with National Weather Service data, the AERMET processor requires an input of surface parameters based on land use. These characteristics include albedo, surface roughness and Bowen ratio. The Department is currently creating a series of AERMET files for National Weather Service stations in Florida. Due to the variations in surface parameter values, using uniform data sets created by one entity, the Department will ensure continuity from project to project. The data for Orlando has not been completed. In addition, guidance on surface parameter values is currently still being processed and has been changed since this project was submitted. Therefore, in addition to using AERMOD, the Department used the still approved ISCST model to verify results.

Meteorological data used in the ISCST3 model consisted of a concurrent 5-year period of hourly surface weather observations and twice-daily upper air soundings from the National Weather Service at Tampa/Ruskin. The 5-year period of meteorological data was from 1991 through 1995. In addition, a concurrent 5-year period of hourly surface weather observations and twice-daily upper air soundings from the National Weather Service at Orlando International Airport and Palm Beach International Airport respectively were used. This 5-year period of meteorological data was from 1987 through 1991. These datasets are the most recent available to the Department in the electronic format compatible with the ISCST3 model. In general, meteorological data used for modeling provides typical and potential situations that an area experiences over several years. Therefore, datasets that are not current may still produce accurate modeling results. These airport stations were selected for use in the study because they are the close primary weather stations to the study area and are most representative of the project site. The surface observations included wind direction, wind speed, temperature, cloud cover, and cloud ceiling.

In reviewing this permit application, the Department has determined that the application complies with the applicable provisions of the stack height regulations as revised by EPA on July 8, 1985 (50 FR 27892). Portions of the regulations have been remanded by a panel of the U.S. Court of Appeals for the D.C. Circuit in *NRDC v. Thomas*, 838 F. 2d 1224 (D.C. Cir. 1988). Consequently, this permit may be subject to modification should EPA revise the regulation in response to the court decision. This may result in revised emission limitations or may affect other actions taken by the source owners or operators. A more detailed discussion of the required analyses follows.

PSD Class I Area: The California Puff (CALPUFF) dispersion model was used in a screening mode to evaluate the pollutant emissions from the proposed project in the Class I CNWR beyond 50 km from the proposed project. Meteorological data used in this model consisted of a concurrent 5-year period of hourly surface weather observations and twice-daily upper air soundings from the National Weather Service at Orlando International Airport and Tampa/Ruskin respectively. The data was from 1996 through 2000. Meteorological precipitation, relative humidity and solar radiation data used were from Orlando as well.

TECHNICAL EVALUATION AND PRELIMINARY DETERMINATION

CALPUFF is a non-steady state, Lagrangian, long-range transport model that incorporates Gaussian puff dispersion algorithms. This model determines ground-level concentrations of inert gases or small particles emitted into the atmosphere by point, line, area, and volume sources. The CALPUFF model has the capability to treat time-varying sources, is suitable for modeling domains from tens of meters to hundreds of kilometers, and has mechanisms to handle rough or complex terrain situations. Finally, the CALPUFF model is applicable for inert pollutants as well as pollutants that are subject to linear removal and chemical conversion mechanism.

Ozone

Although ozone modeling is not required, it is useful to qualitatively assess the potential of the project to contribute to ozone concentrations. High ozone concentrations are area-wide pollution problems and the solutions typically involve broad-based local and regional reductions in VOC emissions (one of the precursors to ozone formation). According to the applicant, in 1999, Orange County had total VOC emissions of 43,828 TPY. The Stanton IGCC Project will add 40 TPY of VOC after the Department's BACT requirement, or 0.1% of regional emissions.

Again, the fact that NO_x emissions will not actually increase from the facility insures that ozone impacts from Stanton Unit B will be minimal.

Preconstruction Monitoring Analysis for Ozone

The applicant provided an ozone Ambient Air Quality analysis for the area of Orange County closest to the project site. Referring to Figure 21 and Table 12, there are two ozone monitoring sites in the general area operated by the Orange County Environmental Protection Division. Both monitors are representative of the air quality in the vicinity of the project since ozone is a regional pollutant. Therefore, placing preconstruction monitors at the project site is not necessary to obtain the background air quality concentrations.

The air quality in the vicinity of the project is detailed in above sections. The county is presently in attainment for ozone.

6.5. Additional Impacts Analysis

Impact on Soils, Vegetation, and Wildlife:

There will be net NO_x emission reductions from the Stanton facility because reductions from Units 1 and 2 will offset emissions from Stanton Unit B. Emissions of SO₂ and sulfuric acid mist will be minimized by deep sulfur removal in the syngas cleanup system. This will insure that emissions of these pollutants per unit of energy are the lowest from any coal-fired unit in the United States built to-date. The Department's VOC BACT determination together with the NO_x netting plan will minimize ozone precursors.

As part of the Additional Impact Analysis, Air Quality Related Values (AQRV) are evaluated with respect to the Class I area. This includes the analysis of sulfur and nitrogen deposition. The CALPUFF model is also used in this analysis to produce quantitative impacts. The results of the analysis show that nitrogen and sulfur deposition rates are less than the significant impact levels (0.01 kg/ha/yr) determined by the National Park Service.

The Department concludes that there will be minimal air impacts, if any, on flora, fauna and soils.

TECHNICAL EVALUATION AND PRELIMINARY DETERMINATION

The Oak Ridge National Laboratory (ORNL) is preparing a multidisciplinary Environmental Impact Statement (EIS) under the requirements of the National Environmental Policy Act (NEPA) for the Department of Energy (DOE). The document will ultimately aid DOE in taking agency action to provide federal funds to construct the project. The Department has discussed the status of the EIS with DOE who contracted ORNL to conduct prepare the document. The EIS will include project impacts on all media.

Impact on Visibility:

The applicant submitted a regional haze analysis for the CNWR. The analysis included modeling from the CALPUFF model. The National Park Service threshold for visibility percent change in extinction is 5%. The modeling results concluded that the new IGCC unit will not contribute to an adverse impact. The National Park service has not made any comments regarding this project.

The minimization of acid rain and ozone precursors minimizes fine particulate emissions, fine particulate formation in the environment and thus regional visibility effects.

Growth-Related Impacts Due to the Proposed Project:

There will be minimal increases in the labor force due to this project. According to the applicant, about 72 additional jobs will be created over the U.S. Department of Energy demonstration period. Fifty-three of these employees will remain permanent. This increase will not result in significant commercial and residential growth near the project and will cause no significant impact on the local area.

This project is a response to state-wide electrical growth and is identified by OUC as a project that will allow it to meet electrical generation needs as part of their 10 year plan submitted to the Public Service Commission.

There will be nationwide benefits in that the demonstration project will help stimulate use of subbituminous coal and associated American industries involved with its mining, transportation, gasification, cleanup, combustion, steam generation and electrical power production. This is in-line with growth of the economy in general and less dependence on natural gas that is progressively being provided through foreign shipments of liquefied natural gas (LNG).

Growth-Related Air Quality Impacts since 1977:

According to the applicant, population growth in the area of the proposed project, Orange County, has doubled from 1980 to 2000. Housing units have also doubled in the same time period. The Orlando population as of 2003 was 1,755,000. Most of the growth has been tourism-dominated. This tourism-dominated growth has lead to an increase in mobile source activity in terms of vehicle miles traveled. However, increases in air pollution due to mobile sources have been counteracted by cleaner fuels and technological advances.

The ambient air monitoring data show overall reductions in industrial air pollution statewide and within the project area. New power plants in the area have included good air pollution control equipment and the large existing residual oil fired plant has been repowered with natural gas.

TECHNICAL EVALUATION AND PRELIMINARY DETERMINATION

Endangered Species Considerations

The purpose of the Endangered Species Act is to conserve “the ecosystems upon which endangered and threatened species depend” and to conserve and recover listed species.⁵³ Under the law, species may be listed as either “endangered” or “threatened”.

Endangered means a species is in danger of extinction throughout all or a significant portion of its range. Threatened means a species is likely to become endangered within the foreseeable future. All species of plants and animals, except pest insects, are eligible for listing as endangered or threatened.

While state PSD permits are not generally reviewed for adherence with the Endangered Species Act, the State of Florida’s Power Plant Certification process requires an assessment of existing ecology and determination of project impacts. Volume 1 of the Site Certification Application includes a characterization of the existing environment in the project area including vegetation, land use and ecology. Specifically, within Volume 1, Section 2, the application addresses the effects of construction and plant operation on ecology. These sections are available at State and local environmental program offices.

The “Florida Natural Areas Inventory” (FNAI) of rare species for Orange County is a compilation that includes a review of the potential habitats for rare species that may be found on the project site. Sightings of the Florida Sandhill Crane, Bald Eagle, Gopher Tortoise and the American Alligator have been documented. Volume 1, Section 2 includes a summary of rare species and natural communities in the project area (including the previously mentioned wildlife), as well as the legal status (e.g. endangered, threatened, listed, etc.) and descriptions of habitat characteristics developed from the FNAI, Florida Fish and Wildlife Conservation Commission and the U.S. Fish and Wildlife Service (USFWS). The relevant sections of the Site Certification Application with this information are available at the State and local environmental program offices.

The most notable Endangered Species onsite of the Stanton facility is the red-cockaded woodpecker. Nesting clusters has been sited on property. The effects of emissions on the red-cockaded woodpecker were evaluated by the applicant. According to the applicant, the OUC Stanton site has a buffer of land, habitat for the woodpecker that is in an area that will not be impacted from Unit B air emissions. Following is a picture of the woodpecker as well as other species found regionally.

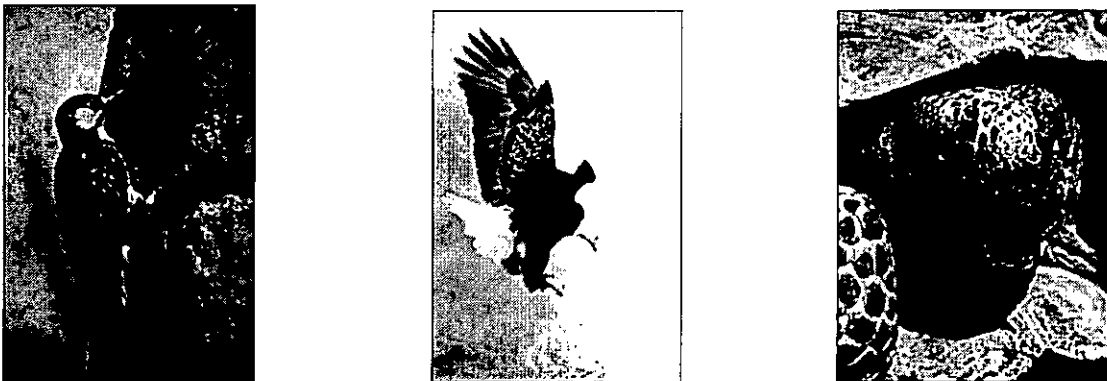

Figure 24. Red-Cockaded Woodpecker, Bald Eagle, Gopher Tortoise (USFWS)

TECHNICAL EVALUATION AND PRELIMINARY DETERMINATION

According to the U. S. Fish and Wildlife Service (F&WS) website at there were 111 threatened or endangered species (per the federal list) in Florida on May 18, 2004. The reader is referred to the following website: http://ecos.fws.gov/tess_public/TESSWebpageUsaLists?state=FL

The EIS under preparation by ORNL for DOE will include a specific section including a Consultation Letter under Section 7 of the Endangered Species Act.

7. CONCLUSION

The Department has reasonable assurance that the proposed Stanton Unit B project will comply with the Department's regulations and has made a preliminary decision to issue a permit under the Rules for the Prevention of Significant Deterioration. The Department has reviewed the BACT proposals and either approved them or made them stricter in line with its authority under the PSD regulations.

Based on the ambient air quality review the Department concludes that the project will neither cause nor contribute to a violation of ambient air quality standards or increments. Further there will not be significant impacts on soils, wildlife or vegetation.

The Department has made a preliminary decision to issue a PSD permit for the proposed project and will make a final decision after receipt of public and agency comments and a decision by the Siting Board whether to certify the project under Sections 403.501-519, Florida Power Plant Siting Act.

Deborah Nelson is the meteorologist responsible for the ambient air quality assessment. She may be contacted at deborah.nelson@dep.state.fl.us or 850/921-9537. Cindy Mulkey is the engineer responsible for preparation of the permit. She may be contacted at cindy.mulkey@dep.state.fl.us or 850/921-8968. Trina Vielhauer is the Chief of the Bureau of Air Regulation that issued this preliminary decision. She may be contacted at trina.vielhauer@dep.state.fl.us or 850/921-9503.

The undersigned is the supervising professional engineer responsible for the technical evaluation and BACT determination.



Alvaro A. Linero, P.E., Program Administrator
alvaro.linero@dep.state.fl.us
Telephone: 850-921-9523

June 16, 2006
Tallahassee, Florida

REFERENCES

- ¹ Article. Farina, G.L. and Bressan, L. "Optimizing IGCC Design." Foster Wheeler Review. 1999.
- ² DOE Presentation. "Demonstration of Air-blown Integrated Gasification Combined Cycle Power Plant with Coal-based Transport Gasifier." Clean Coal Power Initiative – Round 2. November, 2005.
www.netl.doe.gov/technologies/coalpower/cctc/pubs/Benefits%20of%20Southern%20Company.pdf

TECHNICAL EVALUATION AND PRELIMINARY DETERMINATION

- ³ Paper. Breault, R., National Energy Technology Laboratory. "Power Systems Development Facility Transport Gasifier Operations." The Proceedings of the 30th International Conference on Coal Utilization & Fuel Systems. Clearwater, Florida. April 2005.
- ⁴ Paper. Gangwal, S. et. al. Research Triangle Institute, SRI, GE. "Catalytic Ammonia Decomposition for Coal-Derived Fuel Gases." DOE Advanced Coal-Fired Power Systems 1996 Review Meeting. Morgantown, West Virginia. July 16-18, 1996.
- ⁵ Southern Company Presentation. "Wilsonville Power Systems Development Facility - America's Advanced Coal Research Center." http://psdf.southernco.com/pdf/psdf_presentation.pdf
- ⁶ Submittal. Orlando Utilities Commission, Curtis H. Stanton Energy Center Unit B IGCC Project. Sufficiency Responses. Prepared by ECT for applicant. May 2006.
- ⁷ Parsons Presentation. "The Cost of Mercury Removal from Coal-Based IGCC Relative to a PC Plant." Gasification Technologies 2002. San Francisco. October 27-30, 2005. www.gasification.org/Docs/2002_Papers/GTC02020x.pdf
- ⁸ Submittal. Orlando Utilities Commission, Curtis H. Stanton Energy Center Unit B IGCC Project. Sufficiency Responses. Prepared by ECT for applicant. May 2006.
- ⁹ Technical Report DOE No. DE-FC26-99FT40725. Dalrymple, D., CrystaTech. "Hybrid Sulfur Recovery Process for Natural Gas Upgrading." June 2004.
- ¹⁰ Submittal. Orlando Utilities Commission, Curtis H. Stanton Energy Center Unit B IGCC Project. Sufficiency Responses. Prepared by ECT for applicant. May 2006.
- ¹¹ Southern Company Presentation. "Charting The Course-America's Advanced Coal Research Center." <http://investor.southerncompany.com/downloads/2005AnalystSeminar-4.ppt> 2005 Security Analyst Meeting.
- ¹² Telecom. Florida DEP, Southern Company, ECT. HCl emissions from Stanton B Project.
- ¹³ Electronic Mail. Linero, A., FDEP to Martin, R., Southern Company. Inquiry about HCl. June 15, 2006.
- ¹⁴ Daily Reports. Panhandle Energy. Hydrogen Sulphide and Sulfur Values in Natural Gas. May 22, 2006.
- ¹⁵ Technical Report GER 4219. Jones, R and Shilling, N., Dr. GE Power Systems IGCC Gas Turbines for Refinery Applications. May 2003. Page 6.
- ¹⁶ Letter. Stalls, D., OUC to Linero, A., FDEP. OUC Stanton B Netting Submittal. May 10, 2006.
- ¹⁷ Submittal. Orlando Utilities Commission, Curtis H. Stanton Energy Center Unit B IGCC Project. Sufficiency Responses. Prepared by ECT for applicant. May 2006.
- ¹⁸ Report. Department of Energy and TECO. Tampa Electric Integrated Gasification-Combined Cycle Project – Project Performance Summary. Clean Coal Technology Demonstration Program. DOE/FE-0469. June 2004.
- ¹⁹ Paper. Qader, S.A., Qader, Q.A., and Muzio, L.J. Energy and Environmental Technology Corporation, Fossil Energy Research Corporation. "Decomposition of Ammonia in IGCC Fuel Gas Streams." Work Performed under DOE Contract FG03-95ER81964. 1996.

TECHNICAL EVALUATION AND PRELIMINARY DETERMINATION

- ²⁰ Paper. Gangwal, S. et. al. Research Triangle Institute, SRI, GE. "Catalytic Ammonia Decomposition for Coal-Derived Fuel Gases." DOE Advanced Coal-Fired Power Systems 1996 Review Meeting. Morgantown, West Virginia. July 16-18, 1996.
- ²¹ Paper. Shilling, N., Dr. and Lee, D. GE Power Systems. "IGCC – Clean Power Generation Alternative for Solid Fuels." PowerGen Asia. 2003.
- ²² Presentation. McDaniel, J., Tampa Electric, Polk Power Station. "DOE Turbine Program Road Mapping." Pittsburgh. July 29, 2003.
- ²³ Technical Report GER 4219. Jones, R and Shilling, N., Dr. GE Power Systems IGCC Gas Turbines for Refinery Applications. May 2003. Page 9.
- ²⁴ Reference 21, Page 6
- ²⁵ Report. "Development of a 1,500°C-Class Gas Turbine Combustor for IGCC (6th Report)-Evaluation of Fundamental Performance Under Gas Turbine Operating Conditions" CRIEPI Rep. W95017 (1996)
- ²⁶ Letter. KenKnight, J., EPA Region 10 to Fiksdal, A., Washington Energy Facility Site Evaluation Council. BP Cherry Pt. Cogeneration Project. December 4, 2003.
- ²⁷ Letters. Cusson, Thomas P., Massachusetts DEP to Maggiani, R., ANP Blackstone. Emissions Testing Results, ANP Blackstone Units 1 and 2.
- ²⁸ Conditional Approval. Major Comprehensive Plan - PSD Permit. Sithe Mystic Development LLC. Application No. MBR-99-COM-012. Massachusetts Department of Environmental Protection. January 25, 2000.
- ²⁹ Presentation. Shilling, N. Dr., General Electric. "Moving IGCC Forward". FDEP-Reliant 2005 Power Conference. July 28, 2005.
- ³⁰ Presentation. Mitsubishi Heavy Industries. The Latest Supercritical Coal-Fired Boiler and Integrated Coal Gasification Combined Cycle Technology (IGCC). Asia Pacific Economic Cooperation (APEC) Clean Fossil Energy Technical and Policy Seminar. Lampang, Thailand. February 23, 2006. Available at: [www.apec-egcfe.org/ClaenCoal-1205%5BThai\)/Proceedings/session%202/2.4_Ishii.pdf](http://www.apec-egcfe.org/ClaenCoal-1205%5BThai)/Proceedings/session%202/2.4_Ishii.pdf)
- ³¹ Paper. Rogers, L., et al. Southern Company Services, EPRI, National Energy Technology Laboratory, and KBR. "Power from PRB – Four Conceptual IGCC Plant Designs Using the Transport Gasifier." The Proceedings of the 22nd International Pittsburgh Coal Conference. September 13, 2005.
- ³² Presentation. McDaniel, J., Tampa Electric, Polk Power Station. "DOE Turbine Program Road Mapping." Pittsburgh. July 29, 2003.
- ³³ Report. Ratafia-Brown, J., et al. Science Applications International Corporation. Major Environmental Aspects of Gasification-based Power Generation technologies. Prepared for DOE National Energy Technology Laboratory/Gas Technologies Program. December 2002.
- ³⁴ Submittal. Orlando Utilities Commission, Curtis H. Stanton Energy Center Unit B IGCC Project. Sufficiency Responses –Attachment FDEP-5. Prepared by ECT for applicant. May 2006.
- ³⁵ Paper. Dalrymple, D., et al. CrystaTech, Inc. "CrystaSulf – One-Step H₂S to Sulfur Conversion for High-Pressure Natural Gas." GPA Convention. Austin 2005.
- ³⁶ Paper. Eiland, J., et al. Southern Company Services, EPRI, National Energy Technology Laboratory, and KBR. "Impact of CO₂ Capture on Transport Gasifier IGCC Power Plant." The Proceedings of the 31st International Technical Conference on Coal Utilization & Fuel Systems. May 21 – 25, 2006.

TECHNICAL EVALUATION AND PRELIMINARY DETERMINATION

- ³⁷ Paper GT2005-68997. Geosits, R., and Schmoie, L. Bechtel Corporation. "IGCC – The Challenges of Integration." Proceedings of GT2005 ASME Turbo Expo 2005: Power for Land, Sea and Air. June 6-9, 2005 Reno-Tahoe, Nevada.
- ³⁸ Submittal. Attachment FDEP-5. Orlando Utilities Commission, Curtis H. Stanton Energy Center Unit B IGCC Project. Sufficiency Responses. Prepared by ECT for applicant. May 2006.
- ³⁹ Budgetary Proposal. IGCC Unit CO Catalyst. Engelhard to Florida DEP. June 6, 2006.
- ⁴⁰ Electronic Mail. Forney, K., EPA to Mulkey, C. and Linero, A., FDEP. Cost-effectiveness of CO control by oxidation Catalyst based on Engelhard and FDEP information. June 14, 2006.
- ⁴¹ Technical Report GER 4213. Richani, B., Ph.D. and Chalfin, J. GE Power Systems. "Support for Elimination of Oxidation Catalyst Requirements for GE PG7241FA DLN Combustion Turbines." August 2001.
- ⁴² Application. Environmental Consulting and Technology, Inc. OUC Curtis H. Stanton Energy Center Unit B IGCC Project... Prepared for OUC/SPS-OG LLC. February 2006. Section 10.1.5, Page 12.
- ⁴³ Letter. Richani, B., General Electric to Gnecco, J., FP&L. Particulate Matter Emissions: GE 7241FA DLN Combustion Turbines. June 17, 2003.
- ⁴⁴ Letter. Richani, B., General Electric to Gnecco, J., FP&L. Expected Particulate Matter Emissions: GE 7FA DLN Combustion Turbines. September 19, 2003.
- ⁴⁵ Presentation. Horton, R., General Electric. "Delivering the Benefits of IGCC". 2nd International Conference on Clean Coal Technologies for Our Future. - Sardinia, Italy. May 10, 2005.
- ⁴⁶ Report. Ratafia-Brown, J., et al. Science Applications International Corporation. Major Environmental Aspects of Gasification-based Power Generation technologies. Prepared for DOE National Energy Technology Laboratory/Gas Technologies Program. December 2002.
- ⁴⁷ Submittal. Orlando Utilities Commission, Curtis H. Stanton Energy Center Unit B IGCC Project. Sufficiency Responses. Prepared by ECT for applicant. May 2006.
- ⁴⁸ TECO Presentation. "Monitoring and Removal of Mercury in a Texaco IGCC Gasifier System." Gasification Technologies Conference. October 14, 2003.
www.gasification.org/Docs/2003_Papers/34STEE.pdf
- ⁴⁹ Paper. Corvini, G., et al. UOP. "Mercury Removal from Natural Gas and Liquid Streams." Houston, Texas. 2002.
- ⁵⁰ Report. Klett, M., et al. Parsons Infrastructure and technology. "The Cost of Mercury Removal in an IGCC Plant." Prepared for DOE National Energy Technology Laboratory. September 2002.
- ⁵¹ Electronic Mail. Calgon Carbon Corporation to FDEP. Model 10 Vapor Phase Adsorber – Mercury Removal May 2006.
- ⁵² Report. Orange County Environmental Protection Division. 2004 Annual Report. Air Quality Yearly Report. Page 37.

PERMITTEE:

OUC/Southern Power Company
5100 South Alafaya Trail
Orlando, Florida 32831

Authorized Representative:
Frederick F. Haddad, Jr., V.P. Power Resources

Curtis H. Stanton Energy Center
IGCC Unit B
Draft Permit No. PSD-FL-373
Project No. 0950137-010-AC
Siting No. PA 81-14SA3
Expires: July 31, 2010

PROJECT AND LOCATION

This permit authorizes the construction of a nominal 285 MW coal fueled integrated gasification combined cycle electric utility steam generating unit at the existing Curtis H. Stanton Energy Center. The facility is located southeast of Orlando, in Orange County.

STATEMENT OF BASIS

This construction permit is issued under the provisions of Chapter 403 of the Florida Statutes (F.S.), Chapters 62-4, 62-204, 62-210, 62-212, 62-296, and 62-297 of the Florida Administrative Code (F.A.C.). The project was processed in accordance with the requirements of Rule 62-212.400, F.A.C., the preconstruction review program for the Prevention of Significant Deterioration (PSD) of Air Quality. Pursuant to Chapter 62-17, F.A.C. and Chapter 403 Part II, F.S., the project is also subject to Electrical Power Plant Siting. The permittee is authorized to install the proposed equipment in accordance with the conditions of this permit and as described in the application, approved drawings, plans, and other documents on file with the Department of Environmental Protection (Department).

DRAFT

Joseph Kahn, P.E., Acting Director
Division of Air Resources Management

Date: _____

SECTION I - GENERAL INFORMATION

FACILITY DESCRIPTION

The regulated emissions units at the existing Stanton Energy Center include two coal fired boiler steam electric generating stations; solid fuels, fly ash, limestone, gypsum, slag, and bottom ash storage and handling facilities; two combustion turbine electrical generator combined cycle units capable of firing either natural gas or fuel oil; and one distillate fuel oil storage tank.

PROJECT DESCRIPTION

The project is for the addition of a nominal 285 Megawatt (net) integrated Gasification Combined Cycle (IGCC) unit (Stanton Unit B) and auxiliary equipment. The project consists of: a nominal 160 MW General Electric 7F combustion turbine-electrical generator capable of firing synthetic gas (syngas); a supplementary-fired heat recovery steam generator (HRSG); a nominal 135 MW steam-electrical generator; a 205-foot stack; a mechanical draft cooling tower with drift eliminators; a gasification system including air blown coal gasification reactor/s (KBR Transport Gasifier), a multipoint ground flare, a 184-foot gasifier startup stack, and a coal and gasification ash storage and handling area. The gasification train associated with each reactor includes, a high temperature syngas cooler, a high temperature high pressure filtration system, a low temperature gas cooling and mercury removal system, a sulfur removal and recovery process, and a sour water treatment and ammonia recovery process. Natural gas will be used as a backup fuel to the combustion turbine.

EMISSIONS UNITS

This permit authorizes construction and installation of the following new emissions units:

EU ID NO.	EMISSION UNIT DESCRIPTION
030	Unit B Integrated Gasification Combined Cycle – Consists of one General Electric PG7241 FA gas turbine electrical generator (nominal 160 MW) equipped with evaporative inlet air cooling, a heat recovery steam generator (HRSG) with supplemental duct firing, a HRSG stack, a steam turbine electrical generator (nominal 135 MW), and the gasification system associated with one gasifier startup stack.
031	Unit B Flare – A multipoint flare (including 8 pilot flares) enclosed in a 20 foot thermal barrier fence used to combust syngas during startups (once the gasifier switches fuels from natural gas to coal), and during plant upset conditions.
032	Unit B Cooling Tower – consisting of six cells with six individual exhaust fans.
033	Unit B Coal Mill and Coal Storage – including coal crushing, and crushed coal storage, coal pulverizing and feed preparation.
034	Unit B Gasification Ash Storage – including fly ash storage silo and baghouse.
035	Unit B Coal Handling – including coal conveying and transfer.

REGULATORY CLASSIFICATION

Title III: The facility is a "Major Source" of hazardous air pollutants (HAPs).

Title IV: The facility operates units subject to the Acid Rain provisions of the Clean Air Act.

Title V: The facility is a Title V or "Major Source" of air pollution in accordance with Chapter 62-213, F.A.C. because the potential emissions of at least one regulated pollutant exceed 100 tons per year. Regulated pollutants include pollutants such as carbon monoxide (CO), nitrogen oxides (NO_x), particulate matter (PM/PM₁₀), sulfur dioxide (SO₂), sulfuric acid mist (SAM), and volatile organic compounds (VOC).

SECTION I - GENERAL INFORMATION

PSD: The facility is located in an area that is designated as "attainment", "maintenance", or "unclassifiable" for, each pollutant subject to a National Ambient Air Quality Standard. It is classified as a "fossil fuel-fired steam electric plant of more than 250 million BTU per hour of heat input", which is one of the facility categories listed at 62-210.200(definitions, Major Stationary Source) with the lower PSD applicability threshold of 100 tons per year. Potential emissions of at least one regulated pollutant exceed 100 tons per year, therefore the facility is classified as a "Major Stationary Source" with respect to Rule 62-212.400 F.A.C., Prevention of Significant Deterioration (PSD).

NSPS: The following New Source Performance Standards of 40 CFR 60 may be potentially applicable to the IGCC Unit B as described in Section III, Subsection A, Federal Requirements of this permit.

- Subpart Da (Standards of Performance for Electric Utility Steam Generating Units For Which Construction is Commenced After September 18, 1978).
- Subpart KKKK (Standards of Performance for Stationary Combustion Turbines).
- Subparts GG (Standards of Performance for Stationary Gas Turbines).

The coal storage and handling facilities of Unit B are subject to Subpart Y (Standards of Performance for Coal Preparation Plants).

NESHAP: The facility is a "Major Source" of HAPs and Unit B is subject to the applicable requirements of 40 CFR 63, Subpart YYYY (National Emissions Standard for Hazardous Air Pollutants for Stationary Combustion Gas Turbines) as described in Section III, Subsection A, Federal Requirements of this permit.

CAIR: As an electric generating unit, Unit B may be subject to the Clean Air Interstate Rule pending the finalization of DEP rules.

CAMR: Unit B is a new coal-fired power plant and may be subject to the Clean Air Mercury Rule pending finalization of DEP rules.

Siting: The facility is a steam electrical generating plant and is subject to the power plant siting provisions of Chapter 62-17, F.A.C.

PERMITTING AUTHORITY

All documents related to applications for permits to construct, operate or modify an emissions unit shall be submitted to the Bureau of Air Regulation of the Florida Department of Environmental Protection (DEP) at 2600 Blair Stone Road (MS #5505), Tallahassee, Florida 32399-2400. Copies of all such documents shall also be submitted to the Compliance Authority.

COMPLIANCE AUTHORITY

All documents related to compliance activities such as reports, tests, and notifications shall be submitted to the Department of Environmental Protection Central District, 3319 Maguire Boulevard, Suite 232, Orlando, Florida 32803-3767.

APPENDICES

The following Appendices are attached as part of this permit.

- | | |
|--------------|--|
| Appendix A. | NSPS and NESHAP Subparts A, Identification of General Provisions |
| Appendix BD. | Final BACT Determinations and Emissions Standards |
| Appendix Da. | NSPS Subpart Da Requirements for Electric Utility Steam Generating Units |
| Appendix GC. | General Conditions |

SECTION I - GENERAL INFORMATION

Appendix GG	NSPS Subpart GG Requirements for Gas Turbines
Appendix KKKK.	NSPS Subpart KKKK Requirements for Stationary Combustion Turbines
Appendix SC.	Standard Conditions
Appendix Y.	NSPS Subpart Y Requirements for Coal Preparation Plants
Appendix YYYYY.	NESHAP Subpart YYYYY Standard for HAPs for Stationary Combustion Gas Turbines

RELEVANT DOCUMENTS:

The documents listed below are not a part of this permit, however they are specifically related to this permitting action and are on file with the Department.

- February 17, 2006: Received Site Certification Application (SCA) including PSD application.
- April 5, 2006: Sent Sufficiency Issues to DEP Siting Coordination Office (SCO).
- April 10, 2006: SCA determined to be Insufficient by SCO.
- May 8, 2006: Received Sufficiency Responses from Applicant.
- May 26, 2006: Sent Status Letter on Sufficiency Responses.
- June 16, 2006: Intent to Issue PSD Permit distributed.
- Final Certification by the Power Plant Siting Board on XXXX
- Department's Final Determination and Best Available Control Technology Determination issued concurrently with this Final Permit.

SECTION II. ADMINISTRATIVE REQUIREMENTS

1. General Conditions: The permittee shall operate under the attached General Conditions listed in Appendix GC of this permit. General Conditions are binding and enforceable pursuant to Chapter 403 of the Florida Statutes. [Rule 62-4.160, F.A.C.]
2. Applicable Regulations, Forms and Application Procedures: Unless otherwise indicated in this permit, the construction and operation of the subject emissions unit shall be in accordance with the capacities and specifications stated in the application. The facility is subject to all applicable provisions of: Chapter 403 of the Florida Statutes (F.S.); Chapters 62-4, 62-204, 62-210, 62-212, 62-213, 62-296, and 62-297 of the Florida Administrative Code (F.A.C.); and the Title 40, Parts 51, 52, 60, 63, 72, 73, and 75 of the Code of Federal Regulations (CFR), adopted by reference in Rule 62-204.800, F.A.C. The terms used in this permit have specific meanings as defined in the applicable chapters of the Florida Administrative Code. The permittee shall use the applicable forms listed in Rule 62-210.900, F.A.C. and follow the application procedures in Chapter 62-4, F.A.C. Issuance of this permit does not relieve the permittee from compliance with any applicable federal, state, or local permitting or regulations. [Rules 62-204.800, 62-210.300 and 62-210.900, F.A.C.]
3. Construction and Expiration: Authorization to construct shall expire if construction is not commenced within 18 months after receipt of the permit, if construction is discontinued for a period of 18 months or more, or if construction is not completed within a reasonable time. This provision does not apply to the time period between construction of the approved phases of a phased construction project except that each phase must commence construction within 18 months of the commencement date established by the Department in the permit. The Department may extend the 18-month period upon a satisfactory showing that an extension is justified. In conjunction with an extension of the 18-month period to commence or continue construction (or to construct the project in phases), the Department may require the permittee to demonstrate the adequacy of any previous determination of Best Available Control Technology (BACT) for emissions units regulated by the project. For good cause, the permittee may request that this PSD air construction permit be extended. Such a request shall be submitted to the Department's Bureau of Air Regulation at least sixty (60) days prior to the expiration of this permit. [Rules 62-4.070(4), 62-4.080, 62-210.300(1), and 62-212.400(6)(b), F.A.C.]
4. New or Additional Conditions: For good cause shown and after notice and an administrative hearing, if requested, the Department may require the permittee to conform to new or additional conditions. The Department shall allow the permittee a reasonable time to conform to the new or additional conditions, and on application of the permittee, the Department may grant additional time. [Rule 62-4.080, F.A.C.]
5. Source Obligation.
 - a. At such time that a particular source or modification becomes a major stationary source or major modification (as these terms were defined at the time the source obtained the enforceable limitation) solely by virtue of a relaxation in any enforceable limitation which was established after August 7, 1980, on the capacity of the source or modification otherwise to emit a pollutant, such as a restriction on hours of operation, then the requirements of subsections 62-212.400(4) through (12), F.A.C., shall apply to the source or modification as though construction had not yet commenced on the source or modification.
 - b. At such time that a particular source or modification becomes a major stationary source or major modification (as these terms were defined at the time the source obtained the enforceable limitation) solely by exceeding its projected actual emissions, then the requirements of subsections 62-212.400(4) through (12), F.A.C., shall apply to the source or modification as though construction had not yet commenced on the source or modification.

[Rule 62-212.400(12), F.A.C.]

SECTION II. ADMINISTRATIVE REQUIREMENTS

6. Modifications: No emissions unit or facility subject to this permit shall be constructed or modified without obtaining an air construction permit from the Department. Such permit shall be obtained prior to beginning construction or modification. [Chapters 62-210 and 62-212, F.A.C.]
7. Application for Title IV Permit: At least 24 months before the date on which the new unit begins serving an electrical generator greater than 25 MW, the permittee shall submit an application for a Title IV Acid Rain Permit to the Department's Bureau of Air Regulation in Tallahassee and a copy to the Region 4 Office of the U.S. Environmental Protection Agency in Atlanta, Georgia. [40 CFR 72]
8. Title V Permit: This permit authorizes construction of the permitted emissions unit and initial operation to determine compliance with Department rules. A Title V operation permit is required for regular operation of the permitted emission units. The permittee shall apply for and obtain a Title V operation permit in accordance with Rule 62-213.420, F.A.C. To apply for a Title V operation permit, the applicant shall submit the appropriate application form, compliance test results, and such additional information as the Department may by law require. The application shall be submitted to the Department's Bureau of Air Regulation and a copy to the Compliance Authority.
[Rules 62-4.030, 62-4.050, 62-4.220, and Chapter 62-213, F.A.C.]

SECTION III - EMISSIONS UNITS SPECIFIC CONDITIONS

A. Unit B Integrated Gasification Combined Cycle (EU 030)

The specific conditions of this subsection apply to the following emissions unit after construction is complete.

E.U. ID	Emission Unit Description
030	Unit B Integrated Gasification Combined Cycle – Consists of one General Electric PG7241 FA gas turbine electrical generator (nominal 160 MW) equipped with evaporative inlet air cooling, a heat recovery steam generator (HRSG) with supplemental duct firing, a HRSG stack, a steam turbine electrical generator (nominal 135 MW), and the gasification system associated with one gasifier startup stack.

The integrated gasification combined cycle unit contains the following emission points.

Point ID	Emissions Point Description
GCC-1	HRSG Stack
GCC-2	Gasifier Startup Stack

APPLICABLE STANDARDS AND REGULATIONS

1. **BACT Determinations:** A determination of the Best Available Control Technology (BACT) was made for carbon monoxide (CO), particulate matter (PM/PM₁₀), sulfuric acid mist (SAM), sulfur dioxide (SO₂), and volatile organic compounds (VOCs). [Rule 62-210.200 (BACT), F.A.C.]
2. **NO_x Emissions Cap:** An emissions cap on Units 1 and 2 was taken in order for the project to “net out” with respect to NO_x emissions, thus avoiding a BACT determination for nitrogen oxides.
3. **NSPS Requirements:** This unit may be subject to the subparts of 40 CFR 60, listed and as described below, adopted by reference in Rule 62-204.800(7)(b), F.A.C. The Department determines that the BACT emissions performance requirements are as stringent as or more stringent than the limits imposed by the applicable NSPS provisions for SO₂, and PM. Some separate reporting and monitoring may be required by the individual subparts.
 - a. The Unit is subject to **Subpart A, General Provisions**, including:
 - 40 CFR 60.7, Notification and Record Keeping
 - 40 CFR 60.8, Performance Tests
 - 40 CFR 60.11, Compliance with Standards and Maintenance Requirements
 - 40 CFR 60.12, Circumvention
 - 40 CFR 60.13, Monitoring Requirements
 - 40 CFR 60.19, General Notification and Reporting Requirements
 - b. **Subpart Da, Standards of Performance for Electric Utility Steam Generating Units.** These provisions include standards for duct burners and certain heat recovery steam generators and associated stationary combustion turbines. Subpart Da may be applicable to the new IGCC Unit B as described in Section III, Subsection A, Federal Requirements of this permit.
 - c. **Subpart GG, Standards of Performance for Stationary Gas Turbines:** These provisions include standards for stationary gas turbines with a heat input greater than 10 mmBtu/hr constructed after October 3, 1977. Subpart GG may be applicable to the new IGCC Unit B as described in Section III, Subsection A, Federal Requirements of this permit.

SECTION III - EMISSIONS UNITS SPECIFIC CONDITIONS

A. Unit B Integrated Gasification Combined Cycle (EU 030)

- d. **Subpart KKKK, Standards of Performance for Stationary Gas Turbines:** These provisions include standards for stationary combustion turbines constructed after February 18, 2005. Subpart KKKK may be applicable to the new IGCC Unit B as described in Section III, Subsection A, Federal Requirements of this permit.
4. **NESHAP Requirements:** The combustion turbine is subject to 40 CFR 63, Subpart A, Identification of General Provisions and 40 CFR 63, Subpart YYYYY, National Emissions Standard for Hazardous Air Pollutants for Stationary Combustion Gas Turbines as described in Section III, Subsection A, Federal Requirements of this permit.

EQUIPMENT DESCRIPTION

5. **Combustion Turbine:** The permittee is authorized to install, tune, operate, and maintain one General Electric Model PG7241FA gas turbine-electrical generator set with a nominal generating capacity of 160 MW. The gas turbine will be equipped with GE's diffusion flame multinozzle quiet combustor (MNQC), and an inlet air filtration system with evaporative coolers. The combustion turbine will have dual-fuel capability and shall be designed for a maximum heat input rate of 1,940.4 mmBtu per hour when firing natural gas and 1,805.2 mmBtu per hour when firing syngas (based on a compressor inlet air temperature of 20° F, the higher heating value (HHV) of the fuel, and 100% load). Heat input rates will vary depending upon gas turbine characteristics, ambient conditions, alternate methods of operation, and evaporative cooling. The permittee shall provide manufacturer's performance curves (or equations) that correct for site conditions to the Permitting and Compliance Authorities within 45 days of completing the initial compliance testing. Operating data may be adjusted for the appropriate site conditions in accordance with the performance curves and/or equations on file with the Department. [Application; Design]
6. **HRSG:** The permittee is authorized to install, operate, and maintain one heat recovery steam generator (HRSG) with a HRSG exhaust stack. The HRSG shall be designed to recover heat energy from the gas turbine and deliver steam to the steam turbine electrical generator. The HRSG will be equipped with supplemental gas-fired duct burners. The duct burners shall be designed for a maximum heat input rate of 531.5 MMBtu per hour based on the higher heating value (HHV) of natural gas. [Application; Design]
7. **Generating Capacity:** Unit B will have a nominal electrical generating capacity of 285 MW (net) when firing syngas and 310 MW when firing natural gas (duct burners operational).
8. **Gasification System:** The permittee is authorized to install, operate, and maintain a gasification system, consisting of air blown gasifier/s and one startup stack, for the production of synthetic gas to be fired in the combustion turbine. Each gasifier is associated with a gasifier train which includes the transport gasifier, a high temperature syngas cooler, a high temperature high pressure filtration system, a low temperature gas cooling and mercury removal system, a sulfur removal and recovery system, and a sour water treatment and ammonia recovery system. The gasification system shall be designed for a maximum total gasification heat input rate of 2,383.7 mmBtu per hour (based on an ambient air temperature of 20° F, the higher heating value (HHV) of the fuel, and 100% load). [Application; Design].

CONTROL TECHNOLOGY

9. **Combustion Turbine/HRSG:** The following add-on pollution control equipment shall be installed and operated to control stack emissions from the CT/HRSG system.
- a. **Water/Steam Injection:** The permittee shall install, operate, and maintain a steam injection system to reduce NO_x emissions from the combustion turbine when firing natural gas. Prior to the initial emissions performance tests required for the gas turbine, the steam injection system shall be tuned to achieve permitted levels for CO and sufficiently low NO_x values to meet the NO_x limits with the

SECTION III - EMISSIONS UNITS SPECIFIC CONDITIONS

A. Unit B Integrated Gasification Combined Cycle (EU 030)

additional SCR control technology described below. Thereafter, the system shall be maintained and tuned in accordance with the manufacturer's recommendations.

- b. *Selective Catalytic Reduction (SCR) System:* The permittee shall install, tune, operate, and maintain an SCR system to control NO_x emissions from the combustion turbine when firing natural gas, synthetic gas, or a combination thereof. The SCR system consists of an ammonia (NH₃) injection grid, catalyst, ammonia storage, monitoring and control system, electrical, piping and other ancillary equipment. The SCR system shall be designed, constructed and operated to meet the permitted levels of NO_x and NH₃ emissions. Additionally, the SCR system shall be optimized, in order to demonstrate the lowest sustainable NO_x emission rate achievable.

Ammonia Storage: In accordance with 40 CFR 68.130, the storage of ammonia shall comply with all applicable requirements of the Chemical Accident Prevention Provisions in 40 CFR 68.

- c. *Oxidation Catalyst:* Within one calendar year from startup of the combustion turbine, the permittee shall install, operate, and maintain an oxidation catalyst for the control of CO emissions from the combustion turbine when firing natural gas, synthetic gas, or a combination thereof. The oxidation catalyst shall be designed to meet the permitted levels of CO emissions.

[Design; Rules 62-210.200(PTE, and BACT), 62-210.650, 62-212.400(PSD), F.A.C.; Chapter 403.061, F.S.]

10. Gasification System: The following technologies shall be installed and operated for each gasifier train for treatment of the synthetic gas stream prior to combustion in the combustion turbine.

- a. *Particulate Filtration System:* The permittee shall install, operate, and maintain a high temperature/high pressure (HTHP) filtration system for each gasifier train, for the removal of particulate matter from the synthetic gas in order to achieve the permitted levels of particulate matter emissions from the CT/HRSG system.
- b. *Mercury Removal System:* The permittee shall install, operate, and maintain a mercury removal system for each gasifier train, to remove a sufficient amount of mercury from the synthetic gas stream to achieve the permitted levels of mercury emissions from the CT/HRSG system.
- c. *Sulfur Removal System:* The permittee shall install, operate, and maintain a sulfur removal system for each gasifier train, to remove a sufficient amount of sulfur from the synthetic gas stream to achieve the permitted levels of SO₂ and H₂SO₄ emissions from the CT/HRSG system, and to minimize ammonium bisulfate formation in the HRSG.
- d. *Ammonia Recovery:* The permittee shall install, operate, and maintain an ammonia removal system, for each gasifier train, to remove a sufficient amount of ammonia from the synthetic gas stream to minimize formation of NO_x.

Ammonia Storage: In accordance with 40 CFR 68.130, the storage of ammonia shall comply with all applicable requirements of the Chemical Accident Prevention Provisions in 40 CFR 68.

[Design; Rule 62-212.400(PSD), F.A.C.]

PERFORMANCE REQUIREMENTS

11. Hours of Operation: The gasification system and/or gas turbine may operate throughout the year (8,760 hours per year). Restrictions on individual methods of operation are specified in separate conditions.
[Rules 62-210.200(PTE, and BACT) and 62-212.400 (PSD), F.A.C.]

SECTION III - EMISSIONS UNITS SPECIFIC CONDITIONS

A. Unit B Integrated Gasification Combined Cycle (EU 030)

12. Authorized Fuels:

- a. *Synthetic Gas* - The combustion turbine may fire synthetic gas produced in the gasification reactors.
- b. *Natural Gas* - The combustion turbine may fire natural gas which shall contain no more than 2.0 grains of sulfur per 100 standard cubic feet of natural gas. Only natural gas shall be fired in the duct burners, and used for initial startup of the transport gasifier/s.
- c. *Synthetic Gas/Natural Gas Combination* - The combustion turbine may fire a synthetic gas/natural gas mixture. An hour in which a natural gas/synthetic gas fuel mixture is fired, is subject to the BACT limit for natural gas when the mixture contains 50-100% natural gas (by heat input), and subject to the BACT limit for synthetic gas when the mixture contains less than 50% natural gas (by heat input) for that hour.
- d. *Coal* - When burning synthetic gas in the combustion turbine, coal shall be processed in the gasification island.

[Rules 62-210.200(PTE, and BACT) and 62-212.400 (PSD), F.A.C.]

13. Methods of Operation of the Combustion Turbine: Subject to the restrictions and requirements of this permit, the gas turbine may operate under the following methods of operation.

- a. *Combined Cycle Operation:* The combustion turbine/HRSG system may operate to produce direct, shaft-driven electrical power and steam-generated electrical power from the steam turbine-electrical generator as a combined cycle unit subject to the restrictions of this permit. In accordance with the specifications of the SCR and HRSG manufacturers, the SCR system shall be on line and functioning properly during combined cycle operation or when the HRSG is producing steam.
- b. *Inlet Fogging:* In accordance with the manufacturer's recommendations and appropriate ambient conditions, the evaporative cooling system may be operated to reduce the compressor inlet air temperature and provide additional direct, shaft-driven electrical power. This method of operation is commonly referred to as "fogging."
- c. *Duct Firing:* The HRSG system may fire natural gas in the duct burners to provide additional steam-generated electrical power.

[Application; Rules 62-210.200 (PTE, and BACT) and 62-212.400 (PSD), F.A.C.]

14. Methods of Operation of the Gasifiers: Subject to the restrictions and requirements of this permit, the gasification island may operate under the following methods of operation.

- a. *Initial Startup:* During startup of the gasification island, flue gas exhaust may be vented to the gasifier startup stack after passing through the particulate filtration system. As soon as possible, upon reaching a reducing atmosphere within the gasifier, the exhaust synthetic gas shall be directed to the flare and not to the startup stack. At no time, other than initial startup, shall the exhaust gases be directed to the startup stack.
- b. *Synthetic Gas Flaring:* Once the gasifiers reach a reducing atmosphere, synthetic gas shall be directed through the gas clean-up processes to the flare. Flaring during startup shall take place only until there is sufficient synthetic gas production to support operation of the combustion turbine. Operation of the combustion turbine may be accomplished by mixing the synthetic gas with natural gas. Synthetic gas may be directed to the flares during upset conditions such as trips of the CT/HRSG system to allow safe release of the pressurized gas.
- c. *Integrated Operation:* The gasification system may operate to produce synthetic gas for combustion in the combustion turbine. All control equipment/technologies constructed to treat the gas stream prior to

SECTION III - EMISSIONS UNITS SPECIFIC CONDITIONS

A. Unit B Integrated Gasification Combined Cycle (EU 030)

combustion of the synthetic gas in the combustion turbine shall be on line and functioning properly, in accordance with the specifications of the manufacturers, during the integrated operation of the gasification and CT/HRSG systems.

[Application; Rules 62-210.200 (PTE, and BACT) and 62-212.400 (PSD), F.A.C.]

EMISSIONS AND TESTING REQUIREMENTS

15. Emission Standards: Emissions from the turbine/HRSG system shall not exceed the following standards.

Best Available Control Technology (BACT) – Rule 62-210.200, F.A.C.				
<i>While Firing Natural Gas^a</i>				
Pollutant	Stack Test, 3-Run Average		CEMS Average	
	ppmvd @ 15% O ₂	lb/hr ^e		
CO (DB) ^f	4.1	20.8	24-hr rolling	
CO (w/o DB) ^f	4.1	15.8		
VOC (DB) ^f	2.4	7.0	N/A	
VOC (w/o DB) ^f	2.4	5.3		
SO ₂ ^b	2.0 gr S/100 SCF of gas		N/A	
SAM ^b	2.0 gr S/100 SCF of gas		N/A	
PM/PM ₁₀ ^c	2.0 gr S/100 SCF of gas		N/A	
	10 % opacity, 6-minute block average			
Ammonia ^d	5.0	N/A	N/A	
<i>While Firing Synthetic Gas^a</i>				
CO (DB) ^f	4.1	28.1	24-hr rolling	
CO w/o DB ^f	4.1	23.5		
VOC (DB) ^f	2.4	9.3	N/A	
VOC (w/o DB) ^f	2.4	7.9		
SO ₂ ^b	1.8	23.7	24-hr rolling	
PM/PM ₁₀	Compliance with SO ₂ /CO standards		N/A	
	10 % opacity, 6-minute block average			
SAM ^b	Compliance with SO ₂		N/A	
Ammonia ^d	5.0	N/A	N/A	
PSD Preconstruction Review Avoidance – Rule 62-212.400(2)(a), F.A.C.				
Pollutant	Fuel	ppmvd @ 15% O ₂	TPY	CEMS Average
NO _x	Natural Gas	5.0	N/A	30-day rolling
	Syngas	20.0		24-hr rolling
	Natural Gas/Syngas	N/A	987	12-month rolling
Mercury	Natural Gas/Syngas	7.7 x 10 ⁶ lb/MWh	< 22 lb/yr	12-month rolling

a. For purposes of meeting the BACT limits of this subsection, an hour in which a natural gas/synthetic gas fuel mixture is fired, is subject to the BACT limit for natural gas when the mixture contains 50-100%

SECTION III - EMISSIONS UNITS SPECIFIC CONDITIONS

A. Unit B Integrated Gasification Combined Cycle (EU 030)

natural gas (by heat input), and subject to the BACT limit for synthetic gas when the mixture contains less than 50% natural gas (by heat input) for that hour. Any hour in which both synthetic gas and natural gas are combusted in the combustion turbine due to fuel switching, shall be subject to the limits for synthetic gas firing.

- b. The fuel sulfur specifications, established in Condition 12 of this subsection, effectively limit the potential emissions of SO₂ and SAM from the combustion turbine while firing natural gas and represent BACT for these pollutants. Compliance with the fuel sulfur specifications shall be determined by the requirements in Condition No. 47 of this subsection. BACT for SO₂ while firing synthetic gas has been determined as 1.8 ppmvd and 23.7 lb/h. Compliance with the SO₂ limit effectively limits the potential emissions of SAM while firing synthetic gas.
- c. The fuel sulfur specifications for natural gas and the SO₂ standard for syngas, combined with the efficient combustion design and operation of the combustion turbine represent BACT for PM/PM₁₀ emissions. Compliance with the fuel specifications, CO standards, and visible emissions standards shall serve as indicators of good combustion.
- d. The SCR system shall be designed and operated for an ammonia slip limit of no more than 5 ppmvd corrected to 15% O₂ based on the average of three test runs.
- e. Mass emission rate standards are based on 100 percent full load operation, an ambient temperature of 70° F, and using the HHV of the fuel. The mass emission rate may be adjusted from actual test conditions in accordance with the performance curves and/or equations on file with the Department.
- f. These emission rates for CO and VOC shall apply after the first calendar year of first fire of the CT.

{Permitting Note: The above emissions standards effectively limit annual potential emissions from the combustion turbine/HRSG system to: 123 tons/year of CO (after the first year of operation), 40 tons/year of VOC, 103 tons/year of SO₂, less than 24 tons/year of SAM, and less than 156 tons/year of PM/PM₁₀.}

[Rules 62-4.070(3), 62-210.200 (BACT), and 62-212.400(PSD), F.A.C]

16. Carbon Monoxide (CO): Emissions of CO from the CT/HRSG system shall not exceed the following BACT limits on a 24-hr rolling average as measured by the required CEMS and during the required stack tests.

a. *While firing natural gas:*

- i. *For the first 365 calendar days following first fire of the combustion turbine, CO emissions shall not exceed:*

Duct burners on – 27.2 ppmvd @ 15% O₂ and 138.0 lb/hr

Duct burners off – 20.5 ppmvd @ 15% O₂ and 79.0 lb/hr

- ii. *Thereafter, CO emissions shall not exceed:*

Duct burners on – 4.1 ppmvd @ 15% O₂ and 20.8 lb/hr
(for reference equates to ~ 0.066 lb/MWh)

Duct burners off – 4.1 ppmvd @ 15% O₂ and 15.8 lb/hr
(for reference equates to ~ 0.067 lb/MWh)

b. *While firing synthetic gas:*

- i. *For the first 365 calendar days following first fire of the combustion turbine, CO emissions shall not exceed:*

Duct burners on – 20.5 ppmvd @ 15% O₂ and 140.5 lb/hr

SECTION III - EMISSIONS UNITS SPECIFIC CONDITIONS

A. Unit B Integrated Gasification Combined Cycle (EU 030)

Duct burners off – 15.8 ppmvd @ 15% O₂ and 90.7 lb/hr

ii. *Thereafter, CO emissions shall not exceed:*

Duct burners on – 4.1 ppmvd @ 15% O₂ and 28.1 lb/hr
(for reference equates to ~ 0.081 lb/MWh)

Duct burners off – 4.1 ppmvd @ 15% O₂ and 23.5 lb/hr
(for reference equates to ~ 0.072 lb/MWh)

[Rules 62-4.070(3), 62-210.200 (BACT), and 62-212.400(PSD), F.A.C]

17. Volatile Organic Compounds (VOCs): Emissions of VOC from the CT/HRSG system shall not exceed the following standards as determined by data collected during the required stack tests:

a. *While firing natural gas:*

i. *For the first 365 calendar days following first fire of the combustion turbine, CO emissions shall not exceed:*

Duct burners on – 10.1 ppmvd @ 15% O₂ and 29.3 lb/hr

Duct burners off – 6.8 ppmvd @ 15% O₂ and 15.0 lb/hr

ii. *Thereafter, CO emissions shall not exceed:*

Duct burners on – 2.4 ppmvd @ 15% O₂ and 9.3 lb/hr
(for reference equates to ~ 0.030 lb/MWh)

Duct burners off – 2.4 ppmvd @ 15% O₂ and 7.1 lb/hr
(for reference equates to ~ 0.030 lb/MWh)

b. *While firing synthetic gas:*

i. *For the first 365 calendar days following first fire of the combustion turbine, CO emissions shall not exceed:*

Duct burners on – 6.9 ppmvd @ 15% O₂ and 26.9 lb/hr

Duct burners off – 4.7 ppmvd @ 15% O₂ and 15.4 lb/hr

ii. *Thereafter, CO emissions shall not exceed:*

Duct burners on – 2.4 ppmvd @ 15% O₂ and 12.5 lb/hr
(for reference equates to ~ 0.036 lb/MWh)

Duct burners off – 2.4 ppmvd @ 15% O₂ and 10.5 lb/hr
(for reference equates to ~ 0.032 lb/MWh)

[Rules 62-4.070(3), 62-210.200 (BACT), and 62-212.400(PSD), F.A.C]

18. Sulfur Dioxide (SO₂):

a. *While firing natural gas:*

The fuel sulfur specifications, established in Condition 12 of this subsection, of 2.0 grains per 100 standard cubic feet effectively limit the potential emissions of SO₂ while firing natural gas from the combustion turbine.

SECTION III - EMISSIONS UNITS SPECIFIC CONDITIONS

A. Unit B Integrated Gasification Combined Cycle (EU 030)

- b. *While firing synthetic gas*: Emissions of SO₂ from the CT/HRSG system shall not exceed 1.8 ppmvd @ 15% O₂ and 23.7 lb/hr on a 24-hr rolling average as measured by the required CEMS and during the required stack tests. (For reference this equates to ~ 0.08 lb/MWh).

[Rules 62-4.070(3), 62-210.200 (BACT), and 62-212.400(PSD), F.A.C]

19. Sulfuric Acid Mist (SAM, H₂SO₄): Sulfuric acid mist is effectively limited by the fuel sulfur specifications and the sulfur dioxide limits while burning natural gas and synthetic gas respectively. These requirements represent BACT for this pollutant. [Rules 62-4.070(3), 62-210.200 (BACT), and 62-212.400(PSD), F.A.C]

20. Particulate Matter (PM/PM₁₀):

- a. *While burning natural gas*:

The fuel sulfur specifications, established in Condition No. 12 of this subsection, combined with the efficient combustion, design, and operation of the combustion turbine represent BACT for PM/PM₁₀ emissions while firing natural gas. Compliance with the fuel specifications, CO standards, and visible emissions standards shall serve as indicators of good combustion. Visible emissions shall not exceed 10 % opacity as observed during the required visible emissions tests.

- b. *While burning synthetic gas*:

The SO₂ standard for synthetic gas, combined with the efficient combustion design and operation of the combustion turbine represent BACT for PM/PM₁₀ emissions. Compliance with the SO₂ and CO standards, and visible emissions standard shall serve as indicators of good combustion. Visible emissions shall not exceed 10 % opacity as observed during the required visible emissions tests. Results from the particulate matter stack tests, as required in Specific Conditions 28 and 29 of this subsection, shall be reported to the compliance authority.

{Permitting Note: The SO₂ limit of 1.8 ppm is approximately equal to 0.013 lb SO₂/mmBtu of synthetic gas which is below the sulfur dioxide fuel specification of 60.49Da(u)(2)}

[Rules 62-4.070(3), 62-210.200 (BACT), and 62-212.400(PSD), F.A.C, 40 CFR 60.49, and Chapter 403.061(18), F.S.]

21. Ammonia: Ammonia slip shall not exceed 5 ppmvd @ 15% O₂ as determined by data collected during the required stack tests.
22. Mercury (Hg): Emissions of mercury from the CT/HRSG system shall not exceed 7.7 x 10⁻⁶ lb/MWh on a 12 month rolling average based on methods and requirements as described in 40 CFR 60.45Da(b) and 60.50Da(g).
[Rules 62-4.070(3), and 62-212.400(12)(PSD Avoidance), F.A.C, and 40 CFR 60.45Da (b) and 60.50Da(g)]
23. Nitrogen Oxides (NO_x): Emissions of NO_x from the CT/HRSG system shall not exceed the following standards as measured by the required CEMS for the averaging period specified, and as measured during the required stack tests.

- a. *While burning natural gas*:

5.0 ppm (for reference ~ 0.134 lb/MWh) on a rolling 30-day average

- b. *While burning synthetic gas*:

20.0 ppm (for reference ~ 0.574 lb/MWh) on a rolling 24-hr average

[Rules 62-4.070(3), and 62-212.400(12)(PSD Avoidance), F.A.C, Applicant Request]

24. NO_x Emissions Cap:

SECTION III - EMISSIONS UNITS SPECIFIC CONDITIONS

A. Unit B Integrated Gasification Combined Cycle (EU 030)

- a. *Existing Units 1 and 2:* The combined NO_x emissions from existing coal fired boiler steam electric generating Stanton Unit 1 and Stanton Unit 2 shall not exceed 8,300 tons per year on a 12-month rolling total beginning the first month of first fire of Unit B and thereafter. Total NO_x emissions shall be based on data collected from the Unit 1 and Unit 2 NO_x CEMS and the rolling 12-month total from each unit shall be computed in accordance with Specific Condition 44 of this subsection.
- b. *New Unit B:* NO_x emissions from the new Unit B CT/HRSO stack shall not exceed 987 tons on a 12-month rolling total. Total NO_x emissions shall be based on data collected from the required NO_x CEMS and computed in accordance with Specific Condition 44 of this subsection.
- c. If the combined NO_x emissions from Units 1 and 2 exceed 8,300 tons during any 12-month period, and/or the total NO_x emissions from Unit B exceeds 987 tons during any 12-month period, Unit B shall be subject to PSD preconstruction review, and a determination of BACT for NO_x shall be made.
- d. For purposes of meeting the NO_x emissions caps, annual emission of NO_x from existing Units 1 and 2, and Unit B shall be calculated without the Allowable Data Exclusions of Specific Condition 36 of this subsection. All valid hours of data (including startup and shutdown) must be included in the rolling 12-month totals. Also, the data substitution procedures of Part 75 for missing data shall not be used in these calculations.

[62-210.200 (net emissions increase), and 62-212.400(12) (Source Obligation), F.A.C.]

{Permitting Note: This project did not trigger PSD for NO_x due to a NO_x emissions cap taken on existing coal fired boiler steam electric generating Unit 1 and Unit 2. The above conditions establish the requirements for meeting the NO_x emission limitations for purposes of avoiding PSD preconstruction review. These requirements in no way supersede any federal requirement of the applicable NSPS or NESHAP provisions.}

25. **Unconfined Particulate Emissions:** During the construction period, unconfined particulate matter emissions shall be minimized by dust suppressing techniques such as covering, confining, or applying water or chemicals to the affected areas, as necessary. [Rule 62-296.320(4)(c), F.A.C.]
26. **Test Methods:** Required tests shall be performed in accordance with the following reference methods.

Method	Description of Method and Comments
1 - 4	Determination of Traverse Points, Velocity and Flow Rate, Gas Analysis, and Moisture Content. Methods shall be performed as necessary to support other methods.
5	Determination of Particulate Emissions. The minimum sample volume shall be 30 dry standard cubic feet.
6C	Determination of SO ₂ Emissions (Instrumental).
7E	Determination of NO _x Emissions (Instrumental). NO _x emissions testing shall be conducted with the air heater operating at the highest heat input possible during the test.
9	Visual Determination of Opacity
10	Measurement of Carbon Monoxide Emissions (Instrumental). The method shall be based on a continuous sampling train.
25A	Measurement of Gaseous Organic Concentrations (Flame Ionization – Instrumental)
CTM-027	Procedure for Collection and Analysis of Ammonia in Stationary Source <ul style="list-style-type: none"> • This is an EPA conditional test method. The minimum detection limit shall be 1 ppm.

SECTION III - EMISSIONS UNITS SPECIFIC CONDITIONS

A. Unit B Integrated Gasification Combined Cycle (EU 030)

Method CTM-027 is published on EPA's Technology Transfer Network Web Site at "http://www.epa.gov/ttn/emc/ctm.html". The other methods are described in 40 CFR 60, Appendix A, and adopted by reference in Rule 62-204.800, F.A.C. No other methods may be used for compliance testing unless prior written approval is received from the administrator of the Department's Emissions Monitoring Section in accordance with an alternate sampling procedure pursuant to 62-297.620, F.A.C. [Rules 62-204.800, F.A.C.; 40 CFR 60, Appendix A]

27. Testing Requirements: Initial tests shall be conducted between 90% and 100% of permitted capacity; otherwise, this permit shall be modified to reflect the true maximum capacity as constructed. Subsequent annual tests shall be conducted between 90% and 100% of permitted capacity in accordance with the requirements of Rule 62-297.310(2), F.A.C. Tests shall be conducted for each required pollutant when firing natural gas, when firing syngas, and when using the duct burners while firing each fuel in the CT. For each run during tests for visible emissions and ammonia slip, emissions of CO and NO_x recorded by the CEMS shall also be reported. Particulate matter testing and reporting shall include front and back half catches. Data collected from the reference method during the required CEMS quality assurance RATA tests may substitute for annual compliance tests for those pollutants, provided the owner or operator indicates this intent in the submitted test protocol, and obtains approval prior to testing. [Rule 62-297.310(7)(a), F.A.C.; 40 CFR 60.8]
28. Initial Compliance Demonstration: Initial compliance stack tests shall be conducted within 60 days after achieving the maximum production rate at which the combustion turbine will be operated, but not later than 180 days after the initial startup. In accordance with the test methods specified in this permit, the combustion turbine shall be tested to demonstrate initial compliance with the emission standards for CO, SO₂, NO_x, Hg, ammonia slip, VOC, and visible emissions. Particulate matter testing (front and back half) shall be conducted while firing synthetic gas and the results shall be reported to the compliance authority. The permittee shall provide the Compliance Authority with any other initial emissions performance tests conducted to satisfy vendor guarantees. [Rules 62-4.070, 62-297.310(7)(a), F.A.C. and 40 CFR 60.8]
29. Subsequent Compliance Testing: Annual compliance stack tests for CO, SO₂, NO_x, ammonia slip, VOC, and visible emissions shall be conducted during each federal fiscal year (October 1st, to September 30th). Annual testing to determine the ammonia slip shall be conducted while firing the primary fuel. Annual testing to determine particulate matter emissions (front and back half) shall be conducted while firing synthetic gas. Additional testing for CO and NO_x may be required following catalyst replacement. [Rules 62-4.070, 62-210.200(BACT), and 62-297.310(7)(a)4, F.A.C., and 40 CFR 60.50Da]
30. Continuous Compliance: Continuous compliance with the permit standards for emissions of CO, Hg, NO_x, and SO₂ shall be demonstrated with data collected from the required continuous monitoring systems. [Rules 62-4.070, and 62-210.200(BACT), F.A.C., 40 CFR 60.50Da]
31. Special Compliance Tests: When the Department, after investigation, has good reason (such as complaints, increased visible emissions or questionable maintenance of control equipment) to believe that any applicable emission standard contained in a Department rule or in a permit issued pursuant to those rules is being violated, it shall require the owner or operator of the emissions unit to conduct compliance tests which identify the nature and quantity of pollutant emissions from the emissions unit and to provide a report on the results of said tests to the Department. [Rule 62-297.310(7)(b), F.A.C.]

EXCESS EMISSIONS

{Permitting Note: The following conditions apply only to the SIP-based emissions standards specified in Condition No 15 of this subsection. Rule 62-210.700, F.A.C. (Excess Emissions) cannot vary or supersede any federal provision of the NSPS, NESHAP, or Acid Rain programs.}

SECTION III - EMISSIONS UNITS SPECIFIC CONDITIONS

A. Unit B Integrated Gasification Combined Cycle (EU 030)

32. Operating Procedures: The Best Available Control Technology (BACT) determinations established by this permit rely on "good operating practices" to reduce emissions. Therefore, all operators and supervisors shall be properly trained to operate and ensure maintenance of the gas turbine, HRSG, gasifier trains, and pollution control systems in accordance with the guidelines and procedures established by each manufacturer. The training shall include good operating practices as well as methods for minimizing excess emissions. [Rules 62-4.070(3) and 62-210.200(BACT), F.A.C.]
33. Definitions:
- Startup* is defined as the commencement of operation of any emissions unit which has shut down or ceased operation for a period of time sufficient to cause temperature, pressure, chemical or pollution control device imbalances, which result in excess emissions.
 - Shutdown* is the cessation of the operation of an emissions unit for any purpose.
 - Malfunction* is defined as any unavoidable mechanical and/or electrical failure of air pollution control equipment or process equipment or of a process resulting in operation in an abnormal or unusual manner.
- [Rule 62-210.200(164, 241, and 257), F.A.C.]
34. Excess Emissions Prohibited: Excess emissions caused entirely or in part by poor maintenance, poor operation or any other equipment or process failure that may reasonably be prevented during startup, shutdown or malfunction shall be prohibited. All such preventable emissions shall be included in any compliance determinations based on CEMS data. [Rule 62-210.700(4), F.A.C.]
35. Data Exclusion Procedures for SIP Compliance: Limited amounts of CEMS emissions data collected during startup, shutdown, and malfunction, and described in Condition 36 below, may be excluded from the corresponding SIP-based compliance demonstration, provided that best operational practices to minimize emissions are adhered to, the duration of data excluded is minimized, and the procedures for data exclusion listed below are followed. As provided by the authority in Rule 62-210.700(5), F.A.C., these conditions replace the provisions in Rule 62-210.700(1), F.A.C.
- Limiting Data Exclusion*. If the compliance calculation using all the CEMS emission data indicates that the emission unit is in compliance, then no CEMS data shall be excluded from the compliance demonstration.
 - Event Driven Exclusion*. There must be an underlying event (startup, shutdown, or malfunction) in order to exclude data. If there is no underlying event, then no data may be excluded.
 - Continuous Exclusion*. Data shall be excluded on a continuous basis. Data from discontinuous periods shall not be excluded for the same underlying event.
36. Allowable Data Exclusions: The following data may be excluded from the corresponding SIP-based compliance demonstration for each of the events listed below:
- Steam Turbine/HRSG System Cold Startup*: Up to six hours (in any 24-hr period) of excess emissions from the combustion turbine/HRSG system due to cold startup of the steam turbine/HRSG system may be excluded. A "cold startup of the steam turbine/HRSG system" is defined as startup of the combined cycle system following a shutdown of the steam turbine lasting at least 48 hours.
- {Permitting Note: During a cold startup of the steam turbine system, the gas turbine/HRSG system is brought on line at low load to gradually increase the temperature of the steam-electrical turbine and prevent thermal metal fatigue.}*

SECTION III - EMISSIONS UNITS SPECIFIC CONDITIONS

A. Unit B Integrated Gasification Combined Cycle (EU 030)

- b. *Steam Turbine/HRSG System Warm Startup*: Up to four hours (in any 24-hr period) of excess emissions from the combustion turbine/HRSG system due to warm startup of the steam turbine/HRSG system may be excluded. A "warm startup of the steam turbine/HRSG system" is defined as a startup of the combined cycle system following a shutdown of the steam turbine lasting at least 8 hours and less than 48 hours.
- c. *Shutdown*: Up to three hours (in any 24-hr period) of excess emissions from the gas turbine/HRSG system due to shutdown of the combined cycle operation may be excluded.
- d. *Malfunction*: Up to 2 hours (in any 24-hr period) of excess emissions from the combustion turbine/HRSG system due to a documented malfunction may be excluded. A "documented malfunction" means a malfunction that is documented within one working day of detection by contacting the Compliance Authority by telephone, facsimile transmittal, or electronic email.

All valid emissions data (including data collected during startup, shutdown, and malfunction) shall be used to report emissions for the Annual Operating Report.

[Rules 62-210.200(BACT), 62-210.370, and 62-210.700, F.A.C.]

37. *Ammonia Injection*: Ammonia injection shall begin as soon as operation of the gas turbine/HRSG system achieves the operating parameters specified by the manufacturer. As authorized by Rule 62-210.700(5), F.A.C., the above conditions allow excess emissions only for specifically defined periods of startup, shutdown, and documented malfunction of the gas turbine/HRSG system including the pollution control equipment.

[Design; Rules 62-210.200(BACT), 62-212.400(PSD), and 62-210.700, F.A.C.]

38. *Notification Requirements*: The owner or operator shall notify the Compliance Authority within one working day of discovering any emissions that demonstrate non-compliance for a given averaging period. Within one working day of occurrence, the owner or operator shall notify the Compliance Authority of any malfunction resulting in the exclusion of CEMS data. [Rule 62-4.070, F.A.C.]

CONTINUOUS MONITORING REQUIREMENTS

39. *CEM Systems*: The permittee shall install, calibrate, operate, and maintain continuous emission monitoring systems (CEMS) to measure and record the emissions of CO, NO_x, SO₂, and Hg from the combined cycle combustion turbine in terms of the applicable standards. Each monitoring system shall be installed, and functioning within the required performance specifications by the time of the initial compliance demonstration.
 - a. *CO Monitor*: The CO monitor shall be installed pursuant to 40 CFR 60, Appendix B, Performance Specification 4 or 4A. Quality assurance procedures shall conform to the requirements of 40 CFR 60, Appendix F. The RATA tests required for the CO monitor shall be performed using EPA Method 10 in Appendix A of 40 CFR 60 and shall be based on a continuous sampling train. The CO monitor span values shall be set appropriately, considering the allowable methods of operation and corresponding emission standards.
 - b. *NO_x Monitor*: A NO_x monitor installed to meet the requirements of 40 CFR 75, and that is continuing to meet the ongoing requirements of Part 75, may be used to meet the requirements of this permit and 40 CFR 60.49(c), Subpart Da, except that the owner or operator shall also meet the requirements of 60.51Da and the specific conditions of this permit. Data reported to meet the requirements of 60.51Da and the BACT limits of this permit shall not include data substituted using the missing data procedures in Subpart D of Part 75, nor shall the data have been bias adjusted according to Part 75.
 - c. *SO₂ Monitor*: The SO₂ monitor shall be installed pursuant to 40 CFR 60, Appendix B, Performance

SECTION III - EMISSIONS UNITS SPECIFIC CONDITIONS

A. Unit B Integrated Gasification Combined Cycle (EU 030)

Specification 2. Quality assurance procedures shall conform to the requirements of 40 CFR 60, Appendix F. The RATA tests required for the SO₂ monitor shall be performed using EPA Method 7 or 7E in Appendix A of 40 CFR 60. The SO₂ monitor span value shall be set according to 60.49Da(i).

- d. *Mercury Monitor:* A mercury CEMS shall be installed to measure mercury emissions and to meet the requirements of 60.49Da(p).
- e. *Diluent Monitor:* The oxygen (O₂) or carbon dioxide (CO₂) content of the flue gas shall be continuously monitored at the location where CO, NO_x, and SO₂ are monitored. Each monitor shall comply with the performance and quality assurance requirements of 40 CFR 75.

[Rules 62-4.070(3), 62-210.200(BACT), F.A.C., and 40 CFR 60.49Da and Subpart 75]

- 40. Continuous Flow Monitor: A continuous flow monitor shall be installed to determine stack exhaust flow rate to be used in determining mass emission rates. The flow monitor shall be certified and operated according to the requirements of 40 CFR 75. As an alternative to the stack flow monitor, a fuel flow monitoring system certified and operated according to the requirements of appendix D of 40 CFR Part 75 may be installed. [Rules 62-4.070(3), 62-210.200(BACT), F.A.C., and 40 CFR 60.49Da and Subpart 75]
- 41. Wattmeter: A wattmeter (or meters) to continuously measure the gross electrical output of the unit in megawatt-hours must be installed, calibrated, maintained, and operated in accordance with the manufacturer's specifications. [40 CFR 60.49Da]
- 42. Moisture Correction: If necessary, the owner or operator shall install a system to determine the moisture content of the exhaust gas and develop an algorithm to enable correction of the monitoring results to a dry basis (0% moisture). [Rules 62-4.070(3), 62-210.200(BACT), F.A.C.]
- 43. Ammonia Monitoring Requirements: In accordance with the manufacturer's specifications, the permittee shall install, calibrate, operate and maintain an ammonia flow meter to measure and record the ammonia injection rate to the SCR system prior to the initial compliance tests. The permittee shall document and periodically update the general range of ammonia flow rates required to meet permitted emissions levels over the range of load conditions allowed by this permit by comparing NO_x emissions recorded by the CEM system with ammonia flow rates recorded using the ammonia flow meter. During NO_x monitor downtimes or malfunctions, the permittee shall operate at the ammonia flow rate that is consistent with the documented flow rate for the combustion turbine load condition. [Rules 62-4.070(3) and 62-210.200(BACT), F.A.C.]

44. CEMS Data Requirements for BACT Standards:

{Permitting Note: The following conditions apply only to the SIP-based emissions standards specified in Condition Nos. 15 - 24 of this section. These requirements cannot vary or supersede any federal provision of the NSPS, NESHAP, or Acid Rain programs. Additional reporting and monitoring may be required by the individual subparts.}

- a. *Data Collection:* Except for continuous monitoring system breakdowns, repairs, calibration checks, and zero and span adjustments, emissions shall be monitored and recorded during all operation including startup, shutdown, and malfunction. Upon request by the Department, the CEMS emission rates shall be corrected to ISO conditions to demonstrate compliance with the applicable standards of 40 CFR 60.332.
- b. *Operating Hours and Operating Days:* An hour is the 60-minute period beginning at the top of each hour. Any hour during which an emissions unit is in operation for more than 15 minutes is an operating hour for that emission unit. A day is the 24-hour period from midnight to midnight. Any day with at

SECTION III - EMISSIONS UNITS SPECIFIC CONDITIONS

A. Unit B Integrated Gasification Combined Cycle (EU 030)

least one operating hour for an emissions unit is an operating day for that emission unit. [Rule 62-4.070, F.A.C.]

- c. *Valid Hour*: Each CEMS shall be designed and operated to sample, analyze, and record data evenly spaced over the hour at a minimum of one measurement per minute. All valid measurements collected during an hour shall be used to calculate a 1-hour block average that begins at the top of each hour.
 - 1) Hours that are **not operating** hours are **not valid** hours.
 - 2) For each operating hour, the 1-hour block average shall be computed from at least two data points separated by a minimum of 15 minutes. If less than two such data points are available, there is insufficient data and the 1-hour block average is not valid.
 - 3) During fuel switching, an hour in which syngas is fired is attributed towards compliance with the permit standards for syngas firing.
- d. *Rolling 24-Hour Average*: Compliance shall be determined after each valid hourly average is obtained by calculating the arithmetic average of that valid hourly average and the previous 23 valid hourly averages.

{Permitting Note: There may be more than one 24-hour compliance demonstration required for CO emissions depending on the use of alternate methods of operation}
- e. *Rolling 30-day Average*: Compliance shall be determined after each operating day by calculating the arithmetic average of all the valid hourly averages from that operating day and the prior 29 operating days.
- f. *Rolling 12-month Total*: Compliance shall be determined after each calendar month by calculating the total emissions from that calendar month and the last 11 calendar months.
- g. *Missing Data/Bias Adjustments*: If the owner or operator has installed a CEMS to meet the requirements of Part 75, data reported to show compliance with any SIP-based limit shall not include data substituted using the missing data procedures in Subpart D of Part 75, nor shall the data have been bias adjusted according to the procedures of Part 75.
- h. *Data Exclusion*: Each CEMS shall monitor and record emissions during all operations including episodes of startup, shutdown, malfunction, and fuel switches. Some of the CEMS emissions data recorded during these episodes may be excluded from the corresponding CEMS compliance demonstration subject to the provisions of Condition Nos. 35 and 36 of this subsection.
- i. *Availability*: Monitor availability for the Hg CEMS shall be 75% or greater, and for all other CEMS shall be 95% or greater in any calendar quarter. The quarterly excess emissions report shall be used to demonstrate monitor availability. In the event the applicable availability is not achieved, the permittee shall provide the Department with a report identifying the problems in achieving the required availability and a plan of corrective actions that will be taken to achieve 95% or 75% availability. The permittee shall implement the reported corrective actions within the next calendar quarter. Failure to take corrective actions or continued failure to achieve the minimum monitor availability shall be violations of this permit, except as otherwise authorized by the Department's Compliance Authority.

[Rules 62-4.070(3) and 62-210.200(BACT), F.A.C.]

REPORTING AND RECORD KEEPING REQUIREMENTS

45. *Monitoring of Capacity*: The permittee shall monitor and record the operating rate of the gas turbine and HRSG duct burner system on a daily average basis, considering the number of hours of operation during each day (including the times of startup, shutdown, malfunction, and fuel switching). Such monitoring shall be made using a monitoring component of the CEM system required above, or by monitoring daily

SECTION III - EMISSIONS UNITS SPECIFIC CONDITIONS

A. Unit B Integrated Gasification Combined Cycle (EU 030)

rates of consumption and heat content of each allowable fuel in accordance with the provisions of 40 CFR 75 Appendix D. [Rules 62-4.070(3) and 62-210.200(BACT), F.A.C.]

46. Monthly Operations Summary: By the fifth calendar day of each month, the permittee shall record the following for each fuel in a written or electronic log for the gas turbine for the previous month of operation: fuel consumption, hours of operation, hours of duct firing, and the updated 12-month rolling totals for each. Information recorded and stored as an electronic file shall be available for inspection and printing within at least three days of a request by the Department. The fuel consumption shall be monitored in accordance with the provisions of 40 CFR 75 Appendix D. [Rules 62-4.070(3) and 62-210.200(BACT), F.A.C.]
47. Fuel Sulfur Records: The permittee shall demonstrate compliance with the fuel sulfur limits specified in this permit by maintaining the following records of the sulfur contents.
- a. *Natural Gas*: Compliance with the fuel sulfur limit for natural gas shall be demonstrated by keeping reports obtained from the vendor indicating the average sulfur content of the natural gas being supplied from the pipeline for each month of operation. Methods for determining the sulfur content of the natural gas shall be ASTM methods D4084-82, D4468-85, D5504-01, D6228-98 and D6667-01, D3246-81 or more recent versions.

The above methods shall be used to determine the fuel sulfur content in conjunction with the provisions of 40 CFR 75 Appendix D. [Rules 62-4.070(3) and 62-4.160(15), F.A.C.]

48. Emissions Performance Test Reports: A report indicating the results of any required emissions performance test shall be submitted to the Compliance Authority no later than 45 days after completion of the last test run. The test report shall provide sufficient detail on the tested emission unit and the procedures used to allow the Department to determine if the test was properly conducted and if the test results were properly computed. At a minimum, the test report shall provide the applicable information listed in Rule 62-297.310(8)(c), F.A.C. and in Appendix SC of this permit. [Rule 62-297.310(8), F.A.C.].
49. CEMS Data Assessment Report: The Data Assessment Report required by 40 CFR, Appendix F shall be submitted to the Compliance Authority on a quarterly basis for each CEMS required for compliance with a BACT limit only. Separate reporting may be required for CEMS installed for purposes of compliance with an NSPS limit, or Acid Rain.
50. Excess Emissions Reporting:
- a. *Malfunction Notification*: If emissions in excess of a standard (subject to the specified averaging period) occur due to malfunction, the permittee shall notify the Compliance Authority within (1) working day of: the nature, extent, and duration of the excess emissions; the cause of the excess emissions; and the actions taken to correct the problem. In addition, the Department may request a written summary report of the incident.
- b. *SIP Quarterly Report*: Within 30 days following the end of each calendar-quarter, the permittee shall submit a report to the Compliance Authority summarizing periods of CO, and SO₂ emissions in excess of the BACT permit standards following the NSPS format in 40 CFR 60.7(c), Subpart A. A summary of data excluded from SIP compliance calculations should also be provided for. In addition, the report shall summarize the CO, NO_x, SO₂, and Hg CEMS systems monitor availability for the previous quarter.
- c. *NSPS Reporting*: Within 30 days following each calendar quarter, the permittee shall submit the written reports required under 40 CFR 60.51Da for the previous quarter or semi-annual period to the Compliance Authority. Also, within 30 days following the end of each calendar semi-annual period, the permittee shall submit a report on any periods of excess emissions, as applicable, and defined by

SECTION III - EMISSIONS UNITS SPECIFIC CONDITIONS

A. Unit B Integrated Gasification Combined Cycle (EU 030)

NSPS KKKK, and/or NSPS GG that occurred during the previous semi-annual period to the Compliance Authority.

[Rules 62-4.130, 62-204.800, 62-210.700(6), F.A.C., and 40 CFR 60.7, 60.51Da, and 60.4375]

51. **Annual Operating Report:** The permittee shall submit an annual report that summarizes the actual operating hours and emissions from this facility in accordance with 62-210.370. Emissions reported for Unit B shall include estimates of emissions from the flare and startup stack. Annual operating reports shall be submitted to the Compliance Authority by March 1st of each year. [Rule 62-210.370(2), F.A.C.]

FEDERAL REQUIREMENTS

{Permitting Note: The following descriptions summarize specific regulations of the various subparts that are potentially applicable to Unit B. These summaries are based on the current status of each subpart and are included for purposes of clarification.}

52. **NSPS Subpart Da:** The provisions of Subpart Da apply to heat recovery steam generators and the associated stationary combustion turbine(s) burning fuels containing 75 percent by (heat input) or more synthetic-coal gas on a 12-month rolling average. If Unit B burns 75 percent or more syngas on a 12-month rolling average, the CT/HRSG system will be subject to and must comply with the requirements of Subpart Da. Applicable requirements of Subpart Da are summarized below, and details of the Subpart can be found in Appendix Da of this permit.

NSPS Subpart Da Requirements					
<i>Applicable When Firing ≥ 75% Syngas (12-month rolling average)</i>					
Pollutant	Method of Operation*	Limit		Averaging Time	Method of Compliance
		Lb/mmBtu	Lb/MWh		
SO ₂	All Modes	N/A	1.4	30-day Rolling	CEMS
NO _x	CT/CT & DB	N/A	1.0	30-day Rolling	CEMS
	DB	N/A	1.0	30-day Rolling	CEMS
PM	All Modes	0.015	0.14	6-minute block	CEMS ^b
		20% Opacity			Annual Test
Mercury	All Modes	N/A	0.000020	12-month Rolling	CEMS/Sorbent Trap

- a. Demonstration of a fuel sulfur specification of ≤ 0.15 lb S/mmBtu fuel also demonstrates compliance with the PM limit for units that burn liquid or gaseous fuels.

[40 CFR 60 Subpart Da]

53. **NSPS Subpart GG:** The provisions of Subpart GG apply to stationary gas turbines. Prior to finalization of NSPS Subpart KKKK, if Unit B burns less than 75 percent syngas on a 12-month rolling average, the CT will be subject to and must comply with the requirements of Subpart GG, and the HRSG duct burners will be subject to Da. Applicable requirements of Subpart GG are summarized below, and details of the Subpart can be found in Appendix GG of this permit.

- a. *Nitrogen Oxides (NO_x):*

$$STD = 0.0075 \frac{(14.4)}{Y} + F$$

where:

SECTION III - EMISSIONS UNITS SPECIFIC CONDITIONS

A. Unit B Integrated Gasification Combined Cycle (EU 030)

STD = allowable ISO corrected (if required as given in §60.335(b)(1)) NOX emission concentration (percent by volume at 15 percent oxygen and on a dry basis),

Y = manufacturer's rated heat rate at manufacturer's rated load (kilojoules per watt hour) or, actual measured heat rate based on lower heating value of fuel as measured at actual peak load for the facility. The value of Y shall not exceed 14.4 kilojoules per watt hour, and

F = NOX emission allowance for fuel-bound nitrogen as defined in paragraph (a)(4) of this section.

b. Sulfur Dioxides (SO₂):

Emissions of sulfur dioxide shall not exceed 0.015 percent by volume at 15 percent oxygen and on a dry basis.

No owner or operator subject to the provisions of this subpart shall burn in any stationary gas turbine any fuel which contains total sulfur in excess of 0.8 percent by weight (8000 ppmw).

54. **NSPS Subpart KKKK:** The proposed provisions of Subpart KKKK apply to stationary gas turbines constructed after February 18, 2005. Once Subpart KKKK is finalized, if Unit B burns less than 75 percent syngas on a 12-month rolling average, the CT/HRSG system will be subject to and must comply with the requirements of Subpart KKKK, and not Subparts GG and Da. Applicable requirements of Subpart KKKK are summarized below, and details of the Subpart can be found in Appendix KKKK of this permit.

NSPS Subpart KKKK Requirements					
<i>Applicable When Firing < 75% Syngas (12-month rolling average)</i>					
Pollutant	Method of Operation*	Limit		Averaging Time	Method of Compliance
		ppm @ 15% O ₂	Lb/MWhr		
NO _x	CC	15	0.43	30-day Rolling	CEMS
	SC	15	0.043	4-hr Rolling	CEMS
SO ₂	All modes	0.06 lb/mmBtu		Daily Sampling	Fuel Records
		Or 0.90 lb/MWh		Three 1-hr Runs	Annual Test

55. **NESHAP Subpart YYYY:** The combustion turbine is subject to 40 CFR 63, Subpart A, Identification of General Provisions and 40 CFR 63, Subpart YYYY, National Emissions Standard for Hazardous Air Pollutants for Stationary Combustion Gas Turbines. On August 18, 2004 EPA issued a final rule staying the effectiveness of this Subpart with respect to lean premix and diffusion flame gas-fired combustion turbines. The project must comply with the Initial Notification requirements set forth in Sec. 63.6145 and comply with any other applicable requirement of Subpart YYYY upon final action by EPA and publication in the Federal Register. Subpart YYYY specifies an emission limit of 91 parts per billion (ppbv) of formaldehyde (CH₂O) applicable to stationary gas tubines.

SECTION III - EMISSIONS UNITS SPECIFIC CONDITIONS

B. Unit B Flare (EU 031)

ID	Emission Unit Description
031	Unit B Flare – A multipoint flare (including 8 pilot flares) enclosed in a 20 foot thermal barrier fence used to combust syngas during startups (once the gasifier switches fuels from natural gas to coal), and during plant upset conditions.

APPLICABLE STANDARDS AND REGULATIONS

1. BACT Determinations: The emission unit addressed in this section is subject to a Best Available Control Technology (BACT) determination for carbon monoxide (CO), nitrogen oxides (NO_x), particulate matter (PM/PM₁₀), sulfur dioxide (SO₂), and volatile organic compounds (VOCs).
[Rule 62-210.200 (BACT), F.A.C.]

EQUIPMENT SPECIFICATIONS

2. Equipment: The permittee is authorized to install, operate, and maintain one multipoint flare system, approximately 214 feet by 123 feet, enclosed in a 20 foot thermal barrier fence. The flare system will be designed to combust synthetic gas during startup, and during upsets of the gasification plant or the combustion turbine. The flare system will also include 8 pilot flares fueled by natural gas.
[Applicant Request; Rule 62-210.200(PTE), F.A.C.]

PERFORMANCE REQUIREMENTS

3. Hours of Operation: The hours of operation are not restricted (8760 hours per year).
[Applicant Request; Rule 62-210.200(PTE), F.A.C.]
4. Authorized Fuels: Only natural gas containing no more than 2.0 grains of sulfur per 100 standard cubic feet of natural gas shall be fired in the pilot flares.
5. Methods of Operation: Subject to the restrictions and requirements of this permit, the flare may operate under the following methods of operation.
 - a. Pilot Flare: The 8 pilot flares shall be operated with a flame present at all times.
 - b. Synthetic Gas Flaring: Once the gasifiers reach a reducing atmosphere, synthetic gas shall be directed through the gas clean-up processes to the flare. Flaring will take place only until there is sufficient synthetic gas production to support operation of the combustion turbine. Operation of the combustion turbine may be accomplished by mixing the synthetic gas with natural gas.

[Application; Rules 62-210.200 (PTE, and BACT) and 62-212.400 (PSD), F.A.C

6. Work Practice: Good combustion practices will be utilized at all times to ensure emissions from the flare system are minimized. The Best Available Control Technology (BACT) determinations established by this permit rely on “good operating practices” to reduce emissions. Therefore, all operators and supervisors shall be properly trained to operate and ensure maintenance of the flare and pilot systems in accordance with the guidelines and procedures established by each manufacturer. The training shall include good operating practices as well as methods for minimizing excess emissions.
[Rules 62-4.070(3) and 62-210.200(BACT), F.A.C.]
7. Pilot Flares: The 8 pilot flares shall be operated with a flame present at all times. The presence of a flare pilot flame shall be monitored using a thermocouple or any other equivalent device to detect the presence of a flame. [Rules 62-4.070(3) and 62-210.200(BACT), F.A.C.]

NOTIFICATION, REPORTING, AND RECORDS

8. Pilot Flare Records: The permittee shall keep readily accessible records demonstrating the presence of a flame on the pilot flares.

SECTION III - EMISSIONS UNITS SPECIFIC CONDITIONS

B. Unit B Flare (EU 031)

9. Fuel Records: The permittee shall keep records sufficient to determine the annual throughput of natural gas of this unit for use in the Annual Operating Report.
[Rule 62-204.800(7)(b)16, F.A.C]



SECTION III - EMISSIONS UNITS SPECIFIC CONDITIONS

C. Unit B Cooling Tower (EU 032)

This section of the permit addresses the following emissions unit.

ID	Emission Unit Description
032	Unit B Cooling Tower – consisting of six cells with six individual exhaust fans.

EQUIPMENT

1. Cooling Tower: The permittee is authorized to install one 6-cell mechanical draft cooling tower with the following nominal design characteristics: a circulating water flow rate of 86,000 gpm; a design air flow rate of 1,361,880 acfm per cell; drift eliminators; and a drift rate of no more than 0.0005 percent of the circulating water flow. [Application; Design]

EMISSIONS AND PERFORMANCE REQUIREMENTS

2. Drift Rate: Within 60 days of commencing commercial operation, the permittee shall certify that the cooling tower was constructed to achieve the specified drift rate of no more than 0.0005 percent of the circulating water flow rate. [Rule 62-210.200(BACT), F.A.C.]

{Permitting Note: This work practice standard is established as BACT for PM/PM₁₀ emissions from the cooling tower. Based on this design criteria, potential emissions are estimated to be less than 14 tons of PM per year and less than 6 tons of PM₁₀ per year. Actual emissions are expected to be lower than these rates.}

SECTION III - EMISSIONS UNITS SPECIFIC CONDITIONS

D. Unit B Materials Storage and Handling (Units 33, 34, and 35)

This section of the permit addresses the following emissions unit.

ID	Emission Unit Description	
033	Unit B Coal Mill and Coal Storage – including coal crushing, and crushed coal storage, coal pulverizing and feed preparation.	
	<i>Point ID No.</i>	<i>Description</i>
	CMS1	Coal Mill Silo No. 1 Baghouse
	CMS2	Coal Mill Silo No. 2 Baghouse
	CMS3	Coal Mill Silo No. 3 Baghouse
	CMS4	Coal Mill Silo No. 4 Baghouse
	PCS1	Pulverized Coal Storage Bin No. 1 Baghouse
	PCS2	Pulverized Coal Storage Bin No. 2 Baghouse
	PCS3	Pulverized Coal Storage Bin No. 3 Baghouse
	PCS4	Pulverized Coal Storage Bin No. 4 Baghouse
034	Unit B Gasification Ash Storage – including fly ash storage silo and baghouse.	
035	Unit B Coal Handling – Including coal conveying and transfer.	

APPLICABLE STANDARDS AND REGULATIONS

1. **BACT Determinations:** A determination of the Best Available Control Technology (BACT) was made for particulate matter (PM/PM₁₀). To satisfy the BACT requirements for this unit the visible emissions limits, and the baghouse specifications act as surrogate standards for particulate matter. [Rule 62-210.200 (BACT), F.A.C.]
2. **NSPS Requirements:** These units are subject to 40 CFR 60, Subpart A (Identification of General Provisions) and 40 CFR 60, Subpart Y (Standards of Performance for Coal Preparation Plants). The Department determines that the BACT emissions performance requirements are as stringent as or more stringent than the limits imposed by the applicable NSPS provisions. Some separate reporting and monitoring may be required by the individual subparts.

EQUIPMENT AND CONTROL TECHNOLOGY

3. **Equipment Description:** The permittee is authorized to construct, operate, and maintain equipment needed for the grinding, storage, and handling of Unit B coal. Equipment will include a radial-pedestal stacker conveyor; a crusher shed with tramp screens, magnetic separator, sampling system, and crusher; four crushed coal silos with dedicated pulverizers; four surge bins; a high pressure coal feeder system; and all associated conveyor systems.
4. **Baghouse Controls:** Each coal mill silo and each pulverized coal storage bin will be controlled by a baghouse system. Each required baghouse shall be designed, operated, and maintained to achieve a PM design specification of 0.0085 gr/dscf. [Rules 62-4.070(3), and 62-210.200 (BACT), F.A.C.]

PERFORMANCE REQUIREMENTS

5. **Hours of Operation:** The hours of operation for this emissions unit are not limited (8760 hours per year). [Rule 62-21.200 (PTE), F.A.C.]

SECTION III - EMISSIONS UNITS SPECIFIC CONDITIONS

D. Unit B Materials Storage and Handling (Units 33, 34, and 35)

6. Unconfined Emissions of Particulate Matter

- a. No person shall cause, let, permit, suffer or allow the emissions of unconfined particulate matter from any activity without taking reasonable precautions to prevent such emissions. Such activities include, but are not limited to: vehicular movement; transportation of materials; construction, alteration, demolition or wrecking; or industrially related activities such as loading, unloading, storing or handling.
- b. Reasonable precautions shall include the following:
 - (1) Landscaping and planting of vegetation.
 - (2) Application of water to control fugitive dust from activities such as demolition of buildings, grading roads, construction, and land clearing.
 - (3) Water supply lines, hoses and sprinklers shall be located near all stockpiles of raw materials, coal, and petroleum coke.
 - (4) All plant operators shall be trained in basic environmental compliance and shall perform visual inspections of raw materials, coal and petroleum coke periodically and before handling. If the visual inspections indicate a lack of surface moisture, such materials shall be wetted with sprinklers. Wetting shall continue until the potential for unconfined particulate matter emissions are minimized.
 - (5) Water spray shall be used to wet the materials and fuel if inherent moisture and moisture from wetting the storage piles are not sufficient to prevent unconfined particulate matter emissions.
 - (6) As necessary, applications of asphalt, water, or dust suppressants to unpaved roads, yards, open stockpiles and similar activities.
 - (7) Paving of access roadways, parking areas, manufacture area, and fuel storage yard.
 - (8) Removal of dust from buildings, roads, and other paved areas under the control of the owner or operator of the facility to prevent particulate matter from becoming airborne.
 - (9) A vacuum sweeper shall be used to remove dust from paved roads, parking, and other work areas.
 - (10) Enclosure or covering of conveyor systems where practicably feasible.
 - (11) All materials at the plant shall be stored under roof. Materials, other than quarried materials, shall be stored on compacted clay or concrete, or in enclosed vessels.
 - (12) Use of hoods, fans, filters, and similar equipment to contain, capture and/or vent particulate matter.
 - (13) Confining abrasive blasting where possible.
- c. In determining what constitutes reasonable precautions for a particular source, the Department shall consider the cost of the control technique or work practice, the environmental impacts of the technique or practice, and the degree of reduction of emissions expected from a particular technique or practice.

EMISSIONS AND TESTING REQUIREMENTS

7. Visible Emissions Standards: Visible emissions from each baghouse, and visible emissions from all coal processing and conveying equipment, coal storage systems, or coal transfer and loading systems and not controlled by a baghouse, shall not exceed 5 % opacity.
8. Testing Requirements: Each emission point shall be tested to demonstrate initial compliance with the visible emissions standards. The tests shall be conducted within 60 days after achieving the maximum production rate at which the unit will be operated, but not later than 180 days after the initial startup. Thereafter, compliance with the visible emission limits shall be demonstrated during each federal fiscal year (October 1st to September 30th). Compliance with the visible emission limits shall be determined by

SECTION III - EMISSIONS UNITS SPECIFIC CONDITIONS

D. Unit B Materials Storage and Handling (Units 33, 34, and 35)

conducting EPA Method 9 tests. Tests shall be conducted in accordance with the applicable requirements in Appendix C of this permit as well as the applicable NSPS provisions.
[Rule 62-297.310(7)(a), F.A.C., and 40 CFR 60.252]

9. Test Reports: For each test conducted, the permittee shall file a test report including the information specified in Rule 62-297.310(8), F.A.C. with the compliance authority no later than 45 days after the last run of each test is completed. [Rules 62-297.310(8), F.A.C.]

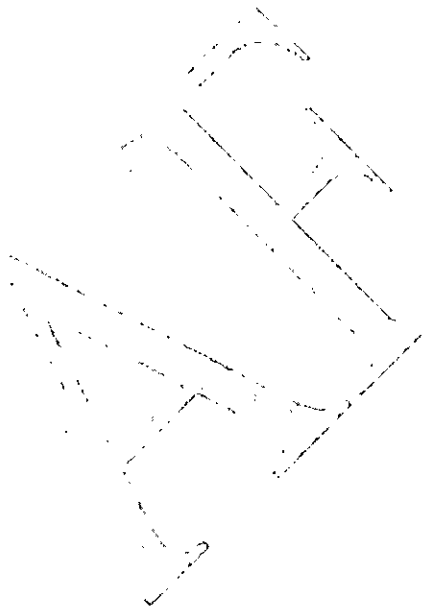

SECTION IV. APPENDICES

CONTENTS

Appendix A	NSPS Subpart A, Identification of General Provisions
Appendix BD	Final BACT Determinations and Emissions Standards
Appendix Da	NSPS Subpart Da Requirements for Duct Burners
Appendix GC	General Conditions
Appendix GG	NSPS subpart GG Requirements for Gas Turbines
Appendix KKKK	NSPS Subpart KKKK Requirements for Stationary Combustion Turbines
Appendix SC	Standard Conditions
Appendix Y	NSPS Subpart Y Requirements for Coal Preparation Plants
Appendix YYY	NESHAP Subpart YYY Standard for HAPs for Stationary Combustion Gas Turbines

SECTION IV. APPENDIX A

NSPS SUBPART A, IDENTIFICATION OF GENERAL PROVISIONS

Emissions units subject to a New Source Performance Standard of 40 CFR 60 are also subject to the applicable requirements of Subpart A, the General Provisions, including:

- § 60.1 Applicability.
- § 60.2 Definitions.
- § 60.3 Units and abbreviations.
- § 60.4 Address.
- § 60.5 Determination of construction or modification.
- § 60.6 Review of plans.
- § 60.7 Notification and Record Keeping.
- § 60.8 Performance Tests.
- § 60.9 Availability of information.
- § 60.10 State Authority.
- § 60.11 Compliance with Standards and Maintenance Requirements.
- § 60.12 Circumvention.
- § 60.13 Monitoring Requirements.
- § 60.14 Modification.
- § 60.15 Reconstruction.
- § 60.16 Priority List.
- § 60.17 Incorporations by Reference.
- § 60.18 General Control Device Requirements.
- § 60.19 General Notification and Reporting Requirements.

Individual subparts may exempt specific equipment or processes from some or all of these requirements. The general provisions may be provided in full upon request.

SECTION IV. APPENDIX BD

FINAL BACT DETERMINATIONS AND EMISSIONS STANDARDS

Refer to the draft BACT proposal discussed in the initial Technical Evaluation for this project and to the Final Determination issued with the Final permit for the rationale regarding the following BACT determination.

Insert Emissions Table From Final Permit

SECTION IV. APPENDIX BD
FINAL BACT DETERMINATIONS AND EMISSIONS STANDARDS

DETAILS OF THE ANALYSIS MAY BE OBTAINED BY CONTACTING:

A. A. Linero, P.E., Program Administrator _____
New Source Review Section
Department of Environmental Protection
Bureau of Air Regulation
2600 Blair Stone Road
Tallahassee, Florida 32399-2400

Recommended By:

Approved By:

Trina L. Vielhauer, Chief
Bureau of Air Regulation

Joseph Kahn, P.E., Acting Director
Division of Air Resources Management

Date

Date

SECTION IV. APPENDIX Da

NSPS SUBPART Da REQUIREMENTS FOR STEAM GENERATING UNITS

When burning 75 percent (by heat input) or more synthetic coal gas, on a 12-month rolling average, Unit B heat recovery steam generator and the associated stationary combustion turbine are subject to NSPS Subpart Da (Standards of Performance for Electric Utility Steam Generating Units for Which Construction is Commenced After September 18, 1978).

{Permitting Note: Numbering of the original NSPS rules in the following conditions has been preserved for ease of reference. Paragraphs that are not applicable have been omitted for clarity and brevity. When used in 40 CFR 60, the term "Administrator" shall mean the Secretary or the Secretary's designee.}

§ 60.40Da Applicability and designation of affected facility.

(a) The affected facility to which this subpart applies is each electric utility steam generating unit:

- (1) That is capable of combusting more than 73 megawatts (250 million Btu/hour) heat input of fossil fuel (either alone or in combination with any other fuel); and
- (2) For which construction or modification is commenced after September 18, 1978.

(b) Heat recovery steam generators that are associated with stationary combustion turbines burning fuels other than 75 percent (by heat input) or more synthetic-coal gas on a 12-month rolling average and that meet the applicability requirements of subpart KKKK of this part are not subject to this subpart. Heat recovery steam generators and the associated stationary combustion turbine(s) burning fuels containing 75 percent (by heat input) or more synthetic-coal gas on a 12-month rolling average are subject to this part and are not subject to subpart KKKK of this part. This subpart will continue to apply to all other electric utility combined cycle gas turbines that are capable of combusting more than 73 MW (250 MMBtu/h) heat input of fossil fuel in the heat recovery steam generator. If the heat recovery steam generator is subject to this subpart and the combined cycle gas turbine burn fuels other than synthetic-coal gas, only emissions resulting from combustion of fuels in the steam-generating unit are subject to this subpart. (The combustion turbine emissions are subject to subpart GG or KKKK, as applicable, of this part).

[44 FR 33613, June 11, 1979, as amended at 63 FR 49453, Sept. 16, 1998. Redesignated at 70 FR 51268, Aug. 30, 2005, as amended at 71 FR 9876, Feb. 27, 2006]

§ 60.42Da Standard for particulate matter.

(a) On and after the date on which the performance test required to be conducted under §60.8 is completed, no owner or operator subject to the provisions of this subpart shall cause to be discharged into the atmosphere from any affected facility for which construction, reconstruction, or modification commenced before or on February 28, 2005, any gases that contain particulate matter in excess of:

- (1) 13 ng/J (0.03 lb/million Btu) heat input derived from the combustion of solid, liquid, or gaseous fuel;
- (2) 1 percent of the potential combustion concentration (99 percent reduction) when combusting solid fuel; and
- (3) 30 percent of potential combustion concentration (70 percent reduction) when combusting liquid fuel.

(b) On and after the date the particulate matter performance test required to be conducted under §60.8 is completed, no owner or operator subject to the provisions of this subpart shall cause to be discharged into the atmosphere from any affected facility any gases which exhibit greater than 20 percent opacity (6-minute average), except for one 6-minute period per hour of not more than 27 percent opacity.

(c) On and after the date on which the performance test required to be conducted under §60.8 is completed, no owner or operator subject to the provisions of this subpart shall cause to be discharged into the atmosphere from any affected facility for which construction, reconstruction, or modification is commenced after February 28, 2005, except for modified affected facilities meeting the requirements of paragraph (d) of this section, any gases that contain particulate matter in excess of either:

- (1) 18 ng/J (0.14 lb/MWh) gross energy output; or
- (2) 6.4 ng/J (0.015 lb/MMBtu) heat input derived from the combustion of solid, liquid, or gaseous fuel.

(d) As an alternative to meeting the requirements of paragraph (c) of this section, the owner or operator of an affected facility for which construction, reconstruction, or modification commenced after February 28, 2005, may elect to meet the requirements of this paragraph. On and after the date on which the performance test required to be conducted under §60.8 is completed, the owner or operator subject to the provisions of this subpart shall not cause to be discharged into the atmosphere from any affected facility for which construction, reconstruction, or modification commenced after February 28, 2005, any gases that contain particulate matter in excess of:

- (1) 13 ng/J (0.03 lb/MMBtu) heat input derived from the combustion of solid, liquid, or gaseous fuel, and
- (2) 0.1 percent of the combustion concentration determined according to the procedure in §60.48Da(o)(5) (99.9 percent reduction) for an affected facility for which construction or reconstruction commenced after February 28, 2005 when combusting solid fuel or solid-derived fuel, or
- (3) 0.2 percent of the combustion concentration determined according to the procedure in §60.48Da(o)(5) (99.8 percent reduction) for an affected facility for which modification commenced after February 28, 2005 when combusting solid fuel or solid-derived fuel.

[44 FR 33613, June 11, 1979. Redesignated at 70 FR 51268, Aug. 30, 2005, as amended at 71 FR 9877, Feb. 27, 2006]

§ 60.43Da Standard for sulfur dioxide.

(i) On and after the date on which the performance test required to be conducted under §60.8 is completed, no owner or operator subject to the provisions of this subpart shall cause to be discharged into the atmosphere from any affected facility for which construction,

SECTION IV. APPENDIX Da

NSPS SUBPART Da REQUIREMENTS FOR STEAM GENERATING UNITS

reconstruction, or modification commenced after February 28, 2005, except as provided for under paragraphs (j) or (k) of this section, any gases that contain sulfur dioxide in excess of the applicable emission limitation specified in paragraphs (i)(1) through (3) of this section.

(1) For an affected facility for which construction commenced after February 28, 2005, any gases that contain sulfur dioxide in excess of either:

- (i) 180 ng/J (1.4 lb/MWh) gross energy output on a 30-day rolling average basis, or
- (ii) 5 percent of the potential combustion concentration (95 percent reduction) on a 30-day rolling average basis.

[44 FR 33613, June 11, 1979, as amended at 54 FR 6663, Feb. 14, 1989; 54 FR 21344, May 17, 1989; 65 FR 61752, Oct. 17, 2000. Redesignated and amended at 70 FR 51268, Aug. 30, 2005; 71 FR 9877, Feb. 27, 2006]

§ 60.44Da Standard for nitrogen oxides.

(2) *NO_x reduction requirement.*

Fuel type	Percent reduction of potential combustion concentration
Gaseous fuels	25
Liquid fuels	30
Solid fuels	65

(c) Except as provided under paragraph (d) of this section, when two or more fuels are combusted simultaneously, the applicable standard is determined by proration using the following formula:

$$E_n = [86w + 130x + 210y + 260z + 340v] / 100$$

where:

- E_n is the applicable standard for nitrogen oxides when multiple fuels are combusted simultaneously (ng/J heat input);
- w is the percentage of total heat input derived from the combustion of fuels subject to the 86 ng/J heat input standard;
- x is the percentage of total heat input derived from the combustion of fuels subject to the 130 ng/J heat input standard;
- y is the percentage of total heat input derived from the combustion of fuels subject to the 210 ng/J heat input standard;
- z is the percentage of total heat input derived from the combustion of fuels subject to the 260 ng/J heat input standard; and
- v is the percentage of total heat input delivered from the combustion of fuels subject to the 340 ng/J heat input standard.

(e) On and after the date on which the performance test required to be conducted under §60.8 is completed, no owner or operator subject to the provisions of this subpart shall cause to be discharged into the atmosphere from any affected facility for which construction, reconstruction, or modification commenced after February 28, 2005, except for an IGCC meeting the requirements of paragraph (f) of this section, any gases that contain nitrogen oxides (expressed as NO₂) in excess of the applicable emission limitation specified in paragraphs (e)(1) through (3) of this section.

(1) For an affected facility for which construction commenced after February 28, 2005, the owner or operator shall not cause to be discharged into the atmosphere any gases that contain nitrogen oxides (expressed as NO₂) in excess of 130 ng/J (1.0 lb/MWh) gross energy output on a 30-day rolling average basis, except as provided under §60.48Da(k).

[44 FR 33613, June 11, 1979, as amended at 54 FR 6664, Feb. 14, 1989; 63 FR 49453, Sept. 16, 1998; 66 FR 18551, Apr. 10, 2001; 66 FR 42610, Aug. 14, 2001. Redesignated and amended at 70 FR 51268, Aug. 30, 2005; 71 FR 9878, Feb. 27, 2006]

§ 60.45Da Standard for mercury.

(b) For each IGCC electric utility steam generating unit, on and after the date on which the initial performance test required to be conducted under §60.8 is completed, no owner or operator subject to the provisions of this subpart shall cause to be discharged into the atmosphere from any affected facility for which construction or reconstruction commenced after January 30, 2004, any gases which contain Hg emissions in excess of 20×10^{-6} lb/MWh or 0.020 lb/GWh on an output basis. The SI equivalent is 0.0025 ng/J. This Hg emissions limit is based on a 12-month rolling average using the procedures in §60.50Da(g).

[70 FR 28653, May 18, 2005. Redesignated and amended at 70 FR 51268, Aug. 30, 2005]

§ 60.48Da Compliance provisions.

(a) Compliance with the particulate matter emission limitation under §60.42Da(a)(1) constitutes compliance with the percent reduction requirements for particulate matter under §60.42Da(a)(2) and (3).

(b) Compliance with the nitrogen oxides emission limitation under §60.44Da(a) constitutes compliance with the percent reduction requirements under §60.44Da(a)(2).

(c) The particulate matter emission standards under §60.42Da, the nitrogen oxides emission standards under §60.44Da, and the Hg emission standards under §60.45Da apply at all times except during periods of startup, shutdown, or malfunction.

(e) After the initial performance test required under §60.8, compliance with the sulfur dioxide emission limitations and percentage reduction requirements under §60.43Da and the nitrogen oxides emission limitations under §60.44Da is based on the average emission rate for 30 successive boiler operating days. A separate performance test is completed at the end of each boiler operating day after the

SECTION IV. APPENDIX Da

NSPS SUBPART Da REQUIREMENTS FOR STEAM GENERATING UNITS

initial performance test, and a new 30 day average emission rate for both sulfur dioxide and nitrogen oxides and a new percent reduction for sulfur dioxide are calculated to show compliance with the standards.

(f) For the initial performance test required under §60.8, compliance with the sulfur dioxide emission limitations and percent reduction requirements under §60.43Da and the nitrogen oxides emission limitation under §60.44Da is based on the average emission rates for sulfur dioxide, nitrogen oxides, and percent reduction for sulfur dioxide for the first 30 successive boiler operating days. The initial performance test is the only test in which at least 30 days prior notice is required unless otherwise specified by the Administrator. The initial performance test is to be scheduled so that the first boiler operating day of the 30 successive boiler operating days is completed within 60 days after achieving the maximum production rate at which the affected facility will be operated, but not later than 180 days after initial startup of the facility.

(g) The owner or operator of an affected facility subject to emission limitations in this subpart shall determine compliance as follows:

(1) Compliance with applicable 30-day rolling average SO₂ and NO_x emission limitations is determined by calculating the arithmetic average of all hourly emission rates for SO₂ and NO_x for the 30 successive boiler operating days, except for data obtained during startup, shutdown, malfunction (NO_x only), or emergency conditions (SO₂) only.

(2) Compliance with applicable SO₂ percentage reduction requirements is determined based on the average inlet and outlet SO₂ emission rates for the 30 successive boiler operating days.

(3) Compliance with applicable daily average particulate matter emission limitations is determined by calculating the arithmetic average of all hourly emission rates for particulate matter each boiler operating day, except for data obtained during startup, shutdown, and malfunction.

(h) If an owner or operator has not obtained the minimum quantity of emission data as required under §60.49Da of this subpart, compliance of the affected facility with the emission requirements under §§60.43Da and 60.44Da of this subpart for the day on which the 30-day period ends may be determined by the Administrator by following the applicable procedures in section 7 of Method 19.

(i) Compliance provisions for sources subject to §60.44Da(d)(1), (e)(1), or (f). The owner or operator of an affected facility subject to §60.44Da(d)(1) or (e)(1) shall calculate NO_x emissions by multiplying the average hourly NO_x output concentration, measured according to the provisions of §60.49Da(c), by the average hourly flow rate, measured according to the provisions of §60.49Da(l), and dividing by the average hourly gross energy output, measured according to the provisions of §60.49Da(k).

(k) Compliance provisions for duct burners subject to §60.44Da(d)(1) or (e)(1). To determine compliance with the emission limitation for NO_x required by §60.44Da(d)(1) or (e)(1) for duct burners used in combined cycle systems, either of the procedures described in paragraphs (k)(1) and (2) of this section may be used:

(1) The owner or operator of an affected duct burner used in combined cycle systems shall determine compliance with the applicable NO_x emission limitation in §60.44Da(d)(1) or (e)(1) as follows:

(i) The emission rate (E) of NO_x shall be computed using Equation 1 of this section:

$$E = [(C_{sg} \times Q_{sg}) - (C_{te} \times Q_{te})] / (O_{sg} \times h) \text{ (Eq. 1)}$$

Where:

E = emission rate of NO_x from the duct burner, ng/J (lb/Mwh) gross output

C_{sg} = average hourly concentration of NO_x exiting the steam generating unit, ng/dscm (lb/dscf)

C_{te} = average hourly concentration of NO_x in the turbine exhaust upstream from duct burner, ng/dscm (lb/dscf)

Q_{sg} = average hourly volumetric flow rate of exhaust gas from steam generating unit, dscm/hr (dscf/hr)

Q_{te} = average hourly volumetric flow rate of exhaust gas from combustion turbine, dscm/hr (dscf/hr)

O_{sg} = average hourly gross energy output from steam generating unit, J (Mwh)

h = average hourly fraction of the total heat input to the steam generating unit derived from the combustion of fuel in the affected duct burner

(ii) Method 7E of appendix A of this part shall be used to determine the NO_x concentrations (C_{sg} and C_{te}). Method 2, 2F or 2G of appendix A of this part, as appropriate, shall be used to determine the volumetric flow rates (Q_{sg} and Q_{te}) of the exhaust gases. The volumetric flow rate measurements shall be taken at the same time as the concentration measurements.

(iii) The owner or operator shall develop, demonstrate, and provide information satisfactory to the Administrator to determine the average hourly gross energy output from the steam generating unit, and the average hourly percentage of the total heat input to the steam generating unit derived from the combustion of fuel in the affected duct burner.

(iv) Compliance with the applicable NO_x emission limitation in §60.44Da(d)(1) or (e)(1) is determined by the three-run average (nominal 1-hour runs) for the initial and subsequent performance tests.

(2) The owner or operator of an affected duct burner used in a combined cycle system may elect to determine compliance with the applicable NO_x emission limitation in §60.44Da(d)(1) or (e)(1) on a 30-day rolling average basis as indicated in paragraphs (k)(2)(i) through (iv) of this section.

(i) The emission rate (E) of NO_x shall be computed using Equation 2 of this section:

SECTION IV. APPENDIX Da

NSPS SUBPART Da REQUIREMENTS FOR STEAM GENERATING UNITS

$$E = (Csg \times Qsd) / Occ \text{ (Eq. 2)}$$

Where:

E = emission rate of NOX from the duct burner, ng/J (lb/Mwh) gross output

Csg = average hourly concentration of NOX exiting the steam generating unit, ng/dscm (lb/dscf)

Qsg = average hourly volumetric flow rate of exhaust gas from steam generating unit, dscm/hr (dscf/hr)

Occ = average hourly gross energy output from entire combined cycle unit, J (Mwh)

(ii) The continuous emissions monitoring system specified under §60.49Da for measuring NOX and oxygen shall be used to determine the average hourly NOX concentrations (Csg). The continuous flow monitoring system specified in §60.49Da(l) shall be used to determine the volumetric flow rate (Qsg) of the exhaust gas. The sampling site shall be located at the outlet from the steam generating unit. Data from a continuous flow monitoring system certified (or recertified) following procedures specified in 40 CFR 75.20, meeting the quality assurance and quality control requirements of 40 CFR 75.21, and validated according to 40 CFR 75.23 may be used.

(iii) The continuous monitoring system specified under §60.49Da(k) for measuring and determining gross energy output shall be used to determine the average hourly gross energy output from the entire combined cycle unit (Occ), which is the combined output from the combustion turbine and the steam generating unit.

(iv) The owner or operator may, in lieu of installing, operating, and recording data from the continuous flow monitoring system specified in §60.49Da(l), determine the mass rate (lb/hr) of NOX emissions by installing, operating, and maintaining continuous fuel flowmeters following the appropriate measurements procedures specified in appendix D of 40 CFR part 75. If this compliance option is selected, the emission rate (E) of NOX shall be computed using Equation 3 of this section:

$$E = (ERsg \times Hcc) / Occ \text{ (Eq. 3)}$$

Where:

E = emission rate of NOX from the duct burner, ng/J (lb/Mwh) gross output

ERsg = average hourly emission rate of NOX exiting the steam generating unit heat input calculated using appropriate F-factor as described in Method 19, ng/J (lb/million Btu)

Hcc = average hourly heat input rate of entire combined cycle unit, J/hr (million Btu/hr)

Occ = average hourly gross energy output from entire combined cycle unit, J (Mwh)

(l) Compliance provisions for sources subject to §60.45Da. The owner or operator of an affected facility subject to §60.45Da (new sources constructed or reconstructed after January 30, 2004) shall calculate the Hg emission rate (lb/MWh) for each calendar month of the year, using hourly Hg concentrations measured according to the provisions of §60.49Da(p) in conjunction with hourly stack gas volumetric flow rates measured according to the provisions of §60.49Da(l) or (m), and hourly gross electrical outputs, determined according to the provisions in §60.49Da(k). Compliance with the applicable standard under §60.45a is determined on a 12-month rolling average basis.

(m) Compliance provisions for sources subject to §60.43Da(i)(1)(i) or (j)(1)(i). The owner or operator of an affected facility subject to §60.43Da(i)(1)(i) or (j)(1)(i) shall calculate SO2 emissions by multiplying the average hourly SO2 output concentration, measured according to the provisions of §60.49Da(b), by the average hourly flow rate, measured according to the provisions of §60.49Da(l), and divided by the average hourly gross energy output, measured according to the provisions of §60.49Da(k).

(n) Compliance provisions for sources subject to §60.42Da(c)(1). The owner or operator of an affected facility subject to §60.42Da(c)(1) shall calculate particulate matter emissions by multiplying the average hourly particulate matter output concentration, measured according to the provisions of §60.49Da(t), by the average hourly flow rate, measured according to the provisions of §60.49Da(l), and divided by the average hourly gross energy output, measured according to the provisions of §60.49Da(k). Compliance with the emission limit is determined by calculating the arithmetic average of the hourly emission rates computed for each boiler operating day.

(o) Compliance provisions for sources subject to §60.42Da(c)(2) or (d). Except as provided for in paragraph (p) of this section, the owner or operator of an affected facility for which construction, reconstruction, or modification commenced after February 28, 2005, shall demonstrate compliance with each applicable emission limit according to the requirements in paragraphs (o)(1) through (o)(5) of this section.

(1) Conduct an initial performance test according to the requirements in §60.50Da to demonstrate compliance by the applicable date specified in §60.8(a) and, thereafter, conduct the performance test annually, and

(2) An owner or operator must use opacity monitoring equipment as an indicator of continuous particulate matter control device performance and demonstrate compliance with §60.42Da(b). In addition, baseline parameters shall be established as the highest hourly opacity average measured during the performance test. If any hourly average opacity measurement is more than 110 percent of the baseline level, the owner or operator will conduct another performance test within 60 days to demonstrate compliance. A new baseline is established during each stack test. The new baseline shall not exceed the opacity limit specified in §60.42Da(b), and

SECTION IV. APPENDIX Da

NSPS SUBPART Da REQUIREMENTS FOR STEAM GENERATING UNITS

- (3) An owner or operator using an ESP to comply with the applicable emission limits shall use voltage and secondary current monitoring equipment to measure voltage and secondary current to the ESP. Baseline parameters shall be established as average rates measured during the performance test. If a 3-hour average voltage and secondary current average deviates more than 10 percent from the baseline level, the owner or operator will conduct another performance test within 60 days to demonstrate compliance. A new baseline is established during each stack test, and
- (4) An owner or operator using a fabric filter to comply with the applicable emission limits shall install, calibrate, maintain, and continuously operate a bag leak detection system according to paragraphs (o)(4)(i) through (viii) of this section.
- (i) Install and operate a bag leak detection system for each exhaust stack of the fabric filter.
 - (ii) Each bag leak detection system must be installed, operated, calibrated, and maintained in a manner consistent with the manufacturer's written specifications and recommendations and in accordance with the guidance provided in EPA-454/R-98-015, September 1997.
 - (iii) The bag leak detection system must be certified by the manufacturer to be capable of detecting particulate matter emissions at concentrations of 10 milligrams per actual cubic meter or less.
 - (iv) The bag leak detection system sensor must provide output of relative or absolute particulate matter loadings.
 - (v) The bag leak detection system must be equipped with a device to continuously record the output signal from the sensor.
 - (vi) The bag leak detection system must be equipped with an alarm system that will sound automatically when an increase in relative particulate matter emissions over a preset level is detected. The alarm must be located where it is easily heard by plant operating personnel. Corrective actions must be initiated within 1 hour of a bag leak detection system alarm. If the alarm is engaged for more than 5 percent of the total operating time on a 30-day rolling average, a performance test must be performed within 60 days to demonstrate compliance.
 - (vii) For positive pressure fabric filter systems that do not duct all compartments of cells to a common stack, a bag leak detection system must be installed in each baghouse compartment or cell.
 - (viii) Where multiple bag leak detectors are required, the system's instrumentation and alarm may be shared among detectors, and
- (5) An owner or operator of a modified affected source electing to meet the emission limitations in §60.42Da(d) shall determine the percent reduction in particulate matter by using the emission rate for particulate matter determined by the performance test conducted according to the requirements in paragraph (o)(1) of this section and the ash content on a mass basis of the fuel burned during each performance test run as determined by analysis of the fuel as fired.
- (p) As an alternative to meeting the compliance provisions specified in paragraph (o) of this section, an owner or operator may elect to install, certify, maintain, and operate a continuous emission monitoring system measuring particulate matter emissions discharged from the affected facility to the atmosphere and record the output of the system as specified in paragraphs (p)(1) through (p)(8) of this section.
- (1) The owner or operator shall submit a written notification to the Administrator of intent to demonstrate compliance with this subpart by using a continuous monitoring system measuring particulate matter. This notification shall be sent at least 30 calendar days before the initial startup of the monitor for compliance determination purposes. The owner or operator may discontinue operation of the monitor and instead return to demonstration of compliance with this subpart according to the requirements in paragraph (o) of this section by submitting written notification to the Administrator of such intent at least 30 calendar days before shutdown of the monitor for compliance determination purposes.
 - (2) Each continuous emission monitor shall be installed, certified, operated, and maintained according to the requirements in §60.49Da(v).
 - (3) The initial performance evaluation shall be completed no later than 180 days after the date of initial startup of the affected facility, as specified under §60.8 of subpart A of this part or within 180 days of the date of notification to the Administrator required under paragraph (p)(1) of this section, whichever is later.
 - (4) Compliance with the applicable emissions limit shall be determined based on the 24-hour daily (block) average of the hourly arithmetic average emissions concentrations using the continuous monitoring system outlet data. The 24-hour block arithmetic average emission concentration shall be calculated using EPA Reference Method 19, section 4.1.
 - (5) At a minimum, valid continuous monitoring system hourly averages shall be obtained for 90 percent of all operating hours on a 30-day rolling average.
 - (i) At least two data points per hour shall be used to calculate each 1-hour arithmetic average.
 - (ii) [Reserved]
 - (6) The 1-hour arithmetic averages required shall be expressed in ng/J, MMBtu/h, or lb/MWh and shall be used to calculate the boiler operating day daily arithmetic average emission concentrations. The 1-hour arithmetic averages shall be calculated using the data points required under §60.13(e)(2) of subpart A of this part.
 - (7) All valid continuous monitoring system data shall be used in calculating average emission concentrations even if the minimum continuous emission monitoring system data requirements of paragraph (j)(5) of this section are not met.

SECTION IV. APPENDIX Da

NSPS SUBPART Da REQUIREMENTS FOR STEAM GENERATING UNITS

(8) When particulate matter emissions data are not obtained because of continuous emission monitoring system breakdowns, repairs, calibration checks, and zero and span adjustments, emissions data shall be obtained by using other monitoring systems as approved by the Administrator or EPA Reference Method 19 to provide, as necessary, valid emissions data for a minimum of 90 percent of all operating hours per 30-day rolling average.

[44 FR 33613, June 11, 1979, as amended at 54 FR 6664, Feb. 14, 1989; 63 FR 49454, Sept. 16, 1998; 66 FR 18552, Apr. 10, 2001; 66 FR 31178, June 11, 2001. Redesignated and amended at 70 FR 28653, 28654, May 18, 2005, and further redesignated and amended at 70 FR 51268, Aug. 30, 2005; 71 FR 9878, Feb. 27, 2006]

§ 60.49Da Emission monitoring.

(a) Except as provided for in paragraphs (t) and (u) of this section, the owner or operator of an affected facility, shall install, calibrate, maintain, and operate a continuous monitoring system, and record the output of the system, for measuring the opacity of emissions discharged to the atmosphere, except where gaseous fuel is the only fuel combusted. If opacity interference due to water droplets exists in the stack (for example, from the use of an FGD system), the opacity is monitored upstream of the interference (at the inlet to the FGD system). If opacity interference is experienced at all locations (both at the inlet and outlet of the sulfur dioxide control system), alternate parameters indicative of the particulate matter control system's performance are monitored (subject to the approval of the Administrator).

(b) The owner or operator of an affected facility shall install, calibrate, maintain, and operate a continuous monitoring system, and record the output of the system, for measuring sulfur dioxide emissions, except where natural gas is the only fuel combusted, as follows:

(1) Sulfur dioxide emissions are monitored at both the inlet and outlet of the sulfur dioxide control device.

(2) For a facility that qualifies under the numerical limit provisions of §60.43Da(d), (i), (j), or (k) sulfur dioxide emissions are only monitored as discharged to the atmosphere.

(3) An "as fired" fuel monitoring system (upstream of coal pulverizers) meeting the requirements of Method 19 may be used to determine potential sulfur dioxide emissions in place of a continuous sulfur dioxide emission monitor at the inlet to the sulfur dioxide control device as required under paragraph (b)(1) of this section.

(c)(1) The owner or operator of an affected facility shall install, calibrate, maintain, and operate a continuous monitoring system, and record the output of the system, for measuring nitrogen oxides emissions discharged to the atmosphere: or

(2) If the owner or operator has installed a nitrogen oxides emission rate continuous emission monitoring system (CEMS) to meet the requirements of part 75 of this chapter and is continuing to meet the ongoing requirements of part 75 of this chapter, that CEMS may be used to meet the requirements of this section, except that the owner or operator shall also meet the requirements of §60.51Da. Data reported to meet the requirements of §60.51a shall not include data substituted using the missing data procedures in subpart D of part 75 of this chapter, nor shall the data have been bias adjusted according to the procedures of part 75 of this chapter.

(d) The owner or operator of an affected facility shall install, calibrate, maintain, and operate a continuous monitoring system, and record the output of the system, for measuring the oxygen or carbon dioxide content of the flue gases at each location where sulfur dioxide or nitrogen oxides emissions are monitored.

(e) The continuous monitoring systems under paragraphs (b), (c), and (d) of this section are operated and data recorded during all periods of operation of the affected facility including periods of startup, shutdown, malfunction or emergency conditions, except for continuous monitoring system breakdowns, repairs, calibration checks, and zero and span adjustments.

(f)(1) For units that began construction, reconstruction, or modification on or before February 28, 2005, the owner or operator shall obtain emission data for at least 18 hours in at least 22 out of 30 successive boiler operating days. If this minimum data requirement cannot be met with a continuous monitoring system, the owner or operator shall supplement emission data with other monitoring systems approved by the Administrator or the reference methods and procedures as described in paragraph (h) of this section.

(2) For units that began construction, reconstruction, or modification after February 28, 2005, the owner or operator shall obtain emission data for at least 90 percent of all operating hours for each 30 successive boiler operating days. If this minimum data requirement cannot be met with a continuous monitoring system, the owner or operator shall supplement emission data with other monitoring systems approved by the Administrator or the reference methods and procedures as described in paragraph (h) of this section.

(g) The 1-hour averages required under paragraph §60.13(h) are expressed in ng/J (lb/million Btu) heat input and used to calculate the average emission rates under §60.48Da. The 1-hour averages are calculated using the data points required under §60.13(b). At least two data points must be used to calculate the 1-hour averages.

(h) When it becomes necessary to supplement continuous monitoring system data to meet the minimum data requirements in paragraph (f) of this section, the owner or operator shall use the reference methods and procedures as specified in this paragraph. Acceptable alternative methods and procedures are given in paragraph (j) of this section.

(1) Method 6 shall be used to determine the SO₂ concentration at the same location as the SO₂ monitor. Samples shall be taken at 60-minute intervals. The sampling time and sample volume for each sample shall be at least 20 minutes and 0.020 dscm (0.71 dscf). Each sample represents a 1-hour average.

(2) Method 7 shall be used to determine the NO_x concentration at the same location as the NO_x monitor. Samples shall be taken at 30-minute intervals. The arithmetic average of two consecutive samples represents a 1-hour average.

SECTION IV. APPENDIX Da

NSPS SUBPART Da REQUIREMENTS FOR STEAM GENERATING UNITS

(3) The emission rate correction factor, integrated bag sampling and analysis procedure of Method 3B shall be used to determine the O₂ or CO₂ concentration at the same location as the O₂ or CO₂ monitor. Samples shall be taken for at least 30 minutes in each hour. Each sample represents a 1-hour average.

(4) The procedures in Method 19 shall be used to compute each 1-hour average concentration in ng/J (1b/million Btu) heat input.

(i) The owner or operator shall use methods and procedures in this paragraph to conduct monitoring system performance evaluations under §60.13(c) and calibration checks under §60.13(d). Acceptable alternative methods and procedures are given in paragraph (j) of this section.

(1) Methods 3B, 6, and 7 shall be used to determine O₂, SO₂, and NO_x concentrations, respectively.

(2) SO₂ or NO_x (NO), as applicable, shall be used for preparing the calibration gas mixtures (in N₂, as applicable) under Performance Specification 2 of appendix B of this part.

(3) For affected facilities burning only fossil fuel, the span value for a continuous monitoring system for measuring opacity is between 60 and 80 percent and for a continuous monitoring system measuring nitrogen oxides is determined as follows:

Fossil fuel	Span value for nitrogen oxides (ppm)
Gas	500
Liquid	500
Solid	1,000
Combination	$500(x+y)+1,000z$

where:

x is the fraction of total heat input derived from gaseous fossil fuel.

y is the fraction of total heat input derived from liquid fossil fuel, and

z is the fraction of total heat input derived from solid fossil fuel.

(4) All span values computed under paragraph (b)(3) of this section for burning combinations of fossil fuels are rounded to the nearest 500 ppm.

(5) For affected facilities burning fossil fuel, alone or in combination with non-fossil fuel, the span value of the sulfur dioxide continuous monitoring system at the inlet to the sulfur dioxide control device is 125 percent of the maximum estimated hourly potential emissions of the fuel fired, and the outlet of the sulfur dioxide control device is 50 percent of maximum estimated hourly potential emissions of the fuel fired.

(j) The owner or operator may use the following as alternatives to the reference methods and procedures specified in this section:

(1) For Method 6, Method 6A or 6B (whenever Methods 6 and 3 or 3B data are used) or 6C may be used. Each Method 6B sample obtained over 24 hours represents 24 1-hour averages. If Method 6A or 6B is used under paragraph (i) of this section, the conditions under §60.46(d)(1) apply; these conditions do not apply under paragraph (h) of this section.

(2) For Method 7, Method 7A, 7C, 7D, or 7E may be used. If Method 7C, 7D, or 7E is used, the sampling time for each run shall be 1 hour.

(3) For Method 3, Method 3A or 3B may be used if the sampling time is 1 hour.

(4) For Method 3B, Method 3A may be used.

(k) The procedures specified in paragraphs (k)(1) through (3) of this section shall be used to determine gross output for sources demonstrating compliance with the output-based standard under §60.44Da(d)(1).

(1) The owner or operator of an affected facility with electricity generation shall install, calibrate, maintain, and operate a wattmeter; measure gross electrical output in megawatt-hour on a continuous basis; and record the output of the monitor.

(2) The owner or operator of an affected facility with process steam generation shall install, calibrate, maintain, and operate meters for steam flow, temperature, and pressure; measure gross process steam output in joules per hour (or Btu per hour) on a continuous basis; and record the output of the monitor.

(3) For affected facilities generating process steam in combination with electrical generation, the gross energy output is determined from the gross electrical output measured in accordance with paragraph (k)(1) of this section plus 75 percent of the gross thermal output (measured relative to ISO conditions) of the process steam measured in accordance with paragraph (k)(2) of this section.

(l) The owner or operator of an affected facility demonstrating compliance with an output-based standard under §60.42Da, §60.43Da, §60.44Da, or §60.45Da shall install, certify, operate, and maintain a continuous flow monitoring system meeting the requirements of Performance Specification 6 of appendix B and procedure 1 of appendix F of this subpart, and record the output of the system, for measuring the flow of exhaust gases discharged to the atmosphere: or

(m) Alternatively, data from a continuous flow monitoring system certified according to the requirements of 40 CFR 75.20, meeting the applicable quality control and quality assurance requirements of 40 CFR 75.21, and validated according to 40 CFR 75.23, may be used.

SECTION IV. APPENDIX Da

NSPS SUBPART Da REQUIREMENTS FOR STEAM GENERATING UNITS

- (n) Gas-fired and oil-fired units. The owner or operator of an affected unit that qualifies as a gas-fired or oil-fired unit, as defined in 40 CFR 72.2, may use, as an alternative to the requirements specified in either paragraph (l) or (m) of this section, a fuel flow monitoring system certified and operated according to the requirements of appendix D of 40 CFR part 75.
- (o) The owner or operator of a duct burner, as described in §60.41Da, which is subject to the NOX standards of §60.44Da(a)(1), (d)(1), or (e)(1) is not required to install or operate a continuous emissions monitoring system to measure NOX emissions; a wattmeter to measure gross electrical output; meters to measure steam flow, temperature, and pressure; and a continuous flow monitoring system to measure the flow of exhaust gases discharged to the atmosphere.
- (p) The owner or operator of an affected facility demonstrating compliance with an Hg limit in §60.45Da shall install and operate a continuous emissions monitoring system (CEMS) to measure and record the concentration of Hg in the exhaust gases from each stack according to the requirements in paragraphs (p)(1) through (p)(3) of this section. Alternatively, for an affected facility that is also subject to the requirements of subpart I of part 75 of this chapter, the owner or operator may install, certify, maintain, operate and quality-assure the data from a Hg CEMS according to §75.10 of this chapter and appendices A and B to part 75 of this chapter, in lieu of following the procedures in paragraphs (p)(1) through (p)(3) of this section.
- (1) The owner or operator must install, operate, and maintain each CEMS according to Performance Specification 12A in appendix B to this part.
 - (2) The owner or operator must conduct a performance evaluation of each CEMS according to the requirements of §60.13 and Performance Specification 12A in appendix B to this part.
 - (3) The owner or operator must operate each CEMS according to the requirements in paragraphs (p)(3)(i) through (iv) of this section.
 - (i) As specified in §60.13(e)(2), each CEMS must complete a minimum of one cycle of operation (sampling, analyzing, and data recording) for each successive 15-minute period.
 - (ii) The owner or operator must reduce CEMS data as specified in §60.13(h).
 - (iii) The owner or operator shall use all valid data points collected during the hour to calculate the hourly average Hg concentration.
 - (iv) The owner or operator must record the results of each required certification and quality assurance test of the CEMS.
 - (4) Mercury CEMS data collection must conform to paragraphs (p)(4)(i) through (iv) of this section.
 - (i) For each calendar month in which the affected unit operates, valid hourly Hg concentration data, stack gas volumetric flow rate data, moisture data (if required), and electrical output data (i.e., valid data for all of these parameters) shall be obtained for at least 75 percent of the unit operating hours in the month.
 - (ii) Data reported to meet the requirements of this subpart shall not include hours of unit startup, shutdown, or malfunction. In addition, for an affected facility that is also subject to subpart I of part 75 of this chapter, data reported to meet the requirements of this subpart shall not include data substituted using the missing data procedures in subpart D of part 75 of this chapter, nor shall the data have been bias adjusted according to the procedures of part 75 of this chapter.
 - (iii) If valid data are obtained for less than 75 percent of the unit operating hours in a month, you must discard the data collected in that month and replace the data with the mean of the individual monthly emission rate values determined in the last 12 months. In the 12-month rolling average calculation, this substitute Hg emission rate shall be weighted according to the number of unit operating hours in the month for which the data capture requirement of §60.49Da(p)(4)(i) was not met.
 - (iv) Notwithstanding the requirements of paragraph (p)(4)(iii) of this section, if valid data are obtained for less than 75 percent of the unit operating hours in another month in that same 12-month rolling average cycle, discard the data collected in that month and replace the data with the highest individual monthly emission rate determined in the last 12 months. In the 12-month rolling average calculation, this substitute Hg emission rate shall be weighted according to the number of unit operating hours in the month for which the data capture requirement of §60.49Da(p)(4)(i) was not met.
- (q) As an alternative to the CEMS required in paragraph (p) of this section, the owner or operator may use a sorbent trap monitoring system (as defined in §72.2 of this chapter) to monitor Hg concentration, according to the procedures described in §75.15 of this chapter and appendix K to part 75 of this chapter.
- (r) For Hg CEMS that measure Hg concentration on a dry basis or for sorbent trap monitoring systems, the emissions data must be corrected for the stack gas moisture content. A certified continuous moisture monitoring system that meets the requirements of §75.11(b) of this chapter is acceptable for this purpose. Alternatively, the appropriate default moisture value, as specified in §75.11(b) or §75.12(b) of this chapter, may be used.
- (s) The owner or operator shall prepare and submit to the Administrator for approval a unit-specific monitoring plan for each monitoring system, at least 45 days before commencing certification testing of the monitoring systems. The owner or operator shall comply with the requirements in your plan. The plan must address the requirements in paragraphs (s)(1) through (6) of this section.
- (1) Installation of the CEMS sampling probe or other interface at a measurement location relative to each affected process unit such that the measurement is representative of the exhaust emissions (e.g., on or downstream of the last control device);

SECTION IV. APPENDIX Da

NSPS SUBPART Da REQUIREMENTS FOR STEAM GENERATING UNITS

- (2) Performance and equipment specifications for the sample interface, the pollutant concentration or parametric signal analyzer, and the data collection and reduction systems;
 - (3) Performance evaluation procedures and acceptance criteria (e.g., calibrations, relative accuracy test audits (RATA), etc.);
 - (4) Ongoing operation and maintenance procedures in accordance with the general requirements of §60.13(d) or part 75 of this chapter (as applicable);
 - (5) Ongoing data quality assurance procedures in accordance with the general requirements of §60.13 or part 75 of this chapter (as applicable); and
 - (6) Ongoing record keeping and reporting procedures in accordance with the requirements of this subpart.
- (t) The owner or operator of an affected facility demonstrating compliance with the output-based emissions limitation under §60.42Da(c)(1) shall install, certify, operate, and maintain a continuous monitoring system for measuring particulate matter emissions according to the requirements of paragraph (v) of this section. An owner or operator of an affected source demonstrating compliance with the input-based emission limitation under §60.42Da(c)(2) may install, certify, operate, and maintain a continuous monitoring system for measuring particulate matter emissions according to the requirements of paragraph (v) of this section in lieu of the requirements in §60.48Da(o).
- (u) An owner or operator of an affected source that meets the conditions in either paragraph (u)(1) or (2) of this section is exempted from the continuous opacity monitoring system requirements in paragraph (a) of this section and the monitoring requirements in §60.48Da(o).
- (1) A continuous monitoring system for measuring particulate matter emissions is used to demonstrate continuous compliance on a boiler operating day average with the emissions limitations under §60.42Da(a)(1) or §60.42Da(c)(2) and is installed, certified, operated, and maintained on the affected source according to the requirements of paragraph (v) of this section.
 - (2) The affected source burns only oil that contains no more than 0.15 weight percent sulfur or liquid or gaseous fuels that when combusted without sulfur dioxide emission control, have a sulfur dioxide emissions rate equal to or less than or equal to 65 ng/J (0.15 lb/MMBtu) heat input.
- (v) The owner or operator of an affected facility using a continuous emission monitoring system measuring particulate matter emissions to meet requirements of this subpart shall install, certify, operate, and maintain the continuous monitoring system as specified in paragraphs (v)(1) through (v)(3).
- (1) The owner or operator shall conduct a performance evaluation of the continuous monitoring system according to the applicable requirements of §60.13, Performance Specification 11 in appendix B of this part, and procedure 2 in appendix F of this part.
 - (2) During each relative accuracy test run of the continuous emission monitoring system required by Performance Specification 11 in appendix B of this part, particulate matter and oxygen (or carbon dioxide) data shall be collected concurrently (or within a 30-to 60-minute period) by both the continuous emission monitors and conducting performance tests using the following test methods.
 - (i) For particulate matter, EPA Reference Method 5, 5B, or 17 shall be used.
 - (ii) For oxygen (or carbon dioxide), EPA Reference Method 3, 3A, or 3B, as applicable shall be used.
 - (3) Quarterly accuracy determinations and daily calibration drift tests shall be performed in accordance with procedure 2 in appendix F of this part. Relative Response Audits must be performed annually and Response Correlation Audits must be performed every 3 years.

[44 FR 33613, June 11, 1979, as amended at 54 FR 6664, Feb. 14, 1989; 55 FR 5212, Feb. 14, 1990; 55 FR 18876, May 7, 1990; 63 FR 49454, Sept. 16, 1998; 65 FR 61752, Oct. 17, 2000; 66 FR 18553, Apr. 10, 2001. Redesignated and amended at 70 FR 28653, 28654, May 18, 2005, and further redesignated and amended at 70 FR 51268, Aug. 30, 2005; 71 FR 9880, Feb. 27, 2006]

§ 60.50Da Compliance determination procedures and methods.

- (a) In conducting the performance tests required in §60.8, the owner or operator shall use as reference methods and procedures the methods in appendix A of this part or the methods and procedures as specified in this section, except as provided in §60.8(b). Section 60.8(f) does not apply to this section for SO₂ and NO_x. Acceptable alternative methods are given in paragraph (e) of this section.
- (b) The owner or operator shall determine compliance with the particulate matter standards in §60.42Da as follows:
- (1) The dry basis F factor (O₂) procedures in Method 19 shall be used to compute the emission rate of particulate matter.
 - (2) For the particulate matter concentration, Method 5 shall be used at affected facilities without wet FGD systems and Method 5B shall be used after wet FGD systems.
 - (i) The sampling time and sample volume for each run shall be at least 120 minutes and 1.70 dscm (60 dscf). The probe and filter holder heating system in the sampling train may be set to provide an average gas temperature of no greater than 160 ±14 °C (320 ±25 °F).
 - (ii) For each particulate run, the emission rate correction factor, integrated or grab sampling and analysis procedures of Method 3B shall be used to determine the O₂ concentration. The O₂ sample shall be obtained simultaneously with, and at the same traverse points as, the particulate run. If the particulate run has more than 12 traverse points, the O₂ traverse points may be

SECTION IV. APPENDIX Da

NSPS SUBPART Da REQUIREMENTS FOR STEAM GENERATING UNITS

reduced to 12 provided that Method 1 is used to locate the 12 O₂ traverse points. If the grab sampling procedure is used, the O₂ concentration for the run shall be the arithmetic mean of the sample O₂ concentrations at all traverse points.

(3) Method 9 and the procedures in §60.11 shall be used to determine opacity.

(c) The owner or operator shall determine compliance with the SO₂ standards in §60.43Da as follows:

(1) The percent of potential SO₂ emissions (%Ps) to the atmosphere shall be computed using the following equation:

$$\%Ps = [(100 - \%Rf)(100 - \%Rg)] / 100$$

where:

%Ps = percent of potential SO₂ emissions, percent.

%Rf = percent reduction from fuel pretreatment, percent.

%Rg = percent reduction by SO₂ control system, percent.

(2) The procedures in Method 19 may be used to determine percent reduction (%Rf) of sulfur by such processes as fuel pretreatment (physical coal cleaning, hydrodesulfurization of fuel oil, etc.), coal pulverizers, and bottom and flyash interactions. This determination is optional.

(3) The procedures in Method 19 shall be used to determine the percent SO₂ reduction (%Rg) of any SO₂ control system. Alternatively, a combination of an "as fired" fuel monitor and emission rates measured after the control system, following the procedures in Method 19, may be used if the percent reduction is calculated using the average emission rate from the SO₂ control device and the average SO₂ input rate from the "as fired" fuel analysis for 30 successive boiler operating days.

(4) The appropriate procedures in Method 19 shall be used to determine the emission rate.

(5) The continuous monitoring system in §60.49Da (b) and (d) shall be used to determine the concentrations of SO₂ and CO₂ or O₂.

(d) The owner or operator shall determine compliance with the NO_x standard in §60.44Da as follows:

(1) The appropriate procedures in Method 19 shall be used to determine the emission rate of NO_x.

(2) The continuous monitoring system in §60.49Da (c) and (d) shall be used to determine the concentrations of NO_x and CO₂ or O₂.

(e) The owner or operator may use the following as alternatives to the reference methods and procedures specified in this section:

(1) For Method 5 or 5B, Method 17 may be used at facilities with or without wet FGD systems if the stack temperature at the sampling location does not exceed an average temperature of 160 °C (320 °F). The procedures of §§2.1 and 2.3 of Method 5B may be used in Method 17 only if it is used after wet FGD systems. Method 17 shall not be used after wet FGD systems if the effluent is saturated or laden with water droplets.

(2) The Fc factor (CO₂) procedures in Method 19 may be used to compute the emission rate of particulate matter under the stipulations of §60.48(d)(1). The CO₂ shall be determined in the same manner as the O₂ concentration.

(f) Electric utility combined cycle gas turbines are performance tested for particulate matter, sulfur dioxide, and nitrogen oxides using the procedures of Method 19. The sulfur dioxide and nitrogen oxides emission rates from the gas turbine used in Method 19 calculations are determined when the gas turbine is performance tested under subpart GG. The potential uncontrolled particulate matter emission rate from a gas turbine is defined as 17 ng/J (0.04 lb/million Btu) heat input.

(g) For the purposes of determining compliance with the emission limits in §§60.45Da and 60.46Da, the owner or operator of an electric utility steam generating unit which is also a cogeneration unit shall use the procedures in paragraphs (g)(1) and (2) of this section to calculate emission rates based on electrical output to the grid plus half of the equivalent electrical energy in the unit's process stream.

(1) All conversions from Btu/hr unit input to MW unit output must use equivalents found in 40 CFR 60.40(a)(1) for electric utilities (i.e., 250 million Btu/hr input to an electric utility steam generating unit is equivalent to 73 MW input to the electric utility steam generating unit; 73 MW input to the electric utility steam generating unit is equivalent to 25 MW output from the boiler electric utility steam generating unit; therefore, 250 million Btu input to the electric utility steam generating unit is equivalent to 25 MW output from the electric utility steam generating unit).

(2) Use the Equation 1 of this section to determine the cogeneration Hg emission rate over a specific compliance period.

$$ER_{\text{cogen}} = \frac{M}{(V_{\text{grid}} + 0.75 \times V_{\text{process}})} \quad (\text{Eq. 1})$$

Where:

ER_{cogen} = Cogeneration Hg emission rate over a compliance period in lb/MWh;

E = Mass of Hg emitted from the stack over the same compliance period (lb);

V_{grid} = Amount of energy sent to the grid over the same compliance period (MWh); and

V_{process} = Amount of energy converted to steam for process use over the same compliance period (MWh).

SECTION IV. APPENDIX Da

NSPS SUBPART Da REQUIREMENTS FOR STEAM GENERATING UNITS

(h) The owner or operator shall determine compliance with the Hg limit in §60.45Da according to the procedures in paragraphs (h)(1) through (3) of this section.

(1) The initial performance test shall be commenced by the applicable date specified in §60.8(a). The required continuous monitoring systems must be certified prior to commencing the test. The performance test consists of collecting hourly Hg emission data (lb/MWh) with the continuous monitoring systems for 12 successive months of unit operation (excluding hours of unit startup, shutdown and malfunction). The average Hg emission rate is calculated for each month, and then the weighted, 12-month average Hg emission rate is calculated according to paragraph (h)(2) or (h)(3) of this section, as applicable. If, for any month in the initial performance test, the minimum data capture requirement in §60.49Da(p)(4)(i) is not met, the owner or operator shall report a substitute Hg emission rate for that month, as follows. For the first such month, the substitute monthly Hg emission rate shall be the arithmetic average of all valid hourly Hg emission rates recorded to date. For any subsequent month(s) with insufficient data capture, the substitute monthly Hg emission rate shall be the highest valid hourly Hg emission rate recorded to date. When the 12-month average Hg emission rate for the initial performance test is calculated, for each month in which there was insufficient data capture, the substitute monthly Hg emission rate shall be weighted according to the number of unit operating hours in that month. Following the initial performance test, the owner or operator shall demonstrate compliance by calculating the weighted average of all monthly Hg emission rates (in lb/MWh) for each 12 successive calendar months, excluding data obtained during startup, shutdown, or malfunction.

(2) If a CEMS is used to demonstrate compliance, follow the procedures in paragraphs (h)(2)(i) through (iii) of this section to determine the 12-month rolling average.

(i) Calculate the total mass of Hg emissions over a month (M), in pounds (lb), using either Equation 2 in paragraph (h)(2)(i)(A) of this section or Equation 3 in paragraph (h)(2)(i)(B) of this section, in conjunction with Equation 4 in paragraph (h)(2)(i)(C) of this section.

(A) If the Hg CEMS measures Hg concentration on a wet basis, use Equation 2 below to calculate the Hg mass emissions for each valid hour:

$$E_k = K C_k Q_k t_k \quad (\text{Eq. 2})$$

Where:

E_h = Hg mass emissions for the hour, (lb)

K = Units conversion constant, 6.24 × 10⁻¹¹ lb-scm/μg-scf

C_h = Hourly Hg concentration, wet basis, (μg/scm)

Q_h = Hourly stack gas volumetric flow rate, (scfh)

t_h = Unit operating time, i.e., the fraction of the hour for which the unit operated. For example, t_h = 0.50 for a half-hour of unit operation and 1.00 for a full hour of operation.

(B) If the Hg CEMS measures Hg concentration on a dry basis, use Equation 3 below to calculate the Hg mass emissions for each valid hour:

$$E_k = K C_k Q_k t_k (1 - B_{ws}) \quad (\text{Eq. 3})$$

Where:

E_h = Hg mass emissions for the hour, (lb)

K = Units conversion constant, 6.24 × 10⁻¹¹ lb-scm/μg-scf

C_h = Hourly Hg concentration, dry basis, (μg/dscm)

Q_h = Hourly stack gas volumetric flow rate, (scfh)

t_h = Unit operating time, i.e., the fraction of the hour for which the unit operated

B_{ws} = Stack gas moisture content, expressed as a decimal fraction (e.g., for 8 percent H₂O, B_{ws} = 0.08)

(C) Use Equation 4, below, to calculate M, the total mass of Hg emitted for the month, by summing the hourly masses derived from Equation 2 or 3 (as applicable):

$$M = \sum_{k=1}^n E_k \quad (\text{Eq. 4})$$

Where:

M = Total Hg mass emissions for the month, (lb)

E_h = Hg mass emissions for hour "h", from Equation 2 or 3 of this section, (lb)

SECTION IV. APPENDIX Da

NSPS SUBPART Da REQUIREMENTS FOR STEAM GENERATING UNITS

n = The number of unit operating hours in the month with valid CEM and electrical output data, excluding hours of unit startup, shutdown and malfunction

(ii) Calculate the monthly Hg emission rate on an output basis (lb/MWh) using Equation 5, below. For a cogeneration unit, use Equation 1 in paragraph (g) of this section instead.

ER = M/P (Eq. 5)

Where:

ER = Monthly Hg emission rate. (lb/MWh)

M = Total mass of Hg emissions for the month, from Equation 4, above. (lb)

P = Total electrical output for the month, for the hours used to calculate M. (MWh)

(iii) Until 12 monthly Hg emission rates have been accumulated, calculate and report only the monthly averages. Then, for each subsequent calendar month, use Equation 6 below to calculate the 12-month rolling average as a weighted average of the Hg emission rate for the current month and the Hg emission rates for the previous 11 months, with one exception. Calendar months in which the unit does not operate (zero unit operating hours) shall not be included in the 12-month rolling average.

Eavg = (sum of ERi * ni) / (sum of ni) (Eq. 6)

Where:

Eavg = Weighted 12-month rolling average Hg emission rate. (lb/MWh)

(ER)i = Monthly Hg emission rate, for month "i". (lb/MWh)

n = The number of unit operating hours in month "i" with valid CEM and electrical output data, excluding hours of unit startup, shutdown, and malfunction

(3) If a sorbent trap monitoring system is used in lieu of a Hg CEMS, as described in §75.15 of this chapter and in appendix K to part 75 of this chapter, calculate the monthly Hg emission rates using Equations 3 through 5 of this section, except that for a particular pair of sorbent traps, Ch in Equation 3 shall be the flow-proportional average Hg concentration measured over the data collection period.

(i) Daily calibration drift (CD) tests and quarterly accuracy determinations shall be performed for Hg CEMS in accordance with Procedure 1 of appendix F to this part. For the CD assessments, you may use either elemental mercury or mercuric chloride (Hg° or HgCl2) standards. The four quarterly accuracy determinations shall consist of one RATA and three measurement error (ME) tests using HgCl2 standards, as described in section 8.3 of Performance Specification 12-A in appendix B to this part (note: Hg° standards may be used if the Hg monitor does not have a converter). Alternatively, the owner or operator may implement the applicable daily, weekly, quarterly, and annual quality assurance (QA) requirements for Hg CEMS in appendix B to part 75 of this chapter, in lieu of the QA procedures in appendices B and F to this part. Annual RATA of sorbent trap monitoring systems shall be performed in accordance with appendices A and B to part 75 of this chapter, and all other quality assurance requirements specified in appendix K to part 75 of this chapter shall be met for sorbent trap monitoring systems.

[44 FR 33613, June 11, 1979, as amended at 54 FR 6664, Feb. 14, 1989; 55 FR 5212, Feb. 14, 1990; 65 FR 61752, Oct. 17, 2000. Redesignated and amended at 70 FR 28653, 28655, May 18, 2005, and further redesignated and amended at 70 FR 51268, Aug. 30, 2005; 71 FR 9881, Feb. 27, 2006]

Editorial Note: At 70 FR 51269, Aug. 30, 2005, the Environmental Protection Agency published a document in the Federal Register, attempting to amend §60.50Da. However, because of inaccurate amendatory language, this amendment could not be incorporated. For the convenience of the user, the language at 70 FR 51269 is set forth as follows:

f. Revising the existing reference in paragraph (e)(2) from "§60.48a(d)(1)" to "§60.48Da(d)(1)";

§ 60.51Da Reporting requirements.

(a) For sulfur dioxide, nitrogen oxides, particulate matter, and Hg emissions, the performance test data from the initial and subsequent performance test and from the performance evaluation of the continuous monitors (including the transmissometer) are submitted to the Administrator.

(b) For sulfur dioxide and nitrogen oxides the following information is reported to the Administrator for each 24-hour period.

(1) Calendar date.

SECTION IV. APPENDIX Da

NSPS SUBPART Da REQUIREMENTS FOR STEAM GENERATING UNITS

- (2) The average sulfur dioxide and nitrogen oxide emission rates (ng/J or lb/million Btu) for each 30 successive boiler operating days, ending with the last 30-day period in the quarter; reasons for non-compliance with the emission standards; and, description of corrective actions taken.
 - (3) Percent reduction of the potential combustion concentration of sulfur dioxide for each 30 successive boiler operating days, ending with the last 30-day period in the quarter; reasons for non-compliance with the standard; and, description of corrective actions taken.
 - (4) Identification of the boiler operating days for which pollutant or diluent data have not been obtained by an approved method for at least 18 hours of operation of the facility; justification for not obtaining sufficient data; and description of corrective actions taken.
 - (5) Identification of the times when emissions data have been excluded from the calculation of average emission rates because of startup, shutdown, malfunction (NOX only), emergency conditions (SO2 only), or other reasons, and justification for excluding data for reasons other than startup, shutdown, malfunction, or emergency conditions.
 - (6) Identification of "F" factor used for calculations, method of determination, and type of fuel combusted.
 - (7) Identification of times when hourly averages have been obtained based on manual sampling methods.
 - (8) Identification of the times when the pollutant concentration exceeded full span of the continuous monitoring system.
 - (9) Description of any modifications to the continuous monitoring system which could affect the ability of the continuous monitoring system to comply with Performance Specifications 2 or 3.
- (c) If the minimum quantity of emission data as required by §60.49Da is not obtained for any 30 successive boiler operating days, the following information obtained under the requirements of §60.48Da(h) is reported to the Administrator for that 30-day period:
- (1) The number of hourly averages available for outlet emission rates (no) and inlet emission rates (ni) as applicable.
 - (2) The standard deviation of hourly averages for outlet emission rates (so) and inlet emission rates (si) as applicable.
 - (3) The lower confidence limit for the mean outlet emission rate (Eo*) and the upper confidence limit for the mean inlet emission rate (Ei*) as applicable.
 - (4) The applicable potential combustion concentration.
 - (5) The ratio of the upper confidence limit for the mean outlet emission rate (Eo*) and the allowable emission rate (Estd) as applicable.
- (d) If any standards under §60.43Da are exceeded during emergency conditions because of control system malfunction, the owner or operator of the affected facility shall submit a signed statement:
- (1) Indicating if emergency conditions existed and requirements under §60.48Da(d) were met during each period, and
 - (2) Listing the following information:
 - (i) Time periods the emergency condition existed;
 - (ii) Electrical output and demand on the owner or operator's electric utility system and the affected facility;
 - (iii) Amount of power purchased from interconnected neighboring utility companies during the emergency period;
 - (iv) Percent reduction in emissions achieved;
 - (v) Atmospheric emission rate (ng/J) of the pollutant discharged; and
 - (vi) Actions taken to correct control system malfunction.
- (e) If fuel pretreatment credit toward the sulfur dioxide emission standard under §60.43Da is claimed, the owner or operator of the affected facility shall submit a signed statement:
- (1) Indicating what percentage cleaning credit was taken for the calendar quarter, and whether the credit was determined in accordance with the provisions of §60.50Da and Method 19 (appendix A); and
 - (2) Listing the quantity, heat content, and date each pretreated fuel shipment was received during the previous quarter; the name and location of the fuel pretreatment facility; and the total quantity and total heat content of all fuels received at the affected facility during the previous quarter.
- (f) For any periods for which opacity, sulfur dioxide or nitrogen oxides emissions data are not available, the owner or operator of the affected facility shall submit a signed statement indicating if any changes were made in operation of the emission control system during the period of data unavailability. Operations of the control system and affected facility during periods of data unavailability are to be compared with operation of the control system and affected facility before and following the period of data unavailability.
- (g) For Hg, the following information shall be reported to the Administrator:
- (1) Company name and address;
 - (2) Date of report and beginning and ending dates of the reporting period;
 - (3) The applicable Hg emission limit (lb/MWh); and

SECTION IV. APPENDIX Da

NSPS SUBPART Da REQUIREMENTS FOR STEAM GENERATING UNITS

(4) For each month in the reporting period:

- (i) The number of unit operating hours;
- (ii) The number of unit operating hours with valid data for Hg concentration, stack gas flow rate, moisture (if required), and electrical output;
- (iii) The monthly Hg emission rate (lb/MWh);
- (iv) The number of hours of valid data excluded from the calculation of the monthly Hg emission rate, due to unit startup, shutdown and malfunction; and
- (v) The 12-month rolling average Hg emission rate (lb/MWh); and

(5) The data assessment report (DAR) required by appendix F to this part, or an equivalent summary of QA test results if the QA of part 75 of this chapter are implemented.

(h) The owner or operator of the affected facility shall submit a signed statement indicating whether:

- (1) The required continuous monitoring system calibration, span, and drift checks or other periodic audits have or have not been performed as specified.
- (2) The data used to show compliance was or was not obtained in accordance with approved methods and procedures of this part and is representative of plant performance.
- (3) The minimum data requirements have or have not been met; or, the minimum data requirements have not been met for errors that were unavoidable.
- (4) Compliance with the standards has or has not been achieved during the reporting period.

(i) For the purposes of the reports required under §60.7, periods of excess emissions are defined as all 6-minute periods during which the average opacity exceeds the applicable opacity standards under §60.42Da(b). Opacity levels in excess of the applicable opacity standard and the date of such excesses are to be submitted to the Administrator each calendar quarter.

(j) The owner or operator of an affected facility shall submit the written reports required under this section and subpart A to the Administrator semiannually for each six-month period. All semiannual reports shall be postmarked by the 30th day following the end of each six-month period.

(k) The owner or operator of an affected facility may submit electronic quarterly reports for SO₂ and/or NO_x and/or opacity and/or Hg in lieu of submitting the written reports required under paragraphs (b), (g), and (i) of this section. The format of each quarterly electronic report shall be coordinated with the permitting authority. The electronic report(s) shall be submitted no later than 30 days after the end of the calendar quarter and shall be accompanied by a certification statement from the owner or operator, indicating whether compliance with the applicable emission standards and minimum data requirements of this subpart was achieved during the reporting period. Before submitting reports in the electronic format, the owner or operator shall coordinate with the permitting authority to obtain their agreement to submit reports in this alternative format.

[44 FR 33613, June 11, 1979, as amended at 63 FR 49454, Sept. 16, 1998; 64 FR 7464, Feb. 12, 1999. Redesignated and amended at 70 FR 28653, 28656, May 18, 2005, and further redesignated and amended at 70 FR 51268, Aug. 30, 2005]

§ 60.52Da Recordkeeping requirements.

The owner or operator of an affected facility subject to the emissions limitations in §60.45Da or §60.46Da shall provide notifications in accordance with §60.7(a) and shall maintain records of all information needed to demonstrate compliance including performance tests, monitoring data, fuel analyses, and calculations, consistent with the requirements of §60.7(f).

[70 FR 28656, May 18, 2005. Redesignated and amended at 70 FR 51268, Aug. 30, 2005]

SECTION IV. APPENDIX GC
GENERAL CONDITIONS

The permittee shall comply with the following general conditions from Rule 62-4.160, F.A.C.

1. The terms, conditions, requirements, limitations, and restrictions set forth in this permit are "Permit Conditions" and are binding and enforceable pursuant to Sections 403.161, 403.727, or 403.859 through 403.861, Florida Statutes. The permittee is placed on notice that the Department will review this permit periodically and may initiate enforcement action for any violation of these conditions.
2. This permit is valid only for the specific processes and operations applied for and indicated in the approved drawings or exhibits. Any unauthorized deviation from the approved drawings, exhibits, specifications, or conditions of this permit may constitute grounds for revocation and enforcement action by the Department.
3. As provided in Subsections 403.087(6) and 403.722(5), Florida Statutes, the issuance of this permit does not convey and vested rights or any exclusive privileges. Neither does it authorize any injury to public or private property or any invasion of personal rights, nor any infringement of federal, state or local laws or regulations. This permit is not a waiver or approval of any other Department permit that may be required for other aspects of the total project which are not addressed in the permit.
4. This permit conveys no title to land or water, does not constitute State recognition or acknowledgment of title, and does not constitute authority for the use of submerged lands unless herein provided and the necessary title or leasehold interests have been obtained from the State. Only the Trustees of the Internal Improvement Trust Fund may express State opinion as to title.
5. This permit does not relieve the permittee from liability for harm or injury to human health or welfare, animal, or plant life, or property caused by the construction or operation of this permitted source, or from penalties therefore; nor does it allow the permittee to cause pollution in contravention of Florida Statutes and Department rules, unless specifically authorized by an order from the Department.
6. The permittee shall properly operate and maintain the facility and systems of treatment and control (and related appurtenances) that are installed or used by the permittee to achieve compliance with the conditions of this permit, as required by Department rules. This provision includes the operation of backup or auxiliary facilities or similar systems when necessary to achieve compliance with the conditions of the permit and when required by Department rules.
7. The permittee, by accepting this permit, specifically agrees to allow authorized Department personnel, upon presentation of credentials or other documents as may be required by law and at a reasonable time, access to the premises, where the permitted activity is located or conducted to:
 - a. Have access to and copy and records that must be kept under the conditions of the permit;
 - b. Inspect the facility, equipment, practices, or operations regulated or required under this permit, and,
 - c. Sample or monitor any substances or parameters at any location reasonably necessary to assure compliance with this permit or Department rules.

Reasonable time may depend on the nature of the concern being investigated.

8. If, for any reason, the permittee does not comply with or will be unable to comply with any condition or limitation specified in this permit, the permittee shall immediately provide the Department with the following information:
 - a. A description of and cause of non-compliance; and
 - b. The period of noncompliance, including dates and times; or, if not corrected, the anticipated time the non-compliance is expected to continue, and steps being taken to reduce, eliminate, and prevent recurrence of the non-compliance.

The permittee shall be responsible for any and all damages which may result and may be subject to enforcement action by the Department for penalties or for revocation of this permit.

9. In accepting this permit, the permittee understands and agrees that all records, notes, monitoring data and other information relating to the construction or operation of this permitted source which are submitted to the Department may be used by the Department as evidence in any enforcement case involving the permitted source arising under the Florida Statutes or Department rules, except where such use is prescribed by Sections 403.73 and 403.111, Florida

SECTION IV. APPENDIX GC
GENERAL CONDITIONS

Statutes. Such evidence shall only be used to the extent it is consistent with the Florida Rules of Civil Procedure and appropriate evidentiary rules.

10. The permittee agrees to comply with changes in Department rules and Florida Statutes after a reasonable time for compliance, provided, however, the permittee does not waive any other rights granted by Florida Statutes or Department rules.
11. This permit is transferable only upon Department approval in accordance with Florida Administrative Code Rules 62-4.120 and 62-730.300, F.A.C., as applicable. The permittee shall be liable for any non-compliance of the permitted activity until the transfer is approved by the Department.
12. This permit or a copy thereof shall be kept at the work site of the permitted activity.
13. This permit also constitutes:
 - a. Determination of Best Available Control Technology (X);
 - b. Determination of Prevention of Significant Deterioration (X);
 - c. Compliance with National Emission Standards for Hazardous Air Pollutants (X); and
 - d. Compliance with New Source Performance Standards (X).
14. The permittee shall comply with the following:
 - a. Upon request, the permittee shall furnish all records and plans required under Department rules. During enforcement actions, the retention period for all records will be extended automatically unless otherwise stipulated by the Department.
 - b. The permittee shall hold at the facility or other location designated by this permit records of all monitoring information (including all calibration and maintenance records and all original strip chart recordings for continuous monitoring instrumentation) required by the permit, copies of all reports required by this permit, and records of all data used to complete the application or this permit. These materials shall be retained at least three years from the date of the sample, measurement, report, or application unless otherwise specified by Department rule.
 - c. Records of monitoring information shall include:
 - 1) The date, exact place, and time of sampling or measurements;
 - 2) The person responsible for performing the sampling or measurements;
 - 3) The dates analyses were performed;
 - 4) The person responsible for performing the analyses;
 - 5) The analytical techniques or methods used; and
 - 6) The results of such analyses.
15. When requested by the Department, the permittee shall within a reasonable time furnish any information required by law which is needed to determine compliance with the permit. If the permittee becomes aware that relevant facts were not submitted or were incorrect in the permit application or in any report to the Department, such facts or information shall be corrected promptly.

SECTION IV. APPENDIX GG
NSPS SUBPART GG REQUIREMENTS FOR GAS TURBINES

The Unit B combustion turbine may be subject to NSPS Subpart GG. The provisions of this Subpart may be provided in full upon request.

§ 60.330 Applicability and Designation of Affected Facility.

Each unit has a heat input at peak load equal to or greater than 10 MMBtu per hour (LHV) and will commence construction after October 3, 1977. Therefore, the gas turbines are subject to NSPS Subpart GG.

§ 60.331 Definitions.

The following applicable terms are defined by this subpart:

- (a) Stationary gas turbine means any simple cycle gas turbine, regenerative cycle gas turbine or any gas turbine portion of a combined cycle steam/electric generating system that is not self propelled. It may, however, be mounted on a vehicle for portability.
- (b) Simple cycle gas turbine means any stationary gas turbine which does not recover heat from the gas turbine exhaust gases to preheat the inlet combustion air to the gas turbine, or which does not recover heat from the gas turbine exhaust gases to heat water or generate steam.
- (d) Combined cycle gas turbine means any stationary gas turbine which recovers heat from the gas turbine exhaust gases to heat water or generate steam.
- (g) ISO standard day conditions mean 288 degrees Kelvin, 60 percent relative humidity and 101.3 kilopascals pressure.
- (h) Efficiency means the gas turbine manufacturer's rated heat rate at peak load in terms of heat input per unit of power output based on the lower heating value of the fuel.
- (i) Peak load means 100 percent of the manufacturer's design capacity of the gas turbine at ISO standard day conditions.
- (j) Base load means the load level at which a gas turbine is normally operated.
- (q) Electric utility stationary gas turbine means any stationary gas turbine constructed for the purpose of supplying more than one-third of its potential electric output capacity to any utility power distribution system for sale.

§ 60.332 Standard for Nitrogen Oxides.

In accordance with § 60.332(a)(1) and (b), emissions of nitrogen oxides (NO_x) from electric utility stationary gas turbines with a heat input at peak load greater than 100 MMBtu Btu per hour (LHV) shall not exceed the following standard.

$$\text{STD} = 0.0075 \frac{(14.4)}{Y} + F$$

Where:

STD = Allowable NO_x emissions (percent by volume at 15 percent oxygen and on a dry basis).

Y = Manufacturer's rated heat rate at manufacturer's rated load (kilojoules per watt hour) or, actual measured heat rate based on lower heating value of fuel as measured at actual peak load for the facility. The value of Y shall not exceed 14.4 kilojoules per watt-hour.

F = NO_x emission allowance for fuel-bound nitrogen as de-fined in paragraph (a)(3) of this section.

§ 60.332(a)(3) defines an allowable NO_x contribution based on the fuel bound nitrogen content. F. However, natural gas and distillate oil contain negligible concentrations of fuel bound nitrogen. Therefore, "F" shall be assumed to be 0. Based on the manufacturer's data and compressor inlet conditions of 59° F and 60% relative humidity, the heat rate for gas firing is 9250 Btu/KW-h at peak load and for oil firing is 9960 Btu/KW-h at peak load. This results in "Y" values of 9.8 for gas firing and 10.5 for oil firing. The equivalent NSPS NO_x emission standards are 110/103 ppmvd at 15% oxygen for gas/oil firing. Compliance with the NO_x standards of the PSD permit ensure compliance with the applicable NSPS standards. The permittee shall make the correction when required by the Department or Administrator.

SECTION IV. APPENDIX GG

NSPS SUBPART GG REQUIREMENTS FOR GAS TURBINES

§ 60.333 Standard for Sulfur Dioxide

In accordance with § 60.333(b), fuel fired in the gas turbines shall contain no more than 0.8% sulfur by weight. The conditions of the PSD permit limit allowable fuels to natural gas (≤ 2.0 grains of sulfur per 100 standard cubic feet of natural gas) and distillate oil ($\leq 0.05\%$ sulfur by weight). These conditions ensure compliance with the NSPS standard for sulfur dioxide.

§ 60.334 Monitoring of Operations.

The PSD permit requires keeping monthly records of the fuel sulfur content of natural gas. For distillate oil, the PSD permit requires initial fuel sulfur sampling and then keeping records of the fuel sulfur content based on vendor information "as supplied" for each subsequent shipment. Appropriate test methods are also specified in the PSD permit. These requirements constitute a custom fuel monitoring schedule that ensures compliance with the NSPS requirements for monitoring the nitrogen and sulfur contents of the fuels. The requirement to monitor the nitrogen contents of these fuels is waived due to negligible concentrations and the PSD conditions that require compliance with the NO_x standards to be demonstrated by CEMS. The CEMS shall be installed, operated, and maintained in accordance with the requirements of the PSD permit.

For the purpose of reports required under § 60.7(c), periods of excess emissions that shall be reported are: any 1-hour period of NO_x emissions greater than the NSPS standard; and any daily period during which the sulfur content of the fuel being fired in the gas turbine exceeds 0.8% sulfur by weight (for sulfur dioxide emissions). The permittee shall submit a semiannual report of emissions in excess of the NSPS standards.

§ 60.335 Test Methods and Procedures.

In accordance with § 60.335(c), compliance with the nitrogen oxides standards in § 60.332 shall be determined by computing the nitrogen oxides emission rate (NO_x) for each run using the following equation:

$$\text{NO}_x = (\text{NO}_{x0}) (\text{Pr}/\text{Po})^{0.5} e^{19(\text{Ho}-0.00633)} (288^\circ\text{K}/\text{Ta})^{1.53}$$

Where:

- NO_x = Emission rate of NO_x at 15 percent O_2 and ISO standard ambient conditions, volume percent
- NO_{x0} = Observed NO_x concentration, ppm by volume
- Pr = Reference combustor inlet absolute pressure at 101.3 kilopascals ambient pressure, mm Hg
- Po = Observed combustor inlet absolute pressure at test, mm Hg
- Ho = Observed humidity of ambient air, g $\text{H}_2\text{O}/\text{g}$ air
- e = Transcendental constant, 2.718
- Ta = Ambient temperature, $^\circ\text{K}$

Tests for nitrogen oxides emissions shall be conducted in accordance with the schedule and methods specified in the PSD permit. The permittee is allowed to conduct initial performance tests at a single load because a NO_x monitor shall be used to demonstrate compliance with the specified NO_x limits. The permittee is allowed to make the initial compliance demonstration for NO_x emissions using certified CEMS data, provided that compliance is based on a minimum of three test runs representing a total of at least three hours of data, and that the CEMS be calibrated in accordance with the procedure in section 6.2.3 of Method 20 following each run. Alternatively, initial compliance may be demonstrated using data collected during the initial relative accuracy test audit (RATA) performed on the NO_x monitor. The permittee is not required to have the NO_x monitor continuously correct NO_x emissions concentrations to ISO conditions. However, the permittee shall make the correction when required by the Department or Administrator.

The permittee shall use the methods specified in the PSD permit to demonstrate compliance with the fuel sulfur specification, which will ensure compliance with the NSPS standard.

SECTION IV. APPENDIX KKKK

NSPS SUBPART KKKK REQUIREMENTS FOR STATIONARY COMBUSTION TURBINES

The proposed provisions of Subpart KKKK apply to stationary gas turbines constructed after February 18, 2005. Once Subpart KKKK is finalized, if Unit B burns less than 75 percent syngas on a 12-month rolling average, the CT/HRSG system will be subject to and must comply with the requirements of Subpart KKKK, and not Subparts GG and Da. The provisions of this Subpart may be provided in full upon request

Applicable requirements of Subpart KKKK are summarized below.

NSPS Subpart KKKK Requirements					
<i>Applicable When Firing < 75% Syngas (12-month rolling average)</i>					
Pollutant	Method of Operation*	Limit		Averaging Time	Method of Compliance
		ppm @ 15% O ₂	Lb/MWhr		
NO _x	CC	15	0.43	30-day Rolling	CEMS
	SC	15	0.043	4-hr Rolling	CEMS
SO ₂	All modes	0.06 lb/mmBtu		Daily Sampling	Fuel Records
		Or 0.90 lb/MWh		Three 1-hr Runs	Annual Test

Insert Proposed/Finalized NSPS KKKK Rule Summary

SECTION IV. APPENDIX SC
STANDARD CONDITIONS

Unless otherwise specified in the permit, the following conditions apply to all emissions units and activities at this facility.

EMISSIONS AND CONTROLS

1. Plant Operation - Problems: If temporarily unable to comply with any of the conditions of the permit due to breakdown of equipment or destruction by fire, wind or other cause, the permittee shall notify each Compliance Authority as soon as possible, but at least within one working day, excluding weekends and holidays. The notification shall include: pertinent information as to the cause of the problem; steps being taken to correct the problem and prevent future recurrence; and, where applicable, the owner's intent toward reconstruction of destroyed facilities. Such notification does not release the permittee from any liability for failure to comply with the conditions of this permit or the regulations. [Rule 62-4.130, F.A.C.]
2. Circumvention: The permittee shall not circumvent the air pollution control equipment or allow the emission of air pollutants without this equipment operating properly. [Rule 62-210.650, F.A.C.]
3. Excess Emissions Allowed: Excess emissions resulting from startup, shutdown or malfunction of any emissions unit shall be permitted providing (1) best operational practices to minimize emissions are adhered to and (2) the duration of excess emissions shall be minimized but in no case exceed two hours in any 24 hour period unless specifically authorized by the Department for longer duration. [Rule 62-210.700(1), F.A.C.]
4. Excess Emissions Prohibited: Excess emissions caused entirely or in part by poor maintenance, poor operation, or any other equipment or process failure that may reasonably be prevented during startup, shutdown or malfunction shall be prohibited. [Rule 62-210.700(4), F.A.C.]
5. Excess Emissions - Notification: In case of excess emissions resulting from malfunctions, the permittee shall notify the Department or the appropriate Local Program in accordance with Rule 62-4.130, F.A.C. A full written report on the malfunctions shall be submitted in a quarterly report, if requested by the Department. [Rule 62-210.700(6), F.A.C.]
6. VOC or OS Emissions: No person shall store, pump, handle, process, load, unload or use in any process or installation, volatile organic compounds or organic solvents without applying known and existing vapor emission control devices or systems deemed necessary and ordered by the Department. [Rule 62-296.320(1), F.A.C.]
7. Objectionable Odor Prohibited: No person shall cause, suffer, allow or permit the discharge of air pollutants, which cause or contribute to an objectionable odor. An "objectionable odor" means any odor present in the outdoor atmosphere which by itself or in combination with other odors, is or may be harmful or injurious to human health or welfare, which unreasonably interferes with the comfortable use and enjoyment of life or property, or which creates a nuisance. [Rules 62-296.320(2) and 62-210.200(203), F.A.C.]
8. General Visible Emissions: No person shall cause, let, permit, suffer or allow to be discharged into the atmosphere the emissions of air pollutants from any activity equal to or greater than 20 percent opacity. [Rule 62-296.320(4)(b)], F.A.C.]
9. Unconfined Particulate Emissions: During the construction period, unconfined particulate matter emissions shall be minimized by dust suppressing techniques such as covering and/or application of water or chemicals to the affected areas, as necessary. [Rule 62-296.320(4)(c), F.A.C.]

TESTING REQUIREMENTS

10. Required Number of Test Runs: For mass emission limitations, a compliance test shall consist of three complete and separate determinations of the total air pollutant emission rate through the test section of the stack or duct and three complete and separate determinations of any applicable process variables corresponding to the three distinct time periods during which the stack emission rate was measured; provided, however, that three complete and separate determinations shall not be required if the process variables are not subject to variation during a compliance test, or if three determinations are not necessary in order to calculate the unit's emission rate. The three required test runs shall be completed within one consecutive five-day period. In the event that a sample is lost or one of the three runs must be discontinued because of circumstances beyond the control of the owner or operator, and a valid third run cannot be obtained within the five-day period allowed for the test, the Secretary or his or her designee may accept the results of two complete runs as proof of compliance, provided that the arithmetic mean of the two complete runs is at least 20% below the allowable emission limiting standard. [Rule 62-297.310(1), F.A.C.]

SECTION IV. APPENDIX SC
STANDARD CONDITIONS

11. Operating Rate During Testing: Testing of emissions shall be conducted with the emissions unit operating at permitted capacity. Permitted capacity is defined as 90 to 100 percent of the maximum operation rate allowed by the permit. If it is impractical to test at permitted capacity, an emissions unit may be tested at less than the maximum permitted capacity; in this case, subsequent emissions unit operation is limited to 110 percent of the test rate until a new test is conducted. Once the unit is so limited, operation at higher capacities is allowed for no more than 15 consecutive days for the purpose of additional compliance testing to regain the authority to operate at the permitted capacity. [Rule 62-297.310(2), F.A.C.]
12. Calculation of Emission Rate: For each emissions performance test, the indicated emission rate or concentration shall be the arithmetic average of the emission rate or concentration determined by each of the three separate test runs unless otherwise specified in a particular test method or applicable rule. [Rule 62-297.310(3), F.A.C.]
13. Test Procedures: Tests shall be conducted in accordance with all applicable requirements of Chapter 62-297, F.A.C.
 - a. Required Sampling Time. Unless otherwise specified in the applicable rule, the required sampling time for each test run shall be no less than one hour and no greater than four hours, and the sampling time at each sampling point shall be of equal intervals of at least two minutes. The minimum observation period for a visible emissions compliance test shall be thirty (30) minutes. The observation period shall include the period during which the highest opacity can reasonably be expected to occur.
 - b. Minimum Sample Volume. Unless otherwise specified in the applicable rule or test method, the minimum sample volume per run shall be 25 dry standard cubic feet.
 - c. Calibration of Sampling Equipment. Calibration of the sampling train equipment shall be conducted in accordance with the schedule shown in Table 297.310-1, F.A.C.
[Rule 62-297.310(4), F.A.C.]
14. Determination of Process Variables
 - a. Required Equipment. The owner or operator of an emissions unit for which compliance tests are required shall install, operate, and maintain equipment or instruments necessary to determine process variables, such as process weight input or heat input, when such data are needed in conjunction with emissions data to determine the compliance of the emissions unit with applicable emission limiting standards.
 - b. Accuracy of Equipment. Equipment or instruments used to directly or indirectly determine process variables, including devices such as belt scales, weight hoppers, flow meters, and tank scales, shall be calibrated and adjusted to indicate the true value of the parameter being measured with sufficient accuracy to allow the applicable process variable to be determined within 10% of its true value.
[Rule 62-297.310(5), F.A.C.]
15. Sampling Facilities: The permittee shall install permanent stack sampling ports and provide sampling facilities that meet the requirements of Rule 62-297.310(6), F.A.C.
16. Test Notification: The owner or operator shall notify the Department, at least 15 days prior to the date on which each formal compliance test is to begin, of the date, time, and place of each such test, and the test contact person who will be responsible for coordinating and having such test conducted for the owner or operator. [Rule 62-297.310(7)(a)9, F.A.C.]
17. Special Compliance Tests: When the Department, after investigation, has good reason (such as complaints, increased visible emissions or questionable maintenance of control equipment) to believe that any applicable emission standard contained in a Department rule or in a permit issued pursuant to those rules is being violated, it shall require the owner or operator of the emissions unit to conduct compliance tests which identify the nature and quantity of pollutant emissions from the emissions unit and to provide a report on the results of said tests to the Department. [Rule 62-297.310(7)(b), F.A.C.]
18. Test Reports: The owner or operator of an emissions unit for which a compliance test is required shall file a report with the Department on the results of each such test. The required test report shall be filed with the Department as soon as practical but no later than 45 days after the last sampling run of each test is completed. The test report shall provide

SECTION IV. APPENDIX SC
STANDARD CONDITIONS

sufficient detail on the emissions unit tested and the test procedures used to allow the Department to determine if the test was properly conducted and the test results properly computed. As a minimum, the test report, other than for an EPA or DEP Method 9 test, shall provide the following information:

- 1) The type, location, and designation of the emissions unit tested.
- 2) The facility at which the emissions unit is located.
- 3) The owner or operator of the emissions unit.
- 4) The normal type and amount of fuels used and materials processed, and the types and amounts of fuels used and material processed during each test run.
- 5) The means, raw data and computations used to determine the amount of fuels used and materials processed, if necessary to determine compliance with an applicable emission limiting standard.
- 6) The type of air pollution control devices installed on the emissions unit, their general condition, their normal operating parameters (pressure drops, total operating current and GPM scrubber water), and their operating parameters during each test run.
- 7) A sketch of the duct within 8 stack diameters upstream and 2 stack diameters downstream of the sampling ports, including the distance to any upstream and downstream bends or other flow disturbances.
- 8) The date, starting time and duration of each sampling run.
- 9) The test procedures used, including any alternative procedures authorized pursuant to Rule 62-297.620, F.A.C. Where optional procedures are authorized in this chapter, indicate which option was used.
- 10) The number of points sampled and configuration and location of the sampling plane.
- 11) For each sampling point for each run, the dry gas meter reading, velocity head, pressure drop across the stack, temperatures, average meter temperatures and sample time per point.
- 12) The type, manufacturer and configuration of the sampling equipment used.
- 13) Data related to the required calibration of the test equipment.
- 14) Data on the identification, processing and weights of all filters used.
- 15) Data on the types and amounts of any chemical solutions used.
- 16) Data on the amount of pollutant collected from each sampling probe, the filters, and the impingers, are reported separately for the compliance test.
- 17) The names of individuals who furnished the process variable data, conducted the test, analyzed the samples and prepared the report.
- 18) All measured and calculated data required to be determined by each applicable test procedure for each run.
- 19) The detailed calculations for one run that relate the collected data to the calculated emission rate.
- 20) The applicable emission standard, and the resulting maximum allowable emission rate for the emissions unit, plus the test result in the same form and unit of measure.
- 21) A certification that, to the knowledge of the owner or his authorized agent, all data submitted are true and correct. When a compliance test is conducted for the Department or its agent, the person who conducts the test shall provide the certification with respect to the test procedures used. The owner or his authorized agent shall certify that all data required and provided to the person conducting the test are true and correct to his knowledge.

[Rule 62-297.310(8), F.A.C.]

RECORDS AND REPORTS

19. Records Retention: All measurements, records, and other data required by this permit shall be documented in a permanent, legible format and retained for at least five (5) years following the date on which such measurements, records, or data are recorded. Records shall be made available to the Department upon request. [Rules 62-4.160(14) and 62-213.440(1)(b)2, F.A.C.]
20. Annual Operating Report: The permittee shall submit an annual report that summarizes the actual operating rates and emissions from this facility. Annual operating reports shall be submitted to the Compliance Authority by March 1st of each year. [Rule 62-210.370(2), F.A.C.]

SECTION IV. APPENDIX Y

NSPS SUBPART Y REQUIREMENTS FOR COAL PREPARATION PLANTS

The specific conditions of this subsection apply to the following emissions units.

ID	Emission Unit Description
033	Unit B Coal Mill and Coal Storage – including coal crushing, and crushed coal storage, coal pulverizing and feed preparation.
034	Unit B Gasification Ash Storage – including fly ash storage silo and baghouse.
035	Unit B Coal Handling – Including coal conveying and transfer.

1. NSPS Subpart A: The affected emissions units are also subject to the applicable General Provisions in Subpart A of 40 CFR 60, as adopted by Rule 62-204.800(8), F.A.C. [40 CFR 60, Subpart A]
2. NSPS Subpart Y: The affected emissions units are also subject to the applicable requirements for Coal Preparation Plants specified in NSPS Subpart Y of 40 CFR 60, as adopted by Rule 62-204.800(8), F.A.C. [40 CFR 60, Subpart Y]

{Permitting Note: Numbering of the original NSPS rules in the following conditions has been preserved for ease of reference with the rules. Paragraphs that are not applicable have been omitted for clarity and brevity. When used in 40 CFR 60, the term "Administrator" shall mean the Secretary or the Secretary's designee.}

§ 60.250 Applicability and Designation of Affected Facility.

(a) The provisions of this subpart are applicable to any of the following affected facilities in coal preparation plants which process more than 200 tons per day: thermal dryers, pneumatic coal cleaning equipment (air tables), coal processing and conveying equipment (including breakers and crushers), and coal storage systems.

§ 60.251 Definitions.

- (a) *Coal preparation plant* means any facility (excluding underground mining operations) which prepares coal by one or more of the following processes: breaking, crushing, screening, wet or dry cleaning, and thermal drying.
- (b) *Bituminous coal* means solid fossil fuel classified as bituminous coal by ASTM Designation D388-77, 90, 91, 95, or 98a (incorporated by reference; see § 60.17).
- (c) *Coal* means all solid fossil fuels classified as anthracite, bituminous, sub bituminous, or lignite by ASTM Designation D388-77, 90, 91, 95, or 98a (incorporated by reference; see § 60.17).
- (d) *Cyclonic flow* means a spiraling movement of exhaust gases within a duct or stack.
- (e) *Thermal dryer* means any facility in which the moisture content of bituminous coal is reduced by contact with a heated gas stream which is exhausted to the atmosphere.
- (f) *Pneumatic coal-cleaning equipment* means any facility which classifies bituminous coal by size or separates bituminous coal from refuse by application of air stream(s).
- (g) *Coal processing and conveying equipment* means any machinery used to reduce the size of coal or to separate coal from refuse, and the equipment used to convey coal to or remove coal and refuse from the machinery. This includes, but is not limited to, breakers, crushers, screens, and conveyor belts.
- (h) *Coal storage system* means any facility used to store coal except for open storage piles.
- (i) *Transfer and loading system* means any facility used to transfer and load coal for shipment.

§ 60.252 Standards for Particulate Matter.

(a) On and after the date on which the performance test required to be conducted by 40 CFR 60.8 is completed, an owner or operator shall not cause to be discharged into the atmosphere from any thermal dryer gases which:

- (1) Contain particulate matter in excess of 0.070 g/dscm (0.031 gr/dscf).
- (2) Exhibit 20 percent opacity or greater.

(c) On and after the date on which the performance test required to be conducted by 40 CFR 60.8 is completed, an owner or operator shall not cause to be discharged into the atmosphere from any coal processing and conveying equipment or coal storage system, gases which exhibit 20 percent opacity or greater. [40 CFR 60.252(a) and (c)].

§ 60.253 Monitoring of Operations.

(a) The owner or operator of any thermal dryer shall install, calibrate, maintain, and continuously operate monitoring devices as follows:

SECTION IV. APPENDIX YYYY

NESHAP SUBPART YYYY HAP STANDARDS FOR STATIONARY COMBUSTION TURBINES

The Unit B combustion turbine is subject to 40 CFR 63, Subpart YYYY, National Emissions Standard for Hazardous Air Pollutants for Stationary Combustion Gas Turbines

{Permitting Note: Numbering of the original NESHAP rules in the following conditions has been preserved for ease of reference. Paragraphs that are not applicable have been omitted for clarity and brevity.}

§ 63.6085 Am I subject to this subpart?

You are subject to this subpart if you own or operate a stationary combustion turbine located at a major source of HAP emissions.

(a) Stationary combustion turbine means all equipment, including but not limited to the turbine, the fuel, air, lubrication and exhaust gas systems, control systems (except emissions control equipment), and any ancillary components and sub-components comprising any simple cycle stationary combustion turbine, any regenerative/recuperative cycle stationary combustion turbine, the combustion turbine portion of any stationary cogeneration cycle combustion system, or the combustion turbine portion of any stationary combined cycle steam/electric generating system. Stationary means that the combustion turbine is not self propelled or intended to be propelled while performing its function, although it may be mounted on a vehicle for portability or transportability. Stationary combustion turbines covered by this subpart include simple cycle stationary combustion turbines, regenerative/recuperative cycle stationary combustion turbines, cogeneration cycle stationary combustion turbines, and combined cycle stationary combustion turbines. Stationary combustion turbines subject to this subpart do not include turbines located at a research or laboratory facility, if research is conducted on the turbine itself and the turbine is not being used to power other applications at the research or laboratory facility.

(b) A major source of HAP emissions is a contiguous site under common control that emits or has the potential to emit any single HAP at a rate of 10 tons (9.07 megagrams) or more per year or any combination of HAP at a rate of 25 tons (22.68 megagrams) or more per year, except that for oil and gas production facilities, a major source of HAP emissions is determined for each surface site.

§ 63.6090 What parts of my plant does this subpart cover?

This subpart applies to each affected source.

(a) Affected source. An affected source is any existing, new, or reconstructed stationary combustion turbine located at a major source of HAP emissions.

(2) New stationary combustion turbine. A stationary combustion turbine is new if you commenced construction of the stationary combustion turbine after January 14, 2003.

§ 63.6095 When do I have to comply with this subpart?

(c) You must meet the notification requirements in §63.6145 according to the schedule in §63.6145 and in 40 CFR part 63, subpart A.

(d) Stay of standards for gas-fired subcategories. If you start up a new or reconstructed stationary combustion turbine that is a lean premix gas-fired stationary combustion turbine or diffusion flame gas-fired stationary combustion turbine as defined by this subpart, you must comply with the Initial Notification requirements set forth in §63.6145 but need not comply with any other requirement of this subpart until EPA takes final action to require compliance and publishes a document in the Federal Register.

[69 FR 10537, Mar. 5, 2004, as amended at 69 FR 51188, Aug. 18, 2004]

Emission and Operating Limitations

§ 63.6100 What emission and operating limitations must I meet?

For each new or reconstructed stationary combustion turbine which is a lean premix gas-fired stationary combustion turbine, a lean premix oil-fired stationary combustion turbine, a diffusion flame gas-fired stationary combustion turbine, or a diffusion flame oil-fired stationary combustion turbine as defined by this subpart, you must comply with the emission limitations and operating limitations in Table 1 and Table 2 of this subpart.

General Compliance Requirements

§ 63.6105 What are my general requirements for complying with this subpart?

(a) You must be in compliance with the emission limitations and operating limitations which apply to you at all times except during startup, shutdown, and malfunctions.

(b) If you must comply with emission and operating limitations, you must operate and maintain your stationary combustion turbine, oxidation catalyst emission control device or other air pollution control equipment, and monitoring equipment in a manner consistent with good air pollution control practices for minimizing emissions at all times including during startup, shutdown, and malfunction.

Testing and Initial Compliance Requirements

§ 63.6110 By what date must I conduct the initial performance tests or other initial compliance demonstrations?

(a) You must conduct the initial performance tests or other initial compliance demonstrations in Table 4 of this subpart that apply to you within 180 calendar days after the compliance date that is specified for your stationary combustion turbine in §63.6095 and according to the provisions in §63.7(a)(2).

§ 63.6115 When must I conduct subsequent performance tests?

Subsequent performance tests must be performed on an annual basis as specified in Table 3 of this subpart.

SECTION IV. APPENDIX YYYY

NESHAP SUBPART YYYY HAP STANDARDS FOR STATIONARY COMBUSTION TURBINES

§ 63.6120 What performance tests and other procedures must I use?

- (a) You must conduct each performance test in Table 3 of this subpart that applies to you.
- (b) Each performance test must be conducted according to the requirements of the General Provisions at §63.7(e)(1) and under the specific conditions in Table 2 of this subpart.
- (c) Do not conduct performance tests or compliance evaluations during periods of startup, shutdown, or malfunction. Performance tests must be conducted at high load, defined as 100 percent plus or minus 10 percent.
- (d) You must conduct three separate test runs for each performance test, and each test run must last at least 1 hour.
- (e) If your stationary combustion turbine is not equipped with an oxidation catalyst, you must petition the Administrator for operating limitations that you will monitor to demonstrate compliance with the formaldehyde emission limitation in Table 1. You must measure these operating parameters during the initial performance test and continuously monitor thereafter. Alternatively, you may petition the Administrator for approval of no additional operating limitations. If you submit a petition under this section, you must not conduct the initial performance test until after the petition has been approved or disapproved by the Administrator.
- (f) If your stationary combustion turbine is not equipped with an oxidation catalyst and you petition the Administrator for approval of additional operating limitations to demonstrate compliance with the formaldehyde emission limitation in Table 1, your petition must include the following information described in paragraphs (f)(1) through (5) of this section.
 - (1) Identification of the specific parameters you propose to use as additional operating limitations;
 - (2) A discussion of the relationship between these parameters and HAP emissions, identifying how HAP emissions change with changes in these parameters and how limitations on these parameters will serve to limit HAP emissions;
 - (3) A discussion of how you will establish the upper and/or lower values for these parameters which will establish the limits on these parameters in the operating limitations;
 - (4) A discussion identifying the methods you will use to measure and the instruments you will use to monitor these parameters, as well as the relative accuracy and precision of these methods and instruments; and
 - (5) A discussion identifying the frequency and methods for recalibrating the instruments you will use for monitoring these parameters.
- (g) If you petition the Administrator for approval of no additional operating limitations, your petition must include the information described in paragraphs (g)(1) through (7) of this section.
 - (1) Identification of the parameters associated with operation of the stationary combustion turbine and any emission control device which could change intentionally (e.g., operator adjustment, automatic controller adjustment, etc.) or unintentionally (e.g., wear and tear, error, etc.) on a routine basis or over time;
 - (2) A discussion of the relationship, if any, between changes in the parameters and changes in HAP emissions;
 - (3) For the parameters which could change in such a way as to increase HAP emissions, a discussion of why establishing limitations on the parameters is not possible;
 - (4) For the parameters which could change in such a way as to increase HAP emissions, a discussion of why you could not establish upper and/or lower values for the parameters which would establish limits on the parameters as operating limitations;
 - (5) For the parameters which could change in such a way as to increase HAP emissions, a discussion identifying the methods you could use to measure them and the instruments you could use to monitor them, as well as the relative accuracy and precision of the methods and instruments;
 - (6) For the parameters, a discussion identifying the frequency and methods for recalibrating the instruments you could use to monitor them; and
 - (7) A discussion of why, from your point of view, it is infeasible, unreasonable or unnecessary to adopt the parameters as operating limitations.

§ 63.6125 What are my monitor installation, operation, and maintenance requirements?

- (a) If you are operating a stationary combustion turbine that is required to comply with the formaldehyde emission limitation and you use an oxidation catalyst emission control device, you must monitor on a continuous basis your catalyst inlet temperature in order to comply with the operating limitations in Table 2 and as specified in Table 5 of this subpart.
- (b) If you are operating a stationary combustion turbine that is required to comply with the formaldehyde emission limitation and you are not using an oxidation catalyst, you must continuously monitor any parameters specified in your approved petition to the Administrator, in order to comply with the operating limitations in Table 2 and as specified in Table 5 of this subpart.
- (d) If you are operating a lean premix gas-fired stationary combustion turbine or a diffusion flame gas-fired stationary combustion turbine as defined by this subpart, and you use any quantity of distillate oil to fire any new or existing stationary combustion turbine which is located at the same major source, you must monitor and record your distillate oil usage daily for all new and existing stationary combustion turbines located at the major source with a non-resettable hour meter to measure the number of hours that distillate oil is fired.

§ 63.6130 How do I demonstrate initial compliance with the emission and operating limitations?

SECTION IV. APPENDIX YYYY

NESHAP SUBPART YYYY HAP STANDARDS FOR STATIONARY COMBUSTION TURBINES

- (a) You must demonstrate initial compliance with each emission and operating limitation that applies to you according to Table 4 of this subpart.
- (b) You must submit the Notification of Compliance Status containing results of the initial compliance demonstration according to the requirements in §63.6145(f).

Continuous Compliance Requirements

§ 63.6135 How do I monitor and collect data to demonstrate continuous compliance?

- (a) Except for monitor malfunctions, associated repairs, and required quality assurance or quality control activities (including, as applicable, calibration checks and required zero and span adjustments of the monitoring system), you must conduct all parametric monitoring at all times the stationary combustion turbine is operating.
- (b) Do not use data recorded during monitor malfunctions, associated repairs, and required quality assurance or quality control activities for meeting the requirements of this subpart, including data averages and calculations. You must use all the data collected during all other periods in assessing the performance of the control device or in assessing emissions from the new or reconstructed stationary combustion turbine.

§ 63.6140 How do I demonstrate continuous compliance with the emission and operating limitations?

- (a) You must demonstrate continuous compliance with each emission limitation and operating limitation in Table 1 and Table 2 of this subpart according to methods specified in Table 5 of this subpart.
- (b) You must report each instance in which you did not meet each emission limitation or operating limitation. You must also report each instance in which you did not meet the requirements in Table 7 of this subpart that apply to you. These instances are deviations from the emission and operating limitations in this subpart. These deviations must be reported according to the requirements in §63.6150.
- (c) Consistent with §§63.6(e) and 63.7(c)(1), deviations that occur during a period of startup, shutdown, and malfunction are not violations if you have operated your stationary combustion turbine in accordance with §63.6(e)(1)(i).

[69 FR 10537, Mar. 5, 2004, as amended at 71 FR 20467, Apr. 20, 2006]

Notifications, Reports, and Records

§ 63.6145 What notifications must I submit and when?

- (a) You must submit all of the notifications in §§63.7(b) and (c), 63.8(e), 63.8(f)(4), and 63.9(b) and (h) that apply to you by the dates specified.
 - (c) As specified in §63.9(b), if you start up your new or reconstructed stationary combustion turbine on or after March 5, 2004, you must submit an Initial Notification not later than 120 calendar days after you become subject to this subpart.
- (d) If you are required to submit an Initial Notification but are otherwise not affected by the emission limitation requirements of this subpart, in accordance with §63.6090(b), your notification must include the information in §63.9(b)(2)(i) through (v) and a statement that your new or reconstructed stationary combustion turbine has no additional emission limitation requirements and must explain the basis of the exclusion (for example, that it operates exclusively as an emergency stationary combustion turbine).
- (e) If you are required to conduct an initial performance test, you must submit a notification of intent to conduct an initial performance test at least 60 calendar days before the initial performance test is scheduled to begin as required in §63.7(b)(1).
- (f) If you are required to comply with the emission limitation for formaldehyde, you must submit a Notification of Compliance Status according to §63.9(h)(2)(ii). For each performance test required to demonstrate compliance with the emission limitation for formaldehyde, you must submit the Notification of Compliance Status, including the performance test results, before the close of business on the 60th calendar day following the completion of the performance test.

§ 63.6150 What reports must I submit and when?

- (a) Anyone who owns or operates a stationary combustion turbine which must meet the emission limitation for formaldehyde must submit a semiannual compliance report according to Table 6 of this subpart. The semiannual compliance report must contain the information described in paragraphs (a)(1) through (a)(4) of this section. The semiannual compliance report must be submitted by the dates specified in paragraphs (b)(1) through (b)(5) of this section, unless the Administrator has approved a different schedule.
 - (1) Company name and address.
 - (2) Statement by a responsible official, with that official's name, title, and signature, certifying the accuracy of the content of the report.
 - (3) Date of report and beginning and ending dates of the reporting period.
 - (4) For each deviation from an emission limitation, the compliance report must contain the information in paragraphs (a)(4)(i) through (a)(4)(iii) of this section.
 - (i) The total operating time of each stationary combustion turbine during the reporting period.
 - (ii) Information on the number, duration, and cause of deviations (including unknown cause, if applicable), as applicable, and the corrective action taken.

SECTION IV. APPENDIX YYYY

NESHAP SUBPART YYYY HAP STANDARDS FOR STATIONARY COMBUSTION TURBINES

(iii) Information on the number, duration, and cause for monitor downtime incidents (including unknown cause, if applicable, other than downtime associated with zero and span and other daily calibration checks).

(b) Dates of submittal for the semiannual compliance report are provided in (b)(1) through (b)(5) of this section.

(1) The first semiannual compliance report must cover the period beginning on the compliance date specified in §63.6095 and ending on June 30 or December 31, whichever date is the first date following the end of the first calendar half after the compliance date specified in §63.6095.

(2) The first semiannual compliance report must be postmarked or delivered no later than July 31 or January 31, whichever date follows the end of the first calendar half after the compliance date that is specified in §63.6095.

(3) Each subsequent semiannual compliance report must cover the semiannual reporting period from January 1 through June 30 or the semiannual reporting period from July 1 through December 31.

(4) Each subsequent semiannual compliance report must be postmarked or delivered no later than July 31 or January 31, whichever date is the first date following the end of the semiannual reporting period.

(5) For each stationary combustion turbine that is subject to permitting regulations pursuant to 40 CFR part 70 or 71, and if the permitting authority has established the date for submitting annual reports pursuant to 40 CFR 70.6(a)(3)(iii)(A) or 40 CFR 71.6(a)(3)(iii)(A), you may submit the first and subsequent compliance reports according to the dates the permitting authority has established instead of according to the dates in paragraphs (b)(1) through (4) of this section.

(c) If you are operating as a stationary combustion turbine which fires landfill gas or digester gas equivalent to 10 percent or more of the gross heat input on an annual basis, or a stationary combustion turbine where gasified MSW is used to generate 10 percent or more of the gross heat input on an annual basis, you must submit an annual report according to Table 6 of this subpart by the date specified unless the Administrator has approved a different schedule, according to the information described in paragraphs (d)(1) through (5) of this section. You must report the data specified in (c)(1) through (c)(3) of this section.

(1) Fuel flow rate of each fuel and the heating values that were used in your calculations. You must also demonstrate that the percentage of heat input provided by landfill gas, digester gas, or gasified MSW is equivalent to 10 percent or more of the total fuel consumption on an annual basis.

(2) The operating limits provided in your federally enforceable permit, and any deviations from these limits.

(3) Any problems or errors suspected with the meters.

(d) Dates of submittal for the annual report are provided in (d)(1) through (d)(5) of this section.

(1) The first annual report must cover the period beginning on the compliance date specified in §63.6095 and ending on December 31.

(2) The first annual report must be postmarked or delivered no later than January 31.

(3) Each subsequent annual report must cover the annual reporting period from January 1 through December 31.

(4) Each subsequent annual report must be postmarked or delivered no later than January 31.

(5) For each stationary combustion turbine that is subject to permitting regulations pursuant to 40 CFR part 70 or 71, and if the permitting authority has established the date for submitting annual reports pursuant to 40 CFR 70.6(a)(3)(iii)(A) or 40 CFR 71.6(a)(3)(iii)(A), you may submit the first and subsequent compliance reports according to the dates the permitting authority has established instead of according to the dates in paragraphs (d)(1) through (4) of this section.

(e) If you are operating a lean premix gas-fired stationary combustion turbine or a diffusion flame gas-fired stationary combustion turbine as defined by this subpart, and you use any quantity of distillate oil to fire any new or existing stationary combustion turbine which is located at the same major source, you must submit an annual report according to Table 6 of this subpart by the date specified unless the Administrator has approved a different schedule, according to the information described in paragraphs (d)(1) through (5) of this section. You must report the data specified in (e)(1) through (e)(3) of this section.

(1) The number of hours distillate oil was fired by each new or existing stationary combustion turbine during the reporting period.

(2) The operating limits provided in your federally enforceable permit, and any deviations from these limits.

(3) Any problems or errors suspected with the meters.

§ 63.6155 What records must I keep?

(a) You must keep the records as described in paragraphs (a)(1) through (5).

(1) A copy of each notification and report that you submitted to comply with this subpart, including all documentation supporting any Initial Notification or Notification of Compliance Status that you submitted, according to the requirements in §63.10(b)(2)(xiv).

(2) Records of performance tests and performance evaluations as required in §63.10(b)(2)(viii).

(3) Records of the occurrence and duration of each startup, shutdown, or malfunction as required in §63.10(b)(2)(i).

(4) Records of the occurrence and duration of each malfunction of the air pollution control equipment, if applicable, as required in §63.10(b)(2)(ii).

(5) Records of all maintenance on the air pollution control equipment as required in §63.10(b)(iii).

SECTION IV. APPENDIX YYYY

NESHAP SUBPART YYYY HAP STANDARDS FOR STATIONARY COMBUSTION TURBINES

(b) If you are operating a stationary combustion turbine which fires landfill gas, digester gas or gasified MSW equivalent to 10 percent or more of the gross heat input on an annual basis, or if you are operating a lean premix gas-fired stationary combustion turbine or a diffusion flame gas-fired stationary combustion turbine as defined by this subpart, and you use any quantity of distillate oil to fire any new or existing stationary combustion turbine which is located at the same major source, you must keep the records of your daily fuel usage monitors.

(c) You must keep the records required in Table 5 of this subpart to show continuous compliance with each operating limitation that applies to you.

§ 63.6160 In what form and how long must I keep my records?

(a) You must maintain all applicable records in such a manner that they can be readily accessed and are suitable for inspection according to §63.10(b)(1).

(b) As specified in §63.10(b)(1), you must keep each record for 5 years following the date of each occurrence, measurement, maintenance, corrective action, report, or record.

(c) You must retain your records of the most recent 2 years on site or your records must be accessible on site. Your records of the remaining 3 years may be retained off site.

Table 1 to Subpart YYYY of Part 63—Emission Limitations

For each new or reconstructed stationary combustion turbine described in §63.6100 which is:	You must meet the following emission limitations:
1. a lean premix gas-fired stationary combustion turbine as defined in this subpart.	limit the concentration of formaldehyde to 91 ppbv or less at 15 percent O ₂ .
2. a lean premix oil-fired stationary combustion turbine as defined in this subpart.	
3. a diffusion flame gas-fired stationary combustion turbine as defined in this subpart, or	
4. a diffusion flame oil-fired stationary combustion turbine as defined in this subpart	

Table 2 to Subpart YYYY of Part 63—Operating Limitations

For:	You must:
1. each stationary combustion turbine that is required to comply with the emission limitation for formaldehyde and is using an oxidation catalyst.	maintain the 4-hour rolling average of the catalyst inlet temperature within the range suggested by the catalyst manufacturer.
2. each stationary combustion turbine that is required to comply with the emission limitation for formaldehyde and is not using an oxidation catalyst.	maintain any operating limitations approved by the Administrator.

Table 3 to Subpart YYYY of Part 63—Requirements for Performance Tests and Initial Compliance Demonstrations

You must:	Using:	According to the following requirements:
a. demonstrate formaldehyde emissions meet the emission limitations specified in Table 1 by a performance test initially and on annual basis AND.	Test Method 320 of 40 CFR part 63, appendix A; ASTM D6348-03 provided an that %R as determined in Annex A5 of ASTM D6348-03 is equal or greater than 70% and less than or equal to 130%; or other methods approved by the Administrator.	Formaldehyde concentration must be corrected to 15 percent O ₂ , dry basis. Results of this test consist of the average of the three 1 hour runs. Test must be conducted within 10 percent of 100 percent load.
b. select the sampling port location and the number of traverse points AND...	Method 1 or 1A of 40 CFR part 60, appendix A § 63.7(d)(1)(i).	if using an air pollution control device, the sampling site must be located at the outlet of the air pollution control device.
c. determine the O ₂ concentration at the sampling port location AND...	Method 3A or 3B of 40 CFR part 60, appendix A.	measurements to determine O ₂ concentration must be made at the same time as the performance test.
d. determine the moisture content at the sampling port location for the purposes of correcting the	Method 4 of 40 CFR part 60, appendix A or Test Method 320 of 40 CFR part 63, appendix A, or ASTM D6348-03.	measurements to determine moisture content must be made at the same time as the performance test.

SECTION IV. APPENDIX YYYY

NESHAP SUBPART YYYY HAP STANDARDS FOR STATIONARY COMBUSTION TURBINES

formaldehyde concentration to a dry basis.

Table 5 to Subpart YYYY of Part 63—Continuous Compliance With Operating Limitations

For each stationary combustion turbine complying with the emission limitation for formaldehyde	You must demonstrate continuous compliance by
1. with an oxidation catalyst	continuously monitoring the inlet temperature to the catalyst and maintaining the 4-hour rolling average of the inlet temperature within the range suggested by the catalyst manufacturer.
2. without the use of an oxidation catalyst	continuously monitoring the operating limitations that have been approved in your petition to the Administrator.

Table 6 to Subpart YYYY of Part 63—Requirements for Reports

If you own or operate a	you must	According to the following requirements
1. stationary combustion turbine which must comply with the formaldehyde emission limitation.	report your compliance status	semiannually, according to the requirements of § 63.6150.
2. stationary combustion turbine which fires landfill gas, digester gas or gasified MSW equivalent to 10 percent or more of the gross heat input on an annual basis	report (1) the fuel flow rate of each fuel and heating values that were used in your calculations, and you must demonstrate that the percentage of heat input provided by landfill gas, digester gas, or gasified MSW is equivalent to 10 percent or more of the gross heat input on an annual basis, (2) the operating limits provided in your federally enforceable permit, and any deviations from these limits, and (3) any problems or errors suspected with the meters.	annually, according to the requirements in § 63.6150.
3. a lean premix gas-fired stationary combustion turbine or a diffusion flame gas-fired stationary combustion turbine as defined by this subpart and you use any quantity of distillate oil to fire any new or existing stationary combustion turbine which is located at the same major source.	report (1) the number of hours distillate oil was fired by each new or existing stationary combustion turbine during the reporting period, (2) the operating limits provided in your federally enforceable permit, and any deviations from these limits, and (3) any problems or errors suspected with the meters.	annually, according to the requirements in § 63.6150