

Check Sheet

Company Name: Walt Disney World ~~Corporation~~ Company
Permit Number: AC98-108740, -741, -742, -743, -745
PSD Number: _____
Permit Engineer: _____

Application:

- | | |
|---|--------------------------|
| <input checked="" type="checkbox"/> Initial Application | Cross References: |
| <input type="checkbox"/> Incompleteness Letters | <input type="checkbox"/> |
| <input type="checkbox"/> Responses | <input type="checkbox"/> |
| <input type="checkbox"/> Waiver of Department Action | <input type="checkbox"/> |
| <input type="checkbox"/> Department Response | |
| <input type="checkbox"/> Other | |

Intent:

- Intent to Issue
 - Notice of Intent to Issue
 - Technical Evaluation
 - BACT or LAER Determination
 - Unsigned Permit
- Correspondence with:
- EPA
 - Park Services
 - Other
- Proof of Publication
 - Petitions - (Related to extensions, hearings, etc.)
 - Waiver of Department Action
 - Other

Final

Determination:

- Final Determination
- Signed Permit
- BACT or LAER Determination
- Other

Post Permit Correspondence:

- Extensions/Amendments/Modifications
- Other

PS Form 3811, July 1983

SENDER: Complete items 1, 2, 3 and 4.
 Put your address in the "RETURN TO" space on the reverse side. Failure to do this will prevent this card from being returned to you. The return receipt fee will provide you the name of the person delivered to and the date of delivery. For additional fees the following services are available. Consult postmaster for fees and check box(es) for service(s) requested.

1. Show to whom, date and address of delivery.
 2. Restricted Delivery.

3. Article Addressed to:
 Mr. Edward B. Crowell
 Walt Disney World Company, Inc.
 P. O. Box 40
 Lake Buena Vista, FL 32830

4. Type of Service: <input type="checkbox"/> Registered <input type="checkbox"/> Insured <input checked="" type="checkbox"/> Certified <input type="checkbox"/> COD <input type="checkbox"/> Express Mail	Article Number P 408 533 641
--	---------------------------------

Always obtain signature of addressee or agent and **DATE DELIVERED.**

5. Signature - Addressee
 X

6. Signature - Agent
 X *E. Crowell*

7. Date of Delivery

8. Addressee's Address (ONLY if requested and fee paid)

DOMESTIC RETURN RECEIPT

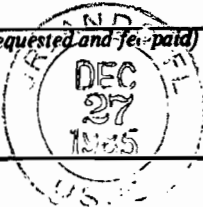

P 408 533 641

RECEIPT FOR CERTIFIED MAIL

NO INSURANCE COVERAGE PROVIDED—
 NOT FOR INTERNATIONAL MAIL

(See Reverse)

Sent to Mr. Edward B. Crowell	
Street and No.	
P.O., State and ZIP Code	
Postage	\$
Certified Fee	
Special Delivery Fee	
Restricted Delivery Fee	
Return Receipt Showing to whom and Date Delivered.	
Return Receipt Showing to whom, Date, and Address of Delivery	
TOTAL Postage and Fees	\$
Postmark or Date 12/24/85	

PS Form 3800, Feb. 1982

STATE OF FLORIDA
DEPARTMENT OF ENVIRONMENTAL REGULATION

TWIN TOWERS OFFICE BUILDING
2600 BLAIR STONE ROAD
TALLAHASSEE, FLORIDA 32301-8241

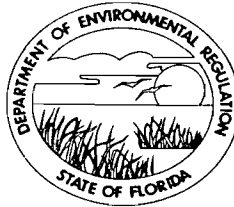

BOB GRAHAM
GOVERNOR

VICTORIA J. TSCHINKEL
SECRETARY

STATE OF FLORIDA
DEPARTMENT OF ENVIRONMENTAL REGULATION
NOTICE OF PERMIT

Mr. Edward B. Crowell
Vice President Facilities Division
Walt Disney World Company, Inc.
Post Office Box 40
Lake Buena Vista, Florida 32830

December 24, 1985

Enclosed are Permit Numbers AC 48-108740 and AC 48-108741, AC 48-108742, AC 48-108743, AC 48-108744, AC 48-108745, to Walt Disney World Company, Inc. which authorizes the construction of paint spray booths at your existing facility in Lake Buena Vista, Orange County, Florida. These permits are issued pursuant to Section 403, Florida Statutes.

Any Party to these permits has the right to seek judicial review of the permit pursuant to Section 120.68, Florida Statutes, by the filing of a Notice of Appeal pursuant to Rule 9.110, Florida Rules of Appellate Procedure, with the clerk of the Department in the Office of General Counsel, 2600 Blair Stone Road, Tallahassee, Florida 32301; and by filing a copy of the Notice of Appeal accompanied by the applicable filing fees with the appropriate District Court of Appeal. The Notice of Appeal must be filed within 30 days from the date this permit is filed with the clerk of the Department.

Sincerely,

for C. H. Fancy

C. H. Fancy, P.E.
Deputy Chief
Bureau of Air Quality
Management

Enclosure

cc: Ted W. McKim, P.E., Reedy Creek Utilities
Charles Collins, DER St. Johns River District

CERTIFICATION

This is to certify that the foregoing Notice of Permit and all copies requested were mailed before the close of business on Dec 24, 1985, 1985.

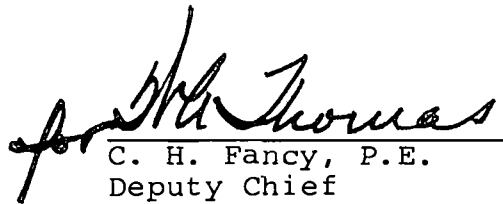
C. H. Fancy, P.E.
Deputy Chief
Bureau of Air Quality
Management
2600 Blair Stone Road
Tallahassee, Florida 32301

FILING AND ACKNOWLEDGEMENT
FILED, on this date, pursuant to
§120.52(9), Florida Statutes, with
the designated Department Clerk,
receipt of which is hereby
acknowledged.

Patricia B. Adams
Clerk

Dec. 24, 1985
Date

Final Determination

Walt Disney World Company, Inc.
Orange County
Lake Buena Vista, Florida

NSA Paint Shop Paint Booths 1, 2, 3; NSA Staff Shop
Spray Booths 1 and 2; Water Wash Plastisol Booth Number 1

Permit Numbers: AC 48-108740
48-108741
48-108742
48-108743
48-108744
48-108745

Florida Department of Environmental Regulation
Bureau of Air Quality Management
Central Air Permitting

December 17, 1985

Final Determination

Walt Disney World Company, Incorporated's applications for permits to construct three paint shop spray booths, two staff shop spray booths and a water wash plastisol spray booth at their facility in Lake Buena Vista, Orange County, Florida have been reviewed by the Bureau of Air Quality Management. Public Notice of the department's Intent to Issue the permit was published in the Orlando Sentinel on November 10, 1985.

Copies of the preliminary determination have been available for public inspection at the St. Johns River District office in Orlando and the Bureau of Air Quality Management office in Tallahassee.

There were no letters of response as a result of the public comment period.

The final action of the department will be to issue the permits to construct as noticed during the public notice period.

STATE OF FLORIDA
DEPARTMENT OF ENVIRONMENTAL REGULATION

TWIN TOWERS OFFICE BUILDING
2600 BLAIR STONE ROAD
TALLAHASSEE, FLORIDA 32301-8241



BOB GRAHAM
GOVERNOR

VICTORIA J. TSCHINKEL
SECRETARY

PERMITTEE: Permit Number: AC 48-108740
Walt Disney World Company, Inc. Expiration Date: April 1, 1986
Post Office Box 40 County: Orange
Lake Buena Vista, Florida 32830 Latitude/Longitude: 28° 25' 32"N/
81° 34' 36"W
Project: NSA Paint Spray Booth No. 1

This permit is issued under the provisions of Chapters 403, Florida Statutes, and Florida Administrative Code Rule(s) 17-2 and 17-4. The above named permittee is hereby authorized to perform the work or operate the facility shown on the application and approved drawings, plans, and other documents attached hereto or on file with the department and made a part hereof and specifically described as follows:

For the construction of a spray booth which will be used to coat a variety of objects including vehicles, wooden furniture, trash cans, ride components, posts and frames using two part polyurethane, two part acrylic, epoxy primers and other primer coating systems. The booth will be equipped with two Binks model 30-43-13 exhaust fans and Binks model 29-893 paint arrestor type filters.

Construction shall be in accordance with the attached permit application and additional information except as otherwise noted on pages 5 and 6, specific conditions.

Attachments are as follows:

1. Applications to construct an Air Pollution Source, DER form 17-1.202(1).

PERMITTEE:
Walt Disney World Company, Inc.

Permit Number: AC 48-108740
Expiration Date: April 1, 1986

GENERAL CONDITIONS:

1. The terms, conditions, requirements, limitations, and restrictions set forth herein are "Permit Conditions" and as such are binding upon the permittee and enforceable pursuant to the authority of Sections 403.161, 403.727, or 403.859 through 403.861, Florida Statutes. The permittee is hereby placed on notice that the department will review this permit periodically and may initiate enforcement action for any violation of the "Permit Conditions" by the permittee, its agents, employees, servants or representatives.
2. This permit is valid only for the specific processes and operations applied for and indicated in the approved drawings or exhibits. Any unauthorized deviation from the approved drawings, exhibits, specifications, or conditions of this permit may constitute grounds for revocation and enforcement action by the department.
3. As provided in Subsections 403.087(6) and 403.722(5), Florida Statutes, the issuance of this permit does not convey any vested rights or any exclusive privileges. Nor does it authorize any injury to public or private property or any invasion of personal rights, nor any infringement of federal, state or local laws or regulations. This permit does not constitute a waiver of or approval of any other department permit that may be required for other aspects of the total project which are not addressed in the permit.
4. This permit conveys no title to land or water, does not constitute state recognition or acknowledgement of title, and does not constitute authority for the use of submerged lands unless herein provided and the necessary title or leasehold interests have been obtained from the state. Only the Trustees of the Internal Improvement Trust Fund may express state opinion as to title.
5. This permit does not relieve the permittee from liability for harm or injury to human health or welfare, animal, plant or aquatic life or property and penalties therefore caused by the construction or operation of this permitted source, nor does it allow the permittee to cause pollution in contravention of Florida Statutes and department rules, unless specifically authorized by an order from the department.

PERMITTEE: Permit Number: AC 48-108740
Walt Disney World Company, Inc. Expiration Date: April 1, 1986

GENERAL CONDITIONS:

6. The permittee shall at all times properly operate and maintain the facility and systems of treatment and control (and related appurtenances) that are installed or used by the permittee to achieve compliance with the conditions of this permit, as required by department rules. This provision includes the operation of backup or auxiliary facilities or similar systems when necessary to achieve compliance with the conditions of the permit and when required by department rules.
7. The permittee, by accepting this permit, specifically agrees to allow authorized department personnel, upon presentation of credentials or other documents as may be required by law, access to the premises, at reasonable times, where the permitted activity is located or conducted for the purpose of:
 - a. Having access to and copying any records that must be kept under the conditions of the permit;
 - b. Inspecting the facility, equipment, practices, or operations regulated or required under this permit; and
 - c. Sampling or monitoring any substances or parameters at any location reasonably necessary to assure compliance with this permit or department rules.

Reasonable time may depend on the nature of the concern being investigated.

8. If, for any reason, the permittee does not comply with or will be unable to comply with any condition or limitation specified in this permit, the permittee shall immediately notify and provide the department with the following information:
 - a. a description of and cause of non-compliance; and
 - b. the period of noncompliance, including exact dates and times; or, if not corrected, the anticipated time the noncompliance is expected to continue, and steps being taken to reduce, eliminate, and prevent recurrence of the noncompliance.

PERMITTEE: Permit Number: AC 48-108740
Walt Disney World Company, Inc. Expiration Date: April 1, 1986

GENERAL CONDITIONS:

The permittee shall be responsible for any and all damages which may result and may be subject to enforcement action by the department for penalties or revocation of this permit.

9. In accepting this permit, the permittee understands and agrees that all records, notes, monitoring data and other information relating to the construction or operation of this permitted source, which are submitted to the department, may be used by the department as evidence in any enforcement case arising under the Florida Statutes or department rules, except where such use is proscribed by Sections 403.73 and 403.111, Florida Statutes.
10. The permittee agrees to comply with changes in department rules and Florida Statutes after a reasonable time for compliance, provided however, the permittee does not waive any other rights granted by Florida Statutes or department rules.
11. This permit is transferable only upon department approval in accordance with Florida Administrative Code Rules 17-4.12 and 17-30.30, as applicable. The permittee shall be liable for any non-compliance of the permitted activity until the transfer is approved by the department.
12. This permit is required to be kept at the work site of the permitted activity during the entire period of construction or operation.
13. This permit also constitutes:
 - () Determination of Best Available Control Technology (BACT)
 - () Determination of Prevention of Significant Deterioration (PSD)
 - () Compliance with New Source Performance Standards.
14. The permittee shall comply with the following monitoring and record keeping requirements:
 - a. Upon request, the permittee shall furnish all records and plans required under department rules. The retention period for all records will be extended automatically, unless otherwise stipulated by the department, during the course of any unresolved enforcement action.

PERMITTEE: Permit Number: AC 48-108740
Walt Disney World Company, Inc. Expiration Date: April 1, 1986

GENERAL CONDITIONS:

- b. The permittee shall retain at the facility or other location designated by this permit records of all monitoring information (including all calibration and maintenance records and all original strip chart recordings for continuous monitoring instrumentation), copies of all reports required by this permit, and records of all data used to complete the application for this permit. The time period of retention shall be at least three years from the date of the sample, measurement, report or application unless otherwise specified by department rule.
 - c. Records of monitoring information shall include:
 - the date, exact place, and time of sampling or measurements;
 - the person responsible for performing the sampling or measurements;
 - the date(s) analyses were performed;
 - the person responsible for performing the analyses;
 - the analytical techniques or methods used; and
 - the results of such analyses.
15. When requested by the department, the permittee shall within a reasonable time furnish any information required by law which is needed to determine compliance with the permit. If the permittee becomes aware that relevant facts were not submitted or were incorrect in the permit application or in any report to the department, such facts or information shall be submitted or corrected promptly.

SPECIFIC CONDITIONS:

- 1. The hours of operation shall not exceed 4160 hours per year.
- 2. The allowable particulate emission rate shall not exceed .125 pounds per hour or 0.19 tons per year.

PERMITTEE:
Walt Disney World Company, Inc.

Permit Number: AC 48-108740
Expiration Date: April 1, 1986

SPECIFIC CONDITIONS:

3. There shall be no visible emissions, initially demonstrated in accordance with DER Method 9 (Rule 17-2.700(6)(a)9, FAC).
4. Allowable volatile organic compound emissions shall not exceed 0.89 pounds per hour or 2.82 tons per year.
5. The volatile organic compound content of all coatings and solvents used in this booth, demonstrated by manufacturer's specification or EPA Method 24, shall be submitted to the St. Johns River District office.
6. The use of all coatings and solvents shall be recorded daily and shall be submitted quarterly to the St. Johns River District office.
7. Compliance tests, in accordance with FAC Rule 17-2.700, shall be submitted to DER's St. Johns River District office within 45 days after completion of the tests.
8. Fifteen (15) days notification of the compliance tests to DER's St. Johns River District office is required.
9. After satisfactory completion of the initial compliance test and prior to ninety (90) days before the expiration of this permit, a complete application for an operating permit shall be submitted to the St. Johns River District office. The permittee may continue to operate in compliance with all terms of this construction permit until its expiration date or the issuance of an operating permit. The department may extend the expiration date of this construction permit as authorized by Rule 17-2.210(1), FAC.

Issued this 23 day of Dec, 19 85

STATE OF FLORIDA DEPARTMENT OF
ENVIRONMENTAL REGULATION

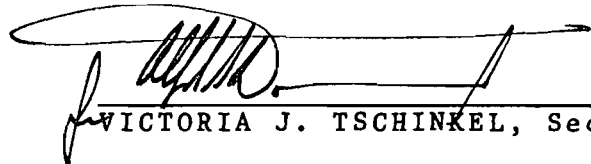
VICTORIA J. TSCHINKEL, Secretary

___ page attached.

STATE OF FLORIDA
DEPARTMENT OF ENVIRONMENTAL REGULATION

TWIN TOWERS OFFICE BUILDING
2600 BLAIR STONE ROAD
TALLAHASSEE, FLORIDA 32301-8241

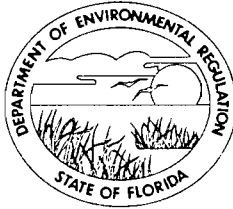

BOB GRAHAM
GOVERNOR
VICTORIA J. TSCHINKEL
SECRETARY

PERMITTEE: Walt Disney World Company, Inc.
Post Office Box 40
Lake Buena Vista, Florida 32830

Permit Number: AC 48-108741
Expiration Date: April 1, 1986
County: Orange
Latitude/Longitude: 28° 25' 32"N/
81° 34' 36"W

Project: NSA Paint Spray Booth No. 2

This permit is issued under the provisions of Chapters 403, Florida Statutes, and Florida Administrative Code Rule(s) 17-2 and 17-4. The above named permittee is hereby authorized to perform the work or operate the facility shown on the application and approved drawings, plans, and other documents attached hereto or on file with the department and made a part hereof and specifically described as follows:

For the construction of a spray booth which will be used to coat a variety of objects including vehicles, wooden furniture, trash cans, ride components, posts and frames using two part polyurethane, two part acrylic, epoxy primers and other primer coating systems. The booth will be equipped with two Binks model 30-4418 exhaust fans and Binks model 29-893 paint arrestor type filters.

Construction shall be in accordance with the attached permit application and additional information except as otherwise noted on pages 5 and 6, specific conditions.

Attachments are as follows:

1. Applications to construct an Air Pollution Source, DER form 17-1.202(1).

PERMITTEE:

Walt Disney World Company, Inc.

Permit Number: AC 48-108741

Expiration Date: April 1, 1986

GENERAL CONDITIONS:

1. The terms, conditions, requirements, limitations, and restrictions set forth herein are "Permit Conditions" and as such are binding upon the permittee and enforceable pursuant to the authority of Sections 403.161, 403.727, or 403.859 through 403.861, Florida Statutes. The permittee is hereby placed on notice that the department will review this permit periodically and may initiate enforcement action for any violation of the "Permit Conditions" by the permittee, its agents, employees, servants or representatives.
2. This permit is valid only for the specific processes and operations applied for and indicated in the approved drawings or exhibits. Any unauthorized deviation from the approved drawings, exhibits, specifications, or conditions of this permit may constitute grounds for revocation and enforcement action by the department.
3. As provided in Subsections 403.087(6) and 403.722(5), Florida Statutes, the issuance of this permit does not convey any vested rights or any exclusive privileges. Nor does it authorize any injury to public or private property or any invasion of personal rights, nor any infringement of federal, state or local laws or regulations. This permit does not constitute a waiver of or approval of any other department permit that may be required for other aspects of the total project which are not addressed in the permit.
4. This permit conveys no title to land or water, does not constitute state recognition or acknowledgement of title, and does not constitute authority for the use of submerged lands unless herein provided and the necessary title or leasehold interests have been obtained from the state. Only the Trustees of the Internal Improvement Trust Fund may express state opinion as to title.
5. This permit does not relieve the permittee from liability for harm or injury to human health or welfare, animal, plant or aquatic life or property and penalties therefore caused by the construction or operation of this permitted source, nor does it allow the permittee to cause pollution in contravention of Florida Statutes and department rules, unless specifically authorized by an order from the department.

PERMITTEE:

Walt Disney World Company, Inc.

Permit Number: AC 48-108741

Expiration Date: April 1, 1986

GENERAL CONDITIONS:

6. The permittee shall at all times properly operate and maintain the facility and systems of treatment and control (and related appurtenances) that are installed or used by the permittee to achieve compliance with the conditions of this permit, as required by department rules. This provision includes the operation of backup or auxiliary facilities or similar systems when necessary to achieve compliance with the conditions of the permit and when required by department rules.
7. The permittee, by accepting this permit, specifically agrees to allow authorized department personnel, upon presentation of credentials or other documents as may be required by law, access to the premises, at reasonable times, where the permitted activity is located or conducted for the purpose of:
 - a. Having access to and copying any records that must be kept under the conditions of the permit;
 - b. Inspecting the facility, equipment, practices, or operations regulated or required under this permit; and
 - c. Sampling or monitoring any substances or parameters at any location reasonably necessary to assure compliance with this permit or department rules.

Reasonable time may depend on the nature of the concern being investigated.

8. If, for any reason, the permittee does not comply with or will be unable to comply with any condition or limitation specified in this permit, the permittee shall immediately notify and provide the department with the following information:
 - a. a description of and cause of non-compliance; and
 - b. the period of noncompliance, including exact dates and times; or, if not corrected, the anticipated time the noncompliance is expected to continue, and steps being taken to reduce, eliminate, and prevent recurrence of the noncompliance.

PERMITTEE: Permit Number: AC 48-108741
Walt Disney World Company, Inc. Expiration Date: April 1, 1986

GENERAL CONDITIONS:

The permittee shall be responsible for any and all damages which may result and may be subject to enforcement action by the department for penalties or revocation of this permit.

9. In accepting this permit, the permittee understands and agrees that all records, notes, monitoring data and other information relating to the construction or operation of this permitted source, which are submitted to the department, may be used by the department as evidence in any enforcement case arising under the Florida Statutes or department rules, except where such use is proscribed by Sections 403.73 and 403.111, Florida Statutes.
10. The permittee agrees to comply with changes in department rules and Florida Statutes after a reasonable time for compliance, provided however, the permittee does not waive any other rights granted by Florida Statutes or department rules.
11. This permit is transferable only upon department approval in accordance with Florida Administrative Code Rules 17-4.12 and 17-30.30, as applicable. The permittee shall be liable for any non-compliance of the permitted activity until the transfer is approved by the department.
12. This permit is required to be kept at the work site of the permitted activity during the entire period of construction or operation.
13. This permit also constitutes:
 - () Determination of Best Available Control Technology (BACT)
 - () Determination of Prevention of Significant Deterioration (PSD)
 - () Compliance with New Source Performance Standards.
14. The permittee shall comply with the following monitoring and record keeping requirements:
 - a. Upon request, the permittee shall furnish all records and plans required under department rules. The retention period for all records will be extended automatically, unless otherwise stipulated by the department, during the course of any unresolved enforcement action.

PERMITTEE: Permit Number: AC 48-108741
Walt Disney World Company, Inc. Expiration Date: April 1, 1986

GENERAL CONDITIONS:

- b. The permittee shall retain at the facility or other location designated by this permit records of all monitoring information (including all calibration and maintenance records and all original strip chart recordings for continuous monitoring instrumentation), copies of all reports required by this permit, and records of all data used to complete the application for this permit. The time period of retention shall be at least three years from the date of the sample, measurement, report or application unless otherwise specified by department rule.
 - c. Records of monitoring information shall include:
 - the date, exact place, and time of sampling or measurements;
 - the person responsible for performing the sampling or measurements;
 - the date(s) analyses were performed;
 - the person responsible for performing the analyses;
 - the analytical techniques or methods used; and
 - the results of such analyses.
15. When requested by the department, the permittee shall within a reasonable time furnish any information required by law which is needed to determine compliance with the permit. If the permittee becomes aware that relevant facts were not submitted or were incorrect in the permit application or in any report to the department, such facts or information shall be submitted or corrected promptly.

SPECIFIC CONDITIONS:

- 1. The hours of operation shall not exceed 4160 hours per year.
- 2. The allowable particulate emission rate shall not exceed 0.250 pounds per hour or 0.38 tons per year.

PERMITTEE: Walt Disney World Company, Inc. Permit Number: AC 48-108741
Expiration Date: April 1, 1986

SPECIFIC CONDITIONS:

3. There shall be no visible emissions, initially demonstrated in accordance with DER Method 9 (Rule 17-2.700(6)(a)9, FAC).
4. Allowable volatile organic compound emissions shall not exceed 1.77 pounds per hour or 5.65 tons per year.
5. The volatile organic compound content of all coatings and solvents used in this booth, demonstrated by manufacturer's specification or EPA Method 24, shall be submitted to the St. Johns River District office.
6. The use of all coatings and solvents shall be recorded daily and shall be submitted quarterly to the St. Johns River District office.
7. Compliance tests, in accordance with FAC Rule 17-2.700, shall be submitted to DER's St. Johns River District office within 45 days after completion of the tests.
8. Fifteen (15) days notification of the compliance tests to DER's St. Johns River District office is required.
9. After satisfactory completion of the initial compliance test and prior to ninety (90) days before the expiration of this permit, a complete application for an operating permit shall be submitted to the St. Johns River District office. The permittee may continue to operate in compliance with all terms of this construction permit until its expiration date or the issuance of an operating permit. The department may extend the expiration date of this construction permit as authorized by Rule 17-2.210(1), FAC.

Issued this 23rd day of Dec, 19 85

STATE OF FLORIDA DEPARTMENT OF
ENVIRONMENTAL REGULATION

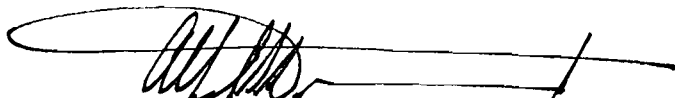

VICTORIA J. TSCHINKEL, Secretary

_____page attached.

STATE OF FLORIDA
DEPARTMENT OF ENVIRONMENTAL REGULATION

TWIN TOWERS OFFICE BUILDING
2600 BLAIR STONE ROAD
TALLAHASSEE, FLORIDA 32301-8241

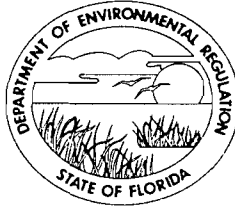

BOB GRAHAM
GOVERNOR
VICTORIA J. TSCHINKEL
SECRETARY

PERMITTEE: Walt Disney World Company, Inc.
Post Office Box 40
Lake Buena Vista, Florida 32830

Permit Number: AC 48-108742
Expiration Date: April 1, 1986
County: Orange
Latitude/Longitude: 28° 25' 32"N/
81° 34' 36"W

Project: NSA Paint Spray Booth No. 3

This permit is issued under the provisions of Chapters 403, Florida Statutes, and Florida Administrative Code Rule(s) 17-2 and 17-4. The above named permittee is hereby authorized to perform the work or operate the facility shown on the application and approved drawings, plans, and other documents attached hereto or on file with the department and made a part hereof and specifically described as follows:

For the construction of a spray booth which will be used to coat a variety of objects including vehicles, wooden furniture, trash cans, ride components, posts and frames using two part polyurethane, two part acrylic, epoxy primers and other primer coating systems. The booth will be equipped with two Binks model 30-4418 exhaust fans and Binks model 29-893 paint arrestor type filters.

Construction shall be in accordance with the attached permit application and additional information except as otherwise noted on pages 5 and 6, specific conditions.

Attachments are as follows:

1. Applications to construct an Air Pollution Source, DER form 17-1.202(1).

PERMITTEE:
Walt Disney World Company, Inc.

Permit Number: AC 48-108742
Expiration Date: April 1, 1986

GENERAL CONDITIONS:

1. The terms, conditions, requirements, limitations, and restrictions set forth herein are "Permit Conditions" and as such are binding upon the permittee and enforceable pursuant to the authority of Sections 403.161, 403.727, or 403.859 through 403.861, Florida Statutes. The permittee is hereby placed on notice that the department will review this permit periodically and may initiate enforcement action for any violation of the "Permit Conditions" by the permittee, its agents, employees, servants or representatives.
2. This permit is valid only for the specific processes and operations applied for and indicated in the approved drawings or exhibits. Any unauthorized deviation from the approved drawings, exhibits, specifications, or conditions of this permit may constitute grounds for revocation and enforcement action by the department.
3. As provided in Subsections 403.087(6) and 403.722(5), Florida Statutes, the issuance of this permit does not convey any vested rights or any exclusive privileges. Nor does it authorize any injury to public or private property or any invasion of personal rights, nor any infringement of federal, state or local laws or regulations. This permit does not constitute a waiver of or approval of any other department permit that may be required for other aspects of the total project which are not addressed in the permit.
4. This permit conveys no title to land or water, does not constitute state recognition or acknowledgement of title, and does not constitute authority for the use of submerged lands unless herein provided and the necessary title or leasehold interests have been obtained from the state. Only the Trustees of the Internal Improvement Trust Fund may express state opinion as to title.
5. This permit does not relieve the permittee from liability for harm or injury to human health or welfare, animal, plant or aquatic life or property and penalties therefore caused by the construction or operation of this permitted source, nor does it allow the permittee to cause pollution in contravention of Florida Statutes and department rules, unless specifically authorized by an order from the department.

PERMITTEE:

Walt Disney World Company, Inc.

Permit Number: AC 48-108742

Expiration Date: April 1, 1986

GENERAL CONDITIONS:

6. The permittee shall at all times properly operate and maintain the facility and systems of treatment and control (and related appurtenances) that are installed or used by the permittee to achieve compliance with the conditions of this permit, as required by department rules. This provision includes the operation of backup or auxiliary facilities or similar systems when necessary to achieve compliance with the conditions of the permit and when required by department rules.
7. The permittee, by accepting this permit, specifically agrees to allow authorized department personnel, upon presentation of credentials or other documents as may be required by law, access to the premises, at reasonable times, where the permitted activity is located or conducted for the purpose of:
 - a. Having access to and copying any records that must be kept under the conditions of the permit;
 - b. Inspecting the facility, equipment, practices, or operations regulated or required under this permit; and
 - c. Sampling or monitoring any substances or parameters at any location reasonably necessary to assure compliance with this permit or department rules.

Reasonable time may depend on the nature of the concern being investigated.

8. If, for any reason, the permittee does not comply with or will be unable to comply with any condition or limitation specified in this permit, the permittee shall immediately notify and provide the department with the following information:
 - a. a description of and cause of non-compliance; and
 - b. the period of noncompliance, including exact dates and times; or, if not corrected, the anticipated time the noncompliance is expected to continue, and steps being taken to reduce, eliminate, and prevent recurrence of the noncompliance.

PERMITTEE: Permit Number: AC 48-108742
Walt Disney World Company, Inc. Expiration Date: April 1, 1986

GENERAL CONDITIONS:

The permittee shall be responsible for any and all damages which may result and may be subject to enforcement action by the department for penalties or revocation of this permit.

9. In accepting this permit, the permittee understands and agrees that all records, notes, monitoring data and other information relating to the construction or operation of this permitted source, which are submitted to the department, may be used by the department as evidence in any enforcement case arising under the Florida Statutes or department rules, except where such use is proscribed by Sections 403.73 and 403.111, Florida Statutes.
10. The permittee agrees to comply with changes in department rules and Florida Statutes after a reasonable time for compliance, provided however, the permittee does not waive any other rights granted by Florida Statutes or department rules.
11. This permit is transferable only upon department approval in accordance with Florida Administrative Code Rules 17-4.12 and 17-30.30, as applicable. The permittee shall be liable for any non-compliance of the permitted activity until the transfer is approved by the department.
12. This permit is required to be kept at the work site of the permitted activity during the entire period of construction or operation.
13. This permit also constitutes:
 - () Determination of Best Available Control Technology (BACT)
 - () Determination of Prevention of Significant Deterioration (PSD)
 - () Compliance with New Source Performance Standards.
14. The permittee shall comply with the following monitoring and record keeping requirements:
 - a. Upon request, the permittee shall furnish all records and plans required under department rules. The retention period for all records will be extended automatically, unless otherwise stipulated by the department, during the course of any unresolved enforcement action.

PERMITTEE:

Walt Disney World Company, Inc.

Permit Number: AC 48-108742

Expiration Date: April 1, 1986

GENERAL CONDITIONS:

- b. The permittee shall retain at the facility or other location designated by this permit records of all monitoring information (including all calibration and maintenance records and all original strip chart recordings for continuous monitoring instrumentation), copies of all reports required by this permit, and records of all data used to complete the application for this permit. The time period of retention shall be at least three years from the date of the sample, measurement, report or application unless otherwise specified by department rule.
 - c. Records of monitoring information shall include:
 - the date, exact place, and time of sampling or measurements;
 - the person responsible for performing the sampling or measurements;
 - the date(s) analyses were performed;
 - the person responsible for performing the analyses;
 - the analytical techniques or methods used; and
 - the results of such analyses.
15. When requested by the department, the permittee shall within a reasonable time furnish any information required by law which is needed to determine compliance with the permit. If the permittee becomes aware that relevant facts were not submitted or were incorrect in the permit application or in any report to the department, such facts or information shall be submitted or corrected promptly.

SPECIFIC CONDITIONS:

- 1. The hours of operation shall not exceed 4160 hours per year.
- 2. The allowable particulate emission rate shall not exceed 0.250 pounds per hour or 0.38 tons per year.

PERMITTEE:

Walt Disney World Company, Inc.

Permit Number: AC 48-108742

Expiration Date: April 1, 1986

SPECIFIC CONDITIONS:

3. There shall be no visible emissions, initially demonstrated in accordance with DER Method 9 (Rule 17-2.700(6)(a)9, FAC).
4. Allowable volatile organic compound emissions shall not exceed 3.54 pounds per hour or 5.65 tons per year.
5. The volatile organic compound content of all coatings and solvents used in this booth, demonstrated by manufacturer's specification or EPA Method 24, shall be submitted to the St. Johns River District office.
6. The use of all coatings and solvents shall be recorded daily and shall be submitted quarterly to the St. Johns River District office.
7. Compliance tests, in accordance with FAC Rule 17-2.700, shall be submitted to DER's St. Johns River District office within 45 days after completion of the tests.
8. Fifteen (15) days notification of the compliance tests to DER's St. Johns River District office is required.
9. After satisfactory completion of the initial compliance test and prior to ninety (90) days before the expiration of this permit, a complete application for an operating permit shall be submitted to the St. Johns River District office. The permittee may continue to operate in compliance with all terms of this construction permit until its expiration date or the issuance of an operating permit. The department may extend the expiration date of this construction permit as authorized by Rule 17-2.210(1), FAC.

Issued this 23rd day of Dec, 19 85

STATE OF FLORIDA DEPARTMENT OF
ENVIRONMENTAL REGULATION

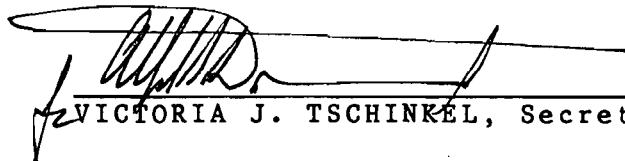

VICTORIA J. TSCHINKEL, Secretary

___ page attached.

STATE OF FLORIDA
DEPARTMENT OF ENVIRONMENTAL REGULATION

TWIN TOWERS OFFICE BUILDING
2600 BLAIR STONE ROAD
TALLAHASSEE, FLORIDA 32301-8241



BOB GRAHAM
GOVERNOR
VICTORIA J. TSCHINKEL
SECRETARY

PERMITTEE: Permit Number: AC 48-108743
Walt Disney World Company, Inc. Expiration Date: April 1, 1986
Post Office Box 40 County: Orange
Lake Buena Vista, Florida 32830 Latitude/Longitude: 28° 25' 32"N/
81° 34' 36"W
Project: NSA Staff Shop Booth No. 1

This permit is issued under the provisions of Chapters 403, Florida Statutes, and Florida Administrative Code Rule(s) 17-2 and 17-4. The above named permittee is hereby authorized to perform the work or operate the facility shown on the application and approved drawings, plans, and other documents attached hereto or on file with the department and made a part hereof and specifically described as follows:

For the construction of a spray booth which will be used to spray polyester resin, lacquer based coatings and polyvinyl alcohol on fiberglass objects and molds. The booth will be a Binks model PPF with model 30-800 fans. The particulate filters will have an efficiency of 80% for lacquers and 95% for two part high particulate coating systems.

Construction shall be in accordance with the attached permit application and additional information except as otherwise noted on pages 5 and 6, specific conditions.

Attachments are as follows:

1. Applications to construct an Air Pollution Source, DER form 17-1.202(1).

PERMITTEE:

Walt Disney World Company, Inc.

Permit Number: AC 48-108743

Expiration Date: April 1, 1986

GENERAL CONDITIONS:

1. The terms, conditions, requirements, limitations, and restrictions set forth herein are "Permit Conditions" and as such are binding upon the permittee and enforceable pursuant to the authority of Sections 403.161, 403.727, or 403.859 through 403.861, Florida Statutes. The permittee is hereby placed on notice that the department will review this permit periodically and may initiate enforcement action for any violation of the "Permit Conditions" by the permittee, its agents, employees, servants or representatives.
2. This permit is valid only for the specific processes and operations applied for and indicated in the approved drawings or exhibits. Any unauthorized deviation from the approved drawings, exhibits, specifications, or conditions of this permit may constitute grounds for revocation and enforcement action by the department.
3. As provided in Subsections 403.087(6) and 403.722(5), Florida Statutes, the issuance of this permit does not convey any vested rights or any exclusive privileges. Nor does it authorize any injury to public or private property or any invasion of personal rights, nor any infringement of federal, state or local laws or regulations. This permit does not constitute a waiver of or approval of any other department permit that may be required for other aspects of the total project which are not addressed in the permit.
4. This permit conveys no title to land or water, does not constitute state recognition or acknowledgement of title, and does not constitute authority for the use of submerged lands unless herein provided and the necessary title or leasehold interests have been obtained from the state. Only the Trustees of the Internal Improvement Trust Fund may express state opinion as to title.
5. This permit does not relieve the permittee from liability for harm or injury to human health or welfare, animal, plant or aquatic life or property and penalties therefore caused by the construction or operation of this permitted source, nor does it allow the permittee to cause pollution in contravention of Florida Statutes and department rules, unless specifically authorized by an order from the department.

Best Available Copy

PERMITTEE: Permit Number: AC 48-108743
Walt Disney World Company, Inc. Expiration Date: April 1, 1986

GENERAL CONDITIONS:

6. The permittee shall at all times properly operate and maintain the facility and systems of treatment and control (and related appurtenances) that are installed or used by the permittee to achieve compliance with the conditions of this permit, as required by department rules. This provision includes the operation of backup or auxiliary facilities or similar systems when necessary to achieve compliance with the conditions of the permit and when required by department rules.
7. The permittee, by accepting this permit, specifically agrees to allow authorized department personnel, upon presentation of credentials or other documents as may be required by law, access to the premises, at reasonable times, where the permitted activity is located or conducted for the purpose of:
 - a. Having access to and copying any records that must be kept under the conditions of the permit;
 - b. Inspecting the facility, equipment, practices, or operations regulated or required under this permit; and
 - c. Sampling or monitoring any substances or parameters at any location reasonably necessary to assure compliance with this permit or department rules.

Reasonable time may depend on the nature of the concern being investigated.

8. If, for any reason, the permittee does not comply with or will be unable to comply with any condition or limitation specified in this permit, the permittee shall immediately notify and provide the department with the following information:
 - a. a description of and cause of non-compliance; and
 - b. the period of noncompliance, including exact dates and times; or, if not corrected, the anticipated time the noncompliance is expected to continue, and steps being taken to reduce, eliminate, and prevent recurrence of the noncompliance.

PERMITTEE:
Walt Disney World Company, Inc.

Permit Number: AC 48-108743
Expiration Date: April 1, 1986

GENERAL CONDITIONS:

The permittee shall be responsible for any and all damages which may result and may be subject to enforcement action by the department for penalties or revocation of this permit.

9. In accepting this permit, the permittee understands and agrees that all records, notes, monitoring data and other information relating to the construction or operation of this permitted source, which are submitted to the department, may be used by the department as evidence in any enforcement case arising under the Florida Statutes or department rules, except where such use is proscribed by Sections 403.73 and 403.111, Florida Statutes.
10. The permittee agrees to comply with changes in department rules and Florida Statutes after a reasonable time for compliance, provided however, the permittee does not waive any other rights granted by Florida Statutes or department rules.
11. This permit is transferable only upon department approval in accordance with Florida Administrative Code Rules 17-4.12 and 17-30.30, as applicable. The permittee shall be liable for any non-compliance of the permitted activity until the transfer is approved by the department.
12. This permit is required to be kept at the work site of the permitted activity during the entire period of construction or operation.
13. This permit also constitutes:
 - () Determination of Best Available Control Technology (BACT)
 - () Determination of Prevention of Significant Deterioration (PSD)
 - () Compliance with New Source Performance Standards.
14. The permittee shall comply with the following monitoring and record keeping requirements:
 - a. Upon request, the permittee shall furnish all records and plans required under department rules. The retention period for all records will be extended automatically, unless otherwise stipulated by the department, during the course of any unresolved enforcement action.

PERMITTEE:

Walt Disney World Company, Inc.

Permit Number: AC 48-108743

Expiration Date: April 1, 1986

GENERAL CONDITIONS:

- b. The permittee shall retain at the facility or other location designated by this permit records of all monitoring information (including all calibration and maintenance records and all original strip chart recordings for continuous monitoring instrumentation), copies of all reports required by this permit, and records of all data used to complete the application for this permit. The time period of retention shall be at least three years from the date of the sample, measurement, report or application unless otherwise specified by department rule.
 - c. Records of monitoring information shall include:
 - the date, exact place, and time of sampling or measurements;
 - the person responsible for performing the sampling or measurements;
 - the date(s) analyses were performed;
 - the person responsible for performing the analyses;
 - the analytical techniques or methods used; and
 - the results of such analyses.
15. When requested by the department, the permittee shall within a reasonable time furnish any information required by law which is needed to determine compliance with the permit. If the permittee becomes aware that relevant facts were not submitted or were incorrect in the permit application or in any report to the department, such facts or information shall be submitted or corrected promptly.

SPECIFIC CONDITIONS:

- 1. The hours of operation shall not exceed 2080 hours per year.
- 2. The allowable particulate emission rate shall not exceed 0.02 pounds per hour or 0.02 tons per year.

PERMITTEE:

Walt Disney World Company, Inc.

Permit Number: AC 48-108743

Expiration Date: April 1, 1986

SPECIFIC CONDITIONS:

3. There shall be no visible emissions, initially demonstrated in accordance with DER Method 9 (Rule 17-2.700(6)(a)9, FAC).
4. Allowable volatile organic compound emissions shall not exceed 0.08 pounds per hour or 0.08 tons per year.
5. The volatile organic compound content of all coatings and solvents used in this booth, demonstrated by manufacturer's specification or EPA Method 24, shall be submitted to the St. Johns River District office.
6. The use of all coatings and solvents shall be recorded daily and shall be submitted quarterly to the St. Johns River District office.
7. Compliance tests, in accordance with FAC Rule 17-2.700, shall be submitted to DER's St. Johns River District office within 45 days after completion of the tests.
8. Fifteen (15) days notification of the compliance tests to DER's St. Johns River District office is required.
9. After satisfactory completion of the initial compliance test and prior to ninety (90) days before the expiration of this permit, a complete application for an operating permit shall be submitted to the St. Johns River District office. The permittee may continue to operate in compliance with all terms of this construction permit until its expiration date or the issuance of an operating permit. The department may extend the expiration date of this construction permit as authorized by Rule 17-2.210(1), FAC.

Issued this 23rd day of Dec, 1985

STATE OF FLORIDA DEPARTMENT OF
ENVIRONMENTAL REGULATION

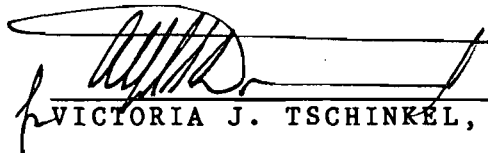

VICTORIA J. TSCHINKEL, Secretary

_____page attached.

Best Available Copy

STATE OF FLORIDA

DEPARTMENT OF ENVIRONMENTAL REGULATION

TWIN TOWERS OFFICE BUILDING
2600 BLAIR STONE ROAD
TALLAHASSEE, FLORIDA 32301-8241



BOB GRAHAM
GOVERNOR

VICTORIA J. TSCHINKEL
SECRETARY

PERMITTEE: Permit Number: AC 48-108744
Walt Disney World Company, Inc. Expiration Date: April 1, 1986
Post Office Box 40 County: Orange
Lake Buena Vista, Florida 32830 Latitude/Longitude: 28° 25' 32"N/
81° 34' 36"W
Project: NSA Staff Shop Spray
Booth No. 2

This permit is issued under the provisions of Chapters 403, Florida Statutes, and Florida Administrative Code Rule(s) 17-2 and 17-4. The above named permittee is hereby authorized to perform the work or operate the facility shown on the application and approved drawings, plans, and other documents attached hereto or on file with the department and made a part hereof and specifically described as follows:

For the construction of a spray booth which will be used to spray lacquer based coatings and polyvinyl alcohol on fiberglass objects and molds. This built in spray booth will be equipped with a New York model 548-1 blower and particulate filters with an efficiency of 80% for lacquers and 95% for two part high particulate coating systems.

Construction shall be in accordance with the attached permit application and additional information except as otherwise noted on pages 5 and 6, specific conditions.

Attachments are as follows:

1. Applications to construct an Air Pollution Source, DER form 17-1.202(1).

PERMITTEE:

Permit Number: AC 48-108744

Walt Disney World Company, Inc. Expiration Date: April 1, 1986

GENERAL CONDITIONS:

1. The terms, conditions, requirements, limitations, and restrictions set forth herein are "Permit Conditions" and as such are binding upon the permittee and enforceable pursuant to the authority of Sections 403.161, 403.727, or 403.859 through 403.861, Florida Statutes. The permittee is hereby placed on notice that the department will review this permit periodically and may initiate enforcement action for any violation of the "Permit Conditions" by the permittee, its agents, employees, servants or representatives.
2. This permit is valid only for the specific processes and operations applied for and indicated in the approved drawings or exhibits. Any unauthorized deviation from the approved drawings, exhibits, specifications, or conditions of this permit may constitute grounds for revocation and enforcement action by the department.
3. As provided in Subsections 403.087(6) and 403.722(5), Florida Statutes, the issuance of this permit does not convey any vested rights or any exclusive privileges. Nor does it authorize any injury to public or private property or any invasion of personal rights, nor any infringement of federal, state or local laws or regulations. This permit does not constitute a waiver of or approval of any other department permit that may be required for other aspects of the total project which are not addressed in the permit.
4. This permit conveys no title to land or water, does not constitute state recognition or acknowledgement of title, and does not constitute authority for the use of submerged lands unless herein provided and the necessary title or leasehold interests have been obtained from the state. Only the Trustees of the Internal Improvement Trust Fund may express state opinion as to title.
5. This permit does not relieve the permittee from liability for harm or injury to human health or welfare, animal, plant or aquatic life or property and penalties therefore caused by the construction or operation of this permitted source, nor does it allow the permittee to cause pollution in contravention of Florida Statutes and department rules, unless specifically authorized by an order from the department.

PERMITTEE: Permit Number: AC 48-108744
Walt Disney World Company, Inc. Expiration Date: April 1, 1986

GENERAL CONDITIONS:

6. The permittee shall at all times properly operate and maintain the facility and systems of treatment and control (and related appurtenances) that are installed or used by the permittee to achieve compliance with the conditions of this permit, as required by department rules. This provision includes the operation of backup or auxiliary facilities or similar systems when necessary to achieve compliance with the conditions of the permit and when required by department rules.
7. The permittee, by accepting this permit, specifically agrees to allow authorized department personnel, upon presentation of credentials or other documents as may be required by law, access to the premises, at reasonable times, where the permitted activity is located or conducted for the purpose of:
 - a. Having access to and copying any records that must be kept under the conditions of the permit;
 - b. Inspecting the facility, equipment, practices, or operations regulated or required under this permit; and
 - c. Sampling or monitoring any substances or parameters at any location reasonably necessary to assure compliance with this permit or department rules.

Reasonable time may depend on the nature of the concern being investigated.

8. If, for any reason, the permittee does not comply with or will be unable to comply with any condition or limitation specified in this permit, the permittee shall immediately notify and provide the department with the following information:
 - a. a description of and cause of non-compliance; and
 - b. the period of noncompliance, including exact dates and times; or, if not corrected, the anticipated time the noncompliance is expected to continue, and steps being taken to reduce, eliminate, and prevent recurrence of the noncompliance.

PERMITTEE: Permit Number: AC 48-108744
Walt Disney World Company, Inc. Expiration Date: April 1, 1986

GENERAL CONDITIONS:

The permittee shall be responsible for any and all damages which may result and may be subject to enforcement action by the department for penalties or revocation of this permit.

9. In accepting this permit, the permittee understands and agrees that all records, notes, monitoring data and other information relating to the construction or operation of this permitted source, which are submitted to the department, may be used by the department as evidence in any enforcement case arising under the Florida Statutes or department rules, except where such use is proscribed by Sections 403.73 and 403.111, Florida Statutes.
10. The permittee agrees to comply with changes in department rules and Florida Statutes after a reasonable time for compliance, provided however, the permittee does not waive any other rights granted by Florida Statutes or department rules.
11. This permit is transferable only upon department approval in accordance with Florida Administrative Code Rules 17-4.12 and 17-30.30, as applicable. The permittee shall be liable for any non-compliance of the permitted activity until the transfer is approved by the department.
12. This permit is required to be kept at the work site of the permitted activity during the entire period of construction or operation.
13. This permit also constitutes:
 - () Determination of Best Available Control Technology (BACT)
 - () Determination of Prevention of Significant Deterioration (PSD)
 - () Compliance with New Source Performance Standards.
14. The permittee shall comply with the following monitoring and record keeping requirements:
 - a. Upon request, the permittee shall furnish all records and plans required under department rules. The retention period for all records will be extended automatically, unless otherwise stipulated by the department, during the course of any unresolved enforcement action.

PERMITTEE:

Walt Disney World Company, Inc.

Permit Number: AC 48-108744

Expiration Date: April 1, 1986

GENERAL CONDITIONS:

b. The permittee shall retain at the facility or other location designated by this permit records of all monitoring information (including all calibration and maintenance records and all original strip chart recordings for continuous monitoring instrumentation), copies of all reports required by this permit, and records of all data used to complete the application for this permit. The time period of retention shall be at least three years from the date of the sample, measurement, report or application unless otherwise specified by department rule.

c. Records of monitoring information shall include:

- the date, exact place, and time of sampling or measurements;
- the person responsible for performing the sampling or measurements;
- the date(s) analyses were performed;
- the person responsible for performing the analyses;
- the analytical techniques or methods used; and
- the results of such analyses.

15. When requested by the department, the permittee shall within a reasonable time furnish any information required by law which is needed to determine compliance with the permit. If the permittee becomes aware that relevant facts were not submitted or were incorrect in the permit application or in any report to the department, such facts or information shall be submitted or corrected promptly.

SPECIFIC CONDITIONS:

1. The hours of operation shall not exceed 2080 hours per year.
2. The allowable particulate emission rate shall not exceed 0.40 pounds per hour or 0.16 tons per year.

PERMITTEE: Walt Disney World Company, Inc. Permit Number: AC 48-108744
Expiration Date: April 1, 1986

SPECIFIC CONDITIONS:

3. There shall be no visible emissions, initially demonstrated in accordance with DER Method 9 (Rule 17-2.700(6)(a)9, FAC).
4. Allowable volatile organic compound emissions shall not exceed 0.61 pounds per hour or 0.63 tons per year.
5. The volatile organic compound content of all coatings and solvents used in this booth, demonstrated by manufacturer's specification or EPA Method 24, shall be submitted to the St. Johns River District office.
6. The use of all coatings and solvents shall be recorded daily and shall be submitted quarterly to the St. Johns River District office.
7. Compliance tests, in accordance with FAC Rule 17-2.700, shall be submitted to DER's St. Johns River District office within 45 days after completion of the tests.
8. Fifteen (15) days notification of the compliance tests to DER's St. Johns River District office is required.
9. After satisfactory completion of the initial compliance test and prior to ninety (90) days before the expiration of this permit, a complete application for an operating permit shall be submitted to the St. Johns River District office. The permittee may continue to operate in compliance with all terms of this construction permit until its expiration date or the issuance of an operating permit. The department may extend the expiration date of this construction permit as authorized by Rule 17-2.210(1), FAC.

Issued this 23rd day of Dec, 19 85

STATE OF FLORIDA DEPARTMENT OF
ENVIRONMENTAL REGULATION

VICTORIA J. TSCHINKEL, Secretary

___ page attached.

STATE OF FLORIDA
DEPARTMENT OF ENVIRONMENTAL REGULATION

TWIN TOWERS OFFICE BUILDING
2600 BLAIR STONE ROAD
TALLAHASSEE, FLORIDA 32301-8241

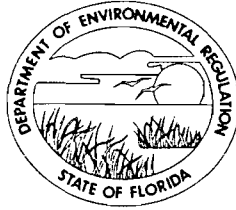

BOB GRAHAM
GOVERNOR
VICTORIA J. TSCHINKEL
SECRETARY

PERMITTEE: Walt Disney World Company, Inc.
Post Office Box 40
Lake Buena Vista, Florida 32830

Permit Number: AC 48-108745
Expiration Date: April 1, 1986
County: Orange
Latitude/Longitude: 28° 25' 32"N/
81° 34' 36"W

Project: Water Wash Plastisol Booth
No. 1

This permit is issued under the provisions of Chapters 403, Florida Statutes, and Florida Administrative Code Rule(s) 17-2 and 17-4. The above named permittee is hereby authorized to perform the work or operate the facility shown on the application and approved drawings, plans, and other documents attached hereto or on file with the department and made a part hereof and specifically described as follows:

For the construction of a Plastisol booth which will consist of a spray booth and curing oven. The spray booth will be a Binks water wash type equipped with a fan and a no pump dyna-precipitator water wash filtering system. The curing oven will be equipped with a fan and be fired by natural gas with an exit stack temperature of 350°F. The booth will be used to spray solvated vinyl plastisol on fiberglass objects and molds.

Construction shall be in accordance with the attached permit application and additional information except as otherwise noted on pages 5 and 6, specific conditions.

Attachments are as follows:

1. Applications to construct an Air Pollution Source, DER form 17-1.202(1).

PERMITTEE:

Walt Disney World Company, Inc.

Permit Number: AC 48-108745

Expiration Date: April 1, 1986

GENERAL CONDITIONS:

1. The terms, conditions, requirements, limitations, and restrictions set forth herein are "Permit Conditions" and as such are binding upon the permittee and enforceable pursuant to the authority of Sections 403.161, 403.727, or 403.859 through 403.861, Florida Statutes. The permittee is hereby placed on notice that the department will review this permit periodically and may initiate enforcement action for any violation of the "Permit Conditions" by the permittee, its agents, employees, servants or representatives.
2. This permit is valid only for the specific processes and operations applied for and indicated in the approved drawings or exhibits. Any unauthorized deviation from the approved drawings, exhibits, specifications, or conditions of this permit may constitute grounds for revocation and enforcement action by the department.
3. As provided in Subsections 403.087(6) and 403.722(5), Florida Statutes, the issuance of this permit does not convey any vested rights or any exclusive privileges. Nor does it authorize any injury to public or private property or any invasion of personal rights, nor any infringement of federal, state or local laws or regulations. This permit does not constitute a waiver of or approval of any other department permit that may be required for other aspects of the total project which are not addressed in the permit.
4. This permit conveys no title to land or water, does not constitute state recognition or acknowledgement of title, and does not constitute authority for the use of submerged lands unless herein provided and the necessary title or leasehold interests have been obtained from the state. Only the Trustees of the Internal Improvement Trust Fund may express state opinion as to title.
5. This permit does not relieve the permittee from liability for harm or injury to human health or welfare, animal, plant or aquatic life or property and penalties therefore caused by the construction or operation of this permitted source, nor does it allow the permittee to cause pollution in contravention of Florida Statutes and department rules, unless specifically authorized by an order from the department.

PERMITTEE: Permit Number: AC 48-108745
Walt Disney World Company, Inc. Expiration Date: April 1, 1986

GENERAL CONDITIONS:

6. The permittee shall at all times properly operate and maintain the facility and systems of treatment and control (and related appurtenances) that are installed or used by the permittee to achieve compliance with the conditions of this permit, as required by department rules. This provision includes the operation of backup or auxiliary facilities or similar systems when necessary to achieve compliance with the conditions of the permit and when required by department rules.
7. The permittee, by accepting this permit, specifically agrees to allow authorized department personnel, upon presentation of credentials or other documents as may be required by law, access to the premises, at reasonable times, where the permitted activity is located or conducted for the purpose of:
 - a. Having access to and copying any records that must be kept under the conditions of the permit;
 - b. Inspecting the facility, equipment, practices, or operations regulated or required under this permit; and
 - c. Sampling or monitoring any substances or parameters at any location reasonably necessary to assure compliance with this permit or department rules.

Reasonable time may depend on the nature of the concern being investigated.

8. If, for any reason, the permittee does not comply with or will be unable to comply with any condition or limitation specified in this permit, the permittee shall immediately notify and provide the department with the following information:
 - a. a description of and cause of non-compliance; and
 - b. the period of noncompliance, including exact dates and times; or, if not corrected, the anticipated time the noncompliance is expected to continue, and steps being taken to reduce, eliminate, and prevent recurrence of the noncompliance.

PERMITTEE: Permit Number: AC 48-108745
Walt Disney World Company, Inc. Expiration Date: April 1, 1986

GENERAL CONDITIONS:

The permittee shall be responsible for any and all damages which may result and may be subject to enforcement action by the department for penalties or revocation of this permit.

9. In accepting this permit, the permittee understands and agrees that all records, notes, monitoring data and other information relating to the construction or operation of this permitted source, which are submitted to the department, may be used by the department as evidence in any enforcement case arising under the Florida Statutes or department rules, except where such use is proscribed by Sections 403.73 and 403.111, Florida Statutes.
10. The permittee agrees to comply with changes in department rules and Florida Statutes after a reasonable time for compliance, provided however, the permittee does not waive any other rights granted by Florida Statutes or department rules.
11. This permit is transferable only upon department approval in accordance with Florida Administrative Code Rules 17-4.12 and 17-30.30, as applicable. The permittee shall be liable for any non-compliance of the permitted activity until the transfer is approved by the department.
12. This permit is required to be kept at the work site of the permitted activity during the entire period of construction or operation.
13. This permit also constitutes:
 - () Determination of Best Available Control Technology (BACT)
 - () Determination of Prevention of Significant Deterioration (PSD)
 - () Compliance with New Source Performance Standards.
14. The permittee shall comply with the following monitoring and record keeping requirements:
 - a. Upon request, the permittee shall furnish all records and plans required under department rules. The retention period for all records will be extended automatically, unless otherwise stipulated by the department, during the course of any unresolved enforcement action.

PERMITTEE: Permit Number: AC 48-108745
Walt Disney World Company, Inc. Expiration Date: April 1, 1986

GENERAL CONDITIONS:

- b. The permittee shall retain at the facility or other location designated by this permit records of all monitoring information (including all calibration and maintenance records and all original strip chart recordings for continuous monitoring instrumentation), copies of all reports required by this permit, and records of all data used to complete the application for this permit. The time period of retention shall be at least three years from the date of the sample, measurement, report or application unless otherwise specified by department rule.
 - c. Records of monitoring information shall include:
 - the date, exact place, and time of sampling or measurements;
 - the person responsible for performing the sampling or measurements;
 - the date(s) analyses were performed;
 - the person responsible for performing the analyses;
 - the analytical techniques or methods used; and
 - the results of such analyses.
15. When requested by the department, the permittee shall within a reasonable time furnish any information required by law which is needed to determine compliance with the permit. If the permittee becomes aware that relevant facts were not submitted or were incorrect in the permit application or in any report to the department, such facts or information shall be submitted or corrected promptly.

SPECIFIC CONDITIONS:

- 1. The hours of operation shall not exceed 2080 hours per year.
- 2. The allowable particulate emission rate shall not exceed 0.07 pounds per hour or 0.08 tons per year.

PERMITTEE:

Walt Disney World Company, Inc.

Permit Number: AC 48-108745

Expiration Date: April 1, 1986

SPECIFIC CONDITIONS:

3. There shall be no visible emissions, initially demonstrated in accordance with DER Method 9 (Rule 17-2.700(6)(a)9, FAC).
4. Allowable volatile organic compound emissions shall not exceed 0.49 pounds per hour or 0.53 tons per year.
5. The volatile organic compound content of all coatings and solvents used in this booth, demonstrated by manufacturer's specification or EPA Method 24, shall be submitted to the St. Johns River District office.
6. The use of all coatings and solvents shall be recorded daily and shall be submitted quarterly to the St. Johns River District office.
7. Stack temperature shall not exceed 350°F.
8. Compliance tests, in accordance with FAC Rule 17-2.700, shall be submitted to DER's St. Johns River District office within 45 days after completion of the tests.
9. Fifteen (15) days notification of the compliance tests to DER's St. Johns River District office is required.
10. After satisfactory completion of the initial compliance test and prior to ninety (90) days before the expiration of this permit, a complete application for an operating permit shall be submitted to the St. Johns River District office. The permittee may continue to operate in compliance with all terms of this construction permit until its expiration date or the issuance of an operating permit. The department may extend the expiration date of this construction permit as authorized by Rule 17-2.210(1), FAC.

Issued this 23rd day of Dec, 1985

STATE OF FLORIDA DEPARTMENT OF
ENVIRONMENTAL REGULATION

VICTORIA J. TSCHINKEL, Secretary

_____ pages attached.

State of Florida
DEPARTMENT OF ENVIRONMENTAL REGULATION



Interoffice Memorandum

FOR ROUTING TO OTHER THAN THE ADDRESSEE

To: _____ LOCTN: _____
To: _____ LOCTN: _____
To: _____ LOCTN: _____
FROM: _____ DATE: _____

TO: Victoria J. Tschinkel
FROM: Clair Fancy *CFD*
DATE: December 23, 1985
SUBJ: Approval of Attached Air Construction Permits

Attached for your approval and signature are six Air Construction Permits to Walt Disney World Company, Inc., to construct three paint shop spray booths, two staff shop spray booths and a water wash plastisol spray booth at their facility in Lake Buena Vista, Orange County, Florida.

Day 90, after which the permits would be issued by default, is December 25, 1986.

The Bureau recommends your approval and signature.

CF/pa

Attachment

The Orlando Sentinel

Published Daily
Orlando, Orange County, Florida

State of Florida) ss.
COUNTY OF ORANGE

Before the undersigned authority personally appeared
Catherine Deering

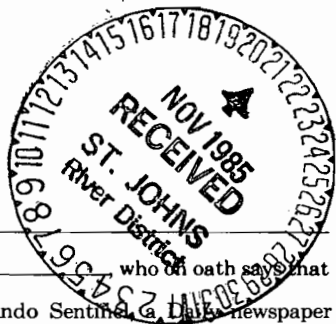

who on oath says that

she is the Legal Advertising Representative of the Orlando Sentinel, a Daily newspaper

published at Orlando, in Orange County, Florida; that the attached copy of advertisement, being a

Notice of Agency Action

Permit to Walt Disney World Company, Inc. in the matter of

in the _____ Court,

was published in said newspaper in the issues of _____

November 10, 1985

Affiant further says that the said Orlando Sentinel is a newspaper published at Orlando, in said Orange County, Florida, and that the said newspaper has heretofore been continuously published in said Orange County, Florida, each Week Day and has been entered as second-class mail matter at the post office in Orlando, in said Orange County, Florida for a period of one year next preceding the first publication of the attached copy of advertisement; and affiant further says that he/she has neither paid nor promised any person, firm or corporation any discount, rebate, commission or refund for the purpose of securing this advertisement for publication in the said newspaper.

Sworn to and subscribed before me this 18th day

of November 1985

A.D., 19

Virginia H. Hollingsworth

Notary Public, State of Florida at Large Notary Public

My Commission Expires July 13, 1989

Bonded Thru Brown & Brown, Inc. FORM NO. AD-262

DER
ADVERTISING CHARGE \$84.79

DEC 18 1985

BAQM

State of Florida
Department of Environmental
Regulation

Notice of Proposed Agency
Action on Permit Applications

The Department of Environmental Regulation gives notice of its intent to issue permits to Walt Disney World Company, Inc. for the construction of three paint shop spray booths, two staff shop spray booths and a water wash plastisol spray booth in the Central Facilities Shop building at the applicant's existing facility in Bay Lake, Orange County, Florida. A determination of best available control technology (BACT) was not required.

Persons whose substantial interests are affected by the Department's proposed permitting decision may petition for an administrative proceeding (hearing) in accordance with Section 120.57, Florida Statutes. The petition must conform to the requirements of Chapters 17-103 and 28-5, Florida Administrative Code, and must be filed (received) in the Office of General Counsel of the Department at 2600 Blair Stone Road, Twin Towers Office Building, Tallahassee, Florida 32301, within fourteen (14) days of publication of this notice. Failure to file a request for hearing within this time period constitutes a waiver of any right such person may have to request an administrative determination (hearing) under Section 120.57, Florida Statutes.

If a petition is filed, the administrative hearing process is designed to formulate agency action. Accordingly, the Department's final action may be different from the proposed agency action. Therefore, persons who may not wish to file a petition may wish to intervene in the proceeding. A petition for intervention must be filed pursuant to Model Rule 28-5.207, Florida Administrative Code, at least five (5) days before the final hearing and be filed with the hearing officer if one has been assigned at the Division of Administrative Hearings, Department of Administration, 2009 Apalachee Parkway, Tallahassee, Florida 32301. If no hearing officer has been assigned, the petition is to be filed with the department's Office of General Counsel, 2600 Blair Stone Road, Tallahassee, Florida 32301.

Failure to petition to intervene within the allowed time frame constitutes a waiver of any right such person has to request a hearing under Section 120.57, Florida Statutes.

The application is available for public inspection during normal business hours, 8:00 a.m. to 5:00 p.m., Monday through Friday, except legal holidays at:

Dept. of Environmental Regulation
St. Johns River District
3319 Maguire Blvd., Suite 232
Orlando, Florida 32803
Dept. of Environmental Regulation
Bureau of Air Quality Management
2600 Blair Stone Road
Tallahassee, Florida 32301

Any person may send written comments on the proposed action to Mr. Bill Thomas at the department's Tallahassee address. All comments mailed within 14 days of the publication of this notice will be considered in the department's final determination.

CL-67 Nov. 10, 1985

DEPARTMENT OF ENVIRONMENTAL REGULATION

**ROUTING AND
TRANSMITTAL SLIP**

ACTION NO

ACTION DUE DATE

1. TO: (NAME, OFFICE, LOCATION)

ED SVEC, BAQM, TALLY

Initial

Date

2.

Initial

Date

3.

Initial

Date

4.

Initial

Date

REMARKS:

*Attached is the original
notification of publication
you requested.*

INFORMATION

Review & Return

Review & File

Initial & Forward

DISPOSITION

Review & Respond

Prepare Response

For My Signature

For Your Signature

Let's Discuss

Set Up Meeting

Investigate & Report

Initial & Forward

Distribute

Concurrence

For Processing

Initial & Return

FROM:

Tom Sawicki

DATE

12/16/85

PHONE

SC 393-1408

PS Form 3811, July 1983

SENDER: Complete items 1, 2, 3 and 4.

Put your address in the "RETURN TO" space on the reverse side. Failure to do this will prevent this card from being returned to you. The return receipt fee will provide you the name of the person delivered to and the date of delivery. For additional fees the following services are available. Consult postmaster for fees and check box(es) for service(s) requested.

1. Show to whom, date and address of delivery.

2. Restricted Delivery.

3. Article Addressed to:
 Mr. Edward B. Crowell
 Walt Disney World Co., Inc.
 Post Office Box 40
 Lake Buena Vista, FL 32830

4. Type of Service: <input type="checkbox"/> Registered <input checked="" type="checkbox"/> Certified <input type="checkbox"/> Express Mail	Article Number <input type="checkbox"/> Insured <input type="checkbox"/> COD P 408 533 637
--	---

Always obtain signature of addressee or agent and **DATE DELIVERED.**

5. Signature - Addressee
 X

6. Signature - Agent
 X *[Signature]*

7. Date of Delivery
 11-4-85

8. Addressee's Address (ONLY if requested and fee paid)

DOMESTIC RETURN RECEIPT

P 408 533 637
 RECEIPT FOR CERTIFIED MAIL
 NO INSURANCE COVERAGE PROVIDED—
 NOT FOR INTERNATIONAL MAIL
 (See Reverse)

PS Form 3800, Feb. 1982

Sent to Mr. Edward B. Crowell	
Street and No.	
P.O., State and ZIP Code	
Postage	\$
Certified Fee	
Special Delivery Fee	
Restricted Delivery Fee	
Return Receipt Showing to whom and Date Delivered	
Return Receipt Showing to whom, Date, and Address of Delivery	
TOTAL Postage and Fees	\$
Postmark or Date 11/1/85	

STATE OF FLORIDA
DEPARTMENT OF ENVIRONMENTAL REGULATION

TWIN TOWERS OFFICE BUILDING
2600 BLAIR STONE ROAD
TALLAHASSEE, FLORIDA 32301-8241

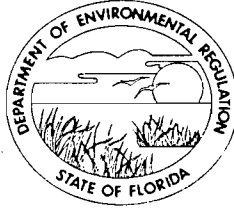

BOB GRAHAM
GOVERNOR
VICTORIA J. TSCHINKEL
SECRETARY

October 28, 1985

CERTIFIED MAIL-RETURN RECEIPT REQUESTED

Mr. Edward B. Crowell
Vice President Facilities Division
Walt Disney World Company, Inc.
Post Office Box 40
Lake Buena Vista, Florida 32830

Dear Mr. Crowell:

Attached is one copy of the Technical Evaluation and Preliminary Determination, and proposed permits to construct paint spray booths at your existing facility in Bay Lake, Orange County, Florida.

Before final action can be taken on your draft permits, you are required by Florida Administrative Code Rule 17-103.150 to publish the attached Notice of Proposed Agency Action in the legal advertising section of a newspaper of general circulation in Orange County no later than fourteen days after receipt of this letter. The department must be provided with proof of publication within seven days of the date the notice is published. Failure to publish the notice may be grounds for denial of the permits.

Please submit, in writing, any comments which you wish to have considered concerning the department's proposed action to Mr. Bill Thomas of the Bureau of Air Quality Management.

Sincerely,

C. H. Fandy, P.E.
Deputy Chief
Bureau of Air Quality
Management

CHF/pa

Attachments

cc: Ted W. McKim, P.E., Reedy Creek Utilities
Charles Collins, DER St. Johns River District

State of Florida
Department of Environmental Regulation
Notice of Proposed Agency Action
on Permit Applications

The Department of Environmental Regulation gives notice of its intent to issue permits to Walt Disney World Company, Inc. for the construction of three paint shop spray booths, two staff shop spray booths and a water wash plastisol spray booth in the Central Facilities Shop building at the applicant's existing facility in Bay Lake, Orange County, Florida. A determination of best available control technology (BACT) was not required.

Persons whose substantial interests are affected by the Department's proposed permitting decision may petition for an administrative proceeding (hearing) in accordance with Section 120.57, Florida Statutes. The petition must conform to the requirements of Chapters 17-103 and 28-5, Florida Administrative Code, and must be filed (received) in the Office of General Counsel of the Department at 2600 Blair Stone Road, Twin Towers Office Building, Tallahassee, Florida 32301, within fourteen (14) days of publication of this notice. Failure to file a request for hearing within this time period constitutes a waiver of any right such person may have to request an administrative determination (hearing) under Section 120.57, Florida Statutes.

If a petition is filed, the administrative hearing process is designed to formulate agency action. Accordingly, the Department's final action may be different from the proposed agency action. Therefore, persons who may not wish to file a petition may wish to intervene in the proceeding. A petition for intervention must be filed pursuant to Model Rule 28-5.207, Florida Administrative Code, at least five (5) days before the final hearing and be filed with the hearing officer if one has been assigned at the Division of Administrative Hearings, Department of Administration, 2009, Apalachee Parkway, Tallahassee, Florida 32301. If no hearing officer has been assigned, the petition is to be filed with the department's Office of General Counsel, 2600 Blair Stone Road, Tallahassee, Florida 32301. Failure to petition to intervene within the allowed time frame constitutes a waiver of any right such person has to request a hearing under Section 120.57, Florida Statutes.

The application is available for public inspection during normal business hours, 8:00 a.m. to 5:00 p.m., Monday through Friday, except legal holidays, at:

Dept. of Environmental Regulation
St. Johns River District
3319 Maguire Blvd., Suite 232
Orlando, Florida 32803

Dept. of Environmental Regulation
Bureau of Air Quality Management
2600 Blair Stone Road
Tallahassee, Florida 32301

Any person may send written comments on the proposed action to Mr. Bill Thomas at the department's Tallahassee address. All comments mailed within 14 days of the publication of this notice will be considered in the department's final determination.

BEFORE THE STATE OF FLORIDA
DEPARTMENT OF ENVIRONMENTAL REGULATION

In the Matter of)	DER File No.	AC 48-108740
Application for Permits by:)		AC 48-108741
)		AC 48-108742
Walt Disney World Company, Inc.)		AC 48-108743
Post Office Box 40)		AC 48-108744
Lake Buena Vista, Florida 32830)		AC 48-108745

INTENT TO ISSUE

The Department of Environmental Regulation hereby gives notice of its Intent to Issue, and proposed order of issuance for, a permit pursuant to Chapter 403, Florida Statutes, for the proposed project as detailed in the application specified above. The Department is issuing this Intent to Issue for the reasons stated in the attached Technical Evaluation and Preliminary Determination.

The applicant, Walt Disney World Company, Inc. applied on August 16, 1985 to DER for permits to construct three paint shop spray booths, two staff shop spray booths and a water wash plastisol booth at the applicant's facility in Bay Lake, Orange County, Florida.

The Department has permitting jurisdiction under Chapter 403, Florida Statutes and Florida Administrative Code Rules 17-2 and 17-4. The project is not exempt from permitting procedures. The applicant was officially notified by the Department that an air construction permit was required for the proposed work.

This intent to issue shall be placed before the Secretary for final action unless an appropriate petition for a hearing pursuant to the provisions of Section 120.57, Florida Statutes, is filed within fourteen (14) days from receipt of this letter or

publication of the public notice (copy attached) required pursuant to Rule 17-103.150, Florida Administrative Code, whichever occurs first. The petition must comply with the requirements of Section 17-103.155 and Rule 28-5.201, Florida Administrative Code (copy attached) and be filed pursuant to Rule 17-103.155(1) in the Office of General Counsel of the Department of Environmental Regulation at 2600 Blair Stone Road, Tallahassee, Florida 32301.

Petitions which are not filed in accordance with the above provisions are subject to dismissal by the Department. In the event a formal hearing is conducted pursuant to Section 120.57(1), all parties shall have an opportunity to respond, to present evidence and argument on all issues involved, to conduct cross-examination of witnesses and submit rebuttal evidence, to submit proposed findings of facts and orders, to file exceptions to any order or hearing officer's recommended order, and to be represented by counsel. If an informal hearing is requested, the agency, in accordance with its rules of procedure, will provide affected persons or parties or their counsel an opportunity, at a convenient time and place, to present to the agency or hearing officer, written or oral evidence in opposition to the agency's action or refusal to act, or a written statement challenging the grounds upon which the agency has chosen to justify its action or inaction, pursuant to Section 120.57(2), Florida Statutes.

If a petition is filed, the administrative hearing process is designed to formulate agency action. Accordingly, the Department's final action may be different from the proposed agency action. Therefore, persons who may not wish to file a petition, may wish to intervene in the proceeding. A petition for intervention must be filed pursuant to Model Rule 28-5.207 at least five (5) days before the final hearing and be filed with the hearing officer if one has been assigned at the Division of

Administrative Hearings, 2009 Apalachee Parkway, Tallahassee, Florida 32301. If no hearing officer has been assigned, the petition is to be filed with the Department's Office of General Counsel, 2600 Blair Stone Road, Tallahassee, Florida 32301. Failure to petition to intervene within the allowed time frame constitutes a waiver of any right such person has to request a hearing under Section 120.57, Florida Statutes.

Executed the 29 day of OCT, 1985, in Tallahassee, Florida.

STATE OF FLORIDA DEPARTMENT
OF ENVIRONMENTAL REGULATION

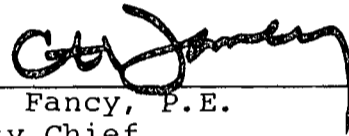

C. H. Fancy, P.E.
Deputy Chief
Bureau of Air Quality
Management

Copies furnished to:

Mr. Edward B. Crowell, Walt Disney World Company, Inc.
Mr. Ted W. McKim, P.E., Reedy Creek Utilities Co., Inc.
Mr. Charles Collins, DER St. Johns River District

CERTIFICATION

This is to certify that the foregoing Intent to Issue and all copies were mailed before the close of business on Nov. 1, 1985.

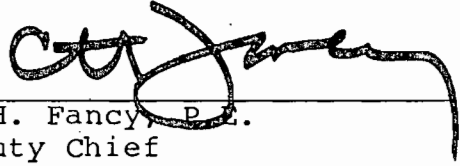

C. H. Fancy, P. E.
Deputy Chief
Bureau of Air Quality
Management
2600 Blair Stone Road
Tallahassee, Florida 32301

FILING AND ACKNOWLEDGEMENT
FILED, on this date, pursuant to
§120.52(9), Florida Statutes, with
the designated Department Clerk,
receipt of which is hereby acknow-
ledged.

Patricia G. Adams Nov. 1, 1985
Clerk Date

RULES OF THE ADMINISTRATIVE COMMISSION
MODEL RULES OF PROCEDURE
CHAPTER 28-5
DECISIONS DETERMINING SUBSTANTIAL INTERESTS

28-5.15 Requests for Formal and Informal Proceedings

- (1) Requests for proceedings shall be made by petition to the agency involved. Each petition shall be printed typewritten or otherwise duplicated in legible form on white paper of standard legal size. Unless printed, the impression shall be on one side of the paper only and lines shall be double spaced and indented.
- (2) All petitions filed under these rules should contain:
 - (a) The name and address of each agency affected and each agency's file or identification number, if known;
 - (b) The name and address of the petitioner or petitioners;
 - (c) All disputed issues of material fact. If there are none, the petition must so indicate;
 - (d) A concise statement of the ultimate facts alleged, and the rules, regulations and constitutional provisions which entitle the petitioner to relief;
 - (e) A statement summarizing any informal action taken to resolve the issues, and the results of that action;
 - (f) A demand for the relief to which the petitioner deems himself entitled; and
 - (g) Such other information which the petitioner contends is material.

Technical Evaluation
and
Preliminary Determination

Walt Disney World Company, Inc.
Orange County
Lake Buena Vista, Florida

NSA Paint Shop Paint Booths 1, 2, 3; NSA Staff Shop
Spray Booths 1 and 2; Water Wash Plastisol Booth Number 1

Permit Numbers AC 48-108740
AC 48-108741
AC 48-108742
AC 48-108743
AC 48-108744
AC 48-108745

Florida Department of Environmental Regulation
Bureau of Air Quality Management
Central Air Permitting

October 25, 1985

I. Project Description

A. Applicant

Walt Disney World Company, Inc.
Post Office Box 40
Lake Buena Vista, Florida 32830

B. Project and Location

The applicant proposes to construct three (3) paint shop spray booths, two (2) staff shop spray booths and a water wash plastisol spray booth. These booths will be constructed in the Central Facilities Shop building. The building is located in the applicant's existing facility at Facilities Way, Orange County, Bay Lake, Florida. The Universal Transverse Mercator (UTM) coordinates of the source are zone 17, 443.5 km East and 3144.3 km North.

C. Process and Controls

The proposed spray booths will service Walt Disney World's theme park, hotels, camp grounds and shops.

NSA Paint Shop Paint Booth No. 1 will coat a variety of objects including vehicles, wooden furniture, trash cans, ride components, posts and frames using two part polyurethane, two part acrylic, epoxy primers and other primer coating systems. The booth will be equipped with two Binks model 30-4313 exhaust fans, each rated at 18,029 SCFM at 1/4 inch WC static pressure, and Binks model 29-893 paint arrestor type filters which are 95% efficient for particulate. There is no proposed add on pollution control equipment for volatile organic compounds (VOC) emissions from this booth.

NSA Paint Shop Paint Spray Booth No. 2 and No. 3 will be coating the same variety of objects and will be using the same coatings as the NSA Paint Shop Paint Spray Booth No. 1. Each booth will be equipped with two Binks model 30-4418 exhaust fans, each rated at 48,500 SCFM at 1/4 inch WC static pressure, and Binks model 29-893 paint arrestor type filters which are 95% efficient for particulate. There is no proposed add on control equipment for VOC emissions from either of these booths.

NSA Staff Shop Spray Booth No. 1 will be used for spraying polyester resin systems, lacquer based primers and sealers and polyvinyl alcohol on fiberglass objects and molds. A Binks model PFF type spray booth with model 30-800 exhaust fans rated at 24,800 SCFM will be used. The particulate filters for the booth have an efficiency of 80% for lacquers and 95% for two part high particulate coating systems. There is no proposed add on control equipment for VOC emissions from this booth.

NSA Staff Shop Spray Booth No. 2 will be used for spraying fiberglass molds and objects with polyester resin systems, lacquer based primers and polyvinyl alcohol. This built-in spray booth will be equipped with a New York blower model 548-1 rated at 29,000 CFM and particulate filters with an efficiency of 80% when used with lacquers and 95% when used with two part high particulate coating systems. There is no proposed add on control equipment for VOC emissions from this booth.

The Water Wash Plastisol Booth No. 1 will consist of a spray booth and curing oven. The spray booth will be a Binks water wash spray booth equipped with a 16,800 SCFM fan, at 4.2 inches WC static pressure, and a nopump dyna-precipitator water wash filtering system that will be 98% efficient for particulate. The curing oven will be equipped with a 3,000 DSCFM rated fan. The oven is fired by natural gas with an exit stack temperature of 350°F. There is no proposed add on control equipment for VOC emissions from this spray booth or curing oven.

D. Sources Reviewed

This application has been submitted for:

<u>Source</u>	<u>Permit Number</u>
NSA Paint Spray Booth No. 1	AC 48-108740
NSA Paint Spray Booth No. 2	AC 48-108741
NSA Paint Spray Booth No. 3	AC 48-108742
NSA Staff Shop Booth No. 1	AC 48-108743
NSA Staff Shop Booth No. 2	AC 48-108744
Water Wash Plastisol Booth No. 1	AC 48-108745

E. Standard Industrial Classification Code (SIC)

The facility is classified as:

Major Group No. 359; Miscellaneous Machinery, Except Electrical

Industrial No. 3599; Machinery, Except Electrical, Not Elsewhere Classified

F. Facility Category

Walt Disney World Company, Inc. is classified as a major emitting facility for the air pollutants nitrogen oxides, sulfur dioxide, and carbon monoxide.

G. Application Completeness Date

(i) Application received: August 16, 1985

(ii) Application deemed complete: August 21, 1985

II. Rule Applicability

The proposed project is located in Orange County which is designated as a nonattainment area for the air pollutant ozone, FAC Rule 17-2.410, and as an attainment area for the air pollutant particulate matter, FAC Rule 17-2.420(2).

Prevention of Significant Deterioration, FAC Rule 17-2.500, will not apply to this proposed project because the total allowable emissions increase of particulate matter is 1.20 tons per year. This is below the PSD significant emission rate of 25 tons per year, FAC Rule 17-2.500, Table 500-2.

The project will not be subject to the New Source Review for Nonattainment Areas standards of FAC Rule 17-2.510 for volatile organic compounds because the VOC emissions are below the significant level. Also, there are no applicable RACT emission limiting standards for this application. However, the general pollutant emission limiting standards of FAC Rule 17-2.620 will apply to this project.

III. Summary of Emissions and Air Quality Analysis

A. Emission Limitations

The pollutants emitted from the proposed sources are particulate matter and volatile organic compounds. Particulate matter is generated from overspray of the applied coatings. Volatile organic compounds are released when the solvents in the applied coatings evaporate. These emissions are summarized as follows:

	Volatile Organic Compounds (ton/yr)	Particulate (ton/yr)	
		Uncontrolled	Actual
NSA Paint Shop No. 1	2.82	3.81	0.19
NSA Paint Shop No. 2	5.65	7.62	0.38
NSA Paint Shop No. 3	5.65	7.62	0.38
NSA Staff Shop No. 1	0.08	0.29	0.02
NSA Staff Shop No. 2	0.63	2.60	0.16
Plastisol Booth No.1	0.53	3.65	0.08
Total	15.36	25.59	1.21

B. Air Quality Analysis

Since the increase of emissions is exempted from the requirements of FAC Rule 17-2.500, Prevention of Significant Deterioration, an ambient air quality analysis is not required.

IV. Conclusion

The emission limits that will be imposed have been determined to be in compliance with all applicable requirements of FAC 17-2. The permitted maximum allowable emission limits should not cause any violation of Florida's ambient air quality standards.

The general and specific conditions listed in the proposed construction permits (attached) will assure compliance with all applicable requirements of FAC 17-2.

STATE OF FLORIDA
DEPARTMENT OF ENVIRONMENTAL REGULATION

TWIN TOWERS OFFICE BUILDING
2600 BLAIR STONE ROAD
TALLAHASSEE, FLORIDA 32301-8241

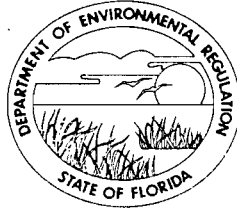

BOB GRAHAM
GOVERNOR
VICTORIA J. TSCHINKEL
SECRETARY

PERMITTEE: Permit Number: AC 48-108740
Walt Disney World Company, Inc. Expiration Date: April 1, 1986
Post Office Box 40 County: Orange
Lake Buena Vista, Florida 32830 Latitude/Longitude: 28° 25' 32"N/
81° 34' 36"W
Project: NSA Paint Spray Booth No. 1

This permit is issued under the provisions of Chapters 403, Florida Statutes, and Florida Administrative Code Rule(s) 17-2 and 17-4. The above named permittee is hereby authorized to perform the work or operate the facility shown on the application and approved drawings, plans, and other documents attached hereto or on file with the department and made a part hereof and specifically described as follows:

For the construction of a spray booth which will be used to coat a variety of objects including vehicles, wooden furniture, trash cans, ride components, posts and frames using two part polyurethane, two part acrylic, epoxy primers and other primer coating systems. The booth will be equipped with two Binks model 30-4313 exhaust fans and Binks model 29-893 paint arrestor type filters.

Construction shall be in accordance with the attached permit application and additional information except as otherwise noted on pages 5 and 6, specific conditions.

Attachments are as follows:

1. Applications to construct an Air Pollution Source, DER form 17-1.202(1).

PERMITTEE:
Walt Disney World Company, Inc.

Permit Number: AC 48-108740
Expiration Date: April 1, 1986

GENERAL CONDITIONS:

1. The terms, conditions, requirements, limitations, and restrictions set forth herein are "Permit Conditions" and as such are binding upon the permittee and enforceable pursuant to the authority of Sections 403.161, 403.727, or 403.859 through 403.861, Florida Statutes. The permittee is hereby placed on notice that the department will review this permit periodically and may initiate enforcement action for any violation of the "Permit Conditions" by the permittee, its agents, employees, servants or representatives.
2. This permit is valid only for the specific processes and operations applied for and indicated in the approved drawings or exhibits. Any unauthorized deviation from the approved drawings, exhibits, specifications, or conditions of this permit may constitute grounds for revocation and enforcement action by the department.
3. As provided in Subsections 403.087(6) and 403.722(5), Florida Statutes, the issuance of this permit does not convey any vested rights or any exclusive privileges. Nor does it authorize any injury to public or private property or any invasion of personal rights, nor any infringement of federal, state or local laws or regulations. This permit does not constitute a waiver of or approval of any other department permit that may be required for other aspects of the total project which are not addressed in the permit.
4. This permit conveys no title to land or water, does not constitute state recognition or acknowledgement of title, and does not constitute authority for the use of submerged lands unless herein provided and the necessary title or leasehold interests have been obtained from the state. Only the Trustees of the Internal Improvement Trust Fund may express state opinion as to title.
5. This permit does not relieve the permittee from liability for harm or injury to human health or welfare, animal, plant or aquatic life or property and penalties therefore caused by the construction or operation of this permitted source, nor does it allow the permittee to cause pollution in contravention of Florida Statutes and department rules, unless specifically authorized by an order from the department.

PERMITTEE: Permit Number: AC 48-108740
Walt Disney World Company, Inc. Expiration Date: April 1, 1986

GENERAL CONDITIONS:

6. The permittee shall at all times properly operate and maintain the facility and systems of treatment and control (and related appurtenances) that are installed or used by the permittee to achieve compliance with the conditions of this permit, as required by department rules. This provision includes the operation of backup or auxiliary facilities or similar systems when necessary to achieve compliance with the conditions of the permit and when required by department rules.
7. The permittee, by accepting this permit, specifically agrees to allow authorized department personnel, upon presentation of credentials or other documents as may be required by law, access to the premises, at reasonable times, where the permitted activity is located or conducted for the purpose of:
 - a. Having access to and copying any records that must be kept under the conditions of the permit;
 - b. Inspecting the facility, equipment, practices, or operations regulated or required under this permit; and
 - c. Sampling or monitoring any substances or parameters at any location reasonably necessary to assure compliance with this permit or department rules.

Reasonable time may depend on the nature of the concern being investigated.

8. If, for any reason, the permittee does not comply with or will be unable to comply with any condition or limitation specified in this permit, the permittee shall immediately notify and provide the department with the following information:
 - a. a description of and cause of non-compliance; and
 - b. the period of noncompliance, including exact dates and times; or, if not corrected, the anticipated time the noncompliance is expected to continue, and steps being taken to reduce, eliminate, and prevent recurrence of the noncompliance.

PERMITTEE: Permit Number: AC 48-108740
Walt Disney World Company, Inc. Expiration Date: April 1, 1986

GENERAL CONDITIONS:

The permittee shall be responsible for any and all damages which may result and may be subject to enforcement action by the department for penalties or revocation of this permit.

9. In accepting this permit, the permittee understands and agrees that all records, notes, monitoring data and other information relating to the construction or operation of this permitted source, which are submitted to the department, may be used by the department as evidence in any enforcement case arising under the Florida Statutes or department rules, except where such use is proscribed by Sections 403.73 and 403.111, Florida Statutes.
10. The permittee agrees to comply with changes in department rules and Florida Statutes after a reasonable time for compliance, provided however, the permittee does not waive any other rights granted by Florida Statutes or department rules.
11. This permit is transferable only upon department approval in accordance with Florida Administrative Code Rules 17-4.12 and 17-30.30, as applicable. The permittee shall be liable for any non-compliance of the permitted activity until the transfer is approved by the department.
12. This permit is required to be kept at the work site of the permitted activity during the entire period of construction or operation.
13. This permit also constitutes:
 - () Determination of Best Available Control Technology (BACT)
 - () Determination of Prevention of Significant Deterioration (PSD)
 - () Compliance with New Source Performance Standards.
14. The permittee shall comply with the following monitoring and record keeping requirements:
 - a. Upon request, the permittee shall furnish all records and plans required under department rules. The retention period for all records will be extended automatically, unless otherwise stipulated by the department, during the course of any unresolved enforcement action.

PERMITTEE: Permit Number: AC 48-108740
Walt Disney World Company, Inc. Expiration Date: April 1, 1986

GENERAL CONDITIONS:

- b. The permittee shall retain at the facility or other location designated by this permit records of all monitoring information (including all calibration and maintenance records and all original strip chart recordings for continuous monitoring instrumentation), copies of all reports required by this permit, and records of all data used to complete the application for this permit. The time period of retention shall be at least three years from the date of the sample, measurement, report or application unless otherwise specified by department rule.
 - c. Records of monitoring information shall include:
 - the date, exact place, and time of sampling or measurements;
 - the person responsible for performing the sampling or measurements;
 - the date(s) analyses were performed;
 - the person responsible for performing the analyses;
 - the analytical techniques or methods used; and
 - the results of such analyses.
15. When requested by the department, the permittee shall within a reasonable time furnish any information required by law which is needed to determine compliance with the permit. If the permittee becomes aware that relevant facts were not submitted or were incorrect in the permit application or in any report to the department, such facts or information shall be submitted or corrected promptly.

SPECIFIC CONDITIONS:

1. The hours of operation shall not exceed 4160 hours per year.
2. The allowable particulate emission rate shall not exceed .125 pounds per hour or 0.19 tons per year.

PERMITTEE:
Walt Disney World Company, Inc.

Permit Number: AC 48-108740
Expiration Date: April 1, 1986

SPECIFIC CONDITIONS:

3. There shall be no visible emissions, initially demonstrated in accordance with DER Method 9 (Rule 17-2.700(6)(a)9, FAC).
4. Allowable volatile organic compound emissions shall not exceed 0.89 pounds per hour or 2.82 tons per year.
5. The volatile organic compound content of all coatings and solvents used in this booth, demonstrated by manufacturer's specification or EPA Method 24, shall be submitted to the St. Johns River District office.
6. The use of all coatings and solvents shall be recorded daily and shall be submitted quarterly to the St. Johns River District office.
7. Compliance tests, in accordance with FAC Rule 17-2.700, shall be submitted to DER's St. Johns River District office within 45 days after completion of the tests.
8. Fifteen (15) days notification of the compliance tests to DER's St. Johns River District office is required.
9. After satisfactory completion of the initial compliance test and prior to ninety (90) days before the expiration of this permit, a complete application for an operating permit shall be submitted to the St. Johns River District office. The permittee may continue to operate in compliance with all terms of this construction permit until its expiration date or the issuance of an operating permit. The department may extend the expiration date of this construction permit as authorized by Rule 17-2.210(1), FAC.

Issued this _____ day of _____, 19____

STATE OF FLORIDA DEPARTMENT OF
ENVIRONMENTAL REGULATION

VICTORIA J. TSCHINKEL, Secretary

_____page attached.

STATE OF FLORIDA
DEPARTMENT OF ENVIRONMENTAL REGULATION

TWIN TOWERS OFFICE BUILDING
2600 BLAIR STONE ROAD
TALLAHASSEE, FLORIDA 32301-8241



BOB GRAHAM
GOVERNOR
VICTORIA J. TSCHINKEL
SECRETARY

PERMITTEE: Permit Number: AC 48-108741
Walt Disney World Company, Inc. Expiration Date: April 1, 1986
Post Office Box 40 County: Orange
Lake Buena Vista, Florida 32830 Latitude/Longitude: 28° 25' 32"N/
81° 34' 36"W
Project: NSA Paint Spray Booth No. 2

This permit is issued under the provisions of Chapters 403, Florida Statutes, and Florida Administrative Code Rule(s) 17-2 and 17-4. The above named permittee is hereby authorized to perform the work or operate the facility shown on the application and approved drawings, plans, and other documents attached hereto or on file with the department and made a part hereof and specifically described as follows:

For the construction of a spray booth which will be used to coat a variety of objects including vehicles, wooden furniture, trash cans, ride components, posts and frames using two part polyurethane, two part acrylic, epoxy primers and other primer coating systems. The booth will be equipped with two Binks model 30-4418 exhaust fans and Binks model 29-893 paint arrestor type filters.

Construction shall be in accordance with the attached permit application and additional information except as otherwise noted on pages 5 and 6, specific conditions.

Attachments are as follows:

1. Applications to construct an Air Pollution Source, DER form 17-1.202(1).

PERMITTEE: Permit Number: AC 48-108741
Walt Disney World Company, Inc. Expiration Date: April 1, 1986

GENERAL CONDITIONS:

1. The terms, conditions, requirements, limitations, and restrictions set forth herein are "Permit Conditions" and as such are binding upon the permittee and enforceable pursuant to the authority of Sections 403.161, 403.727, or 403.859 through 403.861, Florida Statutes. The permittee is hereby placed on notice that the department will review this permit periodically and may initiate enforcement action for any violation of the "Permit Conditions" by the permittee, its agents, employees, servants or representatives.
2. This permit is valid only for the specific processes and operations applied for and indicated in the approved drawings or exhibits. Any unauthorized deviation from the approved drawings, exhibits, specifications, or conditions of this permit may constitute grounds for revocation and enforcement action by the department.
3. As provided in Subsections 403.087(6) and 403.722(5), Florida Statutes, the issuance of this permit does not convey any vested rights or any exclusive privileges. Nor does it authorize any injury to public or private property or any invasion of personal rights, nor any infringement of federal, state or local laws or regulations. This permit does not constitute a waiver of or approval of any other department permit that may be required for other aspects of the total project which are not addressed in the permit.
4. This permit conveys no title to land or water, does not constitute state recognition or acknowledgement of title, and does not constitute authority for the use of submerged lands unless herein provided and the necessary title or leasehold interests have been obtained from the state. Only the Trustees of the Internal Improvement Trust Fund may express state opinion as to title.
5. This permit does not relieve the permittee from liability for harm or injury to human health or welfare, animal, plant or aquatic life or property and penalties therefore caused by the construction or operation of this permitted source, nor does it allow the permittee to cause pollution in contravention of Florida Statutes and department rules, unless specifically authorized by an order from the department.

PERMITTEE: Permit Number: AC 48-108741
Walt Disney World Company, Inc. Expiration Date: April 1, 1986

GENERAL CONDITIONS:

6. The permittee shall at all times properly operate and maintain the facility and systems of treatment and control (and related appurtenances) that are installed or used by the permittee to achieve compliance with the conditions of this permit, as required by department rules. This provision includes the operation of backup or auxiliary facilities or similar systems when necessary to achieve compliance with the conditions of the permit and when required by department rules.
7. The permittee, by accepting this permit, specifically agrees to allow authorized department personnel, upon presentation of credentials or other documents as may be required by law, access to the premises, at reasonable times, where the permitted activity is located or conducted for the purpose of:
 - a. Having access to and copying any records that must be kept under the conditions of the permit;
 - b. Inspecting the facility, equipment, practices, or operations regulated or required under this permit; and
 - c. Sampling or monitoring any substances or parameters at any location reasonably necessary to assure compliance with this permit or department rules.

Reasonable time may depend on the nature of the concern being investigated.

8. If, for any reason, the permittee does not comply with or will be unable to comply with any condition or limitation specified in this permit, the permittee shall immediately notify and provide the department with the following information:
 - a. a description of and cause of non-compliance; and
 - b. the period of noncompliance, including exact dates and times; or, if not corrected, the anticipated time the noncompliance is expected to continue, and steps being taken to reduce, eliminate, and prevent recurrence of the noncompliance.

PERMITTEE: Permit Number: AC 48-108741
Walt Disney World Company, Inc. Expiration Date: April 1, 1986

GENERAL CONDITIONS:

The permittee shall be responsible for any and all damages which may result and may be subject to enforcement action by the department for penalties or revocation of this permit.

9. In accepting this permit, the permittee understands and agrees that all records, notes, monitoring data and other information relating to the construction or operation of this permitted source, which are submitted to the department, may be used by the department as evidence in any enforcement case arising under the Florida Statutes or department rules, except where such use is proscribed by Sections 403.73 and 403.111, Florida Statutes.
10. The permittee agrees to comply with changes in department rules and Florida Statutes after a reasonable time for compliance, provided however, the permittee does not waive any other rights granted by Florida Statutes or department rules.
11. This permit is transferable only upon department approval in accordance with Florida Administrative Code Rules 17-4.12 and 17-30.30, as applicable. The permittee shall be liable for any non-compliance of the permitted activity until the transfer is approved by the department.
12. This permit is required to be kept at the work site of the permitted activity during the entire period of construction or operation.
13. This permit also constitutes:
 - () Determination of Best Available Control Technology (BACT)
 - () Determination of Prevention of Significant Deterioration (PSD)
 - () Compliance with New Source Performance Standards.
14. The permittee shall comply with the following monitoring and record keeping requirements:
 - a. Upon request, the permittee shall furnish all records and plans required under department rules. The retention period for all records will be extended automatically, unless otherwise stipulated by the department, during the course of any unresolved enforcement action.

PERMITTEE: Permit Number: AC 48-108741
Walt Disney World Company, Inc. Expiration Date: April 1, 1986

GENERAL CONDITIONS:

- b. The permittee shall retain at the facility or other location designated by this permit records of all monitoring information (including all calibration and maintenance records and all original strip chart recordings for continuous monitoring instrumentation), copies of all reports required by this permit, and records of all data used to complete the application for this permit. The time period of retention shall be at least three years from the date of the sample, measurement, report or application unless otherwise specified by department rule.
 - c. Records of monitoring information shall include:
 - the date, exact place, and time of sampling or measurements;
 - the person responsible for performing the sampling or measurements;
 - the date(s) analyses were performed;
 - the person responsible for performing the analyses;
 - the analytical techniques or methods used; and
 - the results of such analyses.
15. When requested by the department, the permittee shall within a reasonable time furnish any information required by law which is needed to determine compliance with the permit. If the permittee becomes aware that relevant facts were not submitted or were incorrect in the permit application or in any report to the department, such facts or information shall be submitted or corrected promptly.

SPECIFIC CONDITIONS:

- 1. The hours of operation shall not exceed 4160 hours per year.
- 2. The allowable particulate emission rate shall not exceed 0.250 pounds per hour or 0.38 tons per year.

PERMITTEE: Permit Number: AC 48-108741
Walt Disney World Company, Inc. Expiration Date: April 1, 1986

SPECIFIC CONDITIONS:

3. There shall be no visible emissions, initially demonstrated in accordance with DER Method 9 (Rule 17-2.700(6)(a)9, FAC).
4. Allowable volatile organic compound emissions shall not exceed 1.77 pounds per hour or 5.65 tons per year.
5. The volatile organic compound content of all coatings and solvents used in this booth, demonstrated by manufacturer's specification or EPA Method 24, shall be submitted to the St. Johns River District office.
6. The use of all coatings and solvents shall be recorded daily and shall be submitted quarterly to the St. Johns River District office.
7. Compliance tests, in accordance with FAC Rule 17-2.700, shall be submitted to DER's St. Johns River District office within 45 days after completion of the tests.
8. Fifteen (15) days notification of the compliance tests to DER's St. Johns River District office is required.
9. After satisfactory completion of the initial compliance test and prior to ninety (90) days before the expiration of this permit, a complete application for an operating permit shall be submitted to the St. Johns River District office. The permittee may continue to operate in compliance with all terms of this construction permit until its expiration date or the issuance of an operating permit. The department may extend the expiration date of this construction permit as authorized by Rule 17-2.210(1), FAC.

Issued this _____ day of _____, 19____

STATE OF FLORIDA DEPARTMENT OF
ENVIRONMENTAL REGULATION

VICTORIA J. TSCHINKEL, Secretary

_____page attached.

STATE OF FLORIDA
DEPARTMENT OF ENVIRONMENTAL REGULATION

TWIN TOWERS OFFICE BUILDING
2600 BLAIR STONE ROAD
TALLAHASSEE, FLORIDA 32301-8241



BOB GRAHAM
GOVERNOR
VICTORIA J. TSCHINKEL
SECRETARY

PERMITTEE: Permit Number: AC 48-108742
Walt Disney World Company, Inc. Expiration Date: April 1, 1986
Post Office Box 40 County: Orange
Lake Buena Vista, Florida 32830 Latitude/Longitude: 28° 25' 32"N/
81° 34' 36"W
Project: NSA Paint Spray Booth No. 3

This permit is issued under the provisions of Chapters 403, Florida Statutes, and Florida Administrative Code Rule(s) 17-2 and 17-4. The above named permittee is hereby authorized to perform the work or operate the facility shown on the application and approved drawings, plans, and other documents attached hereto or on file with the department and made a part hereof and specifically described as follows:

For the construction of a spray booth which will be used to coat a variety of objects including vehicles, wooden furniture, trash cans, ride components, posts and frames using two part polyurethane, two part acrylic, epoxy primers and other primer coating systems. The booth will be equipped with two Binks model 30-4418 exhaust fans and Binks model 29-893 paint arrestor type filters.

Construction shall be in accordance with the attached permit application and additional information except as otherwise noted on pages 5 and 6, specific conditions.

Attachments are as follows:

1. Applications to construct an Air Pollution Source, DER form 17-1.202(1).

PERMITTEE:
Walt Disney World Company, Inc.

Permit Number: AC 48-108742
Expiration Date: April 1, 1986

GENERAL CONDITIONS:

1. The terms, conditions, requirements, limitations, and restrictions set forth herein are "Permit Conditions" and as such are binding upon the permittee and enforceable pursuant to the authority of Sections 403.161, 403.727, or 403.859 through 403.861, Florida Statutes. The permittee is hereby placed on notice that the department will review this permit periodically and may initiate enforcement action for any violation of the "Permit Conditions" by the permittee, its agents, employees, servants or representatives.
2. This permit is valid only for the specific processes and operations applied for and indicated in the approved drawings or exhibits. Any unauthorized deviation from the approved drawings, exhibits, specifications, or conditions of this permit may constitute grounds for revocation and enforcement action by the department.
3. As provided in Subsections 403.087(6) and 403.722(5), Florida Statutes, the issuance of this permit does not convey any vested rights or any exclusive privileges. Nor does it authorize any injury to public or private property or any invasion of personal rights, nor any infringement of federal, state or local laws or regulations. This permit does not constitute a waiver of or approval of any other department permit that may be required for other aspects of the total project which are not addressed in the permit.
4. This permit conveys no title to land or water, does not constitute state recognition or acknowledgement of title, and does not constitute authority for the use of submerged lands unless herein provided and the necessary title or leasehold interests have been obtained from the state. Only the Trustees of the Internal Improvement Trust Fund may express state opinion as to title.
5. This permit does not relieve the permittee from liability for harm or injury to human health or welfare, animal, plant or aquatic life or property and penalties therefore caused by the construction or operation of this permitted source, nor does it allow the permittee to cause pollution in contravention of Florida Statutes and department rules, unless specifically authorized by an order from the department.

PERMITTEE: Permit Number: AC 48-10.742
Walt Disney World Company, Inc. Expiration Date: April 1, 1986

GENERAL CONDITIONS:

6. The permittee shall at all times properly operate and maintain the facility and systems of treatment and control (and related appurtenances) that are installed or used by the permittee to achieve compliance with the conditions of this permit, as required by department rules. This provision includes the operation of backup or auxiliary facilities or similar systems when necessary to achieve compliance with the conditions of the permit and when required by department rules.
7. The permittee, by accepting this permit, specifically agrees to allow authorized department personnel, upon presentation of credentials or other documents as may be required by law, access to the premises, at reasonable times, where the permitted activity is located or conducted for the purpose of:
 - a. Having access to and copying any records that must be kept under the conditions of the permit;
 - b. Inspecting the facility, equipment, practices, or operations regulated or required under this permit; and
 - c. Sampling or monitoring any substances or parameters at any location reasonably necessary to assure compliance with this permit or department rules.

Reasonable time may depend on the nature of the concern being investigated.

8. If, for any reason, the permittee does not comply with or will be unable to comply with any condition or limitation specified in this permit, the permittee shall immediately notify and provide the department with the following information:
 - a. a description of and cause of non-compliance; and
 - b. the period of noncompliance, including exact dates and times; or, if not corrected, the anticipated time the noncompliance is expected to continue, and steps being taken to reduce, eliminate, and prevent recurrence of the noncompliance.

PERMITTEE: Permit Number: AC 48-108742
Walt Disney World Company, Inc. Expiration Date: April 1, 1986

GENERAL CONDITIONS:

The permittee shall be responsible for any and all damages which may result and may be subject to enforcement action by the department for penalties or revocation of this permit.

9. In accepting this permit, the permittee understands and agrees that all records, notes, monitoring data and other information relating to the construction or operation of this permitted source, which are submitted to the department, may be used by the department as evidence in any enforcement case arising under the Florida Statutes or department rules, except where such use is proscribed by Sections 403.73 and 403.111, Florida Statutes.
10. The permittee agrees to comply with changes in department rules and Florida Statutes after a reasonable time for compliance, provided however, the permittee does not waive any other rights granted by Florida Statutes or department rules.
11. This permit is transferable only upon department approval in accordance with Florida Administrative Code Rules 17-4.12 and 17-30.30, as applicable. The permittee shall be liable for any non-compliance of the permitted activity until the transfer is approved by the department.
12. This permit is required to be kept at the work site of the permitted activity during the entire period of construction or operation.
13. This permit also constitutes:
 - () Determination of Best Available Control Technology (BACT)
 - () Determination of Prevention of Significant Deterioration (PSD)
 - () Compliance with New Source Performance Standards.
14. The permittee shall comply with the following monitoring and record keeping requirements:
 - a. Upon request, the permittee shall furnish all records and plans required under department rules. The retention period for all records will be extended automatically, unless otherwise stipulated by the department, during the course of any unresolved enforcement action.

PERMITTEE:

Walt Disney World Company, Inc.

Permit Number: AC 48-108742

Expiration Date: April 1, 1986

GENERAL CONDITIONS:

- b. The permittee shall retain at the facility or other location designated by this permit records of all monitoring information (including all calibration and maintenance records and all original strip chart recordings for continuous monitoring instrumentation), copies of all reports required by this permit, and records of all data used to complete the application for this permit. The time period of retention shall be at least three years from the date of the sample, measurement, report or application unless otherwise specified by department rule.
 - c. Records of monitoring information shall include:
 - the date, exact place, and time of sampling or measurements;
 - the person responsible for performing the sampling or measurements;
 - the date(s) analyses were performed;
 - the person responsible for performing the analyses;
 - the analytical techniques or methods used; and
 - the results of such analyses.
15. When requested by the department, the permittee shall within a reasonable time furnish any information required by law which is needed to determine compliance with the permit. If the permittee becomes aware that relevant facts were not submitted or were incorrect in the permit application or in any report to the department, such facts or information shall be submitted or corrected promptly.

SPECIFIC CONDITIONS:

- 1. The hours of operation shall not exceed 4160 hours per year.
- 2. The allowable particulate emission rate shall not exceed 0.250 pounds per hour or 0.38 tons per year.

PERMITTEE: Walt Disney World Company, Inc. Permit Number: AC 48-108742
Expiration Date: April 1, 1986

SPECIFIC CONDITIONS:

3. There shall be no visible emissions, initially demonstrated in accordance with DER Method 9 (Rule 17-2.700(6)(a)9, FAC).
4. Allowable volatile organic compound emissions shall not exceed 3.54 pounds per hour or 5.65 tons per year.
5. The volatile organic compound content of all coatings and solvents used in this booth, demonstrated by manufacturer's specification or EPA Method 24, shall be submitted to the St. Johns River District office.
6. The use of all coatings and solvents shall be recorded daily and shall be submitted quarterly to the St. Johns River District office.
7. Compliance tests, in accordance with FAC Rule 17-2.700, shall be submitted to DER's St. Johns River District office within 45 days after completion of the tests.
8. Fifteen (15) days notification of the compliance tests to DER's St. Johns River District office is required.
9. After satisfactory completion of the initial compliance test and prior to ninety (90) days before the expiration of this permit, a complete application for an operating permit shall be submitted to the St. Johns River District office. The permittee may continue to operate in compliance with all terms of this construction permit until its expiration date or the issuance of an operating permit. The department may extend the expiration date of this construction permit as authorized by Rule 17-2.210(1), FAC.

Issued this _____ day of _____, 19____

STATE OF FLORIDA DEPARTMENT OF
ENVIRONMENTAL REGULATION

VICTORIA J. TSCHINKEL, Secretary

_____page attached.

STATE OF FLORIDA
DEPARTMENT OF ENVIRONMENTAL REGULATION

TWIN TOWERS OFFICE BUILDING
2600 BLAIR STONE ROAD
TALLAHASSEE, FLORIDA 32301-8241



BOB GRAHAM
GOVERNOR
VICTORIA J. TSCHINKEL
SECRETARY

PERMITTEE: Permit Number: AC 48-108743
Walt Disney World Company, Inc. Expiration Date: April 1, 1986
Post Office Box 40 County: Orange
Lake Buena Vista, Florida 32830 Latitude/Longitude: 28° 25' 32"N/
81° 34' 36"W
Project: NSA Staff Shop Booth No. 1

This permit is issued under the provisions of Chapters 403, Florida Statutes, and Florida Administrative Code Rule(s) 17-2 and 17-4. The above named permittee is hereby authorized to perform the work or operate the facility shown on the application and approved drawings, plans, and other documents attached hereto or on file with the department and made a part hereof and specifically described as follows:

For the construction of a spray booth which will be used to spray polyester resin, lacquer based coatings and polyvinyl alcohol on fiberglass objects and molds. The booth will be a Binks model PPF with model 30-800 fans. The particulate filters will have an efficiency of 80% for lacquers and 95% for two part high particulate coating systems.

Construction shall be in accordance with the attached permit application and additional information except as otherwise noted on pages 5 and 6, specific conditions.

Attachments are as follows:

1. Applications to construct an Air Pollution Source, DER form 17-1.202(1).

Best Available Copy

PERMITTEE: Permit Number: AC 48-108743
Walt Disney World Company, Inc. Expiration Date: April 1, 1986

GENERAL CONDITIONS:

1. The terms, conditions, requirements, limitations, and restrictions set forth herein are "Permit Conditions" and as such are binding upon the permittee and enforceable pursuant to the authority of Sections 403.161, 403.727, or 403.859 through 403.861, Florida Statutes. The permittee is hereby placed on notice that the department will review this permit periodically and may initiate enforcement action for any violation of the "Permit Conditions" by the permittee, its agents, employees, servants or representatives.
2. This permit is valid only for the specific processes and operations applied for and indicated in the approved drawings or exhibits. Any unauthorized deviation from the approved drawings, exhibits, specifications, or conditions of this permit may constitute grounds for revocation and enforcement action by the department.
3. As provided in Subsections 403.087(6) and 403.722(5), Florida Statutes, the issuance of this permit does not convey any vested rights or any exclusive privileges. Nor does it authorize any injury to public or private property or any invasion of personal rights, nor any infringement of federal, state or local laws or regulations. This permit does not constitute a waiver of or approval of any other department permit that may be required for other aspects of the total project which are not addressed in the permit.
4. This permit conveys no title to land or water, does not constitute state recognition or acknowledgement of title, and does not constitute authority for the use of submerged lands unless herein provided and the necessary title or leasehold interests have been obtained from the state. Only the Trustees of the Internal Improvement Trust Fund may express state opinion as to title.
5. This permit does not relieve the permittee from liability for harm or injury to human health or welfare, animal, plant or aquatic life or property and penalties therefore caused by the construction or operation of this permitted source, nor does it allow the permittee to cause pollution in contravention of Florida Statutes and department rules, unless specifically authorized by an order from the department.

PERMITTEE: Permit Number: AC 48-108743
Walt Disney World Company, Inc. Expiration Date: April 1, 1986

GENERAL CONDITIONS:

6. The permittee shall at all times properly operate and maintain the facility and systems of treatment and control (and related appurtenances) that are installed or used by the permittee to achieve compliance with the conditions of this permit, as required by department rules. This provision includes the operation of backup or auxiliary facilities or similar systems when necessary to achieve compliance with the conditions of the permit and when required by department rules.
7. The permittee, by accepting this permit, specifically agrees to allow authorized department personnel, upon presentation of credentials or other documents as may be required by law, access to the premises, at reasonable times, where the permitted activity is located or conducted for the purpose of:
 - a. Having access to and copying any records that must be kept under the conditions of the permit;
 - b. Inspecting the facility, equipment, practices, or operations regulated or required under this permit; and
 - c. Sampling or monitoring any substances or parameters at any location reasonably necessary to assure compliance with this permit or department rules.

Reasonable time may depend on the nature of the concern being investigated.

8. If, for any reason, the permittee does not comply with or will be unable to comply with any condition or limitation specified in this permit, the permittee shall immediately notify and provide the department with the following information:
 - a. a description of and cause of non-compliance; and
 - b. the period of noncompliance, including exact dates and times; or, if not corrected, the anticipated time the noncompliance is expected to continue, and steps being taken to reduce, eliminate, and prevent recurrence of the noncompliance.

PERMITTEE:
Walt Disney World Company, Inc.

Permit Number: AC 48-108743
Expiration Date: April 1, 1986

GENERAL CONDITIONS:

The permittee shall be responsible for any and all damages which may result and may be subject to enforcement action by the department for penalties or revocation of this permit.

9. In accepting this permit, the permittee understands and agrees that all records, notes, monitoring data and other information relating to the construction or operation of this permitted source, which are submitted to the department, may be used by the department as evidence in any enforcement case arising under the Florida Statutes or department rules, except where such use is proscribed by Sections 403.73 and 403.111, Florida Statutes.
10. The permittee agrees to comply with changes in department rules and Florida Statutes after a reasonable time for compliance, provided however, the permittee does not waive any other rights granted by Florida Statutes or department rules.
11. This permit is transferable only upon department approval in accordance with Florida Administrative Code Rules 17-4.12 and 17-30.30, as applicable. The permittee shall be liable for any non-compliance of the permitted activity until the transfer is approved by the department.
12. This permit is required to be kept at the work site of the permitted activity during the entire period of construction or operation.
13. This permit also constitutes:
 - () Determination of Best Available Control Technology (BACT)
 - () Determination of Prevention of Significant Deterioration (PSD)
 - () Compliance with New Source Performance Standards.
14. The permittee shall comply with the following monitoring and record keeping requirements:
 - a. Upon request, the permittee shall furnish all records and plans required under department rules. The retention period for all records will be extended automatically, unless otherwise stipulated by the department, during the course of any unresolved enforcement action.

PERMITTEE: Walt Disney World Company, Inc. Permit Number: AC 48-108743
Expiration Date: April 1, 1986

GENERAL CONDITIONS:

- b. The permittee shall retain at the facility or other location designated by this permit records of all monitoring information (including all calibration and maintenance records and all original strip chart recordings for continuous monitoring instrumentation), copies of all reports required by this permit, and records of all data used to complete the application for this permit. The time period of retention shall be at least three years from the date of the sample, measurement, report or application unless otherwise specified by department rule.
 - c. Records of monitoring information shall include:
 - the date, exact place, and time of sampling or measurements;
 - the person responsible for performing the sampling or measurements;
 - the date(s) analyses were performed;
 - the person responsible for performing the analyses;
 - the analytical techniques or methods used; and
 - the results of such analyses.
15. When requested by the department, the permittee shall within a reasonable time furnish any information required by law which is needed to determine compliance with the permit. If the permittee becomes aware that relevant facts were not submitted or were incorrect in the permit application or in any report to the department, such facts or information shall be submitted or corrected promptly.

SPECIFIC CONDITIONS:

1. The hours of operation shall not exceed 2080 hours per year.
2. The allowable particulate emission rate shall not exceed 0.02 pounds per hour or 0.02 tons per year.

PERMITTEE:

Walt Disney World Company, Inc.

Permit Number: AC 48-108743

Expiration Date: April 1, 1986

SPECIFIC CONDITIONS:

3. There shall be no visible emissions, initially demonstrated in accordance with DER Method 9 (Rule 17-2.700(6)(a)9, FAC).
4. Allowable volatile organic compound emissions shall not exceed 0.08 pounds per hour or 0.08 tons per year.
5. The volatile organic compound content of all coatings and solvents used in this booth, demonstrated by manufacturer's specification or EPA Method 24, shall be submitted to the St. Johns River District office.
6. The use of all coatings and solvents shall be recorded daily and shall be submitted quarterly to the St. Johns River District office.
7. Compliance tests, in accordance with FAC Rule 17-2.700, shall be submitted to DER's St. Johns River District office within 45 days after completion of the tests.
8. Fifteen (15) days notification of the compliance tests to DER's St. Johns River District office is required.
9. After satisfactory completion of the initial compliance test and prior to ninety (90) days before the expiration of this permit, a complete application for an operating permit shall be submitted to the St. Johns River District office. The permittee may continue to operate in compliance with all terms of this construction permit until its expiration date or the issuance of an operating permit. The department may extend the expiration date of this construction permit as authorized by Rule 17-2.210(1), FAC.

Issued this _____ day of _____, 19____

STATE OF FLORIDA DEPARTMENT OF
ENVIRONMENTAL REGULATION

VICTORIA J. TSCHINKEL, Secretary

_____page attached.

STATE OF FLORIDA
DEPARTMENT OF ENVIRONMENTAL REGULATION

TWIN TOWERS OFFICE BUILDING
2600 BLAIR STONE ROAD
TALLAHASSEE, FLORIDA 32301-8241



BOB GRAHAM
GOVERNOR
VICTORIA J. TSCHINKEL
SECRETARY

PERMITTEE: Permit Number: AC 48-108744
Walt Disney World Company, Inc. Expiration Date: April 1, 1986
Post Office Box 40 County: Orange
Lake Buena Vista, Florida 32830 Latitude/Longitude: 28° 25' 32"N/
81° 34' 36"W
Project: NSA Staff Shop Spray
Booth No. 2

This permit is issued under the provisions of Chapters 403, Florida Statutes, and Florida Administrative Code Rule(s) 17-2 and 17-4. The above named permittee is hereby authorized to perform the work or operate the facility shown on the application and approved drawings, plans, and other documents attached hereto or on file with the department and made a part hereof and specifically described as follows:

For the construction of a spray booth which will be used to spray lacquer based coatings and polyvinyl alcohol on fiberglass objects and molds. This built in spray booth will be equipped with a New York model 548-1 blower and particulate filters with an efficiency of 80% for lacquers and 95% for two part high particulate coating systems.

Construction shall be in accordance with the attached permit application and additional information except as otherwise noted on pages 5 and 6, specific conditions.

Attachments are as follows:

1. Applications to construct an Air Pollution Source, DER form 17-1.202(1).

PERMITTEE:

Permit Number: AC 48-108744

Walt Disney World Company, Inc. Expiration Date: April 1, 1986

GENERAL CONDITIONS:

1. The terms, conditions, requirements, limitations, and restrictions set forth herein are "Permit Conditions" and as such are binding upon the permittee and enforceable pursuant to the authority of Sections 403.161, 403.727, or 403.859 through 403.861, Florida Statutes. The permittee is hereby placed on notice that the department will review this permit periodically and may initiate enforcement action for any violation of the "Permit Conditions" by the permittee, its agents, employees, servants or representatives.
2. This permit is valid only for the specific processes and operations applied for and indicated in the approved drawings or exhibits. Any unauthorized deviation from the approved drawings, exhibits, specifications, or conditions of this permit may constitute grounds for revocation and enforcement action by the department.
3. As provided in Subsections 403.087(6) and 403.722(5), Florida Statutes, the issuance of this permit does not convey any vested rights or any exclusive privileges. Nor does it authorize any injury to public or private property or any invasion of personal rights, nor any infringement of federal, state or local laws or regulations. This permit does not constitute a waiver of or approval of any other department permit that may be required for other aspects of the total project which are not addressed in the permit.
4. This permit conveys no title to land or water, does not constitute state recognition or acknowledgement of title, and does not constitute authority for the use of submerged lands unless herein provided and the necessary title or leasehold interests have been obtained from the state. Only the Trustees of the Internal Improvement Trust Fund may express state opinion as to title.
5. This permit does not relieve the permittee from liability for harm or injury to human health or welfare, animal, plant or aquatic life or property and penalties therefore caused by the construction or operation of this permitted source, nor does it allow the permittee to cause pollution in contravention of Florida Statutes and department rules, unless specifically authorized by an order from the department.

PERMITTEE: Permit Number: AC 48-108744
Walt Disney World Company, Inc. Expiration Date: April 1, 1986

GENERAL CONDITIONS:

6. The permittee shall at all times properly operate and maintain the facility and systems of treatment and control (and related appurtenances) that are installed or used by the permittee to achieve compliance with the conditions of this permit, as required by department rules. This provision includes the operation of backup or auxiliary facilities or similar systems when necessary to achieve compliance with the conditions of the permit and when required by department rules.
7. The permittee, by accepting this permit, specifically agrees to allow authorized department personnel, upon presentation of credentials or other documents as may be required by law, access to the premises, at reasonable times, where the permitted activity is located or conducted for the purpose of:
 - a. Having access to and copying any records that must be kept under the conditions of the permit;
 - b. Inspecting the facility, equipment, practices, or operations regulated or required under this permit; and
 - c. Sampling or monitoring any substances or parameters at any location reasonably necessary to assure compliance with this permit or department rules.

Reasonable time may depend on the nature of the concern being investigated.

8. If, for any reason, the permittee does not comply with or will be unable to comply with any condition or limitation specified in this permit, the permittee shall immediately notify and provide the department with the following information:
 - a. a description of and cause of non-compliance; and
 - b. the period of noncompliance, including exact dates and times; or, if not corrected, the anticipated time the noncompliance is expected to continue, and steps being taken to reduce, eliminate, and prevent recurrence of the noncompliance.

PERMITTEE:
Walt Disney World Company, Inc.

Permit Number: AC 48-108744
Expiration Date: April 1, 1986

GENERAL CONDITIONS:

The permittee shall be responsible for any and all damages which may result and may be subject to enforcement action by the department for penalties or revocation of this permit.

9. In accepting this permit, the permittee understands and agrees that all records, notes, monitoring data and other information relating to the construction or operation of this permitted source, which are submitted to the department, may be used by the department as evidence in any enforcement case arising under the Florida Statutes or department rules, except where such use is proscribed by Sections 403.73 and 403.111, Florida Statutes.
10. The permittee agrees to comply with changes in department rules and Florida Statutes after a reasonable time for compliance, provided however, the permittee does not waive any other rights granted by Florida Statutes or department rules.
11. This permit is transferable only upon department approval in accordance with Florida Administrative Code Rules 17-4.12 and 17-30.30, as applicable. The permittee shall be liable for any non-compliance of the permitted activity until the transfer is approved by the department.
12. This permit is required to be kept at the work site of the permitted activity during the entire period of construction or operation.
13. This permit also constitutes:
 - () Determination of Best Available Control Technology (BACT)
 - () Determination of Prevention of Significant Deterioration (PSD)
 - () Compliance with New Source Performance Standards.
14. The permittee shall comply with the following monitoring and record keeping requirements:
 - a. Upon request, the permittee shall furnish all records and plans required under department rules. The retention period for all records will be extended automatically, unless otherwise stipulated by the department, during the course of any unresolved enforcement action.

PERMITTEE: Permit Number: AC 48-108744
Walt Disney World Company, Inc. Expiration Date: April 1, 1986

GENERAL CONDITIONS:

- b. The permittee shall retain at the facility or other location designated by this permit records of all monitoring information (including all calibration and maintenance records and all original strip chart recordings for continuous monitoring instrumentation), copies of all reports required by this permit, and records of all data used to complete the application for this permit. The time period of retention shall be at least three years from the date of the sample, measurement, report or application unless otherwise specified by department rule.
 - c. Records of monitoring information shall include:
 - the date, exact place, and time of sampling or measurements;
 - the person responsible for performing the sampling or measurements;
 - the date(s) analyses were performed;
 - the person responsible for performing the analyses;
 - the analytical techniques or methods used; and
 - the results of such analyses.
15. When requested by the department, the permittee shall within a reasonable time furnish any information required by law which is needed to determine compliance with the permit. If the permittee becomes aware that relevant facts were not submitted or were incorrect in the permit application or in any report to the department, such facts or information shall be submitted or corrected promptly.

SPECIFIC CONDITIONS:

- 1. The hours of operation shall not exceed 2080 hours per year.
- 2. The allowable particulate emission rate shall not exceed 0.40 pounds per hour or 0.16 tons per year.

PERMITTEE: Walt Disney World Company, Inc. Permit Number: AC 48-108744
Expiration Date: April 1, 1986

SPECIFIC CONDITIONS:

3. There shall be no visible emissions, initially demonstrated in accordance with DER Method 9 (Rule 17-2.700(6)(a)9, FAC).
4. Allowable volatile organic compound emissions shall not exceed 0.61 pounds per hour or 0.63 tons per year.
5. The volatile organic compound content of all coatings and solvents used in this booth, demonstrated by manufacturer's specification or EPA Method 24, shall be submitted to the St. Johns River District office.
6. The use of all coatings and solvents shall be recorded daily and shall be submitted quarterly to the St. Johns River District office.
7. Compliance tests, in accordance with FAC Rule 17-2.700, shall be submitted to DER's St. Johns River District office within 45 days after completion of the tests.
8. Fifteen (15) days notification of the compliance tests to DER's St. Johns River District office is required.
9. After satisfactory completion of the initial compliance test and prior to ninety (90) days before the expiration of this permit, a complete application for an operating permit shall be submitted to the St. Johns River District office. The permittee may continue to operate in compliance with all terms of this construction permit until its expiration date or the issuance of an operating permit. The department may extend the expiration date of this construction permit as authorized by Rule 17-2.210(1), FAC.

Issued this _____ day of _____, 19____

STATE OF FLORIDA DEPARTMENT OF
ENVIRONMENTAL REGULATION

VICTORIA J. TSCHINKEL, Secretary

_____page attached.

STATE OF FLORIDA
DEPARTMENT OF ENVIRONMENTAL REGULATION

TWIN TOWERS OFFICE BUILDING
2600 BLAIR STONE ROAD
TALLAHASSEE, FLORIDA 32301-8241



BOB GRAHAM
GOVERNOR

VICTORIA J. TSCHINKEL
SECRETARY

PERMITTEE: Walt Disney World Company, Inc.
Post Office Box 40
Lake Buena Vista, Florida 32830

Permit Number: AC 48-108745
Expiration Date: April 1, 1986
County: Orange
Latitude/Longitude: 28° 25' 32"N/
81° 34' 36"W

Project: Water Wash Plastisol Booth
No. 1

This permit is issued under the provisions of Chapters 403, Florida Statutes, and Florida Administrative Code Rule(s) 17-2 and 17-4. The above named permittee is hereby authorized to perform the work or operate the facility shown on the application and approved drawings, plans, and other documents attached hereto or on file with the department and made a part hereof and specifically described as follows:

For the construction of a Plastisol booth which will consist of a spray booth and curing oven. The spray booth will be a Binks water wash type equipped with a fan and a no pump dyna-precipitator water wash filtering system. The curing oven will be equipped with a fan and be fired by natural gas with an exit stack temperature of 350°F. The booth will be used to spray solvated vinyl plastisol on fiberglass objects and molds.

Construction shall be in accordance with the attached permit application and additional information except as otherwise noted on pages 5 and 6, specific conditions.

Attachments are as follows:

1. Applications to construct an Air Pollution Source, DER form 17-1.202(1).

PERMITTEE:
Walt Disney World Company, Inc.

Permit Number: AC 48-108745
Expiration Date: April 1, 1986

GENERAL CONDITIONS:

1. The terms, conditions, requirements, limitations, and restrictions set forth herein are "Permit Conditions" and as such are binding upon the permittee and enforceable pursuant to the authority of Sections 403.161, 403.727, or 403.859 through 403.861, Florida Statutes. The permittee is hereby placed on notice that the department will review this permit periodically and may initiate enforcement action for any violation of the "Permit Conditions" by the permittee, its agents, employees, servants or representatives.
2. This permit is valid only for the specific processes and operations applied for and indicated in the approved drawings or exhibits. Any unauthorized deviation from the approved drawings, exhibits, specifications, or conditions of this permit may constitute grounds for revocation and enforcement action by the department.
3. As provided in Subsections 403.087(6) and 403.722(5), Florida Statutes, the issuance of this permit does not convey any vested rights or any exclusive privileges. Nor does it authorize any injury to public or private property or any invasion of personal rights, nor any infringement of federal, state or local laws or regulations. This permit does not constitute a waiver of or approval of any other department permit that may be required for other aspects of the total project which are not addressed in the permit.
4. This permit conveys no title to land or water, does not constitute state recognition or acknowledgement of title, and does not constitute authority for the use of submerged lands unless herein provided and the necessary title or leasehold interests have been obtained from the state. Only the Trustees of the Internal Improvement Trust Fund may express state opinion as to title.
5. This permit does not relieve the permittee from liability for harm or injury to human health or welfare, animal, plant or aquatic life or property and penalties therefore caused by the construction or operation of this permitted source, nor does it allow the permittee to cause pollution in contravention of Florida Statutes and department rules, unless specifically authorized by an order from the department.

PERMITTEE: Permit Number: AC 48-108745
Walt Disney World Company, Inc. Expiration Date: April 1, 1986

GENERAL CONDITIONS:

6. The permittee shall at all times properly operate and maintain the facility and systems of treatment and control (and related appurtenances) that are installed or used by the permittee to achieve compliance with the conditions of this permit, as required by department rules. This provision includes the operation of backup or auxiliary facilities or similar systems when necessary to achieve compliance with the conditions of the permit and when required by department rules.
7. The permittee, by accepting this permit, specifically agrees to allow authorized department personnel, upon presentation of credentials or other documents as may be required by law, access to the premises, at reasonable times, where the permitted activity is located or conducted for the purpose of:
 - a. Having access to and copying any records that must be kept under the conditions of the permit;
 - b. Inspecting the facility, equipment, practices, or operations regulated or required under this permit; and
 - c. Sampling or monitoring any substances or parameters at any location reasonably necessary to assure compliance with this permit or department rules.

Reasonable time may depend on the nature of the concern being investigated.

8. If, for any reason, the permittee does not comply with or will be unable to comply with any condition or limitation specified in this permit, the permittee shall immediately notify and provide the department with the following information:
 - a. a description of and cause of non-compliance; and
 - b. the period of noncompliance, including exact dates and times; or, if not corrected, the anticipated time the noncompliance is expected to continue, and steps being taken to reduce, eliminate, and prevent recurrence of the noncompliance.

PERMITTEE: Permit Number: AC 48-108745
Walt Disney World Company, Inc. Expiration Date: April 1, 1986

GENERAL CONDITIONS:

The permittee shall be responsible for any and all damages which may result and may be subject to enforcement action by the department for penalties or revocation of this permit.

9. In accepting this permit, the permittee understands and agrees that all records, notes, monitoring data and other information relating to the construction or operation of this permitted source, which are submitted to the department, may be used by the department as evidence in any enforcement case arising under the Florida Statutes or department rules, except where such use is proscribed by Sections 403.73 and 403.111, Florida Statutes.
10. The permittee agrees to comply with changes in department rules and Florida Statutes after a reasonable time for compliance, provided however, the permittee does not waive any other rights granted by Florida Statutes or department rules.
11. This permit is transferable only upon department approval in accordance with Florida Administrative Code Rules 17-4.12 and 17-30.30, as applicable. The permittee shall be liable for any non-compliance of the permitted activity until the transfer is approved by the department.
12. This permit is required to be kept at the work site of the permitted activity during the entire period of construction or operation.
13. This permit also constitutes:
 - () Determination of Best Available Control Technology (BACT)
 - () Determination of Prevention of Significant Deterioration (PSD)
 - () Compliance with New Source Performance Standards.
14. The permittee shall comply with the following monitoring and record keeping requirements:
 - a. Upon request, the permittee shall furnish all records and plans required under department rules. The retention period for all records will be extended automatically, unless otherwise stipulated by the department, during the course of any unresolved enforcement action.

PERMITTEE:

Walt Disney World Company, Inc.

Permit Number: AC 48-108745

Expiration Date: April 1, 1986

GENERAL CONDITIONS:

b. The permittee shall retain at the facility or other location designated by this permit records of all monitoring information (including all calibration and maintenance records and all original strip chart recordings for continuous monitoring instrumentation), copies of all reports required by this permit, and records of all data used to complete the application for this permit. The time period of retention shall be at least three years from the date of the sample, measurement, report or application unless otherwise specified by department rule.

c. Records of monitoring information shall include:

- the date, exact place, and time of sampling or measurements;
- the person responsible for performing the sampling or measurements;
- the date(s) analyses were performed;
- the person responsible for performing the analyses;
- the analytical techniques or methods used; and
- the results of such analyses.

15. When requested by the department, the permittee shall within a reasonable time furnish any information required by law which is needed to determine compliance with the permit. If the permittee becomes aware that relevant facts were not submitted or were incorrect in the permit application or in any report to the department, such facts or information shall be submitted or corrected promptly.

SPECIFIC CONDITIONS:

1. The hours of operation shall not exceed 2080 hours per year.
2. The allowable particulate emission rate shall not exceed 0.07 pounds per hour or 0.08 tons per year.

PERMITTEE:

Walt Disney World Company, Inc.

Permit Number: AC 48-108745

Expiration Date: April 1, 1986

SPECIFIC CONDITIONS:

3. There shall be no visible emissions, initially demonstrated in accordance with DER Method 9 (Rule 17-2.700(6)(a)9, FAC).
4. Allowable volatile organic compound emissions shall not exceed 0.49 pounds per hour or 0.53 tons per year.
5. The volatile organic compound content of all coatings and solvents used in this booth, demonstrated by manufacturer's specification or EPA Method 24, shall be submitted to the St. Johns River District office.
6. The use of all coatings and solvents shall be recorded daily and shall be submitted quarterly to the St. Johns River District office.
7. Stack temperature shall not exceed 350°F.
8. Compliance tests, in accordance with FAC Rule 17-2.700, shall be submitted to DER's St. Johns River District office within 45 days after completion of the tests.
9. Fifteen (15) days notification of the compliance tests to DER's St. Johns River District office is required.
10. After satisfactory completion of the initial compliance test and prior to ninety (90) days before the expiration of this permit, a complete application for an operating permit shall be submitted to the St. Johns River District office. The permittee may continue to operate in compliance with all terms of this construction permit until its expiration date or the issuance of an operating permit. The department may extend the expiration date of this construction permit as authorized by Rule 17-2.210(1), FAC.

Issued this _____ day of _____, 19____

STATE OF FLORIDA DEPARTMENT OF
ENVIRONMENTAL REGULATION

VICTORIA J. TSCHINKEL, Secretary

____ pages attached.

Walt Disney World

BEST AVAILABLE COPY

LAKE BUENA VISTA, FLORIDA

63-215
631

DATE 08/19/85 CHECK NO. 599689

AMOUNT OF CHECK

PAY THE SUM OF *****600 DOLLARS AND 00 CENTS

*****600.00

TO THE ORDER OF

DEPT OF ENVIR REGULATION
BUREAU OF AIR QUALITY MGT
2600 BLAIR STONE RD
TALLAHASSEE FL 32301



WALT DISNEY-WORLD CO.

William A. O'Neil

SUN BANK, N.A.
DOWNTOWN OFFICE
ORLANDO, FLORIDA 32802

REMITTANCE ADVICE



LAKE BUENA VISTA, FLORIDA 32830 - TELE (305) 824-2222

DETACH THIS STUB
BEFORE DEPOSIT

REFERENCE NO.	INVOICE NO.	PURCH. MDSE. ORDER NO.	GROSS	DISCOUNT	NET
PAYEE NO. 3000015899 COMPUTER NO.: 0001301 CHECK NO. 599689					
REMITTANCE ADVICE: PAYING AGENT FOR WALT DISNEY WORLD CO					
438336	AC48-75833	CK R	100.00	.00	100.00
438336	AC48-75834	CK R	100.00	.00	100.00
438336	AC48-75835	CK R	100.00	.00	100.00
438336	AC48-75836	CK R	100.00	.00	100.00
438336	AC48-75837	CK R	100.00	.00	100.00
438336	AC48-75838	CK R	100.00	.00	100.00
APPLICATION PROCESSING FEE FOR 6 PAINT S					
TOTAL:			600.00		600.00
				DER	
				AUG 21 1985	
				BAQM	

STATE OF FLORIDA DEPARTMENT OF ENVIRONMENTAL REGULATION

No 76084

RECEIPT FOR APPLICATION FEES AND MISCELLANEOUS REVENUE

Received from Walt Disney World Date August 23, 1985

Address Lake Buena Vista Florida Dollars \$ 600.00

Applicant Name & Address Same as above

Source of Revenue _____

Revenue Code 001031 Application Number AC 48-108740, 41, 42, 43, 44

By Patricia H. Thomas and 45

PS Form 3811, July 1983

SENDER: Complete items 1, 2, 3 and 4.

Put your address in the "RETURN TO" space on the reverse side. Failure to do this will prevent this card from being returned to you. The return receipt fee will provide you the name of the person delivered to and the date of delivery. For additional fees the following services are available. Consult postmaster for fees and check-box(es) for service(s) requested.

1. Show to whom, date and address of delivery.

2. Restricted Delivery.

3. Article Addressed to:
 Mr. Edward B. Crowell
 Walt Disney World Company, Inc.
 P. O. Box 40
 Lake Buena Vista, Florida 32830

4. Type of Service: <input type="checkbox"/> Registered <input checked="" type="checkbox"/> Certified <input type="checkbox"/> Express Mail	<input type="checkbox"/> Insured <input type="checkbox"/> COD	Article Number P 085 152 632
--	--	-------------------------------------

Always obtain signature of addressee or agent and DATE DELIVERED.

5. Signature - Addressee
X

6. Signature - Agent
X *Buckley*

7. Date of Delivery
AUG 12 1985

8. Addressee's Address (ONLY if requested and fee paid)

DOMESTIC RETURN RECEIPT

P 085 152 632

RECEIPT FOR CERTIFIED MAIL

NO INSURANCE COVERAGE PROVIDED
 NOT FOR INTERNATIONAL MAIL

(See Reverse)

PS Form 3800, Feb. 1982
 ★ U.S.G.P.O. 1984-446-014

Sent to Mr. Edward B. Crowell	
Street and No.	
P.O., State and ZIP Code	
Postage	\$
Certified Fee	
Special Delivery Fee	
Restricted Delivery Fee	
Return Receipt Showing to whom and Date Delivered	
Return receipt showing to whom, Date, and Address of Delivery	
TOTAL Postage and Fees	\$
Postmark or Date 8/9/85	

STATE OF FLORIDA
DEPARTMENT OF ENVIRONMENTAL REGULATION

TWIN TOWERS OFFICE BUILDING
2600 BLAIR STONE ROAD
TALLAHASSEE, FLORIDA 32301-8241



BOB GRAHAM
GOVERNOR
VICTORIA J. TSCHINKEL
SECRETARY

August 9, 1985

CERTIFIED MAIL - RETURN RECEIPT REQUESTED

Mr. Edward B. Crowell
Vice President - Facilities Support
Walt Disney World Company, Inc.
P. O. Box 40
Lake Buena Vista, Florida 32830

Dear Mr. Crowell:

The Bureau of Air Quality Management has received a copy of your July 12, 1985, letter to Mr. Charles Collins in which you requested the extension of the expiration dates of six construction permits. We are unable to grant this request because the six construction permits for the spray booths expired on June 1, 1985.

If you still plan to use these spray booths, you must submit new applications to construct an air pollution source along with the appropriate processing fees.

If you have any questions, please write to me at the above address or call Ed Svec, Review Engineer, at (904)488-1344.

Sincerely,

C. H. Fancy, P.E.
Deputy Chief
Bureau of Air Quality
Management

CHF/ES/s

cc: Charles Collins

**ENVIRONMENTAL SCIENCE
AND ENGINEERING, INC.**

August 15, 1985
85-116-0100-2110

Mr. C. H. Fancy, P.E.
Deputy Chief
Bureau of Air Quality Management
Florida Department of Environmental Regulation
2600 Blair Stone Road
Tallahassee, FL 32301-8241

Re: Reedy Creek Improvement District - Spray Booths

Dear Mr. Fancy:

Enclosed is a copy of the set of original applications for the referenced sources. Also attached are copies of correspondence addressing comments during the previous review period. The processing fee is being sent under separate cover from Reedy Creek Improvement District.

It is my understanding, based on conversation with Mr. Ed Svec on August 13, 1985, that this will be sufficient for the re-application described in your letter of August 9, 1985, to Mr. Crowell.

Yours very truly,



Michael H. Dybeveck, P.E.
Chemical Engineer

MHD:bl

cc: Fred Harden, RCID
Charles Collins, St. Johns River District FDER

*Expired
4/1/86*

*Complete
8/21/85*

DER
AUG 16 1985
BAQM

AC 48-108740

BEST AVAILABLE COPY

AC 48-75833

STATE OF FLORIDA

DEPARTMENT OF ENVIRONMENTAL REGULATION

ST. JOHNS RIVER DISTRICT

3319 MAGUIRE BOULEVARD SUITE 232 ORLANDO, FLORIDA 32803

SEP 22 1983



DER

OCT 6 1983

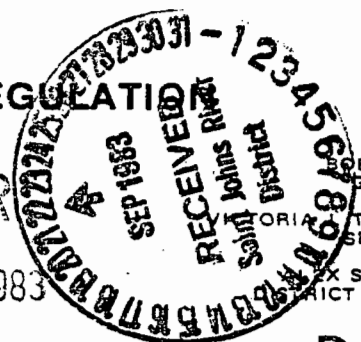

BOB GRAHAM GOVERNOR
ORIAN TSCHINKEL SECRETARY
MAX SENKEVICH DISTRICT MANAGER

SAINT JOHNS RIVER DISTRICT

BAOM

DER

OCT 16 1985

BAQM

APPLICATION TO OPERATE/CONSTRUCT AIR POLLUTION SOURCES

SOURCE TYPE: Spray Paint Booth [] New¹ [X] Existing¹

APPLICATION TYPE: [X] Construction [] Operation [] Modification

COMPANY NAME: WALT DISNEY WORLD Co., Inc. COUNTY: Orange

Identify the specific emission point source(s) addressed in this application (i.e. Lime Kiln No. 4 with Venturi Scrubber; Peaking Unit No. 2, Gas Fired) NSA Paint Shop Paint Booth #1

SOURCE LOCATION: Street Facilities Way City Bay Lake

UTM: East 443527 North 3144316

Latitude 28 ° 25 ' 32 "N Longitude 81 ° 34 ' 36 "W

APPLICANT NAME AND TITLE: Edward B. Crowell, Vice President Facilities Division

APPLICANT ADDRESS: P.O. Box 40, Lake Buena Vista Florida 32830

SECTION I: STATEMENTS BY APPLICANT AND ENGINEER

A. APPLICANT

I am the undersigned owner or authorized representative* of WALT DISNEY WORLD Co.

I certify that the statements made in this application for a construction permit are true, correct and complete to the best of my knowledge and belief. Further, I agree to maintain and operate the pollution control source and pollution control facilities in such a manner as to comply with the provision of Chapter 403, Florida Statutes, and all the rules and regulations of the department and revisions thereof. I also understand that a permit, if granted by the department, will be non-transferable and I will promptly notify the department upon sale or legal transfer of the permitted establishment.

*Attach letter of authorization

Signed: [Signature]

X Edward B. Crowell, V.P. Facilities Division
Name and Title (Please Type)

Date: _____ Telephone No. (305) 824-7700

B. PROFESSIONAL ENGINEER REGISTERED IN FLORIDA (where required by Chapter 471, F.S.)

This is to certify that the engineering features of this pollution control project have been ~~designed~~ examined by me and found to be in conformity with modern engineering principles applicable to the treatment and disposal of pollutants characterized in the permit application. There is reasonable assurance, in my professional judgment, that

¹ See Florida Administrative Code Rule 17-2.100(57) and (104)

the pollution control facilities, when properly maintained and operated, will discharge an effluent that complies with all applicable statutes of the State of Florida and the rules and regulations of the department. It is also agreed that the undersigned will furnish, if authorized by the owner, the applicant a set of instructions for the proper maintenance and operation of the pollution control facilities and, if applicable, pollution sources.

Signed Ted McKim

TED W. MCKIM
Name (Please Type)

Reedy Creek Utilities Co., Inc
Company Name (Please Type)

P.O. Box 40 Lake Buena Vista, FL 32830
Mailing Address (Please Type)

Florida Registration No. 25555 Date: 9/21/83 Telephone No. (305) 824-4950

SECTION II: GENERAL PROJECT INFORMATION

A. Describe the nature and extent of the project. Refer to pollution control equipment, and expected improvements in source performance as a result of installation. State whether the project will result in full compliance. Attach additional sheet if necessary.

Spray paint booth for coating a variety of objects including vehicles, wooden furniture, trash cans, ride components, posts and frames using 2 part polyurethane, 2 part acrylic, epoxy primers and other primer coating systems.

B. Schedule of project covered in this application (Construction Permit Application Only)

Start of Construction existing booth Completion of Construction N/A

C. Costs of pollution control system(s): (Note: Show breakdown of estimated costs only for individual components/units of the project serving pollution control purposes. Information on actual costs shall be furnished with the application for operation permit.)

N/A

D. Indicate any previous DER permits, orders and notices associated with the emission point, including permit issuance and expiration dates. NONE

Permit applications called in by Chuck Collins of Florida DER to be submitted by 9/16/83.

E. Requested permitted equipment operating time: hrs/day 16 ; days/wk 5 ; wks/yr 52 ;
if power plant, hrs/yr _____ ; if seasonal, describe: _____

F. If this is a new source or major modification, answer the following questions.
(Yes or No)

1. Is this source in a non-attainment area for a particular pollutant? yes
a. If yes, has "offset" been applied? no
b. If yes, has "Lowest Achievable Emission Rate" been applied? no
c. If yes, list non-attainment pollutants. VOC

2. Does best available control technology (BACT) apply to this source?
If yes, see Section VI. no

3. Does the State "Prevention of Significant Deterioration" (PSD)
requirement apply to this source? If yes, see Sections VI and VII. no

4. Do "Standards of Performance for New Stationary Sources" (NSPS)
apply to this source? no

5. Do "National Emission Standards for Hazardous Air Pollutants"
(NESHAP) apply to this source? no

H. Do "Reasonably Available Control Technology" (RACT) requirements apply
to this source? no

a. If yes, for what pollutants? _____

b. If yes, in addition to the information required in this form,
any information requested in Rule 17-2.650 must be submitted.

Attach all supportive information related to any answer of "Yes". Attach any justifi-
cation for any answer of "No" that might be considered questionable.

No RACT guidelines for this type of surface coating operations

BEST AVAILABLE COPY

SECTION III: AIR POLLUTION SOURCES & CONTROL DEVICES (Other than Incinerators)

A. Raw Materials and Chemicals Used in your Process, if applicable:

See attachment #1, Part H

Description	Contaminants		Utilization Rate - lbs/hr	Relate to Flow Diagram
	Type	% Wt		
2 part polyurethane system	VOC/particulate	0% 100%	10.1	Paint application
2 part acrylic enamel	VOC/particulate	0% 100%	5.0	Paint application
2 part epoxy primer	VOC/particulate	0% 100%	1.2	Paint application
conventional primer systems	VOC/particulate	51% 49%	0.4 11.8	Paint application Thinner for paint application

B. Process Rate, if applicable: (See Section V, Item 1) N/A

1. Total Process Input Rate (lbs/hr): _____

2. Product Weight (lbs/hr): _____

C. Airborne Contaminants Emitted: (Information in this table must be submitted for each emission point, use additional sheets as necessary) See attachment #1 parts A-G for calculations

Name of Contaminant	Emission ¹		Allowed ² Emission Rate per Rule 17-2	Allowable ³ Emission lbs/hr	Potential ⁴ Emission		Relate to Flow Diagram
	Maximum lbs/hr	Actual T/yr			lbs/yr	T/yr	
VOC	11.9	24.75			49,500	24.75	
particulate	0.47	0.98			39,000	19.5	

See Section V, Item 2.

Reference applicable emission standards and units (e.g. Rule 17-2.600(5)(b)2. Table II, E. (1) - 0.1 pounds per million BTU heat input)

Calculated from operating rate and applicable standard.

Emission, if source operated without control (See Section V, Item 3).

D. Control Devices: (See Section V, Item 4)

Name and Type (Model & Serial No.)	Contaminant	Efficiency	Range of Particles Size Collected (in microns) (If applicable)	Basis for Efficiency (Section V Item 5)
Binks paint arrestor type	particulate	95%	N/A	manufacturers specs.
Filters model #29-893				
Filter Bank dimensions				
10 ft x 26.7 ft or				
267 sq ft total				

E. Fuels N/A

Type (Be Specific)	Consumption*		Maximum Heat Input (MMBTU/hr)
	avg/hr	max./hr	

*Units: Natural Gas--MMCF/hr; Fuel Oils--gallons/hr; Coal, wood, refuse, other--lbs/hr.

Fuel Analysis:

Percent Sulfur: _____ Percent Ash: _____

Density: _____ lbs/gal Typical Percent Nitrogen: _____

Heat Capacity: _____ BTU/lb _____ BTU/gal

Other Fuel Contaminants (which may cause air pollution): _____

F. If applicable, indicate the percent of fuel used for space heating.

Annual Average _____ Maximum _____

G. Indicate liquid or solid wastes generated and method of disposal.

H. Emission Stack Geometry and Flow Characteristics (Provide data for each stack):

Stack Height: 35' ft. Stack Diameter: 2.83 ft.
 Gas Flow Rate: -- ACFM 18,029 DSCFM Gas Exit Temperature: ambient °F.
 Water Vapor Contents: ambient % Velocity: 47.8 FPS

* at 1/2" water static pressure see attachment 1 part I

SECTION IV: INCINERATOR INFORMATION N/A

Type of Waste	Type 0 (Plastics)	Type I (Rubbish)	Type II (Refuse)	Type III (Garbage)	Type IV (Pathological)	Type V (Liq. & Gas By-prod.)	Type VI (Solid By-prod.)
Actual lb/hr Incinerated							
Uncontrolled (lbs/hr)							

Description of Waste: _____

Total Weight Incinerated (lbs/hr) _____ Design Capacity (lbs/hr) _____

Approximate Number of Hours of Operation per day _____ day/wk _____ wks/yr _____

Manufacturer: _____

Date Constructed _____ Model No. _____

	Volume (ft) ³	Heat Release (BTU/hr)	Fuel		Temperature (°F)
			Type	BTU/hr	
Primary Chamber					
Secondary Chamber					

Stack Height: _____ ft. Stack Diameter: _____ Stack Temp. _____

Gas Flow Rate: _____ ACFM _____ DSCFM* Velocity: _____ FPS

If 50 or more tons per day design capacity, submit the emissions rate in grains per standard cubic foot dry gas corrected to 50% excess air.

Type of pollution control devices: Cyclone Wet Scrubber Afterburner
 Other (specify) _____

Brief description of operating characteristics of control devices: _____

Ultimate disposal of any effluent other than that emitted from the stack (scrubber water, ash, etc.):

NOTE: Items 2, 3, 4, 6, 7, 8, and 10 in Section V must be included where applicable.

SECTION V: SUPPLEMENTAL REQUIREMENTS

Please provide the following supplements where required for this application.

1. Total process input rate and product weight -- show derivation [Rule 17-2.100(127)]
2. To a construction application, attach basis of emission estimate (e.g., design calculations, design drawings, pertinent manufacturer's test data, etc.) and attach proposed methods (e.g., FR Part 60 Methods 1, 2, 3, 4, 5) to show proof of compliance with applicable standards. To an operation application, attach test results or methods used to show proof of compliance. Information provided when applying for an operation permit from a construction permit shall be indicative of the time at which the test was made.
3. Attach basis of potential discharge (e.g., emission factor, that is, AP42 test).
4. With construction permit application, include design details for all air pollution control systems (e.g., for baghouse include cloth to air ratio; for scrubber include cross-section sketch, design pressure drop, etc.)
5. With construction permit application, attach derivation of control device(s) efficiency. Include test or design data. Items 2, 3 and 5 should be consistent: actual emissions = potential (1-efficiency).
6. An 8 1/2" x 11" flow diagram which will, without revealing trade secrets, identify the individual operations and/or processes. Indicate where raw materials enter, where solid and liquid waste exit, where gaseous emissions and/or airborne particles are evolved and where finished products are obtained.
7. An 8 1/2" x 11" plot plan showing the location of the establishment, and points of airborne emissions, in relation to the surrounding area, residences and other permanent structures and roadways (Example: Copy of relevant portion of USGS topographic map).
8. An 8 1/2" x 11" plot plan of facility showing the location of manufacturing processes and outlets for airborne emissions. Relate all flows to the flow diagram.

9. The appropriate application fee in accordance with Rule 17-4.05. The check should be made payable to the Department of Environmental Regulation.

10. With an application for operation permit, attach a Certificate of Completion of Construction indicating that the source was constructed as shown in the construction permit.

SECTION VI: BEST AVAILABLE CONTROL TECHNOLOGY

A. Are standards of performance for new stationary sources pursuant to 40 C.F.R. Part 60 applicable to the source?

[] Yes [] No

Contaminant

Rate or Concentration

Contaminant	Rate or Concentration

B. Has EPA declared the best available control technology for this class of sources (if yes, attach copy)

[] Yes [] No

Contaminant

Rate or Concentration

Contaminant	Rate or Concentration

C. What emission levels do you propose as best available control technology?

Contaminant

Rate or Concentration

Contaminant	Rate or Concentration

D. Describe the existing control and treatment technology (if any).

- 1. Control Device/System:
- 2. Operating Principles:
- 3. Efficiency:*
- 4. Capital Costs:

*Explain method of determining

j. Applicability to manufacturing processes:

k. Ability to construct with control device, install in available space, and operate within proposed levels:

3.

a. Control Device:

b. Operating Principles:

c. Efficiency:¹

d. Capital Cost:

e. Useful Life:

f. Operating Cost:

g. Energy:²

h. Maintenance Cost:

i. Availability of construction materials and process chemicals:

j. Applicability to manufacturing processes:

k. Ability to construct with control device, install in available space, and operate within proposed levels:

4.

a. Control Device:

b. Operating Principles:

c. Efficiency:¹

d. Capital Costs:

e. Useful Life:

f. Operating Cost:

g. Energy:²

h. Maintenance Cost:

i. Availability of construction materials and process chemicals:

j. Applicability to manufacturing processes:

k. Ability to construct with control device, install in available space, and operate within proposed levels:

F. Describe the control technology selected:

1. Control Device:

2. Efficiency:¹

3. Capital Cost:

4. Useful Life:

5. Operating Cost:

6. Energy:²

7. Maintenance Cost:

8. Manufacturer:

9. Other locations where employed on similar processes:

a. (1) Company:

(2) Mailing Address:

(3) City:

(4) State:

¹Explain method of determining efficiency.

²Energy to be reported in units of electrical power - KWH design rate.

- (5) Environmental Manager:
- (6) Telephone No.:
- (7) Emissions:¹

Contaminant	Rate or Concentration

(8) Process Rate:¹

- b. (1) Company:
- (2) Mailing Address:
- (3) City: (4) State:
- (5) Environmental Manager:
- (6) Telephone No.:
- (7) Emissions:¹

Contaminant	Rate or Concentration

(8) Process Rate:¹

10. Reason for selection and description of systems:

¹Applicant must provide this information when available. Should this information not be available, applicant must state the reason(s) why.

SECTION VII - PREVENTION OF SIGNIFICANT DETERIORATION

A. Company Monitored Data

1. _____ no. sites _____ TSP () SO₂* _____ Wind spd/dir

Period of Monitoring _____ / _____ / _____ to _____ / _____ / _____
month day year month day year

Other data recorded _____

Attach all data or statistical summaries to this application.

*Specify bubbler (B) or continuous (C).

2. Instrumentation, Field and Laboratory

a. Was instrumentation EPA referenced or its equivalent? [] Yes [] No

b. Was instrumentation calibrated in accordance with Department procedures?
[] Yes [] No [] Unknown

B. Meteorological Data Used for Air Quality Modeling

1. Year(s) of data from ____ / ____ / ____ to ____ / ____ / ____
month day year month day year

2. Surface data obtained from (location) _____

3. Upper air (mixing height) data obtained from (location) _____

4. Stability wind rose (STAR) data obtained from (location) _____

C. Computer Models Used

1. _____ Modified? If yes, attach description.

2. _____ Modified? If yes, attach description.

3. _____ Modified? If yes, attach description.

4. _____ Modified? If yes, attach description.

Attach copies of all final model runs showing input data, receptor locations, and principle output tables.

D. Applicants Maximum Allowable Emission Data

Pollutant	Emission Rate
TSP	_____ grams/sec
SO ²	_____ grama/sec

E. Emission Data Used in Modeling

Attach list of emission sources. Emission data required is source name, description of point source (on NEDS point number), UTM coordinstes, stack data, allowable emissions, and normal operating time.

F. Attach all other information supportive to the PSD review.

G. Discuss the social and economic impact of the selected technology versus other applicable technologies (i.e., jobs, payroll, production, taxes, energy, etc.). Include assesment of the environmental impact of the sources.

H. Attach scientific, engineering, and technical material, reports, publications, journals, and other competent relevant information describing the theory and application of the requested best available control technology.

Attachment #1

A. Quantities of Paints and Thinners Used:

Table 1 - Quantities and Varieties of Paints Used*

<u>Type of Paint</u>	<u>Approx. Daily Usage</u>	<u>Percentage Thinner</u>
2-part polyurethane	35 gal*	50% (thinned for application)
2-part acrylic enamel	18 gal*	50% (thinned for application)
2-part epoxy primer	2.2 gal*	20% (thinned for application)
other primers	0.8 gal*	20% (thinned for application)

*Including volume of thinners added

*AP-42 supplement 12, April 1981 states, "two part catalyzed coatings to be dried, powder coatings, hot melts, and radiation cured coatings contain essentially no volatile organic compounds although some monomers and other lower molecular weight organics may volatilize." Therefore, the total VOC emission from these two part systems comes from the solvent used to thin them prior to spraying.

Table 2 - Volumes of Thinners Used

<u>Type of Paint</u>	<u>Daily Usage</u>	<u>Yearly Usage</u>
2-part polyurethane	17.5 gal	4550 gal*
2-part acrylic enamel	9.0 gal	2340 gal*
2-part epoxy primer	0.44 gal	114 gal*
other primers	0.16	41.6 gal* (includes only solvents added as thinners)

*Based on 5 day/week, 52 weeks/year

B. Calculation of Density (lbs/gal) for a Typical Manufactures Thinner Formulation Used with Two Part Coating Systems:

Calculations for the density of the thinning solvents used for the two part coating systems is based on the composition of Ditzler DTR 60Z reducing solvent which is typical of the solvent mixtures used.

Petroleum Distillates	35%	(Approx. 6.5 lbs/gal, based on mineral spirits)
Toluol (toluene)	25%	(7.26 lbs/gal)
Acetone	15%	(6.59 lbs/gal)
Ethyl Acetate	10%	(7.51 lbs/gal)
Aromatic Hydrocarbon	15%	(Approx. 7.2 lbs/gal, based on xylene)

Contributions of Solvents to Mixture Density:

Petroleum distillates	(0.35) (6.5 lbs/gal) =	2.28
Toluol (toluene)	(0.25) (7.26 lbs/gal) =	1.82
Acetone	(0.15) (6.59 lbs/gal) =	0.99
Ethyl Acetate	(0.10) (7.51 lbs/gal) =	0.75
Aromatic Hydrocarbon	(0.15) (7.2 lbs/gal) =	<u>1.1</u>

Mixture density= 6.94 lbs/gal

C. Solvent Emissions from the Use of Two Part Coating Systems:

Solvent emissions from the two part coating systems are limited to the amount of thinning solvents used to achieve high quality finishes (See Table #1)

Table 3 - Total Emissions from Two Part Coating Systems

<u>Type of Paint</u>	<u>Volumes of Thinners Used</u>	<u>Yearly VOC Emissions</u>
2-part polyurethane	4550 gal/yr.	15.8 T/yr.
2-part acrylic enamel	2340 gal/yr.	8.1 T/yr.
2-part epoxy primer	114 gal/yr.	0.4 T/yr.
other primers	41.6 gal/yr.	0.14 T/yr.

Sample calculation for 2-part polyurethane

4550 gallon thinners used per year for 2-part polyurethane system, density of thinner is approx. 6.94 lbs/gal:

$$[(4,550 \text{ gal}) (6.94 \text{ lbs/gal})] \div 2,000 \text{ lbs/ton} = 15.8 \text{ T/yr.}$$

D. Solvent Emissions from the One Part Primers (Other Primers)

The solvent emissions from the one-part "other primers" is composed of two components - the solvents already present in the paint formulation and the solvents added to thin the primer prior to application.

VOC emissions from solvents already present:
approximate yearly usage volume = 208 gallons thinned with 20% thinner or 166.4 gallons unthinned.

AP-42 supplement 12, table 4.2.2.1-2 states that surfacer primer are typically 49% solids by volume which equates to 51% solvents by volume.

(166.4 gal unthinned primer) (0.51) = 84.9 gal solvents
the solvent used in these one part primers is typically toluene whose density is 7.26 lbs/gallon, therefore: (84.9 gal/yr.) (7.26 lbs/gal) = 616.4 lbs/yr or 0.31 tons/yr from the unthinned portion of the primer.

The thinner used amounts to 208 gal/yr. total - 166.4 gal/yr. unthinned primer or 41.6 gals, all of which ends up as VOC emissions: (41.6 gal/yr) (6.94 lbs/gal*) = 288 lbs/yr. or 0.14 T/yr.

*See Part B of this attachment

Total solvent emissions from one part primers: (0.31 T/yr. from primer itself) + (0.14 T/yr. from thinning solvents) = 0.45 T/yr.

Total Yearly VOC Emissions
 September 13, 1983
 Page Three

E. Total Yearly VOC Emissions:

<u>Source of Emissions</u>	<u>Amount</u>
2-part polyurethane system*	15.8 T/yr.
2-part acrylic enamel*	8.1 T/yr.
2-part epoxy primer*	0.4 T/yr.
other primers*	0.45 T/yr.
*Includes Thinners Total:	24.75 T/yr.

F. Particulate Emissions:

Estimates for overspray percents obtained from AP-40, second edition, page 861:

<u>Method of Spraying</u>	<u>% Over Spray</u>		
	<u>Flat Surface</u>	<u>Table Leg</u>	<u>Bird Cage</u>
Air atomization	50%	85%	90%

Binks manufacturing quotes a 95% efficiency rating for its paint arrester type filters (model 29-893) when used with enamels, primers and two part systems.

The items to be coated in this booth can be broken down as follows:

20%	wooden furniture	(50% flat-50% table leg surfaces)
55%	automotive type	(100% flat type surfaces)
15%	flat surfaces	(100% flat type surfaces)
10%	posts and frames	(99% table leg-1% bird cage type surfaces)

Table 4 - Composite Overspray Rates

<u>Type Surface</u>	<u>Composite Overspray Percentage</u>
Wooden furniture	67.5%
Automotive type	50%
Flat surfaces	50%
posts and frames	85.1%

Unthinned 2-part coating systems can be viewed as being essentially all particulate in content. (AP-42, supplement 12, section 4.2.2-1)

Table 5 - Volumes of Unthinned 2-part Coating Systems

<u>Paint Type</u>	<u>Volume of Unthinned Material</u>		<u>Weight</u>
2-part polyurethane	4550 gal	(9.2 lbs/gal)*	20.9 tons
2-part acrylic enamel	2340 gal	(8.9 lbs/gal)*	10.4 tons
2-part epoxy primer	458 gal	(10.5 lbs/gal)*	2.4 tons

*See AP-42 Table 4.2.2.1-2

Particulate emissions from two part coating systems:
 The calculations proceed as follows:

(Tons of coating system) x (Percentage of items coated) x (Overspray percentage) = tons of particulate in overspray

Sample calculation for 2-part polyurethane system:

(20.9 tons) (20% wooden furniture) (6.75% overspray) = 2.82 tons
 (20.9 tons) (70% flat type surfaces) (50% overspray) = 7.32 tons
 (20.9 tons) (10% postsand frames) (85.1% overspray) = 1.78 tons
 Total particulate overspray from 2-part polyurethane = 11.9 tons/yr.

Efficiency of paint arrestor filter is 95%, therefore, 5% of total overspray is emitted from booth (11.9 tons/yr.) (.05) = 0.60 tons/yr. emitted.

Table 6 - Total Particulate Emissions From 2-part Coating Systems

<u>Paint Type</u>	<u>Ton/Yr. Particulates Emitted</u>	<u>Total Particulate Overspray</u>
2-part polyurethane	0.60 tons/yr.	11.9 tons/yr.
2-part acrylic enamel	0.30 tons/yr.	6.0 tons/yr.
2-part epoxy primer	0.07 tons/yr.	1.4 tons/yr.
Total emitted from 2-part systems	0.97 tons/yr.	

Particulate emissions from "other primers"

AP-42, Table 4.2.2.1-2 states that typical surfacer primers are 49% solids and have a density of 9.4 lbs/gal yearly usage of "other primers" is approximately 166.4 gal/yr.

(166.4 gal/yr) (9.4 lbs/gal) (0.49 solids) = 766.5 lbs/yr. particulate sprayed
 = 0.38 T/yr.

The rest of the calculation proceeds as the above to yield total particulate emissions from "other primers" of 0.01 T/yr.

G. Yearly Total Particulate Emissions

Total from 2-part systems 0.97 tons/yr.
 Total from other primers 0.01 tons/yr.
 Total: 0.98 tons/yr.

Potential emission without filters
 Total from 2-part systems = 19.3 tons/yr.
 Total from "other primers" = 0.2 tons/yr.
 Total potential emissions = 19.5 tons/yr.

H. Contaminants and Utilization Rates:

Table 7 - Utilization Rates

Type of Paints	Approx. Daily Usage (Unthinned Paints)	Density	Utilization Rates
2-part polyurethane	17.5 gal	9.2 lbs/gal*	10.1 lbs/hr.
2-part acrylic	9 gal	8.9 lbs/gal*	5.01 lbs/hr.
2-part epoxy primer	1.8 gal	10.5 lbs/gal*	1.2 lbs/hr.
other primers	0.6 gal	9.4 lbs/gal*	0.4 lbs/gal
thinners	27.1 gal	6.94 lbs/gal**	11.8 lbs/gal

Table 8 - Weight Percent of Contaminants

Type of Paint	Weight Percents		Source of Figure
	VOC	Particulate	
2-part polyurethane	0%	100%	AP-42, 4.2.2.1
2-part acrylic enamel	0%	100%	AP-42, 4.2.2.1
2-part epoxy primer	0%	100%	AP-42, 4.2.2.1
other primers	51%	49%	AP-42, 4.2.2.1-2
thinners	100%	0%	----

I. Calculation of Gas Flow Rates and Velocities

Exhaust Fans:

Booth is equipped with two exhaust fans from Binks Manufacturing, model 30-4313 rated at 18029 SCFM at 1/4" WC static pressure (See Attachment #2)

Total air flow from both fans 36058 SCFM at 1/4" WC static pressure

Stack diameter 2.83 ft.
 radius 1.415 ft.

Cross sectional area of stack = $TTr^2 = (3.14) (1.415)^2 = 6.29$ sq. ft.

Air velocity from stack = $(18029 \text{ SCFM} \div 6.29 \text{ sq. ft.})$

= 2866 FPM

= 47.8 FPS through each of two vents

Attachment #2

Attachment 2 - Flow Diagram

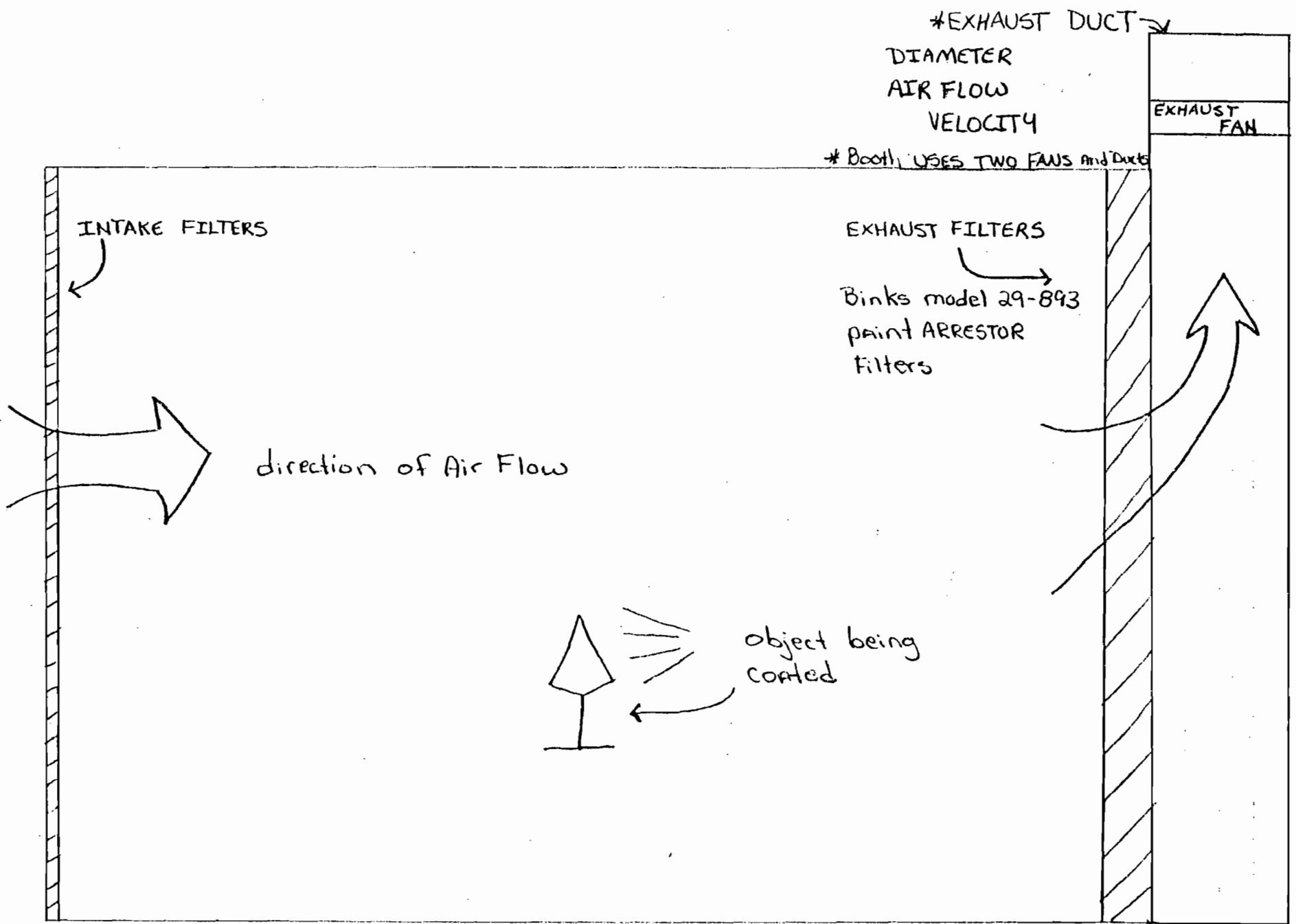

Attachment #3

BEST AVAILABLE COPY

SOURCES OF AIR CONTAMINANTS

1. Central Shops
2. WDW Laundry/Dry Cleaning
3. RCUC Trubines, boilers
4. Waste incinerator, closed.

other sources not shown:
boilers and emergency generators
at EPCOT Central Energy Plant

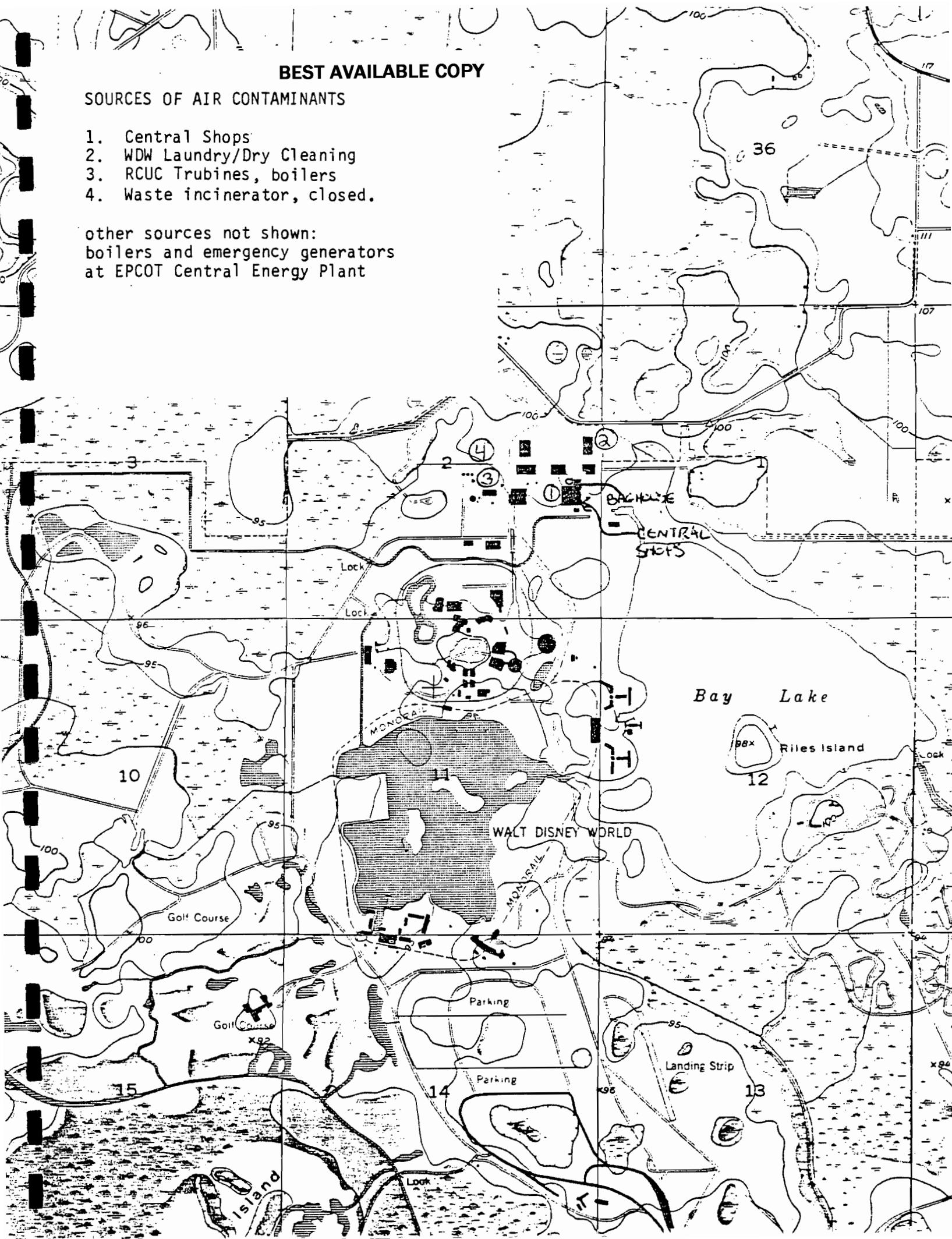

↑ to other shops

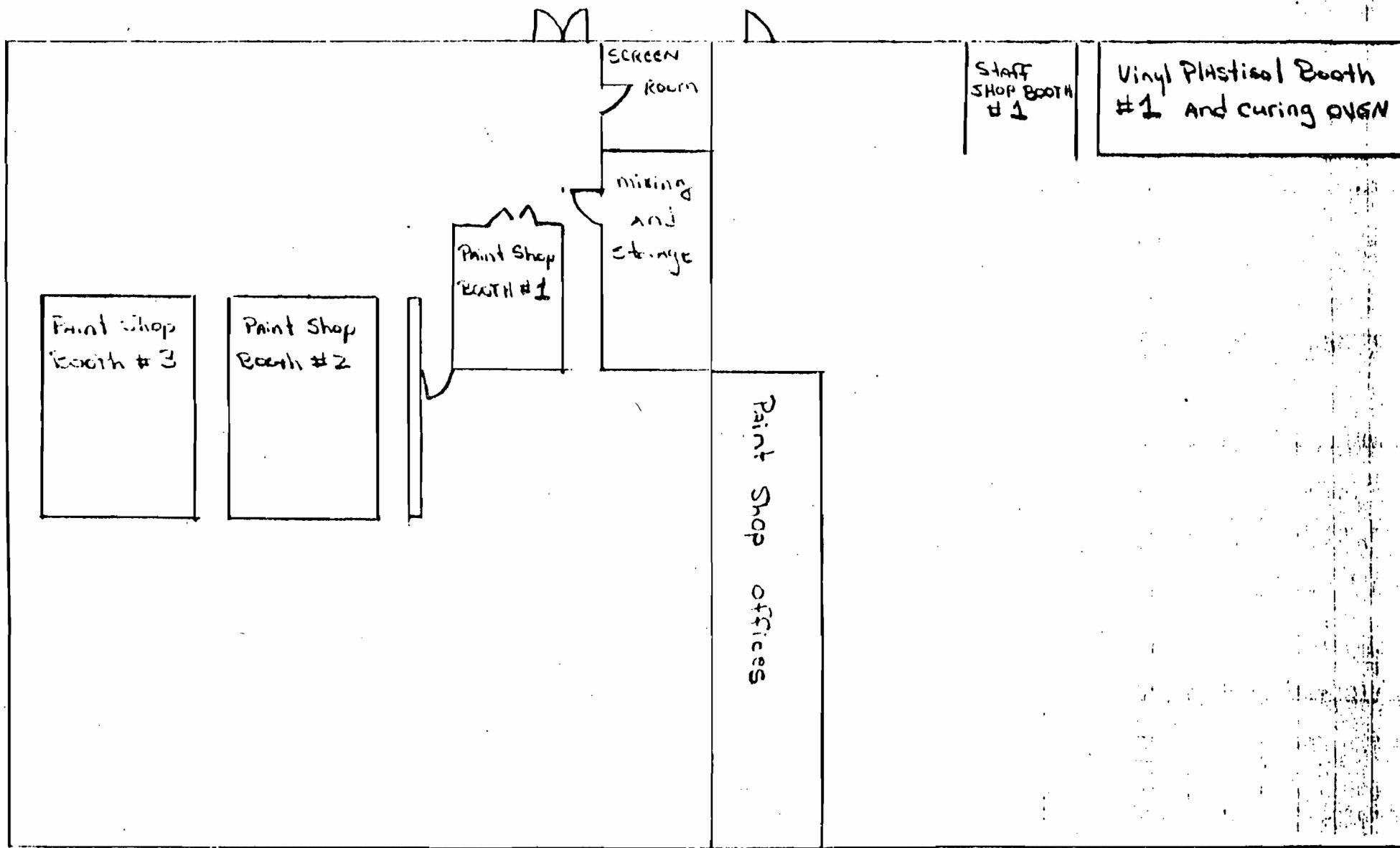

SKETCH OF Facility Layout, not to scale



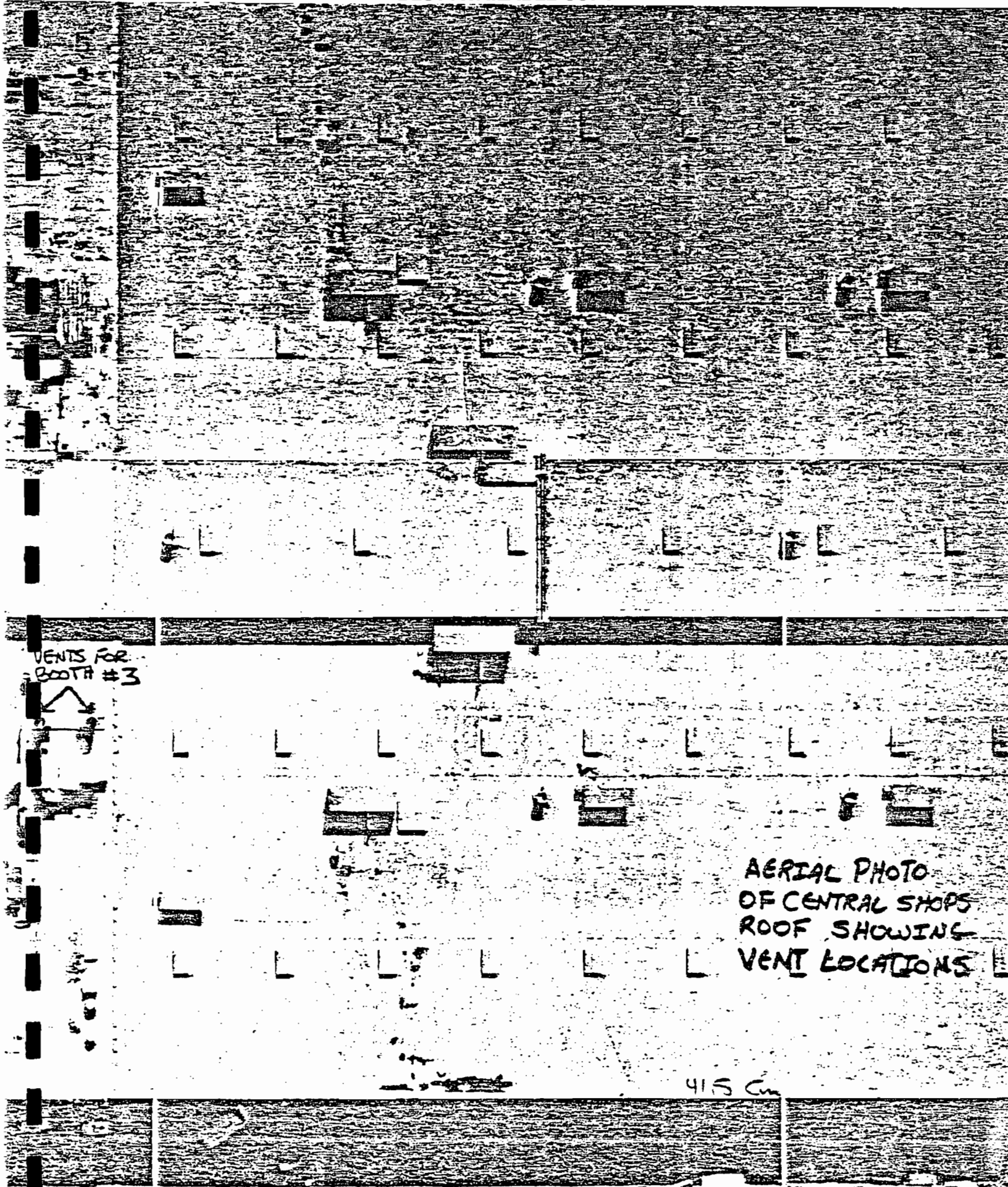

VENTS FOR
BOOTH #3

AERIAL PHOTO
OF CENTRAL SHOPS
ROOF SHOWING
VENT LOCATIONS

415 C



VENTS FOR BOOTH

RECEIVED
 Sept 1953
 Soil Johns River
 District
 10345 G 819

Vents
 for Booth

NE CORNER

AC 48-108741

BEST AVAILABLE COPY

AC 48-75834

STATE OF FLORIDA

DEPARTMENT OF ENVIRONMENTAL REGULATION

ST. JOHNS RIVER DISTRICT

3319 MAGUIRE BOULEVARD SUITE 232 ORLANDO, FLORIDA 32803

PAID 100 SEP 22 1983

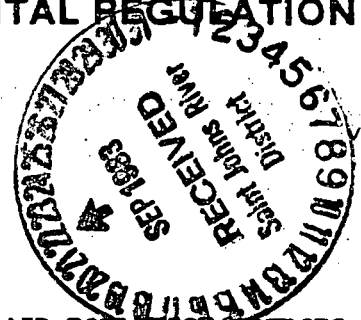
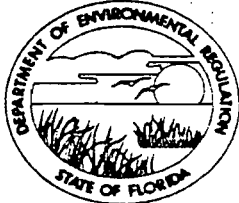

BOB GRAHAM GOVERNOR VICTORIA J. TSCHINKEL SECRETARY ALEX SENKEVICH DISTRICT MANAGER

OCT 6 1983

SAINT JOHNS RIVER DISTRICT

APPLICATION TO OPERATE/CONSTRUCT AIR POLLUTION SOURCES

BAOM

SOURCE TYPE: Spray Paint Booth [] New¹ [] Existing¹

APPLICATION TYPE: [X] Construction [] Operation [] Modification

COMPANY NAME: WALT DISNEY WORLD Co., Inc. COUNTY: Orange

Identify the specific emission point source(s) addressed in this application (i.e. Lime Kiln No. 4 with Venturi Scrubber; Peaking Unit No. 2, Gas Fired) NSA Paint Shop paint Booth #2

SOURCE LOCATION: Street Facilities Way City Bay Street

UTM: East 443516 North 3144309

Latitude 28 ° 25 ' 32 "N Longitude 81 ° 34 ' 36 "W

APPLICANT NAME AND TITLE: Edward B. Crowell, Vice President Facilities Division

APPLICANT ADDRESS: P. O. Box 40 Lake Buena Vista, FL 32830

SECTION I: STATEMENTS BY APPLICANT AND ENGINEER

A. APPLICANT

I am the undersigned owner or authorized representative* of WALT DISNEY WORLD Co.

I certify that the statements made in this application for a construction permit are true, correct and complete to the best of my knowledge and belief. Further, I agree to maintain and operate the pollution control source and pollution control facilities in such a manner as to comply with the provision of Chapter 403, Florida Statutes, and all the rules and regulations of the department and revisions thereof. I also understand that a permit, if granted by the department, will be non-transferable and I will promptly notify the department upon sale or legal transfer of the permitted establishment.

*Attach letter of authorization

Signed: Edward B. Crowell

Edward B. Crowell, V.P. Facilities Division Name and Title (Please Type)

Date: Telephone No. (305) 824-7700

B. PROFESSIONAL ENGINEER REGISTERED IN FLORIDA (where required by Chapter 471, F.S.)

This is to certify that the engineering features of this pollution control project have been designed/examined by me and found to be in conformity with modern engineering principles applicable to the treatment and disposal of pollutants characterized in the permit application. There is reasonable assurance, in my professional judgment, that

¹ See Florida Administrative Code Rule 17-2.100(57) and (104)

BEST AVAILABLE COPY

the pollution control facilities, when properly maintained and operated, will discharge an effluent that complies with all applicable statutes of the State of Florida and the rules and regulations of the department. It is also agreed that the undersigned will furnish, if authorized by the owner, the applicant a set of instructions for the proper maintenance and operation of the pollution control facilities and, if applicable, pollution sources.

Signed Ted W. McKim
TED W. McKim
Name (Please Type)

Reedy Creek Utilities Co., Inc.
Company Name (Please Type)

P.O. Box 40 Lake Buena Vista, FL 32830
Mailing Address (Please Type)

Florida Registration No. 25555 Date: 9/21/83 Telephone No. (305) 824-4950

SECTION II: GENERAL PROJECT INFORMATION

A. Describe the nature and extent of the project. Refer to pollution control equipment, and expected improvements in source performance as a result of installation. State whether the project will result in full compliance. Attach additional sheet if necessary:

Spray paint booth for coating a variety of objects including vehicles, wooden furniture, trash cans, ride components, posts and frames using 2 part polyurethane, 2 part acrylic, epoxy primers and other primer coating systems.

B. Schedule of project covered in this application (Construction Permit Application Only)

Start of Construction existing booth Completion of Construction N/A

C. Costs of pollution control system(s): (Note: Show breakdown of estimated costs only for individual components/units of the project serving pollution control purposes. Information on actual costs shall be furnished with the application for operation permit.)

N/A

D. Indicate any previous DER permits, orders and notices associated with the emission point, including permit issuance and expiration dates. NONE

Permit applications called in by Chuck Collins of Florida DER to be submitted by 9/16/83.

E. Requested permitted equipment operating time: hrs/day 16; days/wk 5; wks/yr 52; if power plant, hrs/yr _____; if seasonal, describe: _____

F. If this is a new source or major modification, answer the following questions. (Yes or No)

1. Is this source in a non-attainment area for a particular pollutant? yes

a. If yes, has "offset" been applied? no

b. If yes, has "Lowest Achievable Emission Rate" been applied? no

c. If yes, list non-attainment pollutants. VOC

2. Does best available control technology (BACT) apply to this source? If yes, see Section VI. no

3. Does the State "Prevention of Significant Deterioration" (PSD) requirement apply to this source? If yes, see Sections VI and VII. no

4. Do "Standards of Performance for New Stationary Sources" (NSPS) apply to this source? no

5. Do "National Emission Standards for Hazardous Air Pollutants" (NESHAP) apply to this source? no

H. Do "Reasonably Available Control Technology" (RACT) requirements apply to this source? no

a. If yes, for what pollutants? _____

b. If yes, in addition to the information required in this form, any information requested in Rule 17-2.650 must be submitted.

Attach all supportive information related to any answer of "Yes". Attach any justification for any answer of "No" that might be considered questionable.

No RACT guidelines for this type of surface coating operation.

BEST AVAILABLE COPY

SECTION III: AIR POLLUTION SOURCES & CONTROL DEVICES (Other than Incinerators)

A Raw Materials and Chemicals Used in your Process, if applicable:

See attachment #1, Part H

Description	Contaminants		Utilization Rate - lbs/hr	Relate to Flow Diagram
	Type	% WE		
2-part polyurethane	VOC Particulate	0%/100%	20.2	Paint application
2-part acrylic enamel	VOC/Partic.	0%/100%	10.0	Paint application
2-part epoxy primer	VOC/Partic.	0%/100%	2.4	Paint application
conventional primer	VOC/Partic.	0%/100%	0.8	Paint application
Systems				
Thinners	VOC/Partic.	0%/100%		Thinner for paint applic

B Process Rate, if applicable: (See Section V, Item 1) N/A

1. Total Process Input Rate (lbs/hr): _____

2. Product Weight (lbs/hr): _____

C Airborne Contaminants Emitted: (Information in this table must be submitted for each emission point, use additional sheets as necessary) See attachment #1 Parts A-G for calculations

Name of contaminant	Emission ¹		Allowed Emission Rate per Rule 17-2	Allowable ³ Emission lbs/hr	Potential ⁴ Emission		Relate to Flow Diagram
	Maximum lbs/hr	Actual T/yr			lbs/yr	T/yr	
VOC	23.8	49.5			99,000	49.5	
Particulate	0.93	1.94			79,000	39.5	

¹See Section V, Item 2.

²Reference applicable emission standards and units (e.g. Rule 17-2.600(5)(b)2. Table II, E. (1) - 0.1 pounds per million BTU heat input)

³Calculated from operating rate and applicable standard.

⁴Emission, if source operated without control (See Section V, Item 3).

D. Control Devices: (See Section V, Item 4)

Name and Type (Model & Serial No.)	Contaminant	Efficiency	Range of Particles Size Collected (in microns) (If applicable)	Basis for Efficiency (Section V Item 5)
Binks Paint arres.type Filters model #29-893	Particulate	95%	N/A	Manufac. Specs.
Filter Bank dimensions 2 filter banks 6.7 ft. x 13.3 ft. for a total of 178 sq. ft.				

E. Fuels N/A

Type (Be Specific)	Consumption*		Maximum Heat Input (MMBTU/hr)
	avg/hr	max./hr	

*Units: Natural Gas--MMCF/hr; Fuel Oils--gallons/hr; Coal, wood, refuse, other--lbs/hr.

Fuel Analysis:

Percent Sulfur: _____ Percent Ash: _____

Density: _____ lbs/gal Typical Percent Nitrogen: _____

Heat Capacity: _____ BTU/lb _____ BTU/gal

Other Fuel Contaminants (which may cause air pollution): _____

F. If applicable, indicate the percent of fuel used for space heating.

Annual Average _____ Maximum _____

G. Indicate liquid or solid waste generated and method of disposal.

4. Emission Stack Geometry and Flow Characteristics (Provide data for each stack):

Stack Height: 35' ft. Stack Diameter: 3.5 ft.
 Gas Flow Rate: ACFM 24,250 DSCFM Gas Exit Temperature: ambient °F.
 Water Vapor Contents: ambient % Velocity: 42.1 FPS
 *At 4" water static pressure See Attachment 1, Part I.

SECTION IV: INCINERATOR INFORMATION

N/A

Type of Waste	Type 0 (Plastics)	Type I (Rubbish)	Type II (Refuse)	Type III (Garbage)	Type IV (Pathological)	Type V (Liq. & Gas By-prod.)	Type VI (Solid By-prod.)
Actual lb/hr Incinerated							
Uncontrolled (lbs/hr)							

Description of Waste: _____

Total Weight Incinerated (lbs/hr) _____ Design Capacity (lbs/hr) _____

Approximate Number of Hours of Operation per day _____ day/wk _____ wks/yr _____

Manufacturer: _____

Site Constructed _____ Model No. _____

	Volume (ft) ³	Heat Release (BTU/hr)	Fuel		Temperature (°F)
			Type	BTU/hr	
Primary Chamber					
Secondary Chamber					

Stack Height: _____ ft. Stack Diameter: _____ Stack Temp. _____

Gas Flow Rate: _____ ACFM _____ DSCFM* Velocity: _____ FPS

If 50 or more tons per day design capacity, submit the emissions rate in grains per standard cubic foot dry gas corrected to 50% excess air.

Type of pollution control devices: Cyclone Wet Scrubber Afterburner

Other (specify) _____

Brief description of operating characteristics of control devices: _____

Ultimate disposal of any effluent other than that emitted from the stack (scrubber water, ash, etc.):

NOTE: Items 2, 3, 4, 6, 7, 8, and 10 in Section V must be included where applicable.

SECTION V: SUPPLEMENTAL REQUIREMENTS

Please provide the following supplements where required for this application.

1. Total process input rate and product weight -- show derivation [Rule 17-2.100(127)]
2. To a construction application, attach basis of emission estimate (e.g., design calculations, design drawings, pertinent manufacturer's test data, etc.) and attach proposed methods (e.g., FR Part 60 Methods 1, 2, 3, 4, 5) to show proof of compliance with applicable standards. To an operation application, attach test results or methods used to show proof of compliance. Information provided when applying for an operation permit from a construction permit shall be indicative of the time at which the test was made.
3. Attach basis of potential discharge (e.g., emission factor, that is, AP42 test).
4. With construction permit application, include design details for all air pollution control systems (e.g., for baghouse include cloth to air ratio; for scrubber include cross-section sketch, design pressure drop, etc.)
5. With construction permit application, attach derivation of control device(s) efficiency. Include test or design data. Items 2, 3 and 5 should be consistent: actual emissions = potential (1-efficiency).
6. An 8 1/2" x 11" flow diagram which will, without revealing trade secrets, identify the individual operations and/or processes. Indicate where raw materials enter, where solid and liquid waste exit, where gaseous emissions and/or airborne particles are evolved and where finished products are obtained.
7. An 8 1/2" x 11" plot plan showing the location of the establishment, and points of airborne emissions, in relation to the surrounding area, residences and other permanent structures and roadways (Example: Copy of relevant portion of USGS topographic map).
8. An 8 1/2" x 11" plot plan of facility showing the location of manufacturing processes and outlets for airborne emissions. Relate all flows to the flow diagram.

BEST AVAILABLE COPY

9. The appropriate application fee in accordance with Rule 17-4.05. The check should be made payable to the Department of Environmental Regulation.
10. With an application for operation permit, attach a Certificate of Completion of Construction indicating that the source was constructed as shown in the construction permit.

SECTION VI: BEST AVAILABLE CONTROL TECHNOLOGY

A. Are standards of performance for new stationary sources pursuant to 40 C.F.R. Part 60 applicable to the source?

Yes No

Contaminant

Rate or Concentration

B. Has EPA declared the best available control technology for this class of sources (If yes, attach copy)

Yes No

Contaminant

Rate or Concentration

C. What emission levels do you propose as best available control technology?

Contaminant

Rate or Concentration

D. Describe the existing control and treatment technology (if any).

1. Control Device/System:

2. Operating Principles:

3. Efficiency:*

4. Capital Costs:

*Explain method of determining

5. Useful Life:

6. Operating Costs:

7. Energy:

8. Maintenance Cost:

9. Emissions:

Contaminant

Rate or Concentration

Contaminant	Rate or Concentration

10. Stack Parameters

a. Height:

ft.

b. Diameter:

ft.

c. Flow Rate:

ACFM

d. Temperature:

°F.

e. Velocity:

FPS

E. Describe the control and treatment technology available (As many types as applicable, use additional pages if necessary).

1.

a. Control Device:

b. Operating Principles:

c. Efficiency:¹

d. Capital Cost:

e. Useful Life:

f. Operating Cost:

g. Energy:²

h. Maintenance Cost:

i. Availability of construction materials and process chemicals:

j. Applicability to manufacturing processes:

k. Ability to construct with control device, install in available space, and operate within proposed levels:

2.

a. Control Device:

b. Operating Principles:

c. Efficiency:¹

d. Capital Cost:

e. Useful Life:

f. Operating Cost:

g. Energy:²

h. Maintenance Cost:

i. Availability of construction materials and process chemicals:

¹Explain method of determining efficiency.

²Energy to be reported in units of electrical power - KWH design rate.

j. Applicability to manufacturing processes:

k. Ability to construct with control device, install in available space, and operate within proposed levels:

3.

a. Control Device:

b. Operating Principles:

c. Efficiency:¹

d. Capital Cost:

e. Useful Life:

f. Operating Cost:

g. Energy:²

h. Maintenance Cost:

i. Availability of construction materials and process chemicals:

j. Applicability to manufacturing processes:

k. Ability to construct with control device, install in available space, and operate within proposed levels:

4.

a. Control Device:

b. Operating Principles:

c. Efficiency:¹

d. Capital Costs:

e. Useful Life:

f. Operating Cost:

g. Energy:²

h. Maintenance Cost:

i. Availability of construction materials and process chemicals:

j. Applicability to manufacturing processes:

k. Ability to construct with control device, install in available space, and operate within proposed levels:

F. Describe the control technology selected:

1. Control Device:

2. Efficiency:¹

3. Capital Cost:

4. Useful Life:

5. Operating Cost:

6. Energy:²

7. Maintenance Cost:

8. Manufacturer:

9. Other locations where employed on similar processes:

a. (1) Company:

(2) Mailing Address:

(3) City:

(4) State:

¹ Explain method of determining efficiency.

² Energy to be reported in units of electrical power - KWH design rate.

(5) Environmental Manager:

(6) Telephone No.:

(7) Emissions:¹

Contaminant

Rate or Concentration

Contaminant	Rate or Concentration

(8) Process Rate:¹

b. (1) Company:

(2) Mailing Address:

(3) City:

(4) State:

(5) Environmental Manager:

(6) Telephone No.:

(7) Emissions:¹

Contaminant

Rate or Concentration

Contaminant	Rate or Concentration

(8) Process Rate:¹

10. Reason for selection and description of systems:

¹Applicant must provide this information when available. Should this information not be available, applicant must state the reason(s) why.

SECTION VII - PREVENTION OF SIGNIFICANT DETERIORATION

A. Company Monitored Data

1. _____ no. sites _____ TSP _____ () SO₂* _____ Wind spd/dir

Period of Monitoring _____ / _____ / _____ to _____ / _____ / _____
month day year month day year

Other data recorded _____

Attach all data or statistical summaries to this application.

*Specify bubbler (B) or continuous (C).

2. Instrumentation, Field and Laboratory

- a. Was instrumentation EPA referenced or its equivalent? Yes No
- b. Was instrumentation calibrated in accordance with Department procedures?
 Yes No Unknown

B. Meteorological Data Used for Air Quality Modeling

- 1. _____ Year(s) of data from _____ / _____ / _____ to _____ / _____ / _____
month day year month day year
- 2. Surface data obtained from (location) _____
- 3. Upper air (mixing height) data obtained from (location) _____
- 4. Stability wind rose (STAR) data obtained from (location) _____

C. Computer Models Used

- 1. _____ Modified? If yes, attach description.
- 2. _____ Modified? If yes, attach description.
- 3. _____ Modified? If yes, attach description.
- 4. _____ Modified? If yes, attach description.

Attach copies of all final model runs showing input data, receptor locations, and principle output tables.

D. Applicants Maximum Allowable Emission Data

Pollutant	Emission Rate
TSP	_____ grams/sec
SO ²	_____ grams/sec

E. Emission Data Used in Modeling

Attach list of emission sources. Emission data required is source name, description of point source (on NEDS point number), UTM coordinates, stack data, allowable emissions, and normal operating time.

F. Attach all other information supportive to the PSD review.

G. Discuss the social and economic impact of the selected technology versus other applicable technologies (i.e., jobs, payroll, production, taxes, energy, etc.). Include assessment of the environmental impact of the sources.

H. Attach scientific, engineering, and technical material, reports, publications, journals, and other competent relevant information describing the theory and application of the requested best available control technology.

Attachment #1

A. Quantities of Paints and Thinners Used:

Table 1 - Quantities and Varieties of Paints Used*

<u>Type of Paint</u>	<u>Approx. Daily Usage</u>	<u>Percentage Thinner</u>
2-part polyurethane	70 gal*	50% (thinned for application)
2-part acrylic enamel	36 gal*	50% (thinned for application)
2-part epoxy primer	4.4 gal*	20% (thinned for application)
other primers	1.6 gal*	20% (thinned for application)

*Including volume of thinners added

*AP-42 supplement 12, April 1981 states, "two part catalyzed coatings to be dried, powder coatings, hot melts, and radiation cured coatings contain essentially no volatile organic compounds although some monomers and other lower molecular weight organics may volatilize." Therefore, the total VOC emission from these two part systems comes from the solvent used to thin them prior to spraying.

Table 2 - Volumes of Thinners Used

<u>Type of Paint</u>	<u>Daily Usage</u>	<u>Yearly Usage</u>
2-part polyurethane	35	9100 gal*
2-part acrylic enamel	18	4680 gal*
2-part epoxy primer	0.88	228 gal*
other primers	0.32	83.2 gal* (includes only solvents added as thinners)

*Based on 5 day/week, 52 weeks/year

B. Calculation of Density (lbs/gal) for a Typical Manufactures Thinner Formulation Used with Two Part Coating Systems:

Calculations for the density of the thinning solvents used for the two part coating systems is based on the composition of Ditzler DTR 60Z reducing solvent which is typical of the solvent mixtures used.

Petroleum Distillates	35%	(Approx. 6.5 lbs/gal, based on mineral spirits)
Toluol (toluene)	25%	(7.26 lbs/gal)
Acetone	15%	(6.59 lbs/gal)
Ethyl Acetate	10%	(7.51 lbs/gal)
Aromatic Hydrocarbon	15%	(Approx. 7.2 lbs/gal, based on xylene)

Contributions of Solvents to Mixture Density:

Petroleum distillates	(0.35) (6.5 lbs/gal) =	2.28
Toluol (toluene)	(0.25) (7.26 lbs/gal) =	1.82
Acetone	(0.15) (6.59 lbs/gal) =	0.99
Ethyl Acetate	(0.10) (7.51 lbs/gal) =	0.75
Aromatic Hydrocarbon	(0.15) (7.2 lbs/gal) =	1.1

Mixture density = 6.94 lbs/gal

C. Solvent Emissions from the Use of Two Part Coating Systems:

Solvent emissions from the two part coating systems are limited to the amount of thinning solvents used to achieve high quality finishes (See Table #1)

Table 3 - Total Emissions from Two Part Coating Systems

<u>Type of Paint</u>	<u>Volumes of Thinners Used</u>	<u>Yearly VOC Emissions</u>
2-part polyurethane	9100 gal/yr.	31.6 T/yr.
2-part acrylic enamel	4680 gal/yr.	16.2 T/yr.
2-part epoxy primer	228 gal/yr.	0.8 T/yr.
other primers	83.2 gal/yr.	0.28 T/yr.

Sample calculation for 2-part polyurethane

9100 gallon thinners used per year for 2-part polyurethane system, density of thinner is approx. 6.94 lbs/gal:

$$[(9100 \text{ gal}) (6.94 \text{ lbs/gal})] \div 2,000 \text{ lbs/ton} = 31.6 \text{ T/yr.}$$

D. Solvent Emissions from the One Part Primers (Other Primers)

The solvent emissions from the one-part "other primers" is composed of two components - the solvents already present in the paint formulation and the solvents added to thin the primer prior to application.

VOC emissions from solvents already present:

approximate yearly usage volume = 416 gallons thinned with 20% thinner or 332.8 gallons unthinned.

AP-42 supplement 12, table 4.2.2.1-2 states that surfacer primer are typically 49% solids by volume which equates to 51% solvents by volume.

(332.8 gal unthinned primer) (0.51) = 169.7 gal solvents
 the solvent used in these one part primers is typically toluene whose density is 7.26 lbs/gallon, therefore: ~~(169.7 gal/yr.)~~ (7.26 lbs/gal) = ~~1232.2~~ 1232.2 lbs/yr or 0.31 tons/yr from the unthinned portion of the primer.
 1232.2 0.62

The thinner used amounts to 416 gal/yr. total - 332.8 gal/yr. unthinned primer or 83.2 gals, all of which ends up as VOC emissions: (83.2 gal/yr) (6.94 lbs/gal*) = 577.4 lbs/yr. or 0.29 T/yr.

*See Part B of this attachment

Total solvent emissions from one part primers: (0.62 T/yr. from primer itself) + (0.29 T/yr. from thinning solvents) = 0.91 T/yr.

Total Yearly VOC Emissions
 September 13, 1983
 Page Three

E. Total Yearly VOC Emissions:

<u>Source of Emissions</u>	<u>Amount</u>
2-part polyurethane system*	31.6 T/yr.
2-part acrylic enamel*	16.2 T/yr.
2-part epoxy primer*	0.8 T/yr.
other primers*	0.9 T/yr.
*Includes Thinners Total:	49.5 T/yr.

F. Particulate Emissions:

Estimates for overspray percents obtained from AP-40, second edition, page 861:

<u>Method of Spraying</u>	<u>% Over Spray</u>		
	<u>Flat Surface</u>	<u>Table Leg</u>	<u>Bird Cage</u>
Air atomization	50%	85%	90%

Binks manufacturing quotes a 95% efficiency rating for its paint arrestor type filters (model 29-893) when used with enamels, primers and two part systems.

The items to be coated in this booth can be broken down as follows:

20%	wooden furniture	(50% flat-50% table leg surfaces)
55%	automotive type	(100% flat type surfaces)
15%	flat surfaces	(100% flat type surfaces)
10%	posts and frames	(99% table leg-1% bird cage type surfaces)

Table 4 - Composite Overspray Rates

<u>Type Surface</u>	<u>Composite Overspray Percentage</u>
Wooden furniture	67.5%
Automotive type	50%
Flat surfaces	50%
posts and frames	85.1%

Unthinned 2-part coating systems can be viewed as being essentially all particulate in content. (AP-42, supplement 12, section 4.2.2-1)

Table 5 - Volumes of Unthinned 2-part Coating Systems

<u>Paint Type</u>	<u>Volume of Unthinned Material</u>		<u>Weight</u>
2-part polyurethane	9100 gal	(9.2 lbs/gal)*	41.9 tons
2-part acrylic enamel	4680 gal	(8.9 lbs/gal)*	20.8 tons
2-part epoxy primer	916 gal	(10.5 lbs/gal)*	4.8 tons

*See AP-42 Table 4.2.2.1-2

Particulate emissions from two part coating systems:
 The calculations proceed as follows:

$$(\text{Tons of coating system}) \times (\text{Percentage of items coated}) \times (\text{Overspray percentage}) = \text{tons of particulate in overspray}$$

Sample calculation for 2-part polyurethane system:

$$\begin{aligned} (41.9 \text{ tons}) (20\% \text{ wooden furniture}) (6.75\% \text{ overspray}) &= 5.66 \text{ tons} \\ (41.9 \text{ tons}) (70\% \text{ flat type surfaces}) (50\% \text{ overspray}) &= 14.7 \text{ tons} \\ (41.9 \text{ tons}) (10\% \text{ postsand frames}) (85.1\% \text{ overspray}) &= 3.57 \text{ tons} \\ \text{Total particulate overspray from 2-part polyurethane} &= 23.9 \text{ tons/yr.} \end{aligned}$$

Efficiency of paint arrestor filter is 95%, therefore, 5% of total overspray is emitted from booth (23.9 tons/yr.) (.05) = 1.20 tons/yr. emitted.

Table 6 - Total Particulate Emissions From 2-part Coating Systems

<u>Paint Type</u>	<u>Ton/Yr. Particulates Emitted</u>	<u>Total Particulate Overspray</u>
2-part polyurethane	1.20 tons/yr.	23.9 tons/yr.
2-part acrylic enamel	0.60 tons/yr.	12.0 tons/yr.
2-part epoxy primer	0.14 tons/yr.	2.8 tons/yr.
Total emitted from 2-part systems	1.94 tons/yr.	

Particulate emissions from "other primers"

AP-42, Table 4.2.2.1-2 states that typical surfacer primers are 49% solids and have a density of 9.4 lbs/gal yearly usage of "other primers" is approximately 166.4 gal/yr.

$$(332.8 \text{ gal/yr}) (9.4 \text{ lbs/gal}) (0.49 \text{ solids}) = 1532.9 \text{ lbs/yr. particulate sprayed} \\ = 0.77 \text{ T/yr.}$$

The rest of the calculation proceeds as the above to yield total particulate emissions from "other primers" of 0.02 T/yr.

G. Yearly Total Particulate Emissions

Total from 2-part systems 1.94 tons/yr.
 Total from other primers 0.02 tons/yr.
 Total: 1.96 tons/yr.

Potential emission without filters
 Total from 2-part systems = 38.8 tons/yr.
 Total from "other primers" = 0.44 tons/yr.
 Total potential emissions = 39.2 tons/yr.

H. Contaminants and Utilization Rates:

Table 7 - Utilization Rates

Type of Paints	Approx. Daily Usage (Unthinned Paints)	Density	Utilization Rates
2-part polyurethane	35 gal	9.2 lbs/gal*	20.2 lbs/hr.
2-part acrylic	18 gal	8.9 lbs/gal*	10.0 lbs/hr.
2-part epoxy primer	3.6 gal	10.5 lbs/gal*	2.4 lbs/hr.
other primers	1.2 gal	9.4 lbs/gal*	0.8 lbs/gal
thinners	54.2 gal	6.94 lbs/gal**	23.6 lbs/gal

Table 8 - Weight Percent of Contaminants

Type of Paint	Weight Percents		Source of Figure
	VOC	Particulate	
2-part polyurethane	0%	100%	AP-42, 4.2.2.1
2-part acrylic enamel	0%	100%	AP-42, 4.2.2.1
2-part epoxy primer	0%	100%	AP-42, 4.2.2.1
other primers	51%	49%	AP-42, 4.2.2.1-2
thinners	100%	0%	----

I. Calculation of Gas Flow Rates and Velocities

Exhaust Fans:

Booth is equipped with two exhaust fans from Binks Manufacturing, model 30-4418 rated at 24,250 SCFM at ¼" WC static pressure (See Attachment #2)

Total air flow from both fans 48500 SCFM at ¼" WC static pressure

Stack diameter 3.5 ft.
 radius 1.75 ft.

Cross sectional area of stack = $\pi r^2 = (3.14) (1.75)^2 = 9.61$ sq. ft.
 Air velocity from stack = $(24250 \text{ CFM} \div 9.61 \text{ sq. ft.})$
 = 2523 FPM
 = 42.1 FPS through each of two vents

Attachment #2

Attachment 2 - Flow Diagram

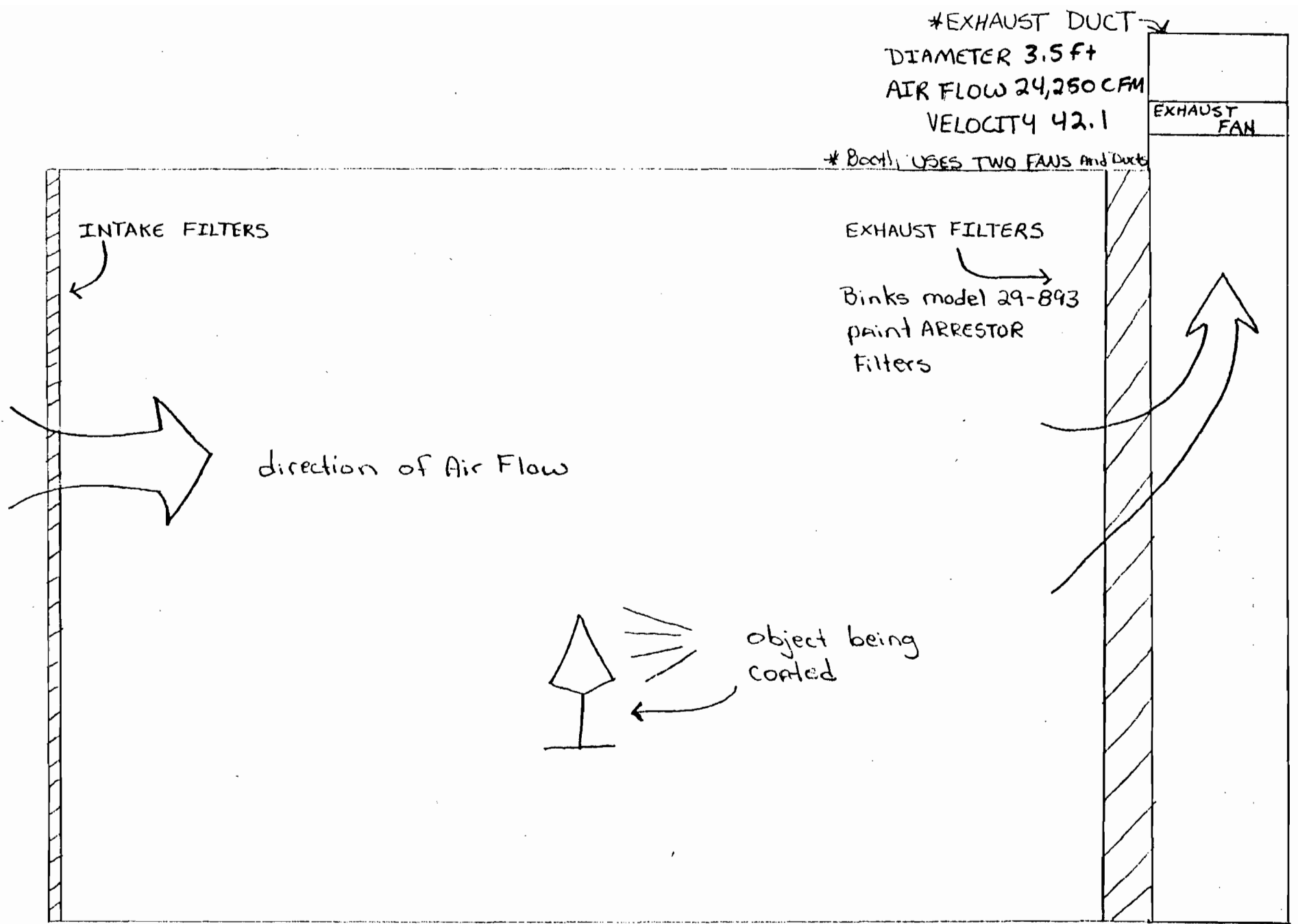

Attachment #3

BEST AVAILABLE COPY

SOURCES OF AIR CONTAMINANTS

1. Central Shops
2. WDW Laundry/Dry Cleaning
3. RCUC Trubines, boilers
4. Waste incinerator, closed.

other sources not shown:
boilers and emergency generators
at EPCOT Central Energy Plant

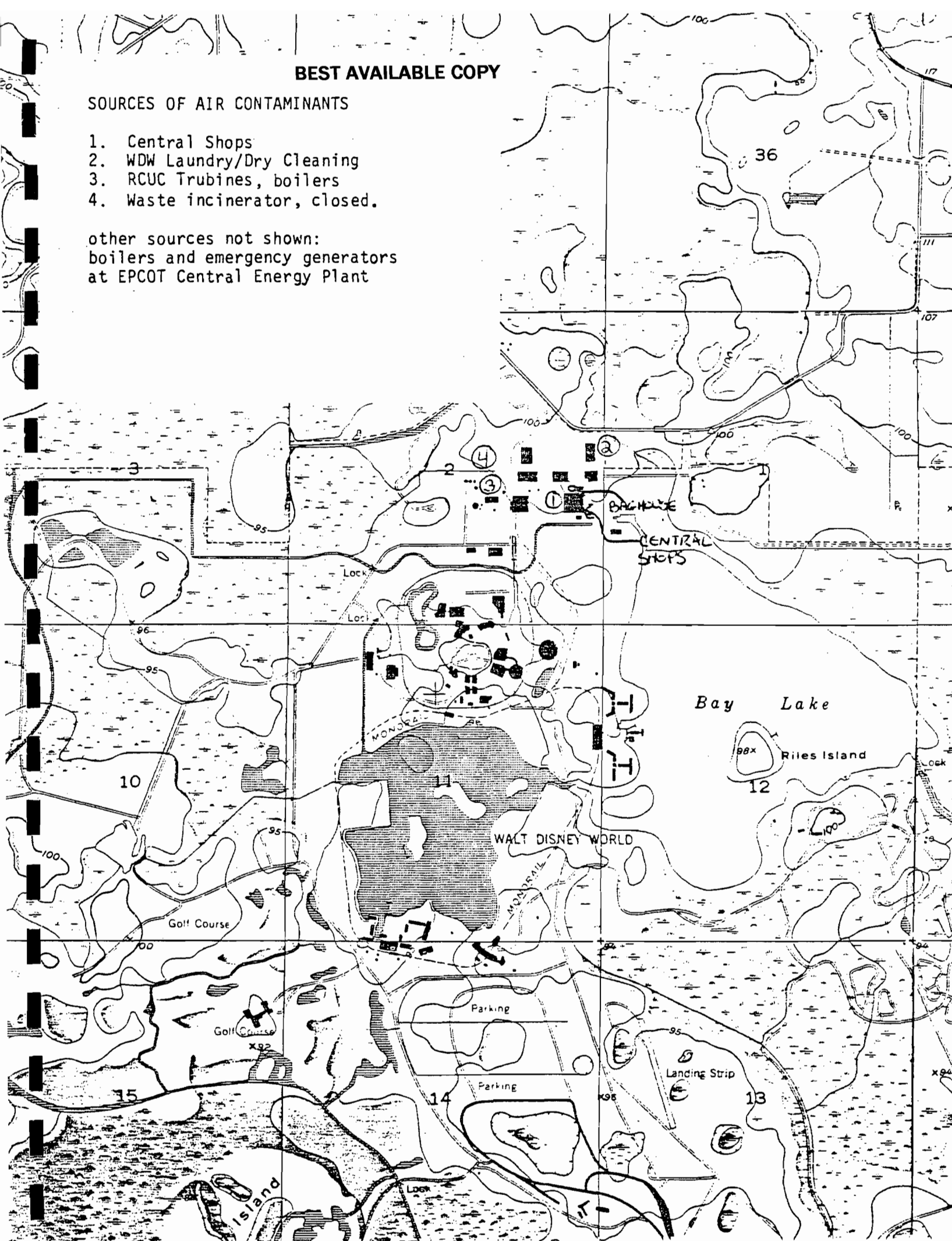

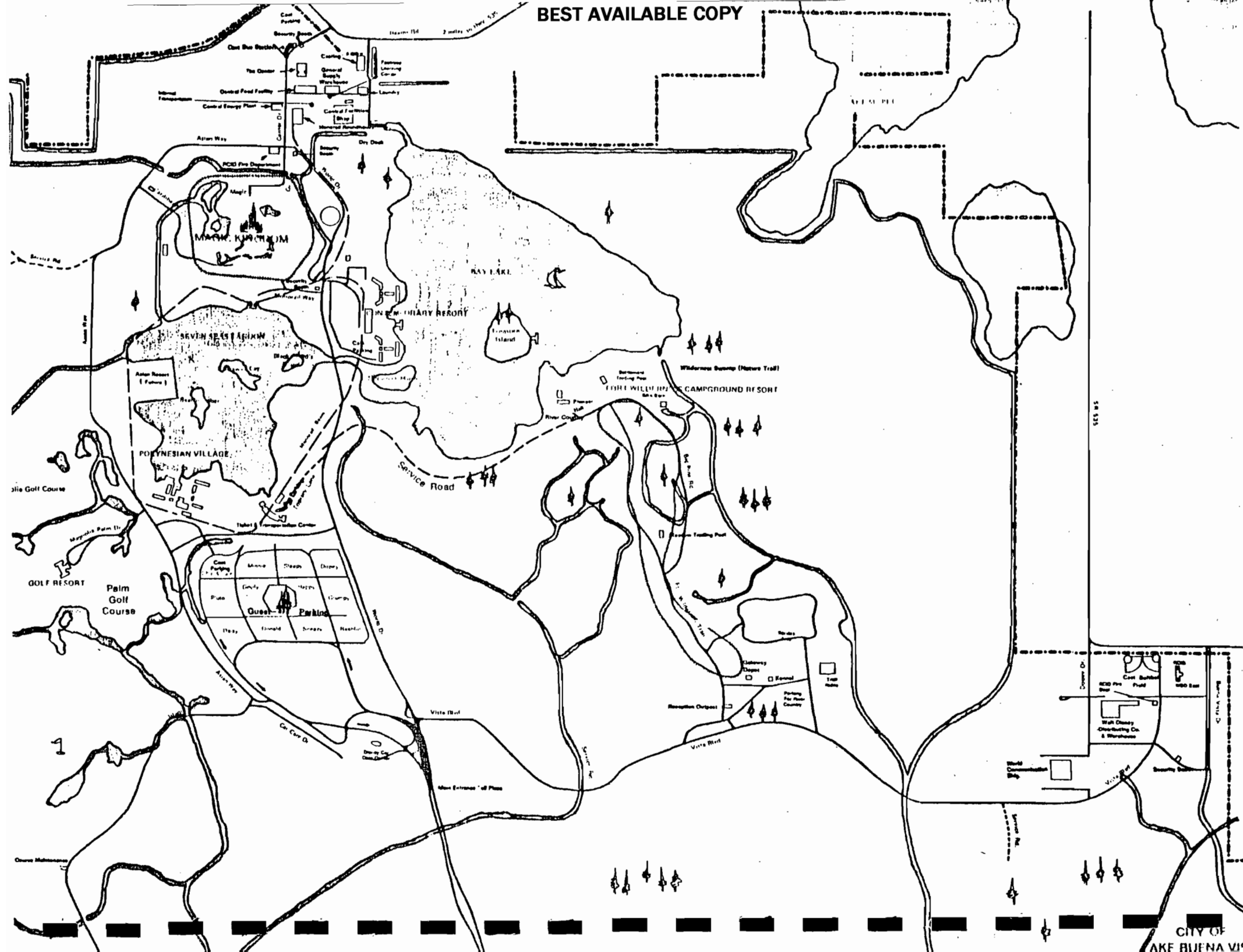

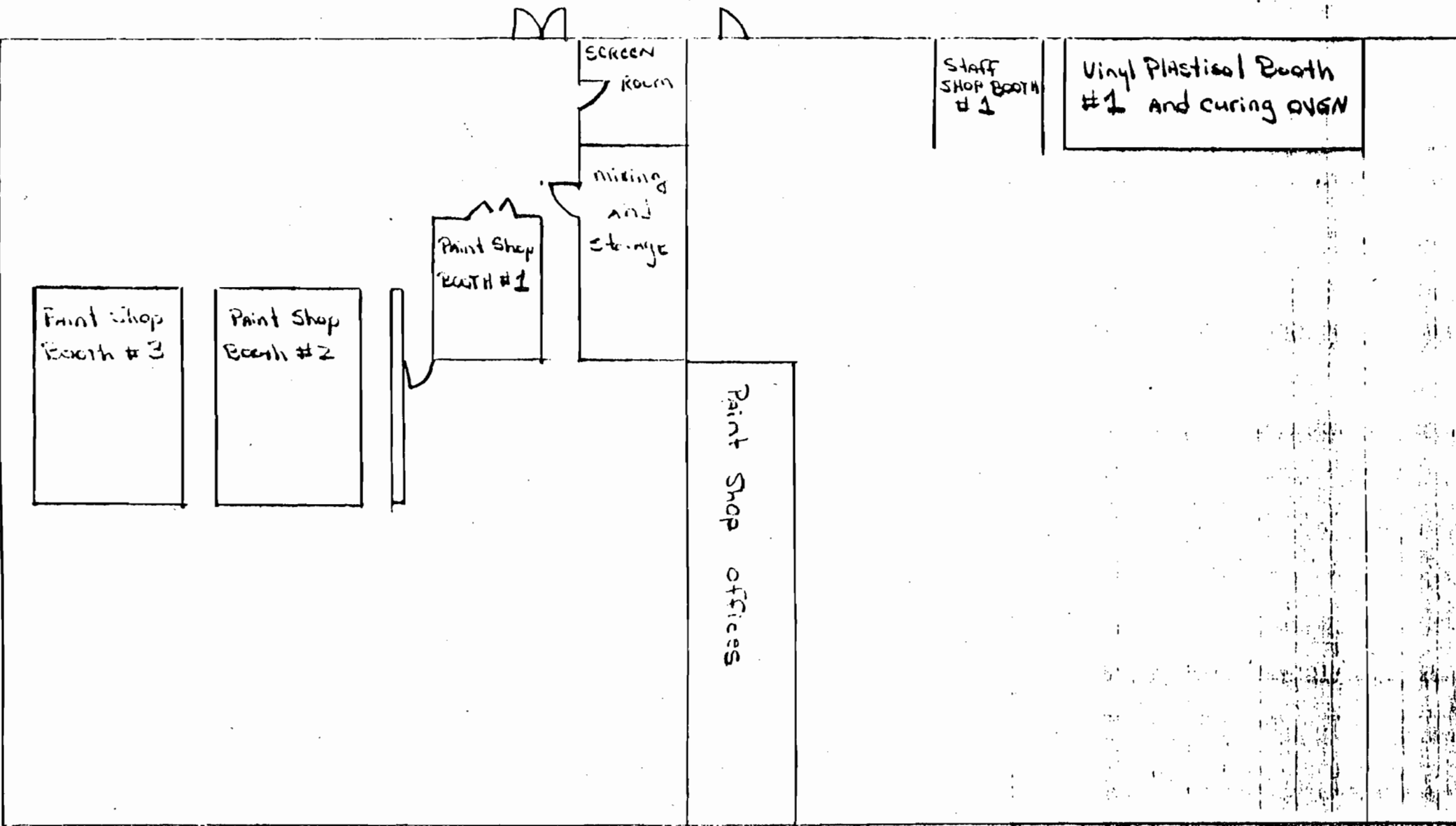

SKETCH OF Facility Layout, not to scale

AC 48-108742

BEST AVAILABLE COPY

AC 48-75835

STATE OF FLORIDA

DEPARTMENT OF ENVIRONMENTAL REGULATION

ST. JOHNS RIVER DISTRICT

3319 MAGUIRE BOULEVARD SUITE 232 ORLANDO, FLORIDA 32803

SEP 26 1983 SAINT JOHNS RIVER DISTRICT

DER OCT 6 1983 BAQM

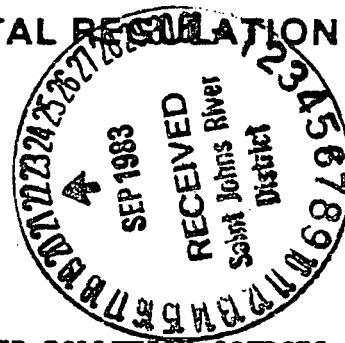
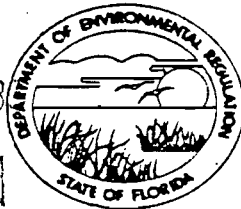

BOB GRAHAM GOVERNOR

STORIEA J. TSCHINKEL SECRETARY

ALEX SENKEVICH DISTRICT MANAGER

APPLICATION TO OPERATE/CONSTRUCT AIR POLLUTION SOURCES

SOURCE TYPE: Spray Paint Booth [] New¹ [] Existing¹

APPLICATION TYPE: [X] Construction [] Operation [] Modification

COMPANY NAME: WALT DISNEY WORLD Co., Inc. COUNTY: Orange

Identify the specific emission point source(s) addressed in this application (i.e. Lime Kiln No. 4 with Venturi Scrubber; Peaking Unit No. 2, Gas Fired) NSA Paint Shop Paint Booth #3

SOURCE LOCATION: Street Facilities Way City Bay Lake

UTM: East 443506 North 3144309

Latitude 28 ° 25 ' 32 "N Longitude 81 ° 34 ' 36 "W

APPLICANT NAME AND TITLE: Edward B. Crowell, Vice President Facilities Division

APPLICANT ADDRESS: P.O. Box 40, Lake Buena Vista Florida 32830

SECTION I: STATEMENTS BY APPLICANT AND ENGINEER

A. APPLICANT

I am the undersigned owner or authorized representative* of WALT DISNEY WORLD Co.

I certify that the statements made in this application for a construction permit are true, correct and complete to the best of my knowledge and belief. Further I agree to maintain and operate the pollution control source and pollution control facilities in such a manner as to comply with the provision of Chapter 403, Florida Statutes, and all the rules and regulations of the department and revisions thereof. I also understand that a permit, if granted by the department, will be non-transferable and I will promptly notify the department upon sale or legal transfer of the permitte establishment.

*Attach letter of authorization

Signed: Edward B. Crowell
Edward B. Crowell V.P. Facilities Division
Name and Title (Please Type)

Date: _____ Telephone No. (305) 824-7700

B. PROFESSIONAL ENGINEER REGISTERED IN FLORIDA (where required by Chapter 471, F.S.)

This is to certify that the engineering features of this pollution control project have been ~~designed~~/examined by me and found to be in conformity with modern engineering principles applicable to the treatment and disposal of pollutants characterized in the permit application. There is reasonable assurance, in my professional judgment, that

¹ See Florida Administrative Code Rule 17-2.100(57) and (104)

The pollution control facilities, when properly maintained and operated, will discharge an effluent that complies with all applicable statutes of the State of Florida and the rules and regulations of the department. It is also agreed that the undersigned will furnish, if authorized by the owner, the applicant a set of instructions for the proper maintenance and operation of the pollution control facilities and, if applicable, pollution sources.

Signed Ted W. McKim
TED W. MCKIM
Name (Please Type)

Reedy Creek Utilities Co., Inc.
Company Name (Please Type)

P.O. Box 40 Lake Buena Vista, FL 32830
Mailing Address (Please Type)

Florida Registration No. 25555 Date: 9/21/83 Telephone No. (305) 824-4950

SECTION II: GENERAL PROJECT INFORMATION

Describe the nature and extent of the project. Refer to pollution control equipment, and expected improvements in source performance as a result of installation. State whether the project will result in full compliance. Attach additional sheet if necessary.

Spray paint booth for coating a variety of objects including vehicles, wooden furniture, trash cans, ride components, posts and frames using 2 part polyurethane, 2 part acrylic, epoxy primers and other primer coating systems.

Schedule of project covered in this application (Construction Permit Application Only)

Start of Construction existing booth Completion of Construction N/A

Costs of pollution control system(s): (Note: Show breakdown of estimated costs only for individual components/units of the project serving pollution control purposes. Information on actual costs shall be furnished with the application for operation permit.)

N/A

Indicate any previous DER permits, orders and notices associated with the emission point, including permit issuance and expiration dates. NONE

Permit applications called in by Chuck Collins of Florida DER to be submitted by 9/16/83.

E. Requested permitted equipment operating time: hrs/day 16; days/wk 5; wks/yr 52;
if power plant, hrs/yr _____; if seasonal, describe: _____

F. If this is a new source or major modification, answer the following questions.
(Yes or No)

1. Is this source in a non-attainment area for a particular pollutant? yes
 - a. If yes, has "offset" been applied? no
 - b. If yes, has "Lowest Achievable Emission Rate" been applied? no
 - c. If yes, list non-attainment pollutants. VOC
2. Does best available control technology (BACT) apply to this source?
If yes, see Section VI. no
3. Does the State "Prevention of Significant Deterioration" (PSD)
requirement apply to this source? If yes, see Sections VI and VII. no
4. Do "Standards of Performance for New Stationary Sources" (NSPS)
apply to this source? no
5. Do "National Emission Standards for Hazardous Air Pollutants"
(NESHAP) apply to this source? no
- Do "Reasonably Available Control Technology" (RACT) requirements apply
to this source? no
 - a. If yes, for what pollutants? _____
 - b. If yes, in addition to the information required in this form,
any information requested in Rule 17-2.650 must be submitted.

Attach all supportive information related to any answer of "Yes". Attach any justifi-
cation for any answer of "No" that might be considered questionable.

No RACT guidelines for this type of surface coating operation.

SECTION III: AIR POLLUTION SOURCES & CONTROL DEVICES (Other than Incinerators)

A. Raw Materials and Chemicals Used in your Process, if applicable:

See Attachment #1, Part H

Description	Contaminants		Utilization Rate - lbs/hr	Relate to Flow Diagram
	Type	% Wt		
2-part polyurethane	VOC/Partic.	0%/100%		Paint application
2-part acrylic enamel	VOC/Partic	0%/100%		Paint application
2-part epoxy primer	VOC/Partic.	0%/100%		Paint application
conventional primer systems	VOC/Partic.	0%/100%		Paint application

Thinners VOC/Partic. 0%/100% Thinner for paint application

B. Process Rate, if applicable: (See Section V, Item 1)

N/A

1. Total Process Input Rate (lbs/hr):

2. Product Weight (lbs/hr):

C. Airborne Contaminants Emitted: (Information in this table must be submitted for each emission point, use additional sheets as necessary) See Attachment #1, Parts A-G for Calculations

Name of Contaminant	Emission ¹		Allowed Emission Rate per Rule 17-2	Allowable Emission lbs/hr	Potential ⁴ Emission		Relate to Flow Diagram
	Maximum lbs/hr	Actual T/yr			lbs/yr	T/yr	
VOC	23.8	49.5			99,000	49.5	
Particulate	0.93	1.94			79,000	39.5	

¹See Section V, Item 2.

²Reference applicable emission standards and units (e.g. Rule 17-2.600(5)(b)2. Table II, E. (1) - 0.1 pounds per million BTU heat input)

³Calculated from operating rate and applicable standard.

⁴Emission, if source operated without control (See Section V, Item 3).

D. Control Devices: (See Section V, Item 4)

Name and Type (Model & Serial No.)	Contaminant	Efficiency	Range of Particles Size Collected (in microns) (If applicable)	Basis for Efficiency (Section V Item 5)
Binks Paint Arrestor Type	Particulate	95%	N/A	Mfg. Specs.
Filters model #29-893				
Filter Bank dimensions				
2 filter banks 6.7 x				
13.3 ft. for a total of				
178 sq. ft.				

E. Fuels N/A

Type (Be Specific)	Consumption*		Maximum Heat Input (MMBTU/hr)
	avg/hr	max./hr	

*Units: Natural Gas--MMCF/hr; Fuel Oils--gallons/hr; Coal, wood, refuse, other--lbs/hr.

Fuel Analysis:

Percent Sulfur: _____ Percent Ash: _____

Density: _____ lbs/gal Typical Percent Nitrogen: _____

Heat Capacity: _____ BTU/lb _____ BTU/gal

Other Fuel Contaminants (which may cause air pollution): _____

F. If applicable, indicate the percent of fuel used for space heating.

Annual Average _____ Maximum _____

G. Indicate liquid or solid wastes generated and method of disposal.

mission Stack Geometry and Flow Characteristics (Provide data for each stack):

Stack Height: 35' ft. Stack Diameter: _____ ft.
 Flow Rate: _____ ACFM 24,250 DSCFM Gas Exit Temperature: ambient °F.
 Water Vapor Content: ambient % Velocity: 42.1 FPS

*At 1/4" water static pressure See Attachment #1, Part I

SECTION IV: INCINERATOR INFORMATION
N/A

Type of Waste	Type 0 (Plastics)	Type I (Rubbish)	Type II (Refuse)	Type III (Garbage)	Type IV (Pathological)	Type V (Liq. & Gas By-prod.)	Type VI (Solid By-prod.)
Actual lbs/hr incinerated							
Uncontrolled lbs/hr							

Description of Waste: _____

Actual Weight Incinerated (lbs/hr) _____ Design Capacity (lbs/hr) _____

Approximate Number of Hours of Operation per day _____ day/wk _____ wks/yr. _____

Manufacturer: _____

Date Constructed: _____ Model No. _____

	Volume (ft) ³	Heat Release (BTU/hr)	Fuel		Temperature (°F)
			Type	BTU/hr	
Primary Chamber					
Secondary Chamber					

Stack Height: _____ ft. Stack Diameter: _____ Stack Temp. _____

Flow Rate: _____ ACFM _____ DSCFM* Velocity: _____ FPS

For more than one ton per day design capacity, submit the emissions rate in grains per standard cubic foot dry gas corrected to 50% excess air.

Other pollution control devices: Cyclone Wet Scrubber Afterburner

Other (specify) _____

Brief description of operating characteristics of control devices: _____

Ultimate disposal of any effluent other than that emitted from the stack (scrubber water, ash, etc.):

NOTE: Items 2, 3, 4, 6, 7, 8, and 10 in Section V must be included where applicable.

SECTION V: SUPPLEMENTAL REQUIREMENTS

Please provide the following supplements where required for this application.

1. Total process input rate and product weight -- show derivation [Rule 17-2.100(127)]
2. To a construction application, attach basis of emission estimate (e.g., design calculations, design drawings, pertinent manufacturer's test data, etc.) and attach proposed methods (e.g., FR Part 60 Methods 1, 2, 3, 4, 5) to show proof of compliance with applicable standards. To an operation application, attach test results or methods used to show proof of compliance. Information provided when applying for an operation permit from a construction permit shall be indicative of the time at which the test was made.
3. Attach basis of potential discharge (e.g., emission factor, that is, AP42 test).
4. With construction permit application, include design details for all air pollution control systems (e.g., for baghouse include cloth to air ratio; for scrubber include cross-section sketch, design pressure drop, etc.)
5. With construction permit application, attach derivation of control device(s) efficiency. Include test or design data. Items 2, 3 and 5 should be consistent: actual emissions = potential (1-efficiency).
6. An 8 1/2" x 11" flow diagram which will, without revealing trade secrets, identify the individual operations and/or processes. Indicate where raw materials enter, where solid and liquid waste exit, where gaseous emissions and/or airborne particles are evolved and where finished products are obtained.
7. An 8 1/2" x 11" plot plan showing the location of the establishment, and points of airborne emissions, in relation to the surrounding area, residences and other permanent structures and roadways (Example: Copy of relevant portion of USGS topographic map).
8. An 8 1/2" x 11" plot plan of facility showing the location of manufacturing processes and outlets for airborne emissions. Relate all flows to the flow diagram.

BEST AVAILABLE COPY

9. The appropriate application fee in accordance with Rule 17-4.05. The check should be made payable to the Department of Environmental Regulation.
10. With an application for operation permit, attach a Certificate of Completion of Construction indicating that the source was constructed as shown in the construction permit.

SECTION VI: BEST AVAILABLE CONTROL TECHNOLOGY

A. Are standards of performance for new stationary sources pursuant to 40 C.F.R. Part 60 applicable to the source?

Yes No

Contaminant

Rate or Concentration

B. Has EPA declared the best available control technology for this class of sources (if yes, attach copy)

Yes No

Contaminant

Rate or Concentration

C. What emission levels do you propose as best available control technology?

Contaminant

Rate or Concentration

D. Describe the existing control and treatment technology (if any).

1. Control Device/System:

2. Operating Principles:

3. Efficiency:*

4. Capital Costs:

*Explain method of determining

5. Useful Life:

6. Operating Costs:

7. Energy:

8. Maintenance Cost:

9. Emissions:

Contaminant

Rate or Concentration

10. Stack Parameters

a. Height:

ft.

b. Diameter:

ft.

c. Flow Rate:

ACFM

d. Temperature:

°F.

e. Velocity:

FPS

E. Describe the control and treatment technology available (As many types as applicable, use additional pages if necessary).

1.

a. Control Device:

b. Operating Principles:

c. Efficiency:¹

d. Capital Cost:

e. Useful Life:

f. Operating Cost:

g. Energy:²

h. Maintenance Cost:

i. Availability of construction materials and process chemicals:

j. Applicability to manufacturing processes:

k. Ability to construct with control device, install in available space, and operate within proposed levels:

2.

a. Control Device:

b. Operating Principles:

c. Efficiency:¹

d. Capital Cost:

e. Useful Life:

f. Operating Cost:

g. Energy:²

h. Maintenance Cost:

i. Availability of construction materials and process chemicals:

¹Explain method of determining efficiency.

²Energy to be reported in units of electrical power - KWH design rate.

j. Applicability to manufacturing processes:

k. Ability to construct with control device, install in available space, and operate within proposed levels:

3.

a. Control Device:

b. Operating Principles:

c. Efficiency:¹

d. Capital Cost:

e. Useful Life:

f. Operating Cost:

g. Energy:²

h. Maintenance Cost:

i. Availability of construction materials and process chemicals:

j. Applicability to manufacturing processes:

k. Ability to construct with control device, install in available space, and operate within proposed levels:

4.

a. Control Device:

b. Operating Principles:

c. Efficiency:¹

d. Capital Costs:

e. Useful Life:

f. Operating Cost:

g. Energy:²

h. Maintenance Cost:

i. Availability of construction materials and process chemicals:

j. Applicability to manufacturing processes:

k. Ability to construct with control device, install in available space, and operate within proposed levels:

Describe the control technology selected:

1. Control Device:

2. Efficiency:¹

3. Capital Cost:

4. Useful Life:

5. Operating Cost:

6. Energy:²

7. Maintenance Cost:

8. Manufacturer:

9. Other locations where employed on similar processes:

a. (1) Company:

(2) Mailing Address:

(3) City:

(4) State:

Explain method of determining efficiency.

Energy to be reported in units of electrical power - KWH design rate.

(5) Environmental Manager:

(6) Telephone No.:

(7) Emissions:¹

Contaminant

Rate or Concentration

(8) Process Rate:¹

b. (1) Company:

(2) Mailing Address:

(3) City:

(4) State:

(5) Environmental Manager:

(6) Telephone No.:

(7) Emissions:¹

Contaminant

Rate or Concentration

(8) Process Rate:¹

10. Reason for selection and description of systems:

¹Applicant must provide this information when available. Should this information not be available, applicant must state the reason(s) why.

SECTION VII - PREVENTION OF SIGNIFICANT DETERIORATION

A. Company Monitored Data

1. _____ no. sites _____ TSP _____ () SO₂* _____ Wind spd/dir

Period of Monitoring _____ / _____ / _____ to _____ / _____ / _____
month day year month day year

Other data recorded _____

Attach all data or statistical summaries to this application.

*Specify bubbler (B) or continuous (C).

2. Instrumentation, Field and Laboratory

a. Was instrumentation EPA referenced or its equivalent? [] Yes [] No

b. Was instrumentation calibrated in accordance with Department procedures?
[] Yes [] No [] Unknown

B. Meteorological Data Used for Air Quality Modeling

1. _____ Year(s) of data from _____ / _____ / _____ to _____ / _____ / _____
month day year month day year

2. Surface data obtained from (location) _____

3. Upper air (mixing height) data obtained from (location) _____

4. Stability wind rose (STAR) data obtained from (location) _____

C. Computer Models Used

1. _____ Modified? If yes, attach description.

2. _____ Modified? If yes, attach description.

3. _____ Modified? If yes, attach description.

4. _____ Modified? If yes, attach description.

Attach copies of all final model runs showing input data, receptor locations, and principle output tables.

D. Applicants Maximum Allowable Emission Data

Pollutant	Emission Rate
TSP	_____ grams/sec
SO2	_____ grams/sec

E. Emission Data Used in Modeling

Attach list of emission sources. Emission data required is source name, description of point source (on NEDS point number), UTM coordinates, stack data, allowable emissions, and normal operating time.

Attach all other information supportive to the PSD review.

Discuss the social and economic impact of the selected technology versus other applicable technologies (i.e., jobs, payroll, production, taxes, energy, etc.). Include assessment of the environmental impact of the sources.

Attach scientific, engineering, and technical material, reports, publications, journals, and other competent relevant information describing the theory and application of the requested best available control technology.

Attachment #1

A. Quantities of Paints and Thinners Used:

Table 1 - Quantities and Varieties of Paints Used*

<u>Type of Paint</u>	<u>Approx. Daily Usage</u>	<u>Percentage Thinner</u>
2-part polyurethane	70 gal*	50% (thinned for application)
2-part acrylic enamel	36 gal*	50% (thinned for application)
2-part epoxy primer	4.4 gal*	20% (thinned for application)
other primers	1.6 gal*	20% (thinned for application)

*Including volume of thinners added

*AP-42 supplement 12, April 1981 states, "two part catalyzed coatings to be dried, powder coatings, hot melts, and radiation cured coatings contain essentially no volatile organic compounds although some monomers and other lower molecular weight organics may volatilize." Therefore, the total VOC emission from these two part systems comes from the solvent used to thin them prior to spraying.

Table 2 - Volumes of Thinners Used

<u>Type of Paint</u>	<u>Daily Usage</u>	<u>Yearly Usage</u>
2-part polyurethane	35	9100 gal*
2-part acrylic enamel	18	4680 gal*
2-part epoxy primer	0.88	228 gal*
other primers	0.32	83.2 gal* (includes only solvents added as thinners)

*Based on 5 day/week, 52 weeks/year

B. Calculation of Density (lbs/gal) for a Typical Manufactures Thinner Formulation Used with Two Part Coating Systems:

Calculations for the density of the thinning solvents used for the two part coating systems is based on the composition of Ditzler DTR 60Z reducing solvent which is typical of the solvent mixtures used.

Petroleum Distillates	35%	(Approx. 6.5 lbs/gal, based on mineral spirits)
Toluol (toluene)	25%	(7.26 lbs/gal)
Acetone	15%	(6.59 lbs/gal)
Ethyl Acetate	10%	(7.51 lbs/gal)
Aromatic Hydrocarbon	15%	(Approx. 7.2 lbs/gal, based on xylene)

Contributions of Solvents to Mixture Density:

Petroleum distillates	(0.35) (6.5 lbs/gal) =	2.28
Toluol (toluene)	(0.25) (7.26 lbs/gal) =	1.82
Acetone	(0.15) (6.59 lbs/gal) =	0.99
Ethyl Acetate	(0.10) (7.51 lbs/gal) =	0.75
Aromatic Hydrocarbon	(0.15) (7.2 lbs/gal) =	1.1

Mixture density = 6.94 lbs/gal

C. Solvent Emissions from the Use of Two Part Coating Systems:

Solvent emissions from the two part coating systems are limited to the amount of thinning solvents used to achieve high quality finishes (See Table #1)

Table 3 - Total Emissions from Two Part Coating Systems

<u>Type of Paint</u>	<u>Volumes of Thinners Used</u>	<u>Yearly VOC Emissions</u>
2-part polyurethane	9100 gal/yr.	31.6 T/yr.
2-part acrylic enamel	4680 gal/yr.	16.2 T/yr.
2-part epoxy primer	228 gal/yr.	0.8 T/yr.
other primers	83.2 gal/yr.	0.28 T/yr.

Sample calculation for 2-part polyurethane

9100 gallon thinners used per year for 2-part polyurethane system, density of thinner is approx. 6.94 lbs/gal:

$$[(9100 \text{ gal}) (6.94 \text{ lbs/gal})] \div 2,000 \text{ lbs/ton} = 31.6 \text{ T/yr.}$$

D. Solvent Emissions from the One Part Primers (Other Primers)

The solvent emissions from the one-part "other primers" is composed of two components - the solvents already present in the paint formulation and the solvents added to thin the primer prior to application.

VOC emissions from solvents already present:

approximate yearly usage volume = 416 gallons thinned with 20% thinner or 332.8 gallons unthinned.

AP-42 supplement 12, table 4.2.2.1-2 states that surfacer primer are typically 49% solids by volume which equates to 51% solvents by volume.

(332.8 gal unthinned primer) (0.51) = 169.7 gal solvents
 the solvent used in these one part primers is typically toluene whose density is 7.26 lbs/gallon, therefore: ~~(0.62 gal/yr.)~~ (7.26 lbs/gal) = ~~616.4~~ 132 lbs/yr or ~~0.31~~ 0.02 tons/yr from the unthinned portion of the primer.

The thinner used amounts to 416 gal/yr. total - 332.8 gal/yr. unthinned primer or 83.2 gals, all of which ends up as VOC emissions: (83.2 gal/yr) (6.94 lbs/gal*) = 577.4 lbs/yr. or 0.29 T/yr.

*See Part B of this attachment

Total solvent emissions from one part primers: (0.62 T/yr. from primer itself) + (0.29 T/yr. from thinning solvents) = 0.91 T/yr.

Total Yearly VOC Emissions
 September 13, 1983
 Page Three

E. Total Yearly VOC Emissions:

<u>Source of Emissions</u>	<u>Amount</u>
2-part polyurethane system*	31.6 T/yr.
2-part acrylic enamel*	16.2 T/yr.
2-part epoxy primer*	0.8 T/yr.
other primers*	0.9 T/yr.
*Includes Thinners Total:	49.5 T/yr.

F. Particulate Emissions:

Estimates for overspray percents obtained from AP-40, second edition, page 861:

<u>Method of Spraying</u>	<u>% Over Spray</u>		
	<u>Flat Surface</u>	<u>Table Leg</u>	<u>Bird Cage</u>
Air atomization	50%	85%	90%

Binks manufacturing quotes a 95% efficiency rating for its paint arrester type filters (model 29-893) when used with enamels, primers and two part systems.

The items to be coated in this booth can be broken down as follows:

20%	wooden furniture	(50% flat-50% table leg surfaces)
55%	automotive type	(100% flat type surfaces)
15%	flat surfaces	(100% flat type surfaces)
10%	posts and frames	(99% table leg-1% bird cage type surfaces)

Table 4 - Composite Overspray Rates

<u>Type Surface</u>	<u>Composite Overspray Percentage</u>
Wooden furniture	67.5%
Automotive type	50%
Flat surfaces	50%
posts and frames	85.1%

Unthinned 2-part coating systems can be viewed as being essentially all particulate in content. (AP-42, supplement 12, section 4.2.2-1)

Table 5 - Volumes of Unthinned 2-part Coating Systems

<u>Paint Type</u>	<u>Volume of Unthinned Material</u>		<u>Weight</u>
2-part polyurethane	9100 gal	(9.2 lbs/gal)*	41.9 tons
2-part acrylic enamel	4680 gal	(8.9 lbs/gal)*	20.8 tons
2-part epoxy primer	916 gal	(10.5 lbs/gal)*	4.8 tons

*See AP-42 Table 4.2.2.1-2

Particulate emissions from two part coating systems:
 The calculations proceed as follows:

(Tons of coating system) x (Percentage of items coated) x (Overspray percentage) = tons of particulate in overspray

Sample calculation for 2-part polyurethane system:

(41.9 tons) (20% wooden furniture) (6.75% overspray) = 5.66 tons
 (41.9 tons) (70% flat type surfaces) (50% overspray) = 17.7 tons
 (41.9 tons) (10% postsand frames) (85.1% overspray) = 13.57 tons
 Total particulate overspray from 2-part polyurethane = 23.9 tons/yr.

Efficiency of paint arrestor filter is 95%, therefore, 5% of total overspray is emitted from booth (23.9 tons/yr.) (.05) = 1.20 tons/yr. emitted.

Table 6 - Total Particulate Emissions From 2-part Coating Systems

<u>Paint Type</u>	<u>Ton/Yr. Particulates Emitted</u>	<u>Total Particulate Overspray</u>
2-part polyurethane	1.20 tons/yr.	23.9 tons/yr.
2-part acrylic enamel	0.60 tons/yr.	12.0 tons/yr.
2-part epoxy primer	0.14 tons/yr.	2.8 tons/yr.
Total emitted from 2-part systems	1.94 tons/yr.	

Particulate emissions from "other primers"

AP-42, Table 4.2.2.1-2 states that typical surfacer primers are 49% solids and have a density of 9.4 lbs/gal yearly useage of "other primers" is approximately 166.4 gal/yr.

(332.8 gal/yr) (9.4 lbs/gal) (0.49 solids) = 1532.9 lbs/yr. particulate sprayed
 = 0.77 T/yr.

The rest of the calculation proceeds as the above to yield total particulate emissions from "other primers" of 0.02 T/yr.

G. Yearly Total Particulate Emissions

Total from 2-part systems 1.94 tons/yr.
 Total from other primers 0.02 tons/yr.
 Total: 1.96 tons/yr.

Potential emission without filters
 Total from 2-part systems = 38.8 tons/yr.
 Total from "other primers" = 0.44 tons/yr.
 Total potential emissions = 39.2 tons/yr.

H. Contaminants and Utilization Rates:

Table 7 - Utilization Rates

Type of Paints	Approx. Daily Usage (Unthinned Paints)	Density	Utilization Rates
2-part polyurethane	35 gal	9.2 lbs/gal*	20.2 lbs/hr.
2-part acrylic	18 gal	8.9 lbs/gal*	10.0 lbs/hr.
2-part epoxy primer	3.6 gal	10.5 lbs/gal*	2.4 lbs/hr.
other primers	1.2 gal	9.4 lbs/gal*	0.8 lbs/gal
thinners	54.2 gal	6.94 lbs/gal**	23.6 lbs/gal

Table 8 - Weight Percent of Contaminants

Type of Paint	Weight Percents		Source of Figure
	VOC	Particulate	
2-part polyurethane	0%	100%	AP-42, 4.2.2.1
2-part acrylic enamel	0%	100%	AP-42, 4.2.2.1
2-part epoxy primer	0%	100%	AP-42, 4.2.2.1
other primers	51%	49%	AP-42, 4.2.2.1-2
thinners	100%	0%	----

I. Calculation of Gas Flow Rates and Velocities

Exhaust Fans:

Booth is equipped with two exhaust fans from Binks Manufacturing, model 30-4418 rated at 23250 SCFM at 1/2" WC static pressure (See Attachment #2)

Total air flow from both fans 48500 SCFM at 1/2" WC static pressure

Stack diameter 3.5 ft.
 radius 1.75 ft.

Cross sectional area of stack = $\pi r^2 = (3.14) (1.75)^2 = 9.61$ sq. ft.
 Air velocity from stack = $(24,250 \text{ CFM} \div 9.61 \text{ sq. ft.})$
 = 2523 FPM
 = 42.1 FPS through each of two vents

Attachment #2

*EXHAUST DUCT
DIAMETER 3.5ft
AIR FLOW 24,250CFM
VELOCITY 42.1

EXHAUST FAN

* Booth, USES TWO FANS and Ducts

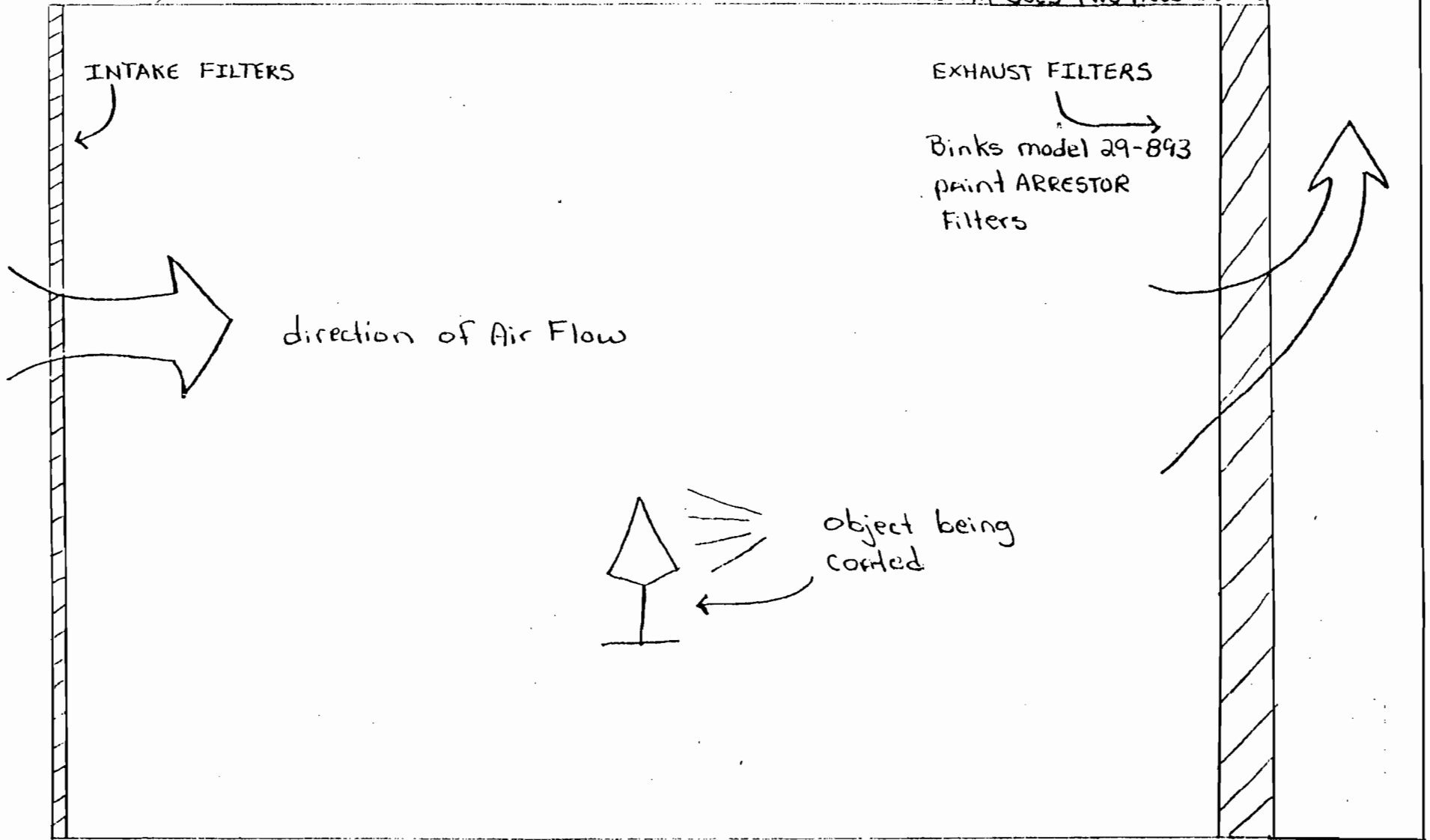

Attachment 2 - Flow Diagram



Attachment #3

BEST AVAILABLE COPY

SOURCES OF AIR CONTAMINANTS

1. Central Shops
2. WDW Laundry/Dry Cleaning
3. RCUC Trubines, boilers
4. Waste incinerator, closed.

other sources not shown:
boilers and emergency generators
at EPCOT Central Energy Plant

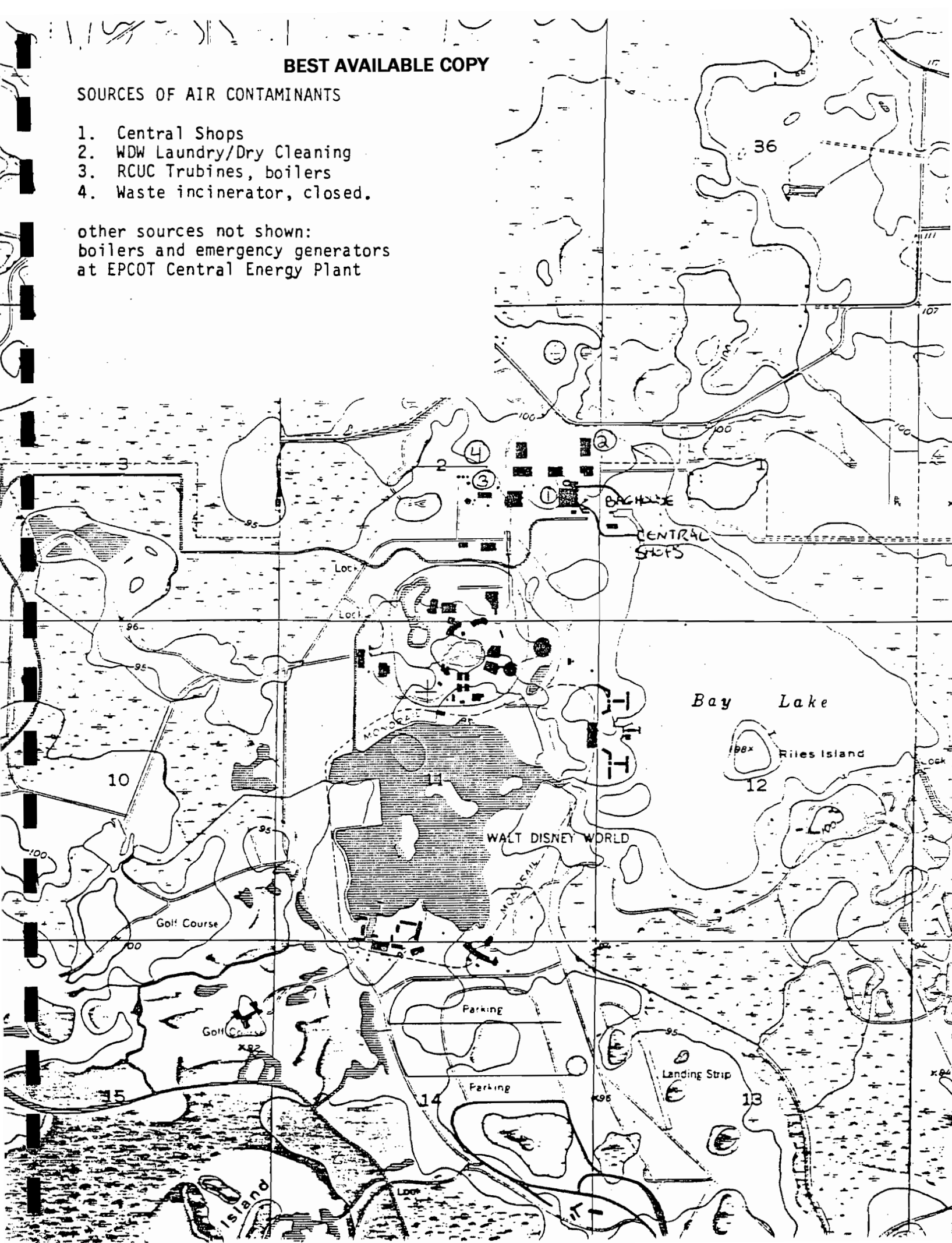

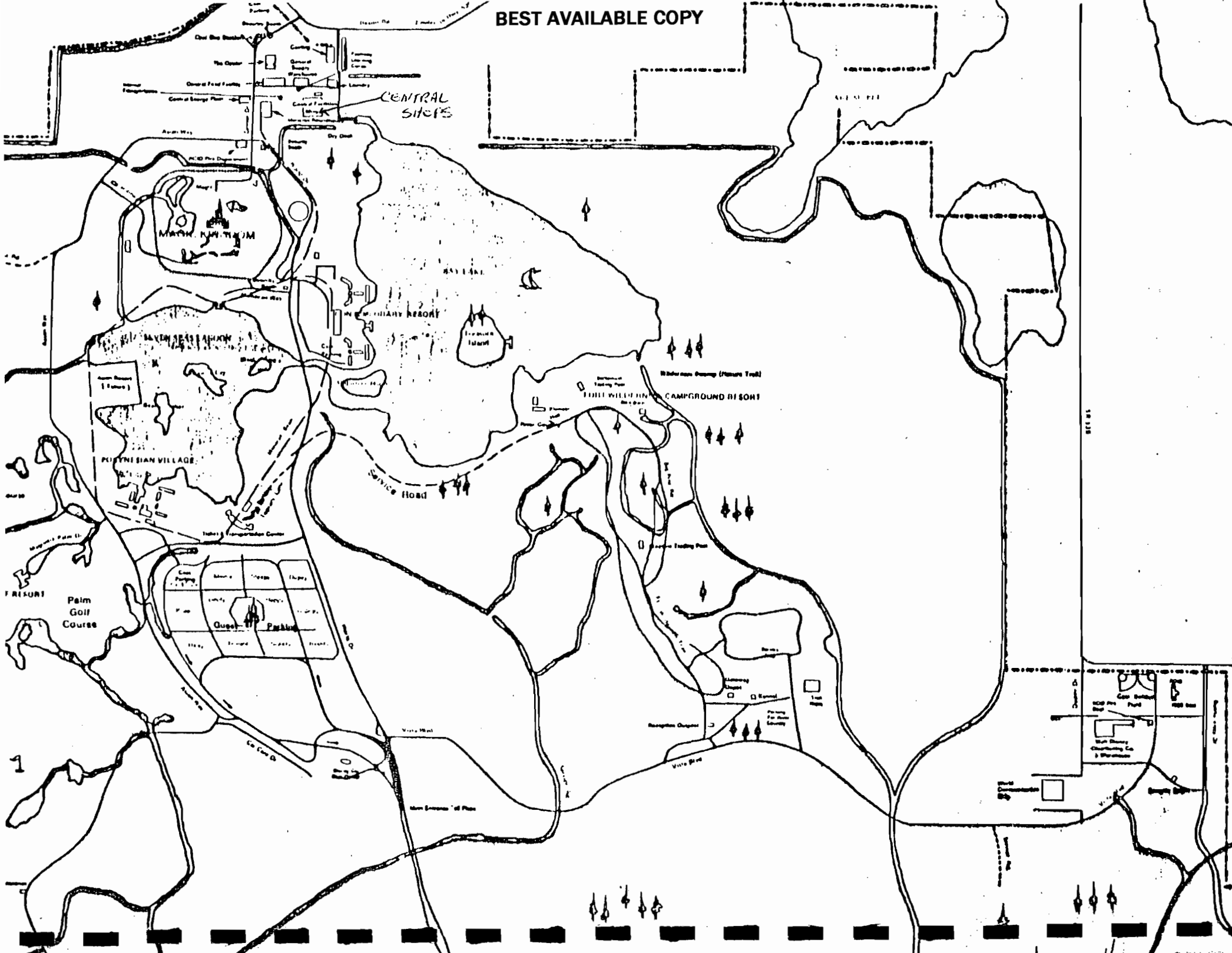

shops
shops
shops

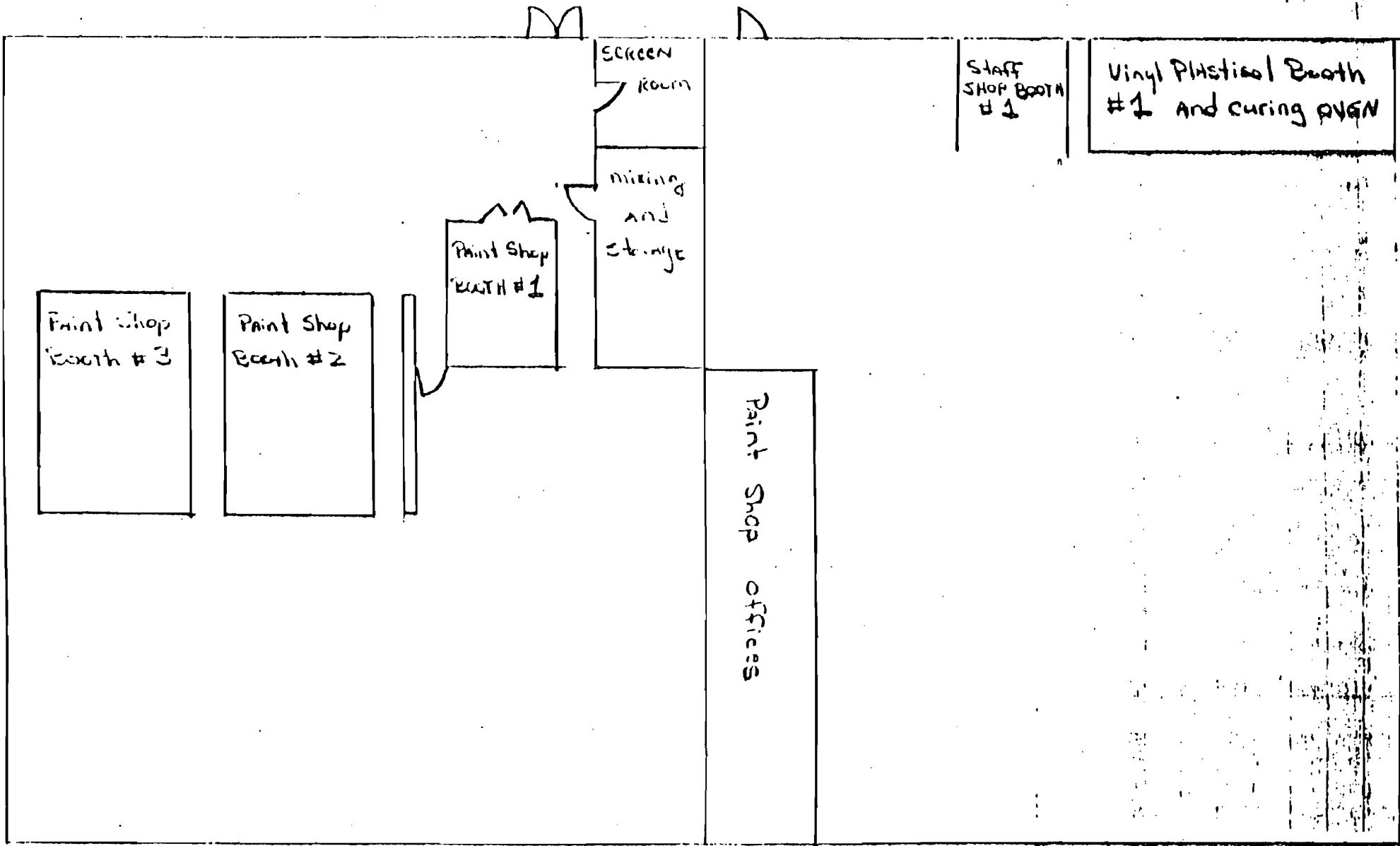

SKETCH OF Facility Layout, not to scale

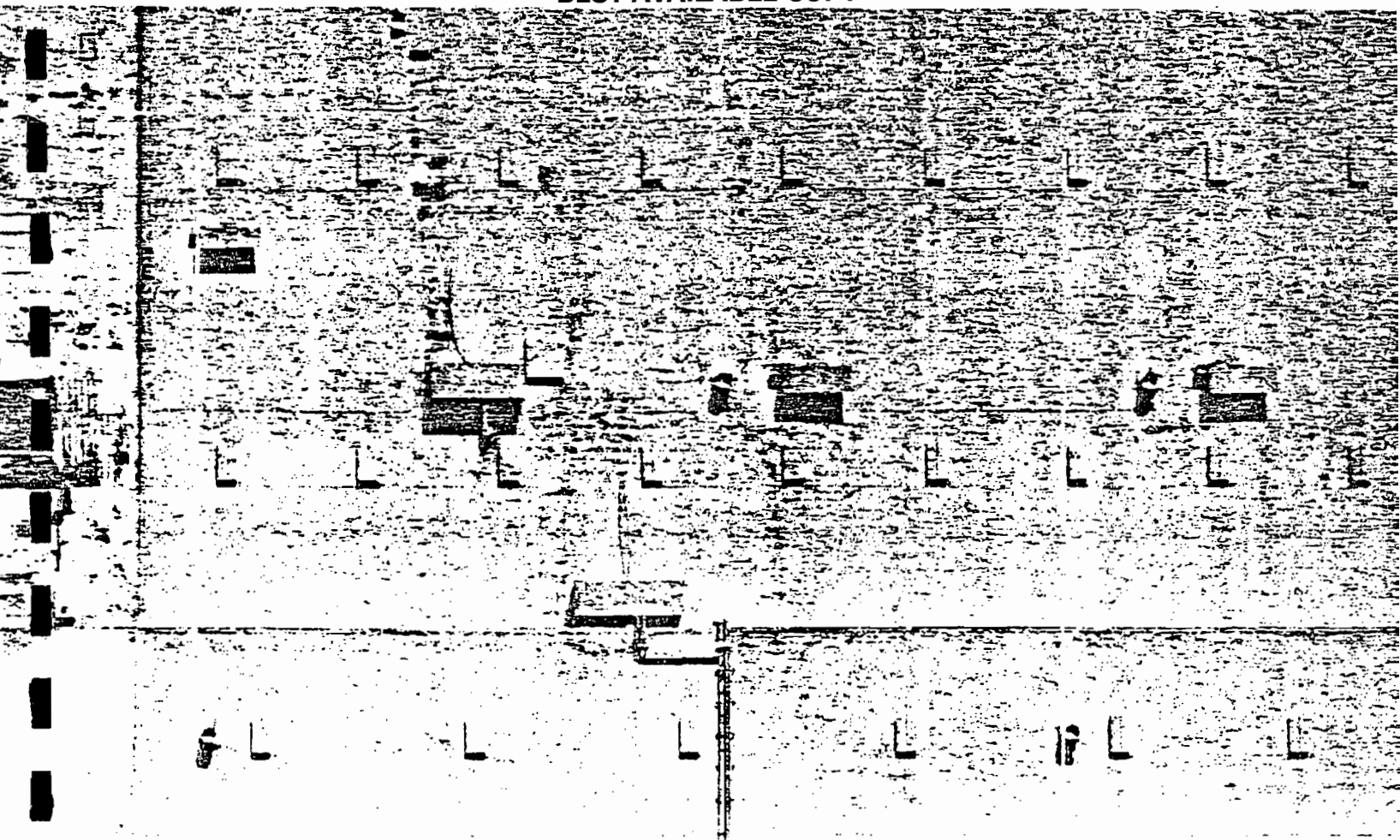

VENTS FOR
BOOTH #3



AERIAL PHOTO
OF CENTRAL SHOPS
ROOF SHOWING
VENT LOCATIONS

415 Cm



AC 48-108743

BEST AVAILABLE COPY

AC 48-7583 B

STATE OF FLORIDA

DEPARTMENT OF ENVIRONMENTAL REGULATION

ST. JOHNS RIVER DISTRICT

3319 MAGUIRE BOULEVARD
SUITE 232
ORLANDO, FLORIDA 32803

DER P

OCT 6 1983

BAQM

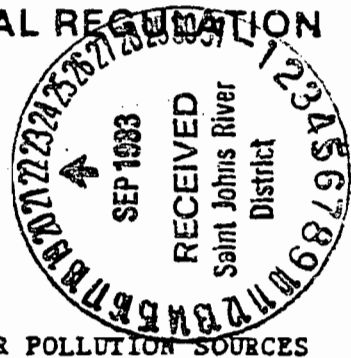

BOB GRAHAM GOVERNOR

TORIA J. TSCHINKEL SECRETARY

ALEX SENKEVICH DISTRICT MANAGER

APPLICATION TO OPERATE/CONSTRUCT AIR POLLUTION SOURCES

SOURCE TYPE: Spray Booth [] New¹ [X] Existing¹

APPLICATION TYPE: [X] Construction [] Operation [] Modification

COMPANY NAME: WALT DISNEY WORLD Co., Inc. COUNTY: Orange

Identify the specific emission point source(s) addressed in this application (i.e. Lime
Kiln No. 4 with Venturi Scrubber; Peaking Unit No. 2, Gas Fired) Spray Booth #1
NSA Staff Shop

SOURCE LOCATION: Street Facilities Way City Bay Lake

UTM: East 443558 North 314333

Latitude 28 ° 25 ' 32 "N Longitude 81 ° 34 ' 36 "W

APPLICANT NAME AND TITLE: Edward B. Crowell, V.P. Facilities Division

APPLICANT ADDRESS: P. O. Box 40 Lake Buena Vista, FL 32830

SECTION I: STATEMENTS BY APPLICANT AND ENGINEER

A. APPLICANT

I am the undersigned owner or authorized representative* of WALT DISNEY WORLD Co., Inc.

I certify that the statements made in this application for a construction permit are true, correct and complete to the best of my knowledge and belief. Further, I agree to maintain and operate the pollution control source and pollution control facilities in such a manner as to comply with the provision of Chapter 403, Florida Statutes, and all the rules and regulations of the department and revisions thereof. I also understand that a permit, if granted by the department, will be non-transferable and I will promptly notify the department upon sale or legal transfer of the permitted establishment.

*Attach letter of authorization

Signed: Edward B. Crowell

Edward B. Crowell, V.P. Facilities Div
Name and Title (Please type)

Date: _____ Telephone No. _____

B. PROFESSIONAL ENGINEER REGISTERED IN FLORIDA (where required by Chapter 471, F.S.)

This is to certify that the engineering features of this pollution control project have been ~~designed~~ examined by me and found to be in conformity with modern engineering principles applicable to the treatment and disposal of pollutants characterized in the permit application. There is reasonable assurance, in my professional judgment, that

¹ See Florida Administrative Code Rule 17-2.100(57) and (104)

the pollution control facilities, when properly maintained and operated, will discharge an effluent that complies with all applicable statutes of the State of Florida and the rules and regulations of the department. It is also agreed that the undersigned will furnish, if authorized by the owner, the applicant a set of instructions for the proper maintenance and operation of the pollution control facilities and, if applicable, pollution sources.

Signed Ted W. McKim

TED W. MCKIM
Name (Please Type)

Reedy Creek Utilities Co.
Company Name (Please Type)

PO. Box 40 LAKE BUENA VISTA, FLA.
Mailing Address (Please Type)

Florida Registration No. 25555 Date: 9/21/83 Telephone No. 305-824-4950

SECTION II: GENERAL PROJECT INFORMATION

Describe the nature and extent of the project. Refer to pollution control equipment, and expected improvements in source performance as a result of installation. State whether the project will result in full compliance. Attach additional sheet if necessary.

Installation of Binks Manufacturing model PFF type spray booth with model 30-800 fan rated at 24,800 SCFM to be used for spraying polyester resin systems, laquer based primers and sealers, and polyvinyl alcohol on fiberglass objects and molds.

Schedule of project covered in this application (Construction Permit Application Only)

Start of Construction existing booth Completion of Construction _____

Costs of pollution control system(s): (Note: Show breakdown of estimated costs only for individual components/units of the project serving pollution control purposes. Information on actual costs shall be furnished with the application for operation permit.)

N/A

Indicate any previous DER permits, orders and notices associated with the emission point, including permit issuance and expiration dates. NONE

Permit application called in by Chuck Collins of Florida DER to be submitted by 9/16/83.

E. Requested permitted equipment operating time: hrs/day 8 ; days/wk 5 ; wks/yr 52 ;
if power plant, hrs/yr _____ ; if seasonal, describe: _____

F. If this is a new source or major modification, answer the following questions.
(Yes or No)

1. Is this source in a non-attainment area for a particular pollutant? yes
a. If yes, has "offset" been applied? no
b. If yes, has "Lowest Achievable Emission Rate" been applied? no
c. If yes, list non-attainment pollutants. VOC (ozone)

2. Does best available control technology (BACT) apply to this source?
If yes, see Section VI. no

3. Does the State "Prevention of Significant Deterioration" (PSD)
requirement apply to this source? If yes, see Sections VI and VII. no

4. Do "Standards of Performance for New Stationary Sources" (NSPS)
apply to this source? no

5. Do "National Emission Standards for Hazardous Air Pollutants"
(NESHAP) apply to this source? no

H. Do "Reasonably Available Control Technology" (RACT) requirements apply
to this source? no

a. If yes, for what pollutants? _____

b. If yes, in addition to the information required in this form,
any information requested in Rule 17-2.650 must be submitted.

Attach all supportive information related to any answer of "Yes". Attach any justifi-
cation for any answer of "No" that might be considered questionable.

SECTION III: AIR POLLUTION SOURCES & CONTROL DEVICES (Other than Incinerators)

Raw Materials and Chemicals Used in your Process, if applicable:

Description	Contaminants		Utilization Rate - lbs/hr	Relate to Flow Diagram
	Type	% Wt		
polyester gelcoat	VOC/Partic.	0/100	0.4	
laquer based primers	VOC/Partic.	56/44	0.1	
polyvinyl alcohol	VOC/Partic.	0/100	0.1	
styrene (thinner)	VOC/Partic.	0/100	0.02	
acetone (thinner)	VOC/Partic.	100/0	0.02	

Process Rate, if applicable: (See Section V, Item 1)

1. Total Process Input Rate (lbs/hr): _____

2. Product Weight (lbs/hr): _____

Airborne Contaminants Emitted: (Information in this table must be submitted for each emission point, use additional sheets as necessary)

Name of Contaminant	Emission ¹		Allowed Emission Rate per Rule 17-2	Allowable ³ Emission lbs/hr	Potential ⁴ Emission		Relate to Flow Diagram
	Maximum lbs/hr	Actual T/yr			lbs/yr	T/yr	
CO	0.08	0.08			166	0.08	
particulate	0.02	0.02			586.4	0.29	

See Section V, Item 2.

Reference applicable emission standards and units (e.g. Rule 17-2.600(5)(b)2. Table II, (1) - 0.1 pounds per million BTU heat input)

Calculated from operating rate and applicable standard.

Emission, if source operated without control (See Section V, Item 3).

D. Control Devices: (See Section V, Item 4)

Name and Type (Model & Serial No.)	Contaminant	Efficiency	Range of Particles Size Collected (in microns) (If applicable)	Basis for Efficiency (Section V Item 5)
Binks Paint arrestor	Particulate	80% for laquers		Mfg. Spec.
Type filter model		95% for two part systems		Mfg. Spec.
29-893. Filter Bank				
dimensions 8.3 ft. x				
16.7 ft. or 139 sq. ft.				

E. Fuels

Type (Be Specific)	Consumption*		Maximum Heat Input (MMBTU/hr)
	avg/hr	max./hr	

*Units: Natural Gas--MMCF/hr; Fuel Oils--gallons/hr; Coal, wood, refuse, other--lbs/hr.

Fuel Analysis:

Percent Sulfur: _____ Percent Ash: _____

Density: _____ lbs/gal Typical Percent Nitrogen: _____

Heat Capacity: _____ BTU/lb _____ BTU/gal

Other Fuel Contaminants (which may cause air pollution): _____

F. If applicable, indicate the percent of fuel used for space heating.

Annual Average _____ Maximum _____

G. Indicate liquid or solid wastes generated and method of disposal.

BEST AVAILABLE COPY

1. Emission Stack Geometry and Flow Characteristics (Provide data for each stack):

Stack Height: 35 ft. Stack Diameter: 3.5 ft.
 Gas Flow Rate: -- ACFM 24,800* DSCFM Gas Exit Temperature: ambient °F.
 Vapor Contents: ambient % Velocity: 43 FPS

*1/4" W.C. static pressure

SECTION IV: INCINERATOR INFORMATION

Type of Waste	Type 0 (Plastics)	Type I (Rubbish)	Type II (Refuse)	Type III (Garbage)	Type IV (Pathological)	Type V (Liq. & Gas By-prod.)	Type VI (Solid By-prod.)
Actual lbs/hr Incinerated							
Uncontrolled (lbs/hr)							

Description of Waste _____
 Waste Weight Incinerated (lbs/hr) _____ Design Capacity (lbs/hr) _____
 Approximate Number of Hours of Operation per day _____ day/wk _____ wks/yr. _____
 Manufacturer _____
 Date Constructed _____ Model No. _____

	Volume (ft) ³	Heat Release (BTU/hr)	Fuel		Temperature (°F)
			Type	BTU/hr	
Primary Chamber					
Secondary Chamber					

Stack Height: _____ ft. Stack Diameter: _____ Stack Temp. _____
 Gas Flow Rate: _____ ACFM _____ DSCFM* Velocity: _____ FPS

If 50 or more tons per day design capacity, submit the emissions rate in grains per standard cubic foot dry gas corrected to 50% excess air.

Type of pollution control device: Cyclone Wet Scrubber Afterburner
 Other (specify) _____

Brief description of operating characteristics of control devices: _____

Ultimate disposal of any effluent other than that emitted from the stack (scrubber water, wash, etc.):

NOTE: Items 2, 3, 4, 6, 7, 8, and 10 in Section V must be included where applicable.

SECTION V: SUPPLEMENTAL REQUIREMENTS

Please provide the following supplements where required for this application.

1. Total process input rate and product weight -- show derivation [Rule 17-2.100(127)]
2. To a construction application, attach basis of emission estimate (e.g., design calculations, design drawings, pertinent manufacturer's test data, etc.) and attach proposed methods (e.g., FR Part 60 Methods 1, 2, 3, 4, 5) to show proof of compliance with applicable standards. To an operation application, attach test results or methods used to show proof of compliance. Information provided when applying for an operation permit from a construction permit shall be indicative of the time at which the test was made.
3. Attach basis of potential discharge (e.g., emission factor, that is, AP42 test).
4. With construction permit application, include design details for all air pollution control systems (e.g., for baghouse include cloth to air ratio; for scrubber include cross-section sketch, design pressure drop, etc.)
5. With construction permit application, attach derivation of control device(s) efficiency. Include test or design data. Items 2, 3 and 5 should be consistent: actual emissions = potential (1-efficiency).
6. An 8 1/2" x 11" flow diagram which will, without revealing trade secrets, identify the individual operations and/or processes. Indicate where raw materials enter, where solid and liquid waste exit, where gaseous emissions and/or airborne particles are evolved and where finished products are obtained.
7. An 8 1/2" x 11" plot plan showing the location of the establishment, and points of airborne emissions, in relation to the surrounding area, residences and other permanent structures and roadways (Example: Copy of relevant portion of USGS topographic map).
8. An 8 1/2" x 11" plot plan of facility showing the location of manufacturing processes and outlets for airborne emissions. Relate all flows to the flow diagram.

BEST AVAILABLE COPY

The appropriate application fee in accordance with Rule 17-4.05. The check should be made payable to the Department of Environmental Regulation.

With an application for operation permit, attach a Certificate of Completion of Construction indicating that the source was constructed as shown in the construction permit.

SECTION VI: BEST AVAILABLE CONTROL TECHNOLOGY

Are standards of performance for new stationary sources pursuant to 40 C.F.R. Part 60 applicable to the source?

[] Yes [] No

Contaminant

Rate or Concentration

Has EPA declared the best available control technology for this class of sources (If yes, attach copy)

[] Yes [] No

Contaminant

Rate or Concentration

What emission levels do you propose as best available control technology?

Contaminant

Rate or Concentration

Describe the existing control and treatment technology (if any).

1. Control Device/System:

2. Operating Principles:

3. Efficiency:*

4. Capital Costs:

Explain method of determining

5. Useful Life:

6. Operating Costs:

7. Energy:

8. Maintenance Cost:

9. Emissions:

Contaminant

Rate or Concentration

10. Stack Parameters

a. Height:

ft.

b. Diameter:

ft.

c. Flow Rate:

ACFM

d. Temperature:

°F.

e. Velocity:

FPS

E. Describe the control and treatment technology available (As many types as applicable, use additional pages if necessary).

1.

a. Control Device:

b. Operating Principles:

c. Efficiency:¹

d. Capital Cost:

e. Useful Life:

f. Operating Cost:

g. Energy:²

h. Maintenance Cost:

i. Availability of construction materials and process chemicals:

j. Applicability to manufacturing processes:

k. Ability to construct with control device, install in available space, and operate within proposed levels:

2.

a. Control Device:

b. Operating Principles:

c. Efficiency:¹

d. Capital Cost:

e. Useful Life:

f. Operating Cost:

g. Energy:²

h. Maintenance Cost:

i. Availability of construction materials and process chemicals:

¹Explain method of determining efficiency.

²Energy to be reported in units of electrical power - KWH design rate.

2. Applicability to manufacturing processes:

k. Ability to construct with control device, install in available space, and operate within proposed levels:

3.

a. Control Device:

b. Operating Principles:

c. Efficiency:¹

d. Capital Cost:

e. Useful Life:

f. Operating Cost:

g. Energy:²

h. Maintenance Cost:

i. Availability of construction materials and process chemicals:

j. Applicability to manufacturing processes:

k. Ability to construct with control device, install in available space, and operate within proposed levels:

a. Control Device:

b. Operating Principles:

c. Efficiency:¹

d. Capital Costs:

e. Useful Life:

f. Operating Cost:

g. Energy:²

h. Maintenance Cost:

i. Availability of construction materials and process chemicals:

j. Applicability to manufacturing processes:

k. Ability to construct with control device, install in available space, and operate within proposed levels:

Describe the control technology selected:

1. Control Device:

2. Efficiency:¹

3. Capital Cost:

4. Useful Life:

5. Operating Cost:

6. Energy:²

7. Maintenance Cost:

8. Manufacturer:

9. Other locations where employed on similar processes:

a. (1) Company:

b. (2) Mailing Address:

c. (3) City:

(4) State:

Explain method of determining efficiency.

Energy to be reported in units of electrical power - KWH design rate.

(5) Environmental Manager:

(6) Telephone No.:

(7) Emissions:¹

Contaminant

Rate or Concentration

(8) Process Rate:¹

b. (1) Company:

(2) Mailing Address:

(3) City:

(4) State:

(5) Environmental Manager:

(6) Telephone No.:

(7) Emissions:¹

Contaminant

Rate or Concentration

(8) Process Rate:¹

10. Reason for selection and description of systems:

¹Applicant must provide this information when available. Should this information not be available, applicant must state the reason(s) why.

SECTION VII - PREVENTION OF SIGNIFICANT DETERIORATION

A. Company Monitored Data

1. _____ no. sites _____ TSP () SO₂* _____ Wind spd/dir

Period of Monitoring _____ / _____ / _____ to _____ / _____ / _____
month day year month day year

Other data recorded _____

Attach all data or statistical summaries to this application.

*Specify bubbler (B) or continuous (C).

2. Instrumentation, Field and Laboratory

- a. Was instrumentation EPA referenced or its equivalent? Yes No
- b. Was instrumentation calibrated in accordance with Department procedures?
 Yes No Unknown

Meteorological Data Used for Air Quality Modeling

- 1. _____ Year(s) of data from _____ / _____ / _____ to _____ / _____ / _____
month day year month day year
- 2. Surface data obtained from (location) _____
- 3. Upper air (mixing height) data obtained from (location) _____
- 4. Stability wind rose (STAR) data obtained from (location) _____

Computer Models Used

- 1. _____ Modified? If yes, attach description.
- 2. _____ Modified? If yes, attach description.
- 3. _____ Modified? If yes, attach description.
- 4. _____ Modified? If yes, attach description.

Attach copies of all final model runs showing input data, receptor locations, and principle output tables.

Applicants Maximum Allowable Emission Data

Pollutant	Emission Rate
TSP	_____ grams/sec
SO ₂	_____ grams/sec

Emission Data Used in Modeling

Attach list of emission sources. Emission data required is source name, description of point source (on NEDS point number), UTM coordinates, stack data, allowable emissions, and normal operating time.

Attach all other information supportive to the PSD review.

Discuss the social and economic impact of the selected technology versus other applicable technologies (i.e., jobs, payroll, production, taxes, energy, etc.). Include assessment of the environmental impact of the sources.

Attach scientific, engineering, and technical material, reports, publications, journals, and other competent relevant information describing the theory and application of the requested best available control technology.

Attachment #1

A. Calculation of Utilization Rates and Percent Contaminants

Polyester gelcoats and styrene can be considered as two part systems containing essentially no VOC since the material hardens via a chemical reaction rather than by drying. Polyvinyl alcohol is an essentially non-volatile material used to coat fiberglass molds to prevent lay-up from sticking and it too contains essentially no VOC.

The calculation of the percent weight of contaminants in laquer based primers and sealers proceeds as follows:

AP-42 4.2.2.1-2 gives a percent by volume for particulates (solids) in laquer of 26.1% and a density of 7.9 lbs/gal.

1 gal of laquer = 73.9% solvents
 = .739 gal solvents
 laquer thinner typically weighs about 6 lbs/gallon (0.739 gal)
 (6 lbs/gal) = 4.43 lbs

1 gal of laquer weighs 7.9 lbs, 4.43 lbs of which is solvent, therefore, $7.9 - 4.43 =$ weight of solids = 3.47 lbs, percent by weight of solids = $\left[\frac{3.47 \text{ lbs}}{7.9 \text{ lbs}} \right] \times 100 = 43.9\%$.

Type of Coating	Approx. Weekly Usage	Density (lbs/gal)	Rate (lbs/hr.)
polyester gelcoat	2. gal	8.0	0.4
laquer based primers	0.5 gal	7.9	0.1
polyvinyl alcohol	0.5 gal	7.26	0.1
styrene (thinner)	0.1 gal	7.52	0.02
acetone (thinner)	0.1 gal	6.59	0.02

B. Calculation of Potential and Actual Emissions for VOC

VOC Emissions: the sources of VOC from this booth come from the thinning solvent acetone and the solvent component of the laquer based primers. All of the acetone used will be emitted as VOC, and the VOC emissions from the laquer based primers can be calculated as follows:

AP-42 4.2.2.1-2 states that laquers are typically 26.1% solids by volume or 73.9% solvents by volume. It has been demonstrated previously in this attachment that this equates to 43.9% by weight solids and 56.1% by weight solvents.

(Laquer utilization rate) (% by weight solvents) = solvent emission (0.1 lbs/hr.) (0.561) = 0.06 lbs/hr. solvents emitted from laquer based primers (0.06 lbs/hr.) (8 hrs/day) (5 days/wk.) (52 wks./yr.)
 = 124.8 lbs/yr.
 = 0.06 T/yr.

VOC emissions rate for acetone = utilization rate for acetone (0.02 lbs/hr.) (8 hrs/day) (5 days/wk.) (52 wks/yr)
 0.02 = 41.6 lbs/yr.
 = 0.02T/yr.

$$\begin{aligned} \text{Total VOC Emissions} &= (\text{portion from laquer}) + (\text{Portion from acetone}) \\ &= (124.8 \text{ lbs/yr}) + (41.6 \text{ lbs/yr}) = 166.4 \text{ lbs/yr.} \\ &= 0.08 \text{ T/yr.} \end{aligned}$$

C. Calculation of Actual and Potential Emissions for Particulate

<u>Material</u>	<u>% Solids (by wt.)</u>	<u>Utilization Rate (lbs/hr.)</u>
polyester gelcoat	100	0.4
polyvinyl alcohol	100	0.1
styrene	100	0.02
laquer based primers	43.9	0.1
acetone	0	0.02

The types of materials sprayed in this booth vary from flat sheets to multi-faceted ornate facade parts. Generally they can be considered to be flat type surfaces for overspray consideration, with an overspray rate of 50% (AP-40 pp 861).

The particulate emission calculation proceeds as follows:

$$\begin{aligned} (\text{Utilization rate}) (\text{fraction of solids}) (\text{fraction of overspray}) \\ = (\text{potential emissions}) \end{aligned}$$

Sample calculation for laquer based primers:

$$\begin{aligned} (0.10 \text{ lbs/yr.}) (.439) (.50) &= 0.02 \text{ lbs/hr.} \\ (0.02 \text{ lbs/hr.}) (8 \text{ hr/day}) (5 \text{ day/wk}) (52 \text{ wk/yr.}) &= 45.6 \text{ lbs/yr.} \\ &= 0.02 \text{ T/yr.} \\ &\text{potential emissions} \end{aligned}$$

The actual emissions take into account a filter efficiency of 80% for laquers and 95% for two part high particulate coating systems (as quoted from the manufacturer)

Sample calculation for laquer based primers:

$$\begin{aligned} (\text{Potential Emissions}) (1 - \text{filter efficiency}) &= \text{actual emissions} (45.6 \\ \text{lbs/yr.}) (.20) &= 9.1 \text{ lbs/yr.} \\ &= 0.005 \text{ T/yr.} \end{aligned}$$

<u>Material</u>	<u>Actual Emissions</u>	<u>Potential Emissions</u>
polyester gelcoat	20.8 lbs/yr.	416 lbs/yr.
laquer based primers	9.1 lbs/yr.	45.6 lbs/yr.
polyvinyl alcohol	5.2 lbs/yr.	104 lbs/yr.
styrene	1.0 lbs/yr.	20.8 lbs/yr.
acetone	0	0
Total:	36.1 lbs/yr. 0.02 T/yr.	586.4 lbs/yr. 0.29 T/yr.

Attachment #2

Attachment 2 - Flow Diagram

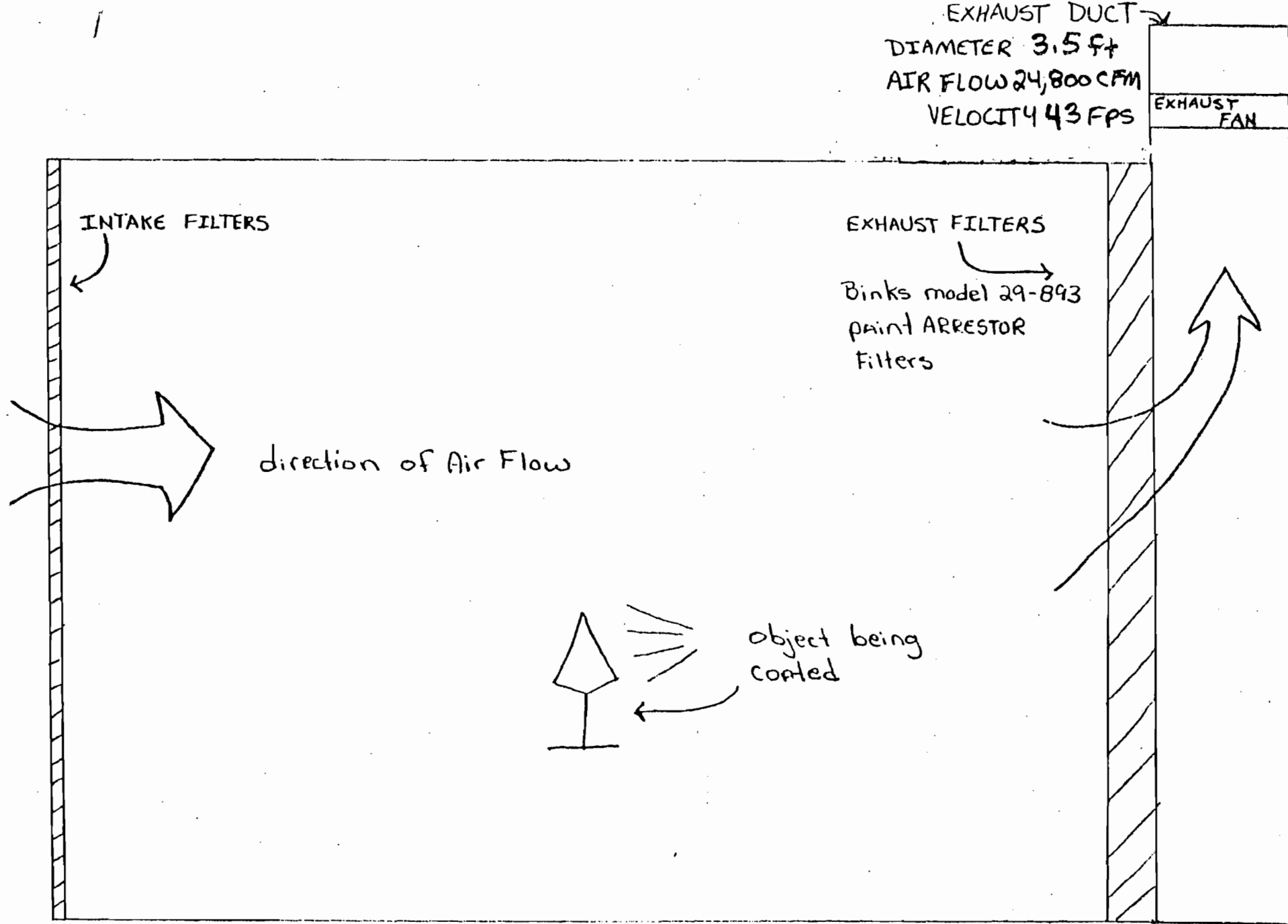

Attachment #3

BEST AVAILABLE COPY

SOURCES OF AIR CONTAMINANTS

1. Central Shops
2. WDW Laundry/Dry Cleaning
3. RCUC Trubines, boilers
4. Waste incinerator, closed.

other sources not shown:
boilers and emergency generators
at EPCOT Central Energy Plant

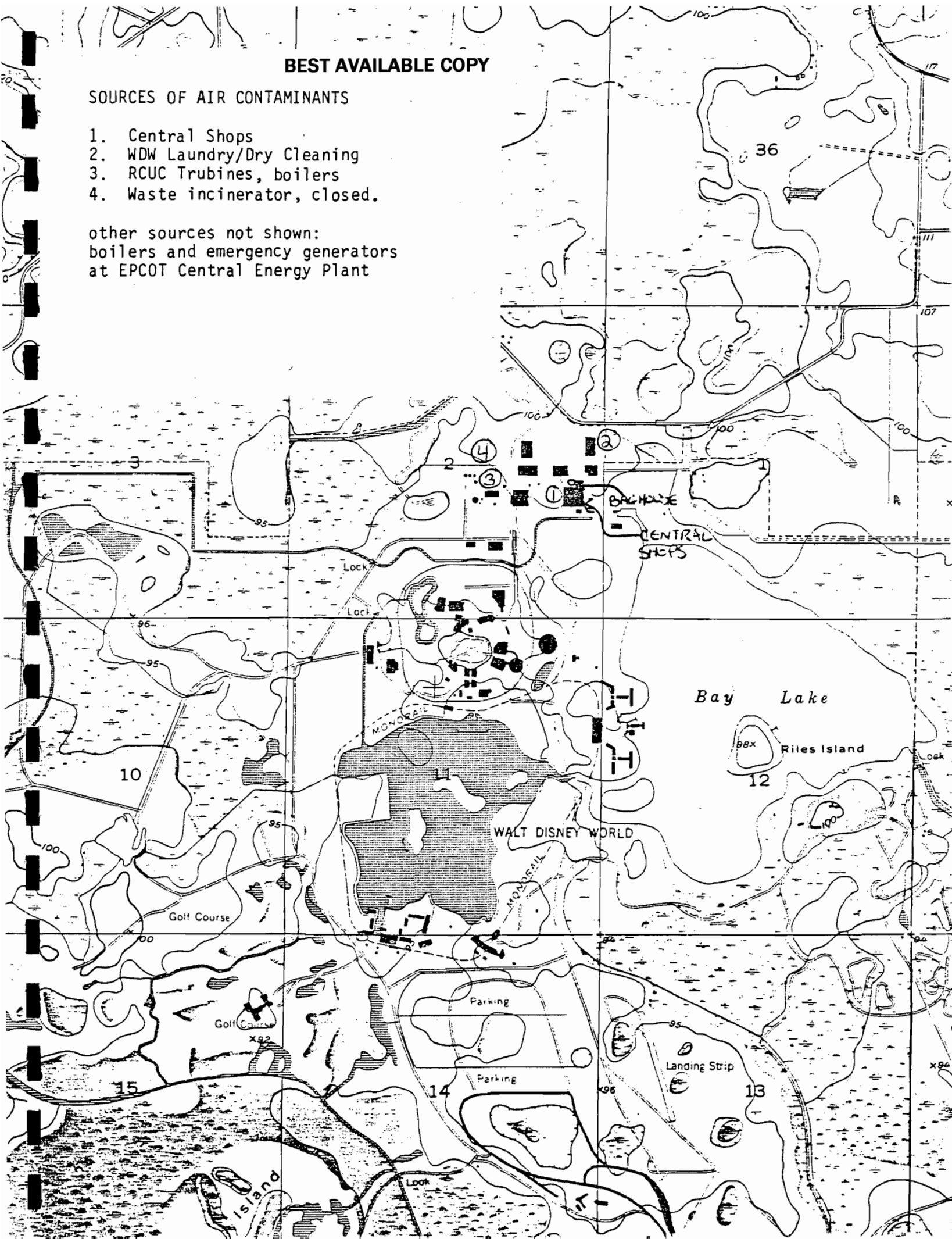

CHAMBER

BEST AVAILABLE COPY

↑ to other shops

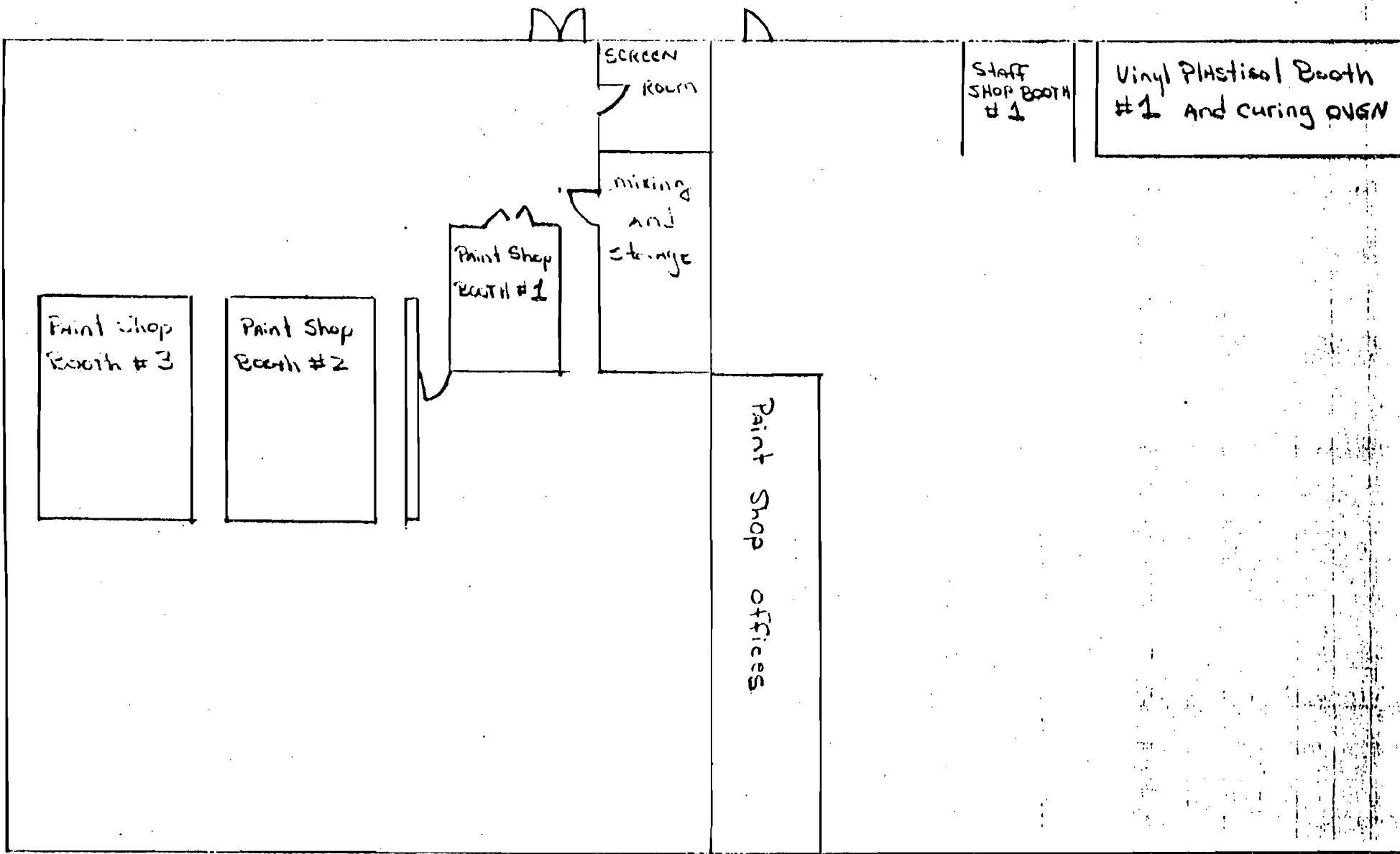

SKETCH OF Facility Layout, not to scale

AC 48-108744

BEST AVAILABLE COPY

STATE OF FLORIDA

AC 48-75837

DEPARTMENT OF ENVIRONMENTAL REGULATION

ST. JOHNS RIVER DISTRICT

3319 MAGUIRE BOULEVARD SUITE 232 ORLANDO, FLORIDA 32803

PAID 100 SEP 22 1983

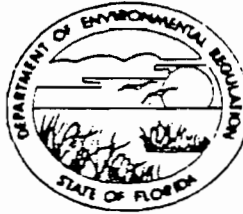

BOB GRAHAM GOVERNOR

TORIA J. TSCHINKEL SECRETARY

DEX SENKEVICH DISTRICT MANAGER

OCT 6 1983

SAINT JOHNS RIVER DISTRICT



BAOM

APPLICATION TO OPERATE/CONSTRUCT AIR POLLUTION SOURCE

SOURCE TYPE: Spray Booth [] New [] Existing

APPLICATION TYPE: [X] Construction [] Operation [] Modification

COMPANY NAME: WALT DISNEY WORLD Co., Inc. COUNTY: Orange

Identify the specific emission point source(s) addressed in this application (i.e. Lime Kiln No. 4 with Venturi Scrubber; Peaking Unit No. 2, Gas Fired) NSA Staff Shop Spray Booth #2

SOURCE LOCATION: Street Facilities Way City Bay Lake

UTM: East 443586 North 314436

Latitude 28 ° 25 ' 32 "N Longitude 81 ° 34 ' 36 "W

APPLICANT NAME AND TITLE: Edward B. Crowell, V.P. Facilities Division

APPLICANT ADDRESS: P. O. Box 40 Lake Buena Vista, FL 32830

SECTION I: STATEMENTS BY APPLICANT AND ENGINEER

A. APPLICANT

I am the undersigned owner or authorized representative* of WALT DISNEY WORLD Co.

I certify that the statements made in this application for a Construction permit are true, correct and complete to the best of my knowledge and belief. Further I agree to maintain and operate the pollution control source and pollution control facilities in such a manner as to comply with the provision of Chapter 403, Florida Statutes, and all the rules and regulations of the department and revisions thereof. I also understand that a permit, if granted by the department, will be non-transferable and I will promptly notify the department upon sale or legal transfer of the permit establishment.

*Attach letter of authorization

Signed: Edward B. Crowell

Edward B. Crowell, V.P.-Facilities Division Name and Title (Please Type)

Date: Telephone No. (305) 823-7700

B. PROFESSIONAL ENGINEER REGISTERED IN FLORIDA (where required by Chapter 471, F.S.)

This is to certify that the engineering features of this pollution control project have been designed/examined by me and found to be in conformity with modern engineering principles applicable to the treatment and disposal of pollutants characterized in the permit application. There is reasonable assurance, in my professional judgment, that

1 See Florida Administrative Code Rule 17-2.100(57) and (104)

the pollution control facilities, when properly maintained and operated, will discharge an effluent that complies with all applicable statutes of the State of Florida and the rules and regulations of the department. It is also agreed that the undersigned will furnish, if authorized by the owner, the applicant a set of instructions for the proper maintenance and operation of the pollution control facilities and, if applicable, pollution sources.

Signed Ted W. McKim

TED W. MCKIM
Name (Please Type)

Reedy Creek Utilities Co
Company Name (Please Type)

P.O. Box 40 LAKE BUENA VISTA, FLA.
Mailing Address (Please Type)

Florida Registration No. 25555 Date: 9/21/83 Telephone No. 305-824-4950

SECTION II: GENERAL PROJECT INFORMATION

Describe the nature and extent of the project. Refer to pollution control equipment, and expected improvements in source performance as a result of installation. State whether the project will result in full compliance. Attach additional sheet if necessary.

Construction of built-in spray booth with a new york blower model #S48-1 rated at 9,000 CFM for spray coating fiberglass molds and objects with polyester resin system, laquer based primers, and polyvinyl alcohol

Schedule of project covered in this application (Construction Permit Application Only)

Start of Construction existing booth Completion of Construction _____

Costs of pollution control system(s): (Note: Show breakdown of estimated costs only for individual components/units of the project serving pollution control purposes. Information on actual costs shall be furnished with the application for operation permit.)

N/A

Indicate any previous DER permits, orders and notices associated with the emission point, including permit issuance and expiration dates. NONE

Permit application called in by Chick Collins of Florida DER to be submitted by 9/16/83.

E. Requested permitted equipment operating time: hrs/day 8; days/wk 5; wks/yr 52;
if power plant, hrs/yr _____; if seasonal, describe: _____

F. If this is a new source or major modification, answer the following questions.
(Yes or No)

1. Is this source in a non-attainment area for a particular pollutant? yes
 - a. If yes, has "offset" been applied? no
 - b. If yes, has "Lowest Achievable Emission Rate" been applied? no
 - c. If yes, list non-attainment pollutants. VOC (ozone)
2. Does best available control technology (BACT) apply to this source?
If yes, see Section VI. no
3. Does the State "Prevention of Significant Deterioration" (PSD)
requirement apply to this source? If yes, see Sections VI and VII. no
4. Do "Standards of Performance for New Stationary Sources" (NSPS)
apply to this source? no
5. Do "National Emission Standards for Hazardous Air Pollutants"
(NESHAP) apply to this source? no

H. Do "Reasonably Available Control Technology" (RACT) requirements apply
to this source? _____

- a. If yes, for what pollutants? _____
- b. If yes, in addition to the information required in this form,
any information requested in Rule 17-2.650 must be submitted.

Attach all supportive information related to any answer of "Yes". Attach any justifi-
cation for any answer of "No" that might be considered questionable.

SECTION III: AIR POLLUTION SOURCES & CONTROL DEVICES (Other than Incinerators)

Raw Materials and Chemicals Used in your Process, if applicable:

Description	Contaminants		Utilization Rate - lbs/hr	Relate to Flow Diagram
	Type	% Wt		
polyester gelcoat	VOC/Partic	0/100	3.6	
aqueous based primer	VOC/Partic	56/44	0.9	
polyvinyl alcohol	VOC/Partic	0/100	0.8	
xylene (thinner)	VOC/Partic	0/100	0.2	
acetone (thinner)	VOC/Partic	100/0	0.1	

Process Rate, if applicable: (See Section V, Item 1)

Total Process Input Rate (lbs/hr): _____

2. Product Weight (lbs/hr): _____

Airborne Contaminants Emitted: (Information in this table must be submitted for each emission point, use additional sheets as necessary)

Name of contaminant	Emission ¹		Allowed ² Emission Rate per Rule 17-2	Allowable ³ Emission lbs/hr	Potential ⁴ Emission		Relate to Flow Diagram
	Maximum lbs/hr	Actual T/yr			lbs/yr	T/yr	
OC	0.61	0.63			1258	0.63	
particulate	0.15	0.16			200	2.6	

See Section V, Item 2.

Reference applicable emission standards and units (e.g. Rule 17-2.600(5)(b)2. Table II, (b) - 0.1 pounds per million BTU heat input)

Calculated from operating rate and applicable standard.

Uncontrolled, if source operated without control (See Section V, Item 3).

D. Control Devices: (See Section V, Item 4)

Name and Type (Model & Serial No.)	Contaminant	Efficiency	Range of Particles Size Collected (in microns) (If applicable)	Basis for Efficiency (Section V Item 5)
Binks Paint Arrestor	Particulate	80% for laquers		Mfg. Spec.
type filter model		95% for 2part sys.		Mfg. Spec.
29-893 filter				
Bank dimensions:				
13.3 ft x 25 ft				
or 333 ft ²				

E. Fuels

Type (Be Specific)	Consumption*		Maximum Heat Input (MMBTU/hr)
	avg/hr	max./hr	

*Units: Natural Gas--MMCF/hr; Fuel Oils--gallons/hr; Coal, wood, refuse, other--lbs/hr.

Fuel Analysis:

Percent Sulfur: _____ Percent Ash: _____

Density: _____ lbs/gal Typical Percent Nitrogen: _____

Heat Capacity: _____ BTU/lb _____ BTU/gal

Other Fuel Contaminants (which may cause air pollution): _____

F. If applicable, indicate the percent of fuel used for space heating.

Annual Average _____ Maximum _____

G. Indicate liquid or solid wastes generated and method of disposal.

H. Emission Stack Geometry and Flow Characteristics (Provide data for each stack):
 Stack Height: 35 ft. Stack Diameter: 5 ft. x 3.4 ft. ft.
 Gas Flow Rate: ACFM 29,000 DSCFM Gas Exit Temperature: ambient °F.
 Water Vapor Content: ambient % Velocity: 28.4 FPS
 @ " W.C. static pressure

SECTION IV: INCINERATOR INFORMATION

Type of Waste	Type 0 (Plastics)	Type I (Rubbish)	Type II (Refuse)	Type III (Garbage)	Type IV (Pathological)	Type V (Liq. & Gas By-prod.)	Type VI (Solid By-prod.)
Actual lbs/hr Incinerated							
Uncontrolled (lbs/hr)							

Description of Waste _____
 Total Weight Incinerated (lbs/hr) _____ Design Capacity (lbs/hr) _____
 Approximate Number of Hours of Operation per day _____ day/wk _____ wks/yr. _____
 Manufacturer _____
 Date Constructed _____ Model No. _____

	Volume (ft) ³	Heat Release (BTU/hr)	Fuel		Temperature (°F)
			Type	BTU/hr	
Primary Chamber					
Secondary Chamber					

Stack Height: _____ ft. Stack Diameter: _____ Stack Temp: _____
 Gas Flow Rate: _____ ACFM _____ DSCFM* Velocity: _____ FPS

If 50 or more tons per day design capacity, submit the emissions rate in grains per standard cubic foot dry gas corrected to 50% excess air.

Type of pollution control devices: Cyclone Wet Scrubber Afterburner
 Other (specify) _____

Brief description of operating characteristics of control devices: _____

Ultimate disposal of any effluent other than that emitted from the stack (scrubber water, ash, etc.):

NOTE: Items 2, 3, 4, 6, 7, 8, and 10 in Section V must be included where applicable.

SECTION V: SUPPLEMENTAL REQUIREMENTS

Please provide the following supplements where required for this application.

1. Total process input rate and product weight -- show derivation [Rule 17-2.100(127)]
2. To a construction application, attach basis of emission estimate (e.g., design calculations, design drawings, pertinent manufacturer's test data, etc.) and attach proposed methods (e.g., FR Part 60 Methods 1, 2, 3, 4, 5) to show proof of compliance with applicable standards. To an operation application, attach test results or methods used to show proof of compliance. Information provided when applying for an operation permit from a construction permit shall be indicative of the time at which the test was made.
3. Attach basis of potential discharge (e.g., emission factor, that is, AP42 test).
4. With construction permit application, include design details for all air pollution control systems (e.g., for baghouse include cloth to air ratio; for scrubber include cross-section sketch, design pressure drop, etc.)
5. With construction permit application, attach derivation of control device(s) efficiency. Include test or design data. Items 2, 3 and 5 should be consistent: actual emissions = potential (1-efficiency).
6. An 8 1/2" x 11" flow diagram which will, without revealing trade secrets, identify the individual operations and/or processes. Indicate where raw materials enter, where solid and liquid waste exit, where gaseous emissions and/or airborne particles are evolved and where finished products are obtained.
7. An 8 1/2" x 11" plot plan showing the location of the establishment, and points of airborne emissions, in relation to the surrounding area, residences and other permanent structures and roadways (Example: Copy of relevant portion of USGS topographic map).
8. An 8 1/2" x 11" plot plan of facility showing the location of manufacturing processes and outlets for airborne emissions. Relate all flows to the flow diagram.

BEST AVAILABLE COPY

The appropriate application fee in accordance with Rule 17-4.05. The check should be made payable to the Department of Environmental Regulation.

With an application for operation permit, attach a Certificate of Completion of Construction indicating that the source was constructed as shown in the construction permit.

SECTION VI: BEST AVAILABLE CONTROL TECHNOLOGY

Are standards of performance for new stationary sources pursuant to 40 C.F.R. Part 60 applicable to the source?

[] Yes [] No

Contaminant

Rate or Concentration

Has EPA declared the best available control technology for this class of sources (if yes, attach copy)

[] Yes [] No

Contaminant

Rate or Concentration

What emission levels do you propose as best available control technology?

Contaminant

Rate or Concentration

Describe the existing control and treatment technology (if any).

1. Control Device/System:

2. Operating Principles:

3. Efficiency:*

4. Capital Costs:

Explain method of determining

5. Useful Life:

6. Operating Costs:

7. Energy:

8. Maintenance Cost:

9. Emissions:

Contaminant

Rate or Concentration

Contaminant	Rate or Concentration

10. Stack Parameters

- a. Height: ft.
- b. Diameter: ft.
- c. Flow Rate: ACFM
- d. Temperature: °F.
- e. Velocity: FPS

E. Describe the control and treatment technology available (As many types as applicable, use additional pages if necessary).

1.

- a. Control Device:
- b. Operating Principles:
- c. Efficiency:¹
- d. Capital Cost:
- e. Useful Life:
- f. Operating Cost:
- g. Energy:²
- h. Maintenance Cost:
- i. Availability of construction materials and process chemicals:
- j. Applicability to manufacturing processes:
- k. Ability to construct with control device, install in available space, and operate within proposed levels:

2.

- a. Control Device:
- b. Operating Principles:
- c. Efficiency:¹
- d. Capital Cost:
- e. Useful Life:
- f. Operating Cost:
- g. Energy:²
- h. Maintenance Cost:
- i. Availability of construction materials and process chemicals:

¹Explain method of determining efficiency.

²Energy to be reported in units of electrical power - KWH design rate.

- j. Applicability to manufacturing processes:
- k. Ability to construct with control device, install in available space, and operate within proposed levels:

- a. Control Device:
- b. Operating Principles:
- c. Efficiency:¹
- d. Capital Cost:
- e. Useful Life:
- f. Operating Cost:
- g. Energy:²
- h. Maintenance Cost:

- i. Availability of construction materials and process chemicals:
- j. Applicability to manufacturing processes:
- k. Ability to construct with control device, install in available space, and operate within proposed levels:

- a. Control Device:
- b. Operating Principles:
- c. Efficiency:¹
- d. Capital Costs:
- e. Useful Life:
- f. Operating Cost:
- g. Energy:²
- h. Maintenance Cost:

- i. Availability of construction materials and process chemicals:
- j. Applicability to manufacturing processes:
- k. Ability to construct with control device, install in available space, and operate within proposed levels:

Describe the control technology selected:

- 1. Control Device:
- 2. Efficiency:¹
- 3. Capital Cost:
- 4. Useful Life:
- 5. Operating Cost:
- 6. Energy:²
- 7. Maintenance Cost:
- 8. Manufacturer:

Other locations where employed on similar processes:

- a. (1) Company:
- (2) Mailing Address:
- (3) City:
- (4) State:

Explain method of determining efficiency.
Energy to be reported in units of electrical power - KWH design rate.

(5) Environmental Manager:

(6) Telephone No.:

(7) Emissions:¹

Contaminant

Rate or Concentration

(8) Process Rate:¹

b. (1) Company:

(2) Mailing Address:

(3) City:

(4) State:

(5) Environmental Manager:

(6) Telephone No.:

(7) Emissions:¹

Contaminant

Rate or Concentration

(8) Process Rate:¹

10. Reason for selection and description of systems:

¹Applicant must provide this information when available. Should this information not be available, applicant must state the reason(s) why.

SECTION VII - PREVENTION OF SIGNIFICANT DETERIORATION

A. Company Monitored Data

1. _____ no. sites _____ TSP _____ () SO₂ _____ Wind spd/dir

Period of Monitoring _____ / _____ / _____ to _____ / _____ / _____
month day year month day year

Other data recorded _____

Attach all data or statistical summaries to this application.

*Specify bubbler (B) or continuous (C).

Attachment #1

A. Calculation of Utilization Rates and Percent Contaminants

Polyester gelcoats and styrene can be considered as two part systems containing essentially no VOC since the material hardens via a chemical reaction rather than by drying. Polyvinyl alcohol is an essentially non-volatile material used to coat fiberglass molds to prevent lay-up from sticking and it too contains essentially no VOC.

The calculation of the percent weight of contaminants in laquer based primers and sealers proceeds as follows:

AP-42 4.2.2.1-2 gives a percent by volume for particulates (solids) in laquer of 26.1% and a density of 7.9 lbs/gal.

1 gal of laquer = 73.9% solvents
 = .739 gal solvents
 laquer thinner typically weighs about 6 lbs/gallon (0.739 gal)
 (6 lbs/gal) = 4.43 lbs

1 gal of laquer weighs 7.9 lbs, 4.43 lbs of which is solvent, therefore, $7.9 - 4.43 =$ weight of solids = 3.47 lbs. percent by weight of solids = $\left[\frac{(3.47 \text{ lbs})}{(7.9 \text{ lbs})} \right] \times 100 = 43.9\%$.

Type of Coating	Approx. Weekly Usage	Density (lbs/gal)	Rate (lbs/gal)
polyester gelcoat	18 gal	8.0	3.6
laquer based primers	4.5 gal	7.9	0.9
polyvinyl alcohol	4.5 gal	7.26	0.8
styrene (thinner)	0.9 gal	7.52	0.2
acetone (thinner)	0.9 gal	6.59	0.1

B. Calculation of Potential and Actual Emissions for VOC

VOC Emissions: the sources of VOC from this booth come from the thinning solvent acetone and the solvent component of the laquer based primers. All of the acetone used will be emitted as VOC, and the VOC emissions from the laquer based primers can be calculated as follows:

AP-42 4.2.2.1-2 states that laquers are typically 26.1% solids by volume or 73.9% solvents by volume. It has been demonstrated previously in this attachment that this equates to 43.9% by weight solids and 56.1% by weight solvents.

(Laquer utilization rate) (% by weight solvents) = solvent emission
 (0.9 lbs/hr.) (0.561) = 0.50 lbs/hr. solvents emitted from laquer based primers (0.50 lbs/hr.) (8 hrs/day) (5 days/wk.) (52 wks./yr.)
 = 1050 lbs/yr.
 = 0.52 T/yr.

VOC emissions rate for acetone = utilization rate for acetone
 (0.1 lbs/hr.) (8 hrs/day) (5 days/wk.) (52 wks/yr)
 = 208 lbs/yr.
 = 0.10 T/yr.

Emissions for VOC
 September 16, 1983
 Page Two

Total VOC Emissions = (portion from laquer) + (Portion from acetone)
 = (1050 lbs/yr) + (208 lbs/yr) = 1258 lbs/yr.
 = 0.63 T/yr.

C. Calculation of Actual and Potential Emissions for Particulate

<u>Material</u>	<u>% Solids (by wt.)</u>	<u>Utilization Rate (lbs/hr.)</u>
polyester gelcoat	100	3.6
polyvinyl alcohol	100	0.8
styrene	100	0.2
laquer based primers	43.9	0.9
acetone	0	0.1

The types of materials sprayed in this booth vary from flat sheets to multi-faceted ornate facade parts. Generally they can be considered to be flat type surfaces for overspray consideration, with an overspray rate of 50% (AP-40 pp 861).

The particulate emission calculation proceeds as follows:

(Utilization rate) (fraction of solids) (fraction of overspray)
 = (potential emissions)

Sample calculation for laquer based primers:
 (0.9 lbs/yr.) (.439) (.50) = 0.20 lbs/hr.
 (0.20 lbs/hr.) (8 hr/day) (5 day/wk) (52 wk/yr.) = 416 lbs/yr.
 = 0.21 T/yr.
 potential emissions

The actual emissions take into account a filter efficiency of 80% for laquers and 95% for two part high particulate coating systems (as quoted from the manufacturer)

Sample calculation for laquer based primers:

(Potential Emissions) (1-filter efficiency) = actual emissions (416 lbs/yr.) (0.20) = 83.2 lbs/yr.
 = 0.04 T/yr.

<u>Material</u>	<u>Actual Emissions</u>	<u>Potential Emissions</u>
polyester gelcoat	187 lbs/yr.	3744 lbs/yr.
laquer based primers	83.2 lbs/yr.	416 lbs/yr.
polyvinyl alcohol	41.6 lbs/yr.	832 lbs/yr.
styrene	10.4 lbs/yr.	208 lbs/yr.
acetone	0	0
Total:	322.2 lbs/yr. 0.16 T/yr.	5200 lbs/yr. 2.6 T/yr.

Attachment #2

Attachment 2 - Flow Diagram

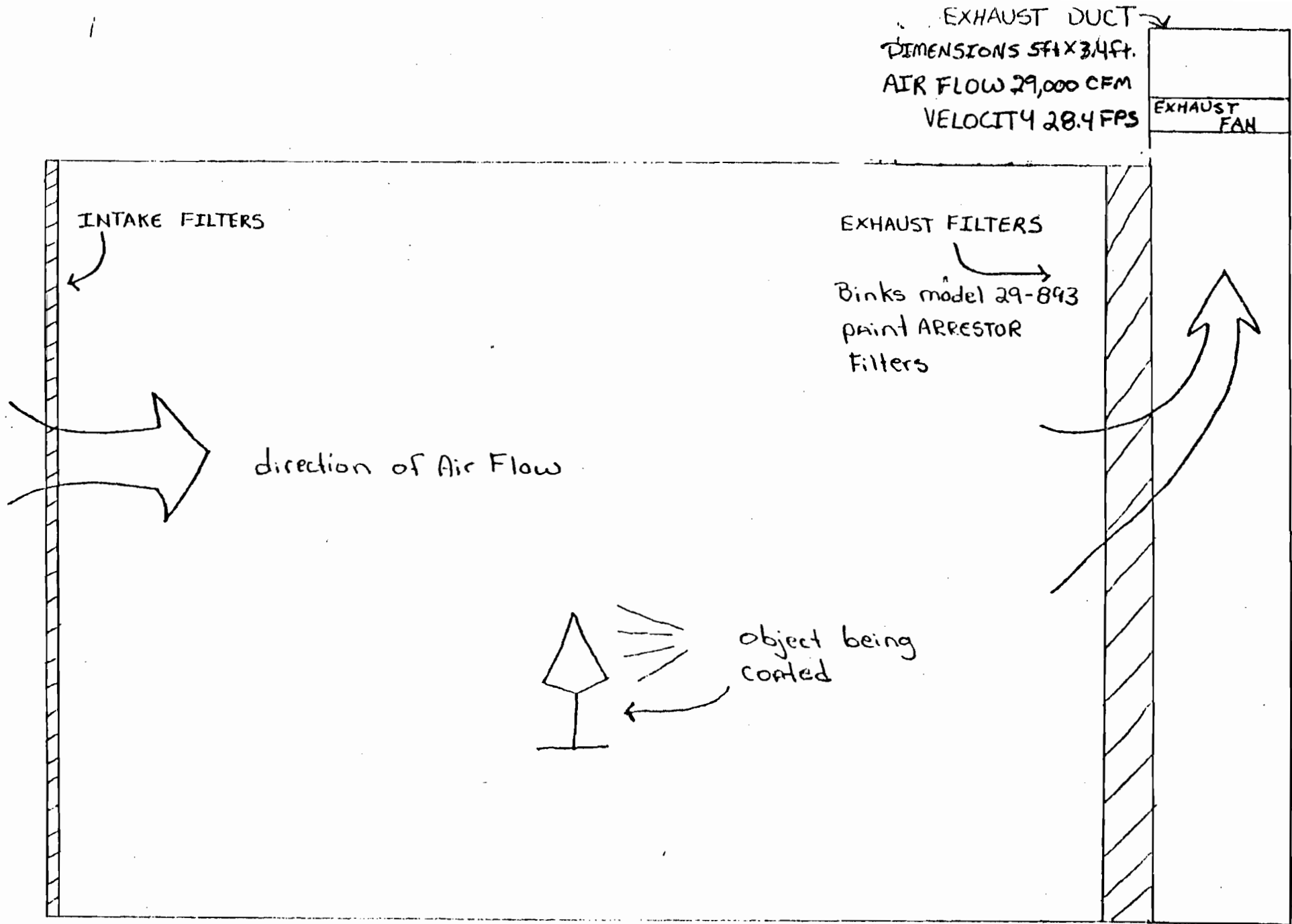

NE CORNER
SHOPS BLDG

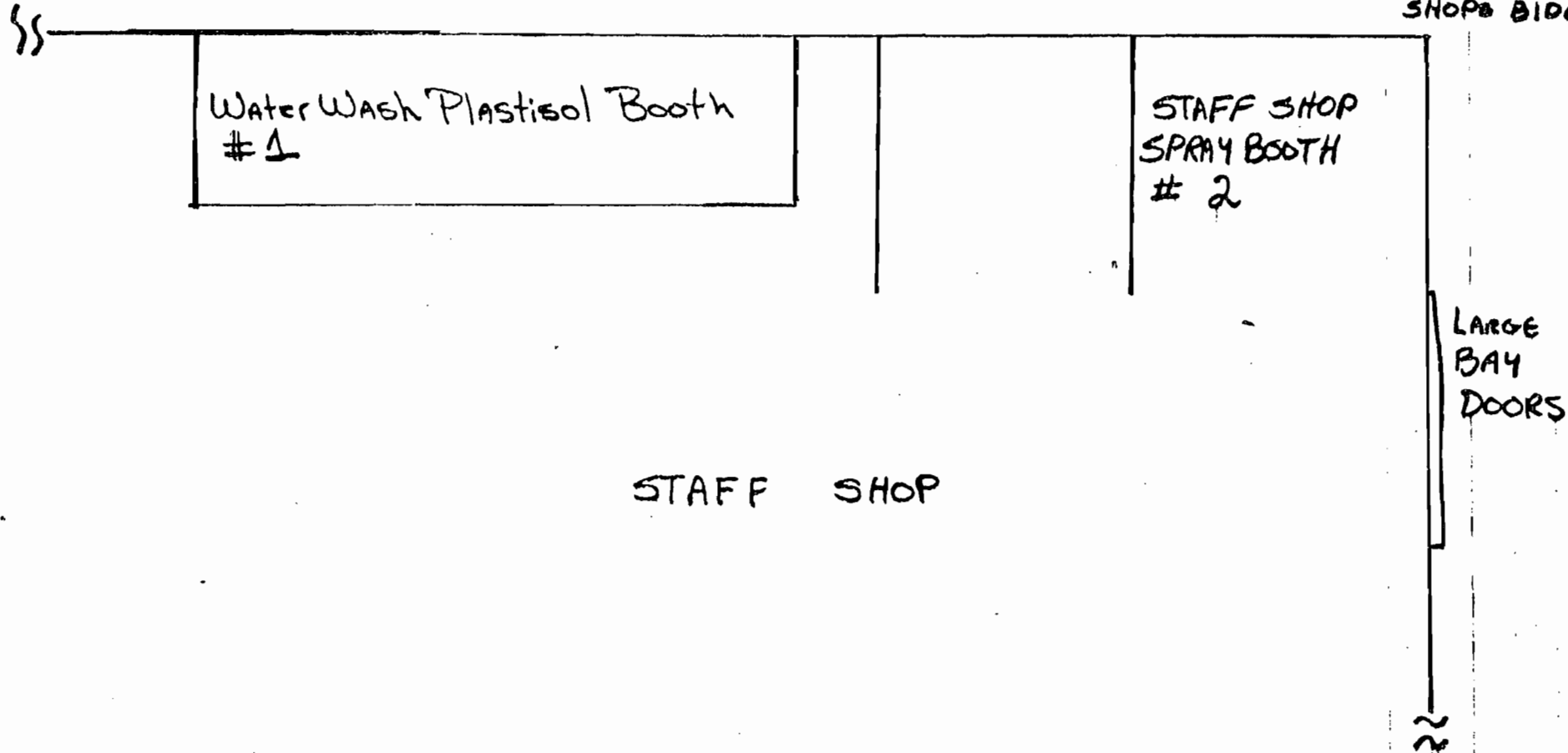

Attachment #2 location of STAFF SHOP SPRAY BOOTH #2

Attachment #3

BEST AVAILABLE COPY

SOURCES OF AIR CONTAMINANTS

1. Central Shops
2. WDW Laundry/Dry Cleaning
3. RCUC Trubines, boilers
4. Waste incinerator, closed.

other sources not shown:
boilers and emergency generators
at EPCOT Central Energy Plant

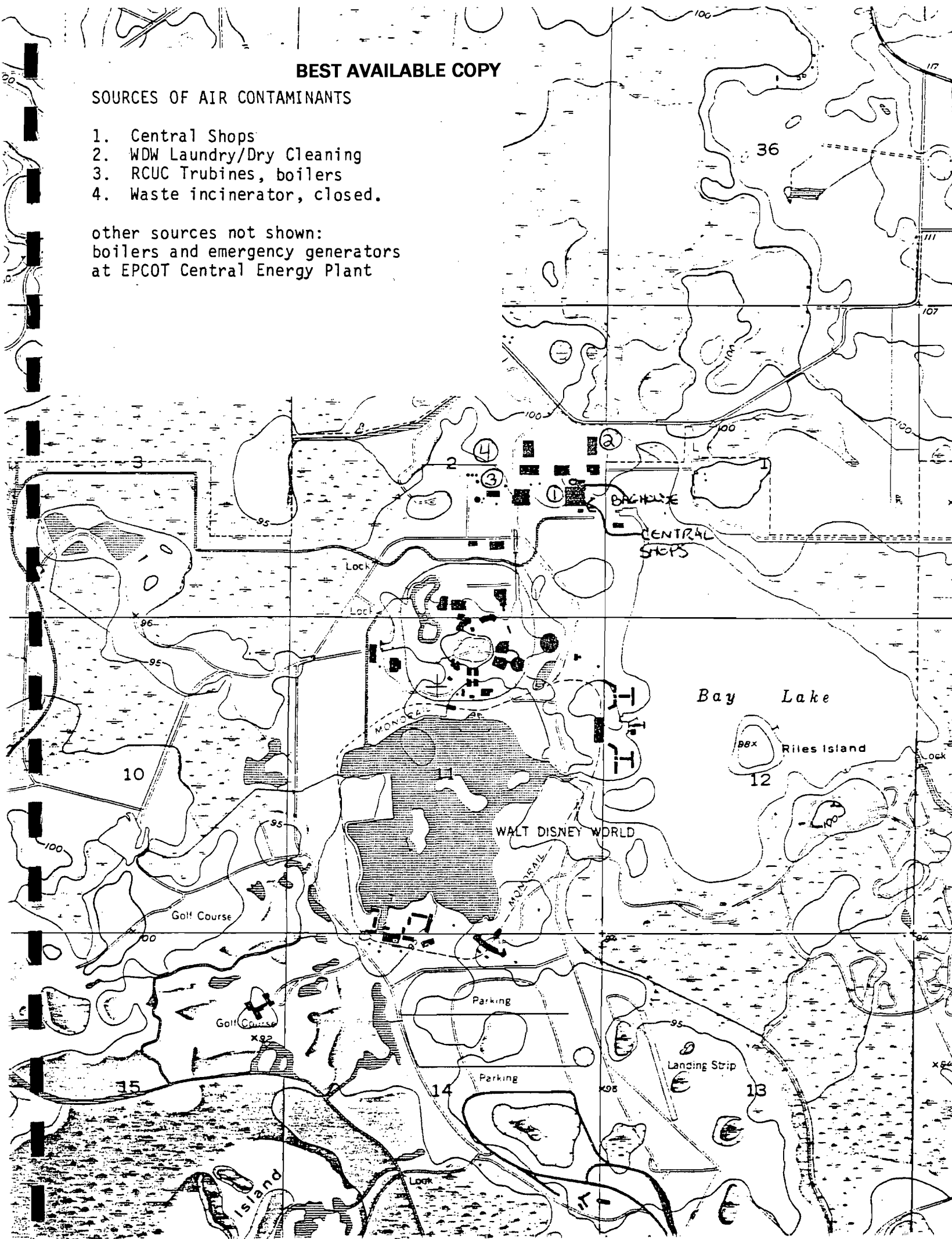

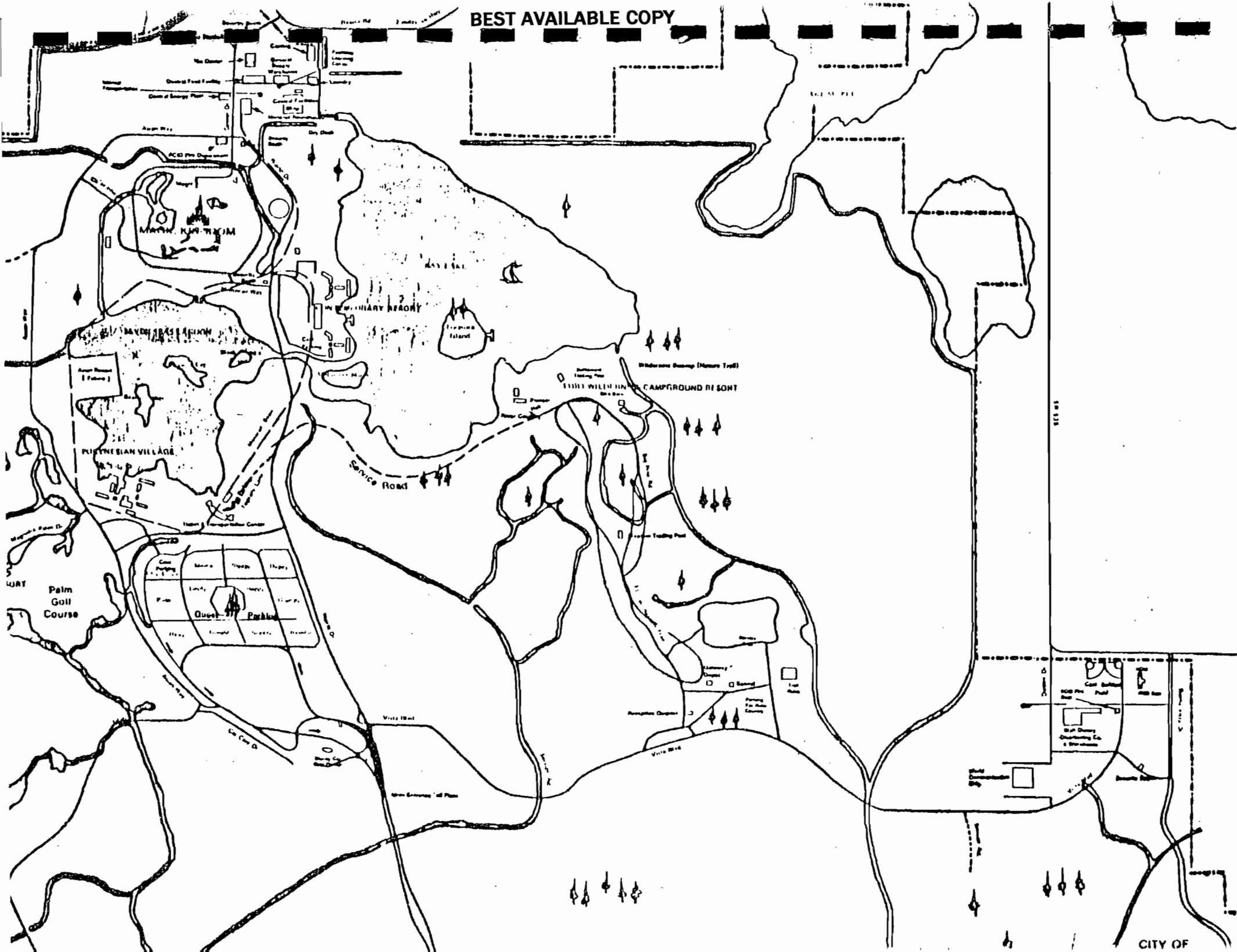

MAYAN KUM TAJUM

PIRYNE SIAN VILLAGE

CAMPGROUND RI SOHT

Palm Golf Course

Service Road

1555 ft

CITY OF

AC 44-104745

AC 48-75838

DEPARTMENT OF ENVIRONMENTAL REGULATION

ST. JOHNS RIVER DISTRICT

3319 MAGUIRE BOULEVARD
SUITE 232
ORLANDO, FLORIDA 32803

PAID
SEP 22 1983

SAINT JOHNS RIVER DISTRICT

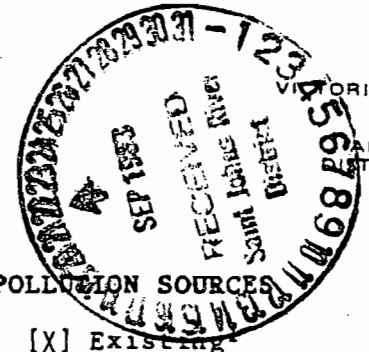
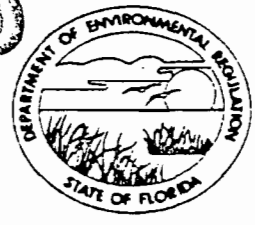

BOB GRAHAM GOVERNOR
ORIA J. TSCHINKEL SECRETARY
ALEX SENKEVICH DISTRICT MANAGER

OCT 6 1983

BAQM

APPLICATION TO OPERATE/CONSTRUCT AIR POLLUTION SOURCES

SOURCE TYPE: Water Wash Spray Booth and Curing [] New¹ [X] Existing

APPLICATION TYPE: [X] Construction [] Operation [] Modification

COMPANY NAME: WALT DISNEY WORLD Co., Inc. COUNTY: Orange

Identify the specific emission point source(s) addressed in this application (i.e. Lime Water Wash plastisol Kiln No. 4 with Venturi Scrubber; Peaking Unit No. 2, Gas Fired) Booth #1

SOURCE LOCATION: Street Facilities Way City Bay Lake

UTM: East 443566 North 3144333

Latitude 28 ° 25 ' 32 "N Longitude 81 ° 34 ' 36 "W

APPLICANT NAME AND TITLE: Edward B. Crowell, V.P. Facilities Division

APPLICANT ADDRESS: P. O. Box 40, Lake Buena Vista, FL 32830

SECTION I: STATEMENTS BY APPLICANT AND ENGINEER

A. APPLICANT

I am the undersigned owner or authorized representative* of WALT DISNEY WORLD Co., Inc

I certify that the statements made in this application for a Construction permit are true, correct and complete to the best of my knowledge and belief. Further, I agree to maintain and operate the pollution control source and pollution control facilities in such a manner as to comply with the provision of Chapter 403, Florida Statutes, and all the rules and regulations of the department and revisions thereof. I also understand that a permit, if granted by the department, will be non-transferable and I will promptly notify the department upon sale or legal transfer of the permitted establishment.

*Attach letter of authorization

Signed: Philip N. Smith

Philip N. Smith, Vice President-Legal
Name and Title (Please Type)

Date: 9/21/83 Telephone No. 828-1735

B. PROFESSIONAL ENGINEER REGISTERED IN FLORIDA (where required by Chapter 471, F.S.)

This is to certify that the engineering features of this pollution control project have been ~~examined~~ examined by me and found to be in conformity with modern engineering principles applicable to the treatment and disposal of pollutants characterized in the permit application. There is reasonable assurance, in my professional judgment, that

¹ See Florida Administrative Code Rule 17-2.100(57) and (104)

The pollution control facilities, when properly maintained and operated, will discharge an effluent that complies with all applicable statutes of the State of Florida and the rules and regulations of the department. It is also agreed that the undersigned will furnish, if authorized by the owner, the applicant a set of instructions for the proper maintenance and operation of the pollution control facilities and, if applicable, pollution sources.

Signed

Ted W. McKin

TED W. MCKIN

Name (Please Type)

Reedy Creek Utilities Co.

Company Name (Please Type)

PO. Box 40 Lake Buena Vista FLA

Mailing Address (Please Type)

Florida Registration No. 25555 Date: 9/21/83 Telephone No. 305-824-4950

SECTION II: GENERAL PROJECT INFORMATION

Describe the nature and extent of the project. Refer to pollution control equipment, and expected improvements in source performance as a result of installation. State whether the project will result in full compliance. Attach additional sheet if necessary.

Installation of Binks Manufacturing water wash spray booth (no pump model) and curing oven to be used for coating various objects with hot melt and vinyl plastisol, objects to be coated are typically fiberglass animated show components, see attachment #1

Schedule of project covered in this application (Construction Permit Application Only)

Start of Construction existing booth Completion of Construction _____

Costs of pollution control system(s): (Note: Show breakdown of estimated costs only for individual components/units of the project serving pollution control purposes. Information on actual costs shall be furnished with the application for operation permit.)

X/A

Indicate any previous DER permits, orders and notices associated with the emission point, including permit issuance and expiration dates. NONE

Permit applications called in by Chuck Collins of Florida DER to be submitted by 16/83.

E. Requested permitted equipment operating time: hrs/day 8; days/wk 5; wks/yr 52;
if power plant, hrs/yr _____; if seasonal, describe: _____

F. If this is a new source or major modification, answer the following questions.
(Yes or No)

1. Is this source in a non-attainment area for a particular pollutant? yes
 - a. If yes, has "offset" been applied? no
 - b. If yes, has "Lowest Achievable Emission Rate" been applied? no
 - c. If yes, list non-attainment pollutants. VOC (ozone)
 2. Does best available control technology (BACT) apply to this source?
If yes, see Section VI. no
 3. Does the State "Prevention of Significant Deterioration" (PSD)
requirement apply to this source? If yes, see Sections VI and VII. no
 4. Do "Standards of Performance for New Stationary Sources" (NSPS)
apply to this source? no
 5. Do "National Emission Standards for Hazardous Air Pollutants"
(NESHAP) apply to this source? no
- H. Do "Reasonably Available Control Technology" (RACT) requirements apply
to this source? no
- a. If yes, for what pollutants? _____
 - b. If yes, in addition to the information required in this form,
any information requested in Rule 17-2.650 must be submitted.

Attach all supportive information related to any answer of "Yes". Attach any justifi-
cation for any answer of "No" that might be considered questionable.

SECTION III: AIR POLLUTION SOURCES & CONTROL DEVICES (Other than Incinerators)

A. Raw Materials and Chemicals Used in your Process, if applicable:

Description	Contaminants		Utilization Rate - lbs/hr	Relate to Flow Diagram
	Type	% Wt		
Hot melts and vinyl plastisols	particulate	100	6.9	
keosene	VOC	100	0.49	

Process Rate, if applicable: (See Section V, Item 1) N/A

- 1. Total Process Input Rate (lbs/hr): _____
- 2. Product Weight (lbs/hr): _____

Airborne Contaminants Emitted: (Information in this table must be submitted for each emission point, use additional sheets as necessary)

Name of Contaminant	Emission ¹		Allowed ² Emission Rate per Rule 17-2	Allowable ³ Emission lbs/hr	Potential ⁴ Emission		Relate to Flow Diagram
	Maximum lbs/hr	Actual T/yr			lbs/yr	T/yr	
VOC	0.49	0.51			1014	0.5	
particulate	0.07	0.07			7280	3.6	

See Section V, Item 2.

Reference applicable emission standards and units (e.g. Rule 17-2.600(5)(b)2. Table II, 17-1) - 0.1 pounds per million BTU heat input)

Calculated from operating rate and applicable standard.

Emission, if source operated without control (See Section V, Item 3).

D. Control Devices: (See Section V, Item 4)

Name and Type (Model & Serial No.)	Contaminant	Efficiency	Range of Particles Size Collected (in microns) (If applicable)	Basis for Efficiency (Section V Item 5)
Binks no pump dynaprecipitator	particulate	98%		mfg. spec.
water wash filter model NPB-14*				

E. Fuels N/A *See attachment #1

Type (Be Specific)	Consumption*		Maximum Heat Input (MMBTU/hr)
	avg/hr	max./hr	

*Units: Natural Gas--MMCF/hr; Fuel Oils--gallons/hr; Coal, wood, refuse, other--lbs/hr.

Fuel Analysis:

Percent Sulfur: _____ Percent Ash: _____

Density: _____ lbs/gal Typical Percent Nitrogen: _____

Heat Capacity: _____ BTU/lb _____ BTU/gal

Other Fuel Contaminants (which may cause air pollution): _____

F. If applicable, indicate the percent of fuel used for space heating.

Annual Average _____ Maximum _____

G. Indicate liquid or solid wastes generated and method of disposal.

Emission Stack Geometry and Flow Characteristics (Provide data for each stack): Spray Booth only
 Stack Height: 35 ft. Stack Diameter: 2.75 ft.
 Gas Flow Rate: ACFM 16,800 DSCFM Gas Exit Temperature: ambient °F.
 Water Vapor Content: ambient % Velocity: 47.2 FPS

SECTION IV: INCINERATOR INFORMATION

Type of Waste	Type 0 (Plastics)	Type I (Rubbish)	Type II (Refuse)	Type III (Garbage)	Type IV (Pathological)	Type V (Liq. & Gas By-prod.)	Type VI (Solid By-prod.)
Actual lbs/hr incinerated							
Uncontrolled lbs/hr							

Description of Waste _____
 Total Weight Incinerated (lbs/hr) _____ Design Capacity (lbs/hr) _____
 Approximate Number of Hours of Operation per day _____ day/wk _____ wks/yr. _____
 Manufacturer _____
 Date Constructed _____ Model No. _____

	Volume (ft) ³	Heat Release (BTU/hr)	Fuel		Temperature (°F)
			Type	BTU/hr	
Primary Chamber					
Secondary Chamber					

Stack Height: _____ ft. Stack Diameter: _____ Stack Temp. _____
 Gas Flow Rate: _____ ACFM _____ DSCFM* Velocity: _____ FPS

For 5 or more tons per day design capacity, submit the emissions rate in grains per standard cubic foot dry gas corrected to 50% excess air.

Other pollution control devices: Cyclone Wet Scrubber Afterburner
 Other (specify) _____

Brief description of operating characteristics of control devices: _____

Ultimate disposal of any effluent other than that emitted from the stack (scrubber water, ash, etc.):

NOTE: Items 2, 3, 4, 6, 7, 8, and 10 in Section V must be included where applicable.

SECTION V: SUPPLEMENTAL REQUIREMENTS

Please provide the following supplements where required for this application.

1. Total process input rate and product weight -- show derivation [Rule 17-2.100(127)]
2. To a construction application, attach basis of emission estimate (e.g., design calculations, design drawings, pertinent manufacturer's test data, etc.) and attach proposed methods (e.g., FR Part 60 Methods 1, 2, 3, 4, 5) to show proof of compliance with applicable standards. To an operation application, attach test results or methods used to show proof of compliance. Information provided when applying for an operation permit from a construction permit shall be indicative of the time at which the test was made.
3. Attach basis of potential discharge (e.g., emission factor, that is, AP42 test).
4. With construction permit application, include design details for all air pollution control systems (e.g., for baghouse include cloth to air ratio; for scrubber include cross-section sketch, design pressure drop, etc.)
5. With construction permit application, attach derivation of control device(s) efficiency. Include test or design data. Items 2, 3 and 5 should be consistent: actual emissions = potential (1-efficiency).
6. An 8 1/2" x 11" flow diagram which will, without revealing trade secrets, identify the individual operations and/or processes. Indicate where raw materials enter, where solid and liquid waste exit, where gaseous emissions and/or airborne particles are evolved and where finished products are obtained.
7. An 8 1/2" x 11" plot plan showing the location of the establishment, and points of airborne emissions, in relation to the surrounding area, residences and other permanent structures and roadways (Example: Copy of relevant portion of USGS topographic map).
8. An 8 1/2" x 11" plot plan of facility showing the location of manufacturing processes and outlets for airborne emissions. Relate all flows to the flow diagram.

The appropriate application fee in accordance with Rule 17-4.05. The check should be made payable to the Department of Environmental Regulation.

With an application for operation permit, attach a Certificate of Completion of Construction indicating that the source was constructed as shown in the construction permit.

SECTION VI: BEST AVAILABLE CONTROL TECHNOLOGY

Are standards of performance for new stationary sources pursuant to 40 C.F.R. Part 60 applicable to the source?

[] Yes [] No

Contaminant

Rate or Concentration

Has EPA declared the best available control technology for this class of sources (If yes, attach copy)

[] Yes [] No

Contaminant

Rate or Concentration

What emission levels do you propose as best available control technology?

Contaminant

Rate or Concentration

Describe the existing control and treatment technology (if any).

1. Control Device/System:

2. Operating Principles:

Efficiency:*

4. Capital Costs:

Explain method of determining

5. Useful Life:

6. Operating Costs:

7. Energy:

8. Maintenance Cost:

9. Emissions:

Contaminant

Rate or Concentration

Contaminant	Rate or Concentration

10. Stack Parameters

- a. Height: ft.
- b. Diameter: ft.
- c. Flow Rate: ACFM
- d. Temperature: °F.
- e. Velocity: FPS

E. Describe the control and treatment technology available (As many types as applicable, use additional pages if necessary).

1.

- a. Control Device:
- b. Operating Principles:
- c. Efficiency:¹
- d. Capital Cost:
- e. Useful Life:
- f. Operating Cost:
- g. Energy:²
- h. Maintenance Cost:
- i. Availability of construction materials and process chemicals:
- j. Applicability to manufacturing processes:
- k. Ability to construct with control device, install in available space, and operate within proposed levels:

2.

- a. Control Device:
- b. Operating Principles:
- c. Efficiency:¹
- d. Capital Cost:
- e. Useful Life:
- f. Operating Cost:
- g. Energy:²
- h. Maintenance Cost:
- i. Availability of construction materials and process chemicals:

¹ Explain method of determining efficiency.

² Energy to be reported in units of electrical power - KWH design rate.

i. Applicability to manufacturing processes:

k. Ability to construct with control device, install in available space, and operate within proposed levels:

a. Control Device:

b. Operating Principles:

Efficiency:¹

d. Capital Cost:

Useful Life:

f. Operating Cost:

Energy:²

h. Maintenance Cost:

Availability of construction materials and process chemicals:

j. Applicability to manufacturing processes:

Ability to construct with control device, install in available space, and operate within proposed levels:

4.

a. Control Device:

b. Operating Principles:

c. Efficiency:¹

d. Capital Costs:

Useful Life:

f. Operating Cost:

g. Energy:²

h. Maintenance Cost:

Availability of construction materials and process chemicals:

i. Applicability to manufacturing processes:

Ability to construct with control device, install in available space, and operate within proposed levels:

Describe the control technology selected:

1. Control Device:

2. Efficiency:¹

3. Capital Cost:

4. Useful Life:

5. Operating Cost:

6. Energy:²

7. Maintenance Cost:

8. Manufacturer:

9. Other locations where employed on similar processes:

(1) Company:

(2) Mailing Address:

(3) City:

(4) State:

Specify in method of determining efficiency.

Energy to be reported in units of electrical power - KWH design rate.

(5) Environmental Manager:

(6) Telephone No.:

(7) Emissions:¹

Contaminant

Rate or Concentration

(8) Process Rate:¹

b. (1) Company:

(2) Mailing Address:

(3) City:

(4) State:

(5) Environmental Manager:

(6) Telephone No.:

(7) Emissions:¹

Contaminant

Rate or Concentration

(8) Process Rate:¹

10. Reason for selection and description of systems:

¹Applicant must provide this information when available. Should this information not be available, applicant must state the reason(s) why.

SECTION VII - PREVENTION OF SIGNIFICANT DETERIORATION

A. Company Monitored Data

1. _____ no. sites _____ TSP _____ () SO₂* _____ Wind spd/dir

Period of Monitoring _____ / _____ / _____ to _____ / _____ / _____
month day year month day year

Other data recorded _____

Attach all data or statistical summaries to this application.

*Specify bubbler (B) or continuous (C).

2. Instrumentation, Field and Laboratory

1. Was instrumentation EPA referenced or its equivalent? [] Yes [] No

2. Was instrumentation calibrated in accordance with Department procedures?
[] Yes [] No [] Unknown

Meteorological Data Used for Air Quality Modeling

1. _____ Year(s) of data from _____ / _____ / _____ to _____ / _____ / _____
month day year month day year

2. Surface data obtained from (location) _____

3. Upper air (mixing height) data obtained from (location) _____

4. Stability wind rose (STAR) data obtained from (location) _____

Computer Models Used

1. _____ Modified? If yes, attach description.

2. _____ Modified? If yes, attach description.

3. _____ Modified? If yes, attach description.

4. _____ Modified? If yes, attach description.

Attach copies of all final model runs showing input data, receptor locations, and principle output tables.

Applicants Maximum Allowable Emission Data

Pollutant	Emission Rate
TSP	_____ grams/sec
SO ₂	_____ grams/sec

Emission Data Used in Modeling

Attach list of emission sources. Emission data required is source name, description of point source (on NEDS point number), UTM coordinates, stack data, allowable emissions, and normal operating time.

Attach all other information supportive to the PSD review.

Discuss the social and economic impact of the selected technology versus other applicable technologies (i.e., jobs, payroll, production, taxes, energy, etc.). Include assessment of the environmental impact of the sources.

Attach scientific, engineering, and technical material, reports, publications, journals, and other competent relevant information describing the theory and application of the requested best available control technology.

Attachment #1

A. Calculation of Utilization Rates:

Vinyl plastisols and hot melts are used at a rate of approximately 30 gallons per week, operation hours and 8 hrs/day, 5 days/wk, 52 wks/yr.

Density of plastisols = 9.17 lbs/gal (based on a specific gravity of 1.1)

$$(30 \text{ gal/wk}) (9.17 \text{ lbs/gal}) = 275.1 \text{ lbs/wk}$$
$$(275.1 \text{ lbs/wk}) \div (40 \text{ hrs/wk}) = 6.9 \text{ lbs/hr.}$$

Kerosene is used as a thinner for these plastisols typically at 10% by volume or 3 gal/wk. density for kerosene 6.51 lbs/gal (based on a specific gravity of 0.780)

$$(3 \text{ gal/wk}) (6.51 \text{ lbs/gal}) = 19.53 \text{ lbs/wk}$$
$$(19.53 \text{ lbs/wk}) \div (40 \text{ hrs/wk}) = 0.49 \text{ lbs/hr.}$$

B. Calculation of Potential and Actual Emissions for Particulate

This coating process involves spraying solvated vinyl plastisol on various fibergalss materials and molds for fabrication of plastic "skins" and other flexible vinyl show components. The booth is equipped with a Binks Manufacturing Company no pump dyna precipitator water wash filtering system. The manufacturer supplied efficiency for this filtering system using vinyl plastisol is 98%.

The overspray rate would be 50% since most objects sprayed are more similar to flat surfaces than to table leg or bird cage surfaces (see AP-40 table 232, page 861)

Therefore, the particulate potential emissions may be calculated as follows:

(Utilization rate) (portion of overspray) = potential particulate emissions.

$$(6.9 \text{ lbs/hr}) (0.50 \text{ overspray}) = 3.5 \text{ lbs/hr potential emissions}$$
$$(3.5 \text{ lbs/hr}) (8 \text{ hrs/day}) (5 \text{ days/wk}) (52 \text{ wks/yr}) = 7280 \text{ lbs/yr}$$
$$= 3.64 \text{ T/yr.}$$

The actual emissions take into account the 98% efficiency for the no pump water wash booth when vinyl plastisols are being sprayed (manufacturers spec.). The calculation proceeds as follows:

$$(\text{potential emission rate}) (1 - \text{filtering efficiency}) = \text{actual emissions}$$
$$(7280 \text{ lbs/yr}) (0.02) = 145.6 \text{ lbs/yr}$$
$$= 0.07 \text{ T/yr}$$

C. Calculation of Potential and Actual Emissions for VOC

(Emission rate for VOC) = (utilization rate for kerosene)
since the vinyl plastisol contains essentially no VOC.

(19.5 lbs/wk) = potential VOC emissions
= 1014 lbs/yr = 0.51 T/yr.

This total for potential emissions is divided between the emissions from the spray booth (flash off) and the emissions from the associated oven when heat curing occurs.

Flash off times are minimal, since the coated objects are rolled into the oven immediately after coating is completed. AP-40 page 862, figure 655 shows that with an estimated flash-off time of one minute, vinyl plastisols will lose approximately 71% of their solvent content. Therefore, the VOC emissions may be divided as follows:

71% from spray booth = 720 lbs/yr = 0.36 T/yr
29% from curing oven = 294 lbs/yr = 0.15 T/yr

Attachment #2

BEST AVAILABLE COPY

Air Out

3000 CFM*

Dimensions: 1ft x 1.33ft

Rate 37.6 FPS

* @ 2.5 in W.C. Static Pressure

Preheated
Air IN

OBJECT BEING
CURED

Flow Diagram for Curing Oven (OVEN ONLY)

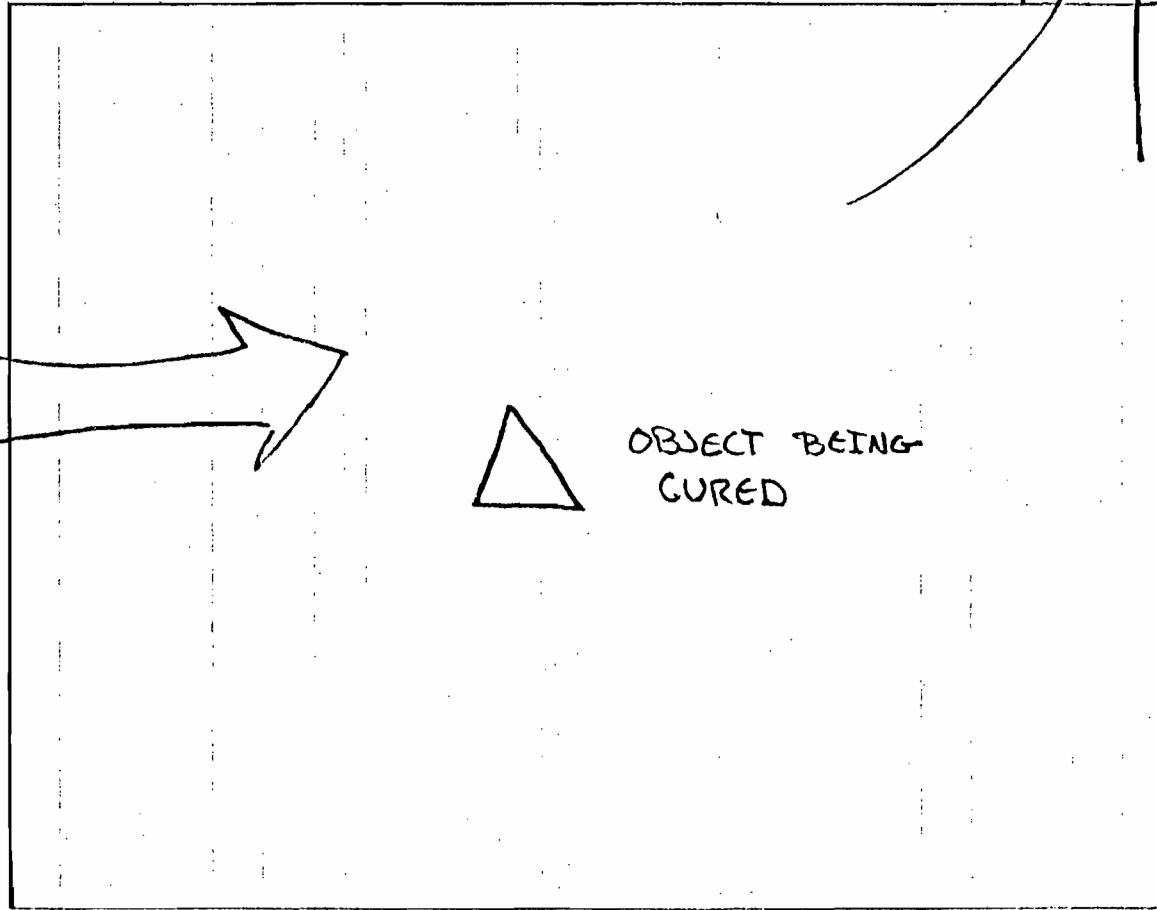

BEST AVAILABLE COPY

AIR OUT

16,800 CFM*
DIAMETER 2.75ft
RATE 47.2 FPS

*@4.2" W.C. Static Pressure

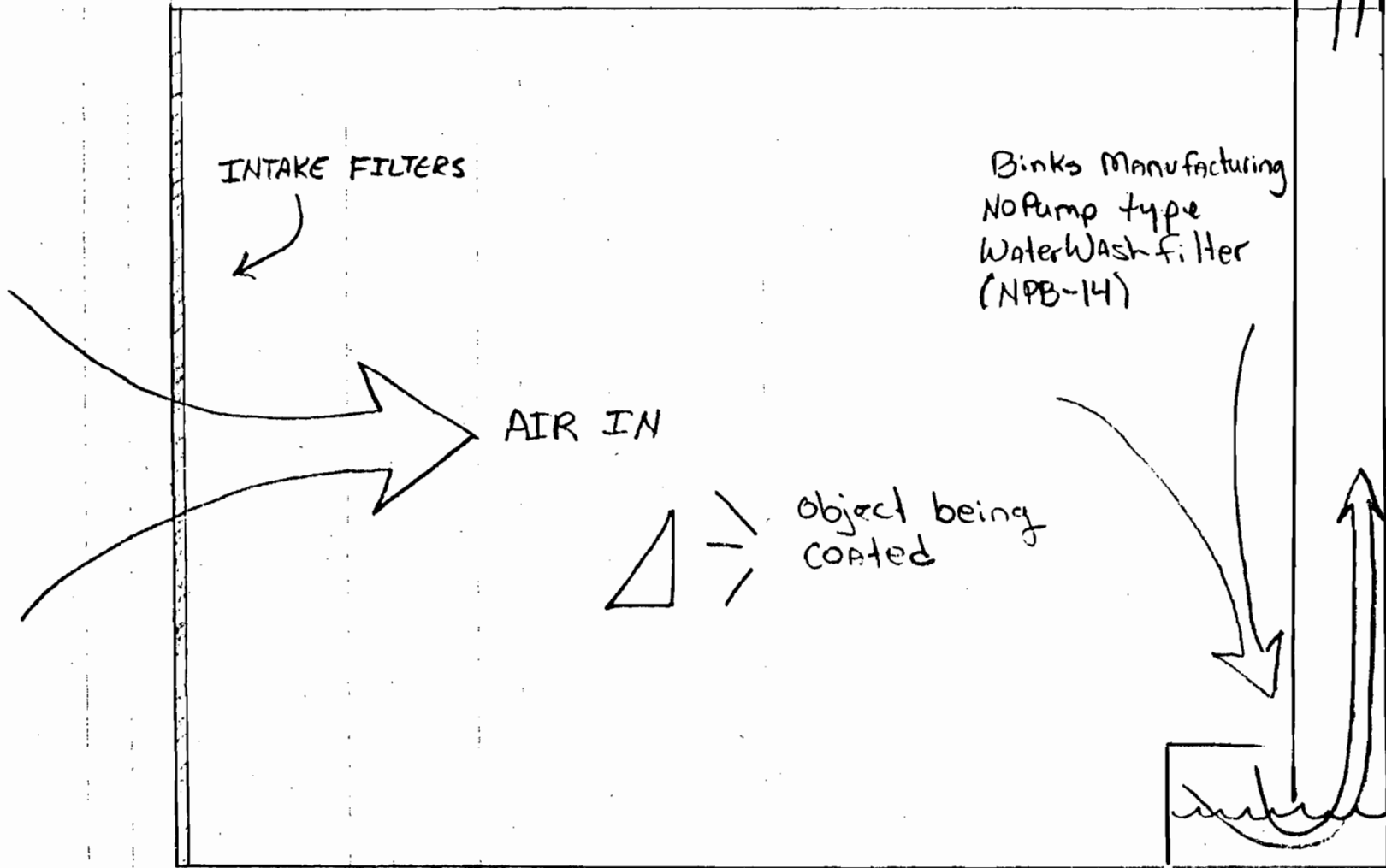

Flow Diagram for Vinyl Plastisol Booth (SPRAY BOOTH ONLY)

NOPUMP SPRAY BOOTH (floor type)

Without benefit of pump or water-spraying manifold, Binks NOPUMP SPRAY BOOTH uses the highly effective scrubbing action of a water wash to separate paint particles from exhaust air. By ingenious channeling of the paint laden exhaust air through a "water tunnel" the NOPUMP system eliminates pumps, piping, filters, manifolds, and nozzles.

This engineering break-through gives you a highly efficient water-wash spray booth in which operating maintenance is virtually eliminated.

How it works

Paint laden air is drawn into the washing chamber at high velocity through an opening between entrainment plate and water surface (see illustration). The controlled dimension of this opening, and the specially designed profile of the entrainment plate, force the high velocity air to become severely turbulent, to splash up water, and to become intimately mixed with it.

This rapidly moving mixture of air, paint particles, and water droplets next impinges on the distribution plate which forces it to change direction abruptly and to flow upward through a torturous, labyrinth of baffles.

The "mixture" flow changes direction 11 times during its passage through the baffle section. At each change, centrifugal force separates air from paint particles and from water droplets. The resulting rain of water, particularly from the lower baffles, serves additionally as a water curtain for scrubbing the incoming spray laden air. And all of the paint spray that is separated from the air falls back into the water tank.

Water Treatment

The water in the tank is treated with Binks Compound, a specially formulated, low-foaming, alkaline-base powder. This additive causes the particles of paint to sink to the bottom of the tank where they agglomerate as a soft, loamy, residue. Residue buildup may approach to within 2 inches of the water surface without adversely affecting the "nopump" action in the water tunnel. Residue removal is very infrequent; even in high production painting.

Precise water level control

The gap between water surface and entrainment plate is kept within $\pm 1\%$ of its optimum dimension. This is accomplished with Binks Water Level Control Unit. This unit is located external to the booth proper—isolated from contaminating water and spray. Yet, it is directly connected, hydraulically, to the water tank and senses water level changes immediately and accurately. Its external location gives it maximum accessibility for inspection and calibration.

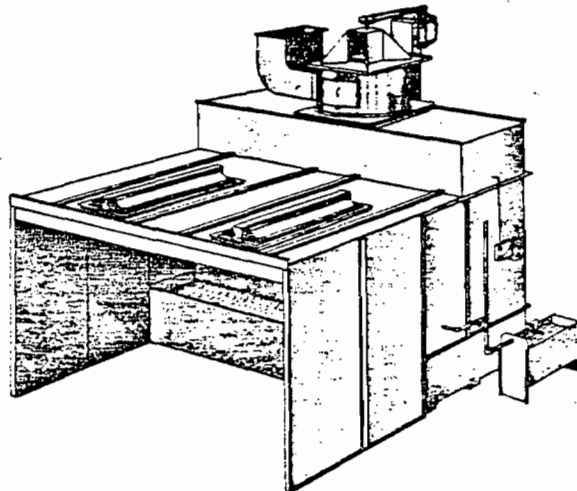

NOPUMP SPRAY BOOTH CROSS SECTION

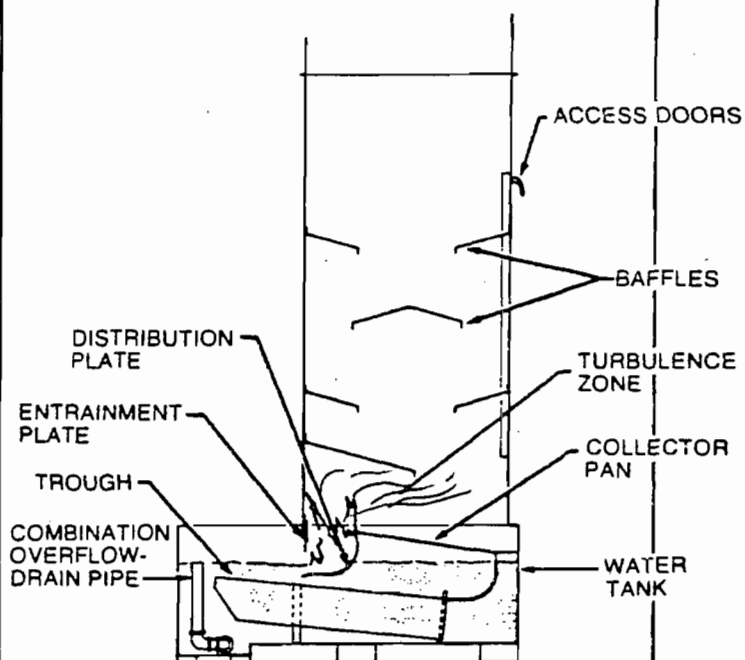

Attachment #3

BEST AVAILABLE COPY

SOURCES OF AIR CONTAMINANTS

1. Central Shops
2. WDW Laundry/Dry Cleaning
3. RCUC Trubines, boilers
4. Waste incinerator, closed.

other sources not shown:
boilers and emergency generators
at EPCOT Central Energy Plant

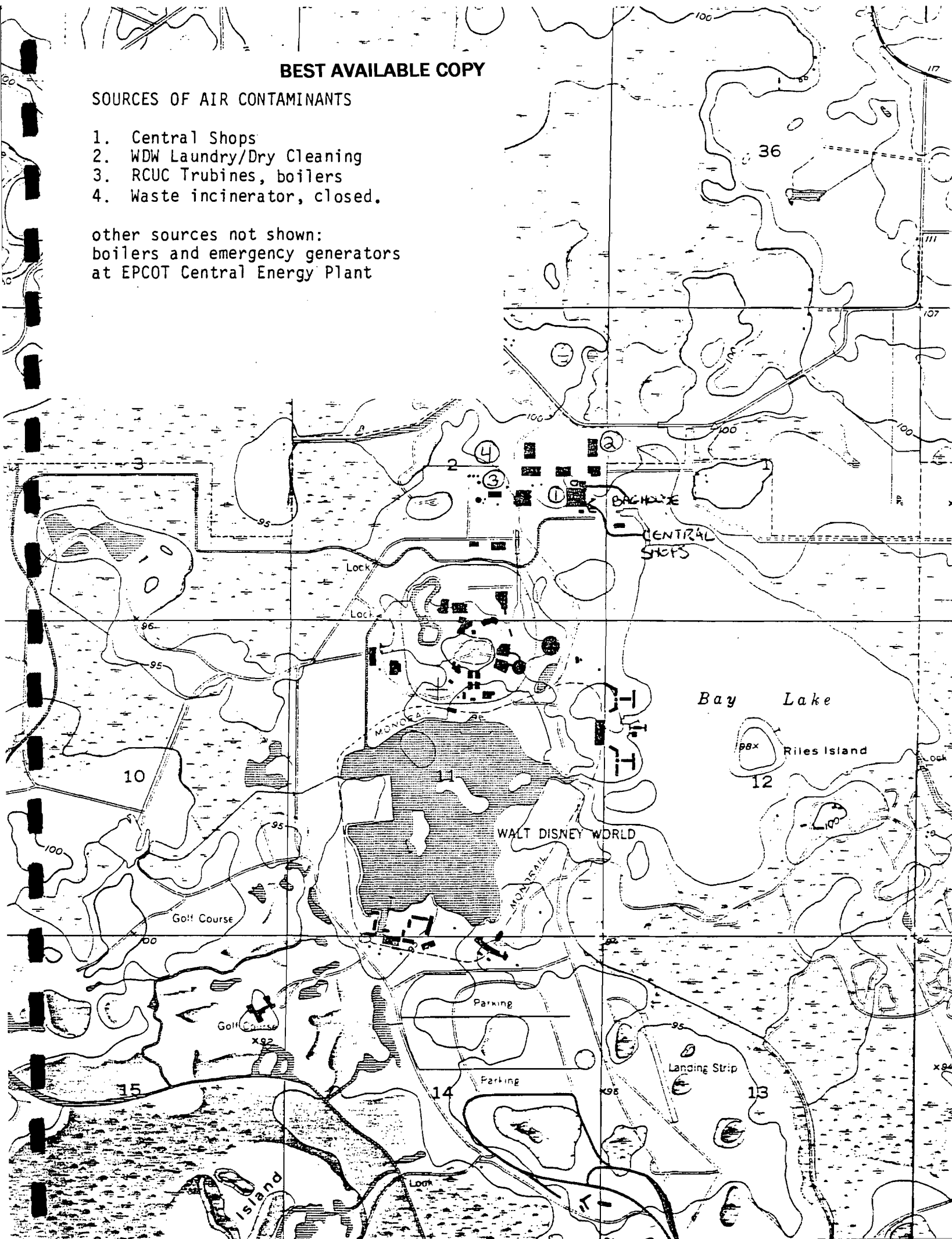

BEST AVAILABLE COPY

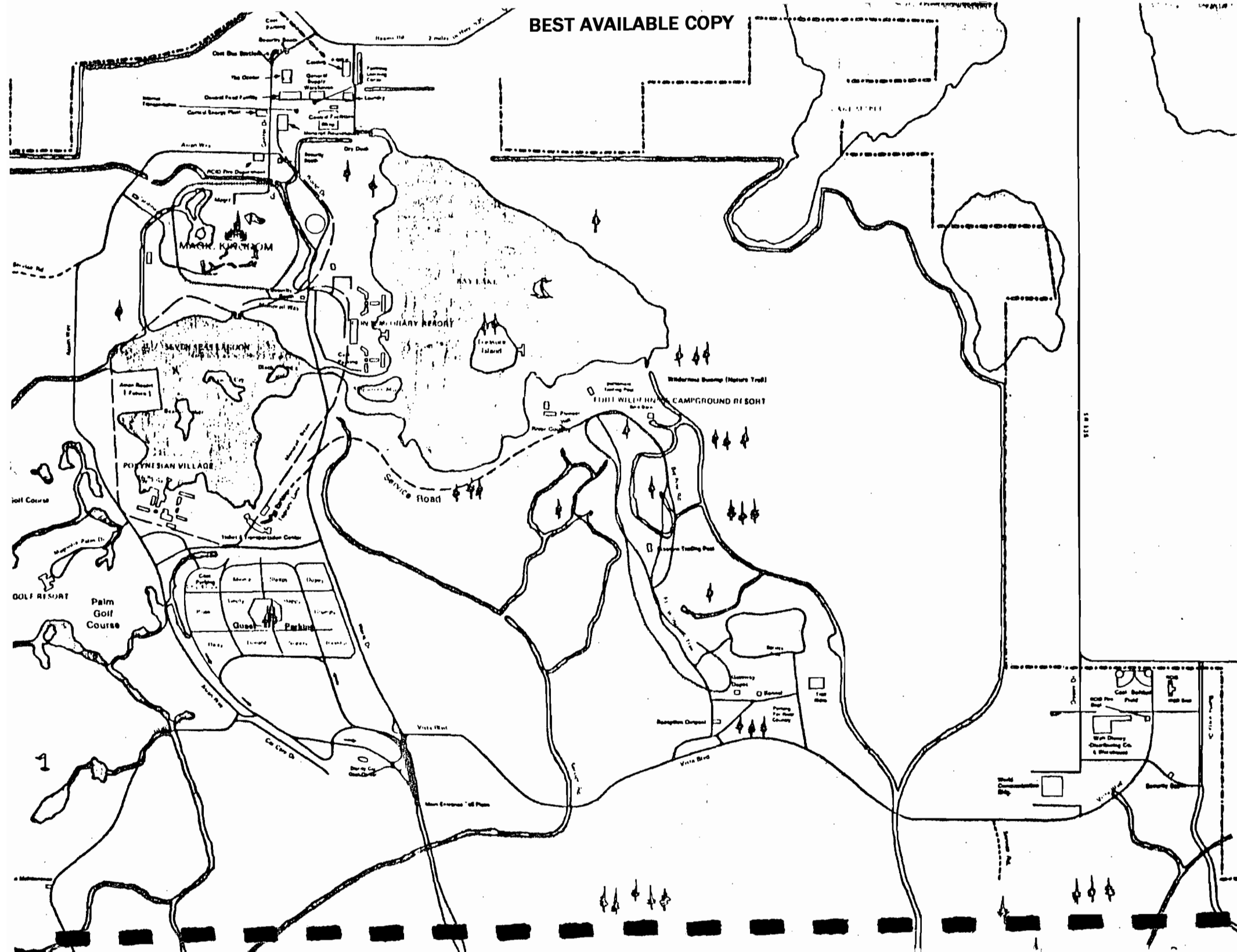

Shops
1 to other of 1

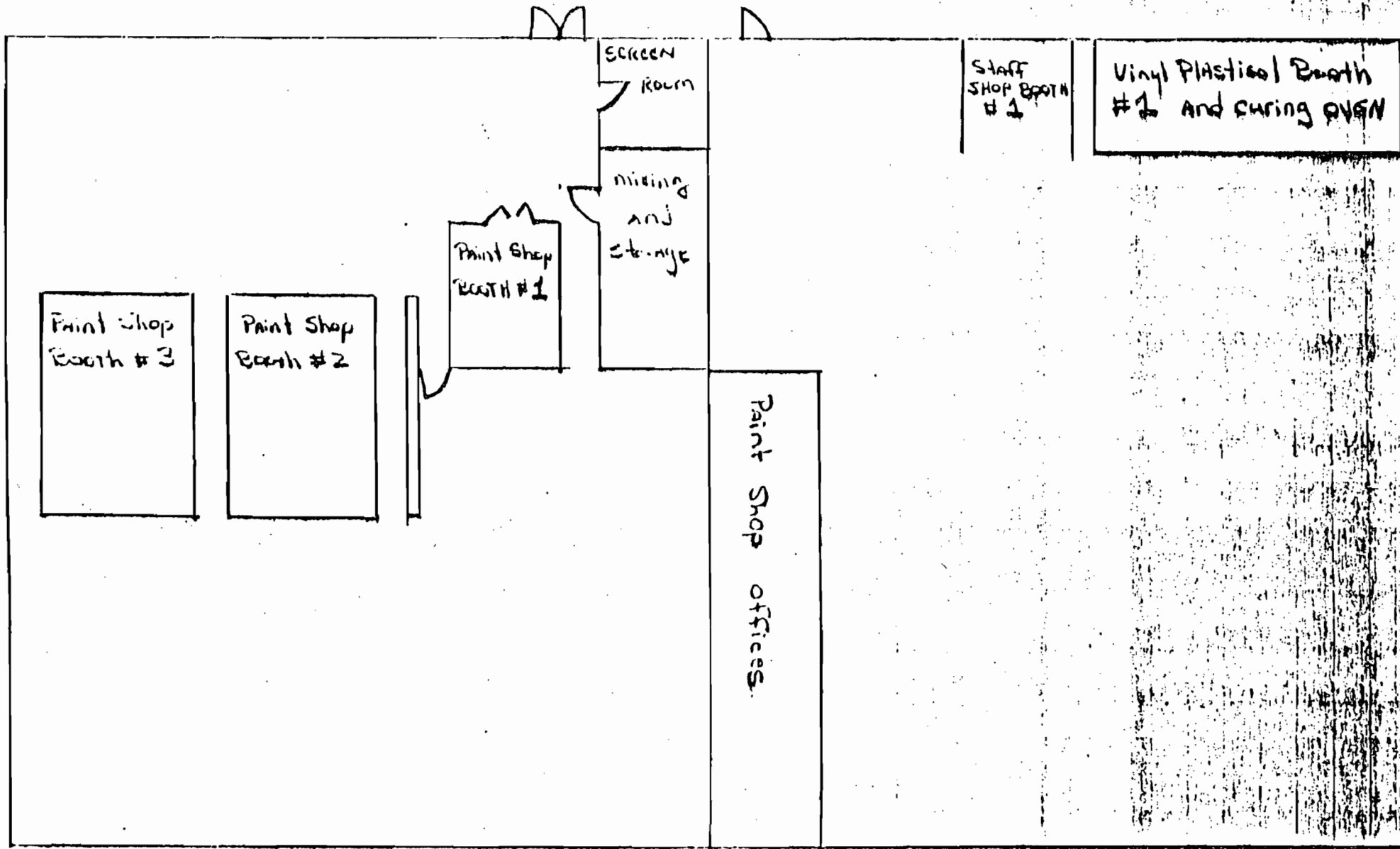

SKETCH OF Facility Layout, not to scale



December 6, 1983

DER
DEC 12 1983
BAQM

Mr. C. H. Fancy, P.E., Deputy Chief
Bureau of Air Quality Management
FLORIDA DEPARTMENT OF ENVIRONMENTAL
REGULATION
Twin Towers Office Building
2600 Blair Stone Road
Tallahassee, Florida 32301

re: Construction Applications
AC 48-75833, AC 48-75834,
AC 48-75835 and AC 48-75838

Dear Mr. Fancy:

In response to your letter of October 17, 1983, we have prepared the following point by point responses to your requests for additional information concerning the above referenced air pollution sources:

1.	<u>Booth</u>	<u>Approximate Construction Date</u>	<u>Approximate Date of Operation</u>
	Paint Shop #1	10/81	12/81
	Paint Shop #2	10/81	12/81
	Paint Shop #3	10/81	12/81
	Staff Shop #1	1970	
	Vinyl Plastisol/ Curing Oven #1	1/83	2/83

2. We are not at this time able to provide the information for a Lowest Achievable Emission Rate (LAER) determination. We do, however, recognize the necessity of providing either process modifications or add on controls to limit VOC emissions from these Paint Spray Booths and are in the process of finding and retaining a suitable consultant to specify the proper emission reduction procedures.

The emission reduction schemes under consideration include:

- a. Substitution of low solvent or waterborne coatings
- b. Installation of thermal combustion equipment
- c. Installation of carbon absorber system
- d. Use of exhaust for make-up air in existing boilers

WALT DISNEY WORLD CO.

P.O. BOX 40 · LAKE BUENA VISTA, FLORIDA 32830

We will provide details of control choice and installation scheduling as soon as they are available to us. We are committed to providing whatever is necessary to bring these sources into compliance and to meet any LAER requirements at the earliest possible opportunity.

Since the three booths at the Paint Shop (AC 48-75833, AC 48-75834, AC 48-75835) account for 99 percent of the total VOC emission from these six sources, we propose to install controls or procedure modifications on these three booths only, subject, of course, to department approval.

3. Six copies of the letter of authorization are enclosed.

The information requests specific to individual permits, which are provided point by point as follows:

- A. The \$150 additional permitting fee is included as part of the \$300 check which is enclosed.
- B.
 1. The \$150 additional permitting fee is included as part of the \$300 check which is enclosed.
 2. The stack diameter, as indicated in attachment #1 (I) to the application, is 3.5 feet.
 3. Three copies of the facility layout sketch are enclosed.
 4. The proper flow rate for each of two exhaust fans is 24,250 SCFM at 1/4" WC static pressure.
- C.
 1. Three copies of the plot plan are enclosed.
 2. The calculation of gas flows and velocities proceeds as follows:

The flow rate based on manufacturer's specifications is 24,800 SCFM at 1/4" WC static pressure. The stack diameter is 3.5 feet.

The cross sectional area of the stack is expressed as πR^2 where the radius is 1.75 feet, $(3.14)(1.75)^2 = 9.62$ square feet.

$$(24,800 \text{ SCFM}) \div (9.62 \text{ sq. ft.}) = 2,578 \text{ FPM}$$
$$(2,578 \text{ FPM}) \div (60 \text{ sec/min}) = 42.97 \text{ FPS}$$

- D. 1. Three copies of the plot plan are enclosed.
2. The calculation of gas flow rate and velocity proceeds as follows:

The flow rate based on manufacturer's specifications is 29,000 CFM at 2" WC static pressure. The stack dimensions are 5 ft. x 3.4 ft. or 17 square feet.

$$(29,000 \text{ SCFM}) \div (17 \text{ sq ft}) = 1,706 \text{ FPM}$$
$$(1,706 \text{ FPM}) \div (60 \text{ sec/min}) = 28.4 \text{ FPS}$$

- E. 1. Three copies of the plot plan are enclosed.
2. The calculations of gas flow rates and velocities proceed as follows:

For the spray booth:

The gas flow rate based on manufacturer's specifications is 16,800 SCFM at 4.2" WC static pressure. The stack diameter is 2.75 ft. (radius = 1.375)
The cross sectional area = $\pi R^2 = (3.14)(1.375)^2$
= 5.94 sq ft

$$(16,800 \text{ SCFM}) \div (5.94 \text{ sq ft}) = 2,828 \text{ FPM}$$
$$(2,828 \text{ FPM}) \div (60 \text{ sec/min}) = 47.1 \text{ FPS}$$

For the curing oven, the gas flow rates and velocities should be corrected as follows:

Manufacturer's specifications flow rate = 3,000 DSCFM

Volume at std conditions = QSTD

$$QSTD = QE \times \frac{530}{TE} \times \frac{PE}{29.92}$$

In one minute 3,000 SCF of air is discharged.

QE = Volume at gas exit conditions

TE = Temperature at gas exit conditions = 350°F

PE = Average atmospheric pressure = 29.94 in Hg

$$3,000 \text{ SCF} = QE \times \frac{530}{810} \times \frac{29.94}{29.92} = 3,000 \text{ SCF} = QE \times 0.65$$
$$\times 1.001$$

$$QE = 4611 \text{ CF}$$

Therefore in one minute at exit gas conditions 4,611 CF of air is discharged or a flow of 4,611 CFM is present.

Construction Applications
December 6, 1983
Page Four

The stack dimensions are 1 ft x 1.3 ft or 1.3 sq ft.
Therefore the exit gas velocity may be calculated as
follows:

$4611 \text{ CFM} \div 1.3 \text{ sq ft} = 3547 \text{ FPM}$
 $3547 \text{ FPM} \div 60 \text{ sec/min} = 59.11 \text{ FPS}$ at exit gas
conditions.

3. Exit gas temperature is 350°F.
4. The curing oven is heated using natural gas.

If you need any additional information , please contact
Ted McKim at (305) 824-4950.

Sincerely,

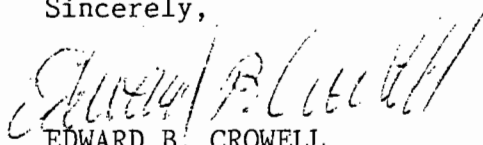

EDWARD B. CROWELL
Vice President
Facilities Division

EBC:CSK:lp

Enclosures



May 01, 1984

Mr. E.H. Fancy, P.E.
Department Chief
BUREAU OF AIR QUALITY MANAGEMENT
STATE OF FLORIDA
Twin Tower Boulevard
2600 Blair Stone Road
Tallahassee, FL 32301-8241

RE: Construction Applications
AC487T833, AC48-75834,
AC48-75835, AC48-75836
AC48-75837 & AC48-75838

Dear Mr. Fancy:

In response to your letter of 1/3/84, in reference to construction applications AC48-75833, 75834, 75835, 75836, 75837, and 75838, we have prepared the following points of additional information and modifications to be included in the permit applications.

INFORMATION REQUIRED FOR COMPLETION OF PERMIT APPLICATIONS:

1. The Staff Shop Spray Booth #2 was originally constructed in December 1974 and initially used in January 1975.

Staff Shop Spray Booth #1 was initially used sometime in the middle part of CY 1970, no precise records exist to fix the date precisely.

2. ATTACHMENT #1 to this letter contains revised emission estimates for the three Paint Shop Spray Booths. Originally submitted paint and solvent usage figures were grossly over estimated and revised figures are based on actual stock withdrawal over a 12 month period from November 1982 to November 1983. This attachment also contains an estimate of VOC emissions resulting from non-booth related painting activities. Procedures implemented to reduce non-spray booth VOC emissions are as follows:
 1. Paint upper stories of buildings with water base latex paints where practical.
 2. Disciplinary actions to encourage recovery of all solvents and unused paints for disposal through the hazardous waste program.
 3. Institute record keeping system to keep track of coatings and solvents used in each booth to verify utilization rates and emission estimates.
 4. Limiting evaporation losses of cleaning solvents and wastes by requiring that waste drums be tightly sealed when not in use and that spent cleaning

WALT DISNEY WORLD CO.

P.O. BOX 40 · LAKE BUENA VISTA, FLORIDA 32830

COPYRIGHT WALT DISNEY PRODUCTIONS

solvents be transferred to waste drums as soon as possible.

5. Audit the integrity of underground storage tanks to rule out solvent loss through leakage into groundwater.
6. Specify low solvent or waterborne coatings for jobs where applicable.

(2. cont.) With these procedure modifications we submit that emission rates tabulated in attachment #1 represent lowest achievable emission rate for the pollutants indicated.

3. ATTACHMENT #2 contains three signed and sealed pages 2 of 12 for permit application AC48-75837, NSA Staff Shop booth 32.
4. Calculation of emissions resultant from the natural gas combustion in the drying oven associated with water wash plastisol booth #1 appears below:

Despatch oven company model PS-4-20 oven rated at 1.5 Mbtu/hr heat input.

Since natural gas contains approximately 1025 btu/SCF, at maximum heat input the oven will burn 1463 SCF nat gas/hr

Using 16 hrs/day, 5 days/wk, 52 wks/yr
operating schedule = 4160 hrs/yr

or

6.09×10^6 SCF nat gas/yr
at maximum conditions

Using AP-42 emission factors for natural gas combustion for domestic and commercial boilers (10Mbtu/hr heat input) yields the following emission rates:

<u>POLLUTANT</u>	<u>ED-42 EMISSION FACTOR (lbs/10 ft)</u>	<u>EMISSION ESTIMATE (lbs/yr)</u>	<u>(T/yr)</u>
Particulate	3	18.27	0.09
Sulfur Dioxide	0.6	3.7	0.02
Nitrogen Oxides	100	609	0.30
Carbon Monoxide	20	122	0.06
Non-Methane VOC	5.3	32.2	0.02
Methane VOC	2.7	16.4	0.008

The following information and documentation was omitted from our letter of Dec. 6, 1983 due to an error on our part:

- A. Six copies of the letter of authorization are included as Attachment #2.
- B. A sketch of the facility layout showing the location of NSA Paint Shop booth #3 and the other booths at the Central Shops facility is included as ATTACHMENT #4.
- C, D, & E. Sketches of facility layout and emission outlets as well as location of other sources on property are included at ATTACHMENT #5 for Staff Shop booth #1, Staff Shop booth #2 and Waterwash Plastisol booth #1.

If you need any additional information please contact Fred Harden @ (305) 828-1883.

Sincerely,



Edward B. Crowell
Vice-President
Facilities Division

EBC:dlh

cc: Chuck Collins FDER
Fred Harden, RCID
Bill Mack, WDW
Tom Moses, RCID

ATTACHMENT 1

Revisions to Paint Shop Spray Booth Emission Estimates

Paint Shop Spray Booth #1, AC48 - 75833

Paint Shop Spray Booth #2, AC48 - 75834

Paint Shop Spray Booth #3, AC48 - 75835

The values for estimated emissions for the three spray booths at the Paint Shop were derived using the following assumptions and calculations:

Total yearly operating hours at 4160 hrs based on 16 hrs/day, 5 days/wk, 52 wks/yr.

Total paint and solvent usage derived from stock withdrawal records.

Total paint and solvent usage in spray booth activities at the paint shop calculated using approximate percentage of total figures used in booths, as provided by Paint Shop personnel.

Total usage in each particular booth was derived from composite figures, for total booth usage by assigning individual usage proportionally to available floor space.

Paint Shop Booth #1	320 sq. ft., 1/5 of total floorspace
Paint Shop Booth #2	640 sq. ft., 2/5 of total floorspace
Paint Shop Booth #3	640 sq. ft., 2/5 of total floorspace

$$\begin{array}{r} \text{Total Stock} \\ \text{Withdrawal} \end{array} \times \begin{array}{r} \text{Estimated Fraction Used} \\ \text{In all three booths, total} \end{array} \times \begin{array}{r} \text{Fraction Total} \\ \text{Floorspace} \end{array} = \begin{array}{r} \text{Usage in} \\ \text{Individual booth} \end{array}$$

Solvent densities and paint densities were derived from manufacturer's data, standard physical tables, and in cases where specific data was unavailable, estimates were used.

Utilization rates were calculated using usages in individual booths and dividing by 4160 hrs/yr (see above).

Potential emissions were calculated without consideration of any emission controls present. For VOC, actual and potential emissions are the same since no VOC controls are in use on these spray booths.

Actual emissions for particulates were calculated as shown in ATTACHMENT I-F of the original permit submittals using composite overspray rates and an efficiency of 95% for the Binks Paint Arrestor type exhaust filters as quoted by the manufacturer.

Table 1	Usage Rates for Solvents
Table 2	Usage Rates and VOC Components for Coating Systems
Table 3	Potential Particulate Emissions and Utilization Rates for Coating Systems
Table 4	Actual Particulate Emissions and VOC Components for Coating
Table 5	Utilization Rates for Solvents
Table 6	Total Potential and Actual Emissions for VOC and Particulate
Table 7	Maximum Emissions for VOC and Particulate
Table 8	Contaminants Types and Weight Percents
Table 9	Estimate of VOC Emissions from Non-Spray Booth Activities

TABLE 1
SOLVENT USAGE

<u>Solvent Name or Destination</u>	<u>Approximate Density (lbs/gal)</u>	<u>Total Yearly Withdrawals</u>	<u>Approximate Usage In Paint Shop Booths</u>	<u>Approximate Usage In Booth #1</u>	<u>Approximate Usage In Booth #2</u>	<u>Approximate Usage In Booth #3</u>
PNT - 88	7.3	243 gal	243 gal	48.6 gal 354.8 lbs	97.2 gal 709.6 lbs	97.2 gal 709.6 lbs
Acrythane Spray	7.33	914 gal	549 gal	109.8 gal 804.8 lbs	219.6 gal 1609.6 lbs	219.6 gal 1609.6 lbs
Acrythane Brush	---	360 gal	0	----	----	----
Acrylic Enamel #601	7.3	618 gal	495 gal	99 gal 727.7 lbs	198 gal 1455.4 lbs	198 gal 1455.4 lbs
Acrylic Enamel #602	6.94	940 gal	752 gal	150.4 gal 1043.8 lbs	300.8 gal 2087.6 lbs	300.8 gal 2087.6 lbs
Acrylic Enamel #607	7.3	22 gal	22 gal	4.4 gal 32.1 lbs	8.8 gal 64.2 lbs	8.8 gal 64.2 lbs
Methanol	6.6	694 gal	243 gal	48.6 gal 320.8 lbs	97.2 gal 641.6 lbs	97.2 gal 641.6 lbs
Z - SPAR #8	---	4 gal	0	----	----	----
Z - SPAR #T - 283	6.98	193 gal	97 gal	19.4 gal 135.4 lbs	38.8 gal 270.8 lbs	38.8 gal 270.8 lbs
Lacquer #105	7.2	1,468 gal	441 gal	88.2 gal 635 lbs	176.4 gal 1270 lbs	176.4 gal 1270 lbs
Rustoleum Reducer	---	31 gal	0	----	----	----
Amerflint Reducer	7.3	374 gal	187 gal	37.4 gal 273 lbs	74.8 gal 546 lbs	74.8 gal 546 lbs

BEST AVAILABLE COPY

TABLE 1
SOLVENT USAGE

<u>Solvent Name or Destination</u>	<u>Approximate Density (lbs/gal)</u>	<u>Total Yearly Withdrawals</u>	<u>Approximate Usage In Paint Shop Booths</u>	<u>Approximate Usage In Booth #1</u>	<u>Approximate Usage In Booth #2</u>	<u>Approximate Usage In Booth #3</u>
Amerthane ST - 535	----	16 gal		----	----	----
Lacquer Thinner	6.0	15,200 gal	152 gal	30.4 gal 182.4 lbs	60.8 gal 364.8 lbs	60.8 gal 364.8 lbs
Acetone	6.59	6,000 gal	50 gal	10 gal 65.9 lbs	20 gal 131.8 lbs	20 gal 131.8 lbs
Methylethyl Ketone	----	36 gal	0	----	----	----
MHK	----	35 gal	0	----	----	----
Mineral Spirits	----	1,250 gal	0	----	----	----
Butyl/Cele/Ace	----	10 gal	0	----	----	----
Precleano	7.3	1,100 gal	50 gal	10 gal 73 lbs	20 gal 146 lbs	20 gal 146 lbs
Trichloroethylene	----	----	----	----	----	----
Methylene-Chloride	11.0	715 gal	30 gal	6 gal 66 lbs	12 gal 132 lbs	12 gal 132 lbs
Lacquer Reducer	6.0	5 gal		1 gal 6 lbs	2 gal 12 lbs	1 gal 12 lbs
Hexa-Methylene	7.3		5 gal	1 gal 7.3 lbs	2 gal 14.6 lbs	2 gal 14.6 lbs
Gil. Ure/Lac	7.3	144 gal	40 gal	8 gal 58.4 lbs	16 gal 116.8 lbs	16 gal 116.8 lbs
TOTALS		30,372 gal	3361 gal	672.2 gal 4786.4 lbs	1344.4 gal 9572.8 lbs	1344.4 gal 9572.8 lbs

BEST AVAILABLE COPY
TABLE 2

PAINT USAGE

Type of Coating System	Approximate Coating Density (lbs/gal)	Approximate Total Usage In Paint Shop Booths	Approximate WT % VOC In Coating	Total Particulate Loads For Booths	Potential VOC Emissions For Booths	Approximate Usage In Non-Booth Painting
2-Part Acrylic Polyurethane	9.2	6,410 gal/yr	0	58,972 lbs/yr	0	15,292 gal/y
2-Part Epoxy Primer	10.5	218 gal/yr	0	2,289 lbs/yr	0	810 gal/y
Conventional Primers	9.4	561 gal/yr	44 %	2,953 lbs/yr	2,320 lbs/yr	661 gal/y
Lacquers	7.9	232 gal/yr	69 %	568 lbs/yr	1,265 lbs/yr	622 gal/y
Latex	8.0	50 gal/yr	0	280 lbs/yr*	0 Waterbase	575 gal/y
Low Solvent Shellac	app. 7.5	200 gal/yr	20.5%	1,192.5	307.5 lbs/yr	1,164 gal/y
Alkyd oil base	8.0	50 gal/yr	49 %	204 lbs/yr	196 lbs/yr	1,443 gal/y
Miscellaneous Other Coatings	9.0	60 gal/yr	40 %**	324 lbs/yr	216 lbs/yr	410 gal/y
TOTALS				65,590 lbs/yr	4,304.5 lbs/yr 2.15 tons/yr VOC FROM COATING SYSTEMS ALONE	21,614 gal/y

* Based on 70% Solids.

** Approximate Average

BEST AVAILABLE COPY

TABLE 3

POTENTIAL PARTICULATE EMISSIONS AND UTILIZATION RATES

Type of Coating System	Potential Particulate Emissions Booth #1	Potential Particulate Emissions Booth #2	Potential Particulate Emissions Booth #3	Utilization Rate Booth #1 lbs/hr	Utilization Rate Booth #2 lbs/hr	Utilization Rate Booth #3 lbs/hr
2-Part ACR Polyurethane	6,724 lbs/yr	13,448 lbs/yr	13,448 lbs/yr	2.84	5.67	5.67
2-Part Epoxy Primer	261.14 lbs/yr	522.8 lbs/yr	522.8 lbs/yr	0.11	0.22	0.22
Conventional Primers	336.7 lbs/yr	673.4 lbs/yr	673.4 lbs/yr	.255	0.51	0.51
Lacquers	64.8 lbs/yr	129.6 lbs/yr	129.6 lbs/yr	0.09	0.18	0.18
Latex	31.9 lbs/yr	63.8 lbs/yr	0.002 lbs/yr	0.002	0.004	0.004
Low Solvent Shellac	136 lbs/yr	272 lbs/yr	272 lbs/yr	0.07	0.14	0.14
Alkyd Oil Base	23.3 lbs/yr	46.5 lbs/yr		0.02	0.04	0.04
Miscellaneous Other Coatings	36.9 lbs/yr	73.8 lbs/yr	73.8 lbs/yr	0.03	0.06	0.06
TOTALS	7,615 lbs/yr ← 3.81 T/yr	15,230 lbs/yr 7.61 → T/yr	15,230 lbs/yr 7.61 → T/yr			

Utilization Rates Based on Total Paint Usage Rates and 4160 hour work year (16 hrs/day, 5 days/wk, 52 wk/yr).

Potential emissions calculated using Overpray rates as presented in Attachment #1-1 of the original permit submittal.

BEST AVAILABLE COPY

TABLE 4

BREAKDOWN OF PARTICULATE EMISSIONS FROM PAINT SHOP SPRAY PAINT BOOTHS

Type of Coating System	Particulate Loads (lbs/yr)			Actual Particulate Emissions (with Controls) (lbs/yr)			VOC Emissions From Coating Systems Alone (lbs/yr)		
	Booth 1	Booth 2	Booth 3	Booth 1	Booth 2	Booth 3	Booth 1	Booth 2	Booth 3
2-Part Acrylic Polyurethane	11,794.3	23,588.3	23,588.3	336.2	672.4	672.4	0	0	0
2-Part Epoxy Primer	457.8	915.6	915.6	13.1	26.2	26.2	0	0	0
Conventional Primers	590.6	1,181.2	1,181.2	16.8	33.6	33.6	464	928	928
Lacquers	113.6	227.2	227.2	3.2	6.4	6.4	253	506	506
Latex	56	112	112	1.6	3.2	3.2	0	0	0
Low Solvent Shellac	238.5	477	477	6.8	13.6	13.6	61.5	123	123
Alkyd Oil Base	40.8	81.6	81.6	1.2	2.4	2.4	39.2	78.4	78.4
Miscellaneous Other Coatings	64.8	129.6	129.6	1.8	3.6	3.6	43.2	86.4	86.4
TOTALS	13,356.4	26,712.5	26,712.5	380.5	761	761	860.9	1,721.8	1,721.8
	lbs/yr	lbs/yr	lbs/yr	lbs/yr	lbs/yr	lbs/yr	lbs/yr	lbs/yr	lbs/yr
	6.7	13.4	13.4	0.19	0.38	0.38	0.43	0.86	0.8
	t/yr	t/yr	t/yr	t/yr	t/yr	t/yr	t/yr	t/yr	t/yr

Actual Emissions were calculated using the overspray rates and objects to be coated as presented in ATTACHMENT 1-F in the original permit submittal Binks Manufacturing quote a 95% efficiency for paint arrestor type filters when used with enamels, primers, and 2-part systems.

$$\left(\frac{\text{PARTICULATE OVERS}}{\text{POTENTIAL EMISS}} \right) = \left(\frac{\text{FRACTION OF OBJECT CATEGORY}}{\text{FRACTION OVERSPRAY}} \right) \times \left(\frac{\text{PARTICULATE OVERS}}{\text{POTENTIAL EMISS}} \right)$$

TABLE 5
UTILIZATION RATES FOR SOLVENT USAGE

<u>Solvent System Name or Designation</u>	<u>Utilization Rate Booth 1 lbs/hr</u>	<u>Utilization Rate Booth 2 lbs/hr</u>	<u>Utilization Rate Booth 3 lbs/hr</u>
PNT - 88	0.09	0.18	0.18
Acrythane Spray	0.20	0.40	0.40
Acrylic Enamel #601	0.17	0.34	0.34
Acrylic Enamel #602	0.25	0.50	0.50
Acrylic Enamel #607	0.008	0.016	0.016
Mehtanol	0.08	0.16	0.16
Z - SPAR T - 283	0.03	0.07	0.07
Lacquer #105	0.15	0.31	0.31
Amerflint Reducer	0.04	0.08	0.08
Lacquer Thinner	0.05	0.09	0.09
Acetone	0.02	0.04	0.04
Precleano	0.02	0.04	0.04
Methylene Chloride	0.009	0.02	0.02
Lacquer Reducer	0.002	0.004	0.004
Hexamethylene	0.005 0.002	0.004	0.004
Gil. Ure./Lac/18-C-135	<u>0.02</u>	<u>0.04</u>	<u>0.04</u>
TOTAL	1.16 lbs/hr	2.32 lbs/hr	2.32 lbs/hr

Utilization rates based on total solvent usage rates and 4160 hour work year
(16 hrs/day, 5 day/wk, 52 wk/yr).

ALL SOLVENTS ARE 100% VOC

TABLE 6
POTENTIAL AND ACTUAL EMISSIONS

	<u>Booth #1</u> lbs/yr	<u>Booth #2</u> lbs/yr	<u>Booth #3</u> lbs/yr
Total VOC Emissions (potential and actual)	5,647.3	11,294.6	11,294.6
Potential Particulate Emissions	7,615	15,230	15,230
Actual Particulate Emissions	380.5	761	761

TABLE 7
MAXIMUM EMISSIONS

	<u>Booth #1</u> lbs/yr	<u>Booth #2</u> lbs/yr	<u>Booth #3</u> lbs/yr
Maximum VOC * Emissions	3.68	7.36	7.36
Maximum Particulate Emissions **	0.26	0.52	0.52

TOTALS FOR ALL THREE BOOTHS

* Based on spraying total of
2½ gal. acrylic enamel
2½ gal. reducer (thinner)
per hour, average thinner
density of 7.36 lbs/gal.

** Based on spraying total of
5 gal./hr. 2-part acrylic
polyurethane in all three
booths.

TABLE 8
CONTAMINANT TYPES AND WT%

<u>Raw Materials</u>	<u>WT% Particulate</u>	<u>WT% VOC</u>
All Solvents	0	100
2-Part Acrylic Polyurethane	100	0
2-Part Epoxy Primer	100	0
Conventional Primers	56	44
Lacquers	31	69
Latex	70	0
Low Solvent Shellac	31.7	20.5
Alkyd Oil Base	51	49
Miscellaneous Other Coatings	60	40

TABLE 9
ESTIMATE OF VOC EMISSIONS FROM NON-BOOTH RELATED ACTIVITIES

Total Solvent Withdrawals	30,372	gal
Solvents disposed of as mixed Waste Solvents	- 11,055	gal
Solvents Disposed of as waste Paints (20% of TOTAL)	- 2,651	gal
Solvents disposed of as waste ACETONE	- 5,940	gal
Solvents used in Spray Booths	- 3,361	gal
	7,365	gal of solvent used in non-booth related painting

Using an average density of 7.3, this equates to:

53,765 lbs/yr VOC Emissions

or

26.9 tons/yr VOC Emissions

From non-booth related activities.

ATTACHMENT 2

P.E.'S SIGNATURE AND SEAL FOR STAFF SHOP BOOTH #2

The pollution control facilities, when properly maintained and operated, will discharge an effluent that complies with all applicable statutes of the State of Florida and the rules and regulations of the department. It is also agreed that the undersigned will furnish, if authorized by the owner, the applicant a set of instructions for the proper maintenance and operation of the pollution control facilities and, if applicable, pollution sources.

Signed

W. H. Mack

William H. Mack

Name (Please Type)

Walt Disney World Co.

Company Name (Please Type)

P.O. Box 40, Lake Buena Vista, FL 32830

Mailing Address (Please Type)

Florida Registration No. 22109 Date: 5-10-84 Telephone No. 305-828-2556

SECTION II: GENERAL PROJECT INFORMATION

Describe the nature and extent of the project. Refer to pollution control equipment, and expected improvements in source performance as a result of installation. State whether the project will result in full compliance. Attach additional sheet if necessary.

Construction of built-in spray booth with a new york blower model #S48-1 rated at 29,000 CFM for spray coating fiberglass molds and objects with polyester resin system, laquer based primers, and polyvinyl alcohol

Schedule of project covered in this application (Construction Permit Application Only)

Start of Construction existing booth Completion of Construction _____

Costs of pollution control system(s): (Note: Show breakdown of estimated costs only for individual components/units of the project serving pollution control purposes. Information on actual costs shall be furnished with the application for operation permit.)

Indicate any previous DER permits, orders and notices associated with the emission point, including permit issuance and expiration dates.

Permit application called in by Chuck Collins of Florida DER to be submitted by 16/83.



November 3, 1983

State of Florida
Department of Environmental Regulation
3319 Maguire Boulevard
Orlando, FL 32803

Re: Application to Operate/
Construct Air Pollution
Sources

Gentlemen:

Please be advised that Edward B. Crowell, Vice President -
Facilities, has been designated to sign all papers pertaining to the
enclosed application as an authorized representative of Walt Disney
World Co. and Reedy Creek Utilities Co., Inc.

Sincerely,

Philip N. Smith
Vice President - Legal and
Secretary

PNS/O/lj

Enclosure

ATTACHMENT #4

SKETCH OF FACILITY LAYOUT FOR NSA PAINT SHOP BOOTH #3

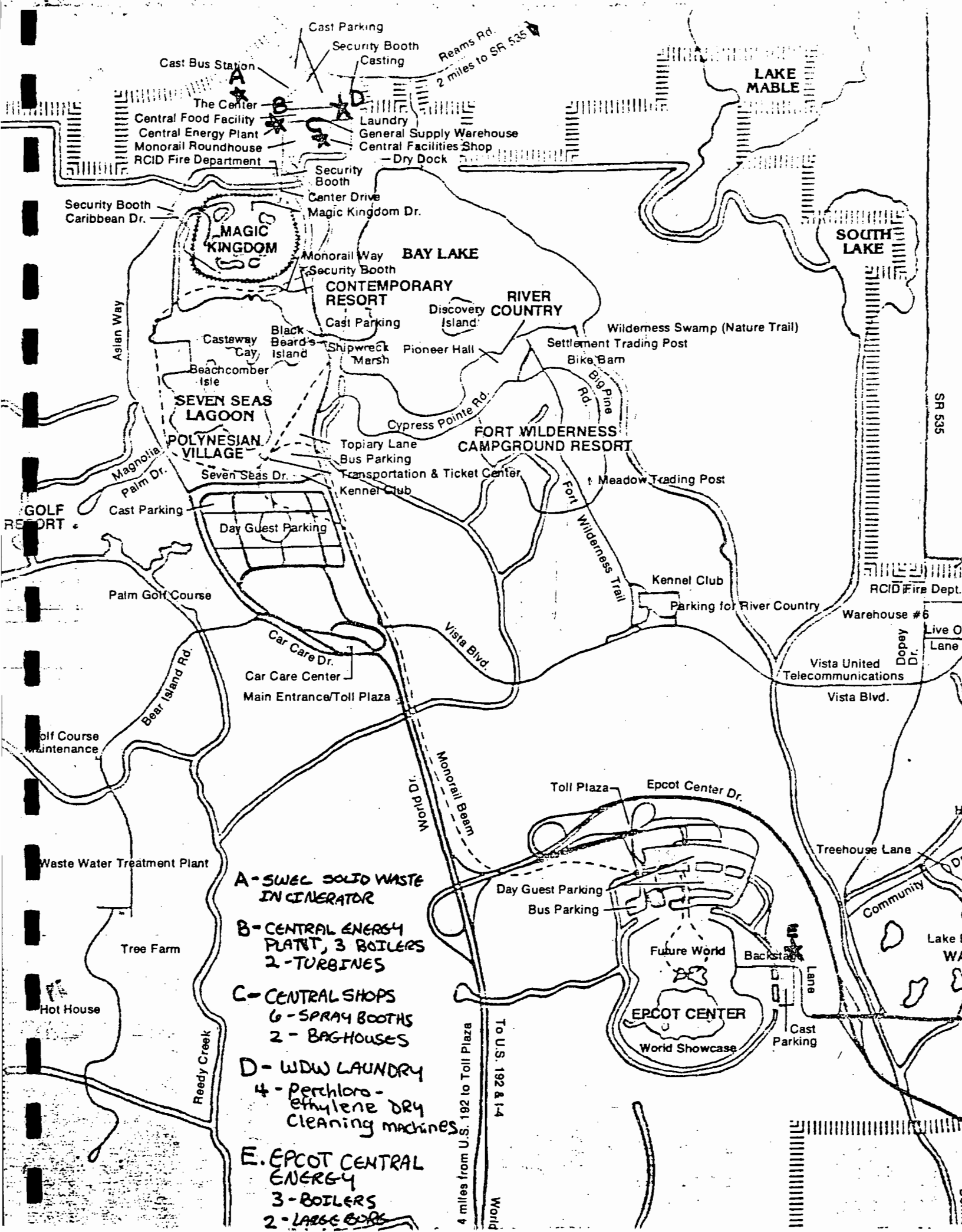

- A - SWEC SOLID WASTE IN CINCINATOR
- B - CENTRAL ENERGY PLANT, 3 BOILERS
2 - TURBINES
- C - CENTRAL SHOPS
6 - SPRAY BOOTHS
2 - BAGHOUSES
- D - WDW LAUNDRY
4 - perchloro-ethylene DRY cleaning machines
- E. EPCOT CENTRAL ENERGY
3 - BOILERS
2 - LARGE BOYS

4 miles from U.S. 192 to Toll Plaza
World
To U.S. 192 & 14

SR 535

RCID Fire Dept.
Warehouse #6
Live O Lane

Vista United Telecommunications
Dopey Dr.
Vista Blvd.

Treehouse Lane
Community
Lake WA

Cast Parking



July 13, 1984

Mr. C. H. Fancy, P.E.
Deputy Chief
Bureau of Air Quality Management
FLORIDA DEPARTMENT OF ENVIRONMENTAL REGULATION
Twin Towers Office Building
2600 Blair Stone Road
Tallahassee, Florida 32301-8241

Re: Construction Applications: AC 48-75833, AC 48-75834,
AC 48-75845, AC 48-75836, AC 48-75837 and AC 48-75838

Dear Mr. Fancy:

The following is in response to the questions put forth in your letter of June 13, 1984 concerning our construction permit applications:

<u>QUESTION 1 - Solvent</u>	<u>Density</u>
Acrythane Brush Reducer	0.971
Z-Spar T-8	0.845
Rustoleum T-66 Reducer (Xylene)	0.861
Amerthane ST-535	0.862
Methyl Ethyl Ketone (MEK)	0.807
Methyl Heptal Ketone (MHK)	0.827
Mineral Spirits	0.890
Butyl Cellosolve Acetate	0.971

QUESTION 2 - No Data Available

QUESTION 3 - There is no anticipated use of Trichloroethylene at any booth or open air spraying.

QUESTION 4 - Units should read, "Tons per Year", not "Pounds per Year".

QUESTION 5 - No solvents are reclaimed from the spray operation phase; however, leftover material which is reduced is disposed of through the Hazardous Waste Program operated by Reedy Creek Utilities Co. Cleaning

Mr. C. H. Fancy
Page Two
July 13, 1984

solvents are also disposed of in the same manner.

QUESTION 6 - There are four (4) dry cleaning units at the Walt Disney World Co. Laundry (see permit no. AO-48-74144). In rechecking with Walt Disney World Co. Laundry and the RCUC Hazardous Waste personnel, the following are the most accurate figures available for fiscal year 1983. Emission calculation is based on the following calculations:

A total of 13,731 gallons of perchloroethylene were purchased in fiscal year 1983; there are approximately 2,000 gallons within the system at any given time. In addition, approximately 6,052 gallons were disposed of through the Hazardous Waste Program leaving a balance of 5,679 gallons actually used which based on a 13.5 pounds per gallon resulted in approximately 38.3 tons per year VOC emission for 1983 from the Laundry Operations personnel.

QUESTION 7 - There are eight (8) service stations within the Walt Disney World Co. Project, seven (7) of which are private, i.e.:

Dry Dock
Grand Prix
WDW Golf Course, LBV
Golf Course and LBV Marina
Reedy Creek Improvement District
Gas Station, North Service Area
Gas Station, Lake Buena Vista

The public station is located at the EXXON Car Care Center.

Output for these stations is as follows:

<u>GAS SERVICE LOCATION</u>	<u>FY 1983</u>	<u>EMISSIONS HYDROCARBONS</u>
(Private)		
Dry Dock	277,465 gal	2.50 T/yr
Grand Prix	93,537 gal	0.84 T/yr
WDW Golf Course, LBV	-----	-----
Golf Course & LBV Marina	78,321 gal	0.70 T/yr
Reedy Creek Improvement District	7,110 gal	0.06 T/yr

Best Available Copy

Mr. C. H. Fancy
Page Three
July 13, 1984

<u>GAS SERVICE LOCATION</u>	<u>FY 1983</u>	<u>EMISSIONS HYDROCARBONS</u>
(Private)		
Gas Station, North Service Area	1,398,826 gal	7.69 T/yr
Gas Station, Lake Buena Vista	<u>1,098,695</u> gal	<u>6.04</u> T/yr
SUBTOTAL	2,953,954 gal	17.83 T/yr
(Public)		
EXXON Car Care Center	<u>1,187,792</u> gal	<u>6.53</u> T/yr
SUBTOTAL	1,187,792 gal	6.53 T/yr
<u>DIESEL</u>		
WDW Golf Course	<u>15,850</u> gal	<u>0.14</u> T/yr
SUBTOTAL	15,850 gal	0.14 T/yr
<u>LP GAS</u>		
Service Station	153,740 gal	-----
Furnishings	<u>2,787</u> gal	<u>-----</u>
SUBTOTAL	<u>156,527</u> gal	<u>-----</u>
TOTAL	4,157,596 gal	24.50 T/yr

We hope this additional information will make our application complete.
Thank you for your cooperation in processing our applications.

Very truly yours,

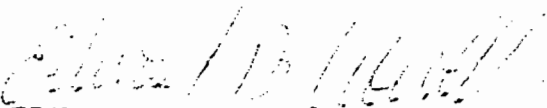
EDWARD B. CROWELL, Vice President
Facilities Division

EBC:psb