

Jeb Bush  
Governor

# Department of Environmental Protection

Twin Towers Office Building  
2600 Blair Stone Road  
Tallahassee, Florida 32399-2400

David B. Struhs  
Secretary

September 15, 1999

CERTIFIED MAIL - Return Receipt Requested

Mr. Lee Schmulde  
Vice President, Legal  
Walt Disney World Co.  
P.O. Box 10,000  
Lake Buena Vista, Florida 32830-1000

Re: Walt Disney World Resort  
Conditional Exemption for Two Paint Spray Booths  
Disney-MGM Studios Feature Animation Building

Dear Mr. Schmulde:

The Department has evaluated the submittal regarding the above referenced proposed new emission activities, in which two new bench-top spray booths will be located in the Disney-MGM Studios Feature Animation Building at the Walt Disney World Resort complex. The booths will be used to spray a small quantity of aerosol paint and adhesive on various paper and wood products. The total increase of potential VOC emissions from the two new booths is 0.63 tons per year (TPY).

The existing facility is a "major source of air pollution" or "Title V Source" for criteria pollutants and hazardous air pollutant emissions pursuant to Rule 62-210.200, Florida Administrative Code (F.A.C.), Definitions, and received its initial Title V operation permit on December 31, 1997, and became effective on January 1, 1998. Since the proposed contemporaneous VOC emissions increase is much less than the significant emissions rate of 40 TPY contained in Table 212.400-2, F.A.C., the proposal is not subject to PSD new source review pursuant to Rule 62-212.400(5), F.A.C.; also, for PSD review consideration pursuant to Rule 62-212.400(6)(b), F.A.C., it is determined that the proposal is not considered as part of a phase project. Finally, there are no specific emission limiting standards pursuant to Rule 62-204.800 and Chapter 62-296, F.A.C.

Based on the above findings, the Department is granting a conditional exemption from the air permitting requirements of the Florida Department of Environmental Protection for the subject two paint spray booths. The exemption is based on the premise that any air pollutants emitted from the proposed paint spray booths will not be in significant quantities to contribute to air pollution problems in the state pursuant to Rule 62-4.040(1)(b), F.A.C.

The conditions of this exemption are:

A. Disney-MGM Studios Feature Animation Building

1. The total VOC emissions from the paint spray booth operations shall not exceed 0.63 TPY per calendar year (0.31 TPY per booth).
2. The owner or operator(s) will account for the materials used using a materials balance scheme, which employs the following:
  - a. a beginning inventory of materials in stock (on or about 1/1/yr);
  - b. adding any materials received during the year;
  - c. subtracting any materials recycled during the year; and,
  - d. subtracting any ending inventory of materials in stock (on or about 12/31/yr), with the net result assumed to have been used and emitted.
3. Any records kept will be retained for a five year period and made available for Department inspection upon request.
4. The operation of this activity shall not cause or contribute to an objectionable odor.

*"Protect, Conserve and Manage Florida's Environment and Natural Resources"*

5. If the conditions on which this exemption are based change, the operator shall notify the Department's Bureau of Air Regulation of the changes and request the exemption be amended.

6. Upon the next opening of the facility's Title V operation permit, which is scheduled for late summer of this year, this paint spray booth will be identified/designated as an "unregulated" emissions unit/activity and placed in Appendix U-1, Unregulated Emissions Units/Activities, for future inventory purposes on an every 5-year basis, starting in year 2000.

This conditional exemption will take effect 21 days from the clerking date unless a timely petition for an administrative hearing is filed pursuant to Sections 120.569 and 120.57, Florida Statutes (F.S.). The procedures for petitioning for a hearing are set forth below.

A person whose substantial interests are affected by the proposed agency action may petition for an administrative proceeding (hearing) under Sections 120.569 and 120.57, F.S. The petition must contain the information set forth below and must be filed (received) in the Office of General Counsel of the Department at 3900 Commonwealth Boulevard, Mail Station #35, Tallahassee, Florida, 32399-3000. Petitions filed by the applicant or any of the parties listed below must be filed within twenty-one days of receipt of this notice of intent. Petitions filed by any persons other than those entitled to written notice under Section 120.60(3), F.S., must be filed within twenty-one days of publication of the public notice or within twenty-one days of receipt of this notice, whichever occurs first. Under Section 120.60(3), F.S., however, any person who asked the Department for notice of agency action may file a petition within twenty-one days of receipt of that notice, regardless of the date of publication. A petitioner shall mail a copy of the petition to the applicant at the address indicated above at the time of filing. The failure of any person to file a petition within the appropriate time period shall constitute a waiver of that person's right to request an administrative determination (hearing) under Sections 120.569 and 120.57, F.S., or to intervene in this proceeding and participate as a party to it. Any subsequent intervention will be only at the approval of the presiding officer upon the filing of a motion in compliance with Rule 28-106.205, F.A.C.

A petition that disputes the material facts on which the Department's action is based must contain the following information: (a) The name and address of each agency affected and each agency's file or identification number, if known; (b) The name, address, and telephone number of the petitioner, the name, address, and telephone number of the petitioner's representative, if any, which shall be the address for service purposes during the course of the proceeding; and an explanation of how the petitioner's substantial interests will be affected by the agency determination; (c) A statement of how and when petitioner received notice of the agency action or proposed action; (d) A statement of all disputed issues of material fact. If there are none, the petition must so indicate; (e) A concise statement of the ultimate facts alleged, as well as the rules and statutes which entitle the petitioner to relief; and, (f) A demand for relief.

A petition that does not dispute the material facts upon which the Department's action is based shall state that no such facts are in dispute and otherwise shall contain the same information as set forth above, as required by Rule 28-106.301, F.A.C.

Because the administrative hearing process is designed to formulate final agency action, the filing of a petition means that the Department's final action may be different from the position taken by it in this notice. Persons whose substantial interests will be affected by any such final decision of the Department on the request for conditional exemption have the right to petition to become a party to the proceeding, in accordance with the requirements set forth above.

Mediation is not available in this proceeding.

#### NOTICE OF APPEAL RIGHTS

Any party to this conditional exemption has the right to seek judicial review of it under Section 120.68, F.S., by filing a Notice of Appeal under Rule 9.110 of the Florida Rules of Appellate Procedure with the Clerk of the Department of Environmental Protection in the Office of General Counsel, Mail Station #35, 3900 Commonwealth Boulevard, Tallahassee, Florida, 32399-3000, and by filing a copy of the Notice of Appeal accompanied by the applicable filing fees with the appropriate District Court of Appeal. The notice must be filed within thirty days after this conditional exemption is filed with the Clerk of the Department.

Walt Disney World Resort  
Conditional Exemption for Two Paint Spray Booths  
Disney-MGM Studios Feature Animation Building  
September 15, 1999  
Page 3 of 4

A copy of the conditional exemption and accompanying materials related to the proposed agency action are available for public inspection during normal business hours, 8:00 a.m. to 5:00 p.m., Monday through Friday, except legal holidays, at the Department of Environmental Protection, Division of Air Resources Management, Suite 23, Magnolia Courtyard, 111 South Magnolia Drive, Tallahassee, Florida 32301, and at the Department's Central Florida District Office, 3319 Maguire Blvd., Suite 232, Orlando, Florida 32803-3767.

Executed in Tallahassee, Florida.

**STATE OF FLORIDA DEPARTMENT  
OF ENVIRONMENTAL PROTECTION**

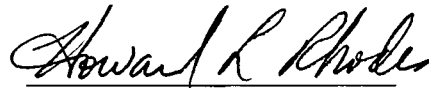

Howard L. Rhodes, Director  
Division of Air Resources  
Management  
2600 Blair Stone Road  
Tallahassee, Florida 32399-2400  
(850)488-0114

Walt Disney World Resort  
Conditional Exemption for Two Paint Spray Booths  
Disney-MGM Studios Feature Animation Building  
September 15, 1999  
Page 4 of 4

**CERTIFICATE OF SERVICE**

The undersigned duly designated deputy agency clerk hereby certifies that this NOTICE OF CONDITIONAL EXEMPTION and all copies were sent by certified mail before the close of business on 9/15/99 to the person(s) listed:

Mr. Lee Schmutde, Vice President, Legal, Walt Disney World Co.

In addition, the undersigned duly designated deputy agency clerk hereby certifies that copies of this NOTICE OF CONDITIONAL EXEMPTION were sent by U.S. mail on the same date to the person(s) listed, unless otherwise noted:

Mr. Len Kozlov, CD (Interoffice mail)  
Mr. Bob Beaver, P.E., Walt Disney World Co.  
Mr. Richard Bumar, Contact, Walt Disney World Co.  
Mr. Scott Sheplak, BAR (hand delivered)

Clerk Stamp

**FILING AND ACKNOWLEDGMENT FILED**, on this date, pursuant to Section 120.52(7), F.S., with the designated agency Clerk, receipt of which is hereby acknowledged.

Barbara J. Portwell 9/15/99  
(Clerk) (Date)

HLR/CHF/bm

Enclosure

v:\bruce\permits\0950111x\psbx2a.ltr



WALT DISNEY World Co.

RECEIVED  
JUL 19 1999  
BUREAU OF AIR REGULATION

July 14, 1999

Mr. Clair Fancy, P.E.  
Chief, Bureau of Air Regulation  
Florida Department of Environmental Protection  
2600 Blair Stone Road  
Tallahassee, Florida 32399-2400

RE: Installation of two bench-top spray booths  
Disney-MGM Studios Feature Animation Building

Dear Mr. Fancy:

This letter proposes conditional exemptions from construction permitting requirements for two new bench-top spray booths at the Walt Disney World Resort complex. The units are located in the Disney-MGM Studios Feature Animation Building and will be used to spray a small quantity of aerosol paints and adhesive on various paper and wood products. Based on the proposed production schedule and material usage rate, the booth has the potential to emit no more than 0.63 tons of VOCs per year. Please refer to Attachment A for the supporting documentation and material safety data sheets that verify this amount. Attachments B and C show the location and plot plan of the proposed emissions unit. Also included are the professional engineer's certification and the responsible official's statement.

Since the potential emissions from each unit are very low, it is requested that the units be granted a conditional exemption from construction permitting requirements. Bruce Mitchell and I have discussed this issue and he has concluded that a conditional exemption is probably appropriate for these units.

If you have any questions or need any further information, please call me at 407-827-2748.

Sincerely,

Rich Bumar  
Environmental Control Representative  
Environmental Control Department

Enclosure

cc: Bob Beaver  
Leonard Kozlov  
Bruce Mitchell  
Armando Rodriguez (w/o enclosure)  
Lee Schmutde (w/o enclosure)  
Scott Sheplak (w/o enclosure)

7/21/99 cc: Bruce Mitchell

Is your RETURN ADDRESS completed on the reverse side?

<b>SENDER:</b> ■ Complete items 1 and/or 2 for additional services. ■ Complete items 3, 4a, and 4b. ■ Print your name and address on the reverse of this form so that we can return this card to you. ■ Attach this form to the front of the mailpiece, or on the back if space does not permit. ■ Write "Return Receipt Requested" on the mailpiece below the article number. ■ The Return Receipt will show to whom the article was delivered and the date delivered.		I also wish to receive the following services (for an extra fee): 1. <input type="checkbox"/> Addressee's Address 2. <input type="checkbox"/> Restricted Delivery Consult postmaster for fee.
3. Article Addressed to: Mr. Lee Schmutde Vice President, Legal Walt Disney World Co. P.O. Box 10,000 Lake Buena Vista, Florida 32830-1000	4a. Article Number P 263 585 245	4b. Service Type <input type="checkbox"/> Registered <input checked="" type="checkbox"/> Certified <input type="checkbox"/> Express Mail <input type="checkbox"/> Insured <input type="checkbox"/> Return Receipt for Merchandise <input type="checkbox"/> COD
5. Received By: (Print Name)	7. Date of Delivery	
6. Signature: (Addressee or Agent) <b>X</b>	8. Addressee's Address (Only if requested and fee is paid)	

Thank you for using Return Receipt Service.

PS Form 3811, December 1994

102595-97-B-0179

Domestic Return Receipt

P 263 585 245

US Postal Service  
**Receipt for Certified Mail**  
 No Insurance Coverage Provided.  
 Do not use for International Mail (See reverse)

Sent to	
Mr. Lee Schmutde	
Street & Number	
P.O. Box 10,000	
Post Office, State, & ZIP Code	
Lake Buena Vista, FL 32830	
Postage	\$ 1000
Certified Fee	
Special Delivery Fee	
Restricted Delivery Fee	
Return Receipt Showing to Whom & Date Delivered	
Return Receipt Showing to Whom, Date, & Addressee's Address	
TOTAL Postage & Fees	\$
Postmark or Date	9/15/99

PS Form 3800, April 1995



WALT DISNEY World Co.

RECEIVED

JUL 19 1999

BUREAU OF AIR REGULATION

July 14, 1999

Mr. Clair Fancy, P.E.  
Chief, Bureau of Air Regulation  
Florida Department of Environmental Protection  
2600 Blair Stone Road  
Tallahassee, Florida 32399-2400

RE: Installation of two bench-top spray booths  
Disney-MGM Studios Feature Animation Building

Dear Mr. Fancy:

This letter proposes conditional exemptions from construction permitting requirements for two new bench-top spray booths at the Walt Disney World Resort complex. The units are located in the Disney-MGM Studios Feature Animation Building and will be used to spray a small quantity of aerosol paints and adhesive on various paper and wood products. Based on the proposed production schedule and material usage rate, the booth has the potential to emit no more than 0.63 tons of VOCs per year. Please refer to Attachment A for the supporting documentation and material safety data sheets that verify this amount. Attachments B and C show the location and plot plan of the proposed emissions unit. Also included are the professional engineer's certification and the responsible official's statement.

Since the potential emissions from each unit are very low, it is requested that the units be granted a conditional exemption from construction permitting requirements. Bruce Mitchell and I have discussed this issue and he has concluded that a conditional exemption is probably appropriate for these units.

If you have any questions or need any further information, please call me at 407-827-2748.

Sincerely,

Rich Bumar  
Environmental Control Representative  
Environmental Control Department

Enclosure

cc: Bob Beaver  
Leonard Kozlov  
Bruce Mitchell  
Armando Rodriguez (w/o enclosure)  
Lee Schmudde (w/o enclosure)  
Scott Sheplak (w/o enclosure)

**Owner/Authorized Representative or Responsible Official**

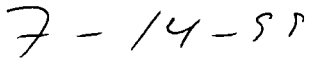
1. Name and Title of Owner/Authorized Representative or Responsible Official: Name: Lee Schmutde Title: Vice-President, Legal
2. Owner/Authorized Representative or Responsible Official Mailing Address:  Organization/Firm: Walt Disney World, Co. Street Address: P.O. Box 10,000 City: Lake Buena Vista State: FL Zip Code: 32830-1000
3. Owner/Authorized Representative or Responsible Official Telephone Numbers: Telephone: (407 ) 828-3701 Fax: (407 ) 828-3239
4. Owner/Authorized Representative or Responsible Official Statement:  <i>I, the undersigned, am the owner or authorized representative* of the facility (non-Title V source) addressed in this Application for Air Permit or the responsible official, as defined in Chapter 62-213, F.A.C., of the Title V source addressed in this application, whichever is applicable. I hereby certify, based on information and belief formed after reasonable inquiry, that the statements made in this application are true, accurate and complete and that, to the best of my knowledge, any estimates of emissions reported in this application are based upon reasonable techniques for calculating emissions. Further, I agree to operate and maintain the air pollutant emissions units and air pollution control equipment described in this application so as to comply with all applicable standards for control of air pollutant emissions found in the statutes of the State of Florida and rules of the Department of Environmental Protection and revisions thereof. If the purpose of this application is to obtain an air operation permit or operation permit revision for one or more emissions units which have undergone construction or modification, I certify that, with the exception of any changes detailed as part of this application, each such emissions unit has been constructed or modified in substantial accordance with the information given in the corresponding application for air construction permit and with all provisions contained in such permit. I understand that a permit, if granted by the Department, cannot be transferred without authorization from the Department, and I will promptly notify the Department upon sale or legal transfer of any permitted emissions unit.</i>   Signature  Date

\* Attach letter of authorization if not currently on file.



**Professional Engineer Certification**

1. Professional Engineer Name: Robert Beaver Registration Number: 32528
2. Professional Engineer Mailing Address:  Organization/Firm: Walt Disney World Co. Street Address: P.O. Box 10,000 City: Lake Buena Vista                      State: FL                      Zip Code: 32830-1000
3. Professional Engineer Telephone Numbers: Telephone: (407) 828- 1584                      Fax: (407) 934- 7927
4. Professional Engineer Statement:  <i>I, the undersigned, hereby certify, except as particularly noted herein*, that:</i>  <i>(1) To the best of my knowledge, there is reasonable assurance (a) that the air pollutant emissions unit(s) and the air pollution control equipment described in this Application for Air Permit, when properly operated and maintained, will comply with all applicable standards for control of air pollutant emissions found in the Florida Statutes and rules of the Department of Environmental Protection; or (b) for any application for a Title V source air operation permit, that each emissions unit described in this Application for Air Permit, when properly operated and maintained, will comply with the applicable requirements identified in this application to which the unit is subject, except those emissions units for which a compliance schedule is submitted with this application;</i>  <i>(2) To the best of my knowledge, any emission estimates reported or relied on in this application are true, accurate, and complete and are either based upon reasonable techniques available for calculating emissions or, for emission estimates of hazardous air pollutants not regulated for an emissions unit addressed in this application, based solely upon the materials, information and calculations submitted with this application; and</i>  <i>(3) For any application for an air construction permit for one or more proposed new or modified emissions units, the engineering features of each such emissions unit described in this application have been designed or examined by me or individuals under my direct supervision and found to be in conformity with sound engineering principles applicable to the control of emissions of the air pollutants characterized in this application.</i>  _____ Signature                      Date 7/14/99  (seal)

\* Attach any exception to certification statement.

Attachment A

Disney-MGM Studios Feature Animation Building Spray Booths

Class	Manufacturer	Material Name	Maximum Daily Usage per booth, 16 oz. Can	% VOC by weight	Potential VOC Emissions		
					Daily lb per booth	Annual pounds per booth	Annual tons per booth
Acrylic Enamel	Krylon Industrial	Krylon Aerosol Paints	1	90%	0.90	328.50	0.164
Spray Adhesive	3M	Spray Mount Artist Adhesive	1	82%	0.82	297.84	0.149

Totals per booth	2 cans/day	1.7	626	0.31
Totals	4 cans/day	3.4	1,253	0.63

# Single Exhaust Bench Type

paasche

EBF- Single Exhaust Filter Type Bench Booths with \*AG- (Standard) Fiber Glass Filters, trap practically all coating solids as they are drawn through the working area of the Spray Booth. This results in cleaner operation and no accumulation of overspray on the fan blades, duct interior, exhaust stack or on building or adjoining property. All Booths are supplied with an extra set of Fiber Glass Filters and visible draft gauge. EBF- Booths will accommodate Top or Back exhaust.

When Ordering, please specify:

- Top or Back Exhaust
- SM-967 Vent Belt Guard  
(Standard when ordering vent unit)

# TEBF- Twin Filter Booths Single Exhaust Bench Type

TEBF- Twin, Single Exhaust Booths provide work spaces for two (2) or more operators. One exhaust unit provides the required ventilation for both sides of the Booth. Rigidly constructed from 18 gauge galvanized sheet steel and supported by four (4) legs on small Booths; six (6) on larger booths. TEBF- Twin, Single Exhaust Booths will accommodate Top exhaust ONLY. An extra set of \*AG- (Standard) Fiber Glass Filters are supplied with each Booth.

When Ordering, please specify:

- TEBF- Will accommodate Top Exhaust ONLY

When Ordering Options, please specify:

- TEBF- Will accommodate Top Exhaust ONLY
- SM-967 Vent Belt Guard  
(Standard when ordering vent unit)

# Sand Blast Booths Silvering Booths

## SAND BLAST BOOTHS

SBB- and SBBV- These Sand Blast Booths are designed to protect operator and improve ecology. Abrasive material is confined within the Booth and falls through the expanded metal shelf to bottom where it is recovered. Tinted glass shelf permits full view of work. Both Styles are constructed of 18 gauge galvanized steel, and can accommodate Top or Back Exhaust. Available in standard sizes or either style can be manufactured to fit your requirements.

SBB- Booth is furnished without an Exhaust System; thus purchaser can furnish a "Dust Collection System" if desired.

SBBV- Booth is furnished with a Ventilating Unit to draw air to outside atmosphere. Regulator Moisture Condenser Unit and Abrasive Guns are optional equipment.

When Ordering, please specify:

- Top or Back Exhaust
- SM-967 Vent Belt Guard  
(Standard when ordering vent unit)
- Optional Equipment (if required)

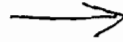

EBF-

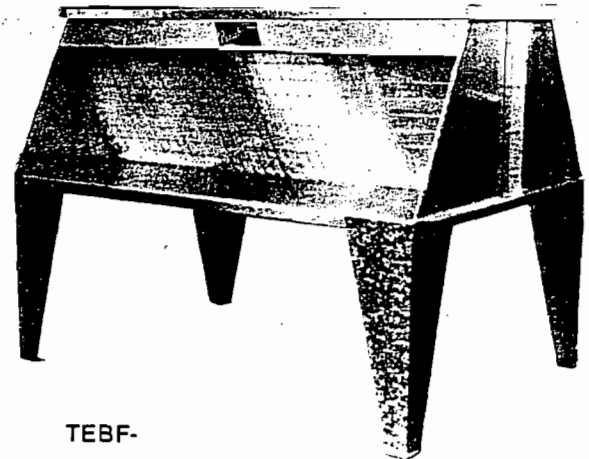
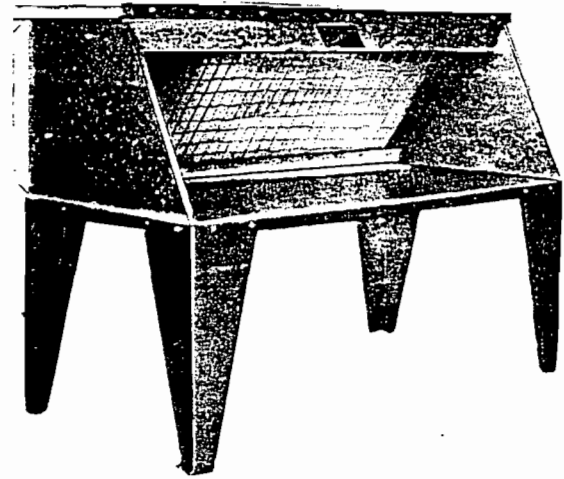

TEBF-

## SILVERING BOOTHS

SB- These Silvering Booths are use extensively by electroplaters, electrotypers, mirror and specialty manufacturers for the application of nitrates, gold, copper, nickel and other fluid materials that can be mixed only at time of application or when two (2) or more fluids are atomized to form a coating mixture.

The Standard Size SB- Booth shown is 4' wide by 4' deep by 7' high with adjustable metal easel 2' wide by 1'8" high and can accommodate Top or Back Exhaust. This Booth can also be manufactured to your specifications. Regulator-Moisture Condenser Unit and Spray Guns are optional equipment.

When Ordering, please specify:

- Top or Back Exhaust
- SM-967 Vent Belt Guard  
(Standard when ordering vent unit)
- Optional Equipment (if required)

# Filter Units for Booths

## Replacement Only, Wire Filter Banks:

- SM-808- Wire Filter Banks
- SM-810A- Wire Filter Banks

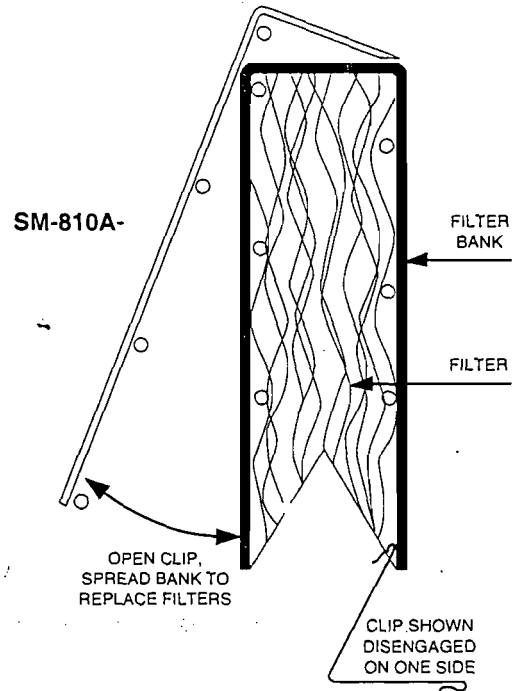
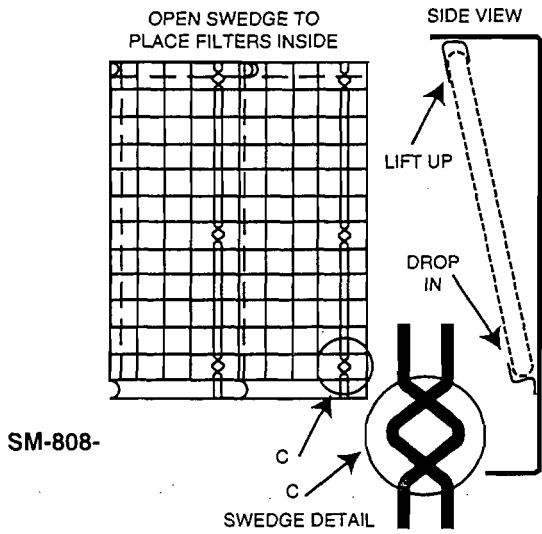

## AG- (Standard) Fiber Glass Filter Replacements:

AG-20" (20" x 20" x 2") 50 per Carton

AG- (Standard)  
Fiber Glass Filter



## FA-1 Filter Cell (For Standard Fiber Glass Filters)

### FA-1 Filter & Grid Installation Instructions:

When replacing AG- Standard Fiber Glass Filters be sure Green Surface is facing Operator. Replacement AG- Fiber Glass Filters are available in cartons of 50 each.

1. FA Filter Frame (20" x 20")
2. RP-20"x20" Retaining Grids
3. AG-20" Fiber Glass Filters (20" x 20" x 2")

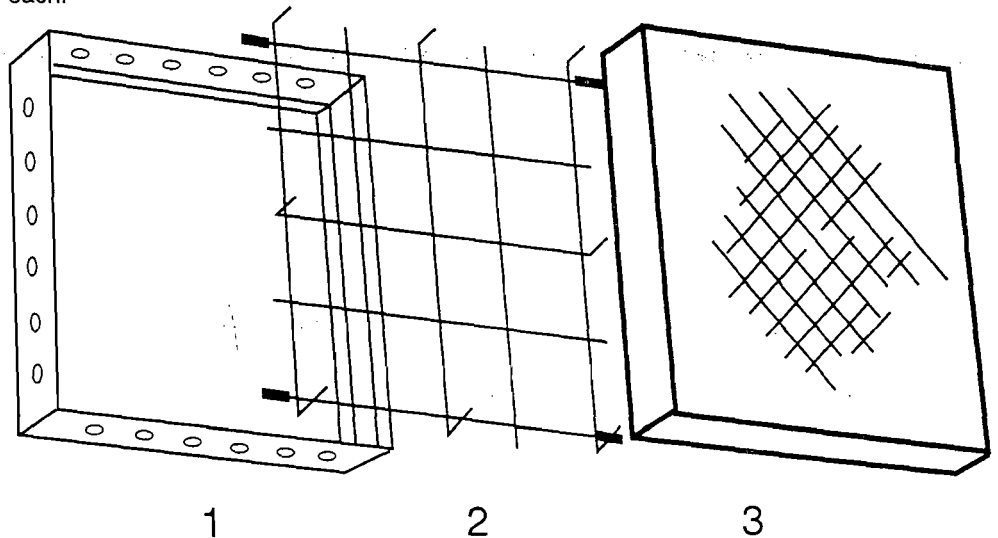

# MATERIAL SAFETY DATA SHEET

— SECTION I —  
PRODUCT IDENTIFICATION

KRYLON INDUSTRIAL  
6830 COCHRAN ROAD  
OLON, OH 44139

EMERGENCY TELEPHONE NO.  
(216) 282-7400  
INFORMATION TELEPHONE NO.  
(800) 247-3266

DATE OF PREPARATION  
20 - FEB - 93

©1993, The Sherwin-Williams Co.

## Specialty Spray Coatings

SPECS/KRI

— SECTION II —		ACGIH	OSHA	Units	Vapor	1303	1306	1310	1311	1312	7005	7006
CAS No.	HAZARDOUS INGREDIENT (percent by weight)	TLV <STEL>	PEL <STEL>		Pressure (mm Hg)	Crystal Clear	Workable Fluid	Dulling Spray	Matte Finish	Kerat Varnish	Polyurethane Gloss	Polyurethane Satin
74-98-6	Propane (propellant)		1000	PPM	760.0	14	14	14	14	14	14	14
75-28-5	2-Methylpropane (propellant)		Not Established		760.0	14	14	14	14	14	14	14
110-54-3	Hexane	50	50	PPM	127.0		18	18	18	18	18	18
64742-89-8	V. M. & P. Naphtha	300	300 <100>	PPM	12.0	6	3	6	6	6	6	11
64742-47-6	Mineral Spirits	100	100	PPM	2.0							
64742-48-9	Hydrocarbon Solvent	100	100	PPM								
108-88-3	Toluene	50	100 <150>	PPM (Skin)	22.0	20	8	15	15	15	15	14
100-41-4	Ethylbenzene	100 <125>	100 <125>	PPM	7.1							
1330-20-7	Xylene	100 <150>	100 <150>	PPM	5.0		4					
64742-95-6	Light Aromatic Naphtha	100		PPM	3.0							
67-83-0	2-Propanol	400 <500>	400 <500>	PPM	33.0							
67-64-1	Acetone	750 <1000>	750 <1000>	PPM	180.0		6					
108-65-6	1-Methoxy-2-Propanol Acetate		Not Established		1.0		4					
VOC as a percent by weight per BAAQMD Rule 49						67	90	83	82	83	82	83
NFPA Code 30B Level						3	3	3	3	3	3	3
HMIS® Ratings (Health - Flammability - Reactivity)						2-4-0	2-4-0	2-4-0	2-4-0	2-4-0	2-4-0	2-4-0

§ Ingredient subject to the reporting requirements of the Superfund Amendments and Reauthorization Act (SARA) Section 313, 40 CFR 372.65 C

PURSUANT TO PROPOSITION 65: These products contain toluene which is known by the state of California to cause reproductive toxicity.

→→→ MSDS Text Page Follows →→→

# Specialty Spray Coatings

# SPECS/KRI

## Section III — PHYSICAL DATA

PRODUCT WEIGHT - N.A.	EVAPORATION RATE - Faster than Ether
SPECIFIC GRAVITY - N.A.	VAPOR DENSITY - Heavier than Air
BOILING RANGE - <math>-4-195\text{ }^{\circ}\text{F}</math>	MELTING POINT - N.A.
SOLUBILITY IN WATER - N.A.	

## Section IV — FIRE AND EXPLOSION HAZARD DATA

FLAMMABILITY CLASSIFICATION FLASH POINT <math>40\text{ }^{\circ}\text{F}</math> HMCC LEL 0.9 UEL 12.8

Extremely Flammable, flash below 21 °F

### EXTINGUISHING MEDIA

Carbon Dioxide, Dry Chemical, Foam

### UNUSUAL FIRE AND EXPLOSION HAZARDS

Isolate from heat, electrical equipment, sparks, and open flame. Closed containers may explode when exposed to extreme heat. Application to hot surfaces requires special precautions. During emergency conditions overexposure to decomposition products may cause a health hazard. Symptoms may not be immediately apparent. Obtain medical attention.

### SPECIAL FIRE FIGHTING PROCEDURES

Full protective equipment including self-contained breathing apparatus should be used. Water spray may be ineffective. If water is used, fog nozzles are preferable. Water may be used to cool closed containers to prevent pressure build-up and possible autoignition or explosion when exposed to extreme heat.

## Section V — HEALTH HAZARD DATA

### ROUTES OF EXPOSURE

Exposure may be by INHALATION and/or SKIN or EYE contact, depending on conditions of use. To minimize exposure, follow recommendations for proper use, ventilation, and personal protective equipment.

### ACUTE Health Hazards

#### EFFECTS OF OVEREXPOSURE

Irritation of eyes, skin and respiratory system. May cause nervous system depression. Extreme overexposure may result in unconsciousness and possibly death.

#### SIGNS AND SYMPTOMS OF OVEREXPOSURE

Headache, dizziness, nausea, and loss of coordination are indications of excessive exposure to vapors or spray mist.

Redness and itching or burning sensation may indicate eye or excessive skin exposure.

#### MEDICAL CONDITIONS AGGRAVATED BY EXPOSURE

Nose generally recognized.

#### EMERGENCY AND FIRST AID PROCEDURES

IF INHALED: If affected, remove from exposure. Restart breathing. Keep warm and quiet.

IF ON SKIN: Wash affected area thoroughly with soap and water.

Remove contaminated clothing and launder before re-use.

IF IN EYES: Flush eyes with large amounts of water for 15 minutes. Get medical attention.

IF SWALLOWED: Get medical attention.

#### CHRONIC Health Hazards

No ingredient in these products is an IARC, NTP or OSHA listed carcinogen.

Prolonged overexposure to solvent ingredients in section II may cause adverse effects to the liver, urinary, blood-forming, cardiovascular, and reproductive systems.

Reports have associated repeated and prolonged overexposure to solvents with permanent brain and nervous system damage.

## Section VI — REACTIVITY DATA

### STABILITY - Stable

### INCOMPATIBILITY

None known.

### HAZARDOUS DECOMPOSITION PRODUCTS

By fire: Carbon Dioxide, Carbon Monoxide

### HAZARDOUS POLYMERIZATION - Will Not Occur

## Section VII — SPILL OR LEAK PROCEDURES

### STEPS TO BE TAKEN IN CASE MATERIAL IS RELEASED OR SPILLED

Remove all sources of ignition. Ventilate and remove with inert absorbent.

### WASTE DISPOSAL METHOD

Waste from this product may be hazardous as defined under the Resource Conservation and Recovery Act (RCRA) 40 CFR 261. Waste must be tested for ignitability to determine the applicable EPA hazardous waste numbers.

Do not incinerate. Depressurize container. Dispose of in accordance with Federal, State, and Local regulations regarding pollution.

## Section VIII — PROTECTION INFORMATION

### PRECAUTIONS TO BE TAKEN IN USE

Use only with adequate ventilation. Avoid breathing vapor and spray mist. Avoid contact with skin and eyes. Wash hands after using.

These coatings may contain materials classified as nuisance particulates (listed "as Dust" in Section II) which may be present at hazardous levels only during sanding or abrading of the dried film. If no specific dusts are listed in Section II, the applicable limits for nuisance dusts are ACGIH TLV 10 mg./m<sup>3</sup> (total dust), OSHA PEL 15 mg./m<sup>3</sup> (total dust), 5 mg./m<sup>3</sup> (respirable fraction).

### VENTILATION

Local exhaust preferable. General exhaust acceptable if the exposure to material in Section II is maintained below applicable exposure limits. Refer to OSHA Standards 1910.94, 1910.107, 1910.108.

### RESPIRATORY PROTECTION

If personal exposure cannot be controlled below applicable limits by ventilation, wear a properly fitted organic vapor/particulate respirator approved by NIOSH/MSHA for protection against materials in Section II.

When sanding or abrading the dried film, wear a dust/mist respirator approved by NIOSH/MSHA for protection against non-volatile materials in Section II.

### PROTECTIVE GLOVES

None required for normal application of aerosol products where minimal skin contact is expected. For long or repeated contact, wear chemical resistant gloves.

### EYE PROTECTION

Wear safety spectacles with unperforated side shields.

## Section IX — PRECAUTIONS

### DOT STORAGE CATEGORY - 1A

#### PRECAUTIONS TO BE TAKEN IN HANDLING AND STORING

Contents are EXTREMELY FLAMMABLE. Keep away from heat, sparks, and open flame.

Vapors will accumulate readily and may ignite explosively.

During use and until all vapors are gone, keep area ventilated. Do not smoke.

Extinguish all flames, pilot lights, and heaters. Turn off stoves, electric tools and appliances, and any other sources of ignition.

Consult NFPA Code. Use approved bonding and grounding procedures.

Contents under pressure. Do not puncture, incinerate, or expose to temperature above 120 °F. Heat from sunlight, radiators, stoves, hot water, and other heat sources could cause container to burst. Do not take internally. Keep out of the reach of children.

#### OTHER PRECAUTIONS

Intentional misuse by deliberately concentrating and inhaling the contents can be harmful or fatal.

The above information pertains to this product as currently formulated, and is based on the information available at this time. Addition of reducers or other additives to this product may substantially alter the composition and hazards of the product. Since conditions of use are outside our control, we make no warranties, express or implied, and assume no liability in connection with any use of this information.

3M General Offices

3M Center  
St. Paul, MN 55144-1000  
612 733 111004-35  
6826MATERIAL SAFETY  
DATA SHEET

Copyright, 1996, Minnesota Mining and Manufacturing Company.  
All rights reserved. Copying and/or downloading of this information for the purpose of properly utilizing 3M products is allowed provided that:

- 1) the information is copied in full with no changes unless prior agreement is obtained from 3M, and
- 2) Neither the copy nor the original is resold or otherwise distributed with the intention of earning a profit thereon.

## DIVISION: INDUSTRIAL TAPE AND SPECIALTIES DIVISION

## TRADE NAME:

Catalog 6065 Spray-Mount (TM) Artist Adhesive

3M ID NUMBER/U.P.C.:	CS-0406-2155-2	-	-	-	62-4953-2930-2	00-21200-89590-6
	62-4953-3730-5	-	-	-	62-4953-4825-2	00-21200-64814-4
	62-4953-4826-0	-	-	-	62-4953-4827-8	00-21200-64814-4

ISSUED: AUGUST 28, 1996  
SUPERSEDES: JUNE 24, 1996  
DOCUMENT: 11-6490-4

1. INGREDIENT	C.A.S. NO.	PERCENT	
ISOBUTANE .....	75-28-5	20.0	30.0
PENTANE .....	109-66-0	20.0	30.0
HEPTANE .....	142-82-5	10.0	20.0
NON-VOLATILE COMPONENTS - N.J.			
TRADE SECRET (T.S.) REGISTRY NO.			
04499600-5904P++ .....	TradeSecret	10.0	20.0
PROPANE .....	74-98-6	10.0	20.0
ACETONE .....	67-64-1	7.0	13.0

NOTE: ++ rosin, synthetic polymer and plasticizers. Not Hazardous according to Canadian WHMIS criteria. Non-WHMIS controlled.

## 2. PHYSICAL DATA

BOILING POINT:.....	Compressed gas
VAPOR PRESSURE:.....	Compressed gas
VAPOR DENSITY: .....	2.97 Air = 1
EVAPORATION RATE:.....	1.90 Water = 1
SOLUBILITY IN WATER: .....	nil
SP. GRAVITY:.....	0.640 Water = 1
PERCENT VOLATILE: .....	ca. 90 % by wt
pH: .....	N/A
VISCOSITY: .....	N/A
MELTING POINT.....	N/D
APPEARANCE AND ODOR:	liquid in aerosol, clear, sweet/fruity odor.

## 3. FIRE AND EXPLOSION HAZARD DATA

FLASH POINT:.....	-50.00 F T.C.C.
Propellant	
FLAMMABLE LIMITS - LEL: .....	N/A
FLAMMABLE LIMITS - UEL: .....	Flamm. Gas

Abbreviations: N/D - Not Determined N/A - Not Applicable

3M General Offices

3M Center  
St. Paul, MN 55144-1000  
612 733 111004-35  
6827MATERIAL SAFETY  
DATA SHEETMSDS: Catalog 6065 Spray-Mount (TM) Artist Adhesive  
AUGUST 28, 1996

PAGE: 2 of 5

---

**3. FIRE AND EXPLOSION HAZARD DATA (continued)**

---

AUTOIGNITION TEMPERATURE: ... N/D

## EXTINGUISHING MEDIA:

Carbon dioxide, Dry chemical, Foam

## SPECIAL FIRE FIGHTING PROCEDURES:

Wear full protective clothing, including helmet, self-contained, positive pressure or pressure demand breathing apparatus, bunker coat and pants, bands around arms, waist and legs, face mask, and protective covering for exposed areas of the head.

## UNUSUAL FIRE AND EXPLOSION HAZARDS:

Closed containers exposed to heat from fire may build pressure and explode. Vapors may travel long distances along the ground or floor to an ignition source and flash back.

NFPA HAZARD CODES: HEALTH: 2 FIRE: 4 REACTIVITY: 0 AEROSOL STORAGE: 3  
UNUSUAL REACTION HAZARD: none

---

**4. REACTIVITY DATA**

---

STABILITY: Stable

## INCOMPATIBILITY - MATERIALS TO AVOID:

Heat.

HAZARDOUS POLYMERIZATION: Will Not Occur

## HAZARDOUS DECOMPOSITION PRODUCTS:

Carbon Monoxide and Carbon Dioxide, Toxic Vapors, Gases or Particulates.

---

**5. ENVIRONMENTAL INFORMATION**

---

## SPILL RESPONSE:

Refer to other sections of this MSDS for information regarding physical and health hazards, respiratory protection, ventilation, and personal protective equipment. In the U.S.A., call (612) 733-1110 or (612) 733-6100 for 24-hour spill assistance. Ventilate area. Extinguish all ignition sources. Cover with absorbent material. Collect using non-sparking tools. Place in a U.S. DOT-approved container.

## RECOMMENDED DISPOSAL:

Incinerate in a permitted hazardous waste incinerator in the presence of a combustible material. Facility must be capable of handling aerosol cans. Dispose of empty cans in a sanitary landfill. Dispose of waste product in a facility permitted to accept chemical waste.

RECYCLE EMPTY AEROSOL CONTAINERS WHERE AVAILABLE.

## ENVIRONMENTAL DATA:

Not determined.

## REGULATORY INFORMATION:

Volatile Organic Compounds: ca. 81.6 % calculated per SCAQMD rule 443.1.

Volatile Organic Compounds: ca. 522 gms/liter calculated per SCAQMD

Abbreviations: N/D - Not Determined N/A - Not Applicable



3M General Offices

3M Center  
St. Paul, MN 55144-1000  
612 733 111004-35  
6828MATERIAL SAFETY  
DATA SHEET**3M**MSDS: Catalog 6068 Spray-Mount (TM) Artist Adhesive  
AUGUST 28, 1996

PAGE: 3 of 5

**5. ENVIRONMENTAL INFORMATION (continued)**

rule 443.1.  
Volatile Organic Compounds: ca. 4.36 lb/gal calculated per SCAQMD  
rule 443.1.  
VOC Less H<sub>2</sub>O & Exempt Solvents: ca. 563 gms/liter calculated per  
SCAQMD rule 443.1.

Since regulations vary, consult applicable regulations or authorities  
before disposal. U.S. EPA Hazardous Waste Number = D001 (Ignitable)

**EPCRA HAZARD CLASS:****FIRE HAZARD: Yes PRESSURE: Yes REACTIVITY: No ACUTE: Yes CHRONIC: Yes****6. SUGGESTED FIRST AID****EYE CONTACT:**

Immediately flush eyes with large amounts of water. Get immediate  
medical attention.

**SKIN CONTACT:**

Flush skin with large amounts of water. If irritation persists, get  
medical attention.

**INHALATION:**

Remove person to fresh air. If not breathing, give artificial  
respiration. If breathing is difficult, get immediate medical  
attention.

**IF SWALLOWED:**

Do not induce vomiting. Drink two glasses of water. Call a physician.

**7. PRECAUTIONARY INFORMATION****EYE PROTECTION:**

Avoid eye contact with vapor, spray, or mist. Wear safety glasses  
with side shields.

**SKIN PROTECTION:**

Avoid prolonged or repeated skin contact.

**VENTILATION PROTECTION:**

Do not use in a confined area or areas with little or no air  
movement. If exhaust ventilation is not adequate, use appropriate  
respiratory protection. Provide ventilation adequate to control vapor  
concentrations below recommended exposure limits and/or control spray  
or mist.

**RESPIRATORY PROTECTION:**

Avoid breathing of vapors, mists or spray. Select one of the  
following NIOSH approved respirators based on airborne concentration  
of contaminants and in accordance with OSHA regulations: half-mask  
organic vapor respirator.

Abbreviations: N/D - Not Determined N/A - Not Applicable

3M General Offices

3M Center  
St. Paul, MN 55144-1000  
612 733 111004-35  
6830MATERIAL SAFETY  
DATA SHEETMSDS: Catalog 6068 Spray-Mount (TM) Artist Adhesive  
AUGUST 28, 1996

PAGE: 5 of 5

---

**B. HEALTH HAZARD DATA**

---

**EYE CONTACT:**

Moderate Eye Irritation: signs/symptoms can include redness, swelling, pain, tearing, and hazy vision.

**SKIN CONTACT:**

Mild Skin Irritation (after prolonged or repeated contact): signs/symptoms can include redness, swelling, and itching.

**INHALATION:**

Intentional concentration and inhalation may be harmful or fatal.

Central Nervous System Depression: signs/symptoms can include headache, dizziness, drowsiness, incoordination, slowed reaction time, slurred speech, giddiness and unconsciousness.

Irritation (upper respiratory): signs/symptoms can include soreness of the nose and throat, coughing and sneezing.

**IF SWALLOWED:**

Ingestion is not a likely route of exposure to this product.

WHILE THE FOLLOWING EFFECTS ARE ASSOCIATED WITH ONE OR MORE OF THE INDIVIDUAL INGREDIENTS IN THIS PRODUCT AND ARE REQUIRED TO BE INCLUDED ON THE MSDS BY THE U.S. OSHA HAZARD COMMUNICATION STANDARD, THEY ARE NOT EXPECTED EFFECTS DURING FORESEEABLE USE OF THIS PRODUCT.

Ingestion may cause:

Irritation of Gastrointestinal Tissues: signs/symptoms can include pain, vomiting, abdominal tenderness, nausea, blood in vomitus, and blood in faces.

---

**SECTION CHANGE DATES**

---

HEADING

SECTION CHANGED SINCE JUNE 24, 1996 ISSUE

---

Abbreviations: N/D - Not Determined N/A - Not Applicable

---

The information in this Material Safety Data Sheet (MSDS) is believed to be correct as of the date issued. 3M MAKES NO WARRANTIES, EXPRESSED OR IMPLIED, INCLUDING, BUT NOT LIMITED TO, ANY IMPLIED WARRANTY OF MERCHANTABILITY OR FITNESS FOR A PARTICULAR PURPOSE OR COURSE OF PERFORMANCE OR USAGE OF TRADE. User is responsible for determining whether the 3M product is fit for a particular purpose and suitable for user's method of use or application. Given the variety of factors that can affect the use and application of a 3M product, some of which are uniquely within the user's knowledge and control, it is essential that the user evaluate the 3M product to determine whether it is fit for a particular purpose and suitable for user's method of use or application.

3M provides information in electronic form as a service to its customers. Due to the remote possibility that electronic transfer may have resulted in errors, omissions or alterations in this information, 3M makes no representations as to its completeness or accuracy. In addition, information obtained from a database may not be as current as the information in the MSDS available directly from 3M.

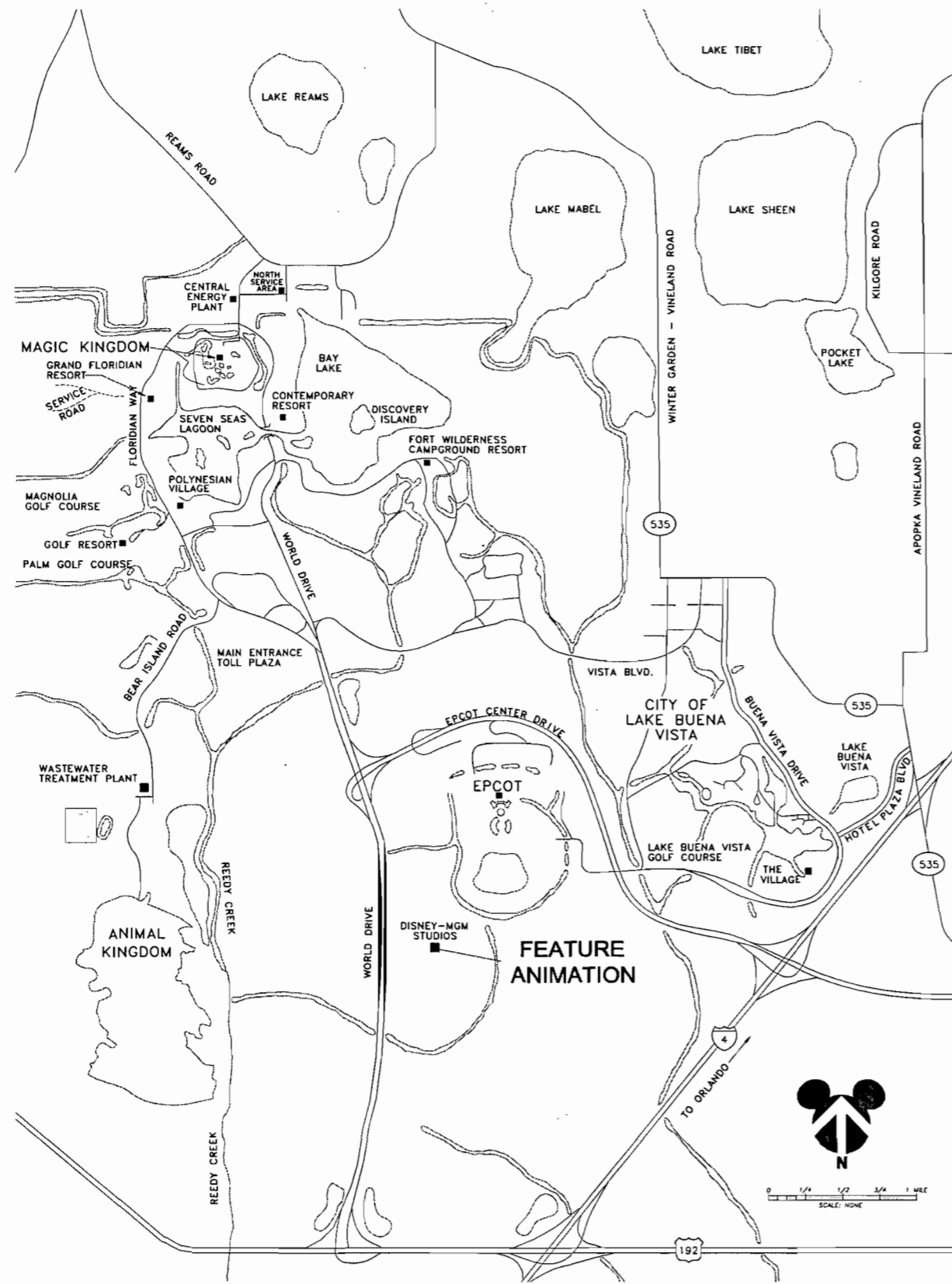

SITE LOCATION MAP

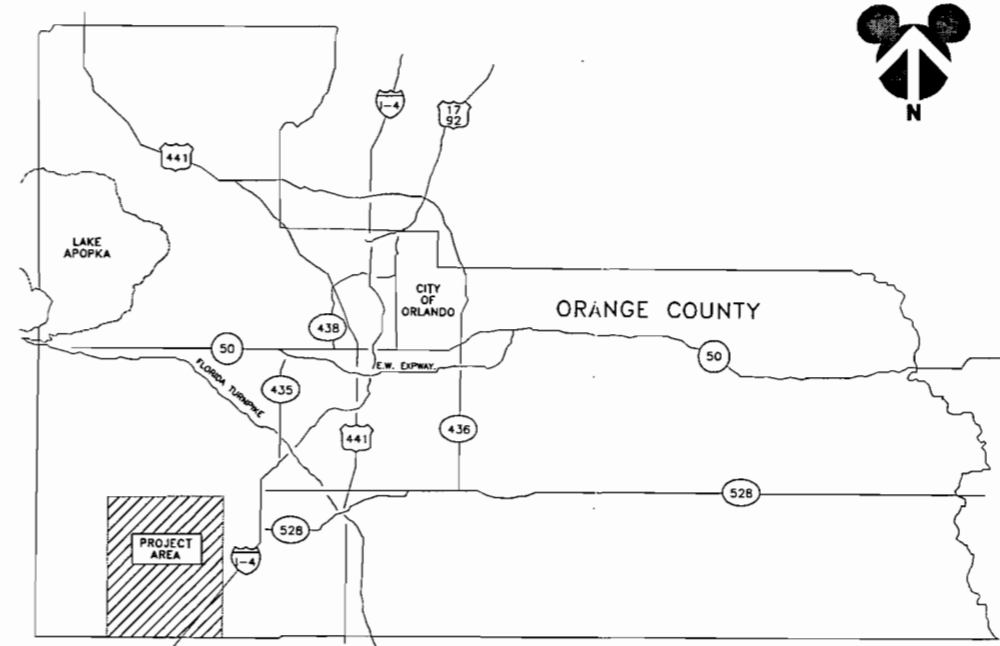

VICINITY MAP

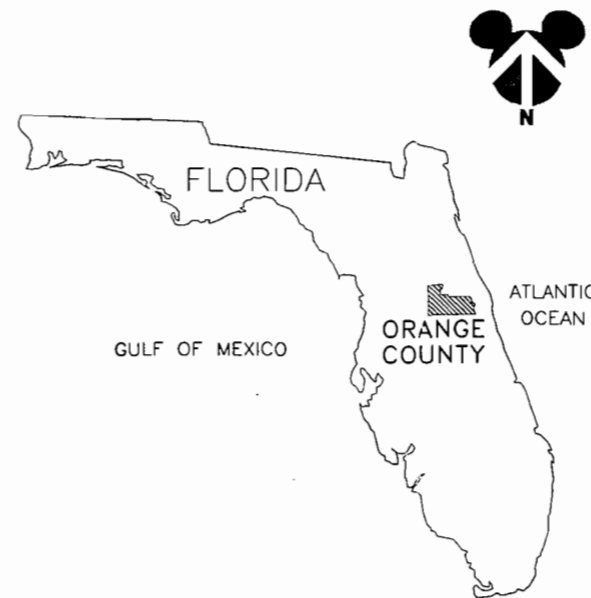

LOCATION MAP

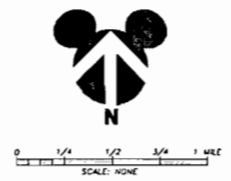

**ATTACHMENT B**  
**AREA MAP SHOWING FACILITY LOCATIONS**  
**DISNEY-MGM STUDIOS FEATURE ANIMATION SPRAY BOOTHS**



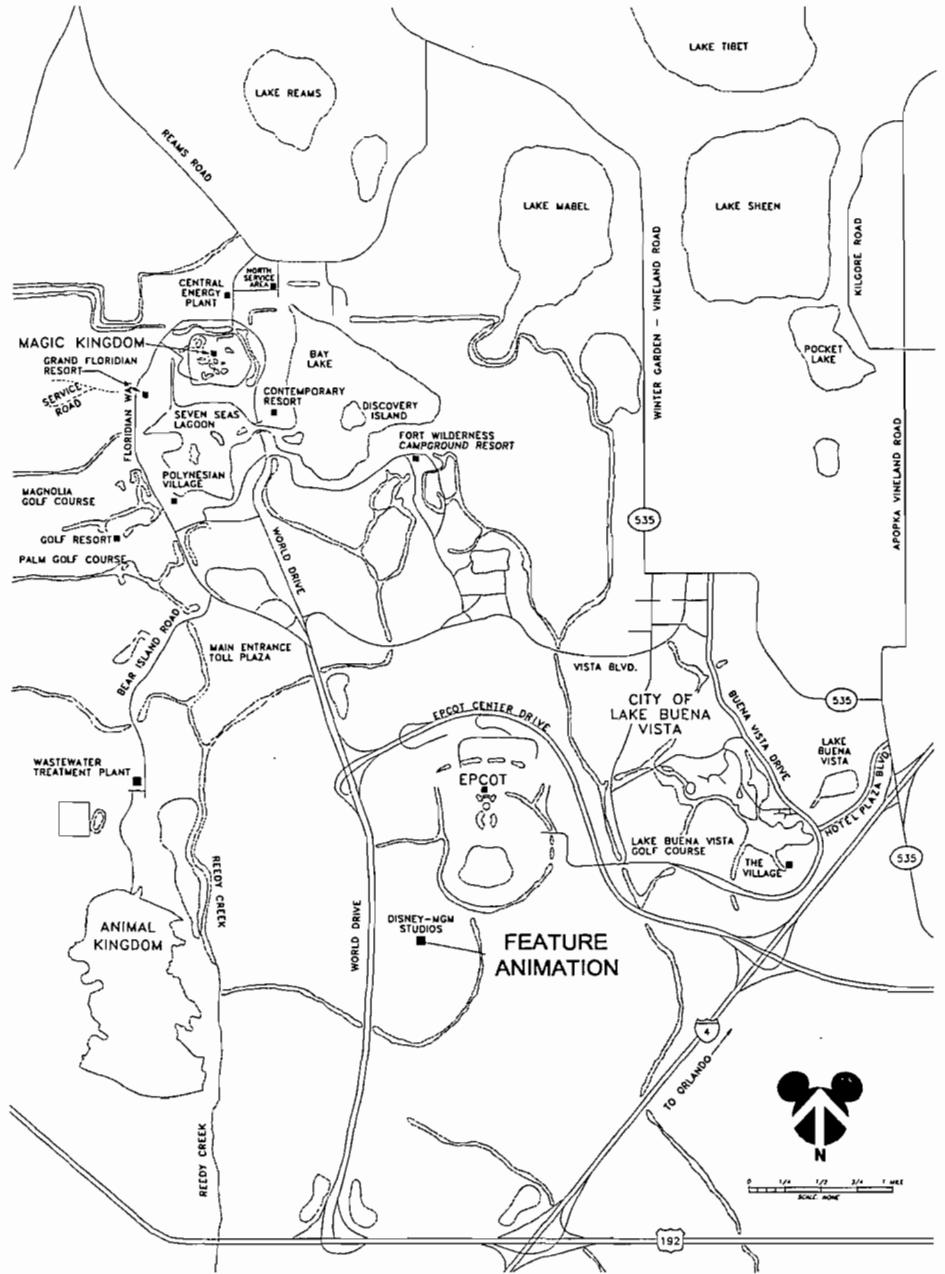

SITE LOCATION MAP

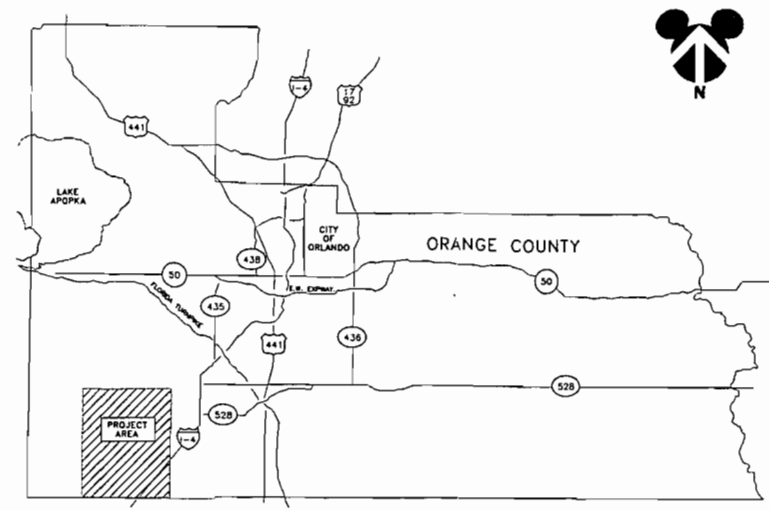

VICINITY MAP



LOCATION MAP

ATTACHMENT B  
 AREA MAP SHOWING FACILITY LOCATIONS  
 DISNEY-MGM STUDIOS FEATURE ANIMATION SPRAY BOOTHS



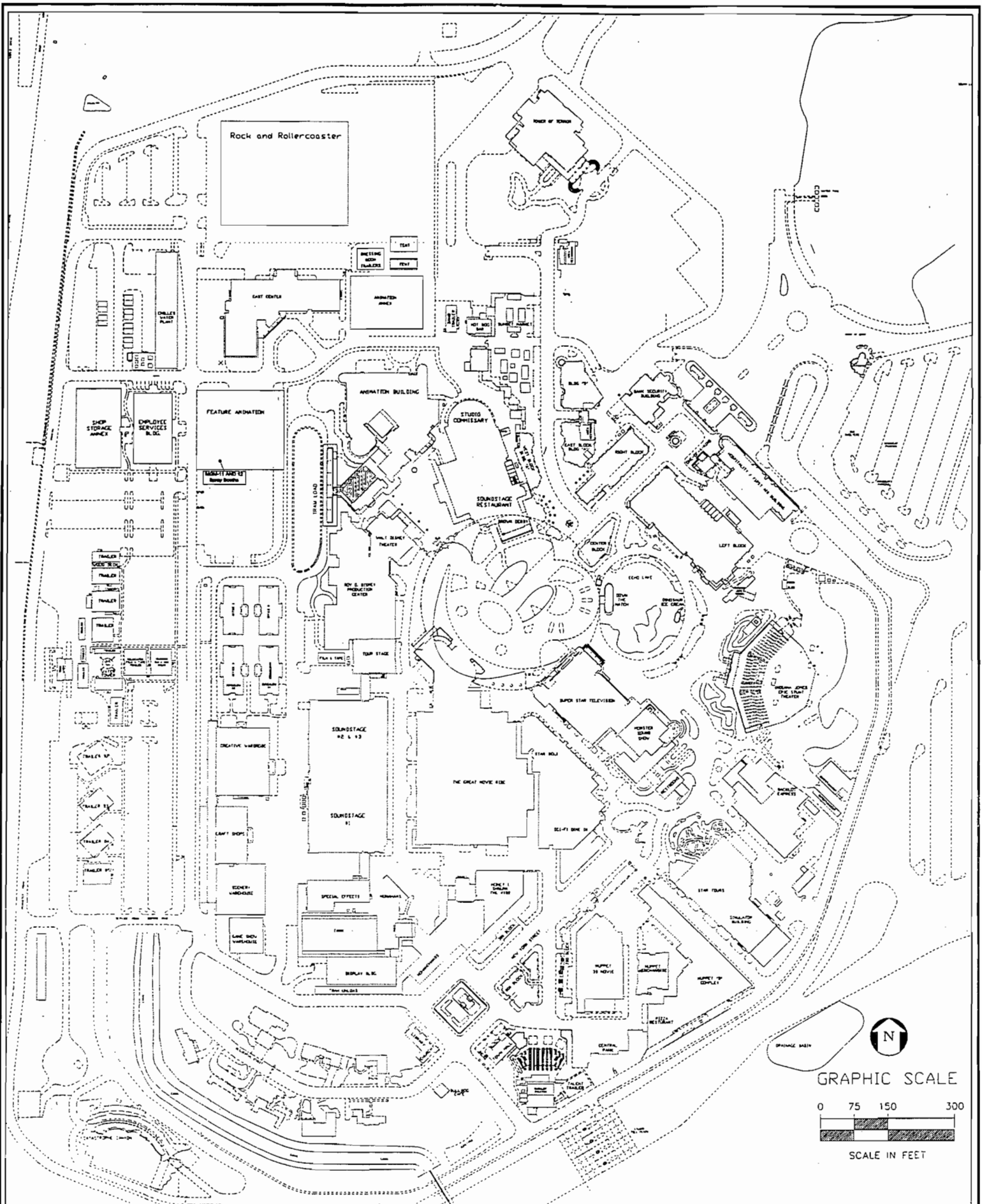

ATTACHMENT C  
 FACILITY PLOT PLAN  
 DISNEY-MGM STUDIOS FEATURE ANIMATION SPRAY BOOTHS