

RECEIVED
DER - MAIL ROOM
1991 MAR 19 AM 8 16

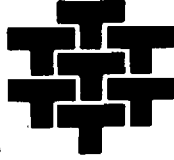

Tarmac

TARMAC FLORIDA, INC.

P.O. Box 2998
Hialeah, Florida 33012

14 March 1991

Mr. Clair Fancy, P.E.
Division of Air Resources Management
Florida Department of Environmental
Regulation
2600 Blair Stone Road
Tallahassee, Florida 32399-2400

RE: Pennsuco Cement & Supply
DER Permit No. AO13-157297
Application For Modification - Kiln 3

Dear Mr. Fancy:

Please find enclosed four (4) copies of an *Application To Operate/Construct Air Pollution Sources* for the facility referenced above. The application is to allow Tarmac the use of waste tires as fuel and to burn petroleum-contaminated soils in Kiln 3. A check in the amount of \$500.00 is enclosed for the permit processing fee.

Tarmac again looks forward to working with you and your staff on the review of this application. Please do not hesitate to contact myself or Mr. Dave Buff, with KBN Engineering, regarding any questions or further information you may need. The telephone number is (305)823-8800.

Sincerely,

Scott Quaas
Environmental Specialist

cc: A. Townsend
D. Buff - KBN Engineering
S. Brooks - FDER, W. Palm Beach

001031



TARMAC FLORIDA, INC.

P.O. BOX 8648, DEERFIELD BEACH, 33443

CHECK NO. [REDACTED]

NCNB NATIONAL BANK, ASHEVILLE, NORTH CAROLINA

FIVE HUNDRED DOLLARS NO CENTS

PAY TO THE ORDER OF

DATE

CHECK AMOUNT

**FLA DEPT OF ENVIRONMENTAL
REGULATION**

2-22-91

500.00

James R. Mason



Regulation
2600 Blair Stone Road
Tallahassee, Florida 32399-2400

RE: Pennsuco Cement & Supply
DER Permit No. AO13-157297
Application For Modification - Kiln 3

Dear Mr. Fancy:

Please find enclosed four (4) copies of an *Application To Operate/Construct Air Pollution Sources* for the facility referenced above. The application is to allow Tarmac the use of waste tires as fuel and to burn petroleum-contaminated soils in Kiln 3. A check in the amount of \$500.00 is enclosed for the permit processing fee.

Tarmac again looks forward to working with you and your staff on the review of this application. Please do not hesitate to contact myself or Mr. Dave Buff, with KBN Engineering, regarding any questions or further information you may need. The telephone number is (305)823-8800.

Sincerely,

Scott Quaas
Environmental Specialist

cc: A. Townsend
D. Buff - KBN Engineering
S. Brooks - FDER, W. Palm Beach

001031

**APPLICATION TO BURN
WASTE TIRES AND
CONTAMINATED SOILS
KILN 3
TARMAC FLORIDA, INC.**

Prepared For:

**Tarmac Florida, Inc.
P.O. Box 2998
Hialeah, FL 33012**

Prepared By:

**KBN Engineering and Applied Sciences, Inc.
1034 NW 57th Street
Gainesville, FL 32605**

**December 1990
90086A1/APS1**

\$500 pd. 3-19-91
\$500 pd. 4-19-91

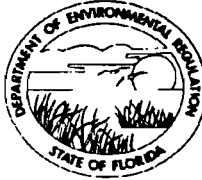

AC 13-194142
PSD-FL-175

APPLICATION TO OPERATE/CONSTRUCT AIR POLLUTION SOURCES

SOURCE TYPE: Portland Cement Plant [] New¹ [X] Existing¹
APPLICATION TYPE: [] Construction [] Operation [X] Modification
COMPANY NAME: Tarmac Florida, Inc. COUNTY: Dade

Identify the specific emission point source(s) addressed in this application (i.e., Lime Kiln No. 4 with Venturi Scrubber; Peaking Unit No. 2, Gas Fired) Kiln 3

SOURCE LOCATION: Street 11000 Northwest 121 Way City Medley

UTM: East Zone 17; 562.8 km North 2861.7 km

Latitude 25 ° 52 ' 30 "N Longitude 80 ° 22 ' 30 "W

APPLICANT NAME AND TITLE: Mr. Scott Quaas, Environmental Specialist

APPLICANT ADDRESS: P.O. Box 2998, Hialeah, FL 33012

SECTION I: STATEMENTS BY APPLICANT AND ENGINEER

A. APPLICANT

I am the undersigned owner or authorized representative* of Tarmac Florida, Inc.

I certify that the statements made in this application for a construction permit are true, correct and complete to the best of my knowledge and belief. Further, I agree to maintain and operate the pollution control source and pollution control facilities in such a manner as to comply with the provision of Chapter 403, Florida Statutes, and all the rules and regulations of the department and revisions thereof. I also understand that a permit, if granted by the department, will be non-transferable and I will promptly notify the department upon sale or legal transfer of the permitted establishment.

*Attach letter of authorization

Signed: [Signature]

Scott Quaas, Environmental Specialist
Name and Title (Please Type)

Date: 14 MAR 1991 Telephone No. (305) 823-8800

B. PROFESSIONAL ENGINEER REGISTERED IN FLORIDA (where required by Chapter 471, F.S.)

This is to certify that the engineering features of this pollution control project have been designed/examined by me and found to be in conformity with modern engineering principles applicable to the treatment and disposal of pollutants characterized in the permit application. There is reasonable assurance, in my professional judgement, that

¹See Florida Administration Code Rule 17-2.100(57) and (104)

the pollution control facilities, when properly maintained and operated, will discharge an effluent that complies with all applicable statutes of the State of Florida and the rules and regulations of the department. It is also agreed that the undersigned will furnish, if authorized by the owner, the applicant a set of instructions for the proper maintenance and operation of the pollution control facilities and, if applicable, pollution sources.

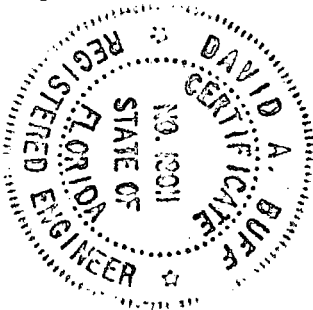

Signed David A. Buff
David A. Buff

Name (Please Type)

KBN Engineering and Applied Sciences, Inc.
Company Name (Please Type)

1034 NW 57th Street, Gainesville, FL 32605
Mailing Address (Please Type)

Florida Registration No. 19011 Date: Dec. 17, 1990 Telephone No. (904) 331-9000

SECTION II: GENERAL PROJECT INFORMATION

A. Describe the nature and extent of the project. Refer to pollution control equipment, and expected improvements in source performance as a result of installation. State whether the project will result in full compliance. Attach additional sheet if necessary.

See Attachment A

B. Schedule of project covered in this application (Construction Permit Application Only)
Start of Construction upon permit issuance Completion of Construction 180 days after permit issuance

C. Costs of pollution control system(s): (Note: Show breakdown of estimated costs only for individual components/units of the project serving pollution control purposes. Information on actual costs shall be furnished with the application for operation permit.)

N/A--all pollution control equipment is already in place

D. Indicate any previous DER permits, orders and notices associated with the emission point, including permit issuance and expiration dates.

A013-157297 Issued 02/09/89 Expires 11/15/93

E. Requested permitted equipment operating time: hrs/day 24; days/wk 7; wks/yr 52;
If power plant, hrs/yr _____; if seasonal, describe: _____

F. If this is a new source or major modification, answer the following questions.
(Yes or No)

1. Is this source in a non-attainment area for a particular pollutant? Yes
 - a. If yes, has "offset" been applied? No
 - b. If yes, has "Lowest Achievable Emission Rate" been applied? No
 - c. If yes, list non-attainment pollutants. Ozone
2. Does best available control technology (BACT) apply to this source?
If yes, see Section VI. Yes
3. Does the State "Prevention of Significant Deterioration" (PSD)
requirement apply to this source? If yes, see Sections VI and VII. Yes
4. Do "Standards of Performance for New Stationary Sources" (NSPS)
apply to this source? Yes
5. Do "National Emission Standards for Hazardous Air Pollutants"
(NESHAP) apply to this source? No

- H. Do "Reasonably Available Control Technology" (RACT) requirements apply
to this source? No
- a. If yes, for what pollutants? _____
 - b. If yes, in addition to the information required in this form, any information
requested in Rule 17-2.650 must be submitted.

Attach all supportive information related to any answer of "Yes". Attach any
justification for any answer of "No" that might be considered questionable.

SECTION III: AIR POLLUTION SOURCES & CONTROL DEVICES (Other than Incinerators)

A. Raw Materials and Chemicals Used in your Process, if applicable:

Description	Contaminants		Utilization Rate - lbs/hr	Relate to Flow Diagram
	Type	% Wt		
Limestone*	Particulate	100	249,920	
Ash/Mineral	Particulate	100	34,080	
Aggregate				

*Can include up to 14,200 lb/hr of contaminated soils (5%).

B. Process Rate, if applicable: (See Section V, Item 1)

1. Total Process Input Rate (lbs/hr): 284,000 lb/hr (142.0 tons/hr) feed, dry
2. Product Weight (lbs/hr): 175,000 lb/hr (87.5 tons/hr) clinker production, dry

C. Airborne Contaminants Emitted: (Information in this table must be submitted for each emission point, use additional sheets as necessary)

Name of Contaminant	Emission ¹		Allowed ² Emission Rate per Rule 17-2	Allowable ³ Emission lbs/hr	Potential ⁴ Emission		Relate to Flow Diagram
	Maximum lbs/hr	Actual T/yr			lbs/hr	T/yr	
See Attachment A							

¹See Section V, Item 2.

²Reference applicable emission standards and units (e.g. Rule 17-2.600(5)(b)2. Table II, E. (1) - 0.1 pounds per million BTU heat input)

³Calculated from operating rate and applicable standard.

⁴Emission, if source operated without control (See Section V, Item 3).

D. Control Devices: (See Section V, Item 4)

Name and Type (Model & Serial No.)	Contaminant	Efficiency	Range of Particles Size Collected (in microns) (If applicable)	Basis for Efficiency (Section V Item 5)
Koppers Electrostatic Precipitator, Model No. 370672-75	Particulate	99.97%	0.1-80	Stack tests

E. Fuels

Type (Be Specific)	Consumption*		Maximum Heat Input (MMBTU/hr)
	avg/hr	max./hr	
Coal	40,000 lb/hr	46,000 lb/hr	552
No. 6 Fuel Oil	3,310 gal/hr	3,807 gal/hr	552
Natural gas	0.46 MMscf/hr	0.53 MMscf/hr	552
Waste Tires	3,250 lb/hr	10,640 lb/hr	8.85

*Units: Natural Gas--MMCF/hr; Fuel Oils--gallons/hr; Coal, wood, refuse, others--lbs/hr.

Fuel Analysis: Coal/No. 6 Oil/(Waste Tires--refer to Attachment A)

Percent Sulfur: 2.0 (max) / 2.5 (max) Percent Ash: 9 / 1

Density: N/A / 8.3 lbs/gal Typical Percent Nitrogen: 1.5 / 1

Heat Capacity: 12,000 / 17,400 BTU/lb N/A / 145,000 BTU/gal

Other Fuel Contaminants (which may cause air pollution): _____

F. If applicable, indicate the percent of fuel used for space heating.

Annual Average N/A Maximum _____

G. Indicate liquid or solid wastes generated and method of disposal.

A portion of the captured dust from ESP is returned to the kiln, while the remainder is stored in an on-site disposal area and then removed as fill to off-site locations.

H. Emission Stack Geometry and Flow Characteristics (Provide data for each stack):

Stack Height: 200 ft. Stack Diameter: 15.0 ft.
 Gas Flow Rate: 384,000 ACFM 190,000 DSCFM Gas Exit Temperature: 350 °F.
 Water Vapor Content: 24 % Velocity: 36.2 FPS

SECTION IV: INCINERATOR INFORMATION
 Not Applicable

Type of Waste	Type 0 (Plastics)	Type II (Rubbish)	Type III (Refuse)	Type IV (Garbage)	Type IV (Pathological)	Type V (Liq. & Gas By-prod.)	Type VI (Solid By-prod.)
Actual lb/hr Incinerated							
Uncontrolled (lbs/hr)							

Description of Waste _____
 Total Weight Incinerated (lbs/hr) _____ Design Capacity (lbs/hr) _____
 Approximate Number of Hours of Operation per day _____ day/wk _____ wks/yr. _____
 Manufacturer _____
 Date Constructed _____ Model No. _____

	Volume (ft) ³	Heat Release (BTU/hr)	Fuel		Temperature (°F)
			Type	BTU/hr	
Primary Chamber					
Secondary Chamber					

Stack Height: _____ ft. Stack Diameter: _____ Stack Temp. _____
 Gas Flow Rate: _____ ACFM _____ DSCFM* Velocity: _____ FPS

*If 50 or more tons per day design capacity, submit the emissions rate in grains per standard cubic foot dry gas corrected to 50% excess air.

Type of pollution control devices: Cyclone Wet Scrubber Afterburner
 Other
 (specify) _____

Brief description of operating characteristics of control devices: _____

Ultimate disposal of any effluent other than that emitted from the stack (scrubber water, ash, etc.):

NOTE: Items 2, 3, 4, 6, 7, 8, and 10 in Section V must be included where applicable.

SECTION V: SUPPLEMENTAL REQUIREMENTS

Please provide the following supplements where required for this application.

1. Total process input rate and product weight -- show derivation [Rule 17-2.100(127)]
2. To a construction application, attach basis of emission estimate (e.g., design calculations, design drawings, pertinent manufacturer's test data, etc.) and attach proposed methods (e.g., FR Part 60 Methods, 1, 2, 3, 4, 5) to show proof of compliance with applicable standards. To an operation application, attach test results or methods used to show proof of compliance. Information provided when applying for an operation permit from a construction permit shall be indicative of the time at which the test was made.
3. Attach basis of potential discharge (e.g., emission factor, that is, AP42 test).
4. With construction permit application, include design details for all air pollution control systems (e.g., for baghouse include cloth to air ratio; for scrubber include cross-section sketch, design pressure drop, etc.)
5. With construction permit application, attach derivation of control device(s) efficiency. Include test or design data. Items 2, 3 and 5 should be consistent: actual emissions = potential (1-efficiency).
6. An 8 1/2" x 11" flow diagram which will, without revealing trade secrets, identify the individual operations and/or processes. Indicate where raw materials enter, where solid and liquid waste exit, where gaseous emissions and/or airborne particles are evolved and where finished products are obtained.
7. An 8 1/2" x 11" plot plan showing the location of the establishment, and points of airborne emissions, in relation to the surrounding area, residences and other permanent structures and roadways (Examples: Copy of relevant portion of USGS topographic map).
8. An 8 1/2" x 11" plot plan of facility showing the location of manufacturing processes and outlets for airborne emissions. Relate all flows to the flow diagram.

- 9. The appropriate application fee in accordance with Rule 17-4.05. The check should be made payable to the Department of Environmental Regulation.
- 10. With an application for operation permit, attach a Certificate of Completion of Construction indicating that the source was constructed as shown in the construction permit.

SECTION VI: BEST AVAILABLE CONTROL TECHNOLOGY

Refer to Attachment A

- A. Are standards of performance for new stationary sources pursuant to 40 C.F.R. Part 60 applicable to the source?

[] Yes [] No

Contaminant	Rate or Concentration
_____	_____
_____	_____
_____	_____

- B. Has EPA declared the best available control technology for this class of sources (If yes, attach copy)

[] Yes [] No

Contaminant	Rate or Concentration
_____	_____
_____	_____
_____	_____

- C. What emission levels do you propose as best available control technology?

Contaminant	Rate or Concentration
_____	_____
_____	_____
_____	_____

- D. Describe the existing control and treatment technology (if any).

- | | |
|---------------------------|--------------------------|
| 1. Control Device/System: | 2. Operating Principles: |
| 3. Efficiency:* | 4. Capital Costs: |

*Explain method of determining

5. Useful Life:

6. Operating Costs:

7. Energy:

8. Maintenance Cost:

9. Emissions:

Contaminant	Rate or Concentration

10. Stack Parameters

- | | | | |
|---------------|------|-----------------|-----|
| a. Height: | ft. | b. Diameter | ft. |
| c. Flow Rate: | ACFM | d. Temperature: | °F. |
| e. Velocity: | FPS | | |

E. Describe the control and treatment technology available (As many types as applicable, use additional pages if necessary).

1.

- | | |
|--|--------------------------|
| a. Control Devices: | b. Operating Principles: |
| c. Efficiency: ¹ | d. Capital Cost: |
| e. Useful Life: | f. Operating Cost: |
| g. Energy: ² | h. Maintenance Cost: |
| i. Availability of construction materials and process chemicals: | |
| j. Applicability to manufacturing processes: | |
| k. Ability to construct with control device, install in available space, and operate within proposed levels: | |

2.

- | | |
|--|--------------------------|
| a. Control Device: | b. Operating Principles: |
| c. Efficiency: ¹ | d. Capital Cost: |
| e. Useful Life: | f. Operating Cost: |
| g. Energy: ² | h. Maintenance Cost: |
| i. Availability of construction materials and process chemicals: | |

¹Explain method of determining efficiency.

²Energy to be reported in units of electrical power - KWH design rate.

- j. Applicability to manufacturing processes:
- k. Ability to construct with control device, install in available space, and operate within proposed levels:

3.

- a. Control Device:
- b. Operating Principles:
- c. Efficiency:¹
- d. Capital Cost:
- e. Useful Life:
- f. Operating Cost:
- g. Energy:²
- h. Maintenance Cost:
- i. Availability of construction materials and process chemicals:
- j. Applicability to manufacturing processes:
- k. Ability to construct with control device, install in available space, and operate within proposed levels:

4.

- a. Control Device:
- b. Operating Principles:
- c. Efficiency:¹
- d. Capital Cost:
- e. Useful Life:
- f. Operating Cost:
- g. Energy:²
- h. Maintenance Cost:
- i. Availability of construction materials and process chemicals:
- j. Applicability to manufacturing processes:
- k. Ability to construct with control device, install in available space, and operate within proposed levels:

F. Describe the control technology selected:

- 1. Control Device:
- 2. Efficiency:¹
- 3. Capital Cost:
- 4. Useful Life:
- 5. Operating Cost:
- 6. Energy:²
- 7. Maintenance Cost:
- 8. Manufacturer:
- 9. Other locations where employed on similar processes:
 - a. (1) Company:
 - (2) Mailing Address:
 - (3) City:
 - (4) State:

¹Explain method of determining efficiency.

²Energy to be reported in units of electrical power - KWH design rate.

(5) Environmental Manager:

(6) Telephone No.:

(7) Emissions:¹

Contaminant	Rate or Concentration

(8) Process Rate:¹

b. (1) Company:

(2) Mailing Address:

(3) City:

(4) State:

(5) Environmental Manager:

(6) Telephone No.:

(7) Emissions:¹

Contaminant	Rate or Concentration

(8) Process Rate:¹

10. Reason for selection and description of systems:

¹Applicant must provide this information when available. Should this information not be available, applicant must state the reason(s) why.

SECTION VII - PREVENTION OF SIGNIFICANT DETERIORATION
Refer to Attachment A

A. Company Monitored Data

1. _____ no. sites _____ TSP _____ () SO²* _____ Wind spd/dir

Period of Monitoring _____ / _____ / _____ to _____ / _____ / _____
month day year month
day year

Other data recorded _____

Attach all data or statistical summaries to this application.

*Specify bubbler (B) or continuous (C).

2. Instrumentation, Field and Laboratory

a. Was instrumentation EPA referenced or its equivalent? [] Yes [] No

b. Was instrumentation calibrated in accordance with Department procedures?
[] Yes [] No [] Unknown

B. Meteorological Data Used for Air Quality Modeling

1. _____ Year(s) of data from _____ / _____ / _____ to _____ / _____ / _____
month day year month day year

2. Surface data obtained from (location) _____

3. Upper air (mixing height) data obtained from (location) _____

4. Stability wind rose (STAR) data obtained from (location) _____

C. Computer Models Used

1. _____ Modified? If yes, attach description.

2. _____ Modified? If yes, attach description.

3. _____ Modified? If yes, attach description.

4. _____ Modified? If yes, attach description.

Attach copies of all final model runs showing input data, receptor locations, and principle output tables.

D. Applicants Maximum Allowable Emission Data

Pollutant	Emission Rate
TSP	_____ grams/sec
SO ²	_____ grams/sec

E. Emission Data Used in Modeling

Attach list of emission sources. Emission data required is source name, description of point source (on NEDS point number), UTM coordinates, stack data, allowable emissions, and normal operating time.

F. Attach all other information supportive to the PSD review.

G. Discuss the social and economic impact of the selected technology versus other applicable technologies (i.e, jobs, payroll, production, taxes, energy, etc.). Include assessment of the environmental impact of the sources.

H. Attach scientific, engineering, and technical material, reports, publications, journals, and other competent relevant information describing the theory and application of the requested best available control technology.

ATTACHMENT A

ATTACHMENT A

1.0 PROJECT DESCRIPTION

Tarmac Florida, Inc., leases and operates a portland cement manufacturing plant in northwest Dade County. This location is just east of the Turnpike Extension and south of U.S. 27 (see Figure A-1). Currently, the Tarmac facility consists of three cement kilns that have operating permits issued by the Florida Department of Environmental Regulation (FDER) and the Dade County Environmental Resources Management (DERM). Kilns 1 and 2 each has a clinker production capacity of 25.0 tons per hour (TPH). Kiln 3 has a clinker production capacity of 87.5 TPH.

A plot plan of the Tarmac facility is presented in Figure A-2. A flow diagram of the wet process cement kiln at Tarmac is shown in Figure A-3.

Only Kiln 3 at Tarmac is currently operating. Kilns 1 and 2 have been shut down since the early 1980s due to economic conditions. In late 1989, Tarmac applied for a construction permit to convert Kiln 2 to coal firing. This permit application is still pending.

Kiln 3 presently burns eastern bituminous coal but is also permitted to burn No. 6 fuel oil and natural gas. Maximum allowable sulfur content of the coal is 2.0 percent, with a 1.75 percent limit on an average basis. Typical characteristics of eastern bituminous coal are presented in Table A-1.

Also located at the Tarmac facility is a fourth cement kiln with associated electrostatic precipitator (ESP). The fourth kiln has never been used. Recently, Tarmac ducted the exhaust gases from Kiln 3 to the Kiln 4 ESP. This ESP will be used in the future to control particulate emissions from Kiln 3. This arrangement is noted on the plot plan (Figure A-2).

Tarmac is proposing to burn waste tires and/or petroleum-contaminated soils in Kiln 3. A cement kiln is an excellent device for complete combustion of

Table A-1. Characteristics of Eastern Bituminous Coal and Tires

Parameter	Eastern Bituminous Coal	Tires
<u>Ultimate Analysis^a</u>		
Carbon	80.64	77.90
Hydrogen	4.50	7.44
Oxygen	2.40	2.24
Nitrogen	1.10	0.24
Sulfur	1.75 ^b	1.34
Chlorine	0.11	0.14
Ash	10.00	9.90
Moisture	7.50	0.80
	-----	-----
	100.00	100.00
Heating Value (HHV) ^a (Btu/lb)	12,500	15,800

Parameter	Eastern Bituminous Coal		Tires	
	ppm	lb/MM Btu	ppm	lb/MM Btu
<u>Trace Element Analysis</u>				
Arsenic	11	0.00088	0	0.00
Beryllium	1	0.000080	0	0.00
Chlorine	1,060	0.085	1,400	0.089
Fluoride	87	0.0070	0	0.00
Lead	6	0.00048	10	0.00063
Mercury	0.2	0.000016	0.1	0.0000063
Sulfur	17,500	1.40	13,400	0.85

^aPercent by weight, as received.

^bTarmac's maximum allowable annual average sulfur content.

Source: Shawmut Engineering, Inc., 1986.
EPA, 1980.
Tarmac Florida, Inc.

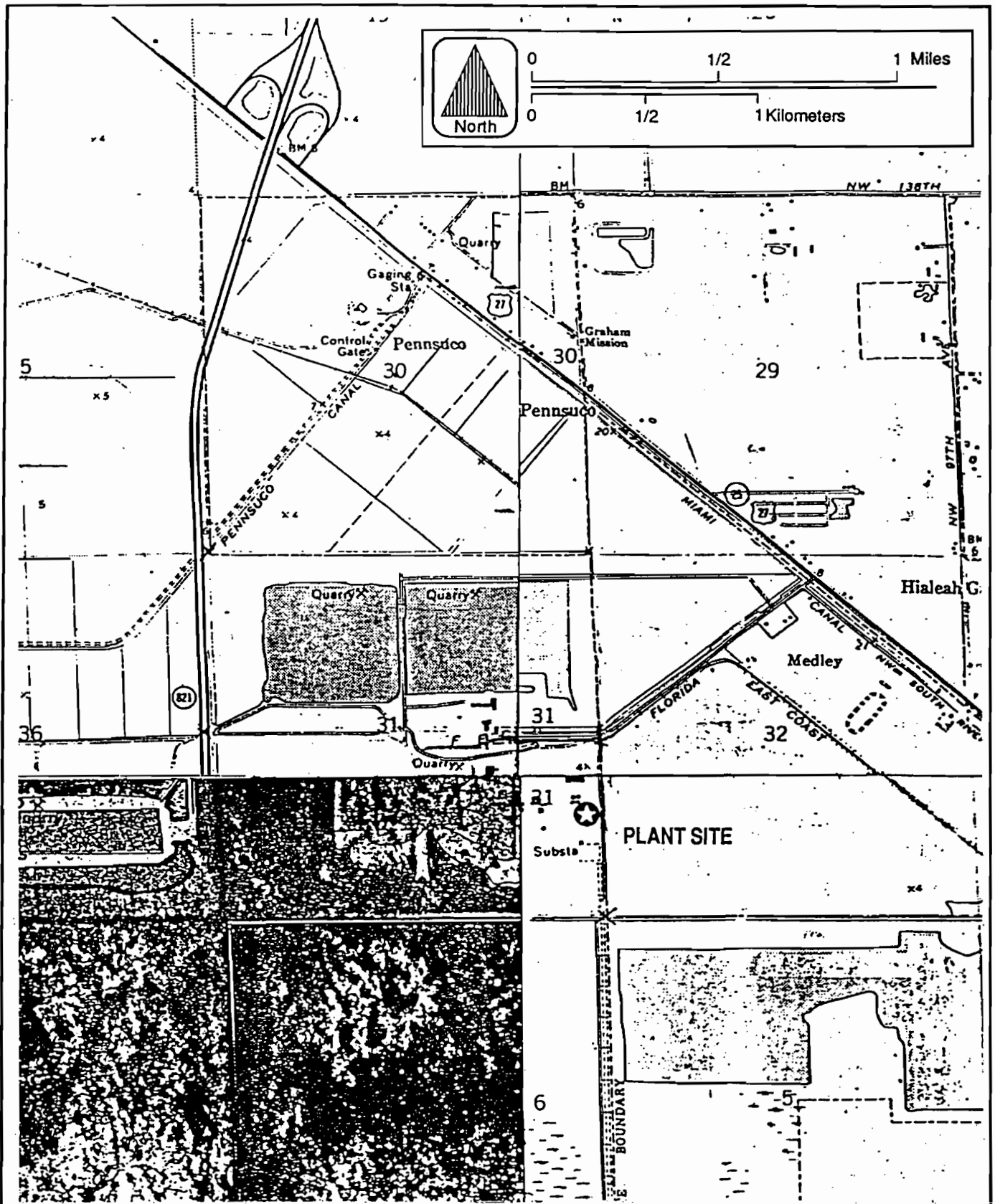

Figure A-1 LOCATION OF TARMAC FLORIDA FACILITY



A-4

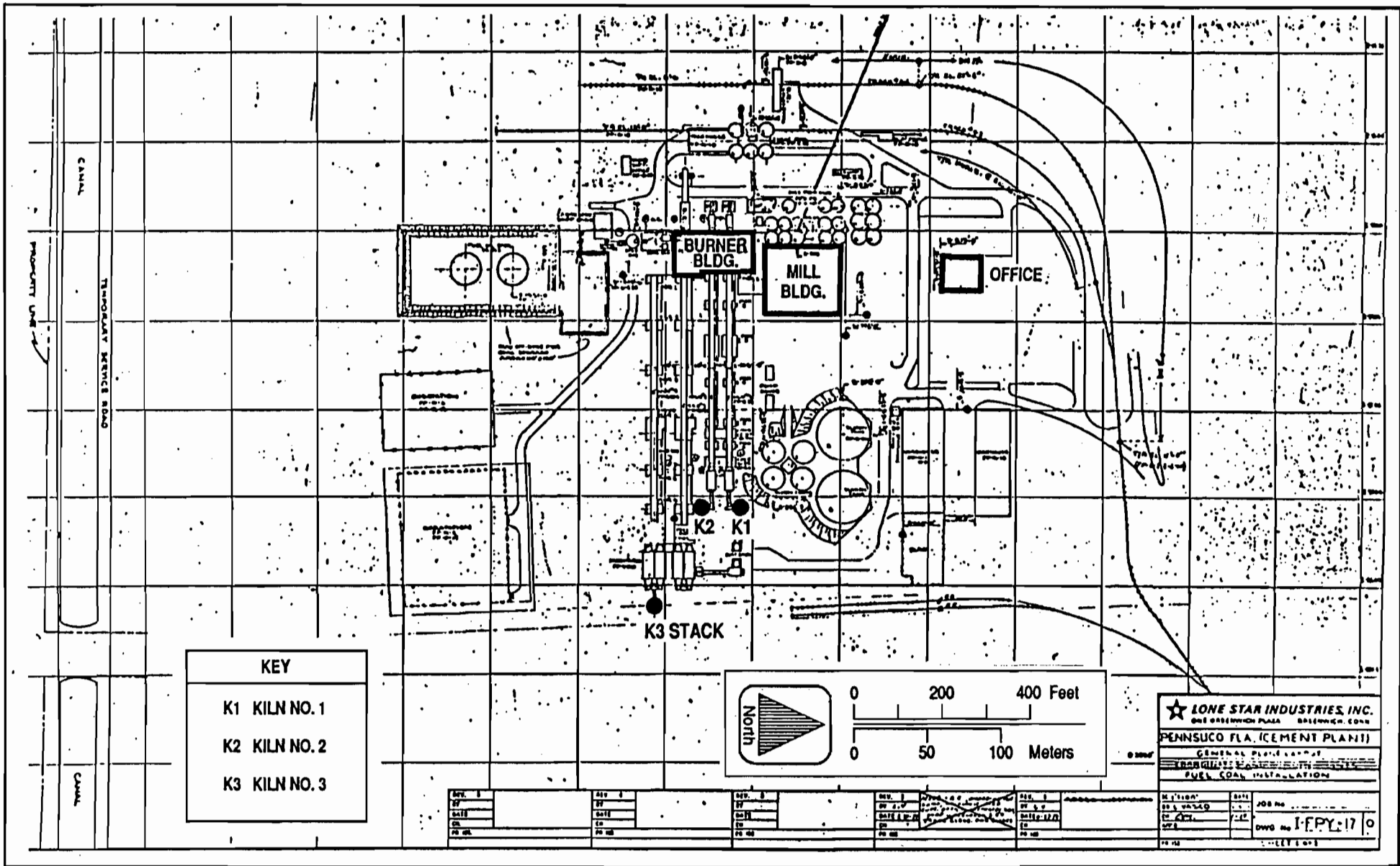
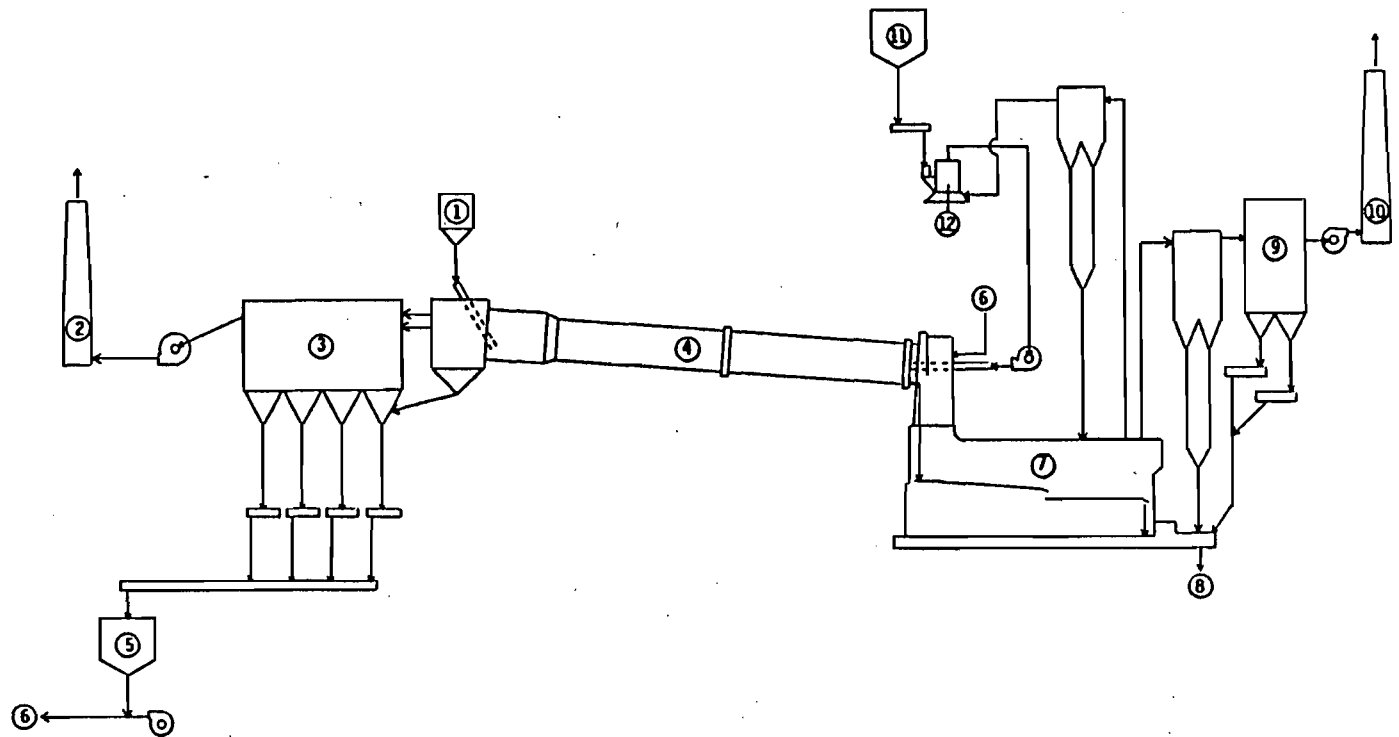

Figure A-2 PLOT PLAN OF TARMAC FACILITY



- [1] Kiln Feed
- [2] Kiln Stack
- [3] Kiln Precipitator
- [4] Kiln
- [5] Waste Dust Storage
- [6] Insufflated Dust
- [7] Clinker Cooler
- [8] Clinker
- [9] Cooler Precipitator
- [10] Cooler Stack
- [11] Coal Storage
- [12] Coal Mill



A-5

Figure A-3 FLOW DIAGRAM FOR KILN 3



these materials. The burning of waste tires in the kiln will reduce the amount of coal burned in the kiln, as well as reduce a significant waste disposal problem in this country. A comparison of the characteristics of eastern bituminous coal, which Tarmac burns in Kiln 3, and tires is presented in Table A-1. As indicated, tires have a higher heating value and lower sulfur content than coal. Tires also have a lower concentration of most trace elements. These qualities make tires attractive from both an economic and an environmental perspective.

The only physical modification necessary to Kiln 3 to allow the burning of tires will be the mechanism to introduce tires into the kiln. Tarmac plans to introduce the tires about mid-kiln. The tires will be introduced as whole, unprocessed tires. Tarmac will require suppliers to supply whole waste tires that are not excessively contaminated with dirt, water, or other foreign materials and do not have rims.

Tarmac desires to be permitted to allow up to 560 waste tires per hour to be burned in Kiln 3. Maximum annual waste tire consumption will be 4.5 million tires per year. Since the maximum heat input rate to the kiln is fixed based on the capacity of the kiln, coal consumption will be reduced on an equivalent Btu basis during the burning of the waste tires. However, Tarmac desires to maintain the flexibility of burning 100 percent coal for fuel, in case the tire-burning system is shut down or waste tires are not available.

The burning of petroleum-contaminated soils will not require any physical modifications to Kiln 3. The contaminated soils are essentially the same as the limestone in the raw feed currently introduced into the kiln. The contaminated soils brought to the cement plant will be blended with the cement raw feed materials. The raw feed is processed into a slurry and fed to the kiln.

Typically, Tarmac will receive shipments of approximately 200 tons of contaminated soil. The contaminated soils will be mixed with the raw feed

at a rate not to exceed 5 percent of the total kiln feed, or 7.1 TPH, which represents a small fraction of the 142.0 TPH kiln feed.

A typical analysis of the contaminated soils Tarmac will burn is presented in Attachment B. This analysis is from a trial burn Tarmac conducted in August 1988. The analysis shows lead, naphthalene, and other hydrocarbon compounds present, as expected. Benzene was not detected in the contaminated soil.

Contaminated soils are currently being burned at many cement plants across the United States. Cement kilns, because of their high temperature and long gas residence times, provide a high destruction and removal efficiency (DRE) for the hazardous constituents. Also, cement product quality is relatively insensitive to the addition of most waste impurities.

The U.S. Environmental Protection Agency (EPA), in a study published in 1988, evaluated the combustion of hazardous wastes in six cement kilns and one lime kiln (EPA, 1988). This study found that DREs for several different hydrocarbon and solvent wastes exceeded 99.95 percent in all cases, with DREs as high as 99.9999 percent achieved. Tarmac also conducted a trial burn of contaminated soils in Kiln 3 in August 1988. There was no discernible difference in the volatile organic compound (VOC) emissions from Kiln 3 when using contaminated soils and when using the normal plant raw feed in the kiln.

2.0 EMISSION ESTIMATES AND SOURCE APPLICABILITY

Tarmac does not expect emissions of any regulated pollutant to increase on a lb/hr basis from Kiln 3 because of the burning of waste tires or petroleum-contaminated soils. As shown in Table A-1, the composition of a tire is better than that of coal, on a lb/MM Btu basis, for all constituents except for chlorine and lead, which show only small differences. The ferrous material within the tire will readily combine with the raw feed materials to form clinker, just like the ferrous materials in the fly ash Tarmac now uses.

The burning of waste tires in the kiln will actually reduce fugitive dust emissions since the waste tire handling will not produce fugitive dust, and less coal will be handled through the coal-handling system. The burning of contaminated soils will not produce any additional fugitive dust emissions over those now generated by the handling of the raw limestone at the plant.

Although emissions from Kiln 3 are not expected to increase on a lb/hr] basis, current EPA policy requires a Prevention of Significant Deterioration (PSD) source applicability analysis whenever a physical change or change in the method of operation is occurring at a source. The burning of waste tires and contaminated soils would constitute both a physical change and a change in the method of operation of Kiln 3. This change does not relate to the production rate of the kiln but only to the fuels and raw materials fed to the kiln.

In order to determine the PSD applicability for the project, EPA requires that "actual" emissions from Kiln 3 be determined. In general, actual emissions are determined based on the average of the last two years of actual operation. However, a different time period can be used if it is more representative of actual source operation.

In the case of Kiln 3, the historic operating data show that the kiln operation has varied greatly in terms of air pollutant emission rates, as demonstrated by annual stack tests. This is expected, since the kiln operation is dependent upon a number of factors, including fuel quality, raw material feed characteristics, and type of product. In addition, clinker production has varied from year to year, based on fluctuating market conditions. As a result, a long-term average emission rate for the kiln is considered to be most representative of actual emissions. Kiln 3 began burning coal in 1982, and 1983 was the first full year on coal operation. Therefore, all years from 1983 through 1989 were used in determining the average actual emissions from the kiln.

Presented in Table A-2 are actual particulate matter (PM) emissions for Kiln 3 for the years 1983 through 1989. The emissions for each year are based on the clinker production and the annual stack test result. The individual stack tests conducted on the kiln are presented in Attachment C. From the stack test results, an average emission factor for each year is calculated in terms of pounds per ton of clinker produced (lb/ton). The stack test results have ranged from 0.12 lb/ton to 0.24 lb/ton (yearly average). The annual emissions are calculated by multiplying the clinker production by the emission factor.

The PM stack tests measure total suspended particulate matter [PM(TSP)]. Emissions of PM with an aerodynamic particle size diameter of 10 microns or less (PM10) were determined based upon size-specific PM emission factors presented in EPA Publication AP-42, Table 8.6-3. For a wet process cement kiln with an ESP for PM control, 85 percent of the PM(TSP) is 10 microns or less. The resulting PM10 emissions also are shown in Table A-2. As shown, average actual PM(TSP) emissions for Kiln 3 are 61.62 tons per year (TPY), and average actual PM10 emissions are 52.38 TPY.

Presented in Table A-3 and Table A-4 are actual average sulfur dioxide (SO₂) and nitrogen oxides (NO_x) emissions calculated in the same manner as PM emissions. Average SO₂ emissions are 1,593.4 TPY, and average NO_x emissions are 2,271.6 TPY.

Actual average CO emissions for the years 1983 through 1989 were determined in a similar manner. CO testing has not been conducted at Tarmac in the past, and there are no established emission factors for CO emissions from cement kilns. However, the CO level in the kiln ESP is maintained at or below 1,000 ppm to minimize the explosion potential in the ESP. The 1,000 ppm level is the best estimate of CO emissions from Kiln 3. CO emissions were calculated on the basis of the gas flow rate measured during each compliance test. From these data, a lb/ton emission factor for CO was determined. These results are presented in Table A-5. Average CO emissions are 3,472.5 TPY.

Table A-2. Baseline PM Emissions For PSD Source Applicability Analysis, Tarmac Kiln 3

Year	Clinker Production (tons)	PM(TSP) Emissions+ (lb/ton)	PM(TSP) Emissions (TPY)	PM10 Emissions** (TPY)
1983	678,000	0.13	44.07	37.46
1984	683,493	0.22	75.18	63.91
1985	679,581	0.24	81.55	69.32
1986	640,737	0.18	57.67	49.02
1987	614,944	0.21	64.57	54.88
1988	652,994	0.21	68.56	58.28
1989	662,748	0.12	39.76	33.80
Average	658,928		61.62	52.38

+ Based on average of all stack tests conducted during the year.

** Calculated as 85% of PM(TSP) emissions.

Table A-3. Baseline SO2 Emissions For PSD Source Applicability Analysis, Tarmac Kiln 3

Year	Clinker Production (tons)	SO2 Emission Factor+ (lb/ton)	SO2 Emissions (TPY)
1983	678,000	7.44	2,522.2
1984	683,493	8.16	2,788.7
1985	679,581	4.70	1,597.0
1986	640,737	1.93	618.3
1987	614,944	3.76	1,156.1
1988	652,994	3.53	1,152.5
1989	662,748	3.98	1,318.9
-----	-----		-----
Average	658,928		1,593.4

+ Based on average of all stack tests conducted during the year.

Table A-4. Baseline NOx Emissions For PSD Source Applicability Analysis, Tarmac Kiln 3

Year	Clinker Production (tons)	NOx Emission Factor+ (lb/ton)	NOx Emissions (TPY)
1983	678,000	6.98 *	2,366.2
1984	683,493	6.98 *	2,385.4
1985	679,581	7.96	2,704.7
1986	640,737	7.71	2,470.0
1987	614,944	5.31	1,632.7
1988	652,994	5.20	1,697.8
1989	662,748	7.98	2,644.4
-----	-----		-----
Average	658,928		2,271.6

+ Based on average of all stack tests conducted during the year.

* NOx test data not obtained during these years. As a result, the average of the 1982 and 1985 tests of 6.98 lb/ton was used.

Table A-5. Baseline CO Emissions For PSD Source Applicability Analysis,
Tarmac Kiln 3

Year	Clinker Production (tons)	Stack Test Data*					CO Emissions (tons/yr)	
		Prod. Rate (tons/hr)	ACFM	Temp. (Deg.F)	CO+ (ppm)	CO (lb/hr)		lb/ton
1983	678,000	91.70	373,450	433	1000	963	9.60	3,254.4
1984	683,493	91.70	311,726	358	1000	877	9.57	3,269.1
1985	679,581	87.29	329,567	395	1000	887	10.16	3,453.8
1986	640,737	85.30	329,314	368	1000	915	9.60	3,075.5
1987	614,944	86.65	346,042	351	1000	982	11.33	3,485.1
1988	652,994	85.75	370,155	365	1000	1,033	12.04	3,932.3
1989	662,748	87.50	343,344	320	1000	1,013	11.58	3,837.2
Average	658,928							3,472.5

* Based upon average of all stack tests conducted during year.

+ Assumed based on maximum tolerable CO level in kiln.

There has been only one test on Kiln 3 for volatile organic compounds (VOC) under normal kiln operating conditions. This test was conducted in July 1988. Two other tests have been conducted: one when burning contaminated soils, and the second when burning refuse-derived fuel. Neither of these is representative of normal kiln operation. Results from the July 1988 test showed 75.9 lb/hr VOC when producing 85.1 TPH of clinker. This results in an emission factor of 0.89 lb/ton. Although the data are very limited, no other emission factors are available for cement kilns. VOC emission tests from other cement plants may not be applicable since the raw material feed to the kiln can significantly affect VOC emissions. As a result, the 0.89 lb/ton factor is considered to be the best available factor for Kiln 3.

As shown in Tables A-2 through A-5, the average clinker production from 1983 through 1989 was 658,928 TPY. Applying the emission factor of 0.89 lb/ton results in actual VOC emissions of 293.2 TPY.

The emission factor for lead (Pb) emissions from cement kilns is published in AP-42 as 0.1 lb/ton. Applying this factor to the average kiln production of 658,928 TPY results in actual emissions of 32.95 TPY. Since SO₂ is emitted from Kiln 3, it is reasonable to expect sulfuric acid mist (H₂SO₄) also to be emitted. Based on AP-42 emission factors for fuel-burning sources, 3 percent of the sulfur emitted can reasonably be expected to convert to H₂SO₄. Based on the actual SO₂ emissions from Kiln 3 of 1,593.4 TPY, H₂SO₄ emissions are calculated as follows:

$$1,593.4 \text{ TPY} \times 32/64 \times 0.03 \times 98/32 = 73.2 \text{ TPY}$$

The only other regulated pollutant for which there exists an emission factor for cement kilns is beryllium. The factor is 0.002 lb/ton, based on EPA's compilation of toxic emission factors (EPA-450/2-88-006). Actual emissions of beryllium, based on the actual average kiln production of 658,928 TPY and this emission factor, is 0.65893 TPY.

The PSD baseline emissions for Kiln 3 for all pollutants are summarized in Table A-6. Also shown are the proposed maximum future emission rates for Kiln 3. The net increase in emissions is shown, along with the PSD source applicability. As shown, only the increase in NO_x emissions exceeds the PSD significant emission rate and is therefore the only pollutant subject to PSD review. The PSD review analysis for NO_x is presented in Attachment D.

Table A-6. PSD/Nonattainment Source Applicability Analysis For Tarmac Kiln 3

Pollutant	Baseline Emissions (TPY)	Future Maximum Emissions			Net Increase (TPY)	PSD Significant Emission (TPY)
		(lb/hr)	(lb/ton)	(TPY)*		
PM(TSP)	61.62	19.70	0.2251	78.80	17.2	25
PM10	52.38	16.74	0.1914	66.98	14.6	15
SO ₂	1,593.4	408.2	4.67	1,632.8	39.4	40
NO _x	2,271.6	592.4	6.77	2,369.5	97.9	40
CO	3,472.5	892.5	10.20	3,570.0	97.5	100
VOC	293.2	83.1	0.95	332.5	39.3	40 +
Pb	32.95	8.37	0.0957	33.50	0.55	0.6
H ₂ SO ₄ Mist	73.2	20.0	0.23	80.0	6.80	7
Be	0.65893	0.1648	0.001883	0.65905	0.0001	0.0004

* Based on maximum of 700,000 tons clinker per year.
+ Significant emission rate for nonattainment review.

ATTACHMENT B

**ANALYSIS OF TYPICAL
PETROLEUM-CONTAMINATED SOIL**



13294
TARMAC FLORIDA INC
P.O. BOX 2998
HIALEAH, FL 33012

Page 1 of 2
July 22, 1988
Report 26759
LAB I.D. 86119

ATT : SCOTT QUASS

Sample Collected: 7/11/88

Sample Received: 7/11/88

Sample Description: COMPOSITE 290 N.W. 171 ST. MPS PLANT

Collected By: FRANCISCO GOMEZ

REPORT OF ANALYSIS : EXCAVATED SOIL		UNITS	DATE
✓ ACENAPHTHENE	< 30	ppb	7/19/88
✓ ACENAPHTHYLENE	< 30	ppb	7/19/88
✓ ANTHRACENE	< 3	ppb	7/19/88
✓ BENZENE	< 100	ppb	7/19/88
✓ BENZO (A) ANTHRACENE	< 3	ppb	7/19/88
✓ BENZO (A) PYRENE	< 3	ppb	7/19/88
✓ BENZO (B) FLUORANTHENE	< 3	ppb	7/19/88
✓ BENZO (G,H,I) PERYLENE	< 3	ppb	7/19/88
✓ BENZO (K) FLUORANTHENE	< 3	ppb	7/19/88
✓ CHLOROBENZENE	< 100	ppb	7/19/88
✓ CHRYSENE	< 3	ppb	7/19/88
✓ DIBENZO (A,H) ANTHRACENE	< 3	ppb	7/19/88
✓ ETHYL BENZENE	< 100	ppb	7/19/88
FLUORANTHENE	< 3	ppb	7/19/88
✓ FLUORENE	< 30	ppb	7/19/88
✓ INDENO-(1,2,3-CD) PYRENE	< 15	ppb	7/19/88
✓ METHYL TERT BUTYL ETHER	< 100	ppb	7/19/88
✓ NAPHTHALENE	< 30	ppb	7/19/88
✓ PHENANTHRENE	< 30	ppb	7/19/88
✓ PYRENE	< 3	ppb	7/19/88
✓ TOLUENE	< 100	ppb	7/19/88
XYLENE, TOTAL	< 100	ppb	7/19/88
✓ 1-METHYL NAPHTHALENE	< 30	ppb	7/19/88
1,2-DICHLOROBENZENE	< 100	ppb	7/19/88

13294
TARMAC FLORIDA INC
P.O. BOX 2998
HIALEAH, FL 33012

Page 2 of 2
July 22, 1988
Report 26759
LAB ID. 86119

ATT : SCOTT QUASS

Sample Collected: 7/11/88

Sample Received: 7/11/88

Collected By: FRANCISCO GOMEZ

Sample Description: COMPOSITE 290 N.W. 171 ST. MPS PLANT

REPORT OF ANALYSIS : EXCAVATED SOIL		UNITS	DATE
✓ 1,3-DICHLOROBENZENE	< 100	ppb	7/19/88
✓ 1,4-DICHLOROBENZENE	< 100	ppb	7/19/88
✓ 2-METHYL NAPHTHALENE	< 30	ppb	7/19/88

Analyses performed in accordance with E.P.A., A.S.T.M., Standard Methods or other approved methods.

Respectfully Submitted,

Michael Rentoumis

Michael Rentoumis
Laboratory Supervisor *MR*
Enviropact Services, Inc.

Jefferson L. Flowers, Ph.D.

Jefferson S. Flowers, Ph.D.

Ph. (305) 339-5984

FLOWERS CHEMICAL LABORATORIES, INC.
ANALYTICAL & CONSULTING CHEMISTS

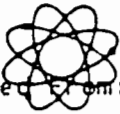

Received From:

Missimer Assoc.
Rt. 8 Box 625D
Cape Coral, FL 33991

Date Reported: Mar 17 1988

PO Number: 88-5

DHRS Lab# : 83139
DER Lab# : E83018
AIHA Lab# : 253

For: 5030/8020 5030/8100 Pb

Date Received:

Mar 4 1988

Lab Numbers: 5846-5849

REPORT OF ANALYSIS

Parameter	Unit	Method	%ACC	%PRC	5846	5847	5848	5849
					WASTE	DIESEL	COVERD	LUBE
					OIL	TANK	SOIL	TANK
Lead	mgPb/kg	0.01	97.5	2.01	0.25	0.36	0.36	0.25
1,2-Dichlorobenzene	ug/kg	0.5	100	12.1	<0.50	<0.50	<0.50	<0.50
1,3-Dichlorobenzene	ug/kg	0.5	101	13.8	<0.50	<0.50	<0.50	<0.50
1,4-Dichlorobenzene	ug/kg	0.5	104	13.1	<0.50	<0.50	<0.50	<0.50
Benzene	ug/kg	0.5	96.2	6.25	<0.50	<0.50	<0.50	<0.50
Chlorobenzene	ug/kg	0.5	100	4.36	<0.50	<0.50	<0.50	<0.50
Ethylbenzene	ug/kg	0.5	98.6	9.56	<0.50	<0.50	<0.50	<0.50
Toluene	ug/kg	0.5	99.4	5.47	<0.50	<0.50	<0.50	1.4
Xylene	ug/kg	0.5	104	5.87	<0.50	309	<0.50	<0.50
M-TertButylEther	ug/kg	0.5	105	1.71	<0.50	<0.50	<0.50	<0.50
DilutionFactor		1	100	0	1	1	1	1
Acenaphthalene	ug/kg	5	93.1	2.39	<5	174	240	<5
Acenaphthene	ug/kg	5	93.1	2.39	<5	168	238	<5
Anthracene	ug/kg	5	93.1	2.39	<5	196	259	<5
Benzo(a)anthracene	ug/kg	5	93.1	2.39	<5	<5	<5	<5
Benzo(a)pyrene	ug/kg	5	93.1	2.39	<5	<5	<5	<5
Benzo(b)fluoranthene	ug/kg	5	93.1	2.39	<5	<5	<5	<5
Benzo(g,h,i)perylene	ug/kg	5	93.1	2.39	<5	<5	<5	<5
Benzo(k)fluoranthene	ug/kg	5	93.1	2.39	<5	<5	<5	<5
Chrysene	ug/kg	5	93.1	2.39	<5	<5	<5	<5
Dibnz(a,h)anthracene	ug/kg	5	93.1	2.39	<5	<5	<5	<5
Fluoranthene	ug/kg	5	93.1	2.39	<5	65.2	341	<5
Fluorene	ug/kg	5	93.1	2.39	<5	106	152	<5
Indn(1,2,3-cd)pyrene	ug/kg	5	93.1	2.39	<5	<5	<5	<5
Naphthalene	ug/kg	5	93.1	2.39	<5	1050	94.2	<5
1-methyl-Naphthalene	ug/kg	5	93.1	2.39	<5	8180	157	<5

Data Release Authorization

Sample integrity and reliability certified by Lab personnel prior to analysis.
Methods of analysis in accordance with FCL QA and EPA approved methodology.

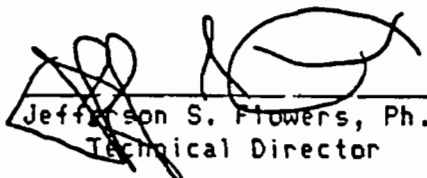
Jefferson S. Flowers, Ph.D.
Technical Director

FLOWERS CHEMICAL LABORATORIES, INC.

ANALYTICAL & CONSULTING CHEMISTS

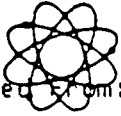

Received From:

Missimer Assoc.
Rt. 8 Box 625D
Cape Coral, FL 33991

Date Reported: Mar 17 1988
PO Number: 88-5

DHRS Lab# : 83139
DER Lab# : E83018
AIHA Lab# : 253

For: 5030/8020 5030/8100 Pb

Date Received:

Mar 4 1988

Lab Numbers: 5846-5849

REPORT OF ANALYSIS

Parameter	Unit	Method	%ACC	%PRC	5846	5847	5848	5849
					WASTE	DIESEL	COVERD	LUBE
					OIL	TANK	SOIL	TANK
2-methyl-Naphthalene	ug/kg	5	93.1	2.39	<5	1380	120	<5
Phenanthrene	ug/kg	5	93.1	2.39	<5	271	419	<5
Pyrene	ug/kg	5	93.1	2.39	<5	37.2	312	<5

Data Release Authorization

Sample integrity and reliability certified by Lab personnel prior to analysis.
Methods of analysis in accordance with FCL QA and EPA approved methodology.

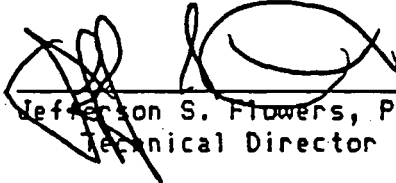
Jefferson S. Flowers, Ph.D.
Technical Director

ATTACHMENT C
KILN 3 STACK TEST RESULTS

Table C-1. PM Emission Tests, Tarmac Kiln No. 3 Burning Coal

Test Date	Clinker Production Rate (TPH)	PM Emissions	
		lb/hr	lb/ton clinker
Mar-83	91.7	12.8	0.14
	91.7	10.9	0.12
	91.7	12.8	0.14
	Avg.	12.2	0.13
Apr-84	91.7	26.8	0.29
	91.7	16.6	0.18
	91.7	16.8	0.18
	Avg.	20.1	0.22
16-May-85	87.5	30.6	0.35
	87.5	19.1	0.22
	87.4	29.1	0.33
24-May-85	87.2	19.1	0.22
	87.3	21.8	0.25
	87.7	21.3	0.24
31-May-85	87.6	18.6	0.21
	87.6	14.6	0.17
	87.6	17.2	0.20
	Aug-85	86.7	17.3
86.7		20.0	0.23
86.7		19.9	0.23
Avg.		20.7	0.24
Dec-86	85.3	16.9	0.20
	85.3	10.4	0.12
	85.3	18.7	0.22
	Avg.	15.3	0.18
Dec-87	87.4	23.3	0.27
	87.4	14.7	0.17
	87.4	17.8	0.20
	Avg.	18.6	0.21
Jul-88	85.1	12.8	0.15
	85.1	11.9	0.14
	85.1	13.3	0.16
Aug-88	86.4	21.6	0.25
	86.4	24.7	0.29
	86.4	22.5	0.26
	Avg.	17.8	0.21
May-89	87.5	12.9	0.15
	87.5	10.4	0.12
	87.5	7.5	0.09
	Avg.	10.3	0.12

Table C-2. SO₂ Emission Tests, Tarmac Kiln No. 3 Burning Coal

Test Date	Clinker Production Rate (TPH)	SO ₂ Emissions		Test Date	Clinker Production Rate (TPH)	SO ₂ Emissions	
		lb/hr	lb/ton clinker			lb/hr	lb/ton clinker
Jan-83	79.2	956	12.07	Apr-87	85.9	270	3.14
	79.2	1,149	14.51		85.9	314	3.66
	79.2	1,778	22.45		85.9	281	3.27
Mar-83	79.2	1,174	14.82	Dec-87	87.4	394	4.51
	91.7	124	1.35		87.4	340	3.89
	91.7	208	2.27		87.4	358	4.10
	91.7	183	1.99	Avg.	326	3.76	
	91.7	186	2.03				
	91.7	161	1.76		Jul-88	85.1	305
	91.7	100	1.10	85.1		380	4.47
	Avg.	602	7.44	85.1		287	3.37
Apr-84	91.7	1,082	11.80	Aug-88	86.4	235	2.73
		1,248	13.61		86.4	302	3.49
		1,209	13.18		86.4	306	3.54
		424	4.62	Avg.	302	3.53	
		238	2.60				
		288	3.14		May-89	87.5	322
Avg.	748	8.16	87.5	330		3.78	
			87.5	393		4.49	
16-May-85	87.5	535	6.11	Avg.	348	3.98	
		439	5.02				
		514	5.88				
24-May-85	87.2	380	4.36				
		357	4.09				
		388	4.42				
31-May-85	87.6	384	4.39				
		409	4.67				
		372	4.25				
Aug-85	86.7	381	4.39				
		367	4.23				
		394	4.54				
Avg.	410	4.70					
Dec-86	85.3	170	1.99				
		168	1.97				
		155	1.82				
Avg.	164	1.93					

Table C-3. NOx Emission Tests, Tarmac Kiln No. 3 Burning Coal

Test Date	Clinker Production Rate (TPH)	NO _x Emission		Test Date	Clinker Production Rate (TPH)	NO _x Emission			
		lb/hr	lb/ton clinker			lb/hr	lb/ton clinker		
Apr-82	85.6	405	4.73	Dec-86	85.3	678	7.95		
	85.6	512	5.98		85.3	671	7.86		
	85.6	695	8.12		85.3	624	7.31		
May-82	79.0	792	10.02	Apr-87	Avg.	658	7.71		
	79.0	520	6.58			85.9	378	4.40	
	79.0	464	5.88			85.9	438	5.10	
	79.0	438	5.54			85.9	436	5.07	
	79.0	218	2.76			Dec-87	87.4	447	5.11
	79.0	346	4.38				87.4	534	6.11
	Avg.	488	6.00				87.4	532	6.09
16-May-85	87.5	643	7.35	Jul-88	Avg.	461	5.31		
	87.5	854	9.77			85.1	484	5.69	
	87.4	750	8.58			85.1	411	4.83	
24-May-85	87.2	732	8.40	Aug-88	Avg.	444	5.14		
	87.3	809	9.26			86.4	488	5.65	
	87.7	768	8.76			86.4	491	5.68	
31-May-85	87.6	647	7.38	May-89	Avg.	446	5.20		
	87.6	618	7.06			87.5	855	9.77	
	87.6	779	8.89			87.5	717	8.19	
	86.7	549	6.33			87.5	521	5.96	
Aug-85	86.7	593	6.84	Avg.	Avg.	698	7.98		
	86.7	602	6.94						
	Avg.	695	7.96						

ATTACHMENT D
PSD ANALYSIS FOR NO_x

PSD ANALYSIS FOR NO_x

1.0 REQUIREMENTS

According to PSD regulations, the following reviews must be performed for the proposed modification of Kiln 3 in order to satisfy the preconstruction review requirements:

1. Air quality impact analysis
2. Air monitoring analysis
3. Control technology review
4. Additional impact analysis

Each of these analysis is addressed in the following sections. In the case of the proposed modification of Kiln 3, these reviews are required for NO_x only since only NO_x is required to undergo PSD review.

2.0 NO_x AIR QUALITY IMPACT ANALYSIS

2.1 AIR QUALITY MODELING APPROACH

2.1.1 General Modeling Approach

The general modeling approach followed EPA and FDER modeling guidelines for determining compliance with AAQS and PSD increments. In general, when model predictions are used to determine compliance with AAQS and PSD increments, current policies stipulate that the highest annual average and highest, second-highest short-term (i.e., 24 hours or less) concentrations be compared to the applicable standard when 5 years of meteorological data are used. The highest, second-highest concentration (HSH) is calculated for a receptor field by:

1. Eliminating the highest concentration predicted at each receptor,
2. Identifying the second-highest concentration at each receptor,
and
3. Selecting the highest concentration among these second-highest concentrations.

This approach is consistent with the air quality standards, which permit a short-term average concentration to be exceeded once per year at each receptor.

To develop the maximum short-term concentrations for the proposed facility, the general modeling approach was divided into screening and refined phases to reduce the computation time required to perform the modeling analysis. The basic difference between the two phases is the receptor grid used when predicting concentrations, the number of emission points, and the number of meteorological periods evaluated. In general, concentrations for the screening phase were predicted using a coarse receptor grid, limited number of major sources, and a 5-year meteorological record.

In this analysis, only the increase in NO_x emissions from the Kiln 3 conversion were modeled. The model was executed with 5 years of meteorological data and with appropriate receptors to determine the maximum annual impact of the increase in emissions.

2.1.2 Model Selection

The selection of an appropriate air dispersion model was based on the model's ability to simulate impacts in areas surrounding the Tarmac facility. Within 50.0 km of the facility, the terrain can be described as simple (i.e., flat to gently rolling). As defined in the EPA modeling guidelines, simple terrain is considered to be an area where the terrain features are all lower in elevation than the top of the stack(s) under evaluation. Therefore, a simple terrain model was selected to predict maximum ground-level concentrations.

The Industrial Source Complex (ISC) dispersion model (EPA, 1988a) was used to evaluate the pollutant emissions from the Tarmac facility and other existing major facilities. This model is contained in EPA's User's Network for Applied Modeling of Air Pollution (UNAMAP), Version 6 (EPA, 1988b). The ISC model is applicable to sources located in either flat or rolling terrain where terrain heights do not exceed stack heights.

The ISC model consists of two sets of computer codes that are used to calculate short- and long-term ground level concentrations. The first model code, the ISCST model, is designed to calculate hourly concentrations based on hourly meteorological parameters (i.e., wind direction, wind speed, atmospheric stability, ambient temperature, and mixing heights). The hourly concentrations are processed into non-overlapping, short-term, and annual averaging periods. For example, a 24-hour average concentration is based on 24 1-hour averages calculated from midnight to midnight of each day. For each short-term averaging period selected, the highest and second-highest average concentrations are calculated for each receptor. As an option, a table of the 50 highest concentrations over the entire field of receptors can be produced.

In this analysis, the ISCST model was used to calculate annual average NO_x concentrations because these concentrations are readily obtainable from the

model output, and the ISCST has been used in previous recent modeling studies for Tarmac.

Major features of the ISCST model are presented in Table 2-1. Concentrations due to stack and volume sources are calculated by the ISCST model using the steady-state Gaussian plume equation for a continuous source. The area source equation in the ISCST model is based on the equation for a continuous and finite crosswind line source. The ISC model has rural and urban options that affect the windspeed profile exponent law, dispersion rates, and mixing-height formulations used in calculating ground level concentrations. The criteria used to determine when the rural or urban mode is appropriate are based on land use near the proposed plant's surroundings (Auer, 1978). If the land use is classified as heavy industrial, light-moderate industrial, commercial, or compact residential for more than 50 percent of the area within a 3 km radius circle centered on the proposed source, the urban option should be selected. Otherwise, the rural option is more appropriate.

For modeling analyses that will undergo regulatory review, such as PSD permit applications, the following model features are recommended by EPA (1987a) and are referred to as the regulatory options in the ISCST model:

1. Final plume rise at all receptor locations,
2. Stack-tip downwash,
3. Buoyancy-induced dispersion,
4. Default windspeed profile coefficients for rural or urban option,
5. Default vertical potential temperature gradients,
6. Calm wind processing, and
7. Reducing calculated SO₂ concentrations in urban areas by using a decay half-life of 4 hours (i.e., reduce the SO₂ concentration emitted by 50 percent for every 4 hours of plume travel time).

In this analysis, the EPA regulatory options were used to address maximum impacts. Based on a review of the land use around the Tarmac facility, the

Table 2-1. Major Features of the ISCST Model

ISCST Model Features

- Polar or Cartesian coordinate systems for receptor locations
 - Rural or one of three urban options that affect wind speed profile exponent, dispersion rates, and mixing height calculations
 - Plume rise as a result of momentum and buoyancy as a function of downwind distance for stack emissions (Briggs, 1969, 1971, 1972, and 1975)
 - Procedures suggested by Huber and Snyder (1976); Huber (1977); and Schulmann and Hanna (1986) and Schulmann and Scire (1980) for evaluating building wake effects
 - Procedures suggested by Briggs (1974) for evaluating stack-tip downwash
 - Separation of multiple point sources
 - Consideration of the effects of gravitational settling and dry deposition on ambient particulate concentrations
 - Capability of simulating point, line, volume, and area sources
 - Capability to calculate dry deposition
 - Variation of wind speed with height (wind speed-profile exponent law)
 - Concentration estimates for 1-hour to annual average
 - Terrain-adjustment procedures for elevated terrain including a terrain truncation algorithm
 - Receptors located above local terrain (i.e., "flagpole" receptors)
 - Consideration of time-dependent exponential decay of pollutants
 - The method of Pasquill (1976) to account for buoyancy-induced dispersion
 - A regulatory default option to set various model options and parameters to EPA-recommended values (see text for regulatory options used)
 - Procedure for calm-wind processing
-

Source: EPA, 1988b.

rural mode was selected based on the degree of residential, industrial, and commercial development within 3 km of the site.

2.1.3 Meteorological Data

Meteorological data used in the ISCST model to determine air quality impacts consisted of a concurrent 5-year period of hourly surface weather observations and twice-daily upper air soundings from the National Weather Service (NWS) stations at Miami International Airport and West Palm Beach, respectively. The 5-year period of meteorological data was from 1982 through 1986. The NWS station in Miami, located approximately 10 km to the southeast of the Tarmac site, was selected for use in the study because it is the closest primary weather station to the study area with similar surrounding topographical features. This station also has the most readily available and complete database that is representative of the plant site.

The surface observations included wind direction, wind speed, temperature, cloud cover, and cloud ceiling. The wind speed, cloud cover, and cloud ceiling values were used in the ISCST meteorological preprocessor program to determine atmospheric stability using the Turner stability scheme. Based on the temperature measurements at morning and afternoon, mixing heights were calculated with the radiosonde data at West Palm Beach International Airport using the Holzworth approach (1972). The West Palm Beach International Airport is located about 100 km north-northeast of the site. Hourly mixing heights were derived from the morning and afternoon mixing heights using the interpolation method developed by EPA (Holzworth, 1972). The hourly surface data and mixing heights were used to develop a sequential series of hourly meteorological data (i.e., wind direction, wind speed, temperature, stability, and mixing heights). Because the observed hourly wind directions were classified into one of thirty-six 10-degree sectors, the wind directions were randomized within each sector to account for the expected variability in air flow. These calculations were performed by using the EPA RAMMET meteorological preprocessor program.

2.1.4 Emission Inventory

Stack operating parameters and NO_x emissions rates for Kiln 3 at Tarmac are presented in Table 2-2. Two NO_x emission rates are presented: the total NO_x emission from Kiln 3; and the increase in NO_x emissions from Kiln 3, as documented in Attachment A of the application.

2.1.5 Receptor Locations

As discussed in Section 2-1, the general modeling approach considered screening and refined phases to address maximum predicted impacts caused by increased NO_x emissions from Kiln 3. In the ISCST modeling, concentrations were predicted for the screening phase using several receptor grids. The locations of the receptors were based on identifying the areas in which maximum concentrations would be expected because of the proposed units.

A description of the receptor locations for determining compliance with PSD Class II increments and AAQS is as follows: 288 receptors located at distances of 100, 300, 500, 800, 1100, 1,500, 2,000, and 2,500 m along 36 radials with each radial spaced at 10-degree increments.

After the screening modeling was completed, refined modeling was conducted using a receptor grid centered on the receptor that had the highest, predicted concentration. In the refined analysis, receptors were located at intervals of 100 m between the distances considered in the screening phase, on the radial along which the maximum concentration was produced.

The effects of building downwash from structures at the Tarmac facility on predicted NO_x impacts were considered. The most significant structures at the Tarmac facility are the finish mill building, the kiln burner building, Kiln 1 and 2 ESPs, and Kiln 3 and 4 ESPs. The dimensions of these buildings are as follows:

Table 2-2. K3 Stack Parameters and NO_x Emissions

Source	Process Rate (TPH Clinker)	NO _x Emission Rate		Stack Height		Stack Diameter		Stack Temperature		Stack Velocity		Flow Rate (acfm)
		(TPY)	(g/s)	ft	m	ft	m	°F	K	ft/min	m/s	
K3	87.5	2,369.5 ^a	68.7 ^a	200	61	15.0	4.57	350	450	2,172	11.04	384,000
		(97.9) ^b	(2.8) ^b									

^aRepresents total NO_x emissions from Kiln 3.

^bRepresents increase in NO_x emissions due to modification of Kiln 3.

<u>Building</u>	<u>Height</u>	<u>Width</u>	<u>Area of Influence</u>
Finish Mill Building:	106 ft.	260 ft.	530 ft.
Kiln Burner Building:	84 ft.	200 ft.	420 ft.
K1/K2 ESP:	70 ft.	60 ft.	300 ft.
K3/K4 ESP:	90 ft.	130 ft.	450 ft.

The kiln burner building and Kiln 1 and 2 ESPs are not tall enough to influence plume dispersion from Kiln 3. However, potential downwash could occur because of the Kiln 3 and 4 ESPs since the stack for Kiln 3 is less than the Good Engineering Practice (GEP) stack height of 225 ft for this structure. The Kiln 3 stack is assumed to be downwashed in all directions.

None of the structures at the Tarmac facility are tall enough, relative to the stack height of Kiln 3, to require direction-specific building dimensions used in the Schulman-Scire downwash algorithm. Therefore, potential downwash was simulated using the Huber-Snyder downwash algorithms that conservatively assume that any stack within the influence of a building has the potential to downwash in all directions.

Impacts on plant property were eliminated from consideration. Only those impacts affecting ambient air (not on the limited-access Tarmac property) are considered. The extent of Tarmac's plant property is shown in Figure 2-1. Distance and direction to plant property relative to Kiln 2 are presented in Table 2-3.

Tarmac's property boundaries are restricted by physical barriers, inaccessibility, no-trespassing signs, and guard gates. Security guards patrol the plant area to provide further restriction to the public. The northern, northeastern, and northwestern property boundaries are all protected by canals or lakes. In the southwest portion of the property, Tarmac's property abuts the Florida East Coast (FEC) railway property. Although no fence is located along this property, there is no access to the property by roadway, and the terrain is rugged. The FEC property in this

Table 2-3. Plant Property Receptors Used in the Modeling Analysis

Direction ^a (°)	Distance ^a (m)	Direction ^a (°)	Distance ^a (m)
10	336	190	461
20	230	200	470
30	211	210	509
40	211	220	576
50	211	230	701
60	221	240	739
70	230	250	835
80	202	260	1,094
90	192	270	1,085
100	192	280	1,114
110	211	290	1,613
120	211	300	1,766
130	278	310	1,766
140	250	320	1,488
150	221	330	374
160	326	340	346
170	461	350	336
180	451	360	326

^aRelative to Kiln 2 stack location.

SEC 31 T 52 S R 40 E FEB 25 1989

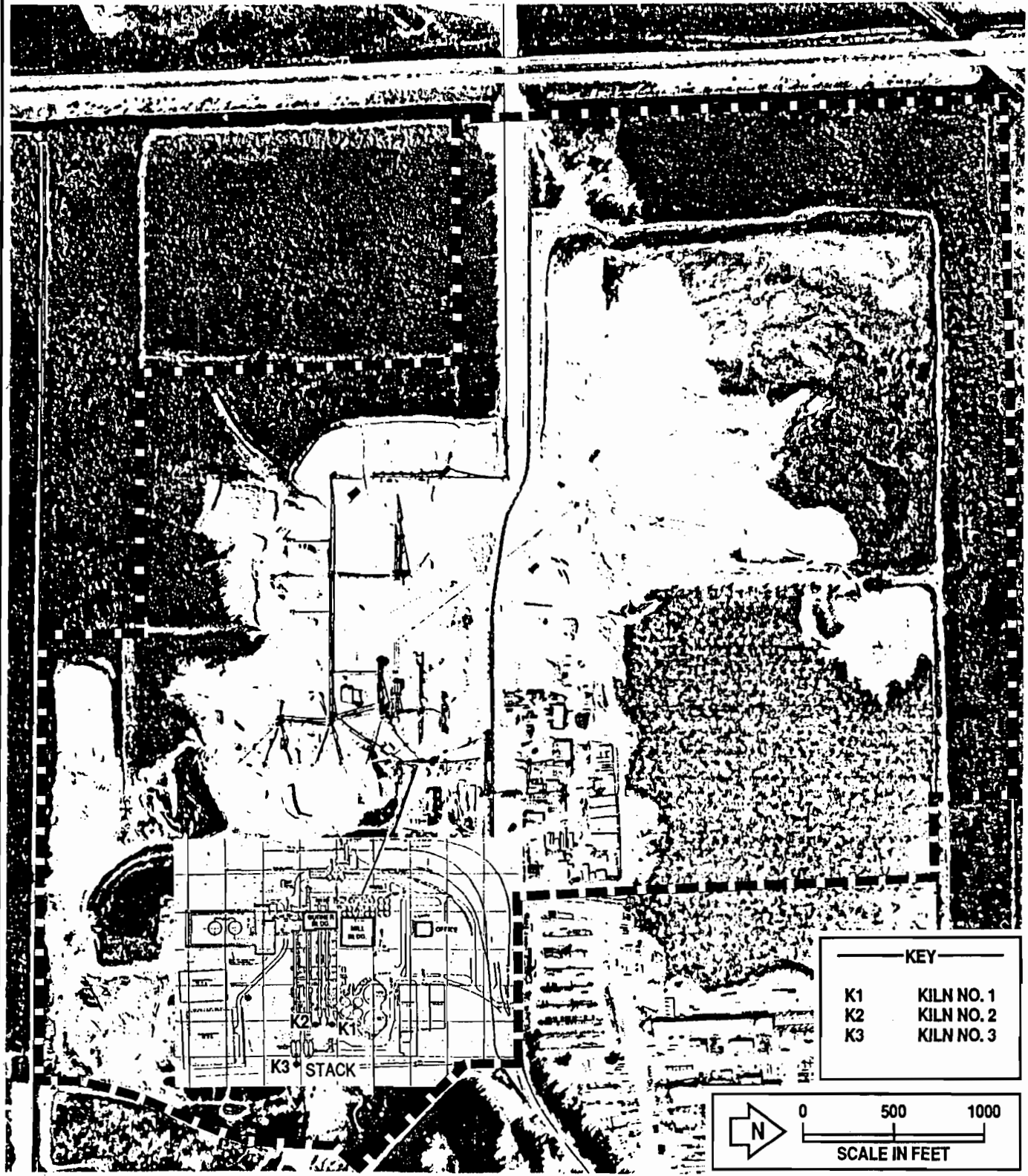

Figure 2-1 PLOT PLAN AND PLANT PROPERTY BOUNDARY OF TARMAC FACILITY



area is bordered by canals on the west and south, further restricting public access.

Tarmac's property to the south of the kiln facilities is bordered by a canal. To the southeast, there is no access to the property by roadway. FEC property also abuts this boundary. Access roads to the southeast and northeast have guard gates. In summary, access to the Tarmac facility is difficult, with restrictions provided by water bodies, spoil piles, guards, restricted signs, and patrols.

2.2 NO_x MODELING RESULTS FOR KILN 3

The increase in NO_x emissions caused by the Kiln 3 modification, from Table 2-2, is 97.9 tons/yr. The maximum annual NO_x impact caused by this increase is 0.06 μg/m³. These results of the modeling analysis are summarized in Table 2-4. The maximum impact to the increase in emissions is below the significance level of 1 μg/m³, the annual average established by EPA and FDER. Therefore, no further modeling analysis is required for NO_x to demonstrate compliance with PSD increments and AAQS.

Table 2-4. Maximum Predicted NO_x Concentrations Due to Kiln 3 Increase of lb/hr

Averaging Period	Maximum Concentration (µg/m ³)	Receptor Location ^a		Period		
		Direction (°)	Distance (km)	Julian Day	Hour Ending	Year
Annual	0.054	320	2.50	—	—	1982
	0.056	300	2.00	—	—	1983
	0.047	300	2.00	—	—	1984
	0.035	320	2.50	—	—	1985
	0.038	270	4.00	—	—	1986

^aRelative to the location of Kiln 3.

Refined: 0.056 µg/m³, @ 300°, 2.1 km, in 1983.

3.0 AIR MONITORING ANALYSIS

According to PSD regulations, a proposed modification can be exempted from conducting preconstruction ambient air monitoring analysis if the proposed increase in emissions caused by the modification causes impacts less than the de minimis monitoring concentrations. For NO_x , the de minimis monitoring concentration is $14 \mu\text{g}/\text{m}^3$, annual average. As demonstrated from the modeling analysis results, presented in Section 2.2., the proposed increase in NO_x emissions will result in a maximum impact of less than $0.1 \mu\text{g}/\text{m}^3$, which is well below the de minimis monitoring concentration. As a result, the proposed modification can be exempted from PSD preconstruction monitoring requirements.

4.0 BACT ANALYSIS FOR NO_x

4.1 TECHNICALLY FEASIBLE CONTROL TECHNOLOGIES

4.1.1 Add-on NO_x Control Technologies

There are no known applications of add-on NO_x control technologies to wet or dry process cement kilns. The State of California, South Coast Air Quality Management District (SCAQMD) was contacted (Mr. Bill Dennison) to inquire as to the status of NO_x control technologies for cement kilns located in California. Mr. Dennison stated that to his knowledge there were no cement kilns operating or permitted in California with add-on NO_x control (i.e., selective catalytic or nonselective catalytic reduction). Review of the BACT/LAER Clearinghouse publications also did not reveal any determinations that required add-on NO_x control. All PSD cement kilns except one were "dry" process kilns, which employed precalciners or calciners ahead of the kiln (refer to Table 4-1). NO_x controls used were low furnace temperatures and low excess air. The single wet process BACT determination for NO_x was issued to Monolith Portland Cement Company in California. This permit was for a new kiln to be installed at an existing wet process cement plant. BACT was based on good combustion practices to minimize NO_x, CO, and VOC emissions, while maintaining product quality.

Since there are no known applications of add-on NO_x control technologies to wet process cement kilns, such technologies will not be considered further.

4.1.2 Process Modification--NO_x Control Technologies

4.1.2.1 Mechanisms of NO_x Formation in a Wet Process Cement Kiln

Before discussing process modifications in the wet process cement kiln for NO_x control, it is first necessary to understand the basic concepts of NO_x formation in the kiln. According to Gardiek, et al. (1984), in the reaction zone of a flame, the following reaction mechanisms are distinguished, although not completely separated from one another:

1. Thermal formation of NO (thermal NO),
2. Formation of NO from fuel nitrogen (fuel NO), and
3. Formation of primary NO (prompt NO).

Table 4-1. Summary of BACT Determinations for Portland Cement Kilns - NOx Emission

Company Name	State	Date of Permit	Source +	Fuel, sulfur content, %	Process	Capacity	Clinker Production	NOx Emission Limit			Comments
								lb/hr	lb/MMBtu	lb/ton cl.	
<u>Dry Process Kilns</u>											
Kaiser Cement & Gypsum Corp.	CA	26-Dec-78	PH/PC/Kiln/Mill	Coal, <1%	Dry	1.60 MMTPY	104 TPH	1158		11.13	Reduced fuel usage, low temp.
Calif. Portland Cement Co.	CA	12-Jan-79	PC/Kiln	Coal	Dry		114 TPH	None		None	Reduced fuel usage, low furnace temp.
Lonestar Industries Inc. *	TX	19-Feb-80	PH/Kiln/Mill	Coal	Dry	1 MMTPY	114 TPH	360		3.16	Precalciner process design
Texas Lehigh Cement Co.	TX	16-May-80	PC/Kiln/Mill	Coal	Dry	2,750 TPD	115 TPH	240		2.09	Flash calciner
Creole Corp.	CA	20-May-80	PC/Kiln/Mill	Coal	Dry	1.10 MMTPY	67 TPH	213		3.18	Reduced temp. in precalcining furnace
Lonestar Portland Cement *	UT	16-Jan-81	PC/Kiln	Coal	Dry	510,000 TPY	71 TPH	236.6		3.33	
Dixie Cement Co. *	TN	10-Sep-81	PH/PC/Kiln	Coal	Dry	800,000 TPY	99 TPH	110		1.11	Dry process
Southwestern Portland Cement	TX	05-Nov-81	Kiln #3	Coal, mod.	Dry	2,500 TPD	104 TPH	88	0.32	0.85	Kiln design
Lonestar Industries Inc.	WA	25-Jan-82	PC/Kiln/Mill	Coal	Dry	750,000 TPY	100 TPH	300		3.00	Process design
Las Vegas Portland Cement *	NV	01-Feb-82	Kiln	Coal, <.9%	Dry	6,000 TPD	125 TPH	281		3.95	
Florida Crushed Stone	FL	27-Mar-84	PH/PC/Kiln	Coal, <.8%	Dry	600,000 TPY	124 TPH	360		2.90	Dry feed, design
Lone Star Industries	CA	29-Jul-86	PH/PC/Kiln	Coal	Dry		100 TPH	250		2.50	Alkali slurry, Inj. System
Florida Mining & Material	FL	26-Dec-88	PH/Kiln/Mill	Coal, <1%	Dry		73.5 TPH	320		4.35	
<u>Wet Process Kiln</u>											
Monolith Portland Cement Co.	CA	23-Dec-81	Rotary Kiln	Coal, <1.5%	Wet	5 MTPY	67 TPH	260		3.88	Good combustion practices

* Facility was never built

+ PH = Preheater

PC = Precalciner

The formation of thermal NO takes place primarily in the combustion products zone (i.e., in the waste gas at temperatures of about 2,900°F at sufficient residence times). The NO formation is highly temperature-dependent and related to the N₂ and O₂ concentrations in the gas stream.

In the case of pulverized coal burning, fuel nitrogen is also important. The formation of NO from fuel nitrogen is completed within a short distance of the flame front. The proportion of fuel nitrogen that is converted into NO is designated as the "fuel NO yield." The fuel NO yield is only slightly dependent upon temperature.

The formation of primary NO is confined to the flame front. Its formation is dependent upon hydrocarbons in the flame front and mutually competing NO and N₂ formation mechanisms.

In order to obtain the desired quality of cement clinker, it is necessary to operate with combustion temperatures above 2,700°F, and with excess air levels of 5 to 10 percent. In addition, with the turbulent diffusion flames produced by kiln burners, more than 80 percent of the air for combustion is supplied to the fuel only after it has been ignited. These technical parameters for the combustion process generally cannot be altered. For this reason, thermal NO_x formation is of most importance since it proceeds at a faster rate when the combustion temperature and oxygen concentration are higher. Because of the very slow rate of decomposition of NO into elemental N₂ and O₂ as the temperature is lowered, the concentration of NO formed is frozen at levels reached corresponding to the peak flame temperatures in the combustion zone.

When a preheater or precalciner is employed, the fuel undergoes staged combustion, and part of the fuel is combusted at lower temperatures, thereby resulting in lower overall NO_x emissions. However, such a process is not available to an existing wet process cement kiln such as Tarmac's Kiln 3.

4.1.2.2 Potential Process Modification Alternatives

Review of the previous BACT determinations for NO_x for portland cement plants (Table 4-1) shows that for both wet and dry process kilns, combustion design has been chosen as BACT. These essentially required operating the kilns under good combustion conditions, thereby minimizing fuel use and lowering the furnace temperature. Lowering the furnace temperature is achievable in a dry process kiln since the fuel is distributed in the precalcining, preheating, and burning zones.

Other cement kiln combustion modification techniques have been addressed only from a pilot scale analysis. EPA conducted a review of the NSPS for Portland plants in 1985 (Portland Cement Plants--Background Information for Proposed Revisions to Standards), and this review revealed only one study that addressed NO_x reduction technologies for Portland cement plants firing coal (KVB, 1982). The KVB study presented the results of a testing program on a subscale cement kiln. Only natural gas was fired in the kiln. The following combustion modification techniques were studied: sulfur injection; water injection; kiln dust injection; and fly ash injection. The following general observations were noted as a result of the testing:

1. Fly ash injection (dust insufflation) was the most effective means of reducing NO_x emissions.
2. Lowered excess air was not practical to control NO_x since the cement industry already maintains the lowest practical oxygen levels in most kilns (1.5 to 2.0 percent O₂).

It was further concluded in the study that the test data were not representative of a full-scale production kiln. Therefore, this study is considered inconclusive.

In a second study by KVB, Inc. (1983), a wet process, coal-fired cement kiln was tested for NO_x emissions. This testing showed a 38 percent reduction in NO_x when the oxygen level was lowered from 2.9 percent to 1.5 percent. However, a simultaneous increase of 47 percent in SO₂ emissions occurred. Excess air was the only process variable investigated in the

full-scale testing. The pertinent conclusions of the study were as follows:

1. NO_x emissions were found to decrease as oxygen content within the kiln decreased. Only a weak correlation was found.
2. Normal variations in coal nitrogen content, burnability of the feed material, and temperatures within the kiln could all significantly affect NO_x emissions.

Further testing on a subscale cement kiln was performed, but only generalized conclusions regarding NO_x control measures could be made. Since these tests were at the subscale level, feasibility for a full-scale cement kiln is unknown.

In a third KVB study (KVB, 1984), a subscale cement kiln was evaluated for NO_x emissions. Several control techniques were analyzed, including flue gas recirculation, combustion air preheat, primary air velocity, primary/secondary air ratio, and oxygen level. Because data obtained from the study were limited, only the following general conclusions could be drawn:

1. NO_x emissions are very sensitive to excess O_2 levels.
2. Flue gas recirculation is more effective with gas firing than with coal firing.
3. Primary air dilution with inert gas was the most effective combustion modification for NO_x reduction firing coal.

Unfortunately, SO_2 emissions were not measured during this study, so no assessment of NO_x/SO_2 relationships was performed.

Tarmac (formerly Lonestar Florida) conducted an extensive study of SO_2/NO_x emissions and kiln operating parameters on Kiln 3 in 1985. Kiln O_2 levels were compared to NO_x and SO_2 levels, and attempts to correlate these variables were attempted. A strong correlation between kiln O_2 and SO_2 emissions was found, but no correlation was found between kiln O_2 and NO_x or between NO_x and SO_2 emissions. It was concluded that NO_x emissions were

primarily a function of temperature within the kiln. SO₂ emissions decreased as kiln O₂ levels increased from 1 to 3.5 percent.

In summary, there are few data available on NO_x combustion modification techniques for full-scale wet process cement kilns. In the one study that employed a full-scale kiln, only the oxygen level in the kiln was evaluated, and the data show a significant increase in SO₂ emissions when oxygen is lowered to reduce NO_x emissions. Significantly more research and application to a full-scale cement kiln is needed before combustion modification techniques can be applied successfully to wet process cement kilns. As a result, combustion modification techniques are not considered further as BACT.

4.2 Determination of Bact and Emission Limit

By virtue of elimination of all add-on NO_x technologies and all process modification technologies for the existing wet process kiln, good combustion practices in the kiln to minimize emissions of NO_x, CO, and VOC is determined to be BACT for Kiln 3. The combustion practices must be implemented consistent with good clinker product quality.

Tarmac has a substantial interest in minimizing NO_x emissions to the extent possible. Lower NO_x emissions translates into less fuel, lower excess air rates, and less heat lost out of the kiln. Therefore, it is in Tarmac's best interest to minimize NO_x emissions. However, it also should be remembered that measures to reduce NO_x (i.e., lower excess air) will act to increase SO₂ emissions.

The most useful information concerning potential NO_x emission reductions through process controls is the experience Tarmac has gained from operation of Kiln 3 on coal. This experience has indicated the following:

1. NO_x emissions are inversely related to SO₂ emissions (i.e., as NO_x is reduced, SO₂ increases).
2. NO_x emissions are reduced by lowering flame temperature and oxygen level (low excess air) in the kiln.

In a wet process kiln, such as Kiln 3, temperature is critical, and high enough temperatures must be maintained to calcine the raw feed. If temperature is not maintained, product quality is reduced. As a result, NO_x emissions from Kiln 3 can be reduced only by adjusting process parameters, but not so much as to affect clinker quality. Also, SO₂ emissions will increase when reducing NO_x emissions. Tarmac's objective for Kiln 3 will be to minimize SO₂ emissions while simultaneously achieving the proposed NO_x emission limit.

The proposed NO_x emission limit is the current emission limit for Kiln 3 of 6.77 lb/ton clinker. It is difficult to compare this emission limit to other BACT emission limits for cement kilns. A complete listing of all NO_x BACT determinations for cement plants is contained in Table 4-1. The list shows that almost all cement plants requiring BACT review were of the dry process type. There are fundamental differences between the dry process and the wet process in regards to NO_x emissions. The dry process is more energy efficient than the wet process, therefore requiring less fuel (on the order of 50 percent less fuel). This translates into lower fuel-bound nitrogen for dry kilns and hence lower NO_x emissions. Secondly, dry process kilns can operate at lower kiln temperatures because of the dry nature of the feed and because most dry processes employ preheaters or precalciners, which serve to stage the combustion and lower the overall combustion temperature. Wet process kilns must operate at higher temperatures to ensure complete calcination of the raw feed and cannot employ preheaters or precalciners. This fundamental difference between the wet and dry process kilns must not be ignored.

It is not proper to compare federal New Source Performance Standards (NSPS) for fossil fuel-fired, steam-generating units to cement kiln emission limits. These NSPS are for a completely different process and completely different industry and have no bearing upon NO_x emissions from cement kilns. A major difference between steam generators and wet process cement kilns is that high temperature can be controlled much more effectively

since this does not adversely affect steam generation. Staged combustion, low excess air, and other techniques to lower the peak flame temperature can be employed with no sacrifice to product quantity or quality. However, in a wet process cement kiln, high temperature is critical to the final product.

However, even the NSPS specifically sets different emission limits for different types of steam-generating units (i.e., pulverized coal, spreader stoker, fluidized bed) and different types of fuel. Therefore, it is proper to differentiate between wet and dry process kilns in determining NO_x emission limits.

Tarmac is requesting an NO_x emission limit for Kiln 3 that is the same as the current limit on Kiln 3 (6.77 lb/ton clinker). Extensive source testing on Kiln 3 when burning coal has shown that this emission level has been exceeded. A complete listing of all NO_x stack tests on Kiln 3 when burning coal are presented in Table 4-2. NO_x emissions have ranged from 2.8 lb/ton of clinker up to 10.0 lb/ton. The average of all tests is 6.4 lb/ton. The requested emission limit is only slightly above the average actual emission level. The proposed BACT emission limit is supported by the site-specific test data.

The potential relationship between SO₂ and NO_x emissions also must be recognized in setting the BACT limit for NO_x. Extensive testing and operation on Kiln 3 has shown there is a generally inverse relationship between these two pollutants. The current SO₂ emission limit for Kiln 3 is 4.57 lb/ton of clinker. In this permit application, Tarmac is applying for a new limit of 4.67 lb/ton, which is only a small increase in the present limit. This slight increase in the SO₂ limit will not allow Tarmac to reduce NO_x emissions further.

Table 4-2. NOx Emission Tests, Tarmac Kiln No. 3 Burning Coal

Test Date	Kiln Feed (TPH)	Production Rate (TPH)	Coal Feed Rate (TPH)	Heat Input * Rate (MMBtu/hr)	Heat/Clinker Ratio (MMBtu/ton)	NOx Emission		
						lb/hr	lb/ton feed	lb/ton clinker
Apr-82	138.30	85.6	16.5	412.5	4.82	405	2.9	4.7
	138.30	85.6	16.5	412.5	4.82	512	3.7	6.0
	138.30	85.6	16.5	412.5	4.82	695	5.0	8.1
May-82	127.59	79.0	13.9	347.5	4.40	792	6.2	10.0
	127.59	79.0	13.5	337.5	4.27	520	4.1	6.6
	127.59	79.0	14.4	360.0	4.56	464	3.6	5.9
	127.59	79.0	14.4	360.0	4.56	438	3.4	5.5
	127.59	79.0	14.4	360.0	4.56	218	1.7	2.8
	127.59	79.0	15.5	387.5	4.91	346	2.7	4.4
16-May-85	133.50	87.5	14.9	372.5	4.26	643	4.8	7.3
	132.80	87.5	14.6	365.0	4.17	854	6.4	9.8
	132.70	87.4	14.7	367.5	4.20	750	5.7	8.6
24-May-85	132.80	87.2	14.8	370.0	4.24	732	5.5	8.4
	132.50	87.3	14.5	362.5	4.15	809	6.1	9.3
	132.30	87.7	14.5	362.5	4.13	768	5.8	8.8
31-May-85	132.80	87.6	14.6	365.0	4.17	647	4.9	7.4
	132.80	87.6	14.6	365.0	4.17	618	4.7	7.1
	132.80	87.6	14.6	365.0	4.17	779	5.9	8.9
Aug-85	133.00	86.7	15.2	380.0	4.38	549	4.1	6.3
	133.00	86.7	15.2	380.0	4.38	593	4.5	6.8
	133.00	86.7	15.0	375.0	4.33	602	4.5	6.9
Dec-86	133.50	85.3	16.2	405.0	4.75	678	5.1	7.9
	133.50	85.3	15.9	397.5	4.66	671	5.0	7.9
	133.50	85.3	15.9	397.5	4.66	624	4.7	7.3
Apr-87	133.30	85.9	16.3	407.5	4.74	378	2.8	4.4
	133.30	85.9	15.9	397.5	4.63	438	3.3	5.1
	133.30	85.9	16.0	400.0	4.66	436	3.3	5.1
Dec-87	133.10	87.4	17.5	437.5	5.01	447	3.4	5.1
	133.10	87.4	17.6	440.0	5.03	534	4.0	6.1
	133.10	87.4	17.8	445.0	5.09	532	4.0	6.1
Jul-88	133.50	85.1	18.2	455.0	5.35	484	3.6	5.7
	133.50	85.1	18.1	452.5	5.32	411	3.1	4.8
	133.50	85.1	17.9	447.5	5.26	360	2.7	4.2
Aug-88	132.90	86.4	18.9	472.5	5.47	444	3.3	5.1
	132.90	86.4	18.9	472.5	5.47	488	3.7	5.7
	132.90	86.4	18.7	467.5	5.41	491	3.7	5.7
May-89	133.00	87.5	16.7	417.5	4.77	855	6.4	9.8
	133.00	87.5	16.7	417.5	4.77	717	5.4	8.2
	133.00	87.5	16.7	417.5	4.77	521	3.9	6.0
Aug-89	140.25	92.1	18.3	457.3	4.97	381	2.7	4.1
	140.25	92.1	18.3	457.3	4.97	261	1.9	2.8
	140.25	92.1	18.3	457.3	4.97	333	2.4	3.6
Maximum =						855	6.4	10.0
Minimum =						218	1.7	2.8
Average =						553	4.2	6.4

* Assuming a coal heating value of 12,500 Btu/hr

The firing of waste tires in Kiln 3 has the potential to lower NO_x emissions. This is because the waste tires, which will serve as a source of fuel, will be introduced midway along the kiln length. This will result in a secondary firing area, which will stage the combustion of fuel and potentially provide lower overall kiln temperatures. However, because of a complete lack of waste tire burning data on Kiln 3, it is not possible to predict the degree of potential NO_x reduction.

5.0 ADDITIONAL IMPACT ANALYSIS

The NO_x modeling analysis demonstrates insignificant changes in total NO_x air quality impacts in the Tarmac area. As a result, no significant impacts upon soils, vegetation, or visibility are expected in the area.

Only slight additional employment at the Tarmac facility will occur because of the proposed modification. Slight additional truck traffic also will occur because of receipt of waste tires and contaminated soils by truck. However, these increases will be accompanied by decreases in coal brought to the site and subsequent coal handling, as well as decreases in raw materials supplied from the associated quarry operations.

REFERENCES

- LVB, Inc. 1984. Combustion Modification Tests on a Subscale Cement Kiln for NO_x Reduction. EPA-600/7-84-075.
- KVB, Inc. 1983. Evaluation of Combustion Variable Effects on NO_x Emissions From Mineral Kilns. EPA-600/7-83-045.
- KVB, Inc. 1982. Application of Advanced Combustion Modifications to Industrial Process Equipment: Subscale Test Results. EPA-600/7-82-021.
- Gardiek, H.O., H. Rosemann, S. Sprung, and W. Rechenberg. 1984. Behavior of Nitrogen Oxides In Rotary Kiln Plants of the Cement Industry. Zement-Klark-Gips, No. 12, 1984. pp. 270.

ATTACHMENT E
ISCST PRINTOUTS

ISCSTK6E MODEL, A VERSION OF
ISCST (VERSION 88348)
AN AIR QUALITY DISPERSION MODEL IN
SECTION 1. GUIDELINE MODELS.
IN UNAMAP (VERSION 6) DEC 1988.
SOURCE: FILE 6 ON UNAMAP MAGNETIC TAPE FROM NTIS.
(Based on Version 3.4 to UNAMAP, Dec 15, 1988)

CONVERTED BY :
KBN ENGINEERING AND APPLIED SCIENCES, INC.
GAINESVILLE, FLORIDA
(904)331-9000

COPYRIGHT 1990 L

CARD INPUT File is	aqslk3.i82	
SUMMARY OUTPUT File is	aqslk3.o82	
METEOROLOGICAL FILE is	miaprl82.bin	
TITLE OF RUN is	1982 TARMAC KILN 3 NOX Increase	10-23-90

NOTE THAT THE BUILDING DIMENSIONS ON CARD 6,1 FOR SOURCE NO. 3 DO NOT MEET THE SCHULMAN-SCIRE CRITERIA.
THEREFORE, DIRECTION SPECIFIC BUILDING DIMENSIONS WILL NOT BE USED BY THE MODEL.

CALCULATE (CONCENTRATION=1,DEPOSITION=2)
 RECEPTOR GRID SYSTEM (RECTANGULAR=1 OR 3, POLAR=2 OR 4)
 DISCRETE RECEPTOR SYSTEM (RECTANGULAR=1,POLAR=2)
 TERRAIN ELEVATIONS ARE READ (YES=1,NO=0)
 CALCULATIONS ARE WRITTEN TO TAPE (YES=1,NO=0)
 LIST ALL INPUT DATA (NO=0,YES=1,MET DATA ALSO=2)

ISW(1) = 1
 ISW(2) = 4
 ISW(3) = 2
 ISW(4) = 0
 ISW(5) = 0
 ISW(6) = 1

COMPUTE AVERAGE CONCENTRATION (OR TOTAL DEPOSITION)
 WITH THE FOLLOWING TIME PERIODS:

HOURLY (YES=1,NO=0)
 2-HOUR (YES=1,NO=0)
 3-HOUR (YES=1,NO=0)
 4-HOUR (YES=1,NO=0)
 6-HOUR (YES=1,NO=0)
 8-HOUR (YES=1,NO=0)
 12-HOUR (YES=1,NO=0)
 24-HOUR (YES=1,NO=0)

ISW(7) = 0
 ISW(8) = 0
 ISW(9) = 0
 ISW(10) = 0
 ISW(11) = 0
 ISW(12) = 0
 ISW(13) = 0
 ISW(14) = 0
 ISW(15) = 1

PRINT 'N'-DAY TABLE(S) (YES=1,NO=0)

PRINT THE FOLLOWING TYPES OF TABLES WHOSE TIME PERIODS ARE
 SPECIFIED BY ISW(7) THROUGH ISW(14):

DAILY TABLES (YES=1,NO=0)
 HIGHEST & SECOND HIGHEST TABLES (YES=1,NO=0)
 MAXIMUM 50 TABLES (YES=1,NO=0)
 METEOROLOGICAL DATA INPUT METHOD (PRE-PROCESSED=1,CARD=2)
 RURAL-URBAN OPTION (RU.=0,UR. MODE 1=1,UR. MODE 2=2,UR. MODE 3=3)
 WIND PROFILE EXPONENT VALUES (DEFAULTS=1,USER ENTERS=2,3)
 VERTICAL POT. TEMP. GRADIENT VALUES (DEFAULTS=1,USER ENTERS=2,3)
 SCALE EMISSION RATES FOR ALL SOURCES (NO=0,YES>0)
 PROGRAM CALCULATES FINAL PLUME RISE ONLY (YES=1,NO=2)
 PROGRAM ADJUSTS ALL STACK HEIGHTS FOR DOWNWASH (YES=2,NO=1)
 PROGRAM USES BUOYANCY INDUCED DISPERSION (YES=1,NO=2)
 CONCENTRATIONS DURING CALM PERIODS SET = 0 (YES=1,NO=2)
 REG. DEFAULT OPTION CHOSEN (YES=1,NO=2)
 TYPE OF POLLUTANT TO BE MODELLED (1=S02,2=OTHER)
 DEBUG OPTION CHOSEN (YES=1,NO=2)
 ABOVE GROUND (FLAGPOLE) RECEPTORS USED (YES=1,NO=0)

ISW(16) = 0
 ISW(17) = 0
 ISW(18) = 0
 ISW(19) = 1
 ISW(20) = 0
 ISW(21) = 1
 ISW(22) = 1
 ISW(23) = 0
 ISW(24) = 1
 ISW(25) = 2
 ISW(26) = 1
 ISW(27) = 1
 ISW(28) = 1
 ISW(29) = 2
 ISW(30) = 2
 ISW(31) = 0

NUMBER OF INPUT SOURCES
 NUMBER OF SOURCE GROUPS (=0,ALL SOURCES)
 TIME PERIOD INTERVAL TO BE PRINTED (=0,ALL INTERVALS)
 NUMBER OF X (RANGE) GRID VALUES
 NUMBER OF Y (THETA) GRID VALUES
 NUMBER OF DISCRETE RECEPTORS
 SOURCE EMISSION RATE UNITS CONVERSION FACTOR
 HEIGHT ABOVE GROUND AT WHICH WIND SPEED WAS MEASURED
 LOGICAL UNIT NUMBER OF METEOROLOGICAL DATA
 DECAY COEFFICIENT FOR PHYSICAL OR CHEMICAL DEPLETION
 SURFACE STATION NO.
 YEAR OF SURFACE DATA
 UPPER AIR STATION NO.
 YEAR OF UPPER AIR DATA
 ALLOCATED DATA STORAGE
 REQUIRED DATA STORAGE FOR THIS PROBLEM RUN

NSOURC = 1
 NGROUP = 0
 IPERD = 0
 NXPNTS = 4
 NYPNTS = 36
 NXWYPT = 238
 TK = .10000E+07
 ZR = 7.01 METERS
 IMET = 9
 DECAY = 0.000000E+00
 ISS = 12839
 ISY = 82
 IUS = 12844
 IUY = 82
 LIMIT = 43500 WORDS
 MIMIT = 1949 WORDS

*** RANGES OF POLAR GRID SYSTEM ***
(METERS)

3000.0, 3500.0, 4000.0, 4500.0,

*** RADIAL ANGLES OF POLAR GRID SYSTEM ***

(DEGREES)

10.0,	20.0,	30.0,	40.0,	50.0,	60.0,	70.0,	80.0,	90.0,	100.0,
110.0,	120.0,	130.0,	140.0,	150.0,	160.0,	170.0,	180.0,	190.0,	200.0,
210.0,	220.0,	230.0,	240.0,	250.0,	260.0,	270.0,	280.0,	290.0,	300.0,
310.0,	320.0,	330.0,	340.0,	350.0,	360.0,				

*** RANGE, THETA COORDINATES OF DISCRETE RECEPTORS ***
(METERS, DEGREES)

(336.0, 10.0),	(500.0, 10.0),	(800.0, 10.0),	(1100.0, 10.0),	(1500.0, 10.0),
(2000.0, 10.0),	(2500.0, 10.0),	(230.0, 20.0),	(300.0, 20.0),	(500.0, 20.0),
(800.0, 20.0),	(1100.0, 20.0),	(1500.0, 20.0),	(2000.0, 20.0),	(2500.0, 20.0),
(211.0, 30.0),	(300.0, 30.0),	(500.0, 30.0),	(800.0, 30.0),	(1100.0, 30.0),
(1500.0, 30.0),	(2000.0, 30.0),	(2500.0, 30.0),	(211.0, 40.0),	(300.0, 40.0),
(500.0, 40.0),	(800.0, 40.0),	(1100.0, 40.0),	(1500.0, 40.0),	(2000.0, 40.0),
(2500.0, 40.0),	(211.0, 50.0),	(300.0, 50.0),	(500.0, 50.0),	(800.0, 50.0),
(1100.0, 50.0),	(1500.0, 50.0),	(2000.0, 50.0),	(2500.0, 50.0),	(221.0, 60.0),
(300.0, 60.0),	(500.0, 60.0),	(800.0, 60.0),	(1100.0, 60.0),	(1500.0, 60.0),
(2000.0, 60.0),	(2500.0, 60.0),	(230.0, 70.0),	(300.0, 70.0),	(500.0, 70.0),
(800.0, 70.0),	(1100.0, 70.0),	(1500.0, 70.0),	(2000.0, 70.0),	(2500.0, 70.0),
(202.0, 80.0),	(300.0, 80.0),	(500.0, 80.0),	(800.0, 80.0),	(1100.0, 80.0),
(1500.0, 80.0),	(2000.0, 80.0),	(2500.0, 80.0),	(192.0, 90.0),	(300.0, 90.0),
(500.0, 90.0),	(800.0, 90.0),	(1100.0, 90.0),	(1500.0, 90.0),	(2000.0, 90.0),
(2500.0, 90.0),	(192.0, 100.0),	(300.0, 100.0),	(500.0, 100.0),	(800.0, 100.0),
(1100.0, 100.0),	(1500.0, 100.0),	(2000.0, 100.0),	(2500.0, 100.0),	(211.0, 100.0),
(300.0, 110.0),	(500.0, 110.0),	(800.0, 110.0),	(1100.0, 110.0),	(1500.0, 110.0),
(2000.0, 110.0),	(2500.0, 110.0),	(211.0, 120.0),	(300.0, 120.0),	(500.0, 120.0),
(800.0, 120.0),	(1100.0, 120.0),	(1500.0, 120.0),	(2000.0, 120.0),	(2500.0, 120.0),
(278.0, 130.0),	(300.0, 130.0),	(500.0, 130.0),	(800.0, 130.0),	(1100.0, 130.0),
(1500.0, 130.0),	(2000.0, 130.0),	(2500.0, 130.0),	(250.0, 140.0),	(300.0, 140.0),
(500.0, 140.0),	(800.0, 140.0),	(1100.0, 140.0),	(1500.0, 140.0),	(2000.0, 140.0),
(2500.0, 140.0),	(221.0, 150.0),	(300.0, 150.0),	(500.0, 150.0),	(800.0, 150.0),
(1100.0, 150.0),	(1500.0, 150.0),	(2000.0, 150.0),	(2500.0, 150.0),	(326.0, 160.0),
(500.0, 160.0),	(800.0, 160.0),	(1100.0, 160.0),	(1500.0, 160.0),	(2000.0, 160.0),
(2500.0, 160.0),	(461.0, 170.0),	(500.0, 170.0),	(800.0, 170.0),	(1100.0, 170.0),
(1500.0, 170.0),	(2000.0, 170.0),	(2500.0, 170.0),	(451.0, 180.0),	(500.0, 180.0),
(800.0, 180.0),	(1100.0, 180.0),	(1500.0, 180.0),	(2000.0, 180.0),	(2500.0, 180.0),
(461.0, 190.0),	(500.0, 190.0),	(800.0, 190.0),	(1100.0, 190.0),	(1500.0, 190.0),
(2000.0, 190.0),	(2500.0, 190.0),	(470.0, 200.0),	(500.0, 200.0),	(800.0, 200.0),
(1100.0, 200.0),	(1500.0, 200.0),	(2000.0, 200.0),	(2500.0, 200.0),	(509.0, 210.0),
(800.0, 210.0),	(1100.0, 210.0),	(1500.0, 210.0),	(2000.0, 210.0),	(2500.0, 210.0),
(576.0, 220.0),	(800.0, 220.0),	(1100.0, 220.0),	(1500.0, 220.0),	(2000.0, 220.0),
(2500.0, 220.0),	(701.0, 230.0),	(800.0, 230.0),	(1100.0, 230.0),	(1500.0, 230.0),
(2000.0, 230.0),	(2500.0, 230.0),	(739.0, 240.0),	(800.0, 240.0),	(1100.0, 240.0),
(1500.0, 240.0),	(2000.0, 240.0),	(2500.0, 240.0),	(835.0, 250.0),	(1100.0, 250.0),
(1500.0, 250.0),	(2000.0, 250.0),	(2500.0, 250.0),	(1094.0, 260.0),	(1100.0, 260.0),
(1500.0, 260.0),	(2000.0, 260.0),	(2500.0, 260.0),	(1085.0, 270.0),	(1100.0, 270.0),
(1500.0, 270.0),	(2000.0, 270.0),	(2500.0, 270.0),	(1114.0, 280.0),	(1500.0, 280.0),
(2000.0, 280.0),	(2500.0, 280.0),	(1613.0, 290.0),	(2000.0, 290.0),	(2500.0, 290.0),
(1766.0, 300.0),	(2000.0, 300.0),	(2500.0, 300.0),	(1766.0, 310.0),	(2000.0, 310.0),
(2500.0, 310.0),	(1488.0, 320.0),	(1500.0, 320.0),	(2000.0, 320.0),	(2500.0, 320.0),
(374.0, 330.0),	(500.0, 330.0),	(800.0, 330.0),	(1100.0, 330.0),	(1500.0, 330.0),
(2000.0, 330.0),	(2500.0, 330.0),	(346.0, 340.0),	(500.0, 340.0),	(800.0, 340.0),
(1100.0, 340.0),	(1500.0, 340.0),	(2000.0, 340.0),	(2500.0, 340.0),	(336.0, 350.0),
(500.0, 350.0),	(800.0, 350.0),	(1100.0, 350.0),	(1500.0, 350.0),	(2000.0, 350.0),
(2500.0, 350.0),	(326.0, 360.0),	(500.0, 360.0),	(800.0, 360.0),	(1100.0, 360.0),
(1500.0, 360.0),	(2000.0, 360.0),	(2500.0, 360.0),	(

*** SOURCE DATA ***

SOURCE NUMBER	PK E	PART. CATS.	EMISSION RATE				BASE ELEV.	HEIGHT	TEMP. (DEG.K); VERT.DIM	EXIT VEL. (M/SEC); HORZ.DIM	DIAMETER	BLDG. HEIGHT	BLDG. LENGTH	BLDG. WIDTH							
			TYPE=0,1 (GRAMS/SEC)		TYPE=2 (GRAMS/SEC)										X (METERS)	Y (METERS)	TYPE=1 (METERS)	TYPE=1,2 (METERS)	TYPE=0 (METERS)	TYPE=0 (METERS)	TYPE=0 (METERS)
			PER METER**2																		
3	0	0	0.28200E+01			70.0	-25.2	0.0	61.00	450.00	11.04	4.57	27.40	35.10	35.10						
*			CALM HOURS (=1) FOR DAY	1	*	0	0	0	0	0	0	0	0	0	0	0					
			CALM HOURS (=1) FOR DAY	2	*	0	0	0	0	0	0	0	0	0	0	0					
			CALM HOURS (=1) FOR DAY	7	*	0	0	1	1	0	1	0	0	0	0	0					
			CALM HOURS (=1) FOR DAY	8	*	0	0	0	1	0	0	0	0	0	0	0					
			CALM HOURS (=1) FOR DAY	16	*	0	0	0	0	0	0	0	0	0	0	0					
			CALM HOURS (=1) FOR DAY	17	*	0	0	0	0	0	0	0	0	0	0	0					
			CALM HOURS (=1) FOR DAY	18	*	1	0	0	0	0	0	0	0	0	0	0					
			CALM HOURS (=1) FOR DAY	19	*	1	0	1	1	0	0	0	0	0	0	0					
			CALM HOURS (=1) FOR DAY	20	*	0	1	1	1	0	0	0	0	0	0	0					
			CALM HOURS (=1) FOR DAY	21	*	0	0	0	0	0	1	0	1	1	0	0					
			CALM HOURS (=1) FOR DAY	24	*	0	0	1	0	0	0	0	0	0	0	0					
			CALM HOURS (=1) FOR DAY	37	*	0	0	0	0	0	0	0	0	0	0	0					
			CALM HOURS (=1) FOR DAY	38	*	1	0	0	0	0	0	0	0	0	0	0					
			CALM HOURS (=1) FOR DAY	42	*	1	1	0	0	1	0	0	1	0	0	0					
			CALM HOURS (=1) FOR DAY	48	*	0	0	0	0	0	0	0	0	0	0	0					
			CALM HOURS (=1) FOR DAY	56	*	0	0	1	1	0	0	0	0	0	0	0					
			CALM HOURS (=1) FOR DAY	57	*	1	0	0	0	0	0	0	0	0	0	0					
			CALM HOURS (=1) FOR DAY	59	*	0	0	0	0	0	0	0	0	0	0	0					
			CALM HOURS (=1) FOR DAY	62	*	0	0	0	1	0	0	0	0	0	0	0					
			CALM HOURS (=1) FOR DAY	70	*	0	0	1	0	0	0	0	0	0	0	0					
			CALM HOURS (=1) FOR DAY	71	*	0	0	0	0	0	0	0	0	0	0	0					
			CALM HOURS (=1) FOR DAY	72	*	0	0	0	1	0	1	0	0	0	0	0					
			CALM HOURS (=1) FOR DAY	73	*	0	0	0	0	0	0	0	0	0	0	0					
			CALM HOURS (=1) FOR DAY	77	*	1	0	0	0	0	0	0	0	0	0	0					
			CALM HOURS (=1) FOR DAY	79	*	0	1	0	0	0	1	0	0	0	0	0					
			CALM HOURS (=1) FOR DAY	80	*	0	0	0	1	0	1	1	0	0	0	0					
			CALM HOURS (=1) FOR DAY	81	*	1	0	0	1	0	0	0	0	0	0	0					
			CALM HOURS (=1) FOR DAY	82	*	1	1	0	0	0	1	1	0	0	0	0					
			CALM HOURS (=1) FOR DAY	83	*	1	0	0	0	1	1	0	0	0	0	0					
			CALM HOURS (=1) FOR DAY	84	*	0	0	0	0	0	0	0	0	0	0	0					
			CALM HOURS (=1) FOR DAY	91	*	0	0	1	0	0	0	0	0	0	0	0					
			CALM HOURS (=1) FOR DAY	100	*	0	0	0	1	0	0	0	0	0	0	0					
			CALM HOURS (=1) FOR DAY	105	*	0	0	0	0	0	1	0	0	0	0	0					
			CALM HOURS (=1) FOR DAY	108	*	0	0	0	0	0	0	0	0	0	0	0					
			CALM HOURS (=1) FOR DAY	109	*	1	1	1	1	0	1	1	0	0	0	0					
			CALM HOURS (=1) FOR DAY	113	*	1	0	0	0	1	0	0	0	0	0	0					
			CALM HOURS (=1) FOR DAY	128	*	0	0	0	0	0	1	0	0	0	0	0					
			CALM HOURS (=1) FOR DAY	129	*	0	0	0	1	0	1	1	0	0	0	0					
			CALM HOURS (=1) FOR DAY	140	*	0	0	0	1	0	0	0	0	0	0	0					
			CALM HOURS (=1) FOR DAY	142	*	0	0	0	0	0	1	0	0	0	0	0					
			CALM HOURS (=1) FOR DAY	143	*	0	0	0	0	0	0	0	0	0	0	0					
			CALM HOURS (=1) FOR DAY	148	*	0	0	0	0	0	0	0	0	0	0	0					
			CALM HOURS (=1) FOR DAY	152	*	0	0	0	0	0	0	0	0	0	0	0					
			CALM HOURS (=1) FOR DAY	154	*	0	0	0	1	0	0	0	0	0	0	0					
			CALM HOURS (=1) FOR DAY	158	*	0	0	1	0	1	1	0	0	0	0	0					
			CALM HOURS (=1) FOR DAY	159	*	0	0	0	0	0	1	0	0	0	0	0					
			CALM HOURS (=1) FOR DAY	160	*	0	0	0	0	1	0	0	0	0	0	0					
			CALM HOURS (=1) FOR DAY	161	*	0	0	0	0	0	0	0	0	0	0	0					
			CALM HOURS (=1) FOR DAY	164	*	0	0	1	0	1	1	0	0	0	0	0					
			CALM HOURS (=1) FOR DAY	165	*	1	1	1	0	0	1	0	0	0	0	0					

CALM HOURS (=1) FOR DAY 321 * 0 0 1 1 0 0 1 0 0 0 0 0 0 0 0 0 0 0 0 0 0 0 0 0
* CALM HOURS (=1) FOR DAY 322 * 0 0 0 0 0 0 1 0 0 0 0 0 0 0 0 0 0 0 0 0 0 0 0 0
CALM HOURS (=1) FOR DAY 324 * 0 0 0 0 0 0 1 0 0 0 0 0 0 0 0 0 0 0 0 0 0 0 0 0
CALM HOURS (=1) FOR DAY 340 * 0 1 1 1 1 0
CALM HOURS (=1) FOR DAY 343 * 0 0 0 1 0
* CALM HOURS (=1) FOR DAY 355 * 0 0 0 0 0 0 1 1 0 0 0 0 0 0 0 0 0 0 0 0 0 0 0 1 0
CALM HOURS (=1) FOR DAY 356 * 0 0 1 0
CALM HOURS (=1) FOR DAY 363 * 0 0 0 0 0 1 0 0 0 0 0 0 0 0 0 0 0 0 0 0 0 0 0 0 0
* CALM HOURS (=1) FOR DAY 364 * 0 0 0 0 0 0 1 1 0 0 0 0 0 0 0 0 0 0 0 0 0 0 0 0 0
* CALM HOURS (=1) FOR DAY 365 * 0 0 0 0 1 0

*** ISCST BY KBN 1/90 *** 1982 TARMAC KILN 3 NOX Increase

10-23-90 ***

* 365-DAY AVERAGE CONCENTRATION (MICROGRAMS/CUBIC METER) *

* FROM ALL SOURCES *
* FOR THE RECEPTOR GRID *

* MAXIMUM VALUE EQUALS 0.05238 AND OCCURRED AT (3000.0, 300.0) *

DIRECTION / RANGE (METERS)
DEGREES) / 3000.0 3500.0 4000.0 4500.0

DIRECTION / DEGREES) /	3000.0	3500.0	4000.0	4500.0
360.0 /	0.01129	0.01084	0.01039	0.00994
350.0 /	0.01668	0.01565	0.01467	0.01377
340.0 /	0.02510	0.02307	0.02122	0.01961
330.0 /	0.03831	0.03477	0.03155	0.02875
320.0 /	0.05109	0.04761	0.04420	0.04106
310.0 /	0.04971	0.04673	0.04375	0.04096
300.0 /	0.05238	0.05100	0.04935	0.04755
290.0 /	0.04230	0.04163	0.04071	0.03960
280.0 /	0.03748	0.03749	0.03711	0.03641
270.0 /	0.02887	0.02923	0.02927	0.02901
260.0 /	0.02749	0.02720	0.02667	0.02596
250.0 /	0.03245	0.03223	0.03166	0.03087
240.0 /	0.03170	0.03182	0.03155	0.03097
230.0 /	0.01800	0.01809	0.01797	0.01767
220.0 /	0.01040	0.01045	0.01038	0.01020
210.0 /	0.00646	0.00653	0.00651	0.00643
200.0 /	0.00627	0.00641	0.00646	0.00645
190.0 /	0.00776	0.00794	0.00801	0.00800
180.0 /	0.00836	0.00863	0.00878	0.00885
170.0 /	0.01171	0.01214	0.01240	0.01253
160.0 /	0.01381	0.01438	0.01473	0.01489
150.0 /	0.00947	0.00941	0.00926	0.00906
140.0 /	0.00673	0.00649	0.00623	0.00598
130.0 /	0.00749	0.00719	0.00690	0.00662
120.0 /	0.00612	0.00580	0.00546	0.00516
110.0 /	0.00397	0.00389	0.00379	0.00368
100.0 /	0.00464	0.00463	0.00457	0.00448
90.0 /	0.00403	0.00391	0.00378	0.00363
80.0 /	0.00340	0.00326	0.00313	0.00302
70.0 /	0.00356	0.00342	0.00331	0.00322
60.0 /	0.00346	0.00329	0.00312	0.00296
50.0 /	0.00420	0.00400	0.00380	0.00362
40.0 /	0.00550	0.00544	0.00532	0.00517
30.0 /	0.00494	0.00479	0.00461	0.00443
20.0 /	0.00541	0.00521	0.00502	0.00483
10.0 /	0.00796	0.00771	0.00746	0.00722

*** ISCST BY KBN 1/90 *** 1982 TARMAC KILN 3 NOX Increase

10-23-90 ***

* 365-DAY AVERAGE CONCENTRATION (MICROGRAMS/CUBIC METER) *

* FROM ALL SOURCES *

* FOR THE DISCRETE RECEPTOR POINTS *

- RNG -	- DIR -	CON.	- RNG -	- DIR -	CON.	- RNG -	- DIR -	CON.
336.0	10.0	0.00093	500.0	10.0	0.00094	800.0	10.0	0.00384
1100.0	10.0	0.00563	1500.0	10.0	0.00706	2000.0	10.0	0.00798
2500.0	10.0	0.00811	230.0	20.0	0.00100	300.0	20.0	0.00128
500.0	20.0	0.00082	800.0	20.0	0.00248	1100.0	20.0	0.00379
1500.0	20.0	0.00486	2000.0	20.0	0.00552	2500.0	20.0	0.00556
211.0	30.0	0.00111	300.0	30.0	0.00196	500.0	30.0	0.00112
800.0	30.0	0.00170	1100.0	30.0	0.00286	1500.0	30.0	0.00401
2000.0	30.0	0.00481	2500.0	30.0	0.00500	211.0	40.0	0.00151
300.0	40.0	0.00265	500.0	40.0	0.00150	800.0	40.0	0.00157
1100.0	40.0	0.00277	1500.0	40.0	0.00406	2000.0	40.0	0.00504
2500.0	40.0	0.00541	211.0	50.0	0.00191	300.0	50.0	0.00295
500.0	50.0	0.00127	800.0	50.0	0.00170	1100.0	50.0	0.00290
1500.0	50.0	0.00379	2000.0	50.0	0.00430	2500.0	50.0	0.00433
221.0	60.0	0.00155	300.0	60.0	0.00166	500.0	60.0	0.00108
800.0	60.0	0.00167	1100.0	60.0	0.00265	1500.0	60.0	0.00321
2000.0	60.0	0.00357	2500.0	60.0	0.00358	230.0	70.0	0.00081
300.0	70.0	0.00078	500.0	70.0	0.00044	800.0	70.0	0.00122
1100.0	70.0	0.00240	1500.0	70.0	0.00317	2000.0	70.0	0.00365
2500.0	70.0	0.00367	202.0	80.0	0.00048	300.0	80.0	0.00159
500.0	80.0	0.00111	800.0	80.0	0.00131	1100.0	80.0	0.00235
1500.0	80.0	0.00311	2000.0	80.0	0.00353	2500.0	80.0	0.00353
192.0	90.0	0.00070	300.0	90.0	0.00124	500.0	90.0	0.00136
800.0	90.0	0.00162	1100.0	90.0	0.00245	1500.0	90.0	0.00326
2000.0	90.0	0.00389	2500.0	90.0	0.00407	192.0	100.0	0.00105
300.0	100.0	0.00239	500.0	100.0	0.00193	800.0	100.0	0.00191
1100.0	100.0	0.00247	1500.0	100.0	0.00327	2000.0	100.0	0.00414
2500.0	100.0	0.00451	211.0	100.0	0.00128	300.0	110.0	0.00215
500.0	110.0	0.00143	800.0	110.0	0.00192	1100.0	110.0	0.00261
1500.0	110.0	0.00315	2000.0	110.0	0.00376	2500.0	110.0	0.00397
211.0	120.0	0.00237	300.0	120.0	0.00359	500.0	120.0	0.00228
800.0	120.0	0.00254	1100.0	120.0	0.00388	1500.0	120.0	0.00520
2000.0	120.0	0.00618	2500.0	120.0	0.00632	278.0	130.0	0.00192
300.0	130.0	0.00222	500.0	130.0	0.00166	800.0	130.0	0.00197
1100.0	130.0	0.00407	1500.0	130.0	0.00610	2000.0	130.0	0.00741
2500.0	130.0	0.00765	250.0	140.0	0.00361	300.0	140.0	0.00359
500.0	140.0	0.00127	800.0	140.0	0.00127	1100.0	140.0	0.00335
1500.0	140.0	0.00536	2000.0	140.0	0.00658	2500.0	140.0	0.00684
221.0	150.0	0.00545	300.0	150.0	0.00890	500.0	150.0	0.00386

*** ISCST BY KBN 1/90 *** 1982 TARMAC KILN 3 NOX Increase

10-23-90 ***

* 365-DAY AVERAGE CONCENTRATION (MICROGRAMS/CUBIC METER) *

* FROM ALL SOURCES *
* FOR THE DISCRETE RECEPTOR POINTS *

- RNG -	- DIR -	CON.	- RNG -	- DIR -	CON.	- RNG -	- DIR -	CON.
800.0	150.0	0.00207	1100.0	150.0	0.00409	1500.0	150.0	0.00670
2000.0	150.0	0.00859	2500.0	150.0	0.00928	326.0	160.0	0.00857
500.0	160.0	0.00403	800.0	160.0	0.00272	1100.0	160.0	0.00486
1500.0	160.0	0.00819	2000.0	160.0	0.01119	2500.0	160.0	0.01280
461.0	170.0	0.00197	500.0	170.0	0.00188	800.0	170.0	0.00209
1100.0	170.0	0.00416	1500.0	170.0	0.00700	2000.0	170.0	0.00956
2500.0	170.0	0.01093	451.0	180.0	0.00073	500.0	180.0	0.00058
800.0	180.0	0.00096	1100.0	180.0	0.00265	1500.0	180.0	0.00473
2000.0	180.0	0.00671	2500.0	180.0	0.00779	461.0	190.0	0.00060
500.0	190.0	0.00052	800.0	190.0	0.00104	1100.0	190.0	0.00276
1500.0	190.0	0.00472	2000.0	190.0	0.00643	2500.0	190.0	0.00733
470.0	200.0	0.00046	500.0	200.0	0.00042	800.0	200.0	0.00101
1100.0	200.0	0.00244	1500.0	200.0	0.00398	2000.0	200.0	0.00528
2500.0	200.0	0.00593	509.0	210.0	0.00090	800.0	210.0	0.00150
1100.0	210.0	0.00298	1500.0	210.0	0.00447	2000.0	210.0	0.00564
2500.0	210.0	0.00620	576.0	220.0	0.00369	800.0	220.0	0.00327
1100.0	220.0	0.00515	1500.0	220.0	0.00743	2000.0	220.0	0.00921
2500.0	220.0	0.01003	701.0	230.0	0.00677	800.0	230.0	0.00685
1100.0	230.0	0.00982	1500.0	230.0	0.01348	2000.0	230.0	0.01623
2500.0	230.0	0.01740	739.0	240.0	0.00989	800.0	240.0	0.01045
1100.0	240.0	0.01641	1500.0	240.0	0.02344	2000.0	240.0	0.02855
2500.0	240.0	0.03068	835.0	250.0	0.01070	1100.0	250.0	0.01702
1500.0	250.0	0.02474	2000.0	250.0	0.02994	2500.0	250.0	0.03181
1094.0	260.0	0.01466	1100.0	260.0	0.01478	1500.0	260.0	0.02136
2000.0	260.0	0.02568	2500.0	260.0	0.02708	1085.0	270.0	0.01418
1100.0	270.0	0.01447	1500.0	270.0	0.02093	2000.0	270.0	0.02566
2500.0	270.0	0.02773	1114.0	280.0	0.01981	1500.0	280.0	0.02810
2000.0	280.0	0.03416	2500.0	280.0	0.03650	1613.0	290.0	0.03626
2000.0	290.0	0.04046	2500.0	290.0	0.04212	1766.0	300.0	0.04824
2000.0	300.0	0.05088	2500.0	300.0	0.05267	1766.0	310.0	0.04940
2000.0	310.0	0.05152	2500.0	310.0	0.05183	1488.0	320.0	0.04628
1500.0	320.0	0.04659	2000.0	320.0	0.05372	2500.0	320.0	0.05373
374.0	330.0	0.00432	500.0	330.0	0.00372	800.0	330.0	0.01426
1100.0	330.0	0.02767	1500.0	330.0	0.03855	2000.0	330.0	0.04291
2500.0	330.0	0.04153	346.0	340.0	0.00189	500.0	340.0	0.00152
800.0	340.0	0.00950	1100.0	340.0	0.01813	1500.0	340.0	0.02478
2000.0	340.0	0.02760	2500.0	340.0	0.02693	336.0	350.0	0.00080
500.0	350.0	0.00097	800.0	350.0	0.00654	1100.0	350.0	0.01166

*** ISCST BY KBN 1/90 *** 1982 TARMAC KILN 3 NOX Increase

10-23-90 ***

* 365-DAY AVERAGE CONCENTRATION (MICROGRAMS/CUBIC METER) *

* FROM ALL SOURCES *

* FOR THE DISCRETE RECEPTOR POINTS *

- RNG -	- DIR -	CON.	- RNG -	- DIR -	CON.	- RNG -	- DIR -	CON.
1500.0	350.0	0.01562	2000.0	350.0	0.01762	2500.0	350.0	0.01752
326.0	360.0	0.00096	500.0	360.0	0.00103	800.0	360.0	0.00498
1100.0	360.0	0.00787	1500.0	360.0	0.01009	2000.0	360.0	0.01143
2500.0	360.0	0.01159						

ISCSTK6E MODEL, A VERSION OF
ISCST (VERSION 88348)
AN AIR QUALITY DISPERSION MODEL IN
SECTION 1. GUIDELINE MODELS.
IN UNAMAP (VERSION 6) DEC 1988.
SOURCE: FILE 6 ON UNAMAP MAGNETIC TAPE FROM NTIS.
(Based on Version 3.4 to UNAMAP, Dec 15, 1988)

CONVERTED BY :
KBN ENGINEERING AND APPLIED SCIENCES, INC.
GAINESVILLE, FLORIDA
(904)331-9000

COPYRIGHT 1990 L

CARD INPUT File is aqlk3.i83
SUMMARY OUTPUT File is aqlk3.o83
METEOROLOGICAL FILE is miapr183.bin
TITLE OF RUN is 1983 TARMAC KILN 3 NOX Increase 10-23-90

NOTE THAT THE BUILDING DIMENSIONS ON CARD 6,1 FOR SOURCE NO. 3 DO NOT MEET THE SCHULMAN-SCIRE CRITERIA.
THEREFORE, DIRECTION SPECIFIC BUILDING DIMENSIONS WILL NOT BE USED BY THE MODEL.

CALCULATE (CONCENTRATION=1,DEPOSITION=2)	ISW(1) = 1
RECEPTOR GRID SYSTEM (RECTANGULAR=1 OR 3, POLAR=2 OR 4)	ISW(2) = 4
DISCRETE RECEPTOR SYSTEM (RECTANGULAR=1,POLAR=2)	ISW(3) = 2
TERRAIN ELEVATIONS ARE READ (YES=1,NO=0)	ISW(4) = 0
CALCULATIONS ARE WRITTEN TO TAPE (YES=1,NO=0)	ISW(5) = 0
LIST ALL INPUT DATA (NO=0,YES=1,MET DATA ALSO=2)	ISW(6) = 1
COMPUTE AVERAGE CONCENTRATION (OR TOTAL DEPOSITION)	
WITH THE FOLLOWING TIME PERIODS:	
HOURLY (YES=1,NO=0)	ISW(7) = 0
2-HOUR (YES=1,NO=0)	ISW(8) = 0
3-HOUR (YES=1,NO=0)	ISW(9) = 0
4-HOUR (YES=1,NO=0)	ISW(10) = 0
6-HOUR (YES=1,NO=0)	ISW(11) = 0
8-HOUR (YES=1,NO=0)	ISW(12) = 0
12-HOUR (YES=1,NO=0)	ISW(13) = 0
24-HOUR (YES=1,NO=0)	ISW(14) = 0
PRINT 'N'-DAY TABLE(S) (YES=1,NO=0)	ISW(15) = 1
PRINT THE FOLLOWING TYPES OF TABLES WHOSE TIME PERIODS ARE SPECIFIED BY ISW(7) THROUGH ISW(14):	
DAILY TABLES (YES=1,NO=0)	ISW(16) = 0
HIGHEST & SECOND HIGHEST TABLES (YES=1,NO=0)	ISW(17) = 0
MAXIMUM 50 TABLES (YES=1,NO=0)	ISW(18) = 0
METEOROLOGICAL DATA INPUT METHOD (PRE-PROCESSED=1,CARD=2)	ISW(19) = 1
RURAL-URBAN OPTION (RU.=0,UR. MODE 1=1,UR. MODE 2=2,UR. MODE 3=3)	ISW(20) = 0
WIND PROFILE EXPONENT VALUES (DEFAULTS=1,USER ENTERS=2,3)	ISW(21) = 1
VERTICAL POT. TEMP. GRADIENT VALUES (DEFAULTS=1,USER ENTERS=2,3)	ISW(22) = 1
SCALE EMISSION RATES FOR ALL SOURCES (NO=0,YES>0)	ISW(23) = 0
PROGRAM CALCULATES FINAL PLUME RISE ONLY (YES=1,NO=2)	ISW(24) = 1
PROGRAM ADJUSTS ALL STACK HEIGHTS FOR DOWNWASH (YES=2,NO=1)	ISW(25) = 2
PROGRAM USES BUOYANCY INDUCED DISPERSION (YES=1,NO=2)	ISW(26) = 1
CONCENTRATIONS DURING CALM PERIODS SET = 0 (YES=1,NO=2)	ISW(27) = 1
REG. DEFAULT OPTION CHOSEN (YES=1,NO=2)	ISW(28) = 1
TYPE OF POLLUTANT TO BE MODELLED (1=S02,2=OTHER)	ISW(29) = 2
DEBUG OPTION CHOSEN (YES=1,NO=2)	ISW(30) = 2
ABOVE GROUND (FLAGPOLE) RECEPTORS USED (YES=1,NO=0)	ISW(31) = 0
NUMBER OF INPUT SOURCES	NSOURC = 1
NUMBER OF SOURCE GROUPS (=0,ALL SOURCES)	NGROUP = 0
TIME PERIOD INTERVAL TO BE PRINTED (=0,ALL INTERVALS)	IPERD = 0
NUMBER OF X (RANGE) GRID VALUES	NXPNTS = 4
NUMBER OF Y (THETA) GRID VALUES	NYPNTS = 36
NUMBER OF DISCRETE RECEPTORS	NXWYPT = 238
SOURCE EMISSION RATE UNITS CONVERSION FACTOR	TK = .10000E+07
HEIGHT ABOVE GROUND AT WHICH WIND SPEED WAS MEASURED	ZR = 7.01 METERS
LOGICAL UNIT NUMBER OF METEOROLOGICAL DATA	IMET = 9
DECAY COEFFICIENT FOR PHYSICAL OR CHEMICAL DEPLETION	DECAY = 0.000000E+00
SURFACE STATION NO.	ISS = 12839
YEAR OF SURFACE DATA	ISY = 83
UPPER AIR STATION NO.	IUS = 12844
YEAR OF UPPER AIR DATA	IUY = 83
ALLOCATED DATA STORAGE	LIMIT = 43500 WORDS
REQUIRED DATA STORAGE FOR THIS PROBLEM RUN	MIMIT = 1949 WORDS

*** RANGES OF POLAR GRID SYSTEM ***
(METERS)

3000.0, 3500.0, 4000.0, 4500.0,

*** RADIAL ANGLES OF POLAR GRID SYSTEM ***

(DEGREES)

10.0,	20.0,	30.0,	40.0,	50.0,	60.0,	70.0,	80.0,	90.0,	100.0,
110.0,	120.0,	130.0,	140.0,	150.0,	160.0,	170.0,	180.0,	190.0,	200.0,
210.0,	220.0,	230.0,	240.0,	250.0,	260.0,	270.0,	280.0,	290.0,	300.0,
310.0,	320.0,	330.0,	340.0,	350.0,	360.0,				

*** RANGE, THETA COORDINATES OF DISCRETE RECEPTORS ***
(METERS, DEGREES)

(336.0,	10.0),	(500.0,	10.0),	(800.0,	10.0),	(1100.0,	10.0),	(1500.0,	10.0),
(2000.0,	10.0),	(2500.0,	10.0),	(230.0,	20.0),	(300.0,	20.0),	(500.0,	20.0),
(800.0,	20.0),	(1100.0,	20.0),	(1500.0,	20.0),	(2000.0,	20.0),	(2500.0,	20.0),
(211.0,	30.0),	(300.0,	30.0),	(500.0,	30.0),	(800.0,	30.0),	(1100.0,	30.0),
(1500.0,	30.0),	(2000.0,	30.0),	(2500.0,	30.0),	(211.0,	40.0),	(300.0,	40.0),
(500.0,	40.0),	(800.0,	40.0),	(1100.0,	40.0),	(1500.0,	40.0),	(2000.0,	40.0),
(2500.0,	40.0),	(211.0,	50.0),	(300.0,	50.0),	(500.0,	50.0),	(800.0,	50.0),
(1100.0,	50.0),	(1500.0,	50.0),	(2000.0,	50.0),	(2500.0,	50.0),	(221.0,	60.0),
(300.0,	60.0),	(500.0,	60.0),	(800.0,	60.0),	(1100.0,	60.0),	(1500.0,	60.0),
(2000.0,	60.0),	(2500.0,	60.0),	(230.0,	70.0),	(300.0,	70.0),	(500.0,	70.0),
(800.0,	70.0),	(1100.0,	70.0),	(1500.0,	70.0),	(2000.0,	70.0),	(2500.0,	70.0),
(202.0,	80.0),	(300.0,	80.0),	(500.0,	80.0),	(800.0,	80.0),	(1100.0,	80.0),
(1500.0,	80.0),	(2000.0,	80.0),	(2500.0,	80.0),	(192.0,	90.0),	(300.0,	90.0),
(500.0,	90.0),	(800.0,	90.0),	(1100.0,	90.0),	(1500.0,	90.0),	(2000.0,	90.0),
(2500.0,	90.0),	(192.0,	100.0),	(300.0,	100.0),	(500.0,	100.0),	(800.0,	100.0),
(1100.0,	100.0),	(1500.0,	100.0),	(2000.0,	100.0),	(2500.0,	100.0),	(211.0,	100.0),
(300.0,	110.0),	(500.0,	110.0),	(800.0,	110.0),	(1100.0,	110.0),	(1500.0,	110.0),
(2000.0,	110.0),	(2500.0,	110.0),	(211.0,	120.0),	(300.0,	120.0),	(500.0,	120.0),
(800.0,	120.0),	(1100.0,	120.0),	(1500.0,	120.0),	(2000.0,	120.0),	(2500.0,	120.0),
(278.0,	130.0),	(300.0,	130.0),	(500.0,	130.0),	(800.0,	130.0),	(1100.0,	130.0),
(1500.0,	130.0),	(2000.0,	130.0),	(2500.0,	130.0),	(250.0,	140.0),	(300.0,	140.0),
(500.0,	140.0),	(800.0,	140.0),	(1100.0,	140.0),	(1500.0,	140.0),	(2000.0,	140.0),
(2500.0,	140.0),	(221.0,	150.0),	(300.0,	150.0),	(500.0,	150.0),	(800.0,	150.0),
(1100.0,	150.0),	(1500.0,	150.0),	(2000.0,	150.0),	(2500.0,	150.0),	(326.0,	160.0),
(500.0,	160.0),	(800.0,	160.0),	(1100.0,	160.0),	(1500.0,	160.0),	(2000.0,	160.0),
(2500.0,	160.0),	(461.0,	170.0),	(500.0,	170.0),	(800.0,	170.0),	(1100.0,	170.0),
(1500.0,	170.0),	(2000.0,	170.0),	(2500.0,	170.0),	(451.0,	180.0),	(500.0,	180.0),
(800.0,	180.0),	(1100.0,	180.0),	(1500.0,	180.0),	(2000.0,	180.0),	(2500.0,	180.0),
(461.0,	190.0),	(500.0,	190.0),	(800.0,	190.0),	(1100.0,	190.0),	(1500.0,	190.0),
(2000.0,	190.0),	(2500.0,	190.0),	(470.0,	200.0),	(500.0,	200.0),	(800.0,	200.0),
(1100.0,	200.0),	(1500.0,	200.0),	(2000.0,	200.0),	(2500.0,	200.0),	(509.0,	210.0),
(800.0,	210.0),	(1100.0,	210.0),	(1500.0,	210.0),	(2000.0,	210.0),	(2500.0,	210.0),
(576.0,	220.0),	(800.0,	220.0),	(1100.0,	220.0),	(1500.0,	220.0),	(2000.0,	220.0),
(2500.0,	220.0),	(701.0,	230.0),	(800.0,	230.0),	(1100.0,	230.0),	(1500.0,	230.0),
(2000.0,	230.0),	(2500.0,	230.0),	(739.0,	240.0),	(800.0,	240.0),	(1100.0,	240.0),
(1500.0,	240.0),	(2000.0,	240.0),	(2500.0,	240.0),	(835.0,	250.0),	(1100.0,	250.0),
(1500.0,	250.0),	(2000.0,	250.0),	(2500.0,	250.0),	(1094.0,	260.0),	(1100.0,	260.0),
(1500.0,	260.0),	(2000.0,	260.0),	(2500.0,	260.0),	(1085.0,	270.0),	(1100.0,	270.0),
(1500.0,	270.0),	(2000.0,	270.0),	(2500.0,	270.0),	(1114.0,	280.0),	(1500.0,	280.0),
(2000.0,	280.0),	(2500.0,	280.0),	(1613.0,	290.0),	(2000.0,	290.0),	(2500.0,	290.0),
(1766.0,	300.0),	(2000.0,	300.0),	(2500.0,	300.0),	(1766.0,	310.0),	(2000.0,	310.0),
(2500.0,	310.0),	(1488.0,	320.0),	(1500.0,	320.0),	(2000.0,	320.0),	(2500.0,	320.0),
(374.0,	330.0),	(500.0,	330.0),	(800.0,	330.0),	(1100.0,	330.0),	(1500.0,	330.0),
(2000.0,	330.0),	(2500.0,	330.0),	(346.0,	340.0),	(500.0,	340.0),	(800.0,	340.0),
(1100.0,	340.0),	(1500.0,	340.0),	(2000.0,	340.0),	(2500.0,	340.0),	(336.0,	350.0),
(500.0,	350.0),	(800.0,	350.0),	(1100.0,	350.0),	(1500.0,	350.0),	(2000.0,	350.0),
(2500.0,	350.0),	(326.0,	360.0),	(500.0,	360.0),	(800.0,	360.0),	(1100.0,	360.0),
(1500.0,	360.0),	(2000.0,	360.0),	(2500.0,	360.0),	(

*** SOURCE DATA ***

SOURCE NUMBER	P K E E	T W Y A NUMBER	PART. CATS.	EMISSION RATE		X	Y	BASE ELEV.	HEIGHT	TEMP.	EXIT VEL.	BLDG. HEIGHT	BLDG. LENGTH	BLDG. WIDTH
				TYPE=0,1 (GRAMS/SEC)	TYPE=2 (GRAMS/SEC)					(DEG.K); VERT.DIM TYPE=1	(M/SEC); HORZ.DIM DIAMETER TYPE=0			
				*PER METER**2 (METERS)		(METERS)		(METERS)		(METERS)		(METERS)		
3	0	0	0	0.28200E+01		70.0	-25.2	0.0	61.00	450.00	11.04	4.57	27.40	35.10 35.10
* CALM HOURS (=1) FOR DAY 5	*	0	0	0	0	1	1	0	0	0	0	0	0	0
* CALM HOURS (=1) FOR DAY 7	*	0	0	0	0	0	0	0	1	1	0	0	0	0
* CALM HOURS (=1) FOR DAY 8	*	0	0	0	0	0	0	0	0	1	0	0	0	0
* CALM HOURS (=1) FOR DAY 9	*	0	0	0	1	0	0	0	1	0	0	0	0	0
* CALM HOURS (=1) FOR DAY 10	*	0	1	0	0	0	0	0	1	0	0	0	0	0
* CALM HOURS (=1) FOR DAY 11	*	1	1	1	0	1	1	1	0	0	0	0	0	0
* CALM HOURS (=1) FOR DAY 21	*	0	0	0	0	0	0	0	1	1	0	0	0	0
* CALM HOURS (=1) FOR DAY 22	*	0	1	1	0	0	0	0	0	0	0	0	0	0
* CALM HOURS (=1) FOR DAY 27	*	0	0	0	1	1	0	0	0	0	0	0	0	0
* CALM HOURS (=1) FOR DAY 29	*	0	0	0	0	0	0	0	1	0	0	0	0	0
* CALM HOURS (=1) FOR DAY 30	*	1	1	1	0	0	0	0	1	1	1	0	0	0
* CALM HOURS (=1) FOR DAY 31	*	1	0	0	0	1	1	1	1	0	0	0	0	0
* CALM HOURS (=1) FOR DAY 46	*	0	0	0	0	0	0	0	0	0	0	0	0	0
* CALM HOURS (=1) FOR DAY 55	*	0	0	0	0	1	1	0	0	0	0	0	0	0
* CALM HOURS (=1) FOR DAY 62	*	0	0	0	1	1	0	0	0	0	0	0	0	0
* CALM HOURS (=1) FOR DAY 72	*	0	0	0	0	0	1	1	0	0	0	0	0	0
* CALM HOURS (=1) FOR DAY 73	*	0	0	1	1	0	1	1	1	0	0	0	0	0
* CALM HOURS (=1) FOR DAY 79	*	0	1	1	0	1	1	0	0	0	0	0	0	0
* CALM HOURS (=1) FOR DAY 89	*	0	0	0	0	0	0	0	1	0	0	0	0	0
* CALM HOURS (=1) FOR DAY 90	*	0	0	0	0	0	0	0	1	0	0	0	0	0
* CALM HOURS (=1) FOR DAY 94	*	0	0	0	0	0	0	0	1	0	0	0	0	0
* CALM HOURS (=1) FOR DAY 100	*	0	0	0	0	0	0	0	0	0	0	0	0	0
* CALM HOURS (=1) FOR DAY 111	*	0	0	0	0	0	0	0	1	0	0	0	0	0
* CALM HOURS (=1) FOR DAY 112	*	0	1	1	0	0	0	0	0	0	0	0	0	0
* CALM HOURS (=1) FOR DAY 122	*	0	1	0	1	1	0	0	0	0	0	0	0	0
* CALM HOURS (=1) FOR DAY 144	*	1	0	1	0	0	0	0	0	0	0	0	0	0
* CALM HOURS (=1) FOR DAY 145	*	0	0	0	0	0	0	0	1	0	0	0	0	0
* CALM HOURS (=1) FOR DAY 146	*	0	0	0	0	0	0	0	1	0	0	0	0	0
* CALM HOURS (=1) FOR DAY 147	*	0	0	0	0	0	0	0	0	0	0	0	0	0
* CALM HOURS (=1) FOR DAY 148	*	1	1	0	1	0	0	0	0	0	0	0	0	0
* CALM HOURS (=1) FOR DAY 150	*	0	0	0	0	0	0	0	0	0	0	0	0	0
* CALM HOURS (=1) FOR DAY 154	*	0	0	0	0	0	1	0	0	0	0	0	0	0
* CALM HOURS (=1) FOR DAY 156	*	0	0	0	0	0	1	0	0	0	0	0	0	0
* CALM HOURS (=1) FOR DAY 159	*	0	0	0	0	0	1	0	0	0	0	0	0	0
* CALM HOURS (=1) FOR DAY 161	*	0	0	1	1	1	0	0	0	0	0	0	0	0
* CALM HOURS (=1) FOR DAY 165	*	0	0	0	0	1	0	0	0	0	0	0	0	0
* CALM HOURS (=1) FOR DAY 174	*	0	0	0	0	1	1	1	0	0	0	0	0	0
* CALM HOURS (=1) FOR DAY 176	*	0	0	0	1	0	0	0	0	0	0	0	0	0
* CALM HOURS (=1) FOR DAY 180	*	0	0	0	0	0	1	0	0	0	0	0	0	0
* CALM HOURS (=1) FOR DAY 190	*	0	0	0	0	0	0	0	0	0	0	0	1	0
* CALM HOURS (=1) FOR DAY 191	*	0	0	0	0	0	0	0	0	0	0	0	0	0
* CALM HOURS (=1) FOR DAY 197	*	0	0	1	0	0	0	0	0	0	0	0	0	0
* CALM HOURS (=1) FOR DAY 198	*	0	0	0	0	1	0	0	0	0	0	0	0	0
* CALM HOURS (=1) FOR DAY 199	*	0	0	0	0	0	0	0	0	0	0	0	0	0
* CALM HOURS (=1) FOR DAY 200	*	0	0	0	1	1	0	1	0	0	0	0	0	0
* CALM HOURS (=1) FOR DAY 201	*	0	0	0	0	0	0	1	0	0	0	0	0	0
* CALM HOURS (=1) FOR DAY 204	*	0	0	0	0	0	0	0	0	1	0	0	0	0
* CALM HOURS (=1) FOR DAY 207	*	0	0	0	0	0	1	1	0	0	0	0	0	0
* CALM HOURS (=1) FOR DAY 208	*	0	0	0	0	0	0	0	0	0	1	0	0	0
* CALM HOURS (=1) FOR DAY 209	*	0	0	0	0	0	0	1	0	0	0	0	0	0

CALM HOURS (=1) FOR DAY 210 * 1 0
 * CALM HOURS (=1) FOR DAY 218 * 0 0 0 0 0 0 1 0 0 1 0 0 0 0 0 0 0 0 0 0 0 0
 CALM HOURS (=1) FOR DAY 219 * 0 0 0 0 1 0 0 0 0 0 0 0 0 0 0 0 0 0 0 0 0 0
 CALM HOURS (=1) FOR DAY 220 * 0 0 0 0 0 0 0 0 0 0 0 0 0 0 0 0 1 1 0 0 1 1
 CALM HOURS (=1) FOR DAY 221 * 0 0 1 1 1 1 1 0 0 0 0 0 0 0 0 0 0 0 0 1 0 1
 * CALM HOURS (=1) FOR DAY 222 * 0 1 0 1 1 1 1 0 0 0 0 0 0 0 0 0 0 0 0 0 0 0
 CALM HOURS (=1) FOR DAY 223 * 0 0 0 0 1 1 0 0 0 0 0 0 0 0 0 0 0 0 0 0 0 0
 CALM HOURS (=1) FOR DAY 225 * 0 0 0 0 0 0 0 0 0 0 0 0 0 0 0 0 0 0 0 1 1 1
 * CALM HOURS (=1) FOR DAY 226 * 0 0 0 0 0 0 1 0 1 0 0 0 0 0 0 0 0 0 0 1 0 0
 * CALM HOURS (=1) FOR DAY 227 * 0 0 0 1 1 1 0 1 0 0 0 0 0 0 0 0 0 0 0 0 0 1
 CALM HOURS (=1) FOR DAY 228 * 1 0 0 0 0 1 0 0 0 0 0 0 0 0 0 0 0 0 0 0 0 0
 CALM HOURS (=1) FOR DAY 229 * 0 0 0 0 1 1 0 0 0 0 0 0 0 0 0 0 0 0 0 0 0 0
 * CALM HOURS (=1) FOR DAY 231 * 0 1
 CALM HOURS (=1) FOR DAY 232 * 0 0 0 0 0 0 0 0 1 0 0 0 0 0 0 0 0 0 0 0 0 0
 CALM HOURS (=1) FOR DAY 233 * 0 0 0 0 0 0 0 0 0 0 0 0 1 0 0 0 0 0 0 0 0 0
 CALM HOURS (=1) FOR DAY 236 * 0 0 0 1 0 0 0 0 0 0 0 0 0 0 0 0 0 0 0 0 0 0
 * CALM HOURS (=1) FOR DAY 240 * 0 0 0 0 0 1 0 0 0 0 0 0 0 0 0 0 0 0 0 0 0 0
 CALM HOURS (=1) FOR DAY 241 * 0 0 0 0 0 0 0 1 0 0 0 0 0 0 0 0 0 0 0 0 0 0
 CALM HOURS (=1) FOR DAY 242 * 0 0 1 1 0 0 0 0 0 0 0 0 0 0 0 0 0 1 0 1 1 1
 * CALM HOURS (=1) FOR DAY 243 * 0 0 0 0 0 0 0 0 0 0 0 0 0 0 0 0 0 0 0 1 0 0
 * CALM HOURS (=1) FOR DAY 245 * 0 0 0 0 0 1 0 0 0 0 0 0 0 0 0 0 0 0 0 0 0 0
 CALM HOURS (=1) FOR DAY 249 * 0 0 0 0 0 0 0 0 0 0 0 0 0 0 0 0 0 0 1 1 1 1
 CALM HOURS (=1) FOR DAY 250 * 1 0 1 1 1 1 0 0 0 0 0 0 0 0 0 0 0 0 0 0 0 0
 * CALM HOURS (=1) FOR DAY 253 * 0 0 0 0 0 0 0 0 0 0 0 0 0 0 0 0 0 1 0 0 0 0
 * CALM HOURS (=1) FOR DAY 254 * 0 0 1 0 0 0 0 0 0 0 0 0 0 0 0 0 0 0 0 0 0 0
 CALM HOURS (=1) FOR DAY 255 * 0 0 1 0 1 0 0 0 0 0 0 0 0 0 0 0 0 0 0 0 0 0
 CALM HOURS (=1) FOR DAY 256 * 0 0 0 1 1 1 0 1 0 0 0 0 0 0 0 0 1 0 1 1 0 1
 * CALM HOURS (=1) FOR DAY 257 * 1 0 0 0 1 1 0 0 0 0 0 0 0 0 0 0 0 0 0 0 0 0
 CALM HOURS (=1) FOR DAY 258 * 0 0 0 0 0 1 0 0 0 0 0 0 0 0 0 0 1 0 0 0 0 0
 CALM HOURS (=1) FOR DAY 259 * 0 0 0 1 1 1 0 0 0 0 0 0 0 0 0 0 0 0 0 0 0 0
 * CALM HOURS (=1) FOR DAY 260 * 0 0 0 0 0 0 1 0 0 0 0 0 0 0 0 0 0 0 0 0 0 0
 * CALM HOURS (=1) FOR DAY 261 * 0 0 0 0 0 1 0 0 0 0 0 0 0 0 0 0 0 0 0 1 0 0
 CALM HOURS (=1) FOR DAY 262 * 0 1 0
 CALM HOURS (=1) FOR DAY 264 * 0 0 0 0 0 0 0 0 0 0 0 0 0 0 0 0 0 1 1 1 0 0
 * CALM HOURS (=1) FOR DAY 265 * 0 0 1 0 1 1 0 1 1 0 0 0 0 0 0 0 0 0 1 0 0 0
 * CALM HOURS (=1) FOR DAY 272 * 0 0 0 0 0 0 0 0 0 0 0 0 0 0 0 0 0 1 0 0 1 0
 CALM HOURS (=1) FOR DAY 274 * 1 0
 CALM HOURS (=1) FOR DAY 275 * 0 0 1 0 0 0 0 0 0 0 0 0 0 0 0 0 0 0 0 0 0 0
 * CALM HOURS (=1) FOR DAY 278 * 0 1 0 1 1 0 1 0 0 0 0 0 0 0 0 0 0 0 0 0 0 0
 * CALM HOURS (=1) FOR DAY 279 * 0 1 1 0 1 1 1 0 0 0 1 0 0 0 0 0 0 0 0 0 0 0
 CALM HOURS (=1) FOR DAY 280 * 1 0
 CALM HOURS (=1) FOR DAY 281 * 0 0 0 0 1 0 0 1 0 0 0 0 0 0 0 0 0 0 0 0 0 0
 * CALM HOURS (=1) FOR DAY 282 * 0 0 1 0 0 0 0 0 0 0 0 0 0 0 0 0 0 0 0 1 0 0
 CALM HOURS (=1) FOR DAY 283 * 1 0 1
 CALM HOURS (=1) FOR DAY 284 * 0 0 0 0 1 0 1 1 0 0 0 0 0 0 0 0 0 0 0 0 0 0
 * CALM HOURS (=1) FOR DAY 285 * 0 1 0 1 0 0 0 0 0 0 0 0 0 0 0 0 0 0 0 0 0 0
 * CALM HOURS (=1) FOR DAY 286 * 0 0 0 0 0 0 1 0 0 0 0 0 0 0 0 0 0 0 0 0 0 1
 CALM HOURS (=1) FOR DAY 289 * 0 0 0 0 0 0 1 0 0 0 0 0 0 0 0 0 0 0 0 0 0 0
 CALM HOURS (=1) FOR DAY 290 * 1 1 0 0 0 0 0 1 1 1 1 0 0 0 0 0 0 0 0 0 0 0
 * CALM HOURS (=1) FOR DAY 297 * 1 1 1 1 1 0 0 0 0 0 0 0 0 0 0 0 0 0 0 0 0 0
 CALM HOURS (=1) FOR DAY 298 * 0 0 1 0 0 0 0 0 0 0 0 0 0 0 0 0 0 0 0 0 0 0
 CALM HOURS (=1) FOR DAY 308 * 0 0 0 0 1 0 0 0 0 0 0 0 0 0 0 0 0 1 1 1 0 0
 CALM HOURS (=1) FOR DAY 309 * 0 1 0 1 0 0 0 0 0 0 0 0 0 0 0 0 0 0 0 0 0 0
 * CALM HOURS (=1) FOR DAY 310 * 0 0 0 0 0 0 0 0 0 0 0 0 0 0 0 0 0 0 1 1 1 1
 CALM HOURS (=1) FOR DAY 311 * 1 1 1 0 1 0 1 0 0 0 0 0 0 0 0 1 0 0 0 0 0 1
 * CALM HOURS (=1) FOR DAY 312 * 0 0 1 0 0 0 0 0 0 0 0 0 0 1 0 0 0 0 0 1 1 1
 * CALM HOURS (=1) FOR DAY 313 * 0 0 0 0 0 1 0 0 0 0 0 0 0 0 0 0 0 0 0 0 0 0
 * CALM HOURS (=1) FOR DAY 314 * 0 0 0 0 1 1 1 0 0 0 0 0 0 0 0 0 0 0 0 1 0 0
 CALM HOURS (=1) FOR DAY 316 * 0 0 0 0 1 0 0 0 0 0 0 0 0 0 0 0 0 0 0 0 0 0
 CALM HOURS (=1) FOR DAY 317 * 0 0 0 0 0 0 0 0 0 0 0 0 0 0 0 0 0 0 1 0 0 0
 * CALM HOURS (=1) FOR DAY 319 * 0 1 0 0 0 0 1 0 0 0 0 0 0 0 0 0 0 0 0 0 0 0
 * CALM HOURS (=1) FOR DAY 324 * 0 1
 CALM HOURS (=1) FOR DAY 325 * 1 0 0 0 0 0 1 0 0 0 0 0 0 0 0 0 0 0 0 0 0 0
 CALM HOURS (=1) FOR DAY 326 * 0 0 0 1 0 1 0 0 0 0 0 0 0 0 0 0 0 0 0 0 0 0
 * CALM HOURS (=1) FOR DAY 330 * 0 0 0 0 0 0 1 1 0 0 0 0 0 0 0 0 0 0 0 0 0 0
 CALM HOURS (=1) FOR DAY 333 * 0 1 1 1 0 0 0 0 0 0 0 0 0 0 0 0 0 0 0 0 0 0

```

* CALM HOURS (=1) FOR DAY 334 * 0 0 0 0 1 1 0 0 0 1 0 0 0 0 0 0 0 0 0 0 0 0 0 0
* CALM HOURS (=1) FOR DAY 335 * 0 0 0 0 1 0 1 0 0 0 0 0 0 0 0 0 0 0 0 0 0 0 0 0
* CALM HOURS (=1) FOR DAY 336 * 0 0 0 1 0 0 0 0 0 0 0 0 0 0 0 0 0 0 0 0 0 0 0 0
* CALM HOURS (=1) FOR DAY 338 * 0 1 1 1 1 0 0 0 0 0 0 0 0 0 0 0 0 0 0 0 0 0 1 1 1
* CALM HOURS (=1) FOR DAY 339 * 1 1 0 0 1 1 0 1 1 0 0 0 0 0 0 0 0 0 0 0 0 0 0 0 0
* CALM HOURS (=1) FOR DAY 345 * 0 0 0 0 1 0 0 0 0 0 0 0 0 0 0 0 0 0 0 0 0 0 0 0 0
* CALM HOURS (=1) FOR DAY 347 * 0 0 0 0 0 0 1 1 0 1 0 0 0 0 0 0 0 0 0 0 0 0 0 0 0
* CALM HOURS (=1) FOR DAY 348 * 1 0 0 1 0 0 1 1 0 0 0 0 0 0 0 0 0 0 0 0 0 0 0 0 0
* CALM HOURS (=1) FOR DAY 352 * 0 0 0 0 1 0 0 0 0 0 0 0 0 0 0 0 0 0 0 0 0 0 1 1 0 1 0
* CALM HOURS (=1) FOR DAY 353 * 0 0 0 0 0 0 0 0 0 0 0 0 0 0 0 0 0 0 0 0 0 0 0 0 0 1
* CALM HOURS (=1) FOR DAY 354 * 0 0 0 1 1 0 0 0 0 0 0 0 0 0 0 0 0 0 0 0 1 1 0 0 0 0 0
* CALM HOURS (=1) FOR DAY 355 * 0 0 0 0 0 1 0 0 0 0 0 0 0 0 0 0 0 0 0 0 0 0 0 0 0 0 0
* CALM HOURS (=1) FOR DAY 356 * 0 0 0 0 1 0 1 1 0 0 0 0 0 0 0 0 0 0 0 0 0 0 0 0 0 0 0
* CALM HOURS (=1) FOR DAY 357 * 0 0 0 1 1 1 0 1 0 0 0 0 0 0 0 0 0 0 0 0 0 0 0 0 0 0 0
* CALM HOURS (=1) FOR DAY 358 * 1 0 0 0 0 0 0 0 0 0 0 0 0 0 0 0 0 0 0 0 0 0 0 0 0 0 0
* CALM HOURS (=1) FOR DAY 361 * 0 0 0 0 0 0 0 0 0 0 0 0 0 0 0 0 0 0 0 0 0 0 1 0 0 0 0 0
* CALM HOURS (=1) FOR DAY 363 * 0 0 0 0 0 0 0 0 0 0 0 0 0 0 0 0 0 0 0 0 0 0 0 0 0 0 1
* CALM HOURS (=1) FOR DAY 364 * 1 0 0 0 0 0 0 0 0 0 0 0 0 0 0 0 0 0 0 0 0 0 0 0 0 0 0

```

*** ISCST BY KBN 1/90 *** 1983 TARMAC KILN 3 NOX Increase

10-23-90 ***

* 365-DAY AVERAGE CONCENTRATION (MICROGRAMS/CUBIC METER) *

* FROM ALL SOURCES *
 * FOR THE RECEPTOR GRID *

* MAXIMUM VALUE EQUALS 0.05152 AND OCCURRED AT (3000.0, 300.0) *

DIRECTION / (DEGREES) /	RANGE (METERS)			
	3000.0	3500.0	4000.0	4500.0
360.0 /	0.00889	0.00841	0.00799	0.00761
350.0 /	0.01432	0.01339	0.01252	0.01175
340.0 /	0.01984	0.01856	0.01737	0.01629
330.0 /	0.02575	0.02386	0.02214	0.02060
320.0 /	0.03511	0.03245	0.03000	0.02782
310.0 /	0.04308	0.03934	0.03597	0.03302
300.0 /	0.05152	0.04773	0.04420	0.04104
290.0 /	0.04550	0.04241	0.03949	0.03684
280.0 /	0.03927	0.03669	0.03427	0.03208
270.0 /	0.03673	0.03461	0.03257	0.03068
260.0 /	0.03138	0.02934	0.02735	0.02552
250.0 /	0.02885	0.02748	0.02606	0.02467
240.0 /	0.02244	0.02189	0.02122	0.02047
230.0 /	0.01385	0.01361	0.01330	0.01293
220.0 /	0.00820	0.00799	0.00773	0.00745
210.0 /	0.00675	0.00651	0.00622	0.00592
200.0 /	0.00810	0.00801	0.00785	0.00765
190.0 /	0.01155	0.01157	0.01148	0.01130
180.0 /	0.01559	0.01577	0.01576	0.01562
170.0 /	0.01866	0.01888	0.01891	0.01878
160.0 /	0.01704	0.01684	0.01651	0.01611
150.0 /	0.01338	0.01297	0.01248	0.01198
140.0 /	0.01104	0.01062	0.01016	0.00970
130.0 /	0.01053	0.01016	0.00974	0.00933
120.0 /	0.00911	0.00868	0.00823	0.00780
110.0 /	0.00944	0.00911	0.00871	0.00829
100.0 /	0.00928	0.00903	0.00869	0.00832
90.0 /	0.00812	0.00777	0.00736	0.00697
80.0 /	0.00642	0.00613	0.00582	0.00553
70.0 /	0.00597	0.00565	0.00532	0.00501
60.0 /	0.00705	0.00690	0.00668	0.00644
50.0 /	0.00758	0.00739	0.00716	0.00692
40.0 /	0.00611	0.00589	0.00566	0.00541
30.0 /	0.00482	0.00472	0.00462	0.00450
20.0 /	0.00430	0.00420	0.00410	0.00399
10.0 /	0.00594	0.00574	0.00555	0.00536

*** ISCST BY KBN 1/90 *** 1983 TARMAC KILN 3 NOX Increase

10-23-90 ***

* 365-DAY AVERAGE CONCENTRATION (MICROGRAMS/CUBIC METER) *

* FROM ALL SOURCES *
* FOR THE DISCRETE RECEPTOR POINTS *

- RNG -	- DIR -	CON.	- RNG -	- DIR -	CON.	- RNG -	- DIR -	CON.
336.0	10.0	0.00000	500.0	10.0	0.00010	800.0	10.0	0.00233
1100.0	10.0	0.00428	1500.0	10.0	0.00542	2000.0	10.0	0.00602
2500.0	10.0	0.00608	230.0	20.0	0.00000	300.0	20.0	0.00000
500.0	20.0	0.00003	800.0	20.0	0.00138	1100.0	20.0	0.00290
1500.0	20.0	0.00377	2000.0	20.0	0.00425	2500.0	20.0	0.00434
211.0	30.0	0.00000	300.0	30.0	0.00005	500.0	30.0	0.00024
800.0	30.0	0.00120	1100.0	30.0	0.00277	1500.0	30.0	0.00392
2000.0	30.0	0.00465	2500.0	30.0	0.00484	211.0	40.0	0.00021
300.0	40.0	0.00193	500.0	40.0	0.00100	800.0	40.0	0.00168
1100.0	40.0	0.00341	1500.0	40.0	0.00493	2000.0	40.0	0.00594
2500.0	40.0	0.00618	211.0	50.0	0.00160	300.0	50.0	0.00212
500.0	50.0	0.00155	800.0	50.0	0.00254	1100.0	50.0	0.00428
1500.0	50.0	0.00602	2000.0	50.0	0.00726	2500.0	50.0	0.00761
221.0	60.0	0.00189	300.0	60.0	0.00434	500.0	60.0	0.00266
800.0	60.0	0.00265	1100.0	60.0	0.00395	1500.0	60.0	0.00548
2000.0	60.0	0.00666	2500.0	60.0	0.00703	230.0	70.0	0.00328
300.0	70.0	0.00481	500.0	70.0	0.00321	800.0	70.0	0.00266
1100.0	70.0	0.00364	1500.0	70.0	0.00506	2000.0	70.0	0.00602
2500.0	70.0	0.00615	202.0	80.0	0.00300	300.0	80.0	0.00346
500.0	80.0	0.00175	800.0	80.0	0.00167	1100.0	80.0	0.00315
1500.0	80.0	0.00501	2000.0	80.0	0.00625	2500.0	80.0	0.00653
192.0	90.0	0.00152	300.0	90.0	0.00339	500.0	90.0	0.00269
800.0	90.0	0.00208	1100.0	90.0	0.00392	1500.0	90.0	0.00633
2000.0	90.0	0.00790	2500.0	90.0	0.00827	192.0	100.0	0.00259
300.0	100.0	0.00521	500.0	100.0	0.00381	800.0	100.0	0.00246
1100.0	100.0	0.00430	1500.0	100.0	0.00685	2000.0	100.0	0.00867
2500.0	100.0	0.00926	211.0	100.0	0.00308	300.0	110.0	0.00494
500.0	110.0	0.00343	800.0	110.0	0.00242	1100.0	110.0	0.00468
1500.0	110.0	0.00725	2000.0	110.0	0.00903	2500.0	110.0	0.00952
211.0	120.0	0.00243	300.0	120.0	0.00324	500.0	120.0	0.00160
800.0	120.0	0.00187	1100.0	120.0	0.00485	1500.0	120.0	0.00750
2000.0	120.0	0.00911	2500.0	120.0	0.00937	278.0	130.0	0.00367
300.0	130.0	0.00383	500.0	130.0	0.00200	800.0	130.0	0.00252
1100.0	130.0	0.00574	1500.0	130.0	0.00852	2000.0	130.0	0.01032
2500.0	130.0	0.01072	250.0	140.0	0.00410	300.0	140.0	0.00523
500.0	140.0	0.00285	800.0	140.0	0.00306	1100.0	140.0	0.00628
1500.0	140.0	0.00913	2000.0	140.0	0.01090	2500.0	140.0	0.01125
221.0	150.0	0.00554	300.0	150.0	0.00717	500.0	150.0	0.00318

*** ISCST BY KBN 1/90 *** 1983 TARMAC KILN 3 NOX Increase

10-23-90 ***

* 365-DAY AVERAGE CONCENTRATION (MICROGRAMS/CUBIC METER) *

* FROM ALL SOURCES *
* FOR THE DISCRETE RECEPTOR POINTS *

- RNG -	- DIR -	CON.	- RNG -	- DIR -	CON.	- RNG -	- DIR -	CON.
800.0	150.0	0.00308	1100.0	150.0	0.00660	1500.0	150.0	0.01031
2000.0	150.0	0.01280	2500.0	150.0	0.01347	326.0	160.0	0.01140
500.0	160.0	0.00396	800.0	160.0	0.00301	1100.0	160.0	0.00716
1500.0	160.0	0.01190	2000.0	160.0	0.01548	2500.0	160.0	0.01678
461.0	170.0	0.00321	500.0	170.0	0.00295	800.0	170.0	0.00311
1100.0	170.0	0.00724	1500.0	170.0	0.01221	2000.0	170.0	0.01619
2500.0	170.0	0.01794	451.0	180.0	0.00174	500.0	180.0	0.00152
800.0	180.0	0.00188	1100.0	180.0	0.00559	1500.0	180.0	0.00989
2000.0	180.0	0.01336	2500.0	180.0	0.01494	461.0	190.0	0.00034
500.0	190.0	0.00030	800.0	190.0	0.00133	1100.0	190.0	0.00440
1500.0	190.0	0.00764	2000.0	190.0	0.01015	2500.0	190.0	0.01120
470.0	200.0	0.00039	500.0	200.0	0.00040	800.0	200.0	0.00145
1100.0	200.0	0.00379	1500.0	200.0	0.00597	2000.0	200.0	0.00747
2500.0	200.0	0.00801	509.0	210.0	0.00064	800.0	210.0	0.00146
1100.0	210.0	0.00344	1500.0	210.0	0.00525	2000.0	210.0	0.00645
2500.0	210.0	0.00681	576.0	220.0	0.00209	800.0	220.0	0.00284
1100.0	220.0	0.00485	1500.0	220.0	0.00671	2000.0	220.0	0.00790
2500.0	220.0	0.00824	701.0	230.0	0.00317	800.0	230.0	0.00415
1100.0	230.0	0.00777	1500.0	230.0	0.01107	2000.0	230.0	0.01316
2500.0	230.0	0.01379	739.0	240.0	0.00457	800.0	240.0	0.00582
1100.0	240.0	0.01218	1500.0	240.0	0.01797	2000.0	240.0	0.02151
2500.0	240.0	0.02249	835.0	250.0	0.00934	1100.0	250.0	0.01690
1500.0	250.0	0.02477	2000.0	250.0	0.02910	2500.0	250.0	0.02969
1094.0	260.0	0.01952	1100.0	260.0	0.01969	1500.0	260.0	0.02843
2000.0	260.0	0.03284	2500.0	260.0	0.03292	1085.0	270.0	0.02313
1100.0	270.0	0.02362	1500.0	270.0	0.03356	2000.0	270.0	0.03835
2500.0	270.0	0.03836	1114.0	280.0	0.02690	1500.0	280.0	0.03710
2000.0	280.0	0.04186	2500.0	280.0	0.04143	1613.0	290.0	0.04501
2000.0	290.0	0.04851	2500.0	290.0	0.04804	1766.0	300.0	0.05428
2000.0	300.0	0.05578	2500.0	300.0	0.05479	1766.0	310.0	0.04804
2000.0	310.0	0.04864	2500.0	310.0	0.04663	1488.0	320.0	0.03502
1500.0	320.0	0.03520	2000.0	320.0	0.03855	2500.0	320.0	0.03752
374.0	330.0	0.00130	500.0	330.0	0.00144	800.0	330.0	0.01000
1100.0	330.0	0.01901	1500.0	330.0	0.02551	2000.0	330.0	0.02809
2500.0	330.0	0.02743	346.0	340.0	0.00081	500.0	340.0	0.00098
800.0	340.0	0.00750	1100.0	340.0	0.01421	1500.0	340.0	0.01905
2000.0	340.0	0.02118	2500.0	340.0	0.02092	336.0	350.0	0.00049
500.0	350.0	0.00050	800.0	350.0	0.00539	1100.0	350.0	0.01035

*** ISCST BY KBN 1/90 *** 1983 TARMAC KILN 3 NOX Increase

10-23-90 ***

* 365-DAY AVERAGE CONCENTRATION (MICROGRAMS/CUBIC METER) *

* FROM ALL SOURCES *

* FOR THE DISCRETE RECEPTOR POINTS *

- RNG -	- DIR -	CON.	- RNG -	- DIR -	CON.	- RNG -	- DIR -	CON.
1500.0	350.0	0.01379	2000.0	350.0	0.01532	2500.0	350.0	0.01512
326.0	360.0	0.00009	500.0	360.0	0.00021	800.0	360.0	0.00364
1100.0	360.0	0.00671	1500.0	360.0	0.00860	2000.0	360.0	0.00943
2500.0	360.0	0.00930						

ISCSTK6E MODEL, A VERSION OF
ISCST (VERSION 88348)
AN AIR QUALITY DISPERSION MODEL IN
SECTION 1. GUIDELINE MODELS.
IN UNAMAP (VERSION 6) DEC 1988.
SOURCE: FILE 6 ON UNAMAP MAGNETIC TAPE FROM NTIS.
(Based on Version 3.4 to UNAMAP, Dec 15, 1988)

CONVERTED BY :
KBN ENGINEERING AND APPLIED SCIENCES, INC.
GAINESVILLE, FLORIDA
(904)331-9000

COPYRIGHT 1990 L

CARD INPUT File is	aqslk3.i84	
SUMMARY OUTPUT File is	aqslk3.o84	
METEOROLOGICAL FILE is	miaprl84.bin	
TITLE OF RUN is	1984 TARMAC KILN 3 NOX Increase	10-23-90

NOTE THAT THE BUILDING DIMENSIONS ON CARD 6,1 FOR SOURCE NO. 3 DO NOT MEET THE SCHULMAN-SCIRE CRITERIA.
THEREFORE, DIRECTION SPECIFIC BUILDING DIMENSIONS WILL NOT BE USED BY THE MODEL.

CALCULATE (CONCENTRATION=1,DEPOSITION=2)	ISW(1) = 1
RECEPTOR GRID SYSTEM (RECTANGULAR=1 OR 3, POLAR=2 OR 4)	ISW(2) = 4
DISCRETE RECEPTOR SYSTEM (RECTANGULAR=1,POLAR=2)	ISW(3) = 2
TERRAIN ELEVATIONS ARE READ (YES=1,NO=0)	ISW(4) = 0
CALCULATIONS ARE WRITTEN TO TAPE (YES=1,NO=0)	ISW(5) = 0
LIST ALL INPUT DATA (NO=0,YES=1,MET DATA ALSO=2)	ISW(6) = 1
COMPUTE AVERAGE CONCENTRATION (OR TOTAL DEPOSITION)	
WITH THE FOLLOWING TIME PERIODS:	
HOURLY (YES=1,NO=0)	ISW(7) = 0
2-HOUR (YES=1,NO=0)	ISW(8) = 0
3-HOUR (YES=1,NO=0)	ISW(9) = 0
4-HOUR (YES=1,NO=0)	ISW(10) = 0
6-HOUR (YES=1,NO=0)	ISW(11) = 0
8-HOUR (YES=1,NO=0)	ISW(12) = 0
12-HOUR (YES=1,NO=0)	ISW(13) = 0
24-HOUR (YES=1,NO=0)	ISW(14) = 0
PRINT 'N'-DAY TABLE(S) (YES=1,NO=0)	ISW(15) = 1
PRINT THE FOLLOWING TYPES OF TABLES WHOSE TIME PERIODS ARE	
SPECIFIED BY ISW(7) THROUGH ISW(14):	
DAILY TABLES (YES=1,NO=0)	ISW(16) = 0
HIGHEST & SECOND HIGHEST TABLES (YES=1,NO=0)	ISW(17) = 0
MAXIMUM 50 TABLES (YES=1,NO=0)	ISW(18) = 0
METEOROLOGICAL DATA INPUT METHOD (PRE-PROCESSED=1,CARD=2)	ISW(19) = 1
RURAL-URBAN OPTION (RU.=0,UR. MODE 1=1,UR. MODE 2=2,UR. MODE 3=3)	ISW(20) = 0
WIND PROFILE EXPONENT VALUES (DEFAULTS=1,USER ENTERS=2,3)	ISW(21) = 1
VERTICAL POT. TEMP. GRADIENT VALUES (DEFAULTS=1,USER ENTERS=2,3)	ISW(22) = 1
SCALE EMISSION RATES FOR ALL SOURCES (NO=0,YES>0)	ISW(23) = 0
PROGRAM CALCULATES FINAL PLUME RISE ONLY (YES=1,NO=2)	ISW(24) = 1
PROGRAM ADJUSTS ALL STACK HEIGHTS FOR DOWNWASH (YES=2,NO=1)	ISW(25) = 2
PROGRAM USES BUOYANCY INDUCED DISPERSION (YES=1,NO=2)	ISW(26) = 1
CONCENTRATIONS DURING CALM PERIODS SET = 0 (YES=1,NO=2)	ISW(27) = 1
REG. DEFAULT OPTION CHOSEN (YES=1,NO=2)	ISW(28) = 1
TYPE OF POLLUTANT TO BE MODELLED (1=S02,2=OTHER)	ISW(29) = 2
DEBUG OPTION CHOSEN (YES=1,NO=2)	ISW(30) = 2
ABOVE GROUND (FLAGPOLE) RECEPTORS USED (YES=1,NO=0)	ISW(31) = 0
NUMBER OF INPUT SOURCES	NSOURC = 1
NUMBER OF SOURCE GROUPS (=0,ALL SOURCES)	NGROUP = 0
TIME PERIOD INTERVAL TO BE PRINTED (=0,ALL INTERVALS)	IPERD = 0
NUMBER OF X (RANGE) GRID VALUES	NXPNTS = 4
NUMBER OF Y (THETA) GRID VALUES	NYPNTS = 36
NUMBER OF DISCRETE RECEPTORS	NXWYPT = 238
SOURCE EMISSION RATE UNITS CONVERSION FACTOR	TK = .10000E+07
HEIGHT ABOVE GROUND AT WHICH WIND SPEED WAS MEASURED	ZR = 7.01 METERS
LOGICAL UNIT NUMBER OF METEOROLOGICAL DATA	IMET = 9
DECAY COEFFICIENT FOR PHYSICAL OR CHEMICAL DEPLETION	DECAY = 0.000000E+00
SURFACE STATION NO.	ISS = 12839
YEAR OF SURFACE DATA	ISY = 84
UPPER AIR STATION NO.	IUS = 12844
YEAR OF UPPER AIR DATA	IUY = 84
ALLOCATED DATA STORAGE	LIMIT = 43500 WORDS
REQUIRED DATA STORAGE FOR THIS PROBLEM RUN	MIMIT = 1949 WORDS

*** RANGES OF POLAR GRID SYSTEM ***
(METERS)

3000.0, 3500.0, 4000.0, 4500.0,

*** RADIAL ANGLES OF POLAR GRID SYSTEM ***

(DEGREES)

10.0, 20.0, 30.0, 40.0, 50.0, 60.0, 70.0, 80.0, 90.0, 100.0,
110.0, 120.0, 130.0, 140.0, 150.0, 160.0, 170.0, 180.0, 190.0, 200.0,
210.0, 220.0, 230.0, 240.0, 250.0, 260.0, 270.0, 280.0, 290.0, 300.0,
310.0, 320.0, 330.0, 340.0, 350.0, 360.0,

*** RANGE, THETA COORDINATES OF DISCRETE RECEPTORS ***
(METERS, DEGREES)

(336.0,	10.0),	(500.0,	10.0),	(800.0,	10.0),	(1100.0,	10.0),	(1500.0,	10.0),
(2000.0,	10.0),	(2500.0,	10.0),	(230.0,	20.0),	(300.0,	20.0),	(500.0,	20.0),
(800.0,	20.0),	(1100.0,	20.0),	(1500.0,	20.0),	(2000.0,	20.0),	(2500.0,	20.0),
(211.0,	30.0),	(300.0,	30.0),	(500.0,	30.0),	(800.0,	30.0),	(1100.0,	30.0),
(1500.0,	30.0),	(2000.0,	30.0),	(2500.0,	30.0),	(211.0,	40.0),	(300.0,	40.0),
(500.0,	40.0),	(800.0,	40.0),	(1100.0,	40.0),	(1500.0,	40.0),	(2000.0,	40.0),
(2500.0,	40.0),	(211.0,	50.0),	(300.0,	50.0),	(500.0,	50.0),	(800.0,	50.0),
(1100.0,	50.0),	(1500.0,	50.0),	(2000.0,	50.0),	(2500.0,	50.0),	(221.0,	60.0),
(300.0,	60.0),	(500.0,	60.0),	(800.0,	60.0),	(1100.0,	60.0),	(1500.0,	60.0),
(2000.0,	60.0),	(2500.0,	60.0),	(230.0,	70.0),	(300.0,	70.0),	(500.0,	70.0),
(800.0,	70.0),	(1100.0,	70.0),	(1500.0,	70.0),	(2000.0,	70.0),	(2500.0,	70.0),
(202.0,	80.0),	(300.0,	80.0),	(500.0,	80.0),	(800.0,	80.0),	(1100.0,	80.0),
(1500.0,	80.0),	(2000.0,	80.0),	(2500.0,	80.0),	(192.0,	90.0),	(300.0,	90.0),
(500.0,	90.0),	(800.0,	90.0),	(1100.0,	90.0),	(1500.0,	90.0),	(2000.0,	90.0),
(2500.0,	90.0),	(192.0,	100.0),	(300.0,	100.0),	(500.0,	100.0),	(800.0,	100.0),
(1100.0,	100.0),	(1500.0,	100.0),	(2000.0,	100.0),	(2500.0,	100.0),	(211.0,	100.0),
(300.0,	110.0),	(500.0,	110.0),	(800.0,	110.0),	(1100.0,	110.0),	(1500.0,	110.0),
(2000.0,	110.0),	(2500.0,	110.0),	(211.0,	120.0),	(300.0,	120.0),	(500.0,	120.0),
(800.0,	120.0),	(1100.0,	120.0),	(1500.0,	120.0),	(2000.0,	120.0),	(2500.0,	120.0),
(278.0,	130.0),	(300.0,	130.0),	(500.0,	130.0),	(800.0,	130.0),	(1100.0,	130.0),
(1500.0,	130.0),	(2000.0,	130.0),	(2500.0,	130.0),	(250.0,	140.0),	(300.0,	140.0),
(500.0,	140.0),	(800.0,	140.0),	(1100.0,	140.0),	(1500.0,	140.0),	(2000.0,	140.0),
(2500.0,	140.0),	(221.0,	150.0),	(300.0,	150.0),	(500.0,	150.0),	(800.0,	150.0),
(1100.0,	150.0),	(1500.0,	150.0),	(2000.0,	150.0),	(2500.0,	150.0),	(326.0,	160.0),
(500.0,	160.0),	(800.0,	160.0),	(1100.0,	160.0),	(1500.0,	160.0),	(2000.0,	160.0),
(2500.0,	160.0),	(461.0,	170.0),	(500.0,	170.0),	(800.0,	170.0),	(1100.0,	170.0),
(1500.0,	170.0),	(2000.0,	170.0),	(2500.0,	170.0),	(451.0,	180.0),	(500.0,	180.0),
(800.0,	180.0),	(1100.0,	180.0),	(1500.0,	180.0),	(2000.0,	180.0),	(2500.0,	180.0),
(461.0,	190.0),	(500.0,	190.0),	(800.0,	190.0),	(1100.0,	190.0),	(1500.0,	190.0),
(2000.0,	190.0),	(2500.0,	190.0),	(470.0,	200.0),	(500.0,	200.0),	(800.0,	200.0),
(1100.0,	200.0),	(1500.0,	200.0),	(2000.0,	200.0),	(2500.0,	200.0),	(509.0,	210.0),
(800.0,	210.0),	(1100.0,	210.0),	(1500.0,	210.0),	(2000.0,	210.0),	(2500.0,	210.0),
(576.0,	220.0),	(800.0,	220.0),	(1100.0,	220.0),	(1500.0,	220.0),	(2000.0,	220.0),
(2500.0,	220.0),	(701.0,	230.0),	(800.0,	230.0),	(1100.0,	230.0),	(1500.0,	230.0),
(2000.0,	230.0),	(2500.0,	230.0),	(739.0,	240.0),	(800.0,	240.0),	(1100.0,	240.0),
(1500.0,	240.0),	(2000.0,	240.0),	(2500.0,	240.0),	(835.0,	250.0),	(1100.0,	250.0),
(1500.0,	250.0),	(2000.0,	250.0),	(2500.0,	250.0),	(1094.0,	260.0),	(1100.0,	260.0),
(1500.0,	260.0),	(2000.0,	260.0),	(2500.0,	260.0),	(1085.0,	270.0),	(1100.0,	270.0),
(1500.0,	270.0),	(2000.0,	270.0),	(2500.0,	270.0),	(1114.0,	280.0),	(1500.0,	280.0),
(2000.0,	280.0),	(2500.0,	280.0),	(1613.0,	290.0),	(2000.0,	290.0),	(2500.0,	290.0),
(1766.0,	300.0),	(2000.0,	300.0),	(2500.0,	300.0),	(1766.0,	310.0),	(2000.0,	310.0),
(2500.0,	310.0),	(1488.0,	320.0),	(1500.0,	320.0),	(2000.0,	320.0),	(2500.0,	320.0),
(374.0,	330.0),	(500.0,	330.0),	(800.0,	330.0),	(1100.0,	330.0),	(1500.0,	330.0),
(2000.0,	330.0),	(2500.0,	330.0),	(346.0,	340.0),	(500.0,	340.0),	(800.0,	340.0),
(1100.0,	340.0),	(1500.0,	340.0),	(2000.0,	340.0),	(2500.0,	340.0),	(336.0,	350.0),
(500.0,	350.0),	(800.0,	350.0),	(1100.0,	350.0),	(1500.0,	350.0),	(2000.0,	350.0),
(2500.0,	350.0),	(326.0,	360.0),	(500.0,	360.0),	(800.0,	360.0),	(1100.0,	360.0),
(1500.0,	360.0),	(2000.0,	360.0),	(2500.0,	360.0),	(

*** SOURCE DATA ***

SOURCE NUMBER	P K E	T W Y A PART. CATS.	EMISSION RATE		X	Y	BASE		HEIGHT	TEMP.	EXIT VEL.		BLDG. HEIGHT	BLDG. LENGTH	BLDG. WIDTH
			TYPE=0,1	TYPE=2			(DEG.K);	TYPE=0		TYPE=0					
NUMBER	E		(GRAMS/SEC)	*PER METER**2	(METERS)	(METERS)	(METERS)	(METERS)	TYPE=1	TYPE=1,2	TYPE=0	TYPE=0	TYPE=0	TYPE=0	TYPE=0

3	0	0	0	0.28200E+01	70.0	-25.2	0.0	61.00	450.00	11.04	4.57	27.40	35.10	35.10	
*															
CALM HOURS	(=1)	FOR DAY	6	*	0	0	0	0	0	0	0	0	0	0	0
CALM HOURS	(=1)	FOR DAY	7	*	0	0	0	1	0	0	1	0	0	0	0
CALM HOURS	(=1)	FOR DAY	19	*	0	0	0	0	0	0	0	1	0	0	0
CALM HOURS	(=1)	FOR DAY	25	*	0	0	0	0	0	0	0	0	0	0	0
CALM HOURS	(=1)	FOR DAY	26	*	1	1	0	0	1	0	0	0	0	0	0
CALM HOURS	(=1)	FOR DAY	29	*	0	0	0	0	0	1	0	1	0	0	0
CALM HOURS	(=1)	FOR DAY	37	*	0	1	0	1	0	0	0	0	0	0	0
CALM HOURS	(=1)	FOR DAY	45	*	1	0	0	0	0	0	0	0	0	0	0
CALM HOURS	(=1)	FOR DAY	46	*	0	0	0	0	0	0	0	1	0	0	0
CALM HOURS	(=1)	FOR DAY	47	*	0	0	0	0	0	0	0	0	1	0	0
CALM HOURS	(=1)	FOR DAY	49	*	0	0	0	0	0	0	1	0	0	0	0
CALM HOURS	(=1)	FOR DAY	51	*	0	0	0	0	1	1	0	0	0	0	0
CALM HOURS	(=1)	FOR DAY	52	*	0	0	0	0	0	0	1	1	0	0	0
CALM HOURS	(=1)	FOR DAY	55	*	0	0	0	0	0	0	0	0	0	0	0
CALM HOURS	(=1)	FOR DAY	56	*	0	0	0	0	0	0	0	0	0	0	0
CALM HOURS	(=1)	FOR DAY	57	*	1	0	1	0	0	1	0	0	0	0	0
CALM HOURS	(=1)	FOR DAY	62	*	0	0	0	0	1	0	0	0	0	0	0
CALM HOURS	(=1)	FOR DAY	63	*	0	0	0	0	1	0	1	1	0	0	0
CALM HOURS	(=1)	FOR DAY	64	*	0	0	0	1	1	1	1	0	0	0	0
CALM HOURS	(=1)	FOR DAY	69	*	1	0	0	0	0	0	0	0	0	0	0
CALM HOURS	(=1)	FOR DAY	71	*	0	0	0	1	1	1	0	1	0	0	0
CALM HOURS	(=1)	FOR DAY	77	*	0	0	0	0	0	0	1	0	0	0	0
CALM HOURS	(=1)	FOR DAY	78	*	0	0	0	1	0	0	1	0	0	0	0
CALM HOURS	(=1)	FOR DAY	82	*	0	1	0	0	0	0	0	0	0	0	0
CALM HOURS	(=1)	FOR DAY	84	*	0	0	0	0	0	0	1	1	1	0	0
CALM HOURS	(=1)	FOR DAY	85	*	0	0	0	0	1	1	1	0	0	0	0
CALM HOURS	(=1)	FOR DAY	87	*	1	1	1	0	0	1	0	0	0	0	0
CALM HOURS	(=1)	FOR DAY	106	*	0	0	0	0	0	0	1	0	0	0	0
CALM HOURS	(=1)	FOR DAY	109	*	0	0	0	0	0	0	1	1	0	0	0
CALM HOURS	(=1)	FOR DAY	126	*	0	0	0	0	0	1	0	0	0	0	0
CALM HOURS	(=1)	FOR DAY	135	*	0	0	0	0	0	1	0	0	0	0	0
CALM HOURS	(=1)	FOR DAY	136	*	0	0	0	0	0	1	1	0	0	0	0
CALM HOURS	(=1)	FOR DAY	155	*	0	0	0	0	0	0	0	1	0	0	0
CALM HOURS	(=1)	FOR DAY	162	*	0	0	0	0	1	0	0	0	0	0	0
CALM HOURS	(=1)	FOR DAY	170	*	0	0	0	0	1	0	0	0	0	0	0
CALM HOURS	(=1)	FOR DAY	171	*	0	0	0	0	0	1	0	1	0	0	0
CALM HOURS	(=1)	FOR DAY	172	*	0	0	1	1	0	0	0	1	0	0	0
CALM HOURS	(=1)	FOR DAY	173	*	0	0	0	0	0	1	0	0	0	0	0
CALM HOURS	(=1)	FOR DAY	184	*	0	0	0	0	0	1	0	0	0	0	0
CALM HOURS	(=1)	FOR DAY	186	*	0	0	0	0	0	0	1	0	0	0	0
CALM HOURS	(=1)	FOR DAY	187	*	0	0	0	0	0	1	0	0	0	0	0
CALM HOURS	(=1)	FOR DAY	189	*	0	0	0	0	0	0	0	0	0	0	0
CALM HOURS	(=1)	FOR DAY	190	*	0	0	0	0	0	1	0	0	0	0	0
CALM HOURS	(=1)	FOR DAY	192	*	0	1	1	0	0	0	0	0	0	0	0
CALM HOURS	(=1)	FOR DAY	193	*	0	0	0	0	1	0	0	0	0	0	0
CALM HOURS	(=1)	FOR DAY	194	*	0	0	0	1	1	0	0	0	0	0	0
CALM HOURS	(=1)	FOR DAY	197	*	1	0	0	0	0	0	0	0	0	0	0
CALM HOURS	(=1)	FOR DAY	198	*	0	0	0	0	0	0	0	0	0	0	0
CALM HOURS	(=1)	FOR DAY	199	*	0	0	0	0	0	1	0	0	0	0	0
CALM HOURS	(=1)	FOR DAY	203	*	0	0	0	0	1	0	0	0	0	0	0

*** ISCST BY KBN 1/90 *** 1984 TARMAC KILN 3 NOX Increase

10-23-90 ***

* 366-DAY AVERAGE CONCENTRATION (MICROGRAMS/CUBIC METER) *

* FROM ALL SOURCES *
 * FOR THE RECEPTOR GRID *

* MAXIMUM VALUE EQUALS 0.04541 AND OCCURRED AT (3000.0, 300.0) *

DIRECTION / (DEGREES) /	RANGE (METERS)			
	3000.0	3500.0	4000.0	4500.0
360.0 /	0.00837	0.00763	0.00697	0.00641
350.0 /	0.01336	0.01212	0.01106	0.01016
340.0 /	0.01986	0.01794	0.01624	0.01478
330.0 /	0.02752	0.02494	0.02261	0.02060
320.0 /	0.03693	0.03368	0.03067	0.02802
310.0 /	0.04183	0.03878	0.03594	0.03339
300.0 /	0.04541	0.04303	0.04079	0.03871
290.0 /	0.04462	0.04278	0.04090	0.03905
280.0 /	0.03906	0.03794	0.03671	0.03542
270.0 /	0.03942	0.03894	0.03814	0.03712
260.0 /	0.03178	0.03110	0.03018	0.02914
250.0 /	0.02838	0.02777	0.02700	0.02613
240.0 /	0.02840	0.02819	0.02774	0.02711
230.0 /	0.02007	0.01988	0.01957	0.01913
220.0 /	0.01274	0.01226	0.01175	0.01122
210.0 /	0.01008	0.00978	0.00944	0.00909
200.0 /	0.01019	0.01007	0.00988	0.00964
190.0 /	0.01269	0.01295	0.01307	0.01305
180.0 /	0.01881	0.01944	0.01978	0.01985
170.0 /	0.01866	0.01906	0.01918	0.01908
160.0 /	0.01423	0.01405	0.01370	0.01327
150.0 /	0.01063	0.01053	0.01032	0.01006
140.0 /	0.00940	0.00916	0.00883	0.00846
130.0 /	0.00750	0.00725	0.00699	0.00675
120.0 /	0.00642	0.00619	0.00596	0.00574
110.0 /	0.00588	0.00556	0.00524	0.00494
100.0 /	0.00718	0.00682	0.00645	0.00609
90.0 /	0.00629	0.00602	0.00575	0.00547
80.0 /	0.00556	0.00525	0.00494	0.00464
70.0 /	0.00578	0.00545	0.00511	0.00478
60.0 /	0.00508	0.00489	0.00467	0.00444
50.0 /	0.00467	0.00454	0.00440	0.00425
40.0 /	0.00510	0.00487	0.00465	0.00443
30.0 /	0.00586	0.00562	0.00539	0.00517
20.0 /	0.00545	0.00510	0.00480	0.00454
10.0 /	0.00579	0.00534	0.00495	0.00462

*** ISCST BY KBN 1/90 *** 1984 TARMAC KILN 3 NOX Increase

10-23-90 ***

* 366-DAY AVERAGE CONCENTRATION (MICROGRAMS/CUBIC METER) *

* FROM ALL SOURCES *

* FOR THE DISCRETE RECEPTOR POINTS *

- RNG -	- DIR -	CON.	- RNG -	- DIR -	CON.	- RNG -	- DIR -	CON.
336.0	10.0	0.00094	500.0	10.0	0.00042	800.0	10.0	0.00245
1100.0	10.0	0.00445	1500.0	10.0	0.00580	2000.0	10.0	0.00641
2500.0	10.0	0.00622	230.0	20.0	0.00083	300.0	20.0	0.00081
500.0	20.0	0.00102	800.0	20.0	0.00242	1100.0	20.0	0.00410
1500.0	20.0	0.00539	2000.0	20.0	0.00594	2500.0	20.0	0.00579
211.0	30.0	0.00116	300.0	30.0	0.00307	500.0	30.0	0.00246
800.0	30.0	0.00255	1100.0	30.0	0.00390	1500.0	30.0	0.00527
2000.0	30.0	0.00600	2500.0	30.0	0.00604	211.0	40.0	0.00288
300.0	40.0	0.00429	500.0	40.0	0.00136	800.0	40.0	0.00144
1100.0	40.0	0.00297	1500.0	40.0	0.00440	2000.0	40.0	0.00518
2500.0	40.0	0.00526	211.0	50.0	0.00207	300.0	50.0	0.00245
500.0	50.0	0.00119	800.0	50.0	0.00112	1100.0	50.0	0.00240
1500.0	50.0	0.00367	2000.0	50.0	0.00449	2500.0	50.0	0.00470
221.0	60.0	0.00157	300.0	60.0	0.00175	500.0	60.0	0.00097
800.0	60.0	0.00113	1100.0	60.0	0.00270	1500.0	60.0	0.00413
2000.0	60.0	0.00497	2500.0	60.0	0.00515	230.0	70.0	0.00117
300.0	70.0	0.00141	500.0	70.0	0.00096	800.0	70.0	0.00143
1100.0	70.0	0.00334	1500.0	70.0	0.00500	2000.0	70.0	0.00589
2500.0	70.0	0.00599	202.0	80.0	0.00107	300.0	80.0	0.00172
500.0	80.0	0.00102	800.0	80.0	0.00157	1100.0	80.0	0.00332
1500.0	80.0	0.00484	2000.0	80.0	0.00568	2500.0	80.0	0.00576
192.0	90.0	0.00110	300.0	90.0	0.00334	500.0	90.0	0.00286
800.0	90.0	0.00262	1100.0	90.0	0.00402	1500.0	90.0	0.00554
2000.0	90.0	0.00637	2500.0	90.0	0.00645	192.0	100.0	0.00177
300.0	100.0	0.00356	500.0	100.0	0.00287	800.0	100.0	0.00248
1100.0	100.0	0.00425	1500.0	100.0	0.00617	2000.0	100.0	0.00729
2500.0	100.0	0.00742	211.0	100.0	0.00206	300.0	110.0	0.00212
500.0	110.0	0.00156	800.0	110.0	0.00171	1100.0	110.0	0.00347
1500.0	110.0	0.00509	2000.0	110.0	0.00603	2500.0	110.0	0.00611
211.0	120.0	0.00147	300.0	120.0	0.00224	500.0	120.0	0.00160
800.0	120.0	0.00185	1100.0	120.0	0.00362	1500.0	120.0	0.00533
2000.0	120.0	0.00636	2500.0	120.0	0.00653	278.0	130.0	0.00417
300.0	130.0	0.00440	500.0	130.0	0.00240	800.0	130.0	0.00213
1100.0	130.0	0.00411	1500.0	130.0	0.00616	2000.0	130.0	0.00740
2500.0	130.0	0.00763	250.0	140.0	0.00472	300.0	140.0	0.00608
500.0	140.0	0.00403	800.0	140.0	0.00288	1100.0	140.0	0.00459
1500.0	140.0	0.00698	2000.0	140.0	0.00877	2500.0	140.0	0.00936
221.0	150.0	0.00452	300.0	150.0	0.00560	500.0	150.0	0.00345

*** ISCST BY KBN 1/90 *** 1984 TARMAC KILN 3 NOX Increase

10-23-90 ***

* 366-DAY AVERAGE CONCENTRATION (MICROGRAMS/CUBIC METER) *

* FROM ALL SOURCES *
* FOR THE DISCRETE RECEPTOR POINTS *

- RNG -	- DIR -	CON.	- RNG -	- DIR -	CON.	- RNG -	- DIR -	CON.
800.0	150.0	0.00274	1100.0	150.0	0.00473	1500.0	150.0	0.00741
2000.0	150.0	0.00957	2500.0	150.0	0.01041	326.0	160.0	0.01155
500.0	160.0	0.00377	800.0	160.0	0.00275	1100.0	160.0	0.00555
1500.0	160.0	0.00930	2000.0	160.0	0.01254	2500.0	160.0	0.01389
461.0	170.0	0.00615	500.0	170.0	0.00542	800.0	170.0	0.00407
1100.0	170.0	0.00722	1500.0	170.0	0.01166	2000.0	170.0	0.01565
2500.0	170.0	0.01765	451.0	180.0	0.00348	500.0	180.0	0.00298
800.0	180.0	0.00306	1100.0	180.0	0.00659	1500.0	180.0	0.01109
2000.0	180.0	0.01525	2500.0	180.0	0.01753	461.0	190.0	0.00187
500.0	190.0	0.00165	800.0	190.0	0.00211	1100.0	190.0	0.00510
1500.0	190.0	0.00825	2000.0	190.0	0.01080	2500.0	190.0	0.01207
470.0	200.0	0.00216	500.0	200.0	0.00189	800.0	200.0	0.00199
1100.0	200.0	0.00466	1500.0	200.0	0.00743	2000.0	200.0	0.00936
2500.0	200.0	0.01005	509.0	210.0	0.00340	800.0	210.0	0.00305
1100.0	210.0	0.00564	1500.0	210.0	0.00821	2000.0	210.0	0.00979
2500.0	210.0	0.01017	576.0	220.0	0.00524	800.0	220.0	0.00520
1100.0	220.0	0.00822	1500.0	220.0	0.01119	2000.0	220.0	0.01280
2500.0	220.0	0.01299	701.0	230.0	0.00720	800.0	230.0	0.00789
1100.0	230.0	0.01230	1500.0	230.0	0.01665	2000.0	230.0	0.01920
2500.0	230.0	0.01986	739.0	240.0	0.00827	800.0	240.0	0.00920
1100.0	240.0	0.01563	1500.0	240.0	0.02226	2000.0	240.0	0.02653
2500.0	240.0	0.02793	835.0	250.0	0.01086	1100.0	250.0	0.01682
1500.0	250.0	0.02346	2000.0	250.0	0.02746	2500.0	250.0	0.02841
1094.0	260.0	0.01866	1100.0	260.0	0.01879	1500.0	260.0	0.02608
2000.0	260.0	0.03053	2500.0	260.0	0.03174	1085.0	270.0	0.02170
1100.0	270.0	0.02212	1500.0	270.0	0.03122	2000.0	270.0	0.03709
2500.0	270.0	0.03898	1114.0	280.0	0.02420	1500.0	280.0	0.03328
2000.0	280.0	0.03855	2500.0	280.0	0.03950	1613.0	290.0	0.04116
2000.0	290.0	0.04510	2500.0	290.0	0.04574	1766.0	300.0	0.04590
2000.0	300.0	0.04743	2500.0	300.0	0.04729	1766.0	310.0	0.04421
2000.0	310.0	0.04537	2500.0	310.0	0.04450	1488.0	320.0	0.03659
1500.0	320.0	0.03679	2000.0	320.0	0.04095	2500.0	320.0	0.03983
374.0	330.0	0.00066	500.0	330.0	0.00129	800.0	330.0	0.01147
1100.0	330.0	0.02155	1500.0	330.0	0.02883	2000.0	330.0	0.03130
2500.0	330.0	0.02998	346.0	340.0	0.00072	500.0	340.0	0.00127
800.0	340.0	0.00928	1100.0	340.0	0.01641	1500.0	340.0	0.02136
2000.0	340.0	0.02288	2500.0	340.0	0.02175	336.0	350.0	0.00024
500.0	350.0	0.00063	800.0	350.0	0.00662	1100.0	350.0	0.01143

*** ISCST BY KBN 1/90 *** 1984 TARMAC KILN 3 NOX Increase

10-23-90 ***

* 366-DAY AVERAGE CONCENTRATION (MICROGRAMS/CUBIC METER) *

* FROM ALL SOURCES *
* FOR THE DISCRETE RECEPTOR POINTS *

- RNG -	- DIR -	CON.	- RNG -	- DIR -	CON.	- RNG -	- DIR -	CON.
1500.0	350.0	0.01453	2000.0	350.0	0.01541	2500.0	350.0	0.01461
326.0	360.0	0.00040	500.0	360.0	0.00047	800.0	360.0	0.00406
1100.0	360.0	0.00699	1500.0	360.0	0.00883	2000.0	360.0	0.00950
2500.0	360.0	0.00910						

CALCULATE (CONCENTRATION=1,DEPOSITION=2)	ISW(1) = 1
RECEPTOR GRID SYSTEM (RECTANGULAR=1 OR 3, POLAR=2 OR 4)	ISW(2) = 4
DISCRETE RECEPTOR SYSTEM (RECTANGULAR=1,POLAR=2)	ISW(3) = 2
TERRAIN ELEVATIONS ARE READ (YES=1,NO=0)	ISW(4) = 0
CALCULATIONS ARE WRITTEN TO TAPE (YES=1,NO=0)	ISW(5) = 0
LIST ALL INPUT DATA (NO=0,YES=1,MET DATA ALSO=2)	ISW(6) = 1
COMPUTE AVERAGE CONCENTRATION (OR TOTAL DEPOSITION)	
WITH THE FOLLOWING TIME PERIODS:	
HOURLY (YES=1,NO=0)	ISW(7) = 0
2-HOUR (YES=1,NO=0)	ISW(8) = 0
3-HOUR (YES=1,NO=0)	ISW(9) = 0
4-HOUR (YES=1,NO=0)	ISW(10) = 0
6-HOUR (YES=1,NO=0)	ISW(11) = 0
8-HOUR (YES=1,NO=0)	ISW(12) = 0
12-HOUR (YES=1,NO=0)	ISW(13) = 0
24-HOUR (YES=1,NO=0)	ISW(14) = 0
PRINT 'N'-DAY TABLE(S) (YES=1,NO=0)	ISW(15) = 1
PRINT THE FOLLOWING TYPES OF TABLES WHOSE TIME PERIODS ARE	
SPECIFIED BY ISW(7) THROUGH ISW(14):	
DAILY TABLES (YES=1,NO=0)	ISW(16) = 0
HIGHEST & SECOND HIGHEST TABLES (YES=1,NO=0)	ISW(17) = 0
MAXIMUM 50 TABLES (YES=1,NO=0)	ISW(18) = 0
METEOROLOGICAL DATA INPUT METHOD (PRE-PROCESSED=1,CARD=2)	ISW(19) = 1
RURAL-URBAN OPTION (RU.=0,UR. MODE 1=1,UR. MODE 2=2,UR. MODE 3=3)	ISW(20) = 0
WIND PROFILE EXPONENT VALUES (DEFAULTS=1,USER ENTERS=2,3)	ISW(21) = 1
VERTICAL POT. TEMP. GRADIENT VALUES (DEFAULTS=1,USER ENTERS=2,3)	ISW(22) = 1
SCALE EMISSION RATES FOR ALL SOURCES (NO=0,YES>0)	ISW(23) = 0
PROGRAM CALCULATES FINAL PLUME RISE ONLY (YES=1,NO=2)	ISW(24) = 1
PROGRAM ADJUSTS ALL STACK HEIGHTS FOR DOWNWASH (YES=2,NO=1)	ISW(25) = 2
PROGRAM USES BUOYANCY INDUCED DISPERSION (YES=1,NO=2)	ISW(26) = 1
CONCENTRATIONS DURING CALM PERIODS SET = 0 (YES=1,NO=2)	ISW(27) = 1
REG. DEFAULT OPTION CHOSEN (YES=1,NO=2)	ISW(28) = 1
TYPE OF POLLUTANT TO BE MODELLED (1=S02,2=OTHER)	ISW(29) = 2
DEBUG OPTION CHOSEN (YES=1,NO=2)	ISW(30) = 2
ABOVE GROUND (FLAGPOLE) RECEPTORS USED (YES=1,NO=0)	ISW(31) = 0
NUMBER OF INPUT SOURCES	NSOURC = 1
NUMBER OF SOURCE GROUPS (=0,ALL SOURCES)	NGROUP = 0
TIME PERIOD INTERVAL TO BE PRINTED (=0,ALL INTERVALS)	IPERD = 0
NUMBER OF X (RANGE) GRID VALUES	NXPNTS = 4
NUMBER OF Y (THETA) GRID VALUES	NYPNTS = 36
NUMBER OF DISCRETE RECEPTORS	NXWYPT = 238
SOURCE EMISSION RATE UNITS CONVERSION FACTOR	TK = .10000E+07
HEIGHT ABOVE GROUND AT WHICH WIND SPEED WAS MEASURED	ZR = 7.01 METERS
LOGICAL UNIT NUMBER OF METEOROLOGICAL DATA	IMET = 9
DECAY COEFFICIENT FOR PHYSICAL OR CHEMICAL DEPLETION	DECAY = 0.000000E+00
SURFACE STATION NO.	ISS = 12839
YEAR OF SURFACE DATA	ISY = 85
UPPER AIR STATION NO.	IUS = 12844
YEAR OF UPPER AIR DATA	IUY = 85
ALLOCATED DATA STORAGE	LIMIT = 43500 WORDS
REQUIRED DATA STORAGE FOR THIS PROBLEM RUN	MIMIT = 1949 WORDS

*** RANGES OF POLAR GRID SYSTEM ***
(METERS)

3000.0, 3500.0, 4000.0, 4500.0,

*** RADIAL ANGLES OF POLAR GRID SYSTEM ***

(DEGREES)

10.0,	20.0,	30.0,	40.0,	50.0,	60.0,	70.0,	80.0,	90.0,	100.0,
110.0,	120.0,	130.0,	140.0,	150.0,	160.0,	170.0,	180.0,	190.0,	200.0,
210.0,	220.0,	230.0,	240.0,	250.0,	260.0,	270.0,	280.0,	290.0,	300.0,
310.0,	320.0,	330.0,	340.0,	350.0,	360.0,				

*** RANGE, THETA COORDINATES OF DISCRETE RECEPTORS ***
(METERS, DEGREES)

(336.0, 10.0),	(500.0, 10.0),	(800.0, 10.0),	(1100.0, 10.0),	(1500.0, 10.0),
(2000.0, 10.0),	(2500.0, 10.0),	(230.0, 20.0),	(300.0, 20.0),	(500.0, 20.0),
(800.0, 20.0),	(1100.0, 20.0),	(1500.0, 20.0),	(2000.0, 20.0),	(2500.0, 20.0),
(211.0, 30.0),	(300.0, 30.0),	(500.0, 30.0),	(800.0, 30.0),	(1100.0, 30.0),
(1500.0, 30.0),	(2000.0, 30.0),	(2500.0, 30.0),	(211.0, 40.0),	(300.0, 40.0),
(500.0, 40.0),	(800.0, 40.0),	(1100.0, 40.0),	(1500.0, 40.0),	(2000.0, 40.0),
(2500.0, 40.0),	(211.0, 50.0),	(300.0, 50.0),	(500.0, 50.0),	(800.0, 50.0),
(1100.0, 50.0),	(1500.0, 50.0),	(2000.0, 50.0),	(2500.0, 50.0),	(221.0, 60.0),
(300.0, 60.0),	(500.0, 60.0),	(800.0, 60.0),	(1100.0, 60.0),	(1500.0, 60.0),
(2000.0, 60.0),	(2500.0, 60.0),	(230.0, 70.0),	(300.0, 70.0),	(500.0, 70.0),
(800.0, 70.0),	(1100.0, 70.0),	(1500.0, 70.0),	(2000.0, 70.0),	(2500.0, 70.0),
(202.0, 80.0),	(300.0, 80.0),	(500.0, 80.0),	(800.0, 80.0),	(1100.0, 80.0),
(1500.0, 80.0),	(2000.0, 80.0),	(2500.0, 80.0),	(192.0, 90.0),	(300.0, 90.0),
(500.0, 90.0),	(800.0, 90.0),	(1100.0, 90.0),	(1500.0, 90.0),	(2000.0, 90.0),
(2500.0, 90.0),	(192.0, 100.0),	(300.0, 100.0),	(500.0, 100.0),	(800.0, 100.0),
(1100.0, 100.0),	(1500.0, 100.0),	(2000.0, 100.0),	(2500.0, 100.0),	(211.0, 100.0),
(300.0, 110.0),	(500.0, 110.0),	(800.0, 110.0),	(1100.0, 110.0),	(1500.0, 110.0),
(2000.0, 110.0),	(2500.0, 110.0),	(211.0, 120.0),	(300.0, 120.0),	(500.0, 120.0),
(800.0, 120.0),	(1100.0, 120.0),	(1500.0, 120.0),	(2000.0, 120.0),	(2500.0, 120.0),
(278.0, 130.0),	(300.0, 130.0),	(500.0, 130.0),	(800.0, 130.0),	(1100.0, 130.0),
(1500.0, 130.0),	(2000.0, 130.0),	(2500.0, 130.0),	(250.0, 140.0),	(300.0, 140.0),
(500.0, 140.0),	(800.0, 140.0),	(1100.0, 140.0),	(1500.0, 140.0),	(2000.0, 140.0),
(2500.0, 140.0),	(221.0, 150.0),	(300.0, 150.0),	(500.0, 150.0),	(800.0, 150.0),
(1100.0, 150.0),	(1500.0, 150.0),	(2000.0, 150.0),	(2500.0, 150.0),	(326.0, 160.0),
(500.0, 160.0),	(800.0, 160.0),	(1100.0, 160.0),	(1500.0, 160.0),	(2000.0, 160.0),
(2500.0, 160.0),	(461.0, 170.0),	(500.0, 170.0),	(800.0, 170.0),	(1100.0, 170.0),
(1500.0, 170.0),	(2000.0, 170.0),	(2500.0, 170.0),	(451.0, 180.0),	(500.0, 180.0),
(800.0, 180.0),	(1100.0, 180.0),	(1500.0, 180.0),	(2000.0, 180.0),	(2500.0, 180.0),
(461.0, 190.0),	(500.0, 190.0),	(800.0, 190.0),	(1100.0, 190.0),	(1500.0, 190.0),
(2000.0, 190.0),	(2500.0, 190.0),	(470.0, 200.0),	(500.0, 200.0),	(800.0, 200.0),
(1100.0, 200.0),	(1500.0, 200.0),	(2000.0, 200.0),	(2500.0, 200.0),	(509.0, 210.0),
(800.0, 210.0),	(1100.0, 210.0),	(1500.0, 210.0),	(2000.0, 210.0),	(2500.0, 210.0),
(576.0, 220.0),	(800.0, 220.0),	(1100.0, 220.0),	(1500.0, 220.0),	(2000.0, 220.0),
(2500.0, 220.0),	(701.0, 230.0),	(800.0, 230.0),	(1100.0, 230.0),	(1500.0, 230.0),
(2000.0, 230.0),	(2500.0, 230.0),	(739.0, 240.0),	(800.0, 240.0),	(1100.0, 240.0),
(1500.0, 240.0),	(2000.0, 240.0),	(2500.0, 240.0),	(835.0, 250.0),	(1100.0, 250.0),
(1500.0, 250.0),	(2000.0, 250.0),	(2500.0, 250.0),	(1094.0, 260.0),	(1100.0, 260.0),
(1500.0, 260.0),	(2000.0, 260.0),	(2500.0, 260.0),	(1085.0, 270.0),	(1100.0, 270.0),
(1500.0, 270.0),	(2000.0, 270.0),	(2500.0, 270.0),	(1114.0, 280.0),	(1500.0, 280.0),
(2000.0, 280.0),	(2500.0, 280.0),	(1613.0, 290.0),	(2000.0, 290.0),	(2500.0, 290.0),
(1766.0, 300.0),	(2000.0, 300.0),	(2500.0, 300.0),	(1766.0, 310.0),	(2000.0, 310.0),
(2500.0, 310.0),	(1488.0, 320.0),	(1500.0, 320.0),	(2000.0, 320.0),	(2500.0, 320.0),
(374.0, 330.0),	(500.0, 330.0),	(800.0, 330.0),	(1100.0, 330.0),	(1500.0, 330.0),
(2000.0, 330.0),	(2500.0, 330.0),	(346.0, 340.0),	(500.0, 340.0),	(800.0, 340.0),
(1100.0, 340.0),	(1500.0, 340.0),	(2000.0, 340.0),	(2500.0, 340.0),	(336.0, 350.0),
(500.0, 350.0),	(800.0, 350.0),	(1100.0, 350.0),	(1500.0, 350.0),	(2000.0, 350.0),
(2500.0, 350.0),	(326.0, 360.0),	(500.0, 360.0),	(800.0, 360.0),	(1100.0, 360.0),
(1500.0, 360.0),	(2000.0, 360.0),	(2500.0, 360.0),	(

*** SOURCE DATA ***

SOURCE NUMBER	P K E E	PART. CATS.	EMISSION RATE		X	Y	BASE		HEIGHT	TEMP.	EXIT VEL.		BLDG. HEIGHT	BLDG. LENGTH	BLDG. WIDTH
			TYPE=0,1 (GRAMS/SEC)	TYPE=2 (GRAMS/SEC)			VERT.DIM TYPE=1	HORZ.DIM TYPE=1,2		DIAMETER TYPE=0	TYPE=0	TYPE=0			
NUMBER	E	E	*PER METER**2	(METERS)	(METERS)	(METERS)	(METERS)	(METERS)	(METERS)	(METERS)	(METERS)	(METERS)	(METERS)	(METERS)	(METERS)

3	0	0	0	0.28200E+01	70.0	-25.2	0.0	61.00	450.00	11.04	4.57	27.40	35.10	35.10	
* CALM HOURS (=1) FOR DAY 5 * 0 0 1 1 1 0 0 0 0 0 0 0 0 0 0 0															
* CALM HOURS (=1) FOR DAY 10 * 0 0 0 0 0 0 1 0 0 0 0 0 0 0 0 0															
* CALM HOURS (=1) FOR DAY 11 * 1 1 0 0 0 0 0 0 0 0 0 0 0 0 0 0															
* CALM HOURS (=1) FOR DAY 20 * 0 0 0 0 1 1 1 1 0 0 0 0 0 0 0 0															
* CALM HOURS (=1) FOR DAY 24 * 0 0 0 0 0 0 1 0 1 0 0 0 0 0 0 0															
* CALM HOURS (=1) FOR DAY 27 * 0 0 0 0 0 0 0 0 0 0 0 0 0 0 0 1															
* CALM HOURS (=1) FOR DAY 28 * 0 0 0 1 1 0 0 1 0 0 0 0 0 0 0 0															
* CALM HOURS (=1) FOR DAY 30 * 0 0 0 0 1 1 1 0 0 0 0 0 0 0 0 0															
* CALM HOURS (=1) FOR DAY 35 * 0 1 0 0 0 0 0 0 0 0 0 0 0 0 0 0															
* CALM HOURS (=1) FOR DAY 38 * 0 0 0 0 0 1 0 0 0 0 0 0 0 0 0 0															
* CALM HOURS (=1) FOR DAY 47 * 0 1 0 0 0 0 0 0 0 0 0 0 0 0 0 0															
* CALM HOURS (=1) FOR DAY 48 * 0 0 1 0 0 0 0 0 0 0 0 0 0 0 0 0															
* CALM HOURS (=1) FOR DAY 58 * 0 0 0 0 0 0 1 1 0 0 0 0 0 0 0 0															
* CALM HOURS (=1) FOR DAY 59 * 0 0 0 0 0 0 0 0 0 0 1 0 0 0 0 0															
* CALM HOURS (=1) FOR DAY 60 * 0 0 1 0 0 1 1 0 1 0 0 0 0 0 0 0															
* CALM HOURS (=1) FOR DAY 70 * 0 1 0 0 0 0 0 0 1 0 0 0 0 0 0 0															
* CALM HOURS (=1) FOR DAY 71 * 0 1 0 0 0 0 0 0 1 0 1 0 0 0 0 0															
* CALM HOURS (=1) FOR DAY 72 * 0 1 1 0 1 0 0 0 0 0 0 0 0 0 0 1															
* CALM HOURS (=1) FOR DAY 73 * 1 1 1 0 0 0 1 0 0 0 0 0 0 0 0 0															
* CALM HOURS (=1) FOR DAY 74 * 0 1 1 0 1 0 0 0 0 0 1 0 0 0 0 0															
* CALM HOURS (=1) FOR DAY 104 * 0 0 1 0 0 0 1 0 0 0 0 0 0 0 0 0															
* CALM HOURS (=1) FOR DAY 131 * 0 1 1 0 0 0 0 0 0 0 0 0 0 0 0 0															
* CALM HOURS (=1) FOR DAY 141 * 0 1 1 1 0 0 0 0 0 0 0 0 0 0 0 1															
* CALM HOURS (=1) FOR DAY 143 * 0 0 0 0 1 0 0 0 0 0 0 0 0 0 0 0															
* CALM HOURS (=1) FOR DAY 160 * 0 0 0 0 0 0 1 0 0 0 0 0 0 0 0 0															
* CALM HOURS (=1) FOR DAY 161 * 0 0 1 1 0 0 0 0 0 0 0 0 0 0 0 0															
* CALM HOURS (=1) FOR DAY 163 * 0 0 0 0 0 0 0 0 0 0 0 0 0 1 0 0															
* CALM HOURS (=1) FOR DAY 181 * 0 0 0 0 0 0 0 0 0 0 0 0 0 0 1 0															
* CALM HOURS (=1) FOR DAY 182 * 0 0 0 0 0 0 0 0 0 0 0 0 0 0 0 1															
* CALM HOURS (=1) FOR DAY 189 * 0 0 0 0 0 0 0 0 0 0 0 0 0 0 1 0															
* CALM HOURS (=1) FOR DAY 190 * 1 1 0 0 1 0 0 0 0 0 0 0 0 0 1 0															
* CALM HOURS (=1) FOR DAY 192 * 0 0 0 0 0 0 0 0 0 0 0 0 0 1 1 0															
* CALM HOURS (=1) FOR DAY 193 * 1 0 0 0 0 0 0 0 0 0 0 0 0 0 1 0															
* CALM HOURS (=1) FOR DAY 194 * 1 0 0 0 0 0 0 0 0 0 0 0 0 0 0 0															
* CALM HOURS (=1) FOR DAY 195 * 1 0 0 0 0 0 0 0 0 0 0 0 0 0 0 0															
* CALM HOURS (=1) FOR DAY 196 * 0 0 0 0 1 0 0 0 0 0 0 0 0 0 0 0															
* CALM HOURS (=1) FOR DAY 198 * 0 0 0 1 1 0 0 0 0 0 0 0 0 0 0 0															
* CALM HOURS (=1) FOR DAY 199 * 0 0 1 0 0 0 0 0 0 0 0 0 0 0 0 0															
* CALM HOURS (=1) FOR DAY 200 * 0 0 0 0 0 0 0 0 0 0 0 0 0 0 1 0															
* CALM HOURS (=1) FOR DAY 201 * 0 0 0 0 0 1 0 1 1 0 0 0 0 0 0 0															
* CALM HOURS (=1) FOR DAY 213 * 0 0 0 0 0 0 0 0 0 0 0 0 0 0 1 0															
* CALM HOURS (=1) FOR DAY 214 * 0 0 0 1 0 0 0 0 0 0 0 0 0 0 0 0															
* CALM HOURS (=1) FOR DAY 215 * 0 0 1 1 1 0 1 0 0 0 0 0 0 0 0 0															
* CALM HOURS (=1) FOR DAY 216 * 1 1 1 1 0 0 1 1 0 1 1 0 0 0 0 0															
* CALM HOURS (=1) FOR DAY 217 * 0 0 0 0 0 0 0 0 0 0 0 0 1 0 0 0															
* CALM HOURS (=1) FOR DAY 218 * 1 1 0 0 0 0 0 0 0 0 0 1 1 0 0 0															
* CALM HOURS (=1) FOR DAY 220 * 0 0 1 0 0 0 0 0 0 0 0 0 0 0 0 0															
* CALM HOURS (=1) FOR DAY 221 * 0 0 1 0 0 0 0 0 0 0 0 0 0 0 0 1															
* CALM HOURS (=1) FOR DAY 222 * 0 0 1 0 0 0 0 0 0 0 0 0 0 0 0 0															
* CALM HOURS (=1) FOR DAY 231 * 0 1 0 0 0 1 1 0 0 0 0 0 0 0 0 0															

* CALM HOURS (=1) FOR DAY 266 * 1 0
* CALM HOURS (=1) FOR DAY 285 * 1 0 1 0
* CALM HOURS (=1) FOR DAY 302 * 1 0
* CALM HOURS (=1) FOR DAY 312 * 0 0 1 0
* CALM HOURS (=1) FOR DAY 320 * 0 0 0 0 0 1 0 0 0 0 0 0 0 0 0 0 0 0 0 0 0 0 0 0
* CALM HOURS (=1) FOR DAY 362 * 0 1
* CALM HOURS (=1) FOR DAY 363 * 0 0 0 0 0 0 1 0 0 0 0 0 0 0 0 0 0 0 0 0 0 0 0 0

*** ISCST BY KBN 1/90 *** 1985 TARMAC KILN 3 NOX Increase

10-23-90 ***

* 365-DAY AVERAGE CONCENTRATION (MICROGRAMS/CUBIC METER) *

* FROM ALL SOURCES *
* FOR THE RECEPTOR GRID *

* MAXIMUM VALUE EQUALS 0.03462 AND OCCURRED AT (3000.0, 320.0) *

DIRECTION / (DEGREES) /	RANGE (METERS)			
	3000.0	3500.0	4000.0	4500.0
360.0 /	0.01047	0.01009	0.00970	0.00930
350.0 /	0.01810	0.01752	0.01688	0.01622
340.0 /	0.02712	0.02620	0.02515	0.02406
330.0 /	0.03199	0.03096	0.02975	0.02850
320.0 /	0.03462	0.03335	0.03190	0.03042
310.0 /	0.03170	0.03061	0.02940	0.02813
300.0 /	0.03195	0.03109	0.03004	0.02890
290.0 /	0.03075	0.02988	0.02885	0.02775
280.0 /	0.03210	0.03185	0.03131	0.03054
270.0 /	0.02969	0.02990	0.02981	0.02945
260.0 /	0.02639	0.02620	0.02576	0.02515
250.0 /	0.02964	0.02974	0.02951	0.02902
240.0 /	0.02882	0.02904	0.02888	0.02841
230.0 /	0.02320	0.02309	0.02270	0.02210
220.0 /	0.01324	0.01300	0.01266	0.01224
210.0 /	0.00854	0.00836	0.00815	0.00792
200.0 /	0.00745	0.00734	0.00720	0.00704
190.0 /	0.00672	0.00675	0.00675	0.00669
180.0 /	0.00969	0.01003	0.01021	0.01025
170.0 /	0.01285	0.01327	0.01349	0.01356
160.0 /	0.01479	0.01528	0.01555	0.01563
150.0 /	0.01768	0.01767	0.01745	0.01711
140.0 /	0.01568	0.01537	0.01492	0.01440
130.0 /	0.01332	0.01318	0.01291	0.01257
120.0 /	0.01036	0.01009	0.00976	0.00939
110.0 /	0.00782	0.00786	0.00786	0.00781
100.0 /	0.00589	0.00572	0.00553	0.00535
90.0 /	0.00706	0.00679	0.00647	0.00616
80.0 /	0.00769	0.00761	0.00744	0.00723
70.0 /	0.00794	0.00786	0.00770	0.00751
60.0 /	0.00723	0.00709	0.00688	0.00666
50.0 /	0.00675	0.00673	0.00664	0.00652
40.0 /	0.00586	0.00583	0.00573	0.00560
30.0 /	0.00546	0.00564	0.00570	0.00569
20.0 /	0.00519	0.00528	0.00532	0.00530
10.0 /	0.00760	0.00761	0.00756	0.00746

*** ISCST BY KBN 1/90 *** 1985 TARMAC KILN 3 NOX Increase

10-23-90 ***

* 365-DAY AVERAGE CONCENTRATION (MICROGRAMS/CUBIC METER) *

* FROM ALL SOURCES *

* FOR THE DISCRETE RECEPTOR POINTS *

- RNG -	- DIR -	CON.	- RNG -	- DIR -	CON.	- RNG -	- DIR -	CON.
336.0	10.0	0.00416	500.0	10.0	0.00193	800.0	10.0	0.00262
1100.0	10.0	0.00434	1500.0	10.0	0.00595	2000.0	10.0	0.00704
2500.0	10.0	0.00745	230.0	20.0	0.00311	300.0	20.0	0.00332
500.0	20.0	0.00220	800.0	20.0	0.00186	1100.0	20.0	0.00267
1500.0	20.0	0.00371	2000.0	20.0	0.00456	2500.0	20.0	0.00496
211.0	30.0	0.00310	300.0	30.0	0.00409	500.0	30.0	0.00212
800.0	30.0	0.00146	1100.0	30.0	0.00212	1500.0	30.0	0.00326
2000.0	30.0	0.00441	2500.0	30.0	0.00507	211.0	40.0	0.00307
300.0	40.0	0.00528	500.0	40.0	0.00207	800.0	40.0	0.00126
1100.0	40.0	0.00237	1500.0	40.0	0.00397	2000.0	40.0	0.00524
2500.0	40.0	0.00572	211.0	50.0	0.00339	300.0	50.0	0.00468
500.0	50.0	0.00263	800.0	50.0	0.00176	1100.0	50.0	0.00309
1500.0	50.0	0.00484	2000.0	50.0	0.00611	2500.0	50.0	0.00659
221.0	60.0	0.00372	300.0	60.0	0.00541	500.0	60.0	0.00283
800.0	60.0	0.00186	1100.0	60.0	0.00335	1500.0	60.0	0.00534
2000.0	60.0	0.00675	2500.0	60.0	0.00719	230.0	70.0	0.00377
300.0	70.0	0.00531	500.0	70.0	0.00333	800.0	70.0	0.00228
1100.0	70.0	0.00379	1500.0	70.0	0.00585	2000.0	70.0	0.00733
2500.0	70.0	0.00782	202.0	80.0	0.00338	300.0	80.0	0.00545
500.0	80.0	0.00317	800.0	80.0	0.00228	1100.0	80.0	0.00373
1500.0	80.0	0.00563	2000.0	80.0	0.00704	2500.0	80.0	0.00755
192.0	90.0	0.00274	300.0	90.0	0.00601	500.0	90.0	0.00409
800.0	90.0	0.00268	1100.0	90.0	0.00403	1500.0	90.0	0.00576
2000.0	90.0	0.00691	2500.0	90.0	0.00716	192.0	100.0	0.00186
300.0	100.0	0.00318	500.0	100.0	0.00207	800.0	100.0	0.00185
1100.0	100.0	0.00338	1500.0	100.0	0.00485	2000.0	100.0	0.00576
2500.0	100.0	0.00596	211.0	100.0	0.00205	300.0	110.0	0.00627
500.0	110.0	0.00413	800.0	110.0	0.00282	1100.0	110.0	0.00426
1500.0	110.0	0.00603	2000.0	110.0	0.00723	2500.0	110.0	0.00766
211.0	120.0	0.00583	300.0	120.0	0.00912	500.0	120.0	0.00596
800.0	120.0	0.00375	1100.0	120.0	0.00546	1500.0	120.0	0.00810
2000.0	120.0	0.00989	2500.0	120.0	0.01037	278.0	130.0	0.00962
300.0	130.0	0.01073	500.0	130.0	0.00700	800.0	130.0	0.00432
1100.0	130.0	0.00658	1500.0	130.0	0.00989	2000.0	130.0	0.01225
2500.0	130.0	0.01310	250.0	140.0	0.01128	300.0	140.0	0.01350
500.0	140.0	0.00604	800.0	140.0	0.00378	1100.0	140.0	0.00727
1500.0	140.0	0.01159	2000.0	140.0	0.01459	2500.0	140.0	0.01555
221.0	150.0	0.00717	300.0	150.0	0.01210	500.0	150.0	0.00794

*** ISCST BY KBN 1/90 *** 1985 TARMAC KILN 3 NOX Increase

10-23-90 ***

* 365-DAY AVERAGE CONCENTRATION (MICROGRAMS/CUBIC METER) *

* FROM ALL SOURCES *

* FOR THE DISCRETE RECEPTOR POINTS *

- RNG -	- DIR -	CON.	- RNG -	- DIR -	CON.	- RNG -	- DIR -	CON.
800.0	150.0	0.00478	1100.0	150.0	0.00797	1500.0	150.0	0.01233
2000.0	150.0	0.01577	2500.0	150.0	0.01720	326.0	160.0	0.01274
500.0	160.0	0.00543	800.0	160.0	0.00388	1100.0	160.0	0.00635
1500.0	160.0	0.00957	2000.0	160.0	0.01236	2500.0	160.0	0.01386
461.0	170.0	0.00403	500.0	170.0	0.00361	800.0	170.0	0.00360
1100.0	170.0	0.00580	1500.0	170.0	0.00844	2000.0	170.0	0.01080
2500.0	170.0	0.01206	451.0	180.0	0.00098	500.0	180.0	0.00096
800.0	180.0	0.00214	1100.0	180.0	0.00400	1500.0	180.0	0.00597
2000.0	180.0	0.00791	2500.0	180.0	0.00903	461.0	190.0	0.00102
500.0	190.0	0.00086	800.0	190.0	0.00159	1100.0	190.0	0.00343
1500.0	190.0	0.00498	2000.0	190.0	0.00609	2500.0	190.0	0.00654
470.0	200.0	0.00227	500.0	200.0	0.00205	800.0	200.0	0.00211
1100.0	200.0	0.00403	1500.0	200.0	0.00589	2000.0	200.0	0.00708
2500.0	200.0	0.00743	509.0	210.0	0.00469	800.0	210.0	0.00316
1100.0	210.0	0.00481	1500.0	210.0	0.00688	2000.0	210.0	0.00821
2500.0	210.0	0.00855	576.0	220.0	0.00956	800.0	220.0	0.00688
1100.0	220.0	0.00833	1500.0	220.0	0.01080	2000.0	220.0	0.01262
2500.0	220.0	0.01315	701.0	230.0	0.01008	800.0	230.0	0.01009
1100.0	230.0	0.01349	1500.0	230.0	0.01804	2000.0	230.0	0.02140
2500.0	230.0	0.02264	739.0	240.0	0.00803	800.0	240.0	0.00867
1100.0	240.0	0.01419	1500.0	240.0	0.02065	2000.0	240.0	0.02556
2500.0	240.0	0.02772	835.0	250.0	0.00973	1100.0	250.0	0.01521
1500.0	250.0	0.02197	2000.0	250.0	0.02682	2500.0	250.0	0.02876
1094.0	260.0	0.01460	1100.0	260.0	0.01470	1500.0	260.0	0.02063
2000.0	260.0	0.02458	2500.0	260.0	0.02593	1085.0	270.0	0.01489
1100.0	270.0	0.01520	1500.0	270.0	0.02203	2000.0	270.0	0.02681
2500.0	270.0	0.02878	1114.0	280.0	0.01719	1500.0	280.0	0.02456
2000.0	280.0	0.02970	2500.0	280.0	0.03156	1613.0	290.0	0.02727
2000.0	290.0	0.03009	2500.0	290.0	0.03099	1766.0	300.0	0.02954
2000.0	300.0	0.03106	2500.0	300.0	0.03213	1766.0	310.0	0.02994
2000.0	310.0	0.03138	2500.0	310.0	0.03217	1488.0	320.0	0.02886
1500.0	320.0	0.02906	2000.0	320.0	0.03418	2500.0	320.0	0.03515
374.0	330.0	0.01049	500.0	330.0	0.00775	800.0	330.0	0.01038
1100.0	330.0	0.01831	1500.0	330.0	0.02640	2000.0	330.0	0.03127
2500.0	330.0	0.03230	346.0	340.0	0.01252	500.0	340.0	0.00808
800.0	340.0	0.00947	1100.0	340.0	0.01596	1500.0	340.0	0.02265
2000.0	340.0	0.02667	2500.0	340.0	0.02746	336.0	350.0	0.01178
500.0	350.0	0.00684	800.0	350.0	0.00710	1100.0	350.0	0.01121

*** ISCST BY KBN 1/90 *** 1985 TARMAC KILN 3 NOX Increase

10-23-90 ***

* 365-DAY AVERAGE CONCENTRATION (MICROGRAMS/CUBIC METER) *

* FROM ALL SOURCES *

* FOR THE DISCRETE RECEPTOR POINTS *

- RNG -	- DIR -	CON.	- RNG -	- DIR -	CON.	- RNG -	- DIR -	CON.
1500.0	350.0	0.01535	2000.0	350.0	0.01785	2500.0	350.0	0.01833
326.0	360.0	0.00847	500.0	360.0	0.00375	800.0	360.0	0.00421
1100.0	360.0	0.00681	1500.0	360.0	0.00919	2000.0	360.0	0.01051
2500.0	360.0	0.01068						

ISCSTK6E MODEL, A VERSION OF
ISCST (VERSION 88348)
AN AIR QUALITY DISPERSION MODEL IN
SECTION 1. GUIDELINE MODELS.
IN UNAMAP (VERSION 6) DEC 1988.
SOURCE: FILE 6 ON UNAMAP MAGNETIC TAPE FROM NTIS.
(Based on Version 3.4 to UNAMAP, Dec 15, 1988)

CONVERTED BY :
KBN ENGINEERING AND APPLIED SCIENCES, INC.
GAINESVILLE, FLORIDA
(904)331-9000

COPYRIGHT 1990 L

CARD INPUT File is	aqslk3.i86	
SUMMARY OUTPUT File is	aqslk3.o86	
METEOROLOGICAL FILE is	miaprl86.bin	
TITLE OF RUN is	1986 TARMAC KILN 3 NOX Increase	10-23-90

NOTE THAT THE BUILDING DIMENSIONS ON CARD 6,1 FOR SOURCE NO. 3 DO NOT MEET THE SCHULMAN-SCIRE CRITERIA.
THEREFORE, DIRECTION SPECIFIC BUILDING DIMENSIONS WILL NOT BE USED BY THE MODEL.

CALCULATE (CONCENTRATION=1,DEPOSITION=2)	ISW(1) = 1
RECEPTOR GRID SYSTEM (RECTANGULAR=1 OR 3, POLAR=2 OR 4)	ISW(2) = 4
DISCRETE RECEPTOR SYSTEM (RECTANGULAR=1,POLAR=2)	ISW(3) = 2
TERRAIN ELEVATIONS ARE READ (YES=1,NO=0)	ISW(4) = 0
CALCULATIONS ARE WRITTEN TO TAPE (YES=1,NO=0)	ISW(5) = 0
LIST ALL INPUT DATA (NO=0,YES=1,MET DATA ALSO=2)	ISW(6) = 1
COMPUTE AVERAGE CONCENTRATION (OR TOTAL DEPOSITION)	
WITH THE FOLLOWING TIME PERIODS:	
HOURLY (YES=1,NO=0)	ISW(7) = 0
2-HOUR (YES=1,NO=0)	ISW(8) = 0
3-HOUR (YES=1,NO=0)	ISW(9) = 0
4-HOUR (YES=1,NO=0)	ISW(10) = 0
6-HOUR (YES=1,NO=0)	ISW(11) = 0
8-HOUR (YES=1,NO=0)	ISW(12) = 0
12-HOUR (YES=1,NO=0)	ISW(13) = 0
24-HOUR (YES=1,NO=0)	ISW(14) = 0
PRINT 'N'-DAY TABLE(S) (YES=1,NO=0)	ISW(15) = 1
PRINT THE FOLLOWING TYPES OF TABLES WHOSE TIME PERIODS ARE SPECIFIED BY ISW(7) THROUGH ISW(14):	
DAILY TABLES (YES=1,NO=0)	ISW(16) = 0
HIGHEST & SECOND HIGHEST TABLES (YES=1,NO=0)	ISW(17) = 0
MAXIMUM 50 TABLES (YES=1,NO=0)	ISW(18) = 0
METEOROLOGICAL DATA INPUT METHOD (PRE-PROCESSED=1,CARD=2)	ISW(19) = 1
RURAL-URBAN OPTION (RU.=0,UR. MODE 1=1,UR. MODE 2=2,UR. MODE 3=3)	ISW(20) = 0
WIND PROFILE EXPONENT VALUES (DEFAULTS=1,USER ENTERS=2,3)	ISW(21) = 1
VERTICAL POT. TEMP. GRADIENT VALUES (DEFAULTS=1,USER ENTERS=2,3)	ISW(22) = 1
SCALE EMISSION RATES FOR ALL SOURCES (NO=0,YES>0)	ISW(23) = 0
PROGRAM CALCULATES FINAL PLUME RISE ONLY (YES=1,NO=2)	ISW(24) = 1
PROGRAM ADJUSTS ALL STACK HEIGHTS FOR DOWNWASH (YES=2,NO=1)	ISW(25) = 2
PROGRAM USES BUOYANCY INDUCED DISPERSION (YES=1,NO=2)	ISW(26) = 1
CONCENTRATIONS DURING CALM PERIODS SET = 0 (YES=1,NO=2)	ISW(27) = 1
REG. DEFAULT OPTION CHOSEN (YES=1,NO=2)	ISW(28) = 1
TYPE OF POLLUTANT TO BE MODELLED (1=SO2,2=OTHER)	ISW(29) = 2
DEBUG OPTION CHOSEN (YES=1,NO=2)	ISW(30) = 2
ABOVE GROUND (FLAGPOLE) RECEPTORS USED (YES=1,NO=0)	ISW(31) = 0
NUMBER OF INPUT SOURCES	NSOURC = 1
NUMBER OF SOURCE GROUPS (=0,ALL SOURCES)	NGROUP = 0
TIME PERIOD INTERVAL TO BE PRINTED (=0,ALL INTERVALS)	IPERD = 0
NUMBER OF X (RANGE) GRID VALUES	NXPNTS = 4
NUMBER OF Y (THETA) GRID VALUES	NYPNTS = 36
NUMBER OF DISCRETE RECEPTORS	NXWYPT = 238
SOURCE EMISSION RATE UNITS CONVERSION FACTOR	TK = .10000E+07
HEIGHT ABOVE GROUND AT WHICH WIND SPEED WAS MEASURED	ZR = 7.01 METERS
LOGICAL UNIT NUMBER OF METEOROLOGICAL DATA	IMET = 9
DECAY COEFFICIENT FOR PHYSICAL OR CHEMICAL DEPLETION	DECAY = 0.000000E+00
SURFACE STATION NO.	ISS = 12839
YEAR OF SURFACE DATA	ISY = 86
UPPER AIR STATION NO.	IUS = 12844
YEAR OF UPPER AIR DATA	IUY = 86
ALLOCATED DATA STORAGE	LIMIT = 43500 WORDS
REQUIRED DATA STORAGE FOR THIS PROBLEM RUN	MIMIT = 1949 WORDS

*** RANGES OF POLAR GRID SYSTEM ***
(METERS)

3000.0, 3500.0, 4000.0, 4500.0,

*** RADIAL ANGLES OF POLAR GRID SYSTEM ***

(DEGREES)

10.0,	20.0,	30.0,	40.0,	50.0,	60.0,	70.0,	80.0,	90.0,	100.0,
110.0,	120.0,	130.0,	140.0,	150.0,	160.0,	170.0,	180.0,	190.0,	200.0,
210.0,	220.0,	230.0,	240.0,	250.0,	260.0,	270.0,	280.0,	290.0,	300.0,
310.0,	320.0,	330.0,	340.0,	350.0,	360.0,				

*** RANGE, THETA COORDINATES OF DISCRETE RECEPTORS ***
(METERS, DEGREES)

(336.0,	10.0),	(500.0,	10.0),	(800.0,	10.0),	(1100.0,	10.0),	(1500.0,	10.0),
(2000.0,	10.0),	(2500.0,	10.0),	(230.0,	20.0),	(300.0,	20.0),	(500.0,	20.0),
(800.0,	20.0),	(1100.0,	20.0),	(1500.0,	20.0),	(2000.0,	20.0),	(2500.0,	20.0),
(211.0,	30.0),	(300.0,	30.0),	(500.0,	30.0),	(800.0,	30.0),	(1100.0,	30.0),
(1500.0,	30.0),	(2000.0,	30.0),	(2500.0,	30.0),	(211.0,	40.0),	(300.0,	40.0),
(500.0,	40.0),	(800.0,	40.0),	(1100.0,	40.0),	(1500.0,	40.0),	(2000.0,	40.0),
(2500.0,	40.0),	(211.0,	50.0),	(300.0,	50.0),	(500.0,	50.0),	(800.0,	50.0),
(1100.0,	50.0),	(1500.0,	50.0),	(2000.0,	50.0),	(2500.0,	50.0),	(221.0,	60.0),
(300.0,	60.0),	(500.0,	60.0),	(800.0,	60.0),	(1100.0,	60.0),	(1500.0,	60.0),
(2000.0,	60.0),	(2500.0,	60.0),	(230.0,	70.0),	(300.0,	70.0),	(500.0,	70.0),
(800.0,	70.0),	(1100.0,	70.0),	(1500.0,	70.0),	(2000.0,	70.0),	(2500.0,	70.0),
(202.0,	80.0),	(300.0,	80.0),	(500.0,	80.0),	(800.0,	80.0),	(1100.0,	80.0),
(1500.0,	80.0),	(2000.0,	80.0),	(2500.0,	80.0),	(192.0,	90.0),	(300.0,	90.0),
(500.0,	90.0),	(800.0,	90.0),	(1100.0,	90.0),	(1500.0,	90.0),	(2000.0,	90.0),
(2500.0,	90.0),	(192.0,	100.0),	(300.0,	100.0),	(500.0,	100.0),	(800.0,	100.0),
(1100.0,	100.0),	(1500.0,	100.0),	(2000.0,	100.0),	(2500.0,	100.0),	(211.0,	100.0),
(300.0,	110.0),	(500.0,	110.0),	(800.0,	110.0),	(1100.0,	110.0),	(1500.0,	110.0),
(2000.0,	110.0),	(2500.0,	110.0),	(211.0,	120.0),	(300.0,	120.0),	(500.0,	120.0),
(800.0,	120.0),	(1100.0,	120.0),	(1500.0,	120.0),	(2000.0,	120.0),	(2500.0,	120.0),
(278.0,	130.0),	(300.0,	130.0),	(500.0,	130.0),	(800.0,	130.0),	(1100.0,	130.0),
(1500.0,	130.0),	(2000.0,	130.0),	(2500.0,	130.0),	(250.0,	140.0),	(300.0,	140.0),
(500.0,	140.0),	(800.0,	140.0),	(1100.0,	140.0),	(1500.0,	140.0),	(2000.0,	140.0),
(2500.0,	140.0),	(221.0,	150.0),	(300.0,	150.0),	(500.0,	150.0),	(800.0,	150.0),
(1100.0,	150.0),	(1500.0,	150.0),	(2000.0,	150.0),	(2500.0,	150.0),	(326.0,	160.0),
(500.0,	160.0),	(800.0,	160.0),	(1100.0,	160.0),	(1500.0,	160.0),	(2000.0,	160.0),
(2500.0,	160.0),	(461.0,	170.0),	(500.0,	170.0),	(800.0,	170.0),	(1100.0,	170.0),
(1500.0,	170.0),	(2000.0,	170.0),	(2500.0,	170.0),	(451.0,	180.0),	(500.0,	180.0),
(800.0,	180.0),	(1100.0,	180.0),	(1500.0,	180.0),	(2000.0,	180.0),	(2500.0,	180.0),
(461.0,	190.0),	(500.0,	190.0),	(800.0,	190.0),	(1100.0,	190.0),	(1500.0,	190.0),
(2000.0,	190.0),	(2500.0,	190.0),	(470.0,	200.0),	(500.0,	200.0),	(800.0,	200.0),
(1100.0,	200.0),	(1500.0,	200.0),	(2000.0,	200.0),	(2500.0,	200.0),	(509.0,	210.0),
(800.0,	210.0),	(1100.0,	210.0),	(1500.0,	210.0),	(2000.0,	210.0),	(2500.0,	210.0),
(576.0,	220.0),	(800.0,	220.0),	(1100.0,	220.0),	(1500.0,	220.0),	(2000.0,	220.0),
(2500.0,	220.0),	(701.0,	230.0),	(800.0,	230.0),	(1100.0,	230.0),	(1500.0,	230.0),
(2000.0,	230.0),	(2500.0,	230.0),	(739.0,	240.0),	(800.0,	240.0),	(1100.0,	240.0),
(1500.0,	240.0),	(2000.0,	240.0),	(2500.0,	240.0),	(835.0,	250.0),	(1100.0,	250.0),
(1500.0,	250.0),	(2000.0,	250.0),	(2500.0,	250.0),	(1094.0,	260.0),	(1100.0,	260.0),
(1500.0,	260.0),	(2000.0,	260.0),	(2500.0,	260.0),	(1085.0,	270.0),	(1100.0,	270.0),
(1500.0,	270.0),	(2000.0,	270.0),	(2500.0,	270.0),	(1114.0,	280.0),	(1500.0,	280.0),
(2000.0,	280.0),	(2500.0,	280.0),	(1613.0,	290.0),	(2000.0,	290.0),	(2500.0,	290.0),
(1766.0,	300.0),	(2000.0,	300.0),	(2500.0,	300.0),	(1766.0,	310.0),	(2000.0,	310.0),
(2500.0,	310.0),	(1488.0,	320.0),	(1500.0,	320.0),	(2000.0,	320.0),	(2500.0,	320.0),
(374.0,	330.0),	(500.0,	330.0),	(800.0,	330.0),	(1100.0,	330.0),	(1500.0,	330.0),
(2000.0,	330.0),	(2500.0,	330.0),	(346.0,	340.0),	(500.0,	340.0),	(800.0,	340.0),
(1100.0,	340.0),	(1500.0,	340.0),	(2000.0,	340.0),	(2500.0,	340.0),	(336.0,	350.0),
(500.0,	350.0),	(800.0,	350.0),	(1100.0,	350.0),	(1500.0,	350.0),	(2000.0,	350.0),
(2500.0,	350.0),	(326.0,	360.0),	(500.0,	360.0),	(800.0,	360.0),	(1100.0,	360.0),
(1500.0,	360.0),	(2000.0,	360.0),	(2500.0,	360.0),	(

*** SOURCE DATA ***

SOURCE NUMBER	P K E E	PART. CATS.	EMISSION RATE		X	Y	BASE ELEV.	HEIGHT	TEMP. (DEG.K); VERT.DIM TYPE=1	EXIT VEL.		BLDG. HEIGHT TYPE=0	BLDG. LENGTH TYPE=0	BLDG. WIDTH TYPE=0	
			TYPE=0,1	TYPE=2						HORZ.DIM TYPE=1,2	DIAMETER TYPE=0				
			(GRAMS/SEC)	(GRAMS/SEC)						(METERS)	(METERS)				
3	0	0	0.28200E+01		70.0	-25.2	0.0	61.00	450.00	11.04	4.57	27.40	35.10	35.10	
*	CALM HOURS (=1)	FOR DAY	1	*	0	1	1	0	0	1	0	0	0	0	0
*	CALM HOURS (=1)	FOR DAY	2	*	0	0	1	1	1	1	0	1	0	0	0
*	CALM HOURS (=1)	FOR DAY	4	*	1	0	1	1	0	0	0	0	0	0	0
*	CALM HOURS (=1)	FOR DAY	24	*	1	0	0	0	0	0	0	0	0	0	0
*	CALM HOURS (=1)	FOR DAY	29	*	0	0	1	0	0	0	0	0	0	0	0
*	CALM HOURS (=1)	FOR DAY	49	*	0	0	0	0	0	0	0	0	0	0	0
*	CALM HOURS (=1)	FOR DAY	50	*	0	0	0	0	1	0	0	0	0	0	0
*	CALM HOURS (=1)	FOR DAY	70	*	0	0	0	0	1	0	0	0	0	0	0
*	CALM HOURS (=1)	FOR DAY	93	*	0	0	1	1	0	0	0	0	0	0	0
*	CALM HOURS (=1)	FOR DAY	119	*	0	0	0	0	0	0	0	0	1	0	0
*	CALM HOURS (=1)	FOR DAY	120	*	0	0	0	1	0	0	0	0	0	0	0
*	CALM HOURS (=1)	FOR DAY	140	*	0	0	0	0	0	0	0	0	0	0	0
*	CALM HOURS (=1)	FOR DAY	143	*	0	0	0	1	0	0	0	0	0	0	0
*	CALM HOURS (=1)	FOR DAY	157	*	0	1	0	1	0	0	0	0	0	0	0
*	CALM HOURS (=1)	FOR DAY	159	*	0	0	1	0	0	0	0	0	0	0	0
*	CALM HOURS (=1)	FOR DAY	160	*	0	0	1	0	0	0	0	0	0	0	0
*	CALM HOURS (=1)	FOR DAY	162	*	0	0	1	0	0	0	0	0	0	0	0
*	CALM HOURS (=1)	FOR DAY	163	*	1	0	0	0	0	0	0	0	0	0	0
*	CALM HOURS (=1)	FOR DAY	165	*	0	0	1	0	0	0	0	0	0	0	0
*	CALM HOURS (=1)	FOR DAY	168	*	0	0	0	0	0	0	0	0	0	0	0
*	CALM HOURS (=1)	FOR DAY	172	*	0	1	0	1	1	0	0	0	0	0	0
*	CALM HOURS (=1)	FOR DAY	173	*	0	1	1	1	0	0	0	0	0	0	0
*	CALM HOURS (=1)	FOR DAY	174	*	0	0	0	0	0	0	0	0	0	0	0
*	CALM HOURS (=1)	FOR DAY	175	*	1	0	0	0	0	0	0	0	0	0	0
*	CALM HOURS (=1)	FOR DAY	176	*	0	0	1	1	0	0	0	0	0	0	0
*	CALM HOURS (=1)	FOR DAY	180	*	0	1	1	0	0	0	0	0	0	0	0
*	CALM HOURS (=1)	FOR DAY	182	*	0	0	0	0	0	0	0	0	0	0	0
*	CALM HOURS (=1)	FOR DAY	183	*	1	0	0	0	0	0	0	0	0	0	0
*	CALM HOURS (=1)	FOR DAY	184	*	0	0	0	0	0	0	0	0	0	0	0
*	CALM HOURS (=1)	FOR DAY	185	*	0	0	0	0	1	0	0	0	0	0	0
*	CALM HOURS (=1)	FOR DAY	191	*	0	0	0	1	0	0	1	0	0	0	0
*	CALM HOURS (=1)	FOR DAY	192	*	0	1	0	1	1	0	0	0	0	0	0
*	CALM HOURS (=1)	FOR DAY	197	*	0	0	0	0	1	0	0	0	0	0	0
*	CALM HOURS (=1)	FOR DAY	202	*	0	0	0	1	0	0	0	0	0	0	0
*	CALM HOURS (=1)	FOR DAY	206	*	0	0	0	0	0	1	1	0	0	0	0
*	CALM HOURS (=1)	FOR DAY	208	*	0	0	0	0	0	1	0	0	0	0	0
*	CALM HOURS (=1)	FOR DAY	209	*	1	1	0	1	1	0	0	0	0	0	0
*	CALM HOURS (=1)	FOR DAY	212	*	0	0	0	0	1	0	0	0	0	0	0
*	CALM HOURS (=1)	FOR DAY	213	*	0	0	0	1	1	0	0	0	0	0	0
*	CALM HOURS (=1)	FOR DAY	217	*	0	0	1	0	0	0	0	0	0	0	0
*	CALM HOURS (=1)	FOR DAY	223	*	0	0	1	0	0	0	0	0	0	0	0
*	CALM HOURS (=1)	FOR DAY	227	*	0	0	0	0	0	0	1	0	0	0	0
*	CALM HOURS (=1)	FOR DAY	228	*	1	1	0	0	0	0	0	0	0	0	0
*	CALM HOURS (=1)	FOR DAY	229	*	1	1	1	1	0	0	0	0	0	0	0
*	CALM HOURS (=1)	FOR DAY	239	*	0	0	0	1	0	0	0	0	0	0	0
*	CALM HOURS (=1)	FOR DAY	249	*	1	0	0	0	0	0	0	0	0	0	0
*	CALM HOURS (=1)	FOR DAY	250	*	0	0	0	0	0	0	0	0	0	0	0
*	CALM HOURS (=1)	FOR DAY	264	*	0	0	0	0	0	0	0	0	0	0	0
*	CALM HOURS (=1)	FOR DAY	266	*	0	0	0	1	0	0	0	0	0	0	0
*	CALM HOURS (=1)	FOR DAY	267	*	0	0	0	1	1	0	0	0	0	0	0

*** ISCST BY KBN 1/90 *** 1986 TARMAC KILN 3 NOX Increase

10-23-90 ***

* 365-DAY AVERAGE CONCENTRATION (MICROGRAMS/CUBIC METER) *

* FROM ALL SOURCES *
* FOR THE RECEPTOR GRID *

* MAXIMUM VALUE EQUALS 0.03787 AND OCCURRED AT (4000.0, 270.0) *

DIRECTION / RANGE (METERS)
(DEGREES) / 3000.0 3500.0 4000.0 4500.0

DIRECTION / (DEGREES) /	3000.0	3500.0	4000.0	4500.0
360.0 /	0.01219	0.01164	0.01107	0.01053
350.0 /	0.01809	0.01713	0.01614	0.01520
340.0 /	0.02560	0.02443	0.02319	0.02198
330.0 /	0.03364	0.03191	0.03006	0.02826
320.0 /	0.03345	0.03150	0.02947	0.02753
310.0 /	0.03237	0.03104	0.02961	0.02818
300.0 /	0.03294	0.03177	0.03044	0.02906
290.0 /	0.03068	0.02949	0.02820	0.02690
280.0 /	0.03555	0.03519	0.03453	0.03367
270.0 /	0.03701	0.03767	0.03787	0.03767
260.0 /	0.02985	0.03000	0.02982	0.02935
250.0 /	0.03168	0.03183	0.03161	0.03109
240.0 /	0.02395	0.02389	0.02356	0.02305
230.0 /	0.01759	0.01759	0.01740	0.01707
220.0 /	0.01178	0.01184	0.01178	0.01159
210.0 /	0.00793	0.00794	0.00786	0.00770
200.0 /	0.00604	0.00614	0.00617	0.00615
190.0 /	0.00640	0.00667	0.00687	0.00698
180.0 /	0.00820	0.00873	0.00909	0.00930
170.0 /	0.01216	0.01290	0.01341	0.01372
160.0 /	0.01438	0.01515	0.01568	0.01598
150.0 /	0.01218	0.01254	0.01274	0.01280
140.0 /	0.01156	0.01156	0.01145	0.01126
130.0 /	0.01015	0.00989	0.00956	0.00921
120.0 /	0.00902	0.00890	0.00872	0.00849
110.0 /	0.00790	0.00782	0.00767	0.00748
100.0 /	0.00609	0.00589	0.00566	0.00544
90.0 /	0.00626	0.00601	0.00575	0.00550
80.0 /	0.00557	0.00553	0.00544	0.00532
70.0 /	0.00506	0.00501	0.00492	0.00481
60.0 /	0.00567	0.00548	0.00528	0.00509
50.0 /	0.00672	0.00651	0.00628	0.00605
40.0 /	0.00618	0.00598	0.00578	0.00557
30.0 /	0.00637	0.00635	0.00630	0.00624
20.0 /	0.00673	0.00655	0.00636	0.00616
10.0 /	0.00825	0.00794	0.00761	0.00728

*** ISCST BY KBN 1/90 *** 1986 TARMAC KILN 3 NOX Increase

10-23-90 ***

* 365-DAY AVERAGE CONCENTRATION (MICROGRAMS/CUBIC METER) *

* FROM ALL SOURCES *
* FOR THE DISCRETE RECEPTOR POINTS *

- RNG -	- DIR -	CON.	- RNG -	- DIR -	CON.	- RNG -	- DIR -	CON.
336.0	10.0	0.00307	500.0	10.0	0.00135	800.0	10.0	0.00282
1100.0	10.0	0.00495	1500.0	10.0	0.00683	2000.0	10.0	0.00811
2500.0	10.0	0.00839	230.0	20.0	0.00282	300.0	20.0	0.00213
500.0	20.0	0.00106	800.0	20.0	0.00214	1100.0	20.0	0.00382
1500.0	20.0	0.00544	2000.0	20.0	0.00653	2500.0	20.0	0.00679
211.0	30.0	0.00181	300.0	30.0	0.00268	500.0	30.0	0.00101
800.0	30.0	0.00196	1100.0	30.0	0.00359	1500.0	30.0	0.00505
2000.0	30.0	0.00600	2500.0	30.0	0.00630	211.0	40.0	0.00161
300.0	40.0	0.00404	500.0	40.0	0.00271	800.0	40.0	0.00284
1100.0	40.0	0.00414	1500.0	40.0	0.00552	2000.0	40.0	0.00627
2500.0	40.0	0.00632	211.0	50.0	0.00365	300.0	50.0	0.00552
500.0	50.0	0.00253	800.0	50.0	0.00233	1100.0	50.0	0.00396
1500.0	50.0	0.00564	2000.0	50.0	0.00667	2500.0	50.0	0.00686
221.0	60.0	0.00364	300.0	60.0	0.00608	500.0	60.0	0.00206
800.0	60.0	0.00173	1100.0	60.0	0.00305	1500.0	60.0	0.00458
2000.0	60.0	0.00557	2500.0	60.0	0.00576	230.0	70.0	0.00268
300.0	70.0	0.00283	500.0	70.0	0.00132	800.0	70.0	0.00103
1100.0	70.0	0.00221	1500.0	70.0	0.00357	2000.0	70.0	0.00461
2500.0	70.0	0.00499	202.0	80.0	0.00142	300.0	80.0	0.00253
500.0	80.0	0.00147	800.0	80.0	0.00141	1100.0	80.0	0.00269
1500.0	80.0	0.00409	2000.0	80.0	0.00512	2500.0	80.0	0.00549
192.0	90.0	0.00175	300.0	90.0	0.00459	500.0	90.0	0.00282
800.0	90.0	0.00237	1100.0	90.0	0.00384	1500.0	90.0	0.00538
2000.0	90.0	0.00628	2500.0	90.0	0.00640	192.0	100.0	0.00177
300.0	100.0	0.00289	500.0	100.0	0.00155	800.0	100.0	0.00181
1100.0	100.0	0.00351	1500.0	100.0	0.00502	2000.0	100.0	0.00597
2500.0	100.0	0.00618	211.0	100.0	0.00198	300.0	110.0	0.00579
500.0	110.0	0.00358	800.0	110.0	0.00253	1100.0	110.0	0.00411
1500.0	110.0	0.00598	2000.0	110.0	0.00733	2500.0	110.0	0.00780
211.0	120.0	0.00615	300.0	120.0	0.00943	500.0	120.0	0.00560
800.0	120.0	0.00321	1100.0	120.0	0.00465	1500.0	120.0	0.00689
2000.0	120.0	0.00844	2500.0	120.0	0.00893	278.0	130.0	0.00860
300.0	130.0	0.00930	500.0	130.0	0.00599	800.0	130.0	0.00357
1100.0	130.0	0.00516	1500.0	130.0	0.00779	2000.0	130.0	0.00964
2500.0	130.0	0.01016	250.0	140.0	0.00714	300.0	140.0	0.01004
500.0	140.0	0.00620	800.0	140.0	0.00352	1100.0	140.0	0.00534
1500.0	140.0	0.00826	2000.0	140.0	0.01044	2500.0	140.0	0.01127
221.0	150.0	0.00609	300.0	150.0	0.00987	500.0	150.0	0.00515

*** ISCST BY KBN 1/90 *** 1986 TARMAC KILN 3 NOX Increase

10-23-90 ***

* 365-DAY AVERAGE CONCENTRATION (MICROGRAMS/CUBIC METER) *

* FROM ALL SOURCES *

* FOR THE DISCRETE RECEPTOR POINTS *

- RNG -	- DIR -	CON.	- RNG -	- DIR -	CON.	- RNG -	- DIR -	CON.
800.0	150.0	0.00258	1100.0	150.0	0.00472	1500.0	150.0	0.00769
2000.0	150.0	0.01022	2500.0	150.0	0.01148	326.0	160.0	0.00877
500.0	160.0	0.00406	800.0	160.0	0.00263	1100.0	160.0	0.00482
1500.0	160.0	0.00801	2000.0	160.0	0.01119	2500.0	160.0	0.01314
461.0	170.0	0.00193	500.0	170.0	0.00163	800.0	170.0	0.00134
1100.0	170.0	0.00347	1500.0	170.0	0.00632	2000.0	170.0	0.00917
2500.0	170.0	0.01098	451.0	180.0	0.00193	500.0	180.0	0.00154
800.0	180.0	0.00097	1100.0	180.0	0.00227	1500.0	180.0	0.00419
2000.0	180.0	0.00614	2500.0	180.0	0.00738	461.0	190.0	0.00126
500.0	190.0	0.00103	800.0	190.0	0.00099	1100.0	190.0	0.00228
1500.0	190.0	0.00382	2000.0	190.0	0.00519	2500.0	190.0	0.00596
470.0	200.0	0.00166	500.0	200.0	0.00148	800.0	200.0	0.00143
1100.0	200.0	0.00269	1500.0	200.0	0.00414	2000.0	200.0	0.00527
2500.0	200.0	0.00580	509.0	210.0	0.00296	800.0	210.0	0.00231
1100.0	210.0	0.00386	1500.0	210.0	0.00568	2000.0	210.0	0.00708
2500.0	210.0	0.00768	576.0	220.0	0.00493	800.0	220.0	0.00454
1100.0	220.0	0.00662	1500.0	220.0	0.00902	2000.0	220.0	0.01073
2500.0	220.0	0.01142	701.0	230.0	0.00535	800.0	230.0	0.00596
1100.0	230.0	0.00958	1500.0	230.0	0.01348	2000.0	230.0	0.01614
2500.0	230.0	0.01713	739.0	240.0	0.00657	800.0	240.0	0.00726
1100.0	240.0	0.01235	1500.0	240.0	0.01791	2000.0	240.0	0.02183
2500.0	240.0	0.02334	835.0	250.0	0.00865	1100.0	250.0	0.01466
1500.0	250.0	0.02228	2000.0	250.0	0.02812	2500.0	250.0	0.03060
1094.0	260.0	0.01328	1100.0	260.0	0.01341	1500.0	260.0	0.02076
2000.0	260.0	0.02635	2500.0	260.0	0.02881	1085.0	270.0	0.01631
1100.0	270.0	0.01668	1500.0	270.0	0.02534	2000.0	270.0	0.03208
2500.0	270.0	0.03531	1114.0	280.0	0.01872	1500.0	280.0	0.02721
2000.0	280.0	0.03308	2500.0	280.0	0.03505	1613.0	290.0	0.02721
2000.0	290.0	0.03042	2500.0	290.0	0.03125	1766.0	300.0	0.03039
2000.0	300.0	0.03223	2500.0	300.0	0.03341	1766.0	310.0	0.03072
2000.0	310.0	0.03231	2500.0	310.0	0.03308	1488.0	320.0	0.02839
1500.0	320.0	0.02860	2000.0	320.0	0.03401	2500.0	320.0	0.03467
374.0	330.0	0.00747	500.0	330.0	0.00583	800.0	330.0	0.00975
1100.0	330.0	0.01921	1500.0	330.0	0.02855	2000.0	330.0	0.03388
2500.0	330.0	0.03463	346.0	340.0	0.00851	500.0	340.0	0.00449
800.0	340.0	0.00716	1100.0	340.0	0.01464	1500.0	340.0	0.02162
2000.0	340.0	0.02559	2500.0	340.0	0.02624	336.0	350.0	0.00437
500.0	350.0	0.00233	800.0	350.0	0.00532	1100.0	350.0	0.01080

*** ISCST BY KBN 1/90 *** 1986 TARMAC KILN 3 NOX Increase

10-23-90 ***

* 365-DAY AVERAGE CONCENTRATION (MICROGRAMS/CUBIC METER) *

* FROM ALL SOURCES *

* FOR THE DISCRETE RECEPTOR POINTS *

RNG -	- DIR -	CON.	- RNG -	- DIR -	CON.	- RNG -	- DIR -	CON.
1500.0	350.0	0.01564	2000.0	350.0	0.01836	2500.0	350.0	0.01869
326.0	360.0	0.00304	500.0	360.0	0.00191	800.0	360.0	0.00432
1100.0	360.0	0.00774	1500.0	360.0	0.01061	2000.0	360.0	0.01229
2500.0	360.0	0.01252						

ISCSTK6E MODEL, A VERSION OF
ISCST (VERSION 88348)
AN AIR QUALITY DISPERSION MODEL IN
SECTION 1. GUIDELINE MODELS.
IN UNAMAP (VERSION 6) DEC 1988.
SOURCE: FILE 6 ON UNAMAP MAGNETIC TAPE FROM NTIS.
(Based on Version 3.4 to UNAMAP, Dec 15, 1988)

CONVERTED BY :
KBN ENGINEERING AND APPLIED SCIENCES, INC.
GAINESVILLE, FLORIDA
(904)331-9000

COPYRIGHT 1990

CARD INPUT File is aqlk3rf.i82
SUMMARY OUTPUT File is aqlk3rf.o82
METEOROLOGICAL FILE is g:\miapre82.bin
TITLE OF RUN is 1982 TARMAC KILN 3 NOX Increase Refined Anal. 10-23-90

NOTE THAT THE BUILDING DIMENSIONS ON CARD 6,1 FOR SOURCE NO. 3 DO NOT MEET THE SCHULMAN-SCIRE CRITERIA.
THEREFORE, DIRECTION SPECIFIC BUILDING DIMENSIONS WILL NOT BE USED BY THE MODEL.

CALCULATE (CONCENTRATION=1,DEPOSITION=2)	ISW(1) = 1
RECEPTOR GRID SYSTEM (RECTANGULAR=1 OR 3, POLAR=2 OR 4)	ISW(2) = 4
DISCRETE RECEPTOR SYSTEM (RECTANGULAR=1,POLAR=2)	ISW(3) = 2
TERRAIN ELEVATIONS ARE READ (YES=1,NO=0)	ISW(4) = 0
CALCULATIONS ARE WRITTEN TO TAPE (YES=1,NO=0)	ISW(5) = 0
LIST ALL INPUT DATA (NO=0,YES=1,MET DATA ALSO=2)	ISW(6) = 1
COMPUTE AVERAGE CONCENTRATION (OR TOTAL DEPOSITION)	
WITH THE FOLLOWING TIME PERIODS:	
HOURLY (YES=1,NO=0)	ISW(7) = 0
2-HOUR (YES=1,NO=0)	ISW(8) = 0
3-HOUR (YES=1,NO=0)	ISW(9) = 0
4-HOUR (YES=1,NO=0)	ISW(10) = 0
6-HOUR (YES=1,NO=0)	ISW(11) = 0
8-HOUR (YES=1,NO=0)	ISW(12) = 0
12-HOUR (YES=1,NO=0)	ISW(13) = 0
24-HOUR (YES=1,NO=0)	ISW(14) = 0
PRINT 'N'-DAY TABLE(S) (YES=1,NO=0)	ISW(15) = 1
PRINT THE FOLLOWING TYPES OF TABLES WHOSE TIME PERIODS ARE SPECIFIED BY ISW(7) THROUGH ISW(14):	
DAILY TABLES (YES=1,NO=0)	ISW(16) = 0
HIGHEST & SECOND HIGHEST TABLES (YES=1,NO=0)	ISW(17) = 0
MAXIMUM 50 TABLES (YES=1,NO=0)	ISW(18) = 0
METEOROLOGICAL DATA INPUT METHOD (PRE-PROCESSED=1,CARD=2)	ISW(19) = 1
RURAL-URBAN OPTION (RU.=0,UR. MODE 1=1,UR. MODE 2=2,UR. MODE 3=3)	ISW(20) = 0
WIND PROFILE EXPONENT VALUES (DEFAULTS=1,USER ENTERS=2,3)	ISW(21) = 1
VERTICAL POT. TEMP. GRADIENT VALUES (DEFAULTS=1,USER ENTERS=2,3)	ISW(22) = 1
SCALE EMISSION RATES FOR ALL SOURCES (NO=0,YES>0)	ISW(23) = 0
PROGRAM CALCULATES FINAL PLUME RISE ONLY (YES=1,NO=2)	ISW(24) = 1
PROGRAM ADJUSTS ALL STACK HEIGHTS FOR DOWNWASH (YES=2,NO=1)	ISW(25) = 2
PROGRAM USES BUOYANCY INDUCED DISPERSION (YES=1,NO=2)	ISW(26) = 1
CONCENTRATIONS DURING CALM PERIODS SET = 0 (YES=1,NO=2)	ISW(27) = 1
REG. DEFAULT OPTION CHOSEN (YES=1,NO=2)	ISW(28) = 1
TYPE OF POLLUTANT TO BE MODELLED (1=SO2,2=OTHER)	ISW(29) = 2
DEBUG OPTION CHOSEN (YES=1,NO=2)	ISW(30) = 2
ABOVE GROUND (FLAGPOLE) RECEPTORS USED (YES=1,NO=0)	ISW(31) = 0
NUMBER OF INPUT SOURCES	NSOURC = 1
NUMBER OF SOURCE GROUPS (=0,ALL SOURCES)	NGROUP = 0
TIME PERIOD INTERVAL TO BE PRINTED (=0,ALL INTERVALS)	IPERD = 0
NUMBER OF X (RANGE) GRID VALUES	NXPNTS = 9
NUMBER OF Y (THETA) GRID VALUES	NYPNTS = 1
NUMBER OF DISCRETE RECEPTORS	NXWYPT = 0
SOURCE EMISSION RATE UNITS CONVERSION FACTOR	TK = .10000E+07
HEIGHT ABOVE GROUND AT WHICH WIND SPEED WAS MEASURED	ZR = 7.01 METERS
LOGICAL UNIT NUMBER OF METEOROLOGICAL DATA	IMET = 9
DECAY COEFFICIENT FOR PHYSICAL OR CHEMICAL DEPLETION	DECAY = 0.000000E+00
SURFACE STATION NO.	ISS = 12839
YEAR OF SURFACE DATA	ISY = 82
UPPER AIR STATION NO.	IUS = 12844
YEAR OF UPPER AIR DATA	IUY = 82
ALLOCATED DATA STORAGE	LIMIT = 43500 WORDS
REQUIRED DATA STORAGE FOR THIS PROBLEM RUN	MIMIT = 324 WORDS

*** RANGES OF POLAR GRID SYSTEM ***
(METERS)

2100.0, 2200.0, 2300.0, 2400.0, 2500.0, 2600.0, 2700.0, 2800.0, 2900.0,

*** RADIAL ANGLES OF POLAR GRID SYSTEM ***

(DEGREES)

320.0,

*** SOURCE DATA ***

SOURCE NUMBER	PK E	PART. CATS.	EMISSION RATE		X	Y	BASE ELEV.	HEIGHT	TEMP.	EXIT VEL.		BLDG. HEIGHT	BLDG. LENGTH	BLDG. WIDTH
			TYPE=0,1 (GRAMS/SEC)	TYPE=2 (GRAMS/SEC)					(DEG.K);	(M/SEC);				
NUMBER	EE		*PER METER**2	**2	(METERS)	(METERS)	(METERS)	(METERS)	TYPE=1	TYPE=1,2	TYPE=0	TYPE=0	TYPE=0	TYPE=0
3	0	0	0.28200E+01		70.0	-25.2	0.0	61.00	450.00	11.04	4.57	27.40	35.10	35.10
* CALM HOURS (=1) FOR DAY	1	*	0	0	0	0	0	0	0	0	0	0	0	0
* CALM HOURS (=1) FOR DAY	2	*	0	0	0	0	0	0	0	0	0	0	0	0
* CALM HOURS (=1) FOR DAY	7	*	0	0	1	1	0	0	0	0	0	0	0	0
* CALM HOURS (=1) FOR DAY	8	*	0	0	0	1	0	0	0	0	0	0	0	0
* CALM HOURS (=1) FOR DAY	16	*	0	0	0	0	0	0	0	0	0	0	0	0
* CALM HOURS (=1) FOR DAY	17	*	0	0	0	0	0	0	0	0	0	0	0	0
* CALM HOURS (=1) FOR DAY	18	*	1	0	0	0	0	0	1	1	0	0	0	0
* CALM HOURS (=1) FOR DAY	19	*	1	0	1	1	0	0	0	0	0	0	0	0
* CALM HOURS (=1) FOR DAY	20	*	0	1	1	1	0	0	0	0	0	0	0	0
* CALM HOURS (=1) FOR DAY	21	*	0	0	0	0	0	1	0	1	1	0	0	0
* CALM HOURS (=1) FOR DAY	24	*	0	0	1	0	0	0	0	0	0	0	0	0
* CALM HOURS (=1) FOR DAY	37	*	0	0	0	0	0	0	0	0	0	0	0	0
* CALM HOURS (=1) FOR DAY	38	*	1	0	0	0	0	0	0	0	0	0	0	0
* CALM HOURS (=1) FOR DAY	42	*	1	1	0	0	1	0	0	0	0	0	0	0
* CALM HOURS (=1) FOR DAY	48	*	0	0	0	0	0	0	0	0	0	0	0	0
* CALM HOURS (=1) FOR DAY	56	*	0	0	1	1	0	0	0	0	0	0	0	0
* CALM HOURS (=1) FOR DAY	57	*	1	0	0	0	0	0	0	0	0	0	0	0
* CALM HOURS (=1) FOR DAY	59	*	0	0	0	0	0	0	1	0	0	0	0	0
* CALM HOURS (=1) FOR DAY	62	*	0	0	0	1	0	0	0	0	0	0	0	0
* CALM HOURS (=1) FOR DAY	70	*	0	0	1	0	0	0	0	0	0	0	0	0
* CALM HOURS (=1) FOR DAY	71	*	0	0	0	0	0	0	1	0	0	0	0	0
* CALM HOURS (=1) FOR DAY	72	*	0	0	0	1	0	1	0	0	0	0	0	0
* CALM HOURS (=1) FOR DAY	73	*	0	0	0	0	0	0	1	0	0	0	0	0
* CALM HOURS (=1) FOR DAY	77	*	1	0	0	0	0	0	0	0	0	0	0	0
* CALM HOURS (=1) FOR DAY	79	*	0	1	0	0	0	1	0	0	0	0	0	0
* CALM HOURS (=1) FOR DAY	80	*	0	0	0	1	0	1	1	0	0	0	0	0
* CALM HOURS (=1) FOR DAY	81	*	1	0	0	1	0	0	0	0	0	0	0	0
* CALM HOURS (=1) FOR DAY	82	*	1	1	0	0	0	1	1	0	0	0	0	0
* CALM HOURS (=1) FOR DAY	83	*	1	0	0	0	1	1	0	0	0	0	0	0
* CALM HOURS (=1) FOR DAY	84	*	0	0	0	0	0	1	0	0	0	0	0	0
* CALM HOURS (=1) FOR DAY	91	*	0	0	1	0	0	0	0	0	0	0	0	0
* CALM HOURS (=1) FOR DAY	100	*	0	0	0	1	0	0	0	0	0	0	0	0
* CALM HOURS (=1) FOR DAY	105	*	0	0	0	0	0	1	0	0	0	0	0	0
* CALM HOURS (=1) FOR DAY	108	*	0	0	0	0	0	0	0	0	0	0	0	0
* CALM HOURS (=1) FOR DAY	109	*	1	1	1	1	0	1	1	0	0	0	0	0
* CALM HOURS (=1) FOR DAY	113	*	1	0	0	0	1	0	0	0	0	0	0	0
* CALM HOURS (=1) FOR DAY	128	*	0	0	0	0	0	1	0	0	0	0	0	0
* CALM HOURS (=1) FOR DAY	129	*	0	0	0	1	0	1	1	0	0	0	0	0
* CALM HOURS (=1) FOR DAY	140	*	0	0	0	1	0	0	0	0	0	0	0	0
* CALM HOURS (=1) FOR DAY	142	*	0	0	0	0	0	1	0	0	0	0	0	0
* CALM HOURS (=1) FOR DAY	143	*	0	0	0	0	0	1	0	0	0	0	0	0
* CALM HOURS (=1) FOR DAY	148	*	0	0	0	0	0	1	0	0	0	0	0	0
* CALM HOURS (=1) FOR DAY	152	*	0	0	0	0	0	0	0	0	0	0	0	0
* CALM HOURS (=1) FOR DAY	154	*	0	0	0	1	0	0	0	0	0	0	0	0
* CALM HOURS (=1) FOR DAY	158	*	0	0	1	0	1	1	0	0	0	0	0	0
* CALM HOURS (=1) FOR DAY	159	*	0	0	0	0	1	0	0	0	0	0	0	0
* CALM HOURS (=1) FOR DAY	160	*	0	0	0	0	1	0	0	0	0	0	0	0
* CALM HOURS (=1) FOR DAY	161	*	0	0	0	0	0	1	1	0	0	0	0	0
* CALM HOURS (=1) FOR DAY	164	*	0	0	1	0	1	1	0	0	0	0	0	0
* CALM HOURS (=1) FOR DAY	165	*	1	1	1	0	0	1	0	0	0	0	0	0

CALM HOURS (=1) FOR DAY 321 * 0 0 1 1 0 0 1 0 0 0 0 0 0 0 0 0 0 0 0 0 0 0 0 0
* CALM HOURS (=1) FOR DAY 322 * 0 0 0 0 0 0 1 0 0 0 0 0 0 0 0 0 0 0 0 0 0 0 0 0
* CALM HOURS (=1) FOR DAY 324 * 0 0 0 0 0 0 1 0 0 0 0 0 0 0 0 0 0 0 0 0 0 0 0 0
CALM HOURS (=1) FOR DAY 340 * 0 1 1 1 1
CALM HOURS (=1) FOR DAY 343 * 0 0 0 1 0
* CALM HOURS (=1) FOR DAY 355 * 0 0 0 0 0 0 1 1 0 0 0 0 0 0 0 0 0 0 0 0 0 0 1 0
* CALM HOURS (=1) FOR DAY 356 * 0 0 1 0
CALM HOURS (=1) FOR DAY 363 * 0 0 0 0 0 1 0 0 0 0 0 0 0 0 0 0 0 0 0 0 0 0 0 0
CALM HOURS (=1) FOR DAY 364 * 0 0 0 0 0 0 1 1 0 0 0 0 0 0 0 0 0 0 0 0 0 0 0 0
* CALM HOURS (=1) FOR DAY 365 * 0 0 0 0 1 0 0 0 0 0 0 0 0 0 0 0 0 0 0 0 0 0 0 0

*** ISCST BY KBN 1/90 *** 1982 TARMAC KILN 3 NOX Increase Refined Anal. 10-23-90 ***

* 365-DAY AVERAGE CONCENTRATION (MICROGRAMS/CUBIC METER) *

* FROM ALL SOURCES *
* FOR THE RECEPTOR GRID *

* MAXIMUM VALUE EQUALS 0.05422 AND OCCURRED AT (2200.0, 320.0) *

DIRECTION / (DEGREES) /	RANGE (METERS)								
	2100.0	2200.0	2300.0	2400.0	2500.0	2600.0	2700.0	2800.0	2900.0
-----	-----	-----	-----	-----	-----	-----	-----	-----	-----
320.0 /	0.05412	0.05422	0.05419	0.05402	0.05373	0.05333	0.05285	0.05231	0.05173

*** RUN TIME STATISTICS ***

BEGINNING HOUR,MINUTE,SECOND - - - - - : 13:37:38
BEGINNING MONTH,DAY,YEAR - - - - - : 10-24-1990

ENDING HOUR,MINUTE,SECOND - - - - - : 13:38:47
ENDING MONTH,DAY,YEAR - - - - - : 10-24-1990

TOTAL CPU SECONDS - - - - - : 69.

ISCSTK6E MODEL, A VERSION OF
ISCST (VERSION 88348)
AN AIR QUALITY DISPERSION MODEL IN
SECTION 1. GUIDELINE MODELS.
IN UNAMAP (VERSION 6) DEC 1988.
SOURCE: FILE 6 ON UNAMAP MAGNETIC TAPE FROM NTIS.
(Based on Version 3.4 to UNAMAP, Dec 15, 1988)

CONVERTED BY :
KBN ENGINEERING AND APPLIED SCIENCES, INC.
GAINESVILLE, FLORIDA
(904)331-9000

COPYRIGHT 1990

CARD INPUT File is aqslk3rf.i83
SUMMARY OUTPUT File is aqslk3rf.o83
METEOROLOGICAL FILE is g:\miapre83.bin
TITLE OF RUN is 1983 TARMAC KILN 3 NOX Increase Refined Anal. 10-23-90

NOTE THAT THE BUILDING DIMENSIONS ON CARD 6,1 FOR SOURCE NO. 3 DO NOT MEET THE SCHULMAN-SCIRE CRITERIA.
THEREFORE, DIRECTION SPECIFIC BUILDING DIMENSIONS WILL NOT BE USED BY THE MODEL.

CALCULATE (CONCENTRATION=1,DEPOSITION=2)	ISW(1) = 1
RECEPTOR GRID SYSTEM (RECTANGULAR=1 OR 3, POLAR=2 OR 4)	ISW(2) = 4
DISCRETE RECEPTOR SYSTEM (RECTANGULAR=1,POLAR=2)	ISW(3) = 2
TERRAIN ELEVATIONS ARE READ (YES=1,NO=0)	ISW(4) = 0
CALCULATIONS ARE WRITTEN TO TAPE (YES=1,NO=0)	ISW(5) = 0
LIST ALL INPUT DATA (NO=0,YES=1,MET DATA ALSO=2)	ISW(6) = 1
COMPUTE AVERAGE CONCENTRATION (OR TOTAL DEPOSITION)	
WITH THE FOLLOWING TIME PERIODS:	
HOURLY (YES=1,NO=0)	ISW(7) = 0
2-HOUR (YES=1,NO=0)	ISW(8) = 0
3-HOUR (YES=1,NO=0)	ISW(9) = 0
4-HOUR (YES=1,NO=0)	ISW(10) = 0
6-HOUR (YES=1,NO=0)	ISW(11) = 0
8-HOUR (YES=1,NO=0)	ISW(12) = 0
12-HOUR (YES=1,NO=0)	ISW(13) = 0
24-HOUR (YES=1,NO=0)	ISW(14) = 0
PRINT 'N'-DAY TABLE(S) (YES=1,NO=0)	ISW(15) = 1
PRINT THE FOLLOWING TYPES OF TABLES WHOSE TIME PERIODS ARE	
SPECIFIED BY ISW(7) THROUGH ISW(14):	
DAILY TABLES (YES=1,NO=0)	ISW(16) = 0
HIGHEST & SECOND HIGHEST TABLES (YES=1,NO=0)	ISW(17) = 0
MAXIMUM 50 TABLES (YES=1,NO=0)	ISW(18) = 0
METEOROLOGICAL DATA INPUT METHOD (PRE-PROCESSED=1,CARD=2)	ISW(19) = 1
RURAL-URBAN OPTION (RU.=0,UR. MODE 1=1,UR. MODE 2=2,UR. MODE 3=3)	ISW(20) = 0
WIND PROFILE EXPONENT VALUES (DEFAULTS=1,USER ENTERS=2,3)	ISW(21) = 1
VERTICAL POT. TEMP. GRADIENT VALUES (DEFAULTS=1,USER ENTERS=2,3)	ISW(22) = 1
SCALE EMISSION RATES FOR ALL SOURCES (NO=0,YES>0)	ISW(23) = 0
PROGRAM CALCULATES FINAL PLUME RISE ONLY (YES=1,NO=2)	ISW(24) = 1
PROGRAM ADJUSTS ALL STACK HEIGHTS FOR DOWNWASH (YES=2,NO=1)	ISW(25) = 2
PROGRAM USES BUOYANCY INDUCED DISPERSION (YES=1,NO=2)	ISW(26) = 1
CONCENTRATIONS DURING CALM PERIODS SET = 0 (YES=1,NO=2)	ISW(27) = 1
REG. DEFAULT OPTION CHOSEN (YES=1,NO=2)	ISW(28) = 1
TYPE OF POLLUTANT TO BE MODELLED (1=SO2,2=OTHER)	ISW(29) = 2
DEBUG OPTION CHOSEN (YES=1,NO=2)	ISW(30) = 2
ABOVE GROUND (FLAGPOLE) RECEPTORS USED (YES=1,NO=0)	ISW(31) = 0
NUMBER OF INPUT SOURCES	NSOURC = 1
NUMBER OF SOURCE GROUPS (=0,ALL SOURCES)	NGROUP = 0
TIME PERIOD INTERVAL TO BE PRINTED (=0,ALL INTERVALS)	IPERD = 0
NUMBER OF X (RANGE) GRID VALUES	NXPNTS = 9
NUMBER OF Y (THETA) GRID VALUES	NYPNTS = 1
NUMBER OF DISCRETE RECEPTORS	NXWYPT = 0
SOURCE EMISSION RATE UNITS CONVERSION FACTOR	TK = .10000E+07
HEIGHT ABOVE GROUND AT WHICH WIND SPEED WAS MEASURED	ZR = 7.01 METERS
LOGICAL UNIT NUMBER OF METEOROLOGICAL DATA	IMET = 9
DECAY COEFFICIENT FOR PHYSICAL OR CHEMICAL DEPLETION	DECAY = 0.000000E+00
SURFACE STATION NO.	ISS = 12839
YEAR OF SURFACE DATA	ISY = 83
UPPER AIR STATION NO.	IUS = 12844
YEAR OF UPPER AIR DATA	IUY = 83
ALLOCATED DATA STORAGE	LIMIT = 43500 WORDS
REQUIRED DATA STORAGE FOR THIS PROBLEM RUN	MIMIT = 324 WORDS

*** ISCST BY KBN 1/90 *** 1983 TARMAC KILN 3 NOX Increase Refined Anal. 10-23-90 ***

*** RANGES OF POLAR GRID SYSTEM ***
(METERS)

1600.0, 1700.0, 1800.0, 1900.0, 2000.0, 2100.0, 2200.0, 2300.0, 2400.0,

*** RADIAL ANGLES OF POLAR GRID SYSTEM ***
(DEGREES)

300.0,

*** SOURCE DATA ***

SOURCE NUMBER	P K E E	PART. CATS.	EMISSION RATE		X	Y	BASE ELEV.	HEIGHT	TEMP.	EXIT VEL.		BLDG. HEIGHT	BLDG. LENGTH	BLDG. WIDTH
			(GRAMS/SEC)	TYPE=2					(DEG.K);	(M/SEC);	TYPE=0			
NUMBER			PER METER**2	(GRAMS/SEC)	(METERS)	(METERS)	(METERS)	(METERS)	TYPE=1	TYPE=1,2	TYPE=0	TYPE=0	TYPE=0	TYPE=0
3	0	0	0.28200E+01		70.0	-25.2	0.0	61.00	450.00	11.04	4.57	27.40	35.10	35.10
*				5	0	0	0	0	0	0	0	0	0	0
*				7	0	0	0	0	0	0	0	0	0	0
*				8	0	0	0	0	0	0	0	0	0	0
*				9	0	0	0	1	0	0	0	0	0	0
*				10	0	1	0	0	0	0	0	0	0	0
*				11	1	1	1	0	1	1	1	0	0	0
*				21	0	0	0	0	0	0	0	0	0	0
*				22	0	1	1	0	0	0	0	0	0	0
*				27	0	0	0	1	1	0	0	0	0	0
*				29	0	0	0	0	0	0	0	0	0	0
*				30	1	1	1	0	0	0	0	0	0	0
*				31	1	0	0	0	1	1	1	0	0	0
*				46	0	0	0	0	0	0	0	0	0	0
*				55	0	0	0	1	1	1	0	0	0	0
*				62	0	0	0	1	1	0	0	0	0	0
*				72	0	0	0	0	0	1	1	0	0	0
*				73	0	0	1	1	0	1	1	1	0	0
*				79	0	1	1	0	1	0	0	0	0	0
*				89	0	0	0	0	0	0	0	0	0	0
*				90	0	0	0	0	0	0	0	0	0	0
*				94	0	0	0	0	0	0	0	0	0	0
*				100	0	0	0	0	0	0	0	0	0	0
*				111	0	0	0	0	0	0	0	0	0	0
*				112	0	1	1	0	0	0	0	0	0	0
*				122	0	1	0	1	1	0	0	0	0	0
*				144	1	0	1	0	0	0	0	0	0	0
*				145	0	0	0	0	0	0	0	0	0	0
*				146	0	0	0	0	0	0	0	0	0	0
*				147	0	0	0	0	0	0	0	0	0	0
*				148	1	1	0	1	0	0	0	0	0	0
*				150	0	0	0	0	0	0	0	0	0	0
*				154	0	0	0	0	0	0	0	0	0	0
*				156	0	0	0	0	0	0	0	0	0	0
*				159	0	0	0	0	0	0	0	0	0	0
*				161	0	0	1	1	1	1	0	0	0	0
*				165	0	0	0	0	1	0	0	0	0	0
*				174	0	0	0	0	1	1	1	0	0	0
*				176	0	0	0	1	0	0	0	0	0	0
*				180	0	0	0	0	0	0	0	0	0	0
*				190	0	0	0	0	0	0	0	0	0	0
*				191	0	0	0	0	0	0	0	0	0	0
*				197	0	0	1	0	0	0	0	0	0	0
*				198	0	0	0	0	1	0	0	0	0	0
*				199	0	0	0	0	0	0	0	0	0	0
*				200	0	0	0	1	1	0	1	0	0	0
*				201	0	0	0	0	0	1	0	0	0	0
*				204	0	0	0	0	0	0	0	0	0	0
*				207	0	0	0	0	0	1	1	0	0	0
*				208	0	0	0	0	0	0	0	0	0	0
*				209	0	0	0	0	0	1	0	0	0	0

* CALM HOURS (=1) FOR DAY 334 * 0 0 0 0 1 1 0 0 0 1 0 0 0 0 0 0 0 0 0 0 0 0 0 0 0
 * CALM HOURS (=1) FOR DAY 335 * 0 0 0 0 1 0 1 0 0 0 0 0 0 0 0 0 0 0 0 0 0 0 0 0 0
 * CALM HOURS (=1) FOR DAY 336 * 0 0 0 1 0
 * CALM HOURS (=1) FOR DAY 338 * 0 1 1 1 1 0 0 0 0 0 0 0 0 0 0 0 0 0 0 0 0 0 1 1 1
 * CALM HOURS (=1) FOR DAY 339 * 1 1 0 0 1 1 0 1 1 0 0 0 0 0 0 0 0 0 0 0 0 0 0 0 0
 * CALM HOURS (=1) FOR DAY 345 * 0 0 0 0 1 0
 * CALM HOURS (=1) FOR DAY 347 * 0 0 0 0 0 0 1 1 0 1 0 0 0 0 0 0 0 0 0 0 0 0 0 0 0
 * CALM HOURS (=1) FOR DAY 348 * 1 0 0 1 0 0 1 1 0 0 0 0 0 0 0 0 0 0 0 0 0 0 0 0 0
 * CALM HOURS (=1) FOR DAY 352 * 0 0 0 0 1 0 0 0 0 0 0 0 0 0 0 0 0 0 0 0 0 0 1 1 0 1 0
 * CALM HOURS (=1) FOR DAY 353 * 0 1
 * CALM HOURS (=1) FOR DAY 354 * 0 0 0 1 1 0 0 0 0 0 0 0 0 0 0 0 0 0 0 1 1 0 0 0 0 0
 * CALM HOURS (=1) FOR DAY 355 * 0 0 0 0 0 1 0
 * CALM HOURS (=1) FOR DAY 356 * 0 0 0 0 1 0 1 1 0 0 0 0 0 0 0 0 0 0 0 0 0 0 0 0 0 0
 * CALM HOURS (=1) FOR DAY 357 * 0 0 0 1 1 1 0 1 0 0 0 0 0 0 0 0 0 0 0 0 0 0 0 0 0 0
 * CALM HOURS (=1) FOR DAY 358 * 1 0
 * CALM HOURS (=1) FOR DAY 361 * 0 1 0 0 0 0
 * CALM HOURS (=1) FOR DAY 363 * 0 1
 * CALM HOURS (=1) FOR DAY 364 * 1 0

*** ISCST BY KBN 1/90 *** 1983 TARMAC KILN 3 NOX Increase Refined Anal. 10-23-90 ***

* 365-DAY AVERAGE CONCENTRATION (MICROGRAMS/CUBIC METER) *

* FROM ALL SOURCES *
* FOR THE RECEPTOR GRID *

* MAXIMUM VALUE EQUALS 0.05595 AND OCCURRED AT (2100.0, 300.0) *

DIRECTION / (DEGREES) /	1600.0	1700.0	1800.0	1900.0	2000.0	2100.0	2200.0	2300.0	2400.0
300.0 /	0.05196	0.05350	0.05462	0.05536	0.05578	0.05595	0.05587	0.05562	0.05526