

February 21, 1984

**DER**

FEB 24 1984

**BAQM**

State of Florida  
Department of Environmental Regulation  
Bureau of Air Quality Management  
2600 Blair Stone Road  
Tallahassee, Florida 32301

Attention: Mr. C.H. Fancy, P.E.  
Deputy Chief

Re: Broward County, Florida Resource  
Recovery Project/Prevention of  
Significant Deterioration Permit Applications

Gentlemen:

On behalf of the Broward County Board of County Commissioners, please find enclosed Prevention of Significant Deterioration (PSD) permit applications for the two resource recovery facility components of the subject project. We would like to acknowledge the efforts of Environmental Science and Engineering, Inc. in preparing Appendix C of the enclosed under subcontract to Malcolm Pirnie, Inc.

As noted in prior discussions and correspondence, each of the two resource recovery facilities (i.e., the northern or Copans Road facility and the southern or Route 441 facility) will utilize mass-burn technology. The mass burning with energy recovery technology represents the state of the art for solid waste disposal, and it has been proven through years of successful operation to be a demonstrated, reliable method of disposal. It is a mature technology with more than 350 plants worldwide, processing over 110,000 tons of refuse per day. The first modern mass burning system was built nearly 30 years ago in Berne, Switzerland, and is still operating successfully today.

As you are aware, Broward County is utilizing the full-service approach for implementation of the subject project. As a result, the enclosed applications are based on preliminary or conceptual design performed to date, and may

therefore be subject to certain refinement following selection of a full-service vendor which is scheduled to occur in March or April, 1984. Because this conceptual design is based on conservative assumptions from a potential air quality impact viewpoint, we are confident that once a vendor is selected and this conceptual design is refined the predicted impact levels will be no more significant than those presented in the enclosed applications.

Broward County has received, and is currently reviewing, proposals submitted by two pre-qualified full-service vendors (Waste Management, Inc./Bechtel Civil and Minerals, Inc. and Signal RESCO, Inc.). Thus, in addition to the technical specifications contained in the County's Request for Proposals and imposed as minimum project requirements, we have also enclosed certain relevant information and data from these vendor proposals. Because final detailed facility design to be performed by the selected vendor must be consistent with the minimum project technical requirements as specified, we feel the predicted air quality impacts presented in the enclosed applications represent conservative projections regardless of which vendor is ultimately selected to enter into a long-term, full-service agreement with Broward County.

Your cooperation and assistance to Broward County on the timely implementation of an environmentally and economically sound program of municipal solid waste management is greatly appreciated. We look forward to working with you during your agency's review of these applications in order to meet the accelerated project schedule necessary to resolve the County's current municipal solid waste disposal situation. Should you have any questions or require clarification on the enclosed applications, please contact us at your convenience.

Very truly yours,

MALCOLM PIRNIE, INC.

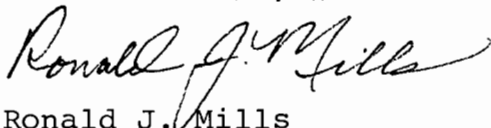

Ronald J. Mills

RJM:hkh

enclosures

cc: P. Korab/Broward County  
G. Carlson/Broward County EQCB  
L. George/Florida DER  
T. Tittle/Florida DER  
R. McCann/Env. Science and Engineering, Inc.

STATE OF FLORIDA DER - APPLICATION TO OPERATE/CONSTRUCT  
AIR POLLUTION SOURCES

TABLE OF CONTENTS

1. Application Form - DER Form 17-1:202(1)
2. Attachment No. 1 - Section I. Statements by Applicant and Engineer
3. Attachment No. 2 - Section V. Supplemental Requirements
4. Attachment No. 3 - Section VII. Prevention of Significant Deterioration
5. Appendix A - Project Description
6. Appendix B - Technical Specifications
7. Appendix C - Technical Support Document for the Prevention of Significant Deterioration (PSD) Permits
8. Appendix D - Typical Air Pollution Control System Details -  
For Waste Management, Inc.-Bechtel Civil &  
Minerals, Inc. Vendor
9. Appendix E - Letter Regarding Ambient Air Quality Monitoring
10. Appendix F - Waste Composition and Type

DEPARTMENT OF ENVIRONMENTAL REGULATION

RULE NO. 17-2.660

RULE TITLE: New Source Performance Standards

PURPOSE AND EFFECT: The proposed amendments adopt by reference the federal New Source Performance Standards (NSPS) for the following categories of sources: publication rotogravure printing, synthetic organic chemical manufacturing equipment, and bulk gasoline terminals.

SUMMARY: The proposed amendments add to the list of federal NSPS already incorporated into Chapter 17-2 by reference.

RULEMAKING AUTHORITY: 403.061, F.S.

LAW IMPLEMENTED: 403.031, 403.061, 403.087, F.S.

SUMMARY OF THE ESTIMATE OF ECONOMIC IMPACT: The sources subject to the NSPS provisions proposed for adoption by reference are already permitted by the Department and, therefore, the proposed amendments will not add to the expenses of source owners.

Instead, the amendment will eliminate the costs now associated with duplicative state and federal permitting. The proposed amendments will have no impact on competition.

THE DEPARTMENT PROPOSES TO ADOPT THESE AMENDMENTS PURSUANT TO SECTION 403.8055, FLORIDA STATUTES. UNLESS A SUBSTANTIALLY AFFECTED PERSON OBJECTS TO SUCH ADOPTION ON OR BEFORE MAY 25, 1984, THE AMENDMENTS WILL BE FILED FOR ADOPTION. OBJECTIONS TO THE PROPOSED AMENDMENTS SHOULD BE FILED WITH THE FOLLOWING PERSON:

Geneva M. Hartsfield, Administrative Assistant, Environmental Regulation Commission, 2600 Blair Stone Road, Tallahassee, Florida 32301.

ANY MEMBER OF THE PUBLIC MAY SUBMIT WRITTEN COMMENTS ON THE PROPOSED AMENDMENTS FOR CONSIDERATION BY THE SECRETARY ON OR BEFORE MAY 25, 1984. WRITTEN COMMENTS SHOULD BE FILED WITH

THE FOLLOWING PERSON:

Walter Starnes, Bureau of Air Quality Management, Department of Environmental Regulation, 2600 Blair Stone Road, Tallahassee, Florida 32301.

A COPY OF THE PROPOSED RULE, MATERIALS ADOPTED BY REFERENCE, AND COMPLETE ECONOMIC IMPACT STATEMENT MAY BE OBTAINED BY WRITING TO: Walter Starnes, Bureau of Air Quality Management, Department of Environmental Regulation, 2600 Blair Stone Road, Tallahassee, Florida 32301.

STATE OF FLORIDA  
DEPARTMENT OF ENVIRONMENTAL REGULATION



DER

FEB 24 1984

BAQM

BOB GRAHAM  
GOVERNOR

VICTORIA J. TSCHINKEL  
SECRETARY

ALEX SENKEVICH  
DISTRICT MANAGER

APPLICATION TO OPERATE/CONSTRUCT AIR POLLUTION SOURCES

SOURCE TYPE: Resource Recovery Facility  New<sup>1</sup> [ ] Existing<sup>1</sup>

APPLICATION TYPE:  Construction [ ] Operation [ ] Modification

COMPANY NAME: Broward County Board of County Commissioners COUNTY: Broward

Identify the specific emission point source(s) addressed in this application (i.e. Lime  
Kiln No. 4 with Venturi Scrubber; Peaking Unit No. 2, Gas Fired) Stack(s)

SOURCE LOCATION: Street Intersection US RT.441 & St. Rt. 84 City Unincorporated Broward County

UTM Zone 17 UTM: ~~XXXXXX~~ X coord = 579.6 km ~~XXXXXX~~ y coord = 2883.3 km

Latitude 26 ° 04 ' 02 "N Longitude 80 ° 12 ' 57 "W

APPLICANT NAME AND TITLE: Ms. Phyllis A. Korab, Project Director, Broward County

APPLICANT ADDRESS: Courthouse-Room 248, 201 SE 6th St., Ft. Lauderdale, FL 33301

SECTION I: STATEMENTS BY APPLICANT AND ENGINEER

A. APPLICANT

I am the undersigned ~~owner or~~ authorized representative\* of Broward County Board of County Commissioners.

I certify that the statements made in this application for a construction permit are true, correct and complete to the best of my knowledge and belief. Further, I agree to maintain and operate the pollution control source and pollution control facilities in such a manner as to comply with the provision of Chapter 403, Florida Statutes, and all the rules and regulations of the department and revisions thereof. I also understand that a permit, if granted by the department, will be non-transferable and I will promptly notify the department upon sale or legal transfer of the permitted establishment.

\*Attach letter of authorization

Signed: Phyllis A. Korab

Phyllis A. Korab, Project Director  
Name and Title (Please Type)

Date: 2/22/84 Telephone No. (305) 765-5844 <sup>357-7585</sup>

B. PROFESSIONAL ENGINEER REGISTERED IN FLORIDA (where required by Chapter 471, F.S.)

This is to certify that the engineering features of this pollution control project have been designed/examined by me and found to be in conformity with modern engineering principles applicable to the treatment and disposal of pollutants characterized in the permit application. There is reasonable assurance, in my professional judgment, that

<sup>1</sup> See Florida Administrative Code Rule 17-2.100(57) and (104)

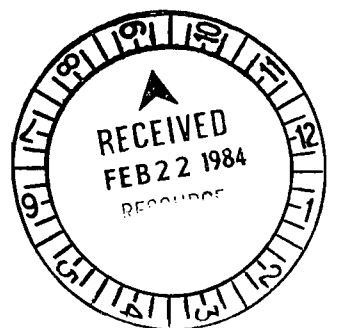



E. Requested permitted equipment operating time: hrs/day 24 ; days/wk 7 ; wks/yr 52 ;  
if power plant, hrs/yr N/A; if seasonal, describe: Not Applicable (N/A)

F. If this is a new source or major modification, answer the following questions.  
(Yes or No)

1. Is this source in a non-attainment area for a particular pollutant? Yes
  - a. If yes, has "offset" been applied? No
  - b. If yes, has "Lowest Achievable Emission Rate" been applied? No
  - c. If yes, list non-attainment pollutants. ozone (see Note 2 below)
2. Does best available control technology (BACT) apply to this source?  
If yes, see Section VI. Yes
3. Does the State "Prevention of Significant Deterioration" (PSD)  
requirement apply to this source? If yes, see Sections VI and VII. Yes
4. Do "Standards of Performance for New Stationary Sources" (NSPS)  
apply to this source? Yes
5. Do "National Emission Standards for Hazardous Air Pollutants"  
(NESHAP) apply to this source? No

- H. Do "Reasonably Available Control Technology" (RACT) requirements apply  
to this source? No
- a. If yes, for what pollutants? N/A
  - b. If yes, in addition to the information required in this form,  
any information requested in Rule 17-2.650 must be submitted.

Attach all supportive information related to any answer of "Yes". Attach any justifi-  
cation for any answer of "No" that might be considered questionable.

Not Applicable

Note:

2. Broward County is currently designated as an ozone nonattainment area.  
There are no other designated nonattainment areas for other pollutants  
within 100 kilometers of the proposed plant site.



SECTION III: AIR POLLUTION SOURCES & CONTROL DEVICES (Other than Incinerators) N/A

A. Raw Materials and Chemicals Used in your Process, if applicable:

Description	Contaminants		Utilization Rate - lbs/hr	Relate to Flow Diagram
	Type	% Wt		
NOT APPLICABLE				

B. Process Rate, if applicable: (See Section V, Item 1)

- Total Process Input Rate (lbs/hr): N/A
- Product Weight (lbs/hr): N/A

C. Airborne Contaminants Emitted: (Information in this table must be submitted for each emission point, use additional sheets as necessary)

Name of Contaminant	Emission <sup>1</sup>		Allowed <sup>2</sup> Emission Rate per Rule 17-2	Allowable <sup>3</sup> Emission lbs/hr	Potential <sup>4</sup> Emission		Relate to Flow Diagram
	Maximum lbs/hr	Actual T/yr			lbs/yr	T/yr	
NOT APPLICABLE							

<sup>1</sup>See Section V, Item 2.

<sup>2</sup>Reference applicable emission standards and units (e.g. Rule 17-2.600(5)(b)2. Table II, E. (1) - 0.1 pounds per million BTU heat input)

<sup>3</sup>Calculated from operating rate and applicable standard.

<sup>4</sup>Emission, if source operated without control (See Section V, Item 3).



H. Emission Stack Geometry and Flow Characteristics (Provide data for each stack):

Stack Height: N/A ft. Stack Diameter: N/A ft.  
 Gas Flow Rate: N/A ACFM N/A DSCFM Gas Exit Temperature: N/A °F.  
 Water Vapor Content: N/A % Velocity: N/A FPS

SECTION IV: INCINERATOR INFORMATION

Type of Waste	Type 0 (Plastics)	Type I (Rubbish)	Type II (Refuse)	Type III (Garbage)	Type IV (Pathological)	Type V (Liq. & Gas By-prod.)	Type VI (Solid By-prod.)
Actual lb/hr Incinerated	REFER TO APPENDIX F				none	none	none
Uncontrolled (lbs/hr)					none	none	none

Description of Waste Refer to Appendix F  
 Total Weight Incinerated (lbs/hr) 125,000 (See Note 3) Design Capacity (lbs/hr) 125,000  
 Approximate Number of Hours of Operation per day 24 day/wk 7 wks/yr. 52  
 Manufacturer To be determined following vendor selection  
 Date Constructed N/A Model No. N/A

	Volume (ft) <sup>3</sup>	Heat Release (BTU/hr)	Fuel		Temperature (°F)
			Type	BTU/hr	
Primary Chamber	To be determined following vendor selection				
Secondary Chamber					

Stack Height: See Note 4 ft. Stack Diameter: See Note 4 Stack Temp. See Note 4  
 Below  
 Gas Flow Rate: See Note 4 ACFM See Note 4 DSCFM\* Velocity: See Note 4 FPS

\*If 50 or more tons per day design capacity, submit the emissions rate in grains per standard cubic foot dry gas corrected to 50% excess air.

Type of pollution control device:  Cyclone  Wet Scrubber  Afterburner  
 Other (specify) Electrostatic Precipitation, See Note 4

DER Form 17-1.202(1)

Effective November 30, 1982

Page 6 of 12

3. For the purposes of this submittal, 100 percent availability (worse case) is assumed; however, the actual average total weight incinerated will be 100,00 lb/hr.

4. Refer to Appendix C

Brief description of operating characteristics of control devices: \_\_\_\_\_

Refer to Appendix C

Ultimate disposal of any effluent other than that emitted from the stack (scrubber water, ash, etc.):

Ash residue generated by the electrostatic precipitator units will be mixed with incinerator bottom ash and deposited at the Southern Residue/Unprocessable Waste Landfill adjacent to the Southern Resource Recovery Facility.

NOTE: Items 2, 3, 4, 6, 7, 8, and 10 in Section V must be included where applicable.

#### SECTION V: SUPPLEMENTAL REQUIREMENTS

Please provide the following supplements where required for this application.

- \*1. Total process input rate and product weight -- show derivation [Rule 17-2.100(127)]
- \*2. To a construction application, attach basis of emission estimate (e.g., design calculations, design drawings, pertinent manufacturer's test data, etc.) and attach proposed methods (e.g., FR Part 60 Methods 1, 2, 3, 4, 5) to show proof of compliance with applicable standards. To an operation application, attach test results or methods used to show proof of compliance. Information provided when applying for an operation permit from a construction permit shall be indicative of the time at which the test was made.
- \*3. Attach basis of potential discharge (e.g., emission factor, that is, AP42 test).
- \*4. With construction permit application, include design details for all air pollution control systems (e.g., for baghouse include cloth to air ratio; for scrubber include cross-section sketch, design pressure drop, etc.)
- \*5. With construction permit application, attach derivation of control device(s) efficiency. Include test or design data. Items 2, 3 and 5 should be consistent: actual emissions = potential (1-efficiency).
- \*6. An 8 1/2" x 11" flow diagram which will, without revealing trade secrets, identify the individual operations and/or processes. Indicate where raw materials enter, where solid and liquid waste exit, where gaseous emissions and/or airborne particles are evolved and where finished products are obtained.
- \*7. An 8 1/2" x 11" plot plan showing the location of the establishment, and points of airborne emissions, in relation to the surrounding area, residences and other permanent structures and roadways (Example: Copy of relevant portion of USGS topographic map).
- \*8. An 8 1/2" x 11" plot plan of facility showing the location of manufacturing processes and outlets for airborne emissions. Relate all flows to the flow diagram.

Note:

\* Refer to Attachment No. 2

- \*9. The appropriate application fee in accordance with Rule 17-4.05. The check should be made payable to the Department of Environmental Regulation.
- \*10. With an application for operation permit, attach a Certificate of Completion of Construction indicating that the source was constructed as shown in the construction permit.

**SECTION VI: BEST AVAILABLE CONTROL TECHNOLOGY**

A. Are standards of performance for new stationary sources pursuant to 40 C.F.R. Part 60 applicable to the source?

Yes [ ] No (Subpart (e))

Contaminant	Rate or Concentration
1. Particulate matter	0.08 grains per standard cubic foot dry gas, corrected to 50% excess air
2. No objectionable odor	

B. Has EPA declared the best available control technology for this class of sources (If yes, attach copy)

[ ] Yes [x] No

Contaminant	Rate or Concentration
N/A	

C. What emission levels do you propose as best available control technology?

Contaminant	Rate or Concentration
1. Refer to Appendix C	
2. Particulate matter	0.03 grains per standard foot dry gas, corrected to 12% CO <sub>2</sub> .

D. Describe the existing control and treatment technology (if any). N/A

- |                           |                          |
|---------------------------|--------------------------|
| 1. Control Device/System: | 2. Operating Principles: |
| 3. Efficiency:*           | 4. Capital Costs:        |

\*Explain method of determining

Note:

\*Refer to attachment No. 2

5. Useful Life:

6. Operating Costs:

7. Energy:

8. Maintenance Cost:

9. Emissions:

Contaminant

Rate or Concentration

Contaminant	Rate or Concentration

10. Stack Parameters

a. Height:

ft.

b. Diameter:

ft.

c. Flow Rate:

ACFM

d. Temperature:

°F.

e. Velocity:

FPS

E. Describe the control and treatment technology available (As many types as applicable, use additional pages if necessary). Refer to Appendix C

1.

a. Control Device:

b. Operating Principles:

c. Efficiency:<sup>1</sup>

d. Capital Cost:

e. Useful Life:

f. Operating Cost:

g. Energy:<sup>2</sup>

h. Maintenance Cost:

i. Availability of construction materials and process chemicals:

j. Applicability to manufacturing processes:

k. Ability to construct with control device, install in available space, and operate within proposed levels:

2.

a. Control Device:

b. Operating Principles:

c. Efficiency:<sup>1</sup>

d. Capital Cost:

e. Useful Life:

f. Operating Cost:

g. Energy:<sup>2</sup>

h. Maintenance Cost:

i. Availability of construction materials and process chemicals:

<sup>1</sup>Explain method of determining efficiency.

<sup>2</sup>Energy to be reported in units of electrical power - KWH design rate.

j. Applicability to manufacturing processes:

k. Ability to construct with control device, install in available space, and operate within proposed levels:

3.

a. Control Device:

b. Operating Principles:

c. Efficiency:<sup>1</sup>

d. Capital Cost:

e. Useful Life:

f. Operating Cost:

g. Energy:<sup>2</sup>

h. Maintenance Cost:

i. Availability of construction materials and process chemicals:

j. Applicability to manufacturing processes:

k. Ability to construct with control device, install in available space, and operate within proposed levels:

4.

a. Control Device:

b. Operating Principles:

c. Efficiency:<sup>1</sup>

d. Capital Costs:

e. Useful Life:

f. Operating Cost:

g. Energy:<sup>2</sup>

h. Maintenance Cost:

i. Availability of construction materials and process chemicals:

j. Applicability to manufacturing processes:

k. Ability to construct with control device, install in available space, and operate within proposed levels:

F. Describe the control technology selected: Refer to Appendix C

1. Control Device:

2. Efficiency:<sup>1</sup>

3. Capital Cost:

4. Useful Life:

5. Operating Cost:

6. Energy:<sup>2</sup>

7. Maintenance Cost:

8. Manufacturer:

9. Other locations where employed on similar processes:

a. (1) Company:

(2) Mailing Address:

(3) City:

(4) State:

<sup>1</sup>Explain method of determining efficiency.

<sup>2</sup>Energy to be reported in units of electrical power - KWH design rate.

(5) Environmental Manager:

(6) Telephone No.:

(7) Emissions:<sup>1</sup>

Contaminant

Rate or Concentration

(8) Process Rate:<sup>1</sup>

b. (1) Company:

(2) Mailing Address:

(3) City:

(4) State:

(5) Environmental Manager:

(6) Telephone No.:

(7) Emissions:<sup>1</sup>

Contaminant

Rate or Concentration

(8) Process Rate:<sup>1</sup>

10. Reason for selection and description of systems:

<sup>1</sup>Applicant must provide this information when available. Should this information not be available, applicant must state the reason(s) why.

### SECTION VII - PREVENTION OF SIGNIFICANT DETERIORATION

A. Company Monitored Data N/A; Refer to Appendix E

1. \_\_\_\_\_ no. sites \_\_\_\_\_ TSP \_\_\_\_\_ ( ) SO<sub>2</sub>\* \_\_\_\_\_ Wind spd/dir

Period of Monitoring \_\_\_\_\_ / \_\_\_\_\_ / \_\_\_\_\_ to \_\_\_\_\_ / \_\_\_\_\_ / \_\_\_\_\_  
month day year month day year

Other data recorded \_\_\_\_\_

Attach all data or statistical summaries to this application.

\*Specify bubbler (B) or continuous (C).



2. Instrumentation, Field and Laboratory

a. Was instrumentation EPA referenced or its equivalent? [ ] Yes [ ] No

b. Was instrumentation calibrated in accordance with Department procedures?  
[ ] Yes [ ] No [ ] Unknown

B. Meteorological Data Used for Air Quality Modeling Refer to Appendix C

1. 5 Year(s) of data from 01 / 01 / 70 to 12 / 31 / 74  
month day year month day year

2. Surface data obtained from (location) Miami, Florida

3. Upper air (mixing height) data obtained from (location) Miami, Florida

4. Stability wind rose (STAR) data obtained from (location) N/A

C. Computer Models Used Refer to Appendix C

1. Industrial Source Complex Model (ISC) - Modified? If yes, attach description.

Only output data format modified Modified? If yes, attach description.

\_\_\_\_\_ Modified? If yes, attach description.

\_\_\_\_\_ Modified? If yes, attach description.

Attach copies of all final model runs showing input data, receptor locations, and principle output tables. Refer to Appendix C

D. Applicants Maximum Allowable Emission Data Refer to Appendix C

Pollutant	Emission Rate
TSP	<u>_____</u> grams/sec
SO <sup>2</sup>	<u>_____</u> grams/sec

E. Emission Data Used in Modeling Refer to Appendix C

Attach list of emission sources. Emission data required is source name, description of point source (on NEDS point number), UTM coordinates, stack data, allowable emissions, and normal operating time.

F. Attach all other information supportive to the PSD review. Refer to Attachment No. 3

G. Discuss the social and economic impact of the selected technology versus other applicable technologies (i.e., jobs, payroll, production, taxes, energy, etc.). Include assessment of the environmental impact of the sources. Refer to Attachment No. 3

H. Attach scientific, engineering, and technical material, reports, publications, journals, and other competent relevant information describing the theory and application of the requested best available control technology. Refer to Attachment No. 3



**County Administrator's Office**  
Room 248, Broward County Courthouse  
Fort Lauderdale, Florida 33301  
(305) 765-5121

February 22, 1984

Attn: To Whom It May Concern

State of Florida  
Department of Environmental Regulation  
2562 Executive Center Circle East  
Montgomery Building  
Tallahassee, Florida 32301

Re: Application to Operate/Construct Air Pollution Source for Southern  
Broward County Resource Recovery Facility

I have designated Phyllis A. Korab, Director, Broward County Resource Recovery Office, as the authorized agent for Broward County's Application to Operate/Construct Air Pollution Source for the above referenced project. Ms. Korab is authorized to negotiate modifications and revisions when necessary, and accept or assent to any stipulation on our behalf.

Very truly yours,

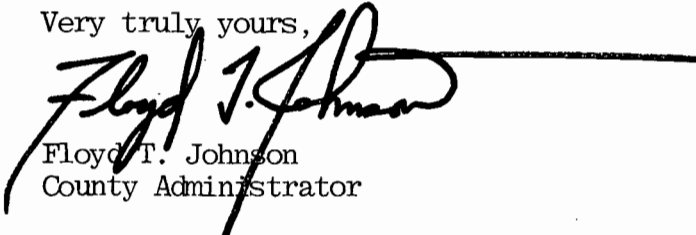
  
Floyd T. Johnson  
County Administrator

FTJ/bd

**BROWARD COUNTY BOARD OF COUNTY COMMISSIONERS**

Marcia Beach Scott I. Cowan Howard Craft Howard Forman Jack Fried Nicki Englander Grossman Gerald Thompson

**An Equal Opportunity Employer**

STATE OF FLORIDA, DER - APPLICATION TO CONSTRUCT/OPERATE  
AIR POLLUTION SOURCES

ATTACHMENT NO. 1

SECTION I

STATEMENTS BY APPLICANT AND ENGINEER

B. Professional Engineer Certification

The engineering features of this pollution control project have been designed as minimum requirements which the vendor selected to design and construct the project must meet. Following vendor selection, a professional engineer registered in accordance with Florida State requirements will certify the actual vendor-designed pollution control project.

STATE OF FLORIDA, DER - APPLICATION TO CONSTRUCT/OPERATE  
AIR POLLUTION SOURCES

ATTACHMENT NO. 2

SECTION V

SUPPLEMENTAL REQUIREMENTS

1. Not Applicable.
2. Basis of emission estimate and proposed methods to show proof of compliance with applicable standards - refer to Appendix C.
3. Basis of potential discharge - refer to Appendix C.
4. Design details for air pollution control systems will be dependent upon the vendor selected to construct the project. Minimum ESP design requirements are presented in Appendix B. Design detail information is presented in Table 1 for equipment to be provided by each potential vendor, Waste Management Inc.-Bechtel Civil & Minerals, Inc. and Signal RESCO, Inc. Typical specifications and detailed drawings of the air pollution system to be provided by Waste Management, Inc.-Bechtel Civil & Minerals, Inc. are included in Appendix D. Information from Signal-RESCO is not available at this time.
5. Not Applicable.
6. Flow diagram - A flow diagram identifying the individual operations of the resource recovery process is included as Figure 1. The process equipment depicted in the diagram is typical; the numbers and/or configuration of the units may vary from vendor to vendor.
7. The location of the resource recovery facility in relation to the surrounding area, residences, roadways, and other structures is shown on Figure 2. The source of airborne emissions at the facility is identified on the plan. The number of stacks at the facility will be one or two, depending upon the selected vendor.
8. The actual configuration of the resource recovery facility will be dependent upon the vendor selected to construct the project. Although the manufacturing processes are the same, each vendor proposes his own manufacturing layout. Plot plans for each potential vendor are included. Figure 3 illustrates the manufacturing process and airborne emissions outlets proposed by Waste Management, Inc.-Bechtel Civil & Minerals, Inc. The plant layout proposed by Signal-RESCO, Inc. is shown on Figure 4.
9. Not Applicable.
10. Certificate of completion of Construction-Not Applicable.

TABLE 1

## ELECTROSTATIC PRECIPITATOR DESIGN CRITERIA

	<u>Waste Management, Inc.- Bechtel Civil &amp; Minerals, Inc.</u>	<u>Signal- RESCO</u>
1) <u>Gas Flow</u>		
a) Volume Flow Rate (per Section) (Max), cubic meters/second	58	82
b) Velocity, meters/second	0.81	15.24
c) Temperature (per Section), °C	200	212
d) Pressure, psi	0.21	See Note 1
2) <u>ESP Design</u>		
a) Electrical Length per Plate, meters	0.50	3.84
b) Wire to Plate Spacing, millimeters	150	152.4
c) Wire to Wire Spacing, millimeters	180/320	304.8
d) Wire Diameter, millimeters	2.7	See Note 2
e) Wires per Section, meters	864	768
f) Wire Length per Section, meters	3,365	7,022.6
g) Number of Electrical Sections	3	3
h) Plate Area per Section, square meters	1,440	2,330.6
i) Duct Width, meters	0.30	9.75
3) <u>Electrical Design</u>		
a) Applied Voltage per Section, volts	60,000	See Note 1
b) Total Current in Electrical Section	0.6	See Note 1
c) Roughness of Wire	0.8	See Note 1

## Notes:

1. Information not provided by vendor.
2. Field No. 1 - Isodyne wires 2.29 mm x 4.82 mm with 5.33 mm spikes every 50.9 mm perpendicular to flow.  
Field No. 2 & 3 - Star shaped wires 5.79 mm diameters.

# Broward County RESOURCE RECOVERY PROGRAM

## FLOW DIAGRAM

**WHAT IS RESOURCE RECOVERY?** It is a solid waste disposal method producing inert residue while recovering useful energy and/or materials. The resource recovery process chosen by Broward County is called mass-fired waterwall incineration.

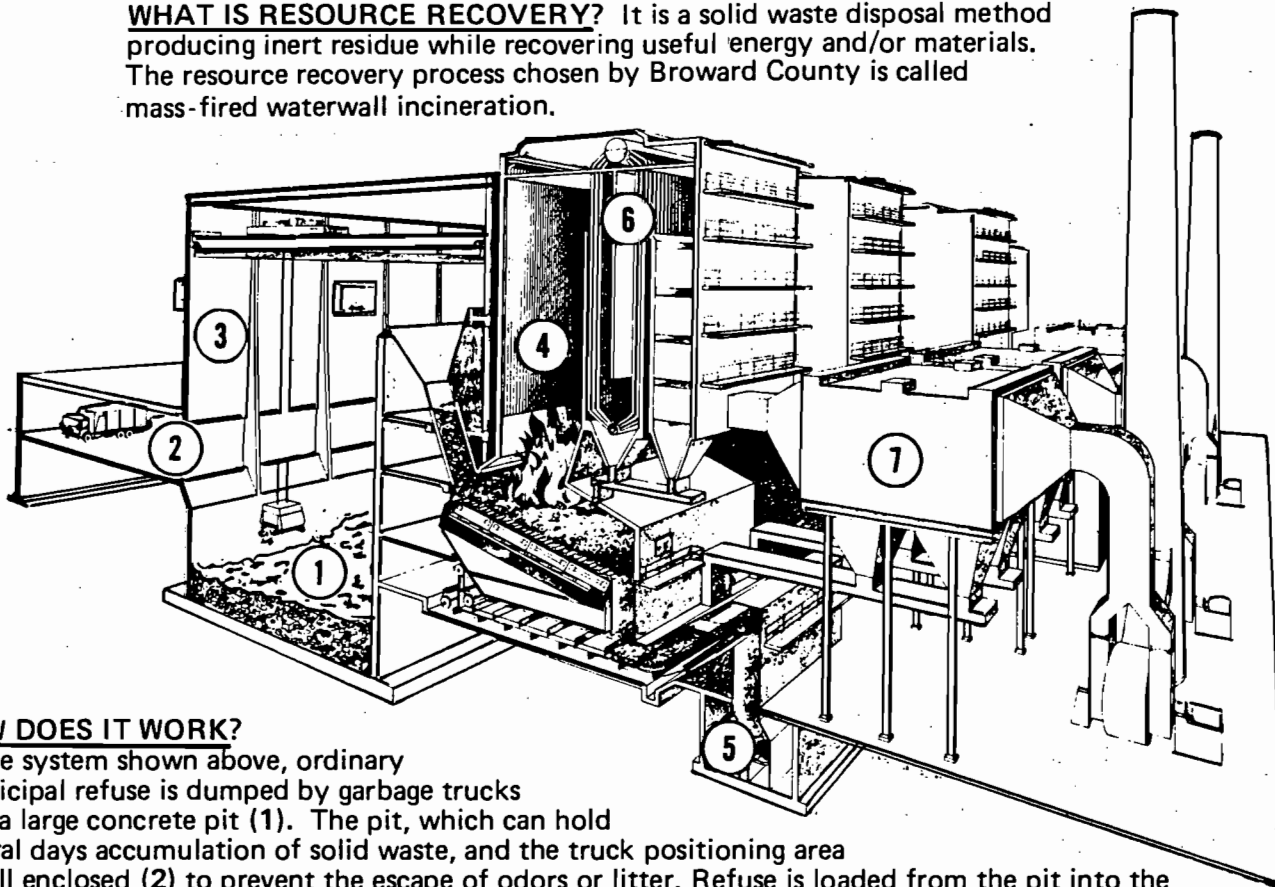

### HOW DOES IT WORK?

In the system shown above, ordinary municipal refuse is dumped by garbage trucks into a large concrete pit (1). The pit, which can hold several days accumulation of solid waste, and the truck positioning area are all enclosed (2) to prevent the escape of odors or litter. Refuse is loaded from the pit into the furnace by a large overhead bridge crane (3). Oversized or unprocessable items (engine blocks, tree stumps, concrete rubble, etc.) which accidentally get into the pit can be removed at this point and either sent directly to the landfill, or put through a shredder for size reduction prior to being sent to landfill or sold.

In the furnace (4) the refuse is burned at high temperature and under controlled conditions of air and turbulence. The result is essentially complete destruction of organic material, (paper, plastic, wood, food wastes, etc.) leaving an ash residue (5) which contains the unburnable fraction (glass, metal, ceramics, etc.). This residue has a volume of five to ten percent of the original solid waste, thus lengthening the projected landfill lifetime by a factor of ten to twenty.

Hot gases from the combustion process pass up through the boiler portion (6) of the furnace where the heat is transferred to water-filled steel tubes. This heat is used to generate steam and ultimately electricity.

After passing through the boiler the hot gases pass through electrostatic precipitators (7) which act as giant filters removing the dust particles from the gas stream. The clean gases are then discharged at the stack.

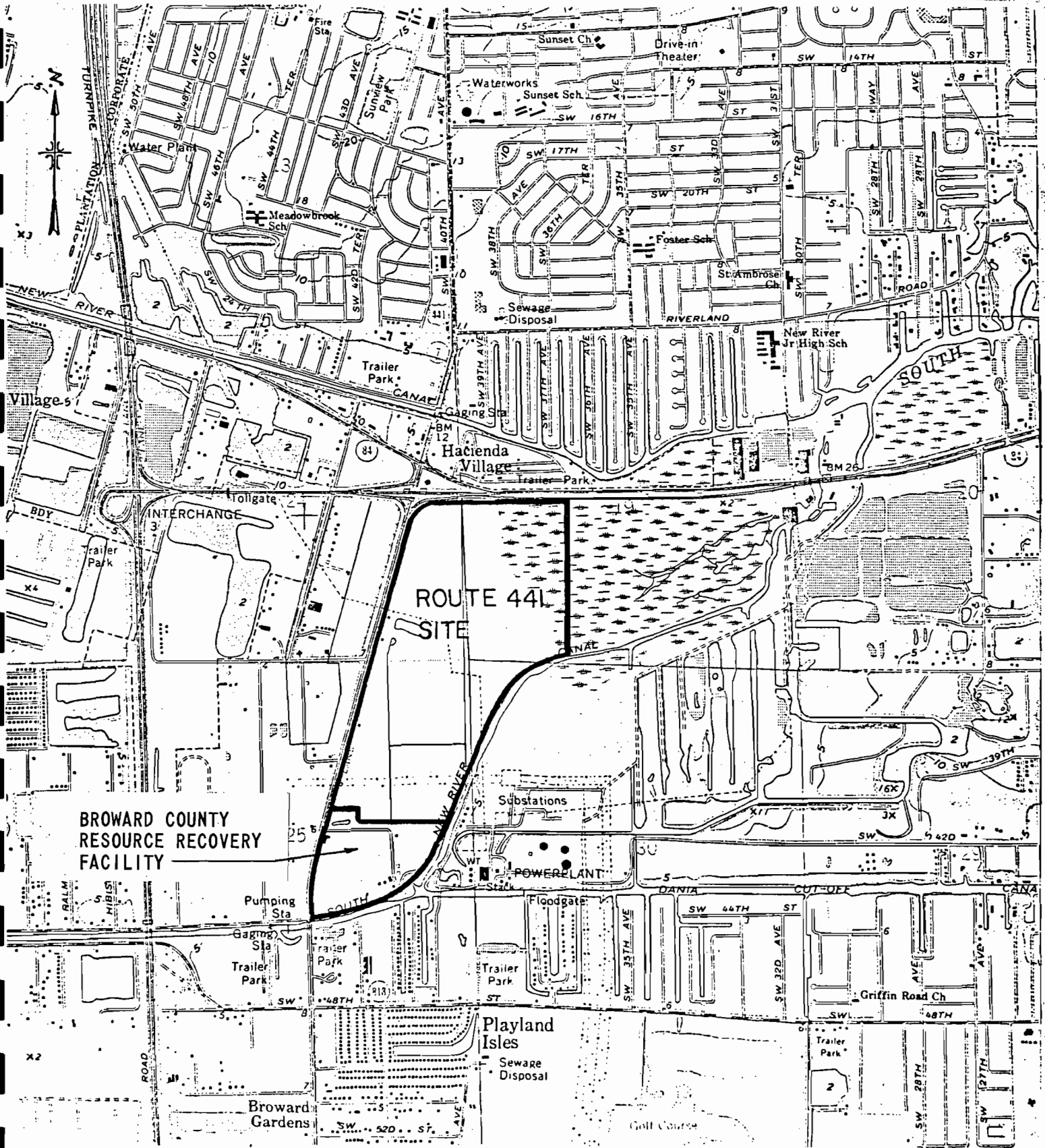

**BROWARD COUNTY  
RESOURCE RECOVERY  
ROUTE 441 SITE**

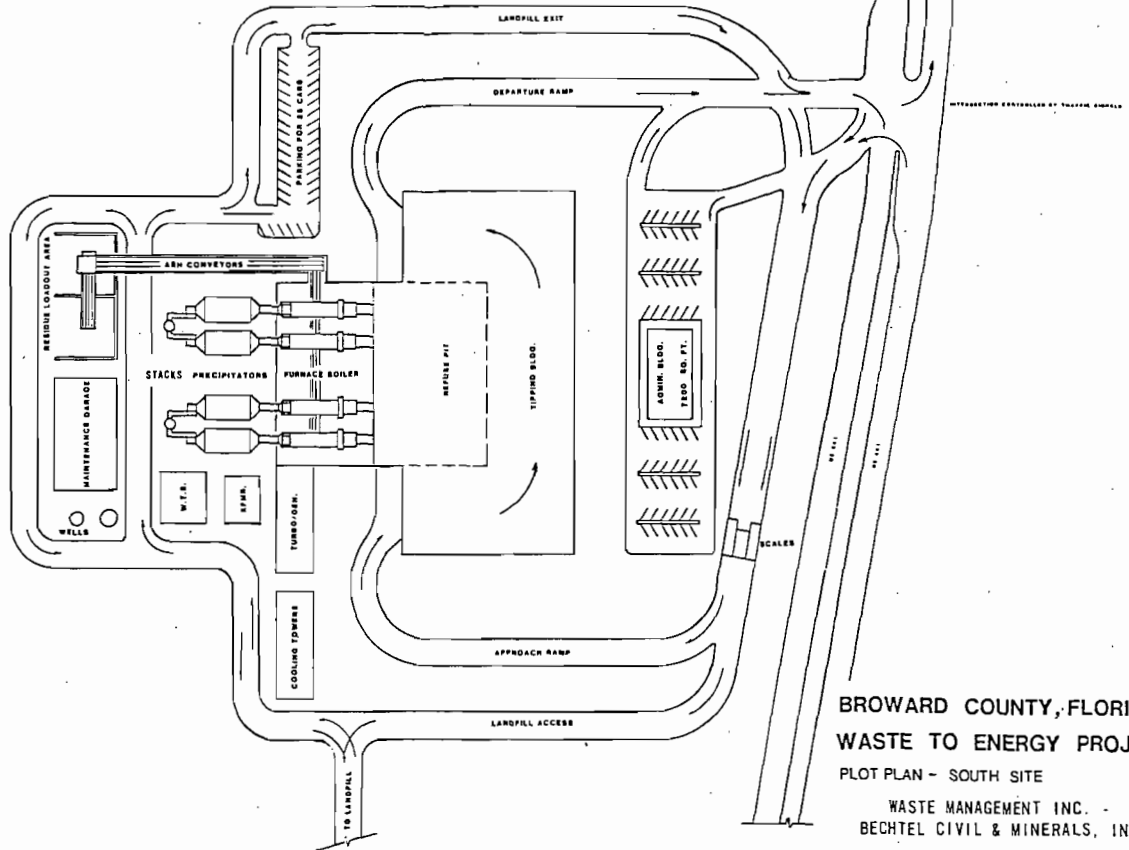
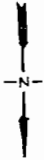

**BROWARD COUNTY, FLORIDA  
WASTE TO ENERGY PROJECT  
PLOT PLAN - SOUTH SITE**  
WASTE MANAGEMENT INC. -  
BECHTEL CIVIL & MINERALS, INC.





STATE OF FLORIDA DER - APPLICATION TO CONSTRUCT/OPERATE  
AIR POLLUTION SOURCES

ATTACHMENT NO. 3

SECTION VII

PREVENTION OF SIGNIFICANT DETERIORATION

F. The following materials are provided supportive of the PSD review:

Appendix A - Project Description

Appendix B - Project Technical Specifications

Appendix C - Technical Support Document for the  
Prevention of Significant Deterioration  
(PSD) Permits for Two Resource  
Recovery Facilities in Broward County,  
Florida

G. Social and economic impacts of the selected technology and assessment of the environmental impact of the air emissions source are discussed in Appendix C.

H. Additional relevant information describing the theory and application of the requested best available control technology - same as Item F above.

APPENDIX A  
PROJECT DESCRIPTION

APPENDIX A  
PROJECT DESCRIPTION

The southern Broward County Resource Recovery Facility (RRF) and residue/unprocessable waste landfill will be located on 228 acres of land in unincorporated Broward County (Figure 1). The site is bounded by Route 441 on the west, the South Fork New River Canal on the south and east and the proposed I-595 right-of-way in the north. A portion of the site including a 300 foot wide strip along the South Fork New River Canal has been designated by Broward County as a Local Area of Particular Concern (LAPC) and an Urban Wilderness area. The resource recovery facility and the residue/unprocessable waste landfill sites will be divided by the Central Broward Wastewater Region sludge composting plant. The resource recovery facility (RRF) will be located on the southern portion of the project site (57 acres). The residue/unprocessable waste landfill will be constructed on 171 acres north of the sludge composting facilities. Development of the 228 acre site will include a significant mitigation effort which will consist of the preservation and enhancement of 50 acres of land adjacent to South Fork New River Canal and Anne Kolb Park (Figure 2).

The RRF is a mass burn system which will receive and process a minimum of 1,600 tpd of solid waste from southern Broward County with capability for future expansion of up to 2,200 tpd. Approximately 60 percent of the processable solid waste generated in Broward County is expected to be received by this resource recovery facility. Most of the solid waste coming to the RRF will be burned to reduce the original volume by 90 percent. Heat energy from the burning process will be recovered to generate electricity which will be sold to FP&L. Ash residue from the incineration process, consisting of less than 4.0 and 0.3 percent by weight of combustible and putres-

FIGURE 1

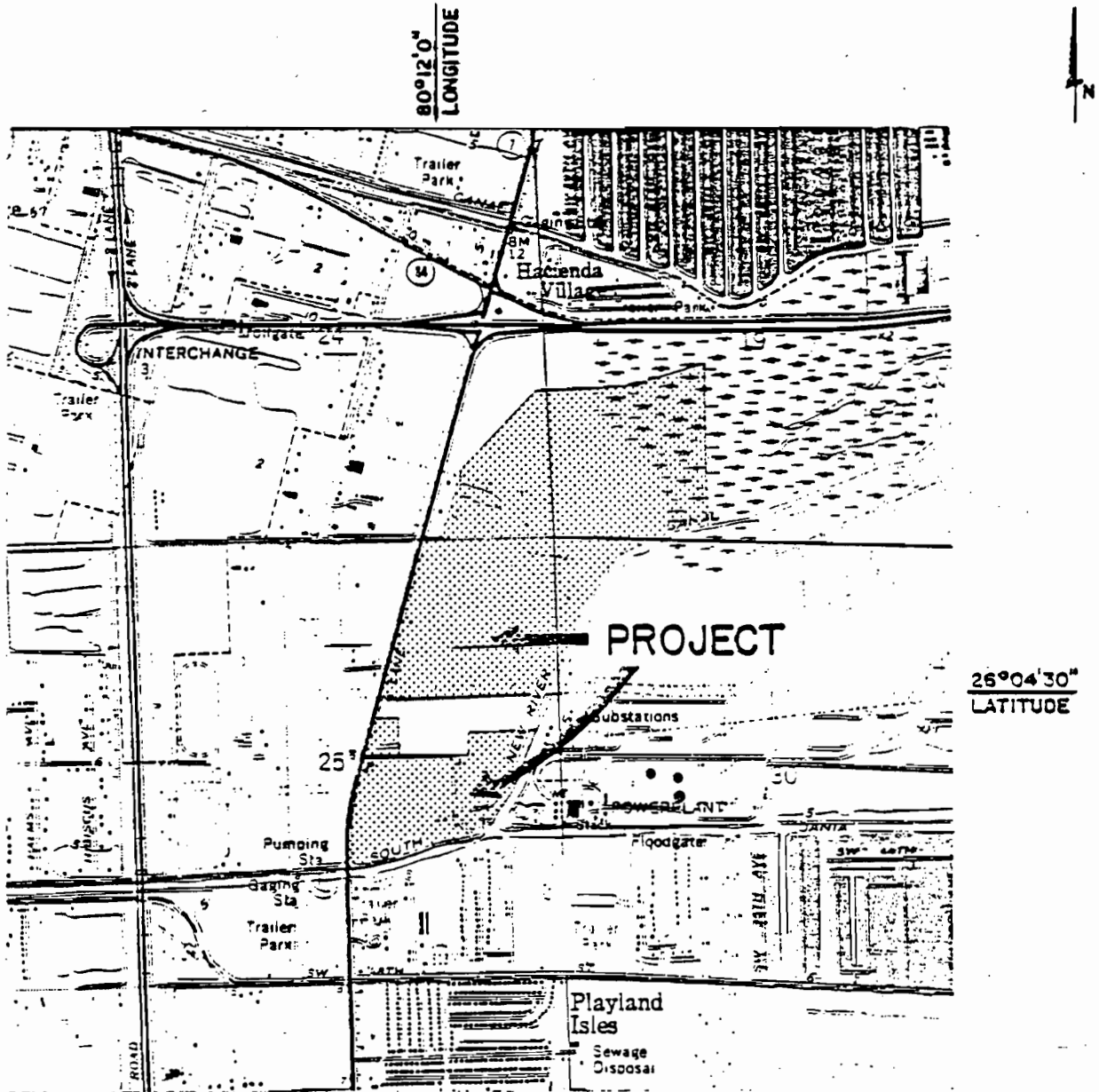

PURPOSE: BROWARD COUNTY RESOURCE RECOVERY FACILITY

DATUM: MEAN SEA LEVEL

SCALE: 1000 0 1000 2000

SOURCE: USC & GS T-8428 FORT LAUDERDALE SOUTH, FLORIDA QUADRANGLE (1962 PHOTO REVISED 1969)

VICINITY MAP

IN AREA ADJACENT TO SOUTH FORK OF THE NEW RIVER

COUNTY OF BROWARD, STATE OF FLORIDA  
APPLICATION BY BROWARD COUNTY

SHEET OF DATE

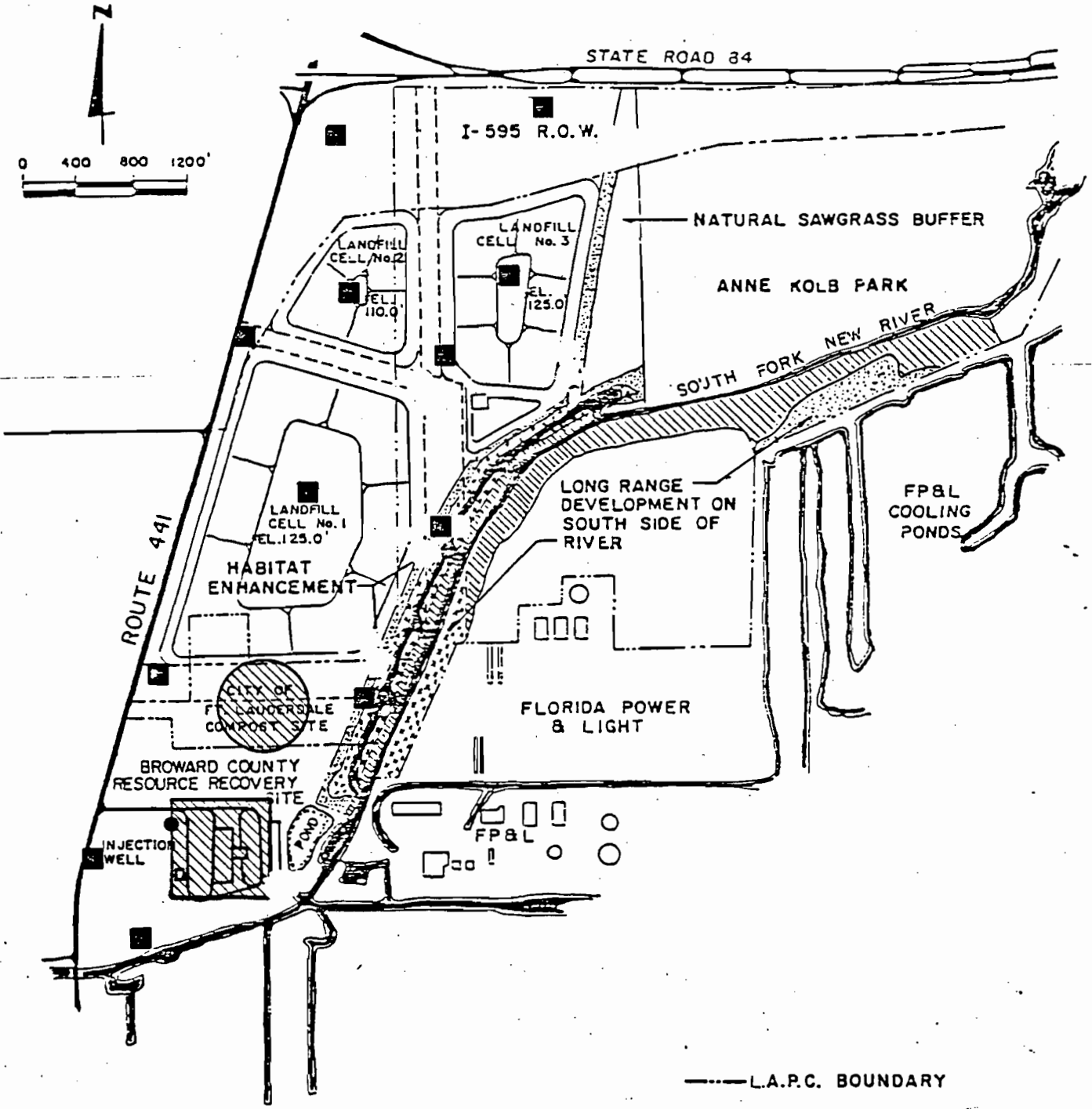

LEGEND

- MARSH
- CYPRESS
- EXISTING VEGETATION

- PROPOSED TEST BORING
- EXISTING TEST BORINGS
- GEOTECHNICAL TEST BORINGS

BROWARD COUNTY  
 RESOURCE RECOVERY  
 CONCEPTUAL DEVELOPMENT AND  
 ENVIRONMENTAL ENHANCEMENT PLAN  
 FOR THE ROUTE 441 SITE  
 NOT TO SCALE

crible matter, respectively, will be landfilled. Unprocess-able wastes such as construction materials will also be landfilled directly. Ferrous metals may be salvaged and stored on site until they are sold by the operator.

The main features of the RRF will consist of material receiving and handling areas, storage pits, incinerators, boilers, turbine generators to produce electricity, and electrostatic precipitators for particulate removal prior to discharge through the stacks. Incinerator and fly ash residue will be cooled in the residue tank and conveyed to the residue disposal wing. Administrative and control facilities will include a scale house, offices, plant personnel facilities, and a control room for observing and controlling facility operations.

The landfill will consist of two landfill cells, attendant facilities for water management, and on-site mitigation adjacent to the South Fork New River Canal (Figure 2). The ash and unprocessable waste will be filled in a series of subcells within each landfill area. All material deposited in the fill will be placed at or above the 100-year flood elevation. Exposed (to public view) faces will be capped and landscaped as filling progresses. The final height of the landfill will be approximately 133 feet above grade, or elevation 140 feet above mean sea level (MSL).

The development plan for the landfill site initially involves material disposal in landfill cell No. 1, which is expected to occur over a period of 14 years (i.e., 1987 to 2001). After landfill cell No. 1 is completely filled and closed in accordance with federal, state, and local regulatory agency requirements, the remaining landfill cell No. 2 will become the final site for active landfilling for a period of 6 years (i.e., 2001 to 2007).

The ash residue and unprocessable solid waste are stable inorganic and nonhazardous materials. Thus, the landfill mass

will be a stable, inorganic material which will not be subject to the anaerobic decomposition processes with associated noxious end products common to the landfilling of organic solid wastes (garbage). Landfills of this type do not attract insects, rodents, and birds as do sanitary (garbage) landfills.

The project site is within regulated airspace of the Fort Lauderdale-Hollywood International Airport. The FAA has been notified of the proposed project and the facility will be in compliance with FAA regulations. The FAA's main concerns are stack height and attraction of birds about landfills. The RRF stack height is below the 200 foot FAA limitation for the site. The FAA has stated that the proposed landfill operations should not promote an increase in bird population at the site due to its inorganic content.

The surface water management system for the southern site will be designed to accommodate current and future site utilization. A phased development plan is envisioned in order to address such issues as the routing and treatment of runoff from active portions of a landfill cell and concerns regarding the quality and appropriate control methods for the disposal of surface runoff during rainfall periods. Collection and disposal of leachate and stormwater from active landfill subcell areas will be entirely separate from the stormwater management facilities. To ensure that all runoff and leachate are contained on-site, each landfill cell will have an impermeable membrane and underdrain system, and the landfill cell will be surrounded by a grassed perimeter swale system and perimeter access road which will serve as a dike. All leachate and stormwater runoff will be disposed of in an environmentally acceptable manner.



APPENDIX B  
TECHNICAL SPECIFICATIONS

APPENDIX B  
TECHNICAL SPECIFICATIONS

TABLE OF CONTENTS

	<u>Page Number</u>
<u>SECTION 1 - RESOURCE RECOVERY FACILITIES</u>	
1.1 Introduction	B-1
1.2 General Requirements	B-3
1.2.1 Civil Engineering	B-3
1.2.2 Image	B-3
1.2.3 System Availability	B-4
1.2.4 General Facility Process Design Requirements	B-4
1.2.5 Applicable Codes and Standards	B-6
1.2.6 Utilities	B-7
1.2.7 Site Utilities	B-10
1.3 Site Work	B-17
1.3.1 Subsurface Investigation	B-17
1.3.2 Survey	B-17
1.3.3 Clearing, Grubbing and Site Preparation	B-18
1.3.4 Excavation, Filling and Backfilling	B-19
1.3.5 Easements and Setbacks	B-21
1.3.6 Site Maintenance	B-21
1.4 Architectural	B-21
1.4.1 Functional	B-21
1.4.2 Detailed Architectural Requirements	B-28
1.5 Structural	B-31
1.5.1 Structures Supporting Vehicular Traffic	B-31
1.5.2 Structural Steel	B-32
1.5.3 Metal Roof Deck	B-33
1.5.4 Miscellaneous Metals	B-33
1.5.5 Concrete	B-35
1.5.6 Light Poles, Mast Lighting Sign and Signal Supports	B-36
1.5.7 Stacks	B-37
1.6 General Mechanical	B-37
1.6.1 Plumbing/Piping	B-37
1.6.2 Heating, Ventilation and Air Conditioning	B-39

APPENDIX B  
TECHNICAL SPECIFICATIONS

TABLE OF CONTENTS  
(continued)

	<u>Page Number</u>
<u>SECTION 1 - RESOURCE RECOVERY FACILITIES (cont'd)</u>	
1.7 Electrical	B-40
1.7.1 Scope of Work	B-40
1.7.2 General Electrical Requirements	B-41
1.7.3 Standards	B-42
1.7.4 Temporary and Interim Electrical Work	B-42
1.7.5 Cutting and Patching	B-42
1.7.6 Fire Alarm System	B-43
1.7.7 Fail-Safe Systems	B-43
1.8 Facility Access and MSW Delivery Requirements	B-43
1.8.1 Functional Design	B-43
1.8.2 Traffic Flow	B-43
1.8.3 Traffic Control	B-46
1.8.4 Weighing Station	B-47
1.8.5 Tipping Area	B-49
1.9 Processable Waste Storage and Handling System	B-50
1.9.1 General Description	B-50
1.9.2 Processable Waste Storage	B-50
1.9.3 Crushers/Shears	B-51
1.9.4 Crane and Grapple Systems	B-51
1.9.5 Charging Hoppers and Chutes	B-55
1.10 Combustion Systems	B-56
1.10.1 General Design	B-56
1.10.2 Furnace Design	B-57
1.10.3 Combustion Air System	B-59
1.10.4 Energy Recovery Systems	B-61
1.10.5 Boiler Auxiliary Systems	B-62
1.10.6 Combustion Controls	B-66
1.11 Residue Handling Systems	B-67
1.11.1 General	B-67
1.11.2 Description	B-67
1.11.3 Bottom Ash	B-68
1.11.4 Fly Ash	B-68
1.12 Air Pollution Control Systems	B-69
1.12.1 Electrostatic Precipitators	B-69
1.12.2 Induced Draft Fan Systems	B-72
1.12.3 Stacks	B-73

APPENDIX B  
TECHNICAL SPECIFICATIONS

TABLE OF CONTENTS  
(continued)

	<u>Page Number</u>
<u>SECTION 1 - RESOURCE RECOVERY FACILITIES (cont'd)</u>	
1.13 Turbine - Generator Sets	B-74
1.13.1 System Design	B-74
1.13.2 Turbines	B-75
1.13.3 Generators	B-75
1.13.4 Cooling System	B-77
1.14 Process Control Systems	B-80
1.14.1 Local Automatic Control Systems	B-80
1.14.2 Remote Automatic Control Systems	B-80
1.14.3 Local Manual Control Systems	B-82
1.14.4 Remote Manual Control Systems	B-82
1.14.5 Control System Priorities	B-83
1.14.6 System Requirements	B-83
1.14.7 Uninterruptible Power Supplies	B-83
1.14.8 Process Alarms	B-84
1.14.9 HVAC	B-84
1.15 Facility Security and Communications Systems	B-85
1.15.1 Facility Security	B-85
1.15.2 Communications	B-85
1.15.3 Security Lighting	B-85
<u>SECTION 2 - LANDFILL TECHNICAL SPECIFICATIONS</u>	
2.1 Introduction	B-86
2.2 General Design and Construction Requirements	B-88
2.3 General Operation Requirements	B-89
2.4 Environmental	B-91
2.4.1 Design and Construction Requirements	B-92
2.4.2 Operations Requirements	B-92
2.4.3 Water Quality Requirements	B-93
2.4.4 Noise Impact Requirements	B-94
2.4.5 Odor/Vector Control Requirements	B-94

APPENDIX B  
TECHNICAL SPECIFICATIONS

TABLE OF CONTENTS  
(continued)

	<u>Page Number</u>
<u>SECTION 3 - ACCEPTANCE TESTING REQUIREMENTS</u>	
3.1 Acceptance Testing	B-95
3.1.1 Pre-Acceptance Test Responsibilities of the Contractor	B-95
3.1.2 Requirements for the Acceptance Testing	B-95
3.1.3 Acceptance Test Procedure	B-96
3.1.4 Environmental Testing	B-97
3.1.5 Facility Capacity Testing	B-99
3.1.6 Energy Recovery Testing	B-100
3.1.7 Materials Recovery Testing	B-101
3.2 Supply of Waste During the Acceptance Testing	B-102
3.3 Residue and Unprocessable Waste Removal	B-102
3.4 Energy Generation During the Facility Acceptance Testing	B-102
3.5 Preparation of Acceptance Test Report	B-102
3.6 Facility Acceptance	B-103

APPENDIX B

TECHNICAL SPECIFICATIONS

LIST OF TABLES

<u>Table Number</u>	<u>Title of Table</u>	<u>Page Number</u>
B-1	1982 Average Annual Water Quality Values for the Broward County System 3-A Plant	B-12
B-2	1982 Average Annual Water Quality Values for the City of Fort Lauderdale's Walter E. Peele Plant	B-14
B-3	1982 Average Annual Water Quality Values for the Broward County System 1-A Plant	B-16

APPENDIX B  
TECHNICAL SPECIFICATIONS

LIST OF FIGURES

<u>Figure Number</u>	<u>Description</u>	<u>Following Page</u>
B-1	Utility Locations Adjacent to the Route 441 Site	B-10
B-2	Electrical Interconnection Schematic Route 441 Site	B-10
B-3	Utility Locations Adjacent to the Copans Road Site	B-14
B-4	Electric Interconnection Schematic Copans Road Site	B-14

APPENDIX B  
TECHNICAL SPECIFICATIONS  
SECTION 1 - RESOURCE RECOVERY FACILITIES

1.1 Introduction

The intent of these technical specifications is to set minimum guidelines and functional design requirements to insure comparable proposals of uniform quality and to establish specific standards for the construction and operation of the facilities. In no instance is there any intent to limit the Proposer from adding to these minimum requirements and guidelines, or to unfavorably affect the use of proprietary systems and subsystems developed by manufacturer-suppliers through their own research and development efforts.

If a Proposer desires a change in the functional design requirements described herein, the Proposer shall submit identification of the change by utilizing Form 5.3 contained in the RFP. As discussed in Section 1 of the RFP, these facilities shall include two resource recovery facilities and two final Residue/Unprocessable Waste disposal landfills. In this specification, unless the context otherwise requires, words imparting the singular include the plural and vice versa. Thus, these technical specifications will apply to each facility.

The Contractor shall provide the necessary facilities to dispose fully of all the municipal solid waste (MSW) delivered to the facilities.

The Contractor shall not receive or dispose of pathogenic or hazardous industrial wastes.

Each resource recovery facility shall process all processable waste delivered to the facilities as received and shall obtain the following outputs:

- o Electrical energy
- o Recovered materials (optional)
- o Ash residue



These technical specifications are based on a mass-burn system technology wherein the waste shall be burned continually in furnace-boilers under controlled conditions of air pressure and temperature. Steam, produced in the boilers, shall be passed through a turbine-generator set to generate electricity. The residue and siftings shall be cooled either by spray or quench, and eventually landfilled if no reuse can be found for them. Gas stream particulates and fly ash removed by electrostatic precipitators before the gases are discharged into the atmosphere may be conveyed to a common residue removal system, along with boiler ash or the fly ash and boiler ash may be removed by separate systems from the plant.

The Contractor shall supply, maintain and operate all necessary process equipment and machinery. All equipment shall be arranged in such a way as to insure safety, good housekeeping, accessibility, and ease of replacement and/or maintenance of the equipment. All equipment and machinery shall be new and of the latest proven design. The process design shall include adequate redundancy to meet the required availability and process requirements. In addition, the facilities shall be designed to accommodate future expansions that may be necessitated as a result of increased waste generation.

In accordance with Section 4 of the RFP, a minimum of two distinct and independent process lines shall be provided at the southern resource recovery facilities, and a minimum of two distinct and independent process lines shall be provided at the northern resource recovery facility. Each process line shall, as a minimum, include the following:

- o A refuse-fired mass-burning furnace/boiler (steam generator) with appurtenances
- o Residue conveyors with appurtenances

- o An electrostatic precipitator with appurtenances
- o An induced draft fan and related duct work
- o Instrumentation

Common elements to each resource recovery facility shall include, but not necessarily be limited to:

- o MSW/residue weighing system
- o Enclosed tipping floor
- o Refuse storage pit
- o Refuse charging cranes and grapples
- o Collecting residue conveyors
- o Ferrous removal systems (optional)
- o Condensers
- o Water treatment equipment
- o Steam extraction headers and controls
- o Two turbine/generator sets or one set with one spare rotor provided
- o Stacks
- o Centralized process control system

## 1.2 General Requirements

### 1.2.1 Civil Engineering

The design of each facility shall take into account the existing site conditions with respect to soil conditions, site clearing and drainage. The Proposer shall be responsible for any site preparation including soil stabilization.

Site grading shall meet the requirements for necessary flood protection and be compatible with the general topography of the adjacent properties.

### 1.2.2 Image

It is important to the County that, because of the anticipated physical size and the activities that take place in and around these facilities, utmost care be paid to minimize any possible adverse impact of the presence of each facility to the public. In this regard, a sensitive and careful urban planning effort is required in the siting and architectural design.

The buildings and grounds of each facility should be designed to project a coherent image of each facility's function and value to the community. Exterior building materials and fenestration shall project an image of quality and functionalism. This architectural image should be contemporary in tone, visually low-key on the exterior, and embody current design for industrial buildings. Each facility should be perceived by the public as a resource and energy recovery industrial building and not as an incinerator or refuse dump. A good neighbor relationship is mandatory for each facility and the surrounding community.

The visual quality of each facility's stack design with regard to siting, material, and color options shall be considered.

#### 1.2.3 System Availability

The facilities shall be designed using a modular approach with sufficient equipment redundancy to avoid shutdowns or outages. Each facility shall be designed to accept those quantities delivered by the County and the contract municipalities in accordance with their normal collection and delivery practices. The facilities shall be designed to process 765,000 tons of Processable Waste per year, 14,700 tons per week, 2,100 tpd, with allowances made for scheduled and unscheduled downtime.

The system designs shall provide for continuous performance.

Guaranteed availability shall be based on a proposed energy output for each ton of input at varying MSW heating values. The extent to which the guaranteed availability changes with changes in the heating value of the wastes shall also be guaranteed.

#### 1.2.4 General Facility Process Design Requirements

The design of each facility shall incorporate the following requirements:

- o Each facility shall be designed so that all the Processable Waste received will be processed in a highly reliable manner. The Proposer will clearly state and demonstrate the long-term reliability and availability of the systems proposed.
- o Each Processable Waste storage pit shall be large enough to hold a minimum of four times the daily Nampelate Capacity of the facility.
- o Each vehicle shall be weighed upon entering the site to determine the net payload of the MSW delivered.
- o On-site MSW truck traffic flow shall be designed to minimize conflicts and to allow a maximum on-site time of ten minutes for any vehicle, even during peak traffic periods.
- o Sufficient unloading bays shall be provided to meet the above stated time criteria in regard to the unloading of Processable Waste in a totally enclosed tipping area.
- o Visitor accommodations shall be provided along with the appropriate walkways, galleries, conference rooms, and control room access.
- o The Proposer shall incorporate the following checklist in the design of each facility:
  - Weighing station - automated, with one standby scale
  - No truck queuing on the ramps or public roadways
  - Cranes - minimum of two each at one hundred percent of daily facility capacity, or three each at fifty percent capacity. The crane grapples shall have the capabilities to transfer the Processable Waste quantities at these crane capacities from the storage pit to the charging hoppers.
  - Manual overrides for all systems and equipment with automatic controls
  - Maximum furnace sizes - 750 tons/day
  - Turbine-generator units - two as a minimum or one with one spare rotor provided
  - Air Pollution Control - Electrostatic Precipitators, one per process line
  - Stack(s) height - at each facility a maximum of 200 feet above final grade elevation
  - Residue removal system - each one hundred percent nominal capacity conveyor systems

- Utility interconnection - as per the requirements of the Florida Power and Light Company (FP&L)
- Fire fighting system

#### 1.2.5 Applicable Codes and Standards

The design and construction of all structures, along with all the equipment, component parts, and ancillaries, shall conform with all governmental and industry codes and standards. Without limiting the foregoing, The South Florida Building Code shall be followed, including requirements for:

- o construction classifications,
- o fire restrictive construction,
- o fire protection systems,
- o elevators.

In addition, the latest issues of the following codes and standards for construction and operation of each facility, shall be incorporated in the design.

- o American Association of State Highway and Transportation Officials (AASHTO)
- o American Institute of Steel Construction (AISC) Specifications
- o American Welding Society Code
- o Applicable codes and standards of the American National Standards Institute (ANSI)
- o American National Standards Building Code Requirements for Minimum Loads in Buildings and Other Structures (ANSI A58.1)
- o Instrument Society of America (ISA)
- o Applicable codes and standards of the American Society for Testing and Materials (ASTM)
- o Air Mixing and Conditioning Association (AMC)
- o ASHRAE Handbook and Standards
- o Tubular Exchange Manufacturers Association (TEMA)
- o American Society of Mechanical Engineers (ASME) - Boiler and Pressure Vessel Code

- o Hydraulic Institute Code (HIC)
- o Heat Exchanger Institute (HEI)
- o American Concrete Institute (ACI)
- o Steel Structures Painting Council (SSPC)
- o All Standards Promulgated by the U.S. Secretary of Labor under Occupational Safety and Health Administration (OSHA)
- o Institute of Electrical and Electronic Engineers (IEEE)
- o National Electrical Code (NEC)
- o National Electrical Manufacturers Association (NEMA)
- o National Fire Protection Association Codes (NFPA)
- o National Board of Fire Underwriting (NBFU)

In the event that any of the above codes or standards conflict with one another, the most stringent requirement shall be applied.

#### 1.2.6 Utilities

General: It is the responsibility of the Proposer to inform the County of the quantities of all utilities required by each proposed facility. The Proposer shall indicate in the proposal if there is an insufficiency in utilities supplying the sites. Off-site costs associated with providing utilities capacity (exclusive of cooling water requirements) in excess of those immediately available shall be treated as "developmental costs" to be included in the Project financing.

The design and installation of all utility connections shall be in accordance with the requirements of the utility suppliers and will be considered as part of the design of each facility.

Water: The requirements of the South Florida Water Management District shall be met, including those for permits.

It is the Proposer's responsibility to include in the proposal, details on the treatment of the water as may be required for plant operations and any pretreatment requirements for industrial wastewater. In addition, the Proposer shall include stormwater drainage plans for the resource recovery facilities and Residue/Unprocessable Waste landfills.

The water quantities and pressures required for plant processing and other purposes, including fire protection, shall be included in the Proposal. If the County cannot provide the quantities and pressures required, auxiliary sources for obtaining same shall be included in the Proposal.

The Proposer shall consider for process water the use of non-potable well water, the recycling of plant wastewater, and the potential use of plant effluent. The Proposal shall include a complete description and estimates for each auxiliary source. Compliance with all applicable codes is mandatory.

Sanitary Sewer: The Proposer shall submit in the Proposal, design data on his projected water discharges, including quantities and qualities of discharge and pretreatment, if required, i.e., characteristics as defined by the rules of the County and/or the host municipality user charge/industrial cost recovery systems. The Proposal shall also include methods to handle discharge if the present systems cannot accept it. Applicable codes and requirements of the State and the County shall be complied with.

Storm Drainage: Storm drainage for the sites shall be developed to conform to all requirements of the South Florida Water Management District (SFWMD). The Proposer shall submit calculations showing the method for determining run-offs. On site retention lakes will be required for storm drainage control.

As part of the County's permit application procedure, preliminary storm drainage plans have been developed and

submitted to the SFWMD. These plans include the use of injection well systems as a result of the limited acreage available at the project sites. Specifications for a typical injection well system are included in Appendix G of the RFP.

Storm drainage plans shall be reviewed with the County for conformance with code and other requirements of the SFWMD.

Electrical Power: Florida Power & Light (FP&L) will bring transmission power to the facility substations. Power requirements and the suggested operating compatibility for the electrical system for each facility during the construction, start-up and operation phases, and for backup, shall be provided in the Proposal. The electrical system includes the plant distribution system, the type of metering, the interconnection systems with FP&L and FP&L protection costs within the interconnection systems. The Proposer shall provide electrical power specifications to the County and shall make all arrangements for electrical service during construction and start-up through FP&L.

For utility interconnection, the design and installation shall be in accordance with the requirements and standards imposed by FP&L and shall be part of each facility. FP&L shall tie-in to electrical substations to be located within each facility site.

The mode of electrical energy distribution shall meet with the following:

- o Each turbo-generator and associated power generation equipment shall have its own bus which is to be at the same voltage level as the generator. Synchronizing and protective relays shall be provided on each generator breaker.
- o Interconnect transformers shall each be sized for the full output of the plant.
- o Complete indoor relay and control switchboards shall be provided for each facility's electric systems.



The distribution systems at each facility shall have 4.16 KV and 400 volt systems with switchgear and related accessories housed in the processing section of each of the facilities.

The electrical output of the turbine-generator sets shall operate within the interconnection system established by FP&L. The turbine-generator sets shall be capable of operating in the full condensing mode, at maximum steam flow, even on the hottest day of the year, and still provide an efficient and adequate quantity of electrical energy.

In addition, payment to FP&L shall be required for interconnection and protection costs associated with the northern and southern facility electrical interconnections, and for the following additional costs:

- o Monthly telephone company charge for FP&L dispatcher communication channel, which has been estimated by FP&L at \$175 per month at each site.
- o Maintenance and operation fee to FP&L for interconnections facilities.
- o Metering costs.
- o Suitable arrangements for termination of FP&L lines. The service points may be adjusted if desirable to provide suitable line terminations.
- o Suitable right-of-ways and easements both on and off the sites for the transmission lines. Thirty-six foot minimum width, accessible easements are required. The right-of-ways must be cleared and finished to adequate grade. Costs of fees and permits, if applicable, shall also be paid.

#### 1.2.7 Site Utilities

This subsection provides information on available utility service for the Route 441 and Copans Road Sites. However, it is the responsibility of the Proposer to verify and supplement this information where necessary.

##### Route 441 Site

Figure A-1 illustrates the known utility locations adjacent to the Route 441 site. The electrical interconnection proposed by FP&L is shown in Figure B-2.

FIGURE B-1

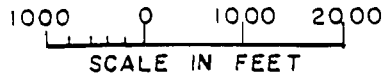
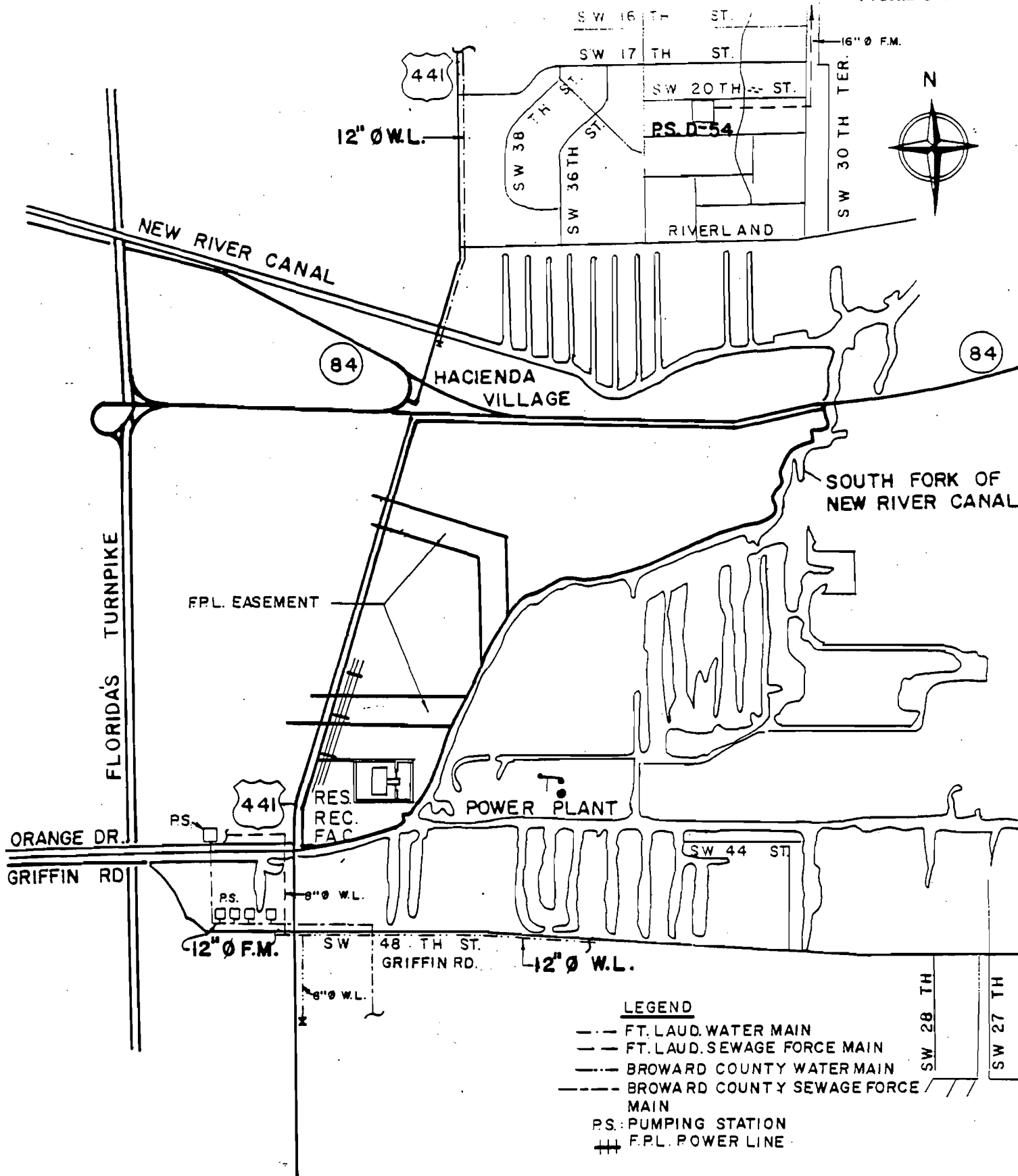

**LEGEND**

- FT. LAUD. WATER MAIN
- FT. LAUD. SEWAGE FORCE MAIN
- BROWARD COUNTY WATER MAIN
- BROWARD COUNTY SEWAGE FORCE MAIN
- PS: PUMPING STATION
- ++ F.P.L. POWER LINE

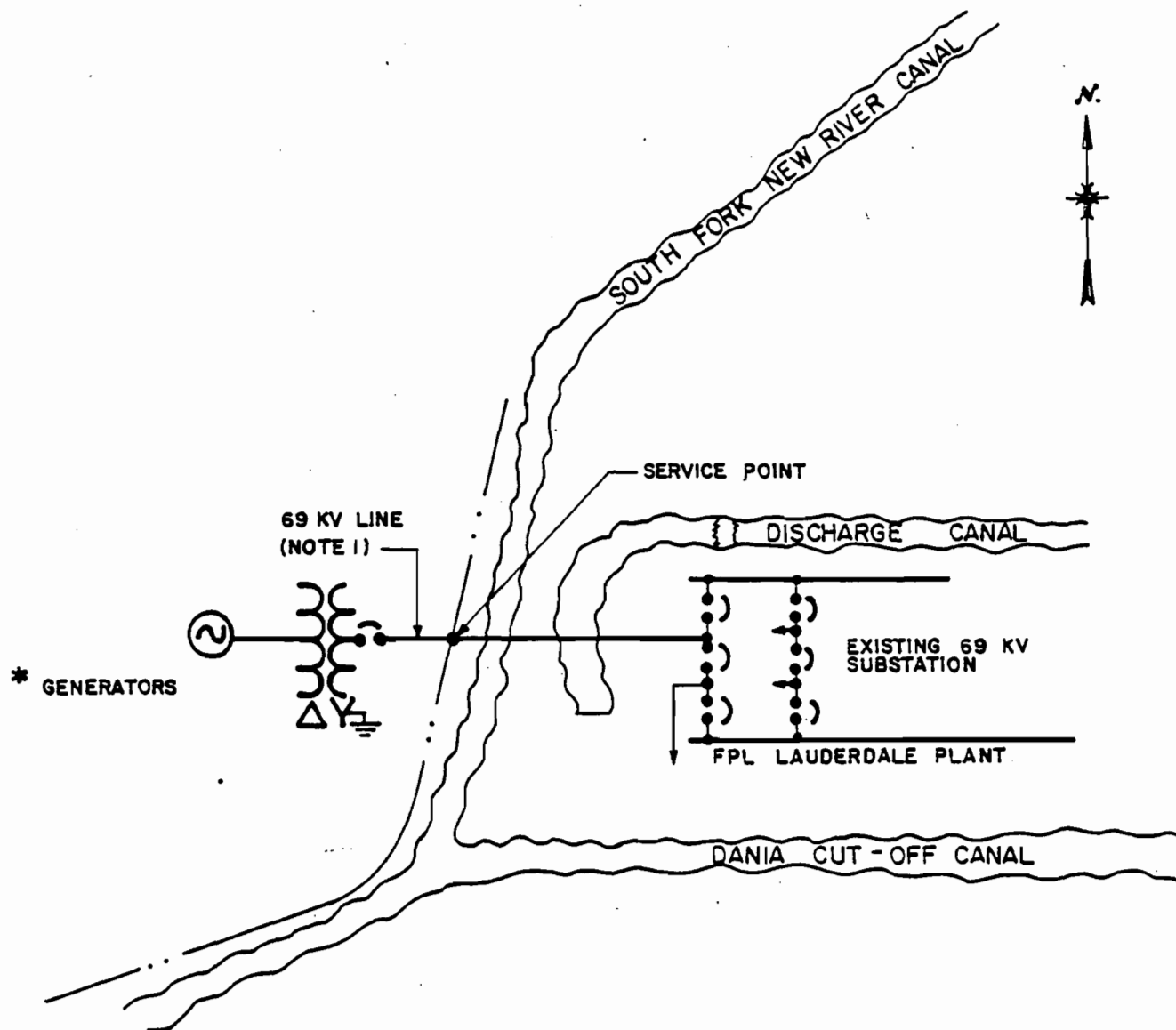

\* GENERATORS

\* GROSS OUTPUT MAY BE SUPPLIED BY TWO GENERATORS

NOTE 1

PROVIDE FOR FUTURE CONVERSION FROM 69 TO 138 KV

Electric Service: For the southern facility, FP&L indicates that a 69 KV transmission line will be extended westwardly across the South Fork New River Canal from FP&L's Lauderdale Power Plant Substation to the southern site's substation. The routing of this line will require coordination in the development of the resource recovery plant. The facilities at the southern sites should be designed to facilitate future conversion of the 69 KV service voltage to 138 KV.

Florida Power and Light has developed an inter-connection cost estimate, including modifications to offsite substations and transmission lines, for the southern site. This estimate, based on the above assumptions is \$300,000 which does not include the cost of the transformer, circuit breaker or protective equipment installed at the site.

The above cost, in current dollars, should be regarded as a budget estimate to provide feasibility guidance. Since the Project will pay on the basis of actual cost including appropriate overheads, rather than estimated cost, the estimates must be reviewed when specific designs become available.

Water Service: Water, exclusive of cooling water requirements, can potentially be provided by Broward County or the City of Fort Lauderdale. Broward County has an existing 12-inch diameter water main, which runs east-west along Griffin Road south of the project site. An 8-inch line extends north from that main to a point adjacent to the resource recovery facility site. Water quality data for the County water plant that would provide service to the southern site is provided in Table B-1. Preliminary information from the County indicates that approximately 100 gpm of water from the County water system may be available to this site.

Service by the City of Fort Lauderdale would require a main extension from the New River Canal, Route 441

TABLE B-1  
 1982 AVERAGE ANNUAL WATER QUALITY VALUES FOR  
 THE BROWARD COUNTY SYSTEM 3-A PLANT

<u>Analytical Results</u>	<u>Raw Water</u>	<u>Finished Water</u>
Water pH at the Plant	7.25 units	8.75 units
Water pH at the Field	-	8.50 units
Water Color at the Plant	63 CU	12.0 CU
Water Color at the Field	-	12.8 CU
Water Odor No. Dilutions	3 DIL	-
Water Turbidity	-	0.41 BTU
Water Free Carbon Dioxide	21 mg/l	0 mg/l
Calcium Hardness as CaCO <sub>3</sub>	209 mg/l	63 mg/l
Magnesium Hardness as CaCO <sub>3</sub>	18 mg/l	14 mg/l
Total Hardness as CaCO <sub>3</sub>	227 mg/l	77 mg/l
Total Mo. Alk. as CaCO <sub>3</sub>	198 mg/l	26 mg/l
Non Carbonate Hardness as CaCO <sub>3</sub>	29 mg/l	51 mg/l
Calcium as Ca <sup>+2</sup>	83.6 mg/l	25 mg/l
Magnesium as MG <sup>+2</sup>	4.4 mg/l	3.4 mg/l
Iron as Fe <sup>+2</sup>	1.67 mg/l	0.03 mg/l
Sodium as Na <sup>+1</sup>	23.2 mg/l	23.8 mg/l
Bicarbonate as HCO <sub>3</sub> <sup>-1</sup>	242 mg/l	31.7 mg/l
Chloride as Cl <sup>-1</sup>	35 mg/l	52.4 mg/l
Sulfate as SO <sub>4</sub> <sup>+2</sup>	17.0 mg/l	18.0 mg/l
Fluoride as F <sup>-1</sup>	0.19 mg/l	0.88 mg/l
Total Dissolved Solids	408 mg/l	173 mg/l
Total Res. Chlorine	-	2.9 mg/l
Total Free Chlorine	-	2.5 mg/l
Total Comb Chlorine	-	0.4 mg/l
Saturation Index	+0.00	+0.14 mg/l

intersection south to the site. This extension will necessitate crossing Route 84 and the proposed I-595 interchange. Preliminary information from the City of Fort Lauderdale indicates that approximately 100 gpm of water may be available from the City's Peele Water Plant. Water quality data for this plant is provided in Table B-2.

Sewer Service: As with water, sewer service can potentially be provided by either Broward County or the City of Fort Lauderdale.

The Broward County system consists of small submersible pump stations discharging through a 6-inch diameter force main located on Griffin Road. The possibility that increased flow through the Broward County system will significantly affect hydraulic conditions must be addressed.

The City of Fort Lauderdale operates pumping station D-54 on S.W. 20th Street to the north of the project site. This is a large station which would probably not be affected by increased flow from the resource recovery facility. However, the piping required to meet the City system must pass across Route 84 and proposed I-595.

#### Copans Road Site

Figure B-3 illustrates the location of known utilities, adjacent to the Copans Road Site. The electrical tie-in proposed by FP&L is shown in Figure B-4.

Electric Service: For the northern facility, FP&L indicates that a 138 KV overhead transmission line will be brought to the eastern side of the site. This pole line will enter the northern site at approximately the northeast corner and extend southward along the east property line to the northern site's substation.

Based on the above assumptions, Florida Power and Light has estimated the interconnection costs for this site, including modifications to offsite substations and transmission lines at \$800,000. This estimate does not include the

TABLE B-2

1982 AVERAGE ANNUAL WATER QUALITY VALUES FOR  
THE CITY OF FORT LAUDERDALE'S

WALTER E. PEELE PLANT

<u>Analytical Results</u>	<u>Raw Water</u>	<u>Finished Water</u>
Water, pH	6.9 units	9.1 units
Water Color	3.65 CU	5.25 CU
Turbidity, NTUO	-	0.36
P Alkalinity	-	8.5 mg/l
M Alkalinity	-	39.7 mg/l
Total Mo. Alkalinity	224 mg/l	-
Calcium hardness as CaCO <sub>3</sub>	254 mg/l	81 mg/l
Total Hardness as CaCO <sub>3</sub>	165 mg/l	90.5 mg/l
CO <sub>2</sub> Calcium	54 mg/l	-
Iron as FE	1.85 mg/l	0.11 mg/l
Chlorides as Cl <sup>-1</sup>	42 mg/l	53.7 mg/l
Residual Chlorine	-	2.5/3.4

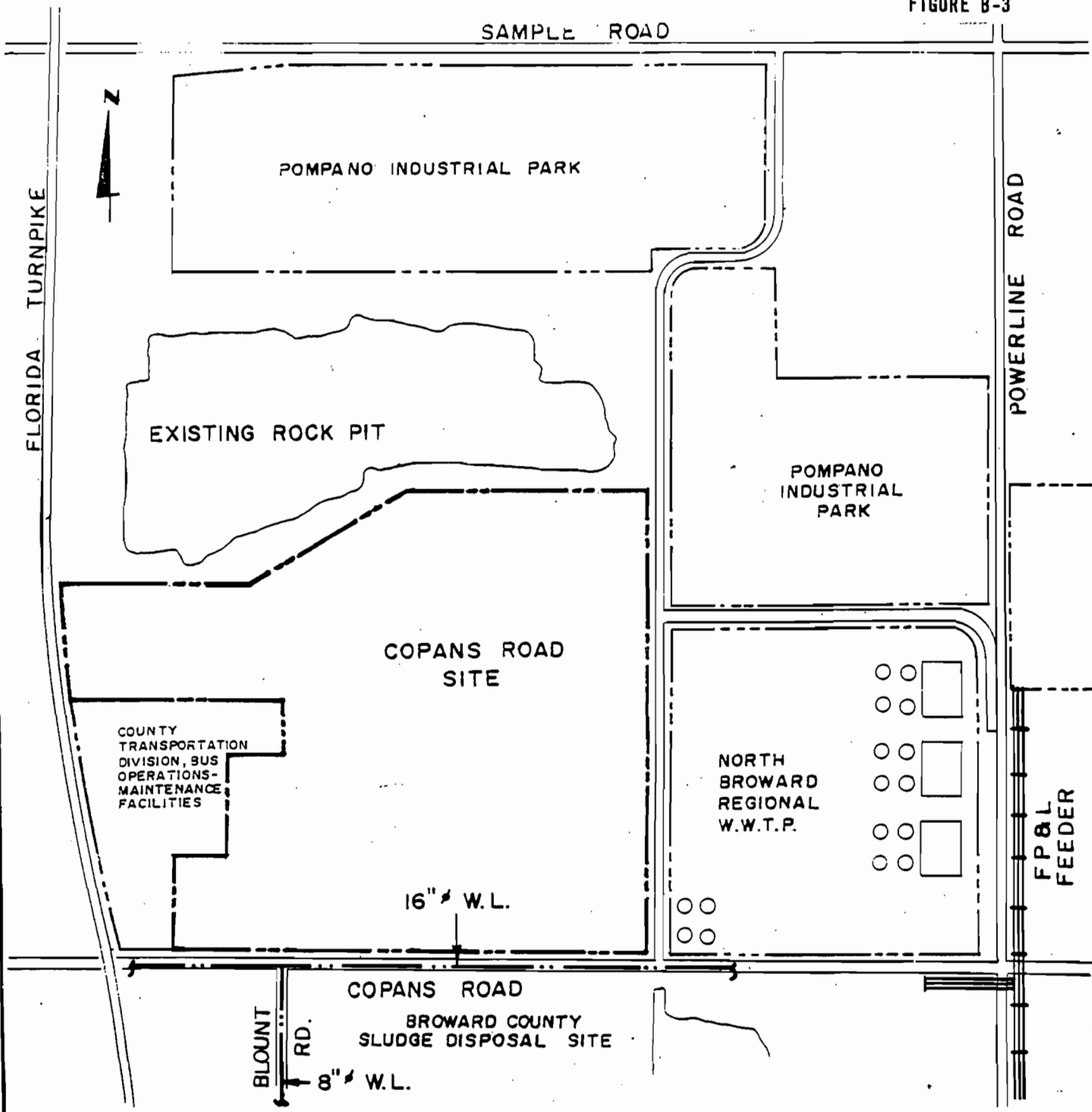

FLORIDA TURNPIKE

SAMPLE ROAD



POMPANO INDUSTRIAL PARK

EXISTING ROCK PIT

COPANS ROAD SITE

COUNTY TRANSPORTATION DIVISION, BUS OPERATIONS-MAINTENANCE FACILITIES

POMPANO INDUSTRIAL PARK

NORTH BROWARD REGIONAL W.W.T.P.

16" W.L.

COPANS ROAD

BROWARD COUNTY SLUDGE DISPOSAL SITE

BLOUNT RD.

8" W.L.

POWERLINE ROAD

FP&L FEEDER

LEGEND

||| FP&L POWER LINE

— — — BROWARD COUNTY WATER MAIN

— · — · — PROJECT BOUNDARY

NOTE: NOT TO SCALE

BROWARD COUNTY RESOURCE RECOVERY

UTILITY LOCATIONS ADJACENT TO THE COPANS ROAD SITE



FIGURE B-4



FLORIDA TURNPIKE

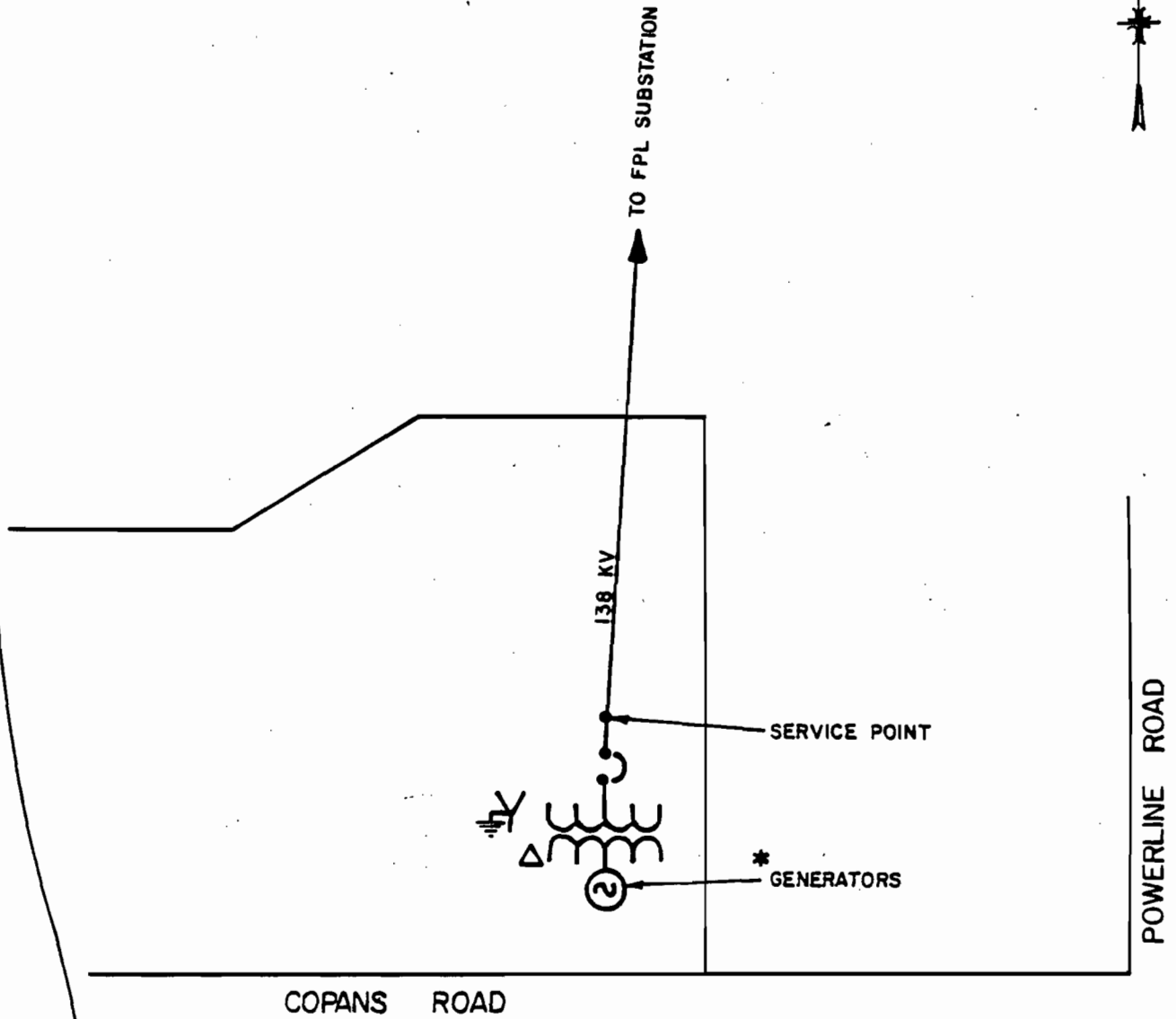

\* GROSS OUTPUT MAY BE SUPPLIED BY TWO GENERATORS.

cost of the transformer, circuit breaker, or protective equipment necessary to be installed at the facility.

The Contractor would be responsible for installation and operation of the step down transformers, interfacing circuit breakers and protective equipment.

The preceding cost, in mid 1983 dollars, should be regarded as a budget estimate to provide feasibility guidance. Since the Project will pay on the basis of actual cost including appropriate overheads, rather than estimated cost, the estimates must be reviewed when specific designs become available.

Water Service: Water, exclusive of cooling water requirements, may be provided from the Broward County water distribution system. Preliminary discussions with the County indicate that approximately 100 gpm of water may be available from the County water system to this site. Water quality data for the County water plant that would provide to the northern site is provided in Table B-3.

Sewer Service: The Copans Road site is located immediately west of the North District Regional Wastewater Treatment Plant which can provide sewer service to the resource recovery facility. Broward County owns and operates this plant.

TABLE B-3  
 1982 AVERAGE ANNUAL WATER QUALITY VALUES FOR  
 THE BROWARD COUNTY SYSTEM 1-A PLANT

<u>Analytical Results</u>	<u>Raw Water</u>	<u>Finished Water</u>
Water pH at the Plant	7.2 units	8.9 units
Water pH at the Field	-	8.6 units
Water Color at the Plant	82 CU	10.75 CU
Water Color at the Field	-	11.5 CU
Water Odor No. Dilutions	3.0 DIL	-
Water Turbidity	-	0.40 BTU
Water Free Carbon Dioxide	27 mg/l	0
Calcium Hardness as CaCO <sub>3</sub>	235 mg/l	70 mg/l
Magnesium Hardness as CaCO <sub>3</sub>	18 mg/l	9 mg/l
Total Hardness as CaCO <sub>3</sub>	253 mg/l	79 mg/l
Total Mo. Alkalinity as CaCO <sub>3</sub>	227 mg/l	29 mg/l
Non Carbonate Hardness as CaCO <sub>3</sub>	26 mg/l	50 mg/l
Calcium as Ca <sup>+2</sup>	94 mg/l	28 mg/l
Magnesium as MG <sup>+2</sup>	4.38 mg/l	2.2 mg/l
Iron as Fe <sup>+2</sup>	1.42 mg/l	0.03 mg/l
Sodium as Na <sup>+1</sup>	32.6 mg/l	32.8 mg/l
Bicarbonate as HCO <sub>3</sub> <sup>-1</sup>	277 mg/l	35.4 mg/l
Chloride as Cl <sup>-1</sup>	57 mg/l	82.0 mg/l
Sulfate as SO <sub>4</sub> <sup>+2</sup>	14 mg/l	14.0 mg/l
Fluoride as F <sup>-1</sup>	0.14 mg/l	0.85 mg/l
Total Dissolved Solids	406 mg/l	275 mg/l
Total Res. Chlorine	-	4.1 mg/l
Total Free Chlorine	-	3.3 mg/l
Total Comb Chlorine	-	0.8 mg/l
Saturation Index	+0.06	+0.37 mg/l

### 1.3 Site Work

#### 1.3.1 Subsurface Investigation

Data and information pertaining to the subsurface conditions at the southern site are provided in Appendix A of the "Route 441 Site Environmental Review Form Summary and Report" dated July, 1983. The Camp, Dresser, McKee report entitled "The Solid Residuals Disposal: Phase I Design" dated May 1980 and prepared for the Broward County Department of Utilities, Division of Water and Wastewater, contains information concerning subsurface conditions for an area adjacent to the northern site. Copies of these documents are available at the Office of the Project Administrator.

In addition, the County will conduct subsurface investigations at the northern and southern sites. These investigations will include a boring program at each site and subsequent laboratory testing. The subsurface data will be compiled into a report-type format which will be made available during the vendor selection process.

This data will be supplied for informational purposes only. The Contractor must assure itself that subsurface conditions are compatible with its facilities.

#### 1.3.2 Survey

The Contractor shall furnish all labor, materials, tools, equipment, to perform all work and services necessary for or incidental to the performance and completion of survey work necessary for the construction of site work, buildings, new utilities, and other new facilities and establish and maintain bench marks, make measurements to verify location of completed construction, and survey alignment to existing property boundaries.

The following conditions shall be followed in making the above described survey:

- o A survey shall be made to establish the property site lines.

- o Copies of all the County's survey information will be made available at Contractor's expense.
- o The Contractor shall not disturb existing benchmarks or property line monuments. Work necessary to replace stakes and monuments as directed by the County shall be at the Contractor's expense.

### 1.3.3 Clearing, Grubbing and Site Preparation

Underground Void Areas: Such as tanks, cisterns, tunnels, or the like shall be removed or filled according to all pertinent codes and regulations.

Shoring: All temporary shoring required to support existing work, and adjacent areas and work shall be furnished and installed to prevent settlement or other damage to surrounding areas and structures and shall be provided with adequate means to compensate for any settlement in the shoring supports.

Debris: All materials removed shall become the property of the Contractor and shall be removed from the premises and disposed of by the Contractor.

Maintenance: All access roadways used by the Contractor shall be maintained in serviceable condition. The Contractor shall keep the surfaces of these roadways free from mounds, depressions and obstructions which might present a hazard or annoyance to traffic.

Signs, Signals and Barricades: All signs, signals and barricades shall be provided by the Contractor and shall meet or exceed all OSHA regulations for accident prevention.

Dust Control: The Contractor shall be responsible for all dust control at the site. The Contractor shall prevent the spread of dust during his operations. Moistening all surfaces with water or applying calcium chloride shall be used to prevent dust from becoming a nuisance to the public and neighbors. Contractor shall furnish all labor and equipment necessary for dust control including but not limited to tank trucks, hoses, calcium chloride spreaders, etc.

Burning: On-site burning shall not permitted.

Vermin and Rodent Control: During the course of construction and operation, a constant control of vermin and rodents shall be maintained by the Contractor. If necessary, the Contractor shall employ the services of a professional exterminator.

Explosives: The use of explosives shall at all times be in conformance with the conditions set forth in Section 3.5 of the RFP.

Disconnection of Utilities: Before starting site operations, the Contractor shall disconnect or arrange for the disconnection of all utility services required to be removed, performing all such work in accordance with the requirements of the utility company or agency involved.

Grubbing: The Contractor shall remove all surface rocks and all stumps, roots and other vegetation within the limits of construction.

Dewatering: The Contractor shall be responsible for performing all necessary site dewatering.

Site Drainage: The Contractor shall be responsible to install and maintain adequate drainage and prevent soil erosion at the site during construction.

#### 1.3.4 Excavation, Filling, and Backfilling

The Contractor shall be responsible for furnishing all supervision, labor, tools, materials and equipment and performing all operations in connection with excavation of all materials regardless of character of material, and obtain fill and backfill material approved by a qualified soil engineer to produce final grade lines. All necessary arrangements for obtaining fill material and topsoil from off-site borrow areas shall be the responsibility of the Contractor.

The Contractor shall remove from the site all rubbish and debris found thereon to prepare the site for excavation.

The Contractor shall perform the required excavation of whatever materials encountered, as necessary for the construction of the Project.

Excavation for footings shall be made sufficiently wide for the installation of form work and to the depths required.

The Contractor shall prevent the foundation area from becoming unstabilized by the flow of water into the excavation or by cave-ins.

Deleterious soil not suitable for sustaining design loads must be removed entirely and controlled fill shall be placed in its stead. In areas other than under buildings unsuitable soil shall be removed to the depth required to sustain traffic loads with controlled fill placed in the area.

The Contractor's quality of work including excavation, fill, backfilling, dewatering, subgrade preparation and stabilization, shoring, drainage, for protection shall comply with soils engineer recommendations, the applicable American Society for Testing and Materials (ASTM) standards, and the Florida State Department of Transportation.

All existing utility lines, drains or other structures which are encountered or which are uncovered by excavation shall be carefully supported and protected from injury by the Contractor, and if damaged shall be restored by the Contractor at his expense to the same condition in which they were found.

Surplus excavated material over and above that required for backfilling shall be placed by the Contractor at points on the property consistent with the Contractor's landscaping plan.

Before backfilling, all excavated areas to be backfilled shall be cleared of all building rubbish, wood, lumber and dismantled from work, etc.

Backfill shall consist of suitable clean soil.

Backfill shall not be placed against walls until they have attained sufficient strength to withstand the pressure of the fill material safely.

### 1.3.5 Easements and Setbacks

Existing easements at the sites, such as those held by FP&L and as indicated on the site drawings in this RFP, must be observed and honored unless specific exceptions are obtained from the easement holder.

A discussion of the required buffer areas for the northern site is provided in Section 4 of the zoning ordinance for the Copans Road Site, while the Zoning and Land Use Section of the "Route 441 Site Environmental Review Form Summary and Report" dated July, 1983 contains information pertaining to setbacks and buffer areas for the southern site.

### 1.3.6 Site Maintenance

The Contractor shall be responsible for the maintenance of the sites. Maintenance shall include all watering, weeding, clean-up, repair of washouts, repairs to fences and all other necessary work associated with site maintenance.

The Contractor shall clean-up and remove from the site all rubbish and materials as they accumulate and shall not permit them to be scattered about the site. If the Contractor fails to attend to this clean-up promptly and satisfactorily, the County shall have the right to employ others for the work and charge the cost to the Contractor.

## 1.4 Architectural

### 1.4.1 Functional

General: The Proposer shall be responsible for developing site layouts which will meet all functional design requirements to provide for efficient operation of each facility.

Plans for each facility shall include an architectural program for all functional areas of the facility, identifying the designated use and capacity of these areas. Concepts for interior design and furnishings shall also be provided. An interior circulation plan shall be designed for efficient



movement and functional operation of equipment and control by the crews of each facility. Personnel facilities should be placed in a central location to minimize walking distances.

Each complete facility, including buildings required to house process equipment and administrative functions, public areas, ancillary buildings, infrastructure such as roadways, parking areas and landscaping, shall be designed and constructed to meet all functional requirements of the Project. Each facility shall be designed and constructed of quality materials to ensure that with proper maintenance and repair the facility will remain in good condition both functionally and visually over the operating period. The selection of exterior materials should be made from the standpoint of durability, weather-resistance and easy maintenance.

The proposal shall include necessary systems for heating, ventilation, air conditioning, plumbing, lighting and power distribution, communication, fire protection, and provision for the handicapped in visitor and administrative office areas to facilitate proper operation of the process equipment and provide essential comfort for the personnel.

Each facility shall include all of the necessary equipment and their enclosures and conform to all applicable Federal, State and local codes.

Each facility shall be designed to facilitate repair and maintenance of process equipment by providing adequate space around and between equipment items.

Main Process Buildings: Each main process building shall house the refuse receiving and handling area, refuse storage area, water and waste handling systems, control room, machine shop and locker rooms. In addition, each main process building shall house an employee area, maintenance and storage areas, laboratory and the first aid center. The turbine-generator sets may be installed outdoors or may be housed within the main process building.

Exterior walls shall be durable, as well as providing noise abatement, and easily maintainable. Natural light shall be utilized throughout the main process buildings to the maximum extent possible.

Material that is easily cleaned, damage resistant against various maintenance activities, and tolerant of adverse conditions created by high humidity and equipment operation (e.g., vibration) shall be selected for the interior walls and partitions. Access stairs, ladders, platforms and elevators shall be provided in accordance with applicable sections of OSHA.

Administrative Office Spaces and Employee Areas: At each facility the administrative offices may be incorporated within the main process building or housed in a separate building. Each facility shall include suitable office space and furnishings to accommodate the facility staff and County representatives.

Conference rooms, a visitor reception area, employee locker room(s) with toilets, an employee lunch room, and toilets for staff and visitors shall also be provided at each facility. These spaces shall be furnished with all customary furniture and equipment.

Visitor Accommodations: Each facility shall provide for occasional visitors, both singly and in groups, and for on-site public educational programs.

In addition, controlled visitor viewing locations, in various process areas of each facility, shall be provided. These viewing spaces shall not be directly exposed to operating equipment to assure the safety of the public. Elevators shall be provided to facilitate visitor access and movement to all levels of each facility.

Maintenance and Storage: Each facility shall include a maintenance and machine shop and adequate storage for spare parts, equipment and rolling stock, sufficient to

provide for a regular program of maintenance for all facility buildings and grounds.

The Contractor shall furnish equipment for the machine shop as part of each facility.

Each facility shall have storage spaces for all mobile vehicular equipment necessary to operate the facility and associated landfills. An enclosed vehicular garage/repair shop shall be provided at each facility.

Scale Houses: Each facility shall have a scale house as a separate building. Each shall contain, in addition to the weighing equipment, provisions for an office for the operator with the necessary furnishings and an area with toilets for truck drivers. Adequate lighting, heating, ventilating and air conditioning shall be provided. A security office shall also be located within each scale house.

Waste Sampling Areas: The enclosed tipping floors at each facility shall have provisions for use of an area on the floors for Processable Waste sampling on a selective or as-needed basis. Vehicular access shall be provided to the sampling areas. Ample space shall be provided to permit waste to be transferred from the receiving areas into a 1-cubic yard box using a small front end loader. These sampling spaces may be routinely used for other purposes and made available for test work on a coordinated basis.

Residue Handling Areas: The residue handling areas shall be enclosed to minimize the aesthetic impact of this operation, control the emission of noise and odor and to conceal the activities from the view of the public.

Laboratory: The facility shall include a fully equipped laboratory to conduct all routine testing of steam and feedwater. The detailed design of the laboratory shall be the responsibility of the Proposer.

First Aid Centers: The Proposer shall provide an area for a fully equipped First Aid Center within each facility.

Access Roads and Ramps: The access roads and/or ramps shall be designed to achieve the greatest efficiency, to minimize the use of space, to minimize the interaction of trucks with staff and visitor vehicles, and to prevent the queuing of trucks on ramps and public roadways.

Road System: The road systems shall include all roadways within the facilities. There shall be at a minimum at each facility a road from:

- (1) The entrance and the exit to:
  - o The weighing station
  - o The main plant building
  - o All auxiliary facilities
  
- (2) The weighing station to and from:
  - o The tipping area (truck ramp shall be constructed with a slope not to exceed five percent
  
  - o The ash handling area
  
  - o The residue/unprocessable waste landfill,
  
- (3) The main plant building to and from:
  - o All auxiliary facilities

Road Geometric Design: There shall be a minimum of two lanes for each traffic direction, one of which shall be a shoulder for breakdowns and traffic by-pass. The width of each lane shall be as a minimum the size of lane as per construction codes of the American Association of State Highway and Transportation Officials for street width for trucks. The radius or curvature of any roadway shall also be not less than the minimum curvature suggested by the same construction codes.

Road Drainage: Paved roads and surfaces shall be pitched so as to adequately drain all storm waters to drainage ditches or to catch basins connected to a subsurface drainage system.

Site Walkways: All walkways shall conform to applicable State and County requirements and the appropriate codes and standards. In addition, all walkways shall be adequately lighted, maintained and have provisions for the handicapped.

Site Outdoor Lighting: Sufficient outdoor lighting of roads, walkways and parking areas shall be provided to insure the safety and security of the operation of each facility, the safe movement of people and vehicles, and for security purposes.

Facility buildings shall be suitably illuminated to present the facility to the public.

Primary lighting shall be provided for the main roadways from each facility to the street gates; the gate house, if any; the refuse vehicle weighing areas (scale house); employees' parking lot; electrical substation; and pedestrian walkways. Primary lighting shall generally be of higher intensity than secondary lighting and shall utilize fixtures and post equipment of superior aesthetic and structural quality. Exterior light poles and fixtures shall be metal and shall be contemporary in design.

Secondary lighting shall cover areas where activity is more intermittent and, therefore, requires less intense lighting. These activities include storage areas, process water wells, outdoor tanks, service truck parking, residue and ash storage, etc. Special process equipment lighting shall also be provided to assure safe access and work illumination. Stacks shall be obstruction lighted in accordance with Federal Aviation Authority (FAA) regulations. All outdoor signs shall be illuminated.

Signage: Well-designed graphics should be used for directional and identification signing. These signs shall be properly located to achieve their purpose without constituting a hazard to vehicles or pedestrians.

Clear, concise graphic design of all directional and identification signs shall be incorporated into the design of each facility, in accordance with County standards and applicable codes of the County.

Erosion Control/Seeding and Planting: The Contractor shall establish an erosion control plan consistent with the State of Florida and Broward County erosion and sediment control requirements.

The Contractor shall establish grass and plant trees and shrubs in accordance with the Landscaping Plan as approved by the County.

Landscaping: Landscaping of each facility site will be used to control or screen views from adjacent roads.

Trees, shrubs, ground cover, planting, sculpture and use of building and paving materials, shall be integrated into the building arrangement, topography, parking and screening requirements.

Fencing, evergreens, shrubs, or bushes (or combinations), shall be located on the site perimeter to minimize the effect of vehicle headlights, noise, outdoor lighting glare and reflection, movements of people and vehicles, and to shield the site activities from adjacent properties where necessary.

Adequate landscaping shall be required to provide maximum screening for the sites. The landscaping plans shall address the following items:

- o Earth sculpturing to provide topographic relief and to aid in screening such areas as parking lots and blank walls.
- o Appropriate street tree plantings along access roads to the site.
- o Extensive use of plants indigenous to Florida to provide visual screening and local color.
- o Plantings to enhance the main entrance to each facility.

- o Appropriate plantings around employee outdoor sitting areas.
- o Preparation of soil stabilization plans for use during construction which utilizes plants and grass as stabilizers.

The selection of plant species should be based upon those plants which are tolerant of local conditions. Indigenous vegetation should be included in appropriate areas of the site. Planter boxes should be kept to a minimum. Lawn areas should be kept to a minimum with hardy ground covers utilized wherever possible. Top soil shall be provided in all planting areas and all plant pits.

A detailed landscaping plan for each facility site is a proposal requirement. Special attention in the plan should be given to the entrance and the visitors' area, as well as the view of each facility from the public streets serving it and/or from adjacent highways.

#### 1.4.2 Detailed Architectural Requirements

Masonry: In addition to complying with all pertinent codes and regulations, the Contractor shall comply with the standards of masonry installation described in "Concrete Block Masonry Inspectors Manual" published by the Technical Committee of the California Concrete Masonry Manufacturers Association.

Concrete Curbing: All curbs shall be constructed of concrete with suitable expansion joints. The Contractor's quality of work shall conform to the requirements of the Florida State Department of Transportation, American Concrete Institute and the American Society for Testing Materials (ASTM).

Carpentry and Mill Work: Lumber, herein referred to, shall conform with the American Lumber Standard, Simplified Practice Recommendations, latest edition. Lumber shall conform to and bear the grade and trade mark for the Association under whose rules it is produced.

Wall Panels: Wall construction shall be fabricated and installed to withstand 100 MPH wind.

Wall panels shall satisfy the following requirements:

ASTM B-117 - Salt Fog Test  
ASTM D-968 - Abrasion Resistance Test  
Kesternich Pollution Resistance Test  
ASTM D-2247 - Humidity Resistance Test  
Color Variance - Not more than 0.5 NBS units

Ceramic Tile: All ceramic tile shall be quality certified by the Tile Council of America Inc. Floor tile shall have abrasive surface. Wall tile shall be glazed surface.

All tile work shall be set in accordance with the "Tile Handbook" superseding the Basic Specifications for Tile Work K-300.

Acoustical Tile Ceilings: Acoustical tile panels shall meet ASTM C523 for light reflectance and Underwriters Laboratories Noncombustible Class 25.

Insulation and Lagging (for Exterior Mechanical Equipment): The Contractor shall furnish and install insulation and lagging for the following equipment: furnaces, boilers, precipitators and inlet ducts and nozzles, precipitators and outlet nozzles, breechings and ducts, I.D. fans and I.D. fan outlet ducts to stack, precipitator hoppers and conveyors.

The exterior lagging shall consist of flat overlapping square panels with cross-brake pattern.

The lagging shall be fastened with non-corrosive studs or clips. Closure strips, flashing and counterflashing of the same thickness as the panels shall be provided as required.

All laps of lagging, flashing and openings which cannot be made waterproof with closure strips shall be filled with high temperatures caulking compound (I-C 405) or equal, so as to render the entire lagging system weathertight.



Any additional stiffeners, corner angles, clips and other fastening and supporting devices shall be supplied as an integral part of the lagging system.

Dissimilar metals shall be insulated from one another by means of dissimilar metals separators or suitable primer and aluminum paint methods in accordance with siding manufacturer's recommendations, subject to approval of the County.

Each precipitator roof shall be adequately insulated. The roof shall be sloped to prevent rain water accumulation and shall be completely weatherproof. The insulation shall be protected by sheet metal panels, supported on purlins and designed for at least a 50 pounds per square foot live load.

Painting: Painting shall include but not be limited to the following items:

- o Structural steel shapes and members
- o Ferrous metal furnace castings and supports
- o Electrical motors
- o Cranes
- o Charging hoppers, chute extension, refuse chutes and gates
- o Combustion air fans and ductwork
- o Stokers and siftings chutes
- o Furnace access doors and ports; boiler doors and appurtenances
- o Conveyors, flap gates, discharge chutes, drives
- o Boiler structures and supports
- o Precipitator, breechings, ductwork and I.D. fan structures
- o Stack and appurtenances

- o Scale and enclosures
- o Transport equipment
- o All pipework, fittings, valves and supports
- o Tanks, strainers, deaerator, steam piping, valves and pumps
- o Conduit, panel boxes, pull boxes, meter boards and distribution boxes
- o Partitions, doors, frames, stairs, railings, ladders, grilles, registers, air diffusers, and underside of exposed metal decking
- o Wood staining of wood doors, trim, paneling, millwork and wood shelving
- o Stripping of on-site road and parking lots

Galvanizing: Galvanizing shall be done by the hot dip process in accordance with the specifications of the AHDGA.

Fencing and Gates: It is the Contractor's responsibility to provide fencing along the entire perimeter of the project sites and to provide site security. Security fencing and gate controls shall be made attractive.

## 1.5 Structural

### 1.5.1 Structures Supporting Vehicular Traffic

The design, loadings, materials, allowable stresses, fabrication and construction of structures subject to vehicular traffic such as roads, ramps, underpasses, tunnels, culverts, elevated roadways and framed slabs shall conform to the current standard specifications of the American Association of State Highway and Transportation Officials (AASHTO), including all interim specifications of AASHTO, and all applicable design requirements of the County and the State.

### 1.5.2 Structural Steel

General Requirements: The current rules and practices set forth in the "Code of Standard Practice for Steel Buildings and Bridges" and the "Specification for the Design, Fabrication and Erection of Structural Steel for Buildings" of the American Institute of Steel Construction (AISC) shall apply to the work performed.

Quality Criteria and Inspection Standards shall conform to the AISC publication "Quality Criteria and Inspection Standards" latest edition.

Materials: Structural steel shall conform to ASTM A 36. High strength bolts, with suitable nuts and washers, shall conform to ASTM A 325. Welding electrodes shall conform to AWS Code D1.1. Stud shear connectors shall conform to AWS Code D.1. The following list indicates the minimum requirements for specific steel items:

Mild Steel Plates: Special Shapes for structural quality - ASTM-A27.

Steel Sheets: Structural quality - ASTM A 245.

Steel Plate: ASTM A 120, fittings for steel pipe shall be standard malleable iron.

Bar Steel: Hot rolled including rounds and squares of all sizes, and flat 6 inches or less in width.

Fabrication: Fabrication shall be in accordance with the applicable provisions of the AISC Specification for the Design, Fabrication, and Erection of Structural Steel for Buildings.

Connections: Standard type connections shall comply with the appropriate tables entitled "Framed Beam Connections" of the AISC "Manual of Steel Construction" and shall be used wherever possible to employ such connections.

Bolting: Assembly of structural joints using high strength steel bolts shall be in accordance with the RCRBSJ Specification for "structural joints using ASTM A325 or A490 bolts."

Welding: Welding of structural steel work and study shear connectors shall be in accordance with AWS Code D1.1.

Shop and field welding shall be performed only by certified welders qualified in accordance with AWS Code D1.1.

Field Erection: All members shall be aligned, leveled, and adjusted accurately prior to final fastening. Tolerances shall conform to the AISC "Code of Standard Practice".

#### 1.5.3 Metal Roof Deck

Materials: Design and fabrication of metal roof deck shall be in accordance with the latest specifications of the Steel Deck Institute. Steel used in the fabrication of deck units shall conform to the requirements of the AISI "Light Gage Cold-Formed Steel Design Manual".

Field Erection: The complete metal deck, including all shaping, cutting, fitting, drilling, welding, accessories, closures, sump pans, fastenings and all other miscellaneous pieces necessary, shall be properly installed with weathertight construction. Metal deck shall be erected in accordance with the deck manufacturer's instructions.

Welding and Fastening: Welding shall be in accordance with the requirements of the AISI "Specifications for the Design of Cold-Formed Steel Structural Members" and the AWS "Structural Welding Code".

#### 1.5.4 Miscellaneous Metals

Miscellaneous metals shall include such items as:

- o Gratings (aluminum, fiberglass and galvanized steel)
- o Metal Floor Plates
- o Railings
- o Loose Lintels and Miscellaneous Framing
- o Ladders

Galvanizing of miscellaneous metal after fabrication shall be in conformance with ASTM A-123 and A-153. Cadmium

plating of miscellaneous metals shall be in accordance with ASTM A-165, Type TS.

Specific requirements for miscellaneous metals include the following:

Grating: Grating shall conform to the following standards:

- o ASTM A-123, zinc (hot-galvanized) coatings on products fabricated from rolled, pressed, and forged steel shapes, plates, bars and strip.
- o ASTM A-385, high quality zinc coatings (hot-dip) on assembled products.
- o ASTM A-569, steel, carbon (0.15 maximum, percent), hot-rolled sheet and strip, commercial quality.
- o NAAMM, Metal Bar Grating Manual and Metal Finishes Manual.
- o Standards of the Reinforced Plastic/Composites Institute.
- o National Bureau of Standards, PS15-69.
- o ASTM B-210, Aluminum-Alloy Drawn Seamless Tubes.
- o ASTM B-221, Aluminum-Alloy Extruded Bars, Rods, Wire, Shapes and Tubes.

Ladders: Vertical ladders and cages shall conform to applicable OSHA regulations.

Railings: All railings (posts, rails and toe plates) shall conform to applicable OSHA regulations.

Metal Floor Plate: All metal floor plate shall conform to the applicable provisions and accommodations of the following:

- o ASTM A-36, Structural Steel.
- o ASTM B-209, Aluminum-Alloy Sheet and Plate.
- o ASTM A-123, zinc (hot-galvanized) coatings on products fabricated from rolled, pressed and forged steel shapes, plates, bars and strip.

### 1.5.5 Concrete

General Requirements: The requirements of Part III of the American Concrete Institute; "Building Code Requirements for Reinforced Concrete", (ACI 318-77) shall govern the concrete work.

Materials: Portland cement shall conform to ASTM "Standard Specifications for Portland Cement", C 150, Type II.

High-Early-Strength Portland Cement shall conform to ASTM "Standard Specifications for Portland Cement", C150, Type III.

Aggregates for concrete shall conform to ASTM "Standard Specifications for Concrete Aggregates" C33.

Air-entraining admixture shall conform to ASTM C 260, and shall be used in all concrete exposed to the weather. Air entraining admixture shall be added in such quantities as necessary to produce an air content of 4 to 6 percent by volume, as determined by ASTM C 231.

Water-reducing and retarding admixture shall conform to ASTM C 494, Type D and shall be used in all concrete. The admixture shall be added to the proportions recommended by the approved manufacturer.

Water shall be clean and free from injurious amount of oil, acid, alkalies, organic materials, or other deleterious substances.

Metal reinforcement shall be deformed bars and wire mesh conforming to the following requirements:

Deformed bars - ASTM A615, Grade 60.

Wire Mesh - ASTM A 185

Testing and Inspection: Testing and inspection of concrete and materials shall be performed by an independent testing laboratory.

The Contractor shall make test cylinders of the concrete placed at the job in accordance with applicable ASTM standards. Concrete cylinder testing shall conform to the

standard Method of Making Compression Test of Concrete, Serial Designation C39.

Test cylinders shall be properly cured and aged before testing. Copies of all test reports shall be retained by the Contractor for record. Cost of all tests shall be borne by the Contractor.

Proportioning and Mixing Cast-in-Place Concrete:

All structural concrete shall have a minimum compressive strength of 4000 psi in 28 days. One brand of cement only shall be used to prevent different shading of finished concrete or mortars.

Ready mixed concrete shall be mixed and delivered in accordance with the Standard Specifications of the ASTM C-94 latest edition.

Temperature: Hot weather - All methods and materials used for hot weather concreting shall be in accordance with the requirements of "Recommended Practice for Hot Weather Concreting" (ACI 605).

Lightweight Insulating Roof Fill: All work shall conform with the requirements of the prevailing Building Code in addition to the requirements or qualifications of these specifications.

Lightweight insulating roof fill shall meet all requirements as detailed in:

ASTM C-332-66(71) Group I

ASTM D-312-71

Factory Mutual 69-209.20

1.5.6 Light Poles, Mast Lighting, Sign and Signal Supports

The design, loadings, materials, fabrication and construction of light poles shall conform to standard specifications for structural supports for highway signs, luminaries and traffic signals of the American Association of State Highway and Transportation Officials, and all the design requirements of the County and the State.

### 1.5.7 Stacks

Stacks shall be designed and erected in accordance with all applicable codes and regulations. The maximum stack height, at each site shall be 200 feet above final grade elevation. The stacks can be of a radial brick, concrete, or steel type with acid resistant high temperature liners. In all cases the stacks shall be of a design providing sufficient draft to exceed by at least twenty percent all losses due to I.D. fan outlet breeching gas velocities, in stack gas velocities and friction and stack outlet velocities. In no case shall the stack designs result in positive pressures at the base of the stacks under normal operating conditions.

The design loading for stacks or chimneys shall conform to the minimum building code requirements of American National Standards Institute (ANSI A58.1). The wind pressure shall be based on a fastest mile speed of 100 miles per hour at 30 feet above ground and Exposure C with consideration given to gusts and vibration response.

The design, materials, fabrications, and construction of concrete chimneys shall conform to the standard specification for design and construction of reinforced concrete chimneys (ACI 505).

The design, materials, fabrication, and construction of steel chimneys shall conform to the specifications of American Institute of Steel Construction and American Iron and Steel Institute with design considerations given to cable deflections.

Masonry chimneys shall be constructed with radial bricks with type "M" mortar conforming to ASTM C-270.

## 1.6 General Mechanical

### 1.6.1 Plumbing/Piping

City Water Piping: The Contractor shall furnish and install City water supply piping as required.



Hydrostatic testing for water piping shall conform to AWWA Specification C-600-64 Section 13.0.

All ductile iron pipe and fittings shall be cement lined. Linings shall conform to ANSI Spec. A 21.4. All piping and fittings shall be shop coated with standard bituminous coating on the exterior.

Reinforced Concrete Piping: Reinforced concrete pipe shall be Class IV Reinforced Concrete ASTM C-76 (Steel Area 0.07).

The installation of all pipe shall conform to the applicable requirements of AWWA Standard C600. All accessories for making mechanical joints shall meet the requirements of ANSI Specification A 21.11.

Polyvinyl Chloride Piping (PVC): All piping and fittings shall be Type 1, Grade 1, virgin unplasticized PVC Schedule 80 conforming to ASTM Des. D 1784, D 1785, D 2241, D 2264 and D 2467.

All assembly shall be done strictly in accordance with the manufacturer's specifications.

Miscellaneous Piping Requirements: Bronze gate and globe valves shall conform to ASTM B 62.

All backflow preventers shall conform to local code requirements. Air release valves shall be installed where required. All required accessories, such as gate valves, globe valves and check valves shall be installed as recommended by the air release valve manufacturer.

Wherever dissimilar metals come in contact, dielectric couplings shall be installed in the lines to separate the metals and prevent galvanic action.

The Contractor shall conduct testing of all pipelines leakage. All pipelines shall be tested to not less than one hundred fifty percent of the working pressure. All visible leaks and defects shall be promptly repaired and the line re-tested.

Drain lines on the process piping system shall be tested as per plumbing standards.

Painting: All pipelines shall be painted in conformance with latest ANSI Standards.

Temporary Water: The installation and cost of temporary water shall be provided and borne by the Contractor.

Water Meters: Water meter(s) shall be furnished and installed by Contractor. Water meter(s) shall conform to local code requirements.

#### 1.6.2 Heating, Ventilation and Air Conditioning

Rules and Regulations: The Contractor shall conform to the rules and regulations of the BOCA Basic Building Code having jurisdiction in this State, and to all County and Local laws, ordinances and regulations affecting the erection and completion of the Heating, Ventilation and Air-Conditioning work.

Piping Installation: Piping shall be erected with proper provision for expansion and contraction, as required.

Dampers: In addition to volume control dampers, fire dampers shall be installed as required by insurance underwriters, and local codes.

Thermal Insulation for Ducts and Piping: All components of the insulation for both piping and ductwork, including facings, mastics and adhesives shall have a fire hazard rating not to exceed 25 for flame spread and 50 for fuel contributed and smoke developed. Ratings shall be as determined by Underwriters Laboratories, Incorporated, or other approved testing laboratory.

Belt Guards: Belt guards shall be installed on all equipment equipped with belt drives.

Vibration Isolation: Vibrating equipment such as pumps, fans, etc., shall be isolated from the building structure in a manner such that sound and vibration will not be transmitted through the building.

## 1.7 Electrical

### 1.7.1 Scope of Work

The scope of this section is to cover the work consisting of designing, furnishing, and installing all necessary equipment for the following:

- o The interconnection system between each facility and FP&L, which shall include the outdoor switching substation consisting of circuit breakers, metering and power transformers and equipment, and all associated protection and synchronizing equipment, as well as the transmission feeders and terminating potheads between switching station and the FP&L transmission line.
- o The step-up/step-down power transformers, interfacing circuit breakers and protective equipment at the switching station to meet facility and FP&L requirements. If load tap changers are required, they shall be provided in separate enclosures. Interconnect transformers shall each be sized for the full output of the plant.
- o Three-phase current limiting reactors, one for each generator. The reactor shall limit the three-phase short circuit power on FP&L to FP&L requirements. The exact rating of the reactor shall be calculated by the Contractor and coordinated with the characteristics of the other equipment (i.e., transient reactance of the generators, independence of power transformers, FP&L available short circuit, etc.).
- o 4.16 KV system for auxiliary services consisting of 4.16 KV switchgear, 4.16 KV motors and associated starters, and all other necessary equipment and materials required for the proper operation of the 4.16 KV system.
- o 480 volt system consisting of the 480 volt switchgear, the 4.16/0.48 KV power transformers, all necessary motor control centers, energy saver type electrical motors, all necessary relaying protection with an emphasis on a properly coordinated ground fault protection system and all necessary equipment and materials required for the proper operation of the 480 volt system.
- o Complete indoor relay and control switchboards for all the facility's electric systems.

- o Indoor and outdoor lighting systems comprising all necessary equipment and materials required for the proper illumination of the plant and site, at the required illumination levels for each specific task.
- o 125 volt DC system consisting of 125 volt DC battery, the required charger and the appropriate DC distribution switchboard.
- o Cable and wiring system with all necessary raceways for all power distribution systems, including reinforced, concrete encased, underground duct banks, and exposed AC and DC conduit system with rigid galvanized steel conduits and approved fittings. This shall include excavating, dewatering and back-filling. All cable and terminations shall be in accordance with the manufacturer's specifications.
- o Control, security and communication systems, Telephone, Fire Alarm, Smoke Detection, Sprinkler, Halon, Lighting, Local Automatic Shutdown, Local Manual Control, Central Automatic Control, Security, and HVAC for all plant and auxiliary operations, all as described elsewhere in these specifications.

#### 1.7.2 General Electrical Requirements

The following items of equipment covered by this specification may be installed either indoors or outdoors in the open atmosphere:

- Turbogenerators and associated power generation equipment.
- 4.16 KV A.C. switchgear and accessories.
- 480 volt A.C. switchgear and accessories.
- 124 volt D.C. battery system.
- Interconnection bus structure, insulators, bus switches, etc.
- Interconnection oil circuit breakers.
- Interconnection power transformers.

The Contractor shall furnish, install and connect any additional components, parts, items and devices not specifically mentioned herein, but necessary for the proper operation of the equipment.

The systems shall be provided in accordance with all local and federal code requirements and shall provide the functional features described. Each system shall be furnished and installed complete with all appurtenances necessary to be fully operational.

#### 1.7.3 Standards

All equipment to be furnished by the Contractor shall be in accordance with the latest applicable standards of NEMA, IEEE, ANSI, AAR, IPCEA, latest OSHA, UL, National Electrical Code, National Electric Safety Code, Florida Electrical Code, and all applicable local codes and/or ordinances with regard to Material, Design, Construction, Testing and Installation except for variations as specified herein.

#### 1.7.4 Temporary and Interim Electric Work

The Contractor shall provide temporary, electrical services required for construction of the Project, including all fees to FP&L for their work associated with such electrical services and connections. FP&L energy use charges shall be paid for by the Contractor.

The installation shall conform to the requirements of FP&L and shall include poles, post, fences, grounding, terminations, meter cabinets, meter and secondary feeder and branch wiring and conduits, circuit breakers, panelboards, lights, wiring devices, wiring, motor connections and supports.

#### 1.7.5 Cutting and Patching

The Contractor shall furnish chases and openings in the floors, walls, and partitions before they are built. The Contractor shall install sleeves or boxes in the forms of floor slabs and/or walls before they are poured.

#### 1.7.6 Fire Alarm System

The Contractor shall equip each facility with a fire alarm system, including all necessary manual stations, bells, control panel and annunciator, wiring and conduit.

#### 1.7.7 Fail-Safe Systems

The Contractor shall install Fail-Safe Systems for all key equipment, including, but not limited to the furnaces, the boilers, turbine-generator set, the electric substation and the electrostatic precipitators. The Fail-Safe Systems of each key equipment item shall be so designed that if any one piece of equipment fails, other equipment will not be damaged by this failure.

### 1.8 Facility Access and MSW Delivery Requirements

#### 1.8.1 Functional Design

Each facility site design shall provide adequate ingress and egress roads and maintain continuous control of all traffic movements during facility operating hours. Each facility design shall also include adequate on-site roadways, parking, and maneuvering areas to accommodate, efficiently and safely, anticipated traffic levels during normal and emergency periods, in order to minimize the impact of traffic on noise and air quality levels and to prevent the queuing of disposal vehicles on public roads adjacent to the facilities.

#### 1.8.2 Traffic Flow

The MSW will be delivered to each facility by collection trucks that are either municipally or privately operated.

On-site traffic shall be directed generally using one-way roads either to the weighing stations (MSW trucks), the ash handling areas (residue truck), and/or to the administration areas and process buildings (staffs, visitors and all other vehicles). This one-way flow of traffic shall help ensure congestion-free operations and smooth-functioning facilities.

MSW trucks shall proceed from the entries to the weighing stations, establish the weight of the refuse, proceed to the tipping areas for unloading, stop at the weighing stations again, if necessary, and then exit the facilities.

Trucks hauling Unprocessable Waste shall proceed from the entries of the resource recovery facilities to the weighing stations, establish the weight of the Unprocessable Waste, proceed to the Residue/Unprocessable Waste landfill dumping areas for unloading, stop at the weighing stations again if necessary, and then exit the facilities.

Two-way roads may be planned for on-site roads at the resource recovery facilities to the Residue/Unprocessable Waste landfills.

Maintenance and delivery vehicles shall be directed to the plant office or to service areas within each facility.

Paving and drainage of parking areas shall be in accordance with accepted standards. Staff and visitor vehicles shall be directed to parking adjacent to the administration area immediately upon entering each facility to prevent any traffic conflict with truck flows.

Roadways for trucks shall serve the scale house areas, the tipping floors and other functional areas of the facilities. Roads within each facility shall be designed to allow proper traffic flow to prevent the queuing of waste-handling vehicles, both during normal operation and in the event of mechanical failure of vehicles or at the scale house. Access to the sites from adjacent roads shall be designed to minimize interference with exiting traffic flow and permit vehicles rapid and safe ingress and egress to and from the sites. Sufficient on-site roadways shall be provided to ensure that traffic backups will not extend out to the local streets or highways.

The traffic design for each facility shall be based on the following criteria:

- o A daily quantity of delivered MSW determined by the following formula:

$$DW = \frac{AFT \times AF_1 \times AF_2 \times AF_3}{365}$$

Where:

DW = Quantity of delivered MSW (processable and unprocessable waste) per day in tons

AFT = Annual guaranteed facility throughput in tons of Processable Waste

AF<sub>1</sub> = MSW Delivery Adjustment Factor = 1.17

$$\left( \frac{7 \text{ days per week operation}}{6 \text{ days per week delivery}} = 1.17 \right)$$

AF<sub>2</sub> = Broward County seasonal MSW generation rate Adjustment Factor = 1.11

AF<sub>3</sub> = Broward County Peak Daily MSW Delivery Adjustment Factor = 1.43

- o The estimated number of trucks delivering garbage shall be based upon 55 percent of DW as determined above and an average net load of 9.0 tons per truck.
- o The estimated number of trucks delivering processable trash shall be based upon 23 percent of DW as determined above and an average net load of 5.0 tons per truck.
- o An estimated quantity of residue based upon such residue containing not more than 4 percent combustibles and 0.2 percent putrescibles of the incoming MSW.
- o The estimated number of trucks delivering unprocessable trash shall be based upon 22 percent of DW as determined above and an average net load of 5.0 ton per truck.
- o An estimated volume of 75 employee and visitor cars per day. Visitors arriving by bus shall also be accommodated.
- o Maintenance and delivery vehicles as required.



Proper access shall also be provided for fire fighting apparatus. There shall be a bypass road around each scale house area for fire fighting, passenger and other designated vehicles.

All access roads used by refuse vehicles shall be constructed and paved in accordance with standards for heavy truck usage.

The Contractor shall maintain weighing, receiving, and queuing areas which are capable of:

- o Accepting the refuse in the quantity proposed and assumed transport mix.
- o Completing the functions of the MSW delivery (entering the plant, weighing, unloading, and exiting the plant) within ten (10) minutes of each truck arrival at the site; even during peak arrival periods.
- o Receiving, holding, or processing normal MSW quantities during scheduled downtime.

Adequate parking and maneuvering areas shall be provided for both facility staff and visitors. Provisions for the handicapped shall also be made for parking and sidewalk access.

The design and operation of all vehicular activities and traffic flow patterns associated with the construction and operation of each facility will be subject to the regulations of state and local Traffic and Highway Departments.

### 1.8.3 Traffic Control

The traffic flow within each facility site shall be controlled by stop signs except at the plant entrances, the weighing stations, and the tipping floor area where traffic lights shall be installed. All routine traffic shall be directed utilizing one-way roads. There shall be a minimum of mixing of truck traffic with staff and visitor traffic. There shall be exclusive truck routes to handle the estimated number of trucks per day including all refuse trucks, residue trucks, unprocessable waste trucks, maintenance and delivery vehicles.

The traffic pattern at each facility shall be designed to provide for efficient operation and use of space. The weighing systems and storage facilities may be of whatever design is most applicable to the process needs, while meeting the efficiency and safety specification.

Identification signs at the entrance and appropriate directional signs which are approved by the County shall be provided. Fences, gates, metal doors with locks, card controlled gates, or other adequate security measures must be provided to control access to each facility.

#### 1.8.4 Weighing Station

General Information: The intake of waste to each facility shall be regulated and controlled by its weighing station's operation. MSW will be transported to the facilities either in municipal collection vehicles or private carter trucks. The facilities will not accept hazardous waste, and private automobiles will not be permitted to dump MSW at the facilities. After weighing, Unprocessable Waste shall be directed to the Residue/Unprocessable Waste landfill. In the event Unprocessable Waste is inadvertently unloaded at the resource recovery facility, the Contractor shall be responsible for cost of transporting such waste to the Residue/Unprocessable Waste landfill.

Deliveries shall be made in accordance with the County's normal collection and delivery practices as now or hereinafter may exist. Safe and adequately-sized areas must be provided for queuing incoming trucks and to prevent traffic back-up from interfering with local street and local highway traffic flows.

Each facility shall have the capacity to unload the Processable Waste from the vehicles, in a totally enclosed tipping area, with a total on-site unloading time of ten (10) minutes for mechanically unloaded vehicles. The unloading time is defined as the time a vehicle first enters the site to the time the vehicle leaves the site.

The Contractor shall maintain an identification system, including scales for weighing and recording deliveries. The scales shall be of a type approved by the State Sealer of Weights and Measures and shall be equipped with automatic printers which shall record the time, date, and scale weight in accordance with the Contractor's identification and accounting procedures.

The number of scales at each weighing station shall be determined using the information for truck flow; queuing space determined by the Proposer, the ten minute time per vehicle as defined above; and the inclusion of one standby scale.

Each weighing station shall be fully automatic with manual override systems. Each weighing station operator shall serve as the equipment operator as well as the traffic flow controller to the tipping area, and also maintain a level of security.

Each weighing station shall consist of as a minimum, but not be limited to, truck scales, scale pit or foundation with understructure and weighbridge, scale house, truck identification system, scale house equipment, approaches, entrance and exit gates and traffic control signal system.

Approach Road: The approach road to the weight station shall be wide enough to "fan" out the incoming flow of traffic as well as serving as a by-pass should any vehicle breakdown.

A deceleration lane shall be provided to ensure that traffic will not back up onto public streets.

The by-pass road for vehicles not having to be weighed (employee, visitor, delivery and maintenance vehicles) shall be controlled by a gate, which shall be manually operated by the weigh scale operator.

Scale Design: The truck scales shall have, as a minimum, a capacity of 40 tons and shall automatically print

out vehicular weights on scale tickets. Each scale shall be equipped with an indicating and recording system.

Upon entering each facility, each delivery vehicle shall be weighed. If tare weights have not been established for particular vehicles, these vehicles shall be unloaded and weighed upon leaving the site. Therefore, provisions for scales to be used upon exit shall also be provided.

Scale Houses: The scale houses shall include all equipment which is auxiliary to the scales, such as the digital indicators, card printers with printout of gross, tare and net weights, and an accumulator for daily totals of net weights. These facilities shall include restrooms for truck drivers and employees, as well as visitors' observation spaces.

#### 1.8.5 Tipping Area

General: The Processable Waste tipping process shall take place in totally enclosed tipping areas, which shall have a minimum length equal to the Processable Waste receiving and storage pit, and which shall be kept under negative pressure.

Ventilation systems shall provide for the control of dust, and shall meet all applicable Occupational Safety and Health Administration (OSHA) requirements for ventilation. In addition, sound proofing shall be provided within the tipping floor areas to limit the maximum noise level to 80 decibels (dba).

Truck Tipping Bays: At each facility there shall be an adequate number of tipping bays (to be determined by the Proposer) to handle the peak flow of waste trucks at all times. The number of bays should be based on the maximum vehicle size; peak truck flow; the coordination of queuing space at the weigh station, and the ten minute on-site time from entering the facility at the gate to exiting at a gate.

Safety and Hazard Controls: Safety measures shall be provided to minimize noise, dust, odors and general haz-

ards, such as fire, in the tipping areas. Efforts shall be made in the design of each facility to maximize safety. All applicable requirements of OSHA shall be met with regard to the tipping area.

## 1.9 Processable Waste Storage and Handling System

### 1.9.1 General Description

At each facility, Processable Waste shall be stored in a pit large enough to hold, as a minimum, the quantity of Processable Waste equal to four times the daily Nameplate Capacity of the facility, without spilling onto the tipping floor. "Dedicated floor area" in lieu of a storage pit will not be acceptable.

At each facility, Processable Waste shall be moved from the storage pit and fed or charged into the furnaces by means of an overhead crane and grapple system. The cranes and grapples will also be used to mix Processable Waste in the pit to produce a homogeneous mass and shall be capable of removing large, bulky combustible trash items from the storage pit and feeding same to the crusher/shears. The crusher/shears, located at one end of the storage pit, shall be used for size reduction of the oversized processable trash prior to charging into the furnaces. Provisions shall also be made for removal of salvageable oversized non-combustible trash from the storage pit, utilizing the overhead crane and grapple system.

### 1.9.2 Processable Waste Storage

Construction: The pits shall be constructed of reinforced concrete and take into account soil, groundwater and flood-prone conditions of the sites. The crane parking areas shall be of prestressed concrete with steel reinforced outer perimeters.

The foundations of the pits shall be isolated and the independent of the foundation of the process buildings.

Dust and Odor Control: The pit areas shall be totally enclosed to limit the spread of any odor and dust. The areas shall be kept under negative pressure by drawing combustion air from the pit areas using the combustion air fans.

Ventilation Systems: The ventilation of the tipping areas as well as the pit areas shall be accomplished by the combustion air fans used for all the furnaces. Make-up air louvers, with broad screens shall be provided as required.

Fire Protection: There shall be at least two types of firefighting equipment for control of both chemical and non-chemical fires (water cannon and standpipe system). There shall also be fire alarms provided which shall be tied directly to the local fire departments in the event of any pit fires.

#### 1.9.3 Crushers/Shears

At each facility a crusher/shear is to be provided for size reduction of oversized combustible bulky waste down to a size which shall minimize bridging or clogging in the furnace charging hoppers and assure complete incineration as fired with processable waste. Shredders shall not be used.

#### 1.9.4 Crane and Grapple Systems

Scope: At each facility there shall be two 100 percent or three 50 percent capacity (one spare) heavy duty electric overhead traveling cranes suitable for continuous service handling Processable Waste.

The cranes shall be remote controlled from a stationary pulpit. "Cab-on-Crane" arrangements will not be permitted. Radio controlled cranes will be permitted.

Codes and Specifications: Unless otherwise specified, the cranes at each facility shall be designed and manufactured in accordance with applicable codes, manuals, specifications and requirements for Severe Duty Cycles and Steel Mill Type of Service:

- (a) American Gear Manufacturers Association (AGMA)
- (b) American Institute of Steel Construction (AISC)
- (c) American National Standards Institute (ANSI)
- (d) American Welding Society (AWS)
- (e) Anti-Friction Bearing Manufacturers Association (AFBMA)
- (f) Crane Manufacturers Association of America (CMAA) - Specification No. 70 (Electric overhead traveling cranes, Class "F", Severe Duty Cycles.)
- (g) Insulated Power Cable Engineers Association (IPCEA)
- (h) National Electrical Manufacturers Association (NEMA)
- (i) National Fire Protection Association (NFPA)
- (j) Occupational Safety and Health Administration (OSHA)
- (k) Steel Structures Painting Council (SSPC)
- (l) American Society for Testing and Materials (ASTM)
- (m) Association of Iron and Steel Engineers (AISE) - Standard No. 6 (May 1969) Specification for electric overhead traveling cranes for Steel Mill Service

In case of conflict between various applicable codes, standards and regulations outlined in this paragraph, the "Specification for Electric Overhead Traveling Cranes for Steel Mill Service" AISE Standard 6 of May, 1969 shall govern.

Rated Capacity: Each crane capacity shall be based on the weight of the grapple including lifting cables, plus material with a density of 540 pounds per cubic yard,

with a heap factor. The feeding cycle calculation shall be based on an average material density of 400 pounds per cubic yard with a heap factor of 1.33.

Design Stresses: The cranes shall be mechanically and structurally designed and fabricated in accordance with AISE specifications for steel mill service. Unless otherwise specified, the design stress conditions shall be those required under codes and specifications above.

Duty Cycle: Duty cycle computations shall be based on:

Furnace Feeding	43%
Restocking	17.0%
Fatigue	10%
Total Active Time	70.0%

The cranes shall be capable of performing continuously, the feeding and rehandling cycles with full load, with motor temperature rises not exceeding the specified rating of the motors. The following crane/grapple motions may take place simultaneously:

- o Hoisting and bridge travel with grapple at any level.
- o Lowering and bridge travel with grapple at any level.
- o Trolley and bridge travel with grapple in high position.

In addition to the simultaneous motions outlined above, the normal crane operations shall permit the following functions:

- o Grapple open and close at any level.
- o Trolley and/or bridge travel with grapple at any level.

Environment: The cranes shall be designed for an indoor dusty environment.



Crane Parking: The crane runways shall be designed to allow for parking of one crane at each end of the pit when out of service for repairs or for inspections. The roof above the crane runway shall include a penthouse with service platforms for each additional crane over and above the two cranes that can be parked at each end of the runway. The penthouse(s) shall include electric hoists to lift an inactive crane from the runway for parking or maintenance.

Operator's Pulpit: There shall be a minimum of one remote, stationary operating station (operator's pulpit) located above the pit on either the tipping floor or hopper side, which allows full view of the storage pit and of the furnace charging hoppers. The operating station shall contain one operator's control chair for each crane installed.

All station access corridor enclosures, separating station corridors from the refuse storage pit, shall be dust tight. The stations shall be equipped with an independent heating, ventilating and air conditioning system in accordance with the applicable building code requirements.

The pulpit shall be equipped with fire alarm systems, indicating panels and fire fighting control capabilities. There shall be a direct phone line to the local fire department from the operator's pulpit.

The normal crane operation shall provide for automatic location of the trolley and bridge over the selected charging hopper after the grapple has picked its load and achieved its lift to the top elevation.

Each crane shall be operable from either control pulpit on demand except when in use by one of the operators. A traverse switch shall be provided which will enable any one crane to be operated from any operator's station. Interlocks shall be provided to prevent interference and attempts for simultaneous operation.

Grapples: Orange peel or clam shell tine type electrohydraulic grapples shall be provided for each crane with one spare at each facility, in addition to the one on the spare crane.

Electrical Motors: All motors shall be capable of starting and operating under any conditions within the design capacity of the crane and with any voltage within plus or minus ten percent of the rated voltage.

All motors shall be totally enclosed, air over housing fan cooled.

#### 1.9.5 Charging Hoppers and Chutes

Charging Hoppers: Charging hoppers shall be designed to withstand the weight of the refuse as well as the vertical and horizontal impact of the fully loaded crane grapple.

Charging hoppers shall be independently supported by the charging floor structure and shall be arranged so as to minimize spillage onto the charging floor. Spill plates shall be incorporated between the charging hopper and refuse pit wall.

Charging hopper discharge throat (exit) shall be smaller than furnace feed chute entrance to furnace/boiler to prevent clogging (bridging) a furnace/boiler entrance, and shall be adequately sized to accommodate individual furnace/boiler rated throughput capacity.

Chutes and Cut-Off Gates: Chutes connecting charging hoppers and furnace/boiler feed throat shall be either water cooled or refractory lined.

Chutes shall be of the inverse taper type to preclude clogging (bridging) in chute.

Between each charging hopper discharge and chute entrance there shall be a cut-off gate to prevent burnback during furnace/boiler shutdown.

## 1.10 Combustion Systems

### 1.10.1 General Design

The combustion systems and all related equipment for each facility shall be supplied by the Contractor. The minimum combined total nameplate rated capacity of the two facilities shall be 2,600 tons of Processable Waste per day. The combustion units proposed shall be of proven design with a minimal successful operating experience of one year. Scaling up of components shall not exceed 25 percent. In view of the documented history on high temperature corrosion on superheaters, the Proposer's base proposal shall be with steam parameters of 750°F and 650 psia. Proposals based on higher quality steam parameters will be accepted, where the proposer can demonstrate, through supporting documentation, furnace/boiler on-line reliability equal to that of the base proposal.

The Contractor shall furnish and install a minimum of three combustion units at the southern facility and two combustion units at the northern facility, each with the capability of operating five percent above its rated Nameplate Capacity. The use of multiple units is intended to provide for system redundancy and the capability of selling additional energy to the utility during peak hours of operation. The Proposer shall provide a firing diagram and additional information indicating how the boilers will be capable of handling fluctuations in BTU content and moisture content as well as proximate and ultimate analysis.

The Contractor shall provide the turndown ratio such that the boiler efficiencies do not drop below 85 percent of the boiler design efficiencies.

All furnace equipment and auxiliary equipment shall be manufactured and constructed in accordance with ASME boiler and furnace construction codes except where otherwise stated, and shall be so stamped on the equipment.

The individual units shall each be designed to operate at the minimum excess air level and exhaust the combustion flue gases from the electrostatic precipitator at a minimum of 40°F above dewpoint.

The minimum combustion temperature shall be 1,500°F and temperature shall be controlled to a maximum of 1,800°F.

#### 1.10.2 Furnace Design

General: Furnace design shall be of the mass-burn stoker-fired, or stoker/rotary kiln tandem type, capable of firing as-received Processable Waste (without auxiliary fuel burning) on a continuous feed basis.

Each combustion train shall be equipped with an individual multiple pass waterwall type boiler of a configuration which has been successfully demonstrated for a minimum of three years.

Refractory Enclosures: The refractory linings of the furnaces, where applicable, shall be of super duty quality, laid in high temperature mortar. The refractory walls (other than rotary kiln) and arches shall be of the sectionally supported type, anchored with high temperature alloy anchors and insulated with an adequate amount of insulation.

The refractory enclosure materials shall conform or be equal to the latest of the following minimum requirements and classification:

- o Super duty fire brick - ASTM C-27
- o Silicon carbide walls - ASTM C-106
- o Insulating brick (where applicable) - ASTM C-15
- o Insulating castable - ASTM C-401, Class Q
- o Expansion joint filler - Fiberfrax, Kaowool or equal
- o Sectionally supported wall and arch mortar--Super-duty Fireclay
- o Insulation - Mineral wool block

- o Tile engaging castings or anchors - ASTM A297-74A

All sectionally supported walls and arches shall be supported on a steel structure independent of stoker supports and assemblies. The exterior surfaces of the wall shall be protected by suitably reinforced steel or aluminum casings.

All structural steel framing shall be designed, fabricated and erected in accordance with the AISC Steel Construction Manual (latest edition), and in accordance with applicable local code requirements, including seismic, impact, lateral, vertical and longitudinal loading.

Grates (Stokers): The grates shall be of manufacturer's design and shall be of a design used in successful operation for a minimum of three years.

The design of mechanical components and selection of construction materials shall be such as to yield ninety percent availability under normal operating conditions. Routine repairs and adjustments shall not require more than 200 man-hours with major overhauls required at a maximum of every three years (or 20-30,000 hours).

All grate operations (speed, cycle frequency, etc.) shall be arranged for remote operation from a central control room with local manual override. Grate drive shall be by hydraulic motor controlled by a variable volume pump. The degree of burnout on the grate sections shall be established and guaranteed by the Contractor. The combustion efficiency of the stokers shall yield a residue containing not more than 4.0 percent combustibles and 0.2 percent putrescibles.

The stoker surface materials shall conform to the following minimum requirements:

- o Reciprocating stokers shall be of precision ground cast chromium alloy steel grate bars.
- o Feed sections not exposed to burning fuel bed - MEEHANITE HS type cast iron or equal.

- o Circular grates may be cast iron.
- o Parts designed to prevent erosion of side walls (if applicable) extending not more than six inches above stoker surface-MEEHANITE HS type cast iron or equal.
- o Burning section castings exposed completely or in part to burning fuel bed not more than forty five percent of operating cycle time, each cycle not exceeding five minutes - MEEHANITE HS type cast iron or equal.
- o All other surface castings - heat resistant alloy conforming to ASTM A 297-74a Grade HF designation.
- o Alloy (weldable stainless steel) steel grates shall have a minimum of four percent nickel composition.
- o Wear plates shall be "NT" (high density forged steel plate).

Waterwall Enclosures: Waterwall enclosures shall be of gas-tight fully-welded membrane type, backed by mineral wool block insulation. The cold face of the insulation shall be protected by steel or aluminum casing.

Where the waterwalls are expected to be exposed directly to direct flame or alternate reducing and oxidizing atmosphere, the tubes shall be protected with silicon carbide low oxidizing grade castable refractory, anchored to the tubes with welded studs of high temperature alloy steel.

The tube arrangements shall be of an in-line pattern (staggered tubes are not acceptable). Each boiler shall be equipped with a tube-cleaning system to provide and ensure high operating efficiency.

The walls adjacent to the stoker surfaces shall be of watercooled silicon carbide tile extending a minimum of four feet above the grate surfaces.

#### 1.10.3 Combustion Air System

The combustion air systems shall be designed to control automatically the furnace temperatures within +50 degrees Fahrenheit of the set-point temperature selected by the Pro-

poser while firing Processable Waste with higher heating values (HHV) varying from 3,500 to 6,000 BTU/lb. The Proposers should note the wide range of HHV for the Processable Waste as fired. Sampling conducted on Broward County's Processable Waste indicates that the minimum and maximum extremes of the range may be realized on a sustained seasonal basis (e.g. November through April at upper range and May through October at lower range) as a result of significant variation in moisture content associated with extremes in rainfall.

The distribution of the primary and secondary air, including secondary air jets, shall yield a combustion efficiency resulting in dry gas carbon monoxide (CO) content not exceeding 0.1 percent by volume, measured upstream of boiler convection sections.

Separate fans for primary and secondary air shall be used (minimum two combustion air fans per boiler). Each fan shall be motor driven. All combustion air fans shall be mounted on vibration elimination bases with non-combustible flexible connections at the inlets and outlets of the fans. Either system shall be automatically controlled by a furnace temperature control system. The control of the primary and secondary air flow shall be automatic with a manual override system in the plant control room.

The combustion air ductwork inlets shall be arranged to use selectively air from the refuse storage area, tipping area, or from outside atmosphere, or any combination of the above. Each primary and secondary air inlet duct shall be fitted with venturi type or similar non-plugging type flow measuring device with remote output readout instruments.

The combustion air ductwork shall be manufactured of sheet metal or steel plate two gauges thicker than required by ASHRAE code for air conditioning and ventilating systems for a similar air capacity and pressure. Section joints shall be flanged and gasketed; access doors or panels shall be provided

at each bend; the ductwork system shall be essentially air tight with leakage not exceeding one percent of the maximum design air flow.

The fan drives shall be selected for a minimum of 125 percent of the maximum design brake horsepower (BHP).

#### 1.10.4 Energy Recovery Systems

The steam parameters for the boiler system shall consist of the following:

- o Stream Pressure - 650 psia  $\pm 5\%$
- o Steam Temperature - 750°F  $\pm 5^\circ\text{F}$

Boilers: The boiler design and manufacture shall conform to the ASME boiler code and approved quality assurance program, and, if required by applicable codes, shall bear the ASME stamp.

The boilers shall be designed with in-line tubes and drum(s) perpendicular to the gas flow. Boiler tubes shall be of an adequate tube thickness and diameter with proper spacing provided between the tubes. Adequate air circulation near the convection tubes shall be provided. Gas temperatures coming into contact with the external tubes should not exceed 1,600°F.

Single pass boilers with vertical tubes shall have an arch or stainless steel baffle to redirect the air flow and prevent excessive corrosion of the boiler side tubes. Properly sized valves with welded packing shall be provided.

The tube and drum configuration shall be the option of the Contractor, but shall conform to general requirements specified herein. The drums shall be Class 1 fusion welded construction, tested before shipment. The steam drums shall be fitted with steam separation baffles yielding dry steam with a purity of one parts per million (ppm) solids at maximum continuous steaming conditions, at the design pressure and temperatures, when the boiler water concentrations do not exceed standard ABMA limits. Each drum shall



have two manhole openings fitted with hinged steel manhole covers complete with necessary bolts, grabs, and gaskets.

Proper provisions shall be made for thermal expansion of the drums so that abnormal stresses are not produced on either the pressure parts or in the supporting members. The boilers shall be designated with either a soot blowing system or tube rapping system for the cleaning of both the external and internal surfaces. An access door allowing for inspection and maintenance of the tubes and the tube rapping system shall be provided.

Superheaters: Superheaters shall be manufactured out of the alloy best suited to resist thermal corrosion as well as chlorine, fluorine and sulphur corrosion. The Contractor shall specify whether the superheater tubes will be provided with clamp protective metallic shields on the tubes at the vulnerable locations or if the tubes will use plasma-gun coating by metallic or ceramic materials.

The superheaters shall be designed with proper provisions for thermal expansion and with attenuators between the stages of the superheater. The superheater bundle shall be placed away from the primary radiant section.

Economizers: Each boiler unit shall be provided with the proper tubular economizer. The economizers shall be the bare tube type (no finned tubes).

The economizers shall be designed for forced circulation, which is provided by the boiler feed pumps, using at a minimum, a feed water temperature of 250°F. The economizer design pressure shall be at a minimum of 125 percent of the boiler design pressure. The economizers shall conform, as a minimum, in all respects to the ASME boiler codes.

#### 1.10.5 Boiler Auxiliary Systems

Boiler Auxiliaries: The Proposer shall provide all required auxiliary systems to make the boilers complete, operable and maintainable. All boiler appurtenances shall be

designed to operate and support each facility at its maximum continuous rating.

Boiler auxiliary systems, including, but not limited to all steam circulation and distribution piping, boiler feed water pumps, treated water pumps, raw water pumps, condensate pumps, tanks and accessories, water treatment and deaeration systems, boiler feedwater heaters, process piping systems, etc., shall be designed and furnished by the Contractor in accordance with:

- o ASME boiler construction codes.
- o Report on the identification of power house piping.
- o U.S. Environmental Protection Agency (USEPA) - noise level of vent, etc.
- o Maximum boiler water concentrations, recommended by American Boiler Manufacturer's Association (ABMA) chemical feed system.
- o ABMA boiler standards.
- o AISC manual on steel construction.
- o ASHRAE standards.

Boiler Trim: Each boiler unit shall be furnished with boiler trim, in accordance with the ASME code requirements as well as conforming to the best standards of power plant practice. Trim shall be designed for a minimum of 125 percent of the nominal operating pressure (PSIG). Each boiler unit shall have manual override systems, which also overrides the boiler auxiliary equipment, located and operated from the plant central control room.

The following list of accessories, at a minimum, are required. The final number and type of accessories shall be determined by the Contractor based on the water circulation and steam distribution designs.

- o Safety valves as per ASME code.

- o Water column, feed water regulator, gauge and glass drain valves.
- o Reliance water column with high and low alarm and water gauges.
- o Low-water cutoff.
- o Water column drain valves and water gauge drain valves, rated for twice the operating pressures.
- o Feedwater regulatory by-pass and drain valves.
- o Feedwater stop and check valves.
- o Drum blow off valves.
- o Boiler air vent valves.
- o Chemical feed valves.
- o Continuous blowdown stop and check valves.
- o Tube rapping - elements, supply and drain valves (if required).
- o Steam and water flow transmitters.
- o Differential level transmitters.
- o Computing relays.
- o Auto-manual set point control station.
- o Air sets.
- o Main steam non-return valves.
- o Feedwater control valves.

Superheater Steam Piping Systems: The high pressure superheated steam piping systems shall be designed in such a way that the pressure drop between the main steam valve of the boilers and the main valves of the turbine, does not exceed ten percent of the nominal boiler pressure and that the drop in temperature does not exceed 10°F. A loop header shall be provided to insure the most flexible mode of operation as well as maintenance.

Reducers and coolers of steam pressure shall be installed so that each facility can bypass the turbines. There shall be no steam released directly into the atmosphere except where silencers are installed to reduce the noise level below 80 decibels (dba). The condensate drainage system of the high pressure superheated piping system shall be designed such that the condensate is recovered.

Feedwater Systems: The feedwater treatment systems shall be capable of handling a minimum of 100 percent of each facility's make-up water requirements. The systems will treat water to meet each facility's boiler water quality requirements.

There shall be one high pressure boiler feedwater pump for each boiler and one standby (backup) pump for every two boilers installed. High pressure boiler feedwater pumps shall be equipped with dual (electric and steam) drives. The feedwater system shall be designed in such a manner that achieves the maximum flexibility within the system.

The pumps shall be designed for operation at a maximum water temperature of 350°F, unless the Contractor's designed thermodynamic cycle demands otherwise.

Deaerator Systems: The water deaerator systems shall be designed in accordance with the applicable ASME codes. The deaerator storage tanks shall have a minimum ten minutes of storage of the plant's full load. The working pressure shall be suitable for the designed thermodynamic cycle of the facility. There shall be two, 100 percent capacity deaerators. The Contractor shall specify and guarantee the oxygen and carbon dioxide (CO<sub>2</sub>) removal at any load between five percent and one hundred percent of the rated capacity. The Contractor shall also specify the amount of steam loss while the oxygen and CO<sub>2</sub> is being released through the deaerators. The Contractor may supply and install steam accumulator systems in order to avoid a severely fluctuating steam flow caused by the variation in the Processable Waste Btu/lb content.

Condensate System: Surge tanks for receiving the returnable condensate from the process shall be provided by the Contractor. The size and number of surge tanks depend on the amount of condensate returned and shall be determined by the Contractor. The returnable condensate is that condensate which can be reused without any major form of treatment.

Special Requirements: Boiler auxiliary equipment items shall have as a minimum the same degree of availability and reliability as the facility. Where necessary redundancy of any auxiliary equipment is required, it shall be supplied in the form of spare units.

All auxiliary equipment shall be automatically controlled with manual override systems, all of which shall be controlled from the facility's central control room.

Water Usage, Quality and Treatment: This section pertains to water that is to be used as:

- o Make-up water for steam generating systems.
- o Internal facility consumption (domestic and process uses).

Boiler water for the northern facility may be supplied by water lines from the Broward County water system. Table B-3 in Section 1.2.7 of this appendix, presents the 1982 annual average for water quality values for the County's System 1-A.

Water service by either Broward County or the City of Fort Lauderdale to the southern site may be possible. Tables B-2 and B-1, also in Section 1.2.7 of this appendix, provide annual average water quality values for the System 3-A plant (Broward County) and Walter E. Peele Plant (City of Fort Lauderdale), respectively.

#### 1.10.6 Combustion Controls

At each facility controls shall be provided to monitor water level, furnace combustion temperature, steam flow, and exhaust gas temperature and volume. Combustion air modulation shall also be provided.

Controls shall consist of systems for Remote Automatic, Local Manual, and Remote Manual modes.

#### 1.11 Residue Handling Systems

##### 1.11.1 General

The solid residues from each facility must be managed and disposed of according to Federal and State standards for resource recovery facilities. The Proposer shall indicate the quantity and composition of residue ash expected to be produced at each facility from the furnace/boiler and air pollution control systems. The Contractor shall be responsible for ensuring that this residue ash, will not be considered hazardous based on applicable Federal and State regulations and requirements.

The Contractor will also be responsible for residue removal, transportation and landfilling, and all testing necessary to determine whether the residue is hazardous according to the applicable Federal and State regulations.

##### 1.11.2 Description

The purpose of the residue handling systems is to collect the post-incineration bottom ash and fly ash while separating any recyclable materials in a dust free manner. The systems shall have two, one hundred percent capacity ash conveyors to transport the ash to the handling areas at each facility.

Provisions for tractor-trailer loading in an enclosed area, with ventilation and dust control shall be incorporated into the design. A clamshell-type bucket for loading ash onto trucks from an ash storage pit may be provided.

The Proposer shall indicate the marketability of ash, if any. The residue ash shall contain less than 4.0 percent combustibles, and less than 0.2 percent putrescibles. The residue shall be such that it will not support any type of animal or vermin life and will not sustain combustion.

### 1.11.3 Bottom Ash

The Contractor shall design the furnace connection of the ash discharge chute to be the full width of the final grate section to prevent blocking of the chute from the burn-out grate section. The distance from the end of the stoker to the furnace rear wall shall be at least equal to the height of the boiler feed throat lintel above the stoker feed section.

The bottom ash or residue shall be water cooled by spray or quenched in tanks or sumps before it is handled by the conveyors. The cooled bottom ash handling systems shall consist of drag or vibrating conveyors designed to handle the total plant load.

The Proposer shall specify water usage for residue quenching. Boiler blowdown may be used for ash quenching.

After removal of the residue ash from the water cooling system by the conveyors, the residue ash may be moved from the furnace/boilers to the ash storage area by either drag, belt, or vibrating conveyors designed for heavy duty service.

The drag conveyors, if included in the proposer's design, shall be extra heavy duty type with double strands (chains), steel flights, and with drives of the hydraulic infinitely variable speed type.

The vibrating conveyors, if included in the proposer's design, shall be natural frequency, balanced type, not requiring special foundations.

The belt conveyors, if included in the proposer's design, shall be of a trough type.

All conveyors shall be equipped with safety devices and zero speed switches.

### 1.11.4 Fly Ash

The fly ash may be combined with quenched bottom residue ash removed by the residue ash conveyors. Separate collection of the fly ash may be utilized should the Proposer wish to market the fly ash for re-use.

The fly ash handling systems include, but are not limited to, screw conveyors inside precipitator hoppers, rotary or double flap air lock valves, and dry drag type transfer conveyors.

#### 1.12 Air Pollution Control Systems

Except as may be required under applicable law, the air pollution control systems at each facility shall consist of one electrostatic precipitator and one induced draft fan per combustion line.

##### 1.12.1 Electrostatic Precipitators

Each combustion line shall be equipped with an electrostatic precipitator (ESP) including all appurtenances, structural supports, foundations, external and internal walkways, platforms access stairways, fly ash hoppers with discharge air lock valves, power and control wiring, and other accessories for a complete operation system.

Each ESP shall be a multi-field type with the output of each ESP's flowing into a single flue. The fields shall be sized adequately considering both the volume of gases and amount of excess air. The temperature of flue gases entering the ESP must be below 600°F and at least 40°F above the dew point temperature.

The U.S. Environmental Protection Agency's (USEPA) best available control technology (B.A.C.T.) shall define the minimum efficiency of the ESP's. The Contractor shall guarantee ESP performance. For the purpose of proposal submission, Proposers shall assume that the ESP outlet gases shall not exceed 0.03 grams per cubic foot of air. The actual required removal rate shall be determined during the permit negotiation process with the appropriate regulatory agencies.

Each ESP design submitted shall have been successfully operated in a facility firing Processable Waste for a minimum of three years. The proposed ESP shall not have been scaled up more than 25 percent over previous installation.



Casing and hoppers of each ESP shall be enclosed with weather resistant materials.

ESP structural design shall be based on all applicable codes as to dead, live, wind and seismic loads, using all external structural members, rigid frames, etc. Internal bracing exposed to the gas flow is not allowed. All design, fabrication and installation shall be in accordance with all applicable design codes and standards.

ESP internal walkways shall be provided at the inlet and outlet nozzles and between fields.

All ESP induction motors shall be extra severe duty high efficiency type, with a minimum guaranteed efficiency value which shall be confirmed by NEMA test standard MG-1-12.53a, (IEEE test procedure 112. Method B) using accuracy improvement by segregated loss determination including stray load loss measurement. All motors shall be labeled with the NEMA efficiency.

All ESP steel casing in contact with the flue gas shall be of ASTM A 242 steel; external structural members shall be ASTM A36 steel.

ESP gas distribution shall be accomplished via a low velocity, multiple vane system or a perforated plate system. It should be noted that as part of the contractual requirements of the selected Contractor, model studies of geometrically similar units shall be submitted for evaluation.

ESP collection systems shall consist of formed rolled ASTM A242 sheet of manufacturer's standard design.

ESP collecting surface rapping shall be by shaft-driven rotary hammers. Solenoid impact or vibration rapping is not acceptable.

ESP high voltage systems shall have star shaped, spiked stainless steel electrodes, rigid mast mounted; and high alumina refractory type insulators. Weighted wire systems will not be acceptable.

ESP discharge electrode rapping shall be accomplished by shaft mounted rotary hammers; solenoid impact or vibrating rapping is not acceptable.

ESP electrical systems shall be in accordance with ASA, AIEE, MENA and National Electrical Code requirements, designed by manufacturer. All operational functions controlled remotely from central control room. High voltage field control panel shall include all solid state, full wave bridge, thyristor type regulated D.C. supply with protective reactances. Saturable reactor systems are not acceptable. Key-type safety interlocks with sequential key arrangements shall be included on all precipitator access doors, rectifier enclosure access doors, high tension switching, and control units circuit breakers.

Minimum ESP remote control functions shall include:

- o Transformer overload alarm.
- o Precipitator failure alarm, if field ceases to operate, or if a long-term precipitator under voltage condition exists, while precipitator control is in on position.
- o Isolated contact for precipitator field.
- o Remote on-off switching.
- o Hopper and insulator heaters failure alarm.
- o Rapper start-stop-failure alarms.
- o Flyash conveyor start-stop failure alarms.
- o Flyash discharge air lock valves start-stop failure alarms.

ESP insulation (nozzles, sides, roof and hoppers) shall be mineral wool block or fiberglass blanket, applied directly onto the precipitator casing. Stiffeners and other structural members attached to the casing shall be wrapped with an insulating blanket.

ESP lagging shall be aluminum panels, except for the roof of the precipitator. Roof insulation shall be protected by purlins and metal panels which shall be designed for appropriate loads.

ESP flyash hopper heaters shall be the resistance type extending two thirds of the ash hopper height from the bottom of the hopper (to prevent blockage).

#### 1.12.2 Induced Draft Fan Systems

Each furnace-boiler shall be equipped with an induced draft fan, an induced draft fan drive, an induced fan inlet damper, and appropriate breechings.

Induced Draft Fans: Induced draft fans shall be centrifugal, backward curved inclined blade, treated-radial tip type, designed for continuous operation at 600°F, in a dusty environment.

The fans shall conform to the following minimum requirements:

- o Fan speed not to exceed 750 RPM.
- o Equipped with access doors.
- o Insulation and lagging in accordance with that required for the ESP's.
- o Test block capacity factor: 1.15.
- o If erected on an elevated structure, the I.D. fans shall be mounted on spring-loaded inertia bases.
- o Fan blades shall be lined to withstand corrosion.

Induced Draft Fan Drives: The induced draft fans shall be coupled to electric variable speed drive systems consisting of either direct current drive motors with AC/DC

converter or AC variable speed motors and operator control stations, as required.

The drive HP shall be a minimum of 115 percent of the fan test block BHP. The control system shall include positive acceleration on demand and deceleration by inertia.

Induced Draft Fan Inlet Dampers: The induced draft (I.D.) fan inlet houses shall be fitted with parallel blade type inlet dampers designed and manufactured for 600°F continuous operation. The dampers shall conform to the following minimum requirements:

- o Blades - ASTM A242 steel plates, air foil type.
- o External blade linkages.
- o End shaft connection with a universal joint (rigid jack shaft coupling not acceptable).
- o Damper operators - Worm gear reducers with beveled gear attachments and AWWA limit stops.

Induced Draft Fan Breechings: All breechings shall be of ASTM A-242 steel plate, reinforced as required. I.D. fan inlet and outlet breechings shall be connected to the I.D. fans via flexible joints and supported independently of the I.D. fans housings.

Shaft extension shall be fitted with a manual handle and a locking arrangement.

All breechings shall be insulated and lagged in accordance with that required for the ESP's.

I.D. fan outlet breechings shall be designed to enter stack(s) at not less than a 45 degree angle.

### 1.12.3 Stacks

The height of stacks at both sites is to be limited to 200 feet above final grade elevations.

The stacks shall include access ladders, a test platform located at the point required by testing procedures, test ports, access doors at the base of the stack, lightning

protection system, and obstruction warning light system. Structural designs shall take into consideration all dead, wind and seismic loads, and shall include natural frequency vibration analysis where applicable.

Heights of the stacks shall be based on draft considerations and residual pollutant dispersion analysis in accordance with latest USEPA regulations along with Federal Aviation Authority (FAA) requirements since the sites are near commercial airports.

The stacks shall have one flue per combustion line and shall include provisions for a possible additional line.

### 1.13 Turbine-Generator Sets

#### 1.13.1 System Design

At each facility the turbine-generator set shall consist as a minimum of the following component items:

- o Turbine
- o Generator
- o Cooling Systems
- o Operating Controls

At each facility, the Contractor may provide one multiple stage turbine generator set sized at 100 percent of the maximum generation rate.

Proposers should be aware that the Florida Public Service Commission's proposal rules and regulations, for qualifying alternative energy generation facilities, does contain provisions for minimum on-line generating reliability. Consequently, the Proposer may wish to consider incorporating more than a single turbine generator set at each facility. Should a Proposer wish to consider two turbine generator sets at either, or both, facilities, the Proposer shall be aware that Florida Power and Light may have limitations on the minimum size turbine generator installed.

Design of the turbine-generator sets shall also take into consideration the installed capacity, the available power and the spinning reserve power of the turbines.

The turbine-generator sets shall be designed such that no loss of energy production, either thermal or electrical, occurs throughout the lifetime of each facility. Each facility shall be able to process Processable Waste at full capacity even during scheduled and unscheduled outages of the turbine-generator sets.

The spinning reserve power of the turbines shall be such that variations in the steam mass flow from the boilers can be accepted without overloading the turbines.

#### 1.13.2 Turbines

The turbines shall be radiographically tested, magnetic particle inspected, and sonic tested, as outlined in the currently applicable ASTM specifications.

The turbines, which shall be rated in accordance with the requirements of these specifications, including boiler steam output at 650 psia and 750°F, shall rotate at 3600 rpm, and shall be directly connected to the generator and shall drive the generator described herein as an integrated unit.

The turbines shall be designed for continuous operation, even if pressure at the turbine main steam stop valve rises to, but does not exceed, 105 percent of turbines rated pressure.

The average steam mass flow into the turbines shall be based on a boiler steam output of 650 psia and 750°F.

#### 1.13.3 Generators

The generators shall be alternating current synchronous generators rated in accordance with the requirements of these specifications and shall be directly connected to and driven by the turbines described herein.

The generators shall be of the nonsalient pole revolved field type.

The telephone influence factors of the generators shall be in accordance with the latest ANSI Standards.

The deviation factor of the open circuit terminal voltage wave of the generators shall not exceed ten percent (as defined by ANSI standards).

The generator armatures shall be capable of operating at 130 percent of rated armature current for at least one minute, starting from stabilized temperatures at rated conditions.

The generator field windings shall be capable of operating at a field voltage of 125 percent of rated load field voltage for at least one minute starting from stabilized temperatures at rated conditions.

The generator will be capable of withstanding, without injury, the thermal effects of unbalanced faults at the generator terminals, including the decaying effects of field current (where protection is provided by causing field current reduction, such as with a field breaker or equivalent) and the DC component of the stator current, for times up to 120 seconds, provided the integrated product ( $I t$ ) of generator negative phase sequence current ( $I$ ) and time ( $t$ ) does not exceed 30 seconds.

The generator shall be capable of withstanding, without mechanical injury, and type of short circuit at its terminals for times not exceeding the short time thermal capabilities, when operating at rated KVA and power factor and five percent overvoltage, provided the maximum phase current is limited by external means to a value which does not exceed the maximum phase current obtained from the three-phase fault. In the case of stator windings, the criterion for no injury is that the windings will satisfactorily withstand a normal maintenance high-potential test. There will also be no visible abnormal deformation or damage to the winding coils and connections resulting from this test.

The generator shall be suitable, for operation at rated KVA, power factor, and frequency at any voltage not more than five percent above or below rated voltage, but not necessarily in accordance with the standards of performance established for operation at normal rating.

The generator shall be capable of operating continuously at full rated load under usual service conditions. The total temperatures as determined by any of the methods given in ANSI standards shall not exceed 110°C for the stator coils and 125°C for the field when operating at full load or below.

#### 1.13.4 Cooling Systems

General: The following information pertaining to cooling systems is included to provide Proposers with the appropriate systems and project site constraints that may impact upon the actual implementation of a cooling system at the selected sites. The cooling method at each facility may eventually be:

- o Once through cooling (surface condenser).
- o Evaporative cooling (evaporative cooling tower).
- o Air cooling (air cooled condenser).

The final determination of the actual cooling system that will be utilized will be made prior to the approval of the final Contract Agreement.

For the purposes of this proposal submission, however, proposals shall be based upon the utilization of an air cooled system at both sites.

At each facility the steam turbine(s) condenser(s) shall be designed to meet maximum boiler ASHRAE output without any steam being extracted for process, for the hottest day in the year, as per the Florida Weather Bureau, for the Broward County area.

The Proposer shall provide cooling systems sized to condense the exhaust steam for the turbine(s) assuming all



boilers are in operation. Reducers and coolers of steam pressure shall be installed so that the facility can also bypass the turbine(s) and condense the total output of all boilers under maximum steam generation. Sustained venting of steam shall be avoided. The condensing system shall be valved and piped to increase operation and maintenance flexibility.

The following sections provide information to acquaint Proposers with the conditions that may impact on the final selection of the cooling systems at each of the selected sites.

Northern Facility (Copans Road Site): For consideration of a once through cooling systems, Contractors should be aware that the North Broward Regional Wastewater Treatment Plant lies just to the east of site selected for the Northern Resource Recovery Facility. The following information is provided for the period of August, 1982 through May 1983, on effluent from this facility.

	<u>Min.</u>	<u>Max.</u>
Daily Flow (MGD)	-	64.21
Minimum Hourly Flow <sup>(1)</sup>	10.0	-
Chlorine Residual (ppm)	0.5	2.4
BOD (mg/l)	2.0	13.0
TSS (mg/l)	3.0	22.0
pH	6.7	7.4
Fecal Coliform	<10.0	160.0
Temperature (°F)	78.0	86.0

(1) MGD basis occurred in August, 1982.

The effluent from this facility is currently discharged through an ocean out-fall with a maximum temperature discharge limitation of 97°F.

In order to consider once through cooling using closed loop surface condensing (evaporative cooling is unacceptable using wastewater treatment plant effluent) the following additional costs must be investigated:

- o Cooling water supply and return system remote controlled variable speed pumps (one on, one

standby); supply and return piping; power and control wiring; hyperchlorination and straining system.

- o Modifications and/or alternations required to the wastewater treatment plant.
- o Satisfying wastewater treatment plant environmental permit conditions established by the State of Florida DER, including any ocean out-fall limitation on effluent discharge temperature.

For consideration of evaporative cooling at this site, the sources of water are limited to County water, as supplied by the County System 1-A plant, or ground water. With respect to County water, average annual water quality values are presented in Table B-3 of this Appendix. The Contractor will be responsible for determining makeup water requirements and County water availability to satisfy such requirements. With respect to utilization of groundwater, Appendix B, Environmental Specifications, of the RFP contains data regarding the underlying aquifers in this area.

Southern Facility (Route 441 Site): Steam plumbing is of major concern at this site due to the proximity of Fort Lauderdale International Airport. Consequently, the consideration of evaporative cooling tower(s) at this site, such towers would be limited to a wet-dry type to eliminate visible plume formation which would occur under certain wet bulb and relative humidity conditions.

City and County water (refer to Tables B-2 and B-3) or ground water may be considered for evaporative cooling use. As in the case for the Northern Facility, the Contractor shall be responsible for determining make-up water requirements and city water availability to satisfy such requirements.

Summary: The data presented above regarding cooling systems is provided for informational purposes and for future reference only. All proposers are required to base

their proposals on air cooled systems for comparison purposes. The actual cooling systems utilized at the selected sites will be determined during contract negotiations.

#### 1.14 Process Control Systems

##### 1.14.1 Local Automatic Control Systems

At each facility these systems shall provide for automatic shutdown of certain critical operations in the processes. This shall include, but not be limited to:

- o Turbine Generator(s)
- o Electrostatic Precipitators
- o Conveyors
- o Induced Draft Fans
- o Pumps
- o Stokers

These local control systems shall identify their actions to the remote central control systems.

##### 1.14.2 Remote Automatic Control Systems

These on-line, real time systems shall provide automatic operation, control monitoring and data trending and logging of all plant process from the Central Control Room (CCR) of each facility, by means of a computer based central processing units (CPU).

The CPU's shall continually monitor the parameters of all the plant's process systems. The monitored data shall be used by the CPU's to determine whether the process lines are operating correctly, to identify any alarm conditions to the CCR operator that arise, and to generate operating and management reports.

The CPU's shall automatically control the operations of all process line component systems. Such control shall be in conjunction with any local control systems specified elsewhere in the RFP.

At each facility the systems shall provide to the CCR operators an interactive control station from which the operators shall institute process system startups and shut-downs, and affect modifications to all operating parameter setpoints.

The systems shall automatically optimize the operation of each process line by the proper coordination of the line's component systems, including, but not limited to: furnace grate speed control, under and over fire air feed control, temperature control, and boiler feed water control systems to provide maximum efficiency in steam generation.

The ratio of under and over fire air shall be automatically adjusted to compensate for the Processable Waste's moisture content so that a selected furnace temperature is maintained and complete burnout is obtained. The Processable Waste feed rate, grate speed and combustion air volume shall be adjusted to maintain optimum steam generation and complete burn-out.

The CPU's shall provide data logging and trending of all process parameters, including operator inputs to the system.

The systems shall be computer based and shall have a minimum of two CRT/keyboard operator stations and one printer for logging at each facility.

The mainframe processor (CPU) shall have sufficient memory capacity to contain all software operating systems and shall use, and be furnished with, mass storage devices of the rigid disk type for maintaining event data files, etc. Two magnetic tape drives shall also be furnished with each CPU and used for recording event data for off-line processing. Each CPU shall have a real time clock.

The CPU's shall perform an auto restart after a power failure and restoration of power. Floppy disks may be used for system initialization and restarts requiring software reloads. However, Floppy disks shall not be used for any continuous system function.

At each facility a priority software interrupt system shall be furnished and all high priority alarms shall be individually hand wired into this system, e.g., high steam pressure, malfunction of boiler feed water pump, etc. The CPU's shall instantly respond to all priority interrupts received and indicate appropriate action.

In the event of system malfunctions and/or alarms, the CPU's shall identify the event to the operator in fully description English text and shall also "prompt" the operator with a complete list of the actions to be taken in response to the specific event.

The CPU's shall monitor all process operating parameters and shall maintain and store the same for a minimum period of 30 calendar days.

The CCR operators shall have access to this stored data and be provided with requested hardcopy printouts of a specified parameter over a specified period of time.

#### 1.14.3 Local Manual Control Systems

At each facility these systems shall provide manual on/off and lock-out controls for all moving equipment in the processing systems, i.e., electric motors, hydraulic or steam driven devices, etc. The manual control systems are required specifically for the safe performance of maintenance operations and for equipment testing and startup operations. The remote control systems shall monitor the status of these local manual controls and take appropriate action in response to the status indicated.

#### 1.14.4 Remote Manual Control Systems

At each facility these systems shall provide for the manual operation of the plant's process lines from the plant's central control room. The systems shall be operated from a control and information display board which shall contain start/stop controls for all process operations, instrumentation indication of all critical and necessary parameters

remote automatic control system and to other facility equipment requiring UPS for its protection in an emergency.

This UPS shall include a converter and a battery storage system. The converter shall have, but not be limited to, a separate isolation step-down transformer, a solid state inverter bypass switch, an automatic transfer switch, input and output circuit breakers, meters, pilot status lights, low alarm, output frequency meter, manual TS control and fault alarm.

The battery storage system shall include lead-calcium batteries, tiered storage racks with interconnecting metal straps, and battery charger. The capacity of the UPS systems shall be twelve hours and shall be rated at not less than 50 KVA for the northern facility and 100 KVA for the southern facility, 120 volt, single phase outlet with one-hour battery reserve power.

#### 1.14.8 Process Alarms

At each facility alarm annunciators shall be provided to alert the control room operators or other operators/attendants to abnormal process conditions of particular importance. These alarm systems will sound until acknowledged by the operators, and the status lights for the alarms will continue to be "on" until the abnormal conditions are attended to.

The various alarms shall be organized on annunciator panels located in the central control room. In addition, duplicate alarms shall be located at local alarm stations, such as the stoker panels, the turbine-generator rooms, the water treatment system rooms and the precipitator control consoles.

#### 1.14.9 HVAC

All central computer system areas and all UPS battery storage areas shall be provided with the special air conditioning required for each area's proper operation.

Each battery storage area shall have a continuous exhaust of air to prevent hydrogen buildup and the area's temperature shall not exceed 85°F to prevent shortening of the batteries' life.

Each computer room shall have a floating floor which shall be utilized for all cable entry to the equipment and for forced air ventilation of the equipment cabinets. The ambient temperature in each room shall be maintained at 70°F, but in no case shall the temperature within any equipment cabinet be allowed to exceed 85°F.

#### 1.15 Facility Security and Communication Systems

##### 1.15.1 Facility Security

The Contractor shall be solely responsible for providing adequate security at each site, both during construction and operation of the facility.

Security during operation of the facility may include personnel, video, lighting, as well as electronic alarms. One, or a combination, of the methods shall be instituted at the Contractor's discretion.

##### 1.15.2 Communications

The communications systems shall include the following services at each facility: telephone, intercom, public address, and two-way radio.

##### 1.15.3 Security Lighting

Security lighting shall be provided on the exteriors of all facility buildings, in the vehicle parking lot(s), and on the entire perimeter fence. The type of light fixtures and the footcandle level of the illumination shall, as a minimum, be high pressure sodium and 2.5 foot candles.

SECTION 2  
LANDFILL TECHNICAL SPECIFICATIONS

2.1 Introduction

As with the preceding technical specifications for resource recovery facilities, the purpose of these landfill technical specifications is to set minimum guidelines and functional design requirements to insure comparable proposals of uniform quality.

In addition, the County has initiated the permit application process with the appropriate government agencies, for the Residue/Unprocessable Waste landfills. As part of this activity, the County has and will continue to develop permit submittals containing landfill plans. The Proposals developed by the Proposers must conform to the plans and requirements contained in these permit submittals. As an example, a landfill liner, leachate control system and stormwater drainage system will be required at each of the landfills as part of the permit conditions. As a result, these items must be treated as required in each Proposal.

The Proposer is not limited to these minimum requirements and guidelines, however, should the Proposer desire to change the functional design requirements described herein, the Proposer shall utilize Proposal Form 5.3 of the RFP to describe the change.

The Proposer shall provide for the design, construction and operation of separate Residue/Unprocessable Waste landfills, together with the associated landfill facilities at the northern and southern resource recovery sites. Descriptions of these sites are provided in section 4.7 of the RFP. More specifically, development of these landfills shall include but not be limited to the following at each landfill:

1. Construction and maintenance of access roadways and parking areas.



2. Furnishing, installation and maintenance of a site security system.
3. Furnishing, installation, operation and maintenance of a truck weighing scale.
4. Furnishing, construction and maintenance of a scale building.
5. Furnishing, construction and maintenance of an equipment shed.
6. Furnishing, installation, and maintenance of land-fill liners.
7. Furnishing, construction, operation and maintenance of leachate collection and disposal systems.
8. Construction and maintenance of storm water drainage systems, including installation, operation and maintenance of injection well systems.
9. Clearing and grubbing of trees, brush, shrubs, and stumps within the limits of the site.
10. All excavating, backfilling and disposing of all materials, including unsuitable muck material, encountered at the site as required for the purpose of constructing structures, conduits, pipelines, roads, grading and other facilities required to complete development of the site.
11. Provisions for water, sewage, fire protection, and other utilities.
12. Furnishing, installation, operation and maintenance of a gas control system.
13. Furnishing, installation, and maintenance of ground-water monitoring wells.
14. Placement and compaction of select fill, as required, to increase site elevations to 100 year flood elevations prior to placement of solid waste.

In all cases, the above described work, and any other work required to complete the design, construction and operation of the Residue/Unprocessable Waste landfills, shall be in compliance with all applicable federal, state, county and local rules and regulations.

In addition to the development and construction of the Residue/Unprocessable Waste landfills, the Proposer shall be responsible for the operation, maintenance and final closure of these landfills.

## 2.2 General Design and Construction Requirements

In addition to the specific design requirements described in the site work section, the Contractor shall meet the following general design requirements:

- o The bottom of the landfills must be at least 5 feet above the groundwater table. To provide a suitable base for constructing the landfills it will be necessary to remove all unsuitable materials and to place clean fill on the site to establish the 5 foot separation of the groundwater table and the landfill bottom. If excavation uncovers an unexpected water table that cannot be lowered the excavated area must be backfilled to a point that will provide the necessary 5 foot separation.
- o Select fill must be placed and compacted wherever necessary to increase grade elevations to 100 year flood elevations. This will insure that solid waste will not be placed in future flood waters.
- o The top slope of completed landfill sections must be maintained at 2 percent or greater for drainage and the slopes at the sides of the fill should not be steeper than 3 horizontal to 1 vertical.
- o All materials and equipment used in the construction of the landfill should be handled, stored and installed in accordance with the manufacturer's recommendations.
- o All concrete structures, including drainage ditches, shall be constructed on a 12-inch layer of clean, fill. Backfill structures shall be backfilled with 12-inch thick layer of clean fill all around and tightly compacted.
- o Erosion control measures such as straw bales, silt fences and temporary seeding must be utilized to keep erosion of soil to a minimum.
- o A sufficient number of ground water monitoring wells shall be provided to determine ground water flow

direction, background ground water quality and sub-surface geology, as required by the appropriate regulatory agency(ies).

- o A landfill liner system shall be installed and maintained to contain infiltrated rainfall in accordance with the requirements of the Florida Department of Environmental Regulation (DER) and Broward County Environmental Quality Control Board (BCEQCB).
- o A leachate collection system shall be installed, operated and maintained to collect and remove leachate from the landfill in accordance with the requirements of the Florida DER and BCEQCB.
- o A storm water drainage system shall be installed, operated and maintained in accordance with the requirements of the South Florida Water Management District. As part of this system, injection wells will be required. Typical specifications for injection wells are provided in Appendix G of the RFP for informational purposes.

Conceptual layouts of the northern and southern landfills are included in the RFP as Figures 2 and 3, respectively.

### 2.3 General Operational Requirements

As part of the operational requirements, the Contractor shall develop operational procedure and maintenance manuals, which shall include, but not be limited to, the following items:

- o Operation hours;
- o Weighing procedures;
- o Vehicle flow and unloading;
- o Waste handling procedures;
- o Placement of cover;
- o Maintenance procedures;
- o Operating procedures for various weather conditions;

- o Fire prevention procedures; and
- o Salvage and screening policy and procedures.

In addition to the development of operations and maintenance manuals, the general operational requirements for the Residue/Unprocessable Waste landfills include:

- o All of the permanent facilities that will impact on the proposed landfill must be constructed prior to placement of waste in a new area. This includes such items as storm drainage lines and ditches, liner and leachate collection system, monitoring wells, haul roads and gas vents.
- o Temporary measures that must be pursued on a continuous basis include temporary surface water diversion ditches, erosion control measures, and fencing to control blowing paper.
- o The solid waste shall be covered according to the requirements of the applicable regulatory agency(ies). Final cover, however, shall consist of a layer of impervious material having a permeability of 10<sup>-5</sup> cm/sec or less, topped with sufficient topsoil to support the growth of vegetative cover. Vegetative cover must then be established to prevent erosion.
- o Burning of waste shall not be allowable and hazardous waste shall not be acceptable for disposal at the sites.
- o A minimum 100 foot separation distance shall be maintained between fill areas and property boundaries. (Zoning Ordinances and permit requirements may necessitate larger separation distances).
- o Initially, gas monitoring wells shall be tested once a month. If explosive limits of gas are detected, then a more extensive monitoring program should be developed. This more extensive monitoring program could involve additional monitoring wells as well as mitigating measures to stop the migration of gas.
- o Ground water samples shall be taken in accordance with regulatory requirements and guidelines and shall be tested for those parameters required by the applicable regulatory agencies.
- o After an area of the landfill is completed and final cover is applied, regular checks of the area will be

made to determine if any erosion is taking place. Any eroded areas will be filled and a dense stand of grass established. An active ground water and gas monitoring program meeting the requirements of the Florida Department of Environmental Regulation will be carried out to make sure the landfill does not have an adverse effect on the environment.

#### 2.4 Environmental

The Proposer shall assume and provide that, the design, construction, and operation of the Residue/Unprocessable Waste landfills shall comply with all applicable federal, state, county and local environmental regulations and standards in effect as of the proposal submission due date, unless otherwise advised in writing by the County. These environmental requirements will cover all air quality, water quality, traffic, noise, odor/vector control, residue, and community impacts. In particular, the design, construction and operation of the Residue/Unprocessable Waste landfills shall at all times be in compliance with the rules and regulations of the Florida Department of Environmental Regulation, specifically Chapter 17-7 Resource Recovery and Management; Part I: Solid Waste Facilities. Specific mitigating measures will be necessary at the southern site to minimize the environmental input on the South New River Canal. A discussion of these measures is provided in the "Land Use and Environmental Overview of the Route 441 Site" dated February 1983. Copies of this report are available at the office of the Project Administrator.

The Proposer shall itemize the measures by which all adverse environmental impacts will be mitigated including design features, construction procedures, operating procedures, and control hardware.

Attendance and participation at meetings and hearings will also be required of the Proposer and others retained by the Proposer in connection with the permit approval, and certification process. A listing of the environmental permits

and regulations that may be applicable to these landfills is provided in Appendix B of the RFP.

Information pertaining to the Proposer's Residue/Unprocessable Waste landfills is to be provided in the proposal on Form 5.4- Technical Data; Section 5.4.5 Residue/Unprocessable Waste Landfills. Specifically this section requests information concerning the following:

- o Development plan.
- o Type of security system.
- o Operations plan.
- o Liner system.
- o Leachate system.
- o Closure cover.

The Proposer may provide additional information by attaching supplemental sheets to the proposal.

The following sections are intended to provide an overview of the environmental requirements for the residue/unprocessable waste landfills. These requirements include but are not limited to:

2.4.1. Design and Construction Requirements

During construction of the landfills, the Contractor will be required to:

- o Control or prevent fugitive dust emissions.
- o Prevent the depositing of dirt and construction debris on neighboring streets and properties.
- o Provide for control of soil erosion and sedimentation of existing water courses.
- o Provide appropriate disposal for any water removed through dewatering.

2.4.2. Operations Requirements

During operation of the landfills, the Contractor will be required to:

- o Train special environmental personnel.
- o Prepare operational procedure and maintenance manuals.
- o Develop practices to define the nature and quality of waste input to prevent the processing of obnoxious, undesirable, and hazardous material at the landfills.
- o Prevent dirt and debris from being deposited on neighboring streets.
- o No solid waste shall be disposed of:
  - within 200 feet of any natural or artificial body of water, except canals used to lower site water tables or bodies of water, contained completely within the site, which do not discharge from the site.
  - within 10,000 feet of the closest point of any runway at any airport licensed by the State of Florida, owned or operated by the United State, or subject to regulation by the Federal Aviation Administration which may be used by turbo-jet aircraft; or within 5,000 feet of any runway at any such airport used only by piston engine type aircraft unless it has been determined by the Federal Aviation Administration, or other appropriate federal or state agency charged with preventing airport hazards, that the proposed solid waste facility poses no safety hazard to aircraft in the vicinity.

#### 2.4.3. Water Quality Requirements

No substance shall be discharged into the surface waters, groundwaters, storm or sanitary sewer system without the approval of the applicable agency(ies) regulating that discharge.

Proposers shall provide sufficient information and data on the proposed landfills including any necessary leachate pretreatment process, to show how compliance with these regulations and standards would be achieved.

#### 2.4.4. Noise Impact Requirements

The proposal shall indicate, among other things, the methods to be used to safeguard both people working at the landfills and in neighboring areas from exposure to noise levels, greater than allowable thresholds, during both construction and operation.

The design and selection of equipment and construction materials should be made with consideration to the minimizing of noise generation within the site property lines and the transmission of noise beyond the property lines, and shall incorporate any design or operation measures requested by the County. The prevention of community nuisances due to excessive noise during construction and operation is extremely important to assure that the landfills are "good neighbors".

#### 2.4.5. Odor/Vector Control Requirements

The Proposer shall provide sufficient controls to insure that the landfills will not constitute a hazard to public health, safety, or property both on-site, and in neighboring communities.

The design of the Residue/Unprocessible Waste landfills and associated facilities shall include all necessary provisions as required by Federal, State and local laws and regulations to eliminate any potential problems with odor or vector control.



SECTION 3  
ACCEPTANCE TESTING REQUIREMENTS

3.1 Acceptance Testing

3.1.1 Pre-Acceptance Test Responsibilities of the Contractor

Each Proposer shall prepare, and submit to the County as part of their Proposals, a Preliminary Acceptance Test plan detailing the protocol to be followed for Acceptance Testing at each facility. It is understood that reference to an individual Acceptance Test implies and includes reference to both Acceptance Tests, unless expressly stated otherwise. The final Acceptance Test plan shall be submitted for County approval at least four months prior to the planned start of Acceptance Testing. The plan shall be a detailed test procedure. The plan shall include the methodology for monitoring facility processing capacity, residue quantity and quality steam generation, gross and net electrical generation, stack emissions, water discharges, traffic impacts and noise and odor during Acceptance Testing. The Contractor shall notify the County at least two weeks prior to the commencement of the Acceptance Test. The County will monitor the Acceptance Test to verify that the contractually agreed upon methods and procedures are being met.

3.1.2 Requirements for the Acceptance Testing

The Contractor shall provide all personnel, services, utilities, supplies, other than the County's committed Processable Waste, required to operate the Facility in accordance with the approved Facility Acceptance Test plan.

The Acceptance Test will determine if the Facility meets the specific performance requirements of the Construction Contract. During this testing period, the Facility shall be operated by operating personnel of the Contractor. Compliance

with full scale operational performance guarantees shall be determined by the Acceptance Test which will be conducted at the expense of the Contractor.

The Acceptance Test Procedure, provided below, shall be utilized to determine whether the Facility meets all of the environmental requirements and performance guarantees set. The County reserves the right to have its staff present for any or all testing.

All operations during Acceptance Testing shall be conducted in conformance with applicable Federal, State and local laws, standards and regulations.

### 3.1.3 Acceptance Test Procedure

Acceptance of the Facility shall be contingent on a successful Acceptance Test run comprised of the following:

- o Demonstrating the Facility's capability to meet all applicable environmental requirements as of the date of acceptance for stack emissions, residue quality and water discharges.
- o Demonstrating the capability of the Facility to receive and process the guaranteed tonnage (name-plate capacity) of Processable Waste for a continuous period of not less than 28 consecutive days.
- o Demonstrating the Facility's capability to produce the guaranteed plant throttle steam and net electrical energy output and the recovered materials output (if any).
- o Demonstrating the Facility's capability to prevent traffic from backing onto public roadways and to provide, at a maximum, vehicle turn-around time of 10 minutes.
- o Demonstrating the capability of the Facility to meet all other guarantees with respect to noise and odors.

Prior to any test run, all operating conditions shall be established and stabilized, the waste storage pits shall be emptied of all wastes, and the County shall be notified 14 calendar days in advance in writing when the test run shall

occur. The County shall be supplied with all test data forms. During the test run, all operating conditions which might affect the results of the test run, will be maintained as constant as possible recognizing the heterogeneous nature of the Processable Waste. All equipment and accessories shall perform in their normal mode of operation.

For the Facility to be accepted, there shall be no major scheduled or unscheduled outages during the consecutive four week, 28 day Acceptance Test period. Routine preventive maintenance shall be scheduled as presented in the Contractor's operating plan. Operations during the Acceptance Test run shall be of a routine nature.

#### 3.1.4 Environmental Testing

The Contractor will be required to retain the services of an independent consultant or laboratory subject to final approval by the County, for the purpose of conducting the following tests. The test protocol for the Environmental Testing shall be included with each Proposer's proposal responding to the RFP.

Stack Emissions Testing: Stack emissions testing shall be performed during the Acceptance Test period. Test protocol (methodology) for particulate and gaseous emissions testing shall be as approved by the Federal and/or State agencies having jurisdiction.

The Contractor shall be responsible for notifying appropriate jurisdictional agencies of the stack emissions testing schedule.

The testing results shall demonstrate conformance with the standards of the Federal and/or State agencies having jurisdiction as of the date of Acceptance.

Water Effluent Discharge Testing: Water effluent discharge testing shall be performed during the Acceptance Test period. Test protocol (methodology) for pH, BOD, COD, solids, temperature, flammability, corrosiveness and toxicity,

shall be as approved by the Federal, State and/or local agencies having jurisdiction.

The Contractor shall be responsible for notifying appropriate jurisdictional agencies of the water effluent discharge testing schedule.

The testing results shall demonstrate conformance with the standards of the Federal and/or State agencies having jurisdiction as of the date of Acceptance.

Residue Quality Testing: Residue quality testing shall be performed during the Acceptance Test period.

A. Combustible and Putrescible Content Test

Under this test, residue quality shall be demonstrated to be less than 4.0% combustible content and 0.2% putrescible content (dry weight basis).

If the Contractor's system combines the fly ash from the boiler hoppers and/or air pollution control system hoppers with furnace bottom ash, then the definition of residue quality shall apply to the combined ash.

If the Contractor's system segregates fly ash from the boilers and air pollution control systems for direct marketing as a recovered secondary material, then the definition for residue quality shall apply to furnace bottom ash only.

The proposed test protocol (methodology) for residue sampling and quality analysis shall be included with each Proposer's proposal responding to the RFP. The actual test protocol utilized during the Acceptance Test shall be as negotiated between the Contractor and County and included in the Construction Contract.

B. Hazardous/Non-Hazardous Test

Under this residue test, the Contractor shall perform tests in accordance with RCRA regulations and applicable Florida DER requirements to demonstrate that the residue complies with standards set forth therein determining whether the residue is non-hazardous.

Noise Testing: Noise testing shall be performed during the Acceptance Test period. The Facility will be required to meet the Broward County Noise Regulations established under Chapter 27-7 of the Code of Regulations of the Broward County Environmental Quality Control Board. A copy of Chapter 27-7 of these regulations is provided as Appendix H of the RFP.

Odor Testing: Odor testing shall be performed during the Acceptance Test period. The Facility shall be designed to minimize odors resulting from the handling, storage and processing of solid waste so as not to create a health hazard or public nuisance. Since odors represent air pollutant, the following criteria have been established. These criteria utilize odor concentration units which are defined as the number of standard cubic feet of odor-free air needed to dilute each cubic foot of contaminated air such that at least 50 percent of an odor concentration test panel appointed by the County does not detect any odor in the diluted mixture. The Project shall meet the following criteria:

- o Odors emitted from well-defined stacks 50 feet or more above grade evaluation and with adequate dispersion characteristics as determined by the County shall not be greater than 150 odor concentration units.
- o Odors emitted from sources less than 50 feet above grade elevation or otherwise failing to create good dispersion conditions as determined by the County shall not be greater than 25 odor concentration units.
- o No source shall emit odors in excess of 1,000,000 odor concentration units per minute.
- o No source shall emit air contaminants into the ambient air which cause odors outside the boundary line in excess of one odor unit.

### 3.1.5 Facility Capacity Testing

Total facility, as well as individual process line (furnace) Nameplate Capacity shall be tested during the

Acceptance Test period. In order to pass the Capacity Test, the facilities and the individual process lines must operate at their nameplate capacities for the testing period of 28 consecutive days.

The proposed test protocol (methodology) for facility and individual furnace nameplate capacity testing shall be included with each Proposer's proposal responding to this RFP. The actual test protocol utilized during the Acceptance Test shall be as negotiated between the Contractor and the County and included in the Construction Contract.

Prior to the initiation of the Capacity Test, the storage pits shall be empty to ensure that the quantity of Processable Waste that is processed during the Test is accurately recorded.

During performance of the Capacity Test, Processable Waste shall be sampled from the Facility receiving and storage pit, by an independent testing laboratory, approved by the County. Processable Waste samples shall be analyzed for proximate and calorific values for an as received/as fired basis.

#### 3.1.6 Energy Recovery Testing

The Energy Recovery Test, as described herein shall be performed when the boilers have had a minimum of two weeks operating time to allow the boilers to become fouled to a normal operating mode. This two week period can take place during the inception of the Acceptance Test period.

The Energy Recovery Test shall be performed in accordance with the Performance Test Code for Large Incinerators, ANSI/ASME PTC 33. During the Energy Recovery Test period, pertinent information shall be recorded at appropriate intervals and in accordance with the Test Code. Test measurements shall be taken from the installed plant instruments which have been previously calibrated, by an approved independent testing laboratory, and approved by all concerned, including the County. Special portable instrumentation may also be used

where required by the Contractor and agreed upon by the County.

Utilizing the test data and measurements, calculations shall be made in accordance with the Test Code for the determination of all boiler heat losses, heat outputs, and heat credits. All data and measurements from the test shall be presented for each combustion train (furnace) and then averaged for the sum total of all the combustion trains. Processable Waste fuel composition will be determined by independent laboratory analysis for higher heating value and proximate analysis, (percent moisture, percent volatiles, percent ash, and percent fixed carbon) performed under Capacity Testing, which shall in turn be performed simultaneously with the Energy Recovery Testing.

Installed plant instruments shall be utilized for measuring and recording throttle steam flow, gross facility electrical generation and net electrical generation being delivered to FP&L.

The results of the Energy Recovery Test shall meet the Energy Production Guarantees provided by the Contractor on Form 5.7 of the RFP, which shall be included in the Construction Contract.

### 3.1.7 Materials Recovery Testing

Materials recovery (if any) testing shall be performed during the Acceptance Test period. The proposed test protocol (methodology) for materials recovery testing shall be included with the Proposer's proposal responding to this RFP, if said proposal also includes material(s) recovery. The actual test protocol utilized during the Acceptance Test shall be as negotiated between the Contractor and the County and included in the Construction Contract.

The test protocol shall provide for the determination of:

- o Efficiency of material(s) recovery system.
- o Actual recovered material quality compared to quality specifications of the Contractor's recovered material market.

### 3.2 Supply of Waste During the Acceptance Testing

The Contractor shall notify the County, at least two weeks in advance, of the quantity of Processable Waste required for the Acceptance Test. The County will arrange for the delivery of that quantity of Processable Waste to the Facility in accordance with the County's responsibility under the approved Acceptance Test Plan.

The Contractor shall be responsible for any additional Processable Waste required.

### 3.3 Residue and Unprocessable Waste Removal

The Contractor shall be responsible for the removal and transport of all Residue and Unprocessable Waste to the disposal site, during the Facility Acceptance Testing. Residue and Unprocessable Waste removal shall be in accordance with the Contractor's Facility Acceptance Test plan.

For Residue and Unprocessable Waste removal, the Contractor must complete the initial development of the Residue/Unprocessable Waste landfills, and all necessary permits to construct and operate these landfills must be obtained from the applicable Federal, State and local regulatory agencies.

### 3.4 Energy Generation During the Facility Acceptance Testing

The Contractor will arrange with Florida Power and Light to accept electrical energy generated during the Acceptance Testing.

### 3.5 Preparation of Acceptance Test Report

The Contractor shall prepare and submit to the County the written test results and performance data, within four weeks after completing each Facility Acceptance Test. The Contractor shall submit to the County copies of the test report, for the County's full review, along with copies of the original test data sheets and log sheets.



Test and performance data shall be compiled and certified by an independent consultant engineering firm and/or certified testing laboratory selected by the Contractor and approved by the County. The independent firm will indicate whether the Acceptance Test was conducted in accordance with the Acceptance Test Plan and whether the Acceptance criteria have been met.

The County will observe the Acceptance Test and, upon request, have access to all raw data and calculations. The County reserves the right to Accept or Reject the Facility.

### 3.6 Facility Acceptance

Facility acceptance will be made by the County, only after the following conditions have been satisfied:

- o All environmental testing must meet compliance requirements for stacks emissions, water effluent discharges, residue quality, traffic impact, noise and odor.
- o All permits-to-operate must be issued by Federal, State and local agencies having jurisdiction.
- o The Acceptance Test report has been delivered to the County by the Contractor and has been approved by the County.
- o The County's consulting engineer has verified that all Acceptance criteria and performance guarantees have been met, and that the Acceptance Test was conducted in conformance with the approved Acceptance Test Plan.
- o A current system configuration description has been delivered to the County by the Contractor. The system configuration shall include, but not be limited to utility and construction record drawings.
- o The facilities are constructed in compliance with the negotiated specifications and with all applicable codes and regulations, and all punch list items have been completed.
- o A Certificate of Occupancy has been issued for the facilities.

- o A Notice of Final Completion under the Construction Contract has been issued to the Contractor by the County.

The County may consider partial acceptance of the Facility should Waste Processing and Energy Production Performance Guarantees not be met under the Facility Acceptance Testing. Consideration, by the County, of partial acceptance would be limited to actually demonstrated Facility Processable Waste capacity, throttle steam production, as well as gross and net electrical energy, with all other Construction Contract and Facility Acceptance Test conditions satisfied by the Contractor.

The County's rights and recourse under partial Facility acceptance considerations are set forth under Section 4.14 of the RFP.

APPENDIX C

TECHNICAL SUPPORT DOCUMENT FOR THE PREVENTION  
OF SIGNIFICANT DETERIORATION (PSD) PERMITS

TECHNICAL SUPPORT DOCUMENT FOR  
THE PREVENTION OF SIGNIFICANT DETERIORATION  
(PSD) PERMITS FOR TWO RESOURCE RECOVERY  
FACILITIES IN BROWARD COUNTY, FLORIDA

Prepared for  
MALCOLM PIRNIE, INC.

Prepared by  
ENVIRONMENTAL SCIENCE AND ENGINEERING, INC.  
Gainesville, Florida

December 1983

ESE NO. 83-156-100

## TABLE OF CONTENTS

<u>Section</u>		<u>Page</u>
1.0	INTRODUCTION	1-1
2.0	AIR QUALITY REVIEW REQUIREMENTS AND APPLICABILITY	2-1
	2.1 Project Description	2-1
	2.2 National and State AAQS	2-5
	2.3 PSD Requirements	2-8
	2.3.1 General Requirements	2-8
	2.3.2 Increments/Classifications	2-10
	2.3.3 Control Technology Review	2-12
	2.3.4 Air Quality Analysis	2-13
	2.3.5 Source Impact Analysis	2-14
	2.3.6 Additional Impact Analysis	2-16
	2.4 Source Applicability	2-16
3.0	FACILITY DESIGN	3-1
	3.1 Process Description	3-1
	3.2 Solid Waste Composition	3-3
	3.3 Emission and Stack Operating Parameters	3-3
4.0	BEST AVAILABLE CONTROL TECHNOLOGY EVALUATION	4-1
	4.1 Description of Proposed Control Technology	4-1
	4.1.1 Particulate Matter	4-2
	4.1.2 Sulfur Dioxide	4-4
	4.1.3 Nitrogen Oxides and Carbon Monoxide	4-5
	4.1.4 Other Pollutants	4-6
	4.1.5 Test Methods to Demonstrate Compliance	4-6
	4.2 Comparison of Alternative Control Technologies	4-7
	4.2.1 Particulate Matter	4-7
	4.2.2 Sulfur Dioxide	4-10
	4.2.3 Nitrogen Oxides and Carbon Monoxide	4-12
	4.2.4 Other Pollutants	4-13
5.0	AIR QUALITY MODELING APPROACH	5-1
	5.1 Model Selection	5-1
	5.2 Meteorological Data	5-2
	5.3 Receptor Grid	5-3
	5.4 Review of Existing Ambient Monitoring Data	5-4
6.0	AIR QUALITY MODELING RESULTS	6-1

TABLE OF CONTENTS  
(continued)

<u>Section</u>		<u>Page</u>
7.0	IMPACT ON VEGETATION, SOILS, AND VISIBILITY	7-1
	7.1 Impacts on Vegetation and Soils	7-1
	7.2 Visibility Impacts	7-4
	7.3 Indirect Air Quality Impacts	7-5
8.0	SUMMARY AND CONCLUSIONS	8-1
REFERENCES		

LIST OF TABLES

<u>Table</u>		<u>Page</u>
2-1	National and Florida AAQS	2-7
2-2	PSD Significant Emission Rates and <u>De Minimis</u> Impact Levels	2-9
2-3	Significant Impact Levels for Criteria Pollutants	2-15
2-4	Potential Emissions for Each Proposed BCRR Facility Compared to PSD Significant Emission Rates	2-17
2-5	Predicted Impacts for Each Proposed BCRR Facility Compared to <u>De Minimis</u> Air Quality Impacts	2-19
3-1	Proximate and Ultimate Analyses of MSW for BCRR Project	3-4
3-2	Stack and Operating Parameters for North and South BCRR Facilities	3-5
3-3	Emission Factors of Regulated Pollutants	3-7
3-4	Maximum Hourly and Annual Average Emission Rates for Both North and South BCRR Facilities	3-8
5-1	Ambient Air Monitoring Sites in Broward County	5-5
5-2	1982 Ambient Air Quality Data for Monitoring Stations Within 10 km of the North BCRR Facility	5-6
5-3	1982 Ambient Air Quality Data for Monitoring Stations Within 10 km of the South BCRR Facility	5-7
6-1	Predicted Maximum Concentrations for Each Proposed Resource Recovery Facility Using Screening Modeling Methods	6-2
6-2	Predicted Maximum Concentrations for the Proposed Resource Recovery Facility Using Refined Modeling Methods	6-3
6-3	Predicted Maximum Concentrations at the PSD Class I Area Due to Both Proposed Resource Recovery Facilities	6-4
7-1	Maximum Predicted Concentrations Due to Proposed Resource Recovery Facilities Compared to Concentra- tions Known to Adversely Impact Vegetation	7-3

LIST OF FIGURES

<u>Figure</u>		<u>Page</u>
2-1	Locations of the Proposed North and South Resource Recovery Facilities in Broward County	2-3
2-2	Location of Proposed North Resource Recovery Facility	2-4
2-3	Location of Proposed South Resource Recovery Facility	2-6



## 1.0 INTRODUCTION

This report presents the results of a comprehensive air quality dispersion modeling analysis and study performed by Environmental Science and Engineering, Inc. (ESE) for the proposed Broward County Resource Recovery (BCRR) facilities. The proposed plants will be located in the north and south portions of Broward County and, therefore, are referred to as the north and south BCRR facility, respectively. They will be owned by Broward County and operated by a vendor selected by Broward County. Because a vendor will not be selected until March 1984, a conceptual design has been specified by Malcolm Pirnie, Inc. based on conservative, or worst-case, assumptions from a potential air quality impact viewpoint. Once a vendor is selected and the conceptual design is finalized, the predicted impacts are not expected to be significantly different (i.e., not significantly higher) than those presented in this report. Therefore, for this analysis, each facility is assumed to be capable of charging 1,500 tons per day (TPD) of municipal solid waste (MSW) at a 100-percent annual availability factor. Solid waste will fuel steam generation boilers at each facility for the purpose of reducing waste volume and generating electricity.

In accordance with the Clean Air Act (CAA) Amendments of 1977, this report addresses the requirements of the Prevention of Significant Deterioration (PSD) review which will be submitted to the Florida Department of Environmental Agency (EPA) Region IV for their approval. This review includes an emission control technology evaluation, an air quality modeling and monitoring assessment of expected air pollutant emissions and background sources, and an assessment of the impact of the proposed facilities on soils, vegetation, and visibility.

As part of the air quality modeling assessment, incremental and total ambient pollutant concentrations were simulated for comparison to the national and Florida Ambient Air Quality Standards (AAQS) and PSD increments in the area surrounding the proposed plants. Air quality dispersion modeling was conducted using the EPA Industrial Source Complex (ISC) model for estimating concentrations.

The air quality regulatory requirements pertaining to the proposed BCRR facilities are presented in Section 2.0. The facility design description and control technology review are presented in Sections 3.0 and 4.0, respectively. The air quality modeling procedures and assumptions are presented in Section 5.0. The results of the modeling analyses that compare the predicted impacts of the BCRR facilities to the national and Florida AAQS and the PSD Class I and II increments are discussed in Section 6.0. An evaluation of the predicted impacts on soils, vegetation, and visibility is presented in Section 7.0. A summary of the results of this analysis and the conclusions are presented in Section 8.0.

## 2.0 AIR QUALITY REVIEW REQUIREMENTS AND APPLICABILITY

The following discussions pertain to the general project description and regulatory requirements that must be met for the construction and operation of the proposed resource recovery facilities, as required by federal and state PSD regulations and other air quality regulations.

### 2.1 Project Description

Broward County occupies an area of approximately 1,200 square miles (mi<sup>2</sup>) and is located in the southeastern portion of the State of Florida. Broward County is bounded on the north by Palm Beach County, on the east by the Atlantic Ocean, on the south by Dade County, and on the west by Hendry and Collier Counties.

In 1981, Broward County generated approximately 2,700 TPD of solid waste (Malcolm Pirnie, Inc., 1983a). Currently, the County's waste is disposed of at two landfills. One of these landfills, the county landfill at Davie, is projected to reach capacity in 1986. The other landfill, the central disposal landfill located at Pompano Beach, is owned and operated by Waste Management, Inc. It is estimated that this landfill will reach capacity in the early 1990's.

The capacity limitations of these landfills necessitate the development of a long-term countywide disposal plan. Recognizing this need, Broward County authorized the investigation of solid waste management alternatives. A policy decision was made by Broward County not to rely on landfill as a primary long-term disposal solution and to concentrate on alternatives that involve the recovery of materials and/or energy as valuable resources.

Originally, Broward County pursued the development of two separate resource recovery projects. A northern project involving a 600-TPD co-disposal waste-to-energy facility was

planned for a site located at Powerline Road. In addition, a southern, mass-burning waste-to-energy project at the intersection of Route 441 and State Road 84 was planned to accommodate the remaining county wastes. On October 12, 1982, Broward County suspended all activity on these previous projects and authorized the preparation of Request for Proposals (RFP) for long-term full-service waste disposal. The project included the design, construction, startup, and operation of two resource recovery facilities to be located in northern and southern Broward County, each with an accompanying disposal landfill site. The engineering firm of Malcolm Pirnie, Inc., in association with W.F. Cosulich and Associates, Inc. and Hazen and Sawyer, Inc., was retained by the County to assist representatives from applicable county agencies in developing this full-service RFP.

The BCRR project will utilize two sites to locate the necessary facilities. Figure 2-1 illustrates the general locations of the northern and southern sites. A resource recovery facility and landfill area will be located at each site. Broward County is currently in the process of acquiring and rezoning these sites. Negotiations have been initiated with the appropriate property owners, and the rezoning applications have been submitted.

The northern site location is shown in Figure 2-2. This site is accessible by Powerline Road to Copans Road. Powerline Road is a 4-lane paved roadway with current development in the vicinity of the site limited to industrial activity. Copans Road is a 2-lane paved roadway extending westward from Powerline Road to Blount Road.

At the northern site, approximately 130 acres will be available for siting the resource recovery facility and accompanying landfill and to provide buffer and stormwater retention ponds. Acreage requirements for the resource recovery facility, stormwater retention ponds, and buffer

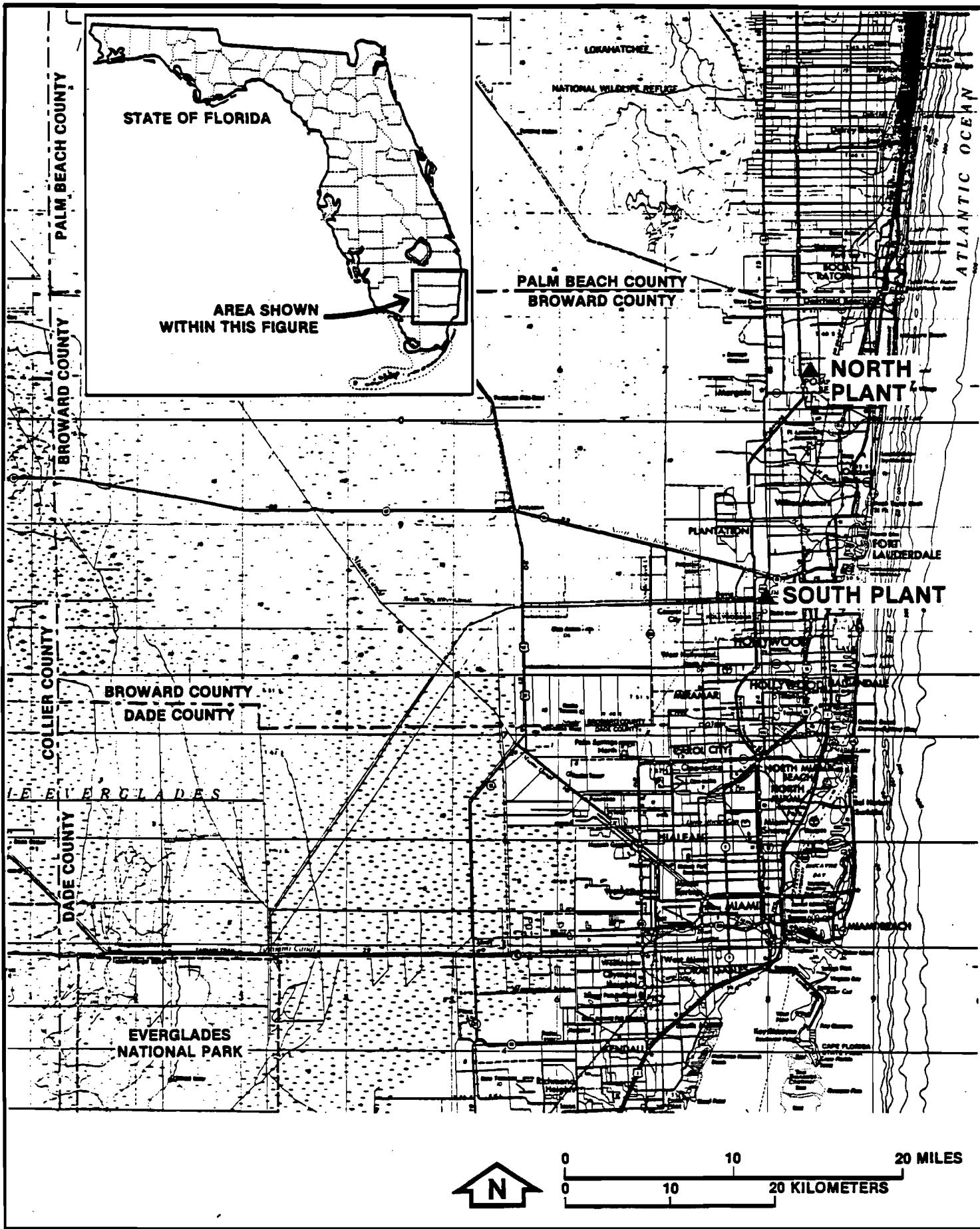

Figure 2-1  
 LOCATIONS OF THE PROPOSED NORTH AND  
 SOUTH RESOURCE RECOVERY FACILITIES IN  
 BROWARD COUNTY

SOURCE: ESE, 1983.

MALCOLM PIRNIE, INC.

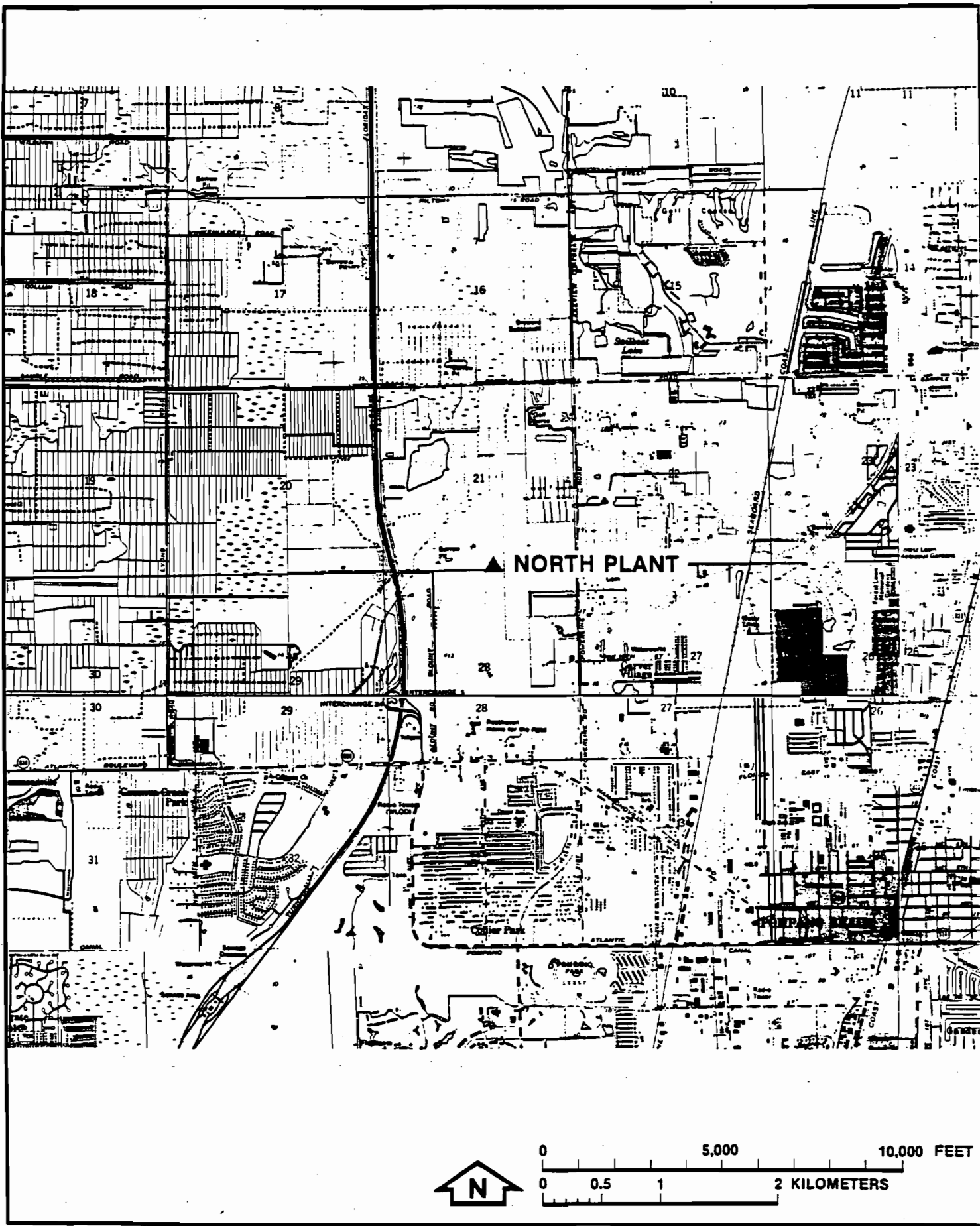

Figure 2-2  
 LOCATION OF PROPOSED NORTH RESOURCE  
 RECOVERY FACILITY

SOURCE: ESE, 1983.

MALCOLM PIRNIE, INC.

areas are estimated to be approximately 50 acres. Approximately 80 acres will be available at this site for landfill development. The southern site, shown in Figure 2-3, will be located about 1.5 km southeast of the intersection of US Route 441 (State Road 7) and State Road 84. The southern and eastern site boundaries are formed by the South New River Canal. This site is accessible from an easement off US Route 441, which is a 4-lane undivided highway and a major roadway in the area.

## 2.2 National and State AAQS

As a result of the requirements of the 1970 CAA Amendments, EPA enacted primary and secondary national AAQS (Federal Register, 1971) for six air pollutants. Primary national AAQS are required to protect the public health, and secondary national AAQS are required to protect the public welfare from any known or anticipated adverse effects associated with the presence of pollutants in the ambient air.

The existing applicable national and Florida AAQS are presented in Table 2-1. Since the original standards were issued in 1971, the following changes have been made to national AAQS:

1. EPA eliminated the 24-hour and annual secondary AAQS for SO<sub>2</sub>;
2. AAQS for photochemical oxidants was redesignated as ozone, the concentration limit was increased, and the method for determining compliance was changed;
3. A new national AAQS for lead was promulgated; and
4. AAQS for hydrocarbons, used as a guide in achieving the AAQS for photochemical oxidants, was eliminated.

Prior to these changes, the State of Florida promulgated the secondary national AAQS for SO<sub>2</sub> as the state AAQS. Since states have the authority to adopt AAQS more stringent than those established by EPA, the State of Florida has chosen to

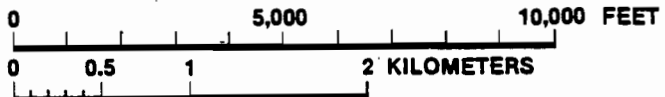
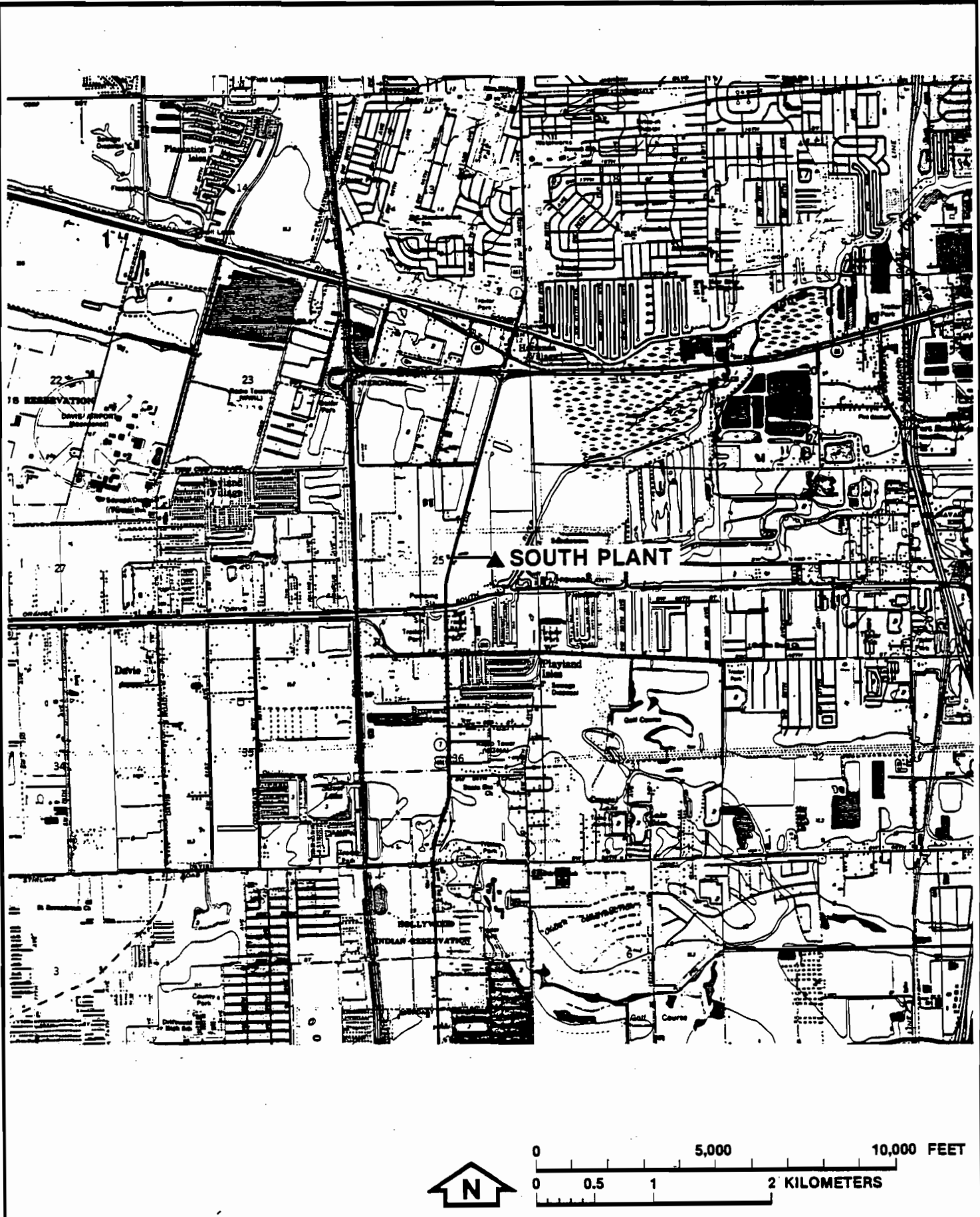

Figure 2-3  
 LOCATION OF PROPOSED SOUTH RESOURCE  
 RECOVERY FACILITY

MALCOLM PIRNIE, INC.

SOURCE: ESE, 1983.



TABLE 2-1

## National and Florida AAQS

Pollutant	Averaging Time	National* AAQS (ug/m <sup>3</sup> )		PSD Increments (ug/m <sup>3</sup> )	
		Primary	Secondary	Class I	Class II
Suspended Particulate Matter	Annual Geometric Mean	75	60	5	19
	24-Hour Maximum†	260	150	10	37
Sulfur Dioxide	Annual Arithmetic Mean	80	N/A	2	20
	24-Hour Maximum†	365	N/A	5	91
	3-Hour Maximum†	N/A	1,300	25	512
Carbon Monoxide	8-Hour Maximum†	10,000	10,000	NA	NA
	1-Hour Maximum†	40,000	40,000	NA	NA
Nitrogen Dioxide	Annual Arithmetic Mean	100	100	NA	NA
Ozone	1-Hour Maximum**	235	235	NA	NA
Lead	Calendar Quarter	1.5	1.5	NA	NA

\* Florida AAQS are identical to the secondary national AAQS except for the following sulfur dioxide concentrations: 60 ug/m<sup>3</sup>, annual average, and 260 ug/m<sup>3</sup>, 24-hour average.

† Maximum concentration not to be exceeded more than once per year.

\*\* Maximum concentration not to be exceeded more than an average of 1 calendar day per year.

ug/m<sup>3</sup> = micrograms per cubic meter.

N/A = Not applicable.

Source: 40 CFR, Parts 50 and 52.

retain the secondary AAQS for SO<sub>2</sub> which were eliminated by EPA. Pollutants for which AAQS have been established are called "criteria" pollutants.

Areas of the country in violation of AAQS are designated as nonattainment areas, and new sources to be located in or near these areas may be subject to more stringent air permitting requirements. Broward County is currently designated an ozone nonattainment area. There are no other designated nonattainment areas for other pollutants within 100 kilometers (km) of the proposed plant sites.

## 2.3 PSD Requirements

### 2.3.1 General Requirements

Under federal PSD review requirements, all major new sources of air pollutants regulated under CAA must be reviewed and approved by EPA (in this case, reviewed and approved by DER since PSD review authority has been delegated to the state). A "major stationary source" is defined as any one of 28 named source categories which has the potential to emit 100 tons per year (TPY) or more, or any other stationary source which has the potential to emit 250 TPY or more, of any pollutant regulated under CAA. "Potential to emit" means the capability at maximum design capacity to emit a pollutant after the application of control equipment.

PSD review is used to determine whether significant air quality deterioration will result from the new or modified source. PSD requirements are contained in 40 CFR 52.21, Prevention of Significant Deterioration of Air Quality. Major sources are required to undergo the following reviews related to PSD for each pollutant emitted in significant amounts:

1. Control technology review,
2. Source impact analysis,
3. Air quality analysis (monitoring),

4. Source information, and
5. Additional impact analyses.

"Significant" is defined as any increase in emissions in excess of specified levels (Table 2-2).

The control technology review includes determination of Best Available Control Technology (BACT) for each applicable pollutant. BACT emission limits cannot exceed applicable emission standards (e.g., New Source Performance Standards (NSPS) or state emission limits) promulgated under 40 CFR 60. The source impact analysis requires demonstration of compliance with federal and state AAQS and allowable PSD increment limitations. Projected ambient impacts on designated nonattainment areas and federally promulgated Class I PSD areas must also be addressed. The air quality analysis (monitoring) portion of PSD review requires an analysis of continuous ambient air monitoring data to be performed for the impact area of the proposed source. Source information, including process design parameters and control equipment information, must be submitted to the reviewing agencies. Additional analysis of the proposed source's impact on soils, vegetation, and visibility, especially pertaining to Class I PSD areas, must be performed, as well as analysis of impacts due to growth in the area associated with the proposed source.

#### 2.3.2 Increments/Classifications

In promulgating the 1977 CAA Amendments, Congress specified that certain increases above an air quality "baseline concentration" level of sulfur dioxide (SO<sub>2</sub>) and total suspended particulate (TSP) concentrations would constitute significant deterioration. The magnitude of the increment that cannot be exceeded depends on the classification of the area in which a new source (or modification) will have an impact. Three classifications were designated based on

TABLE 2-2

PSD Significant Emission Rates and De Minimis Impact Levels

Pollutant	Regulated Under	Significant Emission Rate (TPY)	De Minimis Air Quality Impact (ug/m <sup>3</sup> )
Sulfur Dioxide	NAAQS, NSPS	40	13, 24-hour
Particulate Matter	NAAQS, NSPS	25	10, 24-hour
Nitrogen Oxides	NAAQS, NSPS	40	14, Annual
Carbon Monoxide	NAAQS, NSPS	100	575, 8-hour
Volatile Organic Compounds (Ozone)	NAAQS, NSPS	40	100 TPY*
Lead	NAAQS	0.6	0.1, 24-hour
Sulfuric Acid Mist	NSPS	7	†
Total Fluorides	NSPS	3	0.25, 24-hour
Total Reduced Sulfur	NSPS	10	10, 1-hour
Reduced Sulfur Compounds	NSPS	10	10, 1-hour
Hydrogen Sulfide	NSPS	10	0.04, 1-hour
Asbestos	NESHAP	0.007	†
Beryllium	NESHAP	0.0004	0.0005, 24-hour
Mercury	NESHAP	0.1	0.25, 24-hour
Vinyl Chloride	NESHAP	1	15, 24-hour
Benzene	NESHAP	0	†
Radionuclides	NESHAP	0	†
Inorganic Arsenic	NESHAP	0	†
Any Regulated Pollutant	—	Class I Impact**	

\* Increase in volatile organic compounds (VOC) emissions.

† No ambient measurement method.

\*\* Any emission rate for a source located within 10 km of a Class I area which causes impacts of 1 ug/m<sup>3</sup>, 24-hour average, or greater.

Notes: Ambient monitoring requirements for subject pollutants may be exempted if the impact of the increase in emissions is below air quality impact de minimis levels.

TPY = Tons per year

NAAQS = National Ambient Air Quality Standards.

NSPS = New Source Performance Standards.

NESHAP = National Emission Standards for Hazardous Air Pollutants.

In February 1981, the Ambient Monitoring Guidelines for PSD (EPA-450/4-80-012) were revised to reflect the following changes in the de minimis levels: lead--0.1 ug/m<sup>3</sup>, calendar quarter; hydrogen sulfide--0.2 ug/m<sup>3</sup>, 1-hour; and beryllium--0.001 ug/m<sup>3</sup>, 24-hour. These revisions have not been published in the Federal Register or incorporated into the Code of Federal Regulations.

Sources: 40 CFR 52.21.

Lutz, 1981.

criteria established in the CAA Amendments. Initially, Congress promulgated areas as Class I (international parks, national wilderness areas, and memorial parks larger than 2,024 hectares (ha) 5,000 acres), and national parks larger than 2,428 ha (6,000 acres)] or Class II (all other areas not designated as Class I). No Class III areas, which would be allowed greater deterioration than Class II areas, were designated. However, the states were given the authority to redesignate any Class II area to Class III status, provided certain requirements were met. EPA then promulgated as regulations the requirements for classifications and area designations. The State of Florida has adopted the EPA class designations and allowable PSD increments (Table 2-2). The nearest Class I area is the Everglades National Park, located about 75 and 57 km from the north and south BCRR facility, respectively.

The term "baseline concentration" evolved from federal and state PSD regulations and denotes a fictitious concentration level corresponding to a specified baseline date and certain additional baseline sources. By definition in the PSD regulations, as amended August 7, 1980, baseline concentration means the ambient concentration level which exists in the baseline area at the time of the applicable baseline date. A baseline concentration is determined for each pollutant for which a baseline data is established and shall include:

1. The actual emissions representative of sources in existence on the applicable baseline date; and
2. The allowable emissions of major stationary sources which commenced construction before January 6, 1975, but were not in operation by the applicable baseline date.

The following will not be included in the baseline concentration and will affect the applicable maximum allowable increase(s) (allowed increment consumption):

1. Actual emissions from any major stationary source on which construction commenced after January 6, 1975; and
2. Actual emissions increases and decreases at any stationary source occurring after the baseline data.

"Baseline date" means the earliest date after August 7, 1977, on which the first complete application under 40 CFR 52.21 is submitted by a major stationary source or major modification subject to the requirements of 40 CFR 52.21.

### 2.3.3 Control Technology Review

CAA mandated that EPA promulgate NSPS, which are a set of national emission standards for stationary sources of air pollution. These standards are applicable to specific categories of sources and apply not only to new sources, but also to modified or reconstructed existing sources of air pollution. Consequently, EPA promulgated NSPS for incinerators in June 1974 (40 CFR 60, Subpart E). NSPS for incinerators impose an emission limitation on particulate matter (PM) only. Specifically, incinerators with a charging rate in excess of 50 TPD of solid waste may not discharge to the atmosphere flue gases that contain PM in excess of 0.08 grain per standard cubic foot dry gas (gr/dscf), corrected to 12-percent carbon dioxide (CO<sub>2</sub>).

DER has promulgated pollutant emission limitations to attain and preserve ambient air quality. The only emission regulation that applies to the proposed BCRR facilities is a PM standard. Particulate emissions from a new incinerator with a charging rate equal to or greater than 50 TPD are limited to 0.08 gr/dscf corrected to 50-percent excess air. Opacity is limited to 20 percent.

Under EPA's implementation of the CAA Amendments, the basic control technology requirement is the application and evaluation of BACT. BACT is defined as follows (40 CFR 52.21(b)(12)):

An emission limitation...based on the maximum degree of reduction for each pollutant...which would be emitted from any proposed major stationary source or major modification which the Administrator, on a case-by-case basis, taking into account energy, environmental, and economic impacts and other costs, determines is achievable...for control of such pollutant.

In December 1978, EPA's Office of Air, Noise, and Radiation published Guidelines for the Evaluation of BACT to assist states and EPA Regional Offices in making BACT determinations. The BACT requirements are intended to ensure that the control systems incorporated in the design of a proposed facility reflect the latest in control technologies used in a particular industry and take into consideration existing and future air quality in the vicinity of the proposed facility. BACT must, as a minimum, demonstrate compliance with NSPS for this source, if applicable. An evaluation of the air pollution control techniques and systems, including a cost-benefit analysis of alternative control technologies capable of achieving a higher degree of emission reduction than the proposed control technology, is also required. The cost-benefit analysis requires the documentation of the materials, energy, and economic penalties associated with the proposed and alternative control systems as well as the environmental benefits derived from these systems.

#### 2.3.4 Air Quality Analysis

In accordance with requirements of 40 CFR 52.21(m), any application for a PSD permit must contain, for each pollutant regulated under CAA, an analysis of continuous ambient air quality data in the area affected by the proposed major stationary source or major modification. For a new major source, the affected pollutants are those that the source would potentially emit in a significant amount.

According to CAA, ambient air monitoring for a period of up to 1 year generally is appropriate to complete the PSD requirements of CAA. Existing data from the vicinity of the

proposed source may be utilized if the data meet certain quality assurance requirements; otherwise, additional data may need to be gathered. Guidance in designing a PSD monitoring network is provided in EPA's Ambient Monitoring Guidelines for Prevention of Significant Deterioration (EPA, November 1980).

The regulations include an exemption which excludes or limits the pollutants for which an air quality analysis is conducted. This exemption states that the Administrator may exempt a proposed major stationary source or major modification from the monitoring requirements of 40 CFR 52.21(m) with respect to a particular pollutant if the emissions increase of the pollutant from the source or modification would cause, in any area, air quality impacts less than the de minimis levels presented in Table 2-2.

The State of Florida has passed similar PSD air quality analysis requirements. EPA and State of Florida de minimis air quality impact levels are currently identical. In February 1981, EPA revised the de minimis levels and averaging times for three of the pollutants (Lutz, 1981). The averaging period for the de minimis level for lead was changed to 3 months, and the de minimis impact levels for beryllium and hydrogen sulfide were changed to 0.001 microgram per cubic meter ( $\text{ug}/\text{m}^3$ ) and  $0.2 \text{ ug}/\text{m}^3$ , respectively.

#### 2.3.5 Source Impact Analysis

A source impact analysis must be performed by a proposed major source subject to PSD for each pollutant for which the increase in emissions exceeds the significant emission rates (Table 2-2). The PSD regulations specifically require the use of atmospheric dispersion models in performing impact analysis, estimating baseline and future air quality levels, and determining compliance with AAQS and allowable PSD increments. Designated EPA models must normally be used in performing the impact analysis. Specific applications for other than EPA-approved models require EPA's consultation and prior approval.



Guidance for the use and application of dispersion models is presented in the EPA publications, "Guideline on Air Quality Models" (EPA, 1978) and "Regional Workshops on Air Quality Modeling: A Summary Report" (EPA, 1982a). Criteria pollutants may be exempt from the source impact analysis if the net increase in impacts due to the proposed source is below significant impact levels, as presented in Table 2-3.

Various lengths of record for meteorological data can be utilized for impact analysis. A 5-year period can be used with corresponding evaluation of highest, second-highest short-term concentrations for comparison to AAQS or PSD increments. The term "highest, second-highest" refers to the highest of the second-highest concentrations at all receptors (i.e., the highest concentration at each receptor is discarded). The second-highest concentration is significant because short-term AAQS specify that the standard should not be exceeded at any location more than once a year. If less than 5 years of meteorological data are used, the highest concentration at each receptor must be used.

#### 2.3.6 Additional Impact Analyses

In addition to air quality impact analyses, federal PSD regulations require analyses of the impairment to visibility and the impacts on soils and vegetation that would occur as a result of the proposed source. These analyses are to be conducted primarily for PSD Class I areas. Impacts due to general commercial, residential, industrial and other growth associated with the source must also be addressed. These analyses are required for each pollutant emitted in significant amounts.

#### 2.4 Source Applicability

The estimated emissions of regulated pollutants from the BCRR facilities are presented in Table 2-4. The proposed facilities will be located in Broward County, which is designated by EPA and DER as an attainment area for all criteria

TABLE 2-3

## Significant Impact Levels for Criteria Pollutants

Pollutant	Averaging Period	Concentration (ug/m <sup>3</sup> )
Sulfur Dioxide	3-Hour	25
	24-Hour	5
	Annual	1
Particulate Matter	24-Hour	5
	Annual	1
Nitrogen Dioxide	Annual	1
Carbon Monoxide	1-Hour	2,000
	8-Hour	500

Source: 40 CFR 52.

Temp 1800°F  
 2100°F  
 2+ seconds  
 OAP inlet ~ 450°F

North - 101 Ton/hr - 698,000 TPY  
 South - 113 Ton/hr - 730,000 TPY  
 110-115% Nameplate

TABLE 2-4

Potential Emissions for Each Proposed BCRR Facility Compared to PSD Significant Emission Rates

4500 Btu/lb 9 mm Btu/lb

Pollutant	Emission* Factor (lb/ton)	(lb/mmBtu)	Estimated Emissions† (TPY)	PSD Significant Emission Rate (TPY)
Particulate Matter	1.14**	0.074	312	25
Sulfur Dioxide	3.0	0.60	821	40
Nitrogen Dioxide	3.0	0.60	821	40
Carbon Monoxide	0.6	0.089	164	100
Volatile Organic Compounds	0.14	.02	38	40
Lead	0.15	.03	41	0.6
Fluorides	0.1	.07	27	3
Sulfuric Acid Mist	0.025		6.8	7
Hydrogen Sulfide	NA		NA	10
Total Reduced Sulfur	NA		NA	10
Reduced Sulfur Compounds	NA		NA	10
Asbestos	NA		NA	0.007
Beryllium	0.000011	$9.3 \times 10^{-7}$	0.003	0.0004
Mercury	0.0023		0.63	0.1
Vinyl Chloride	NA		NA	1
Benzene	NA		NA	0
Radionuclides	NA		NA	0
Inorganic Arsenic	0.00028		0.077	0

NA = Not applicable.

\* See Table 3-3 for references for emission factors.

† Based on burning 1,500 TPD of MSW and 100-percent annual availability factor, for a total of 547,500 TPY.

\*\* Assumes emission rate of 0.03 gr/dscf.

Source: ESE, 1983.

pollutants except ozone, and a PSD Class II area for SO<sub>2</sub> and TSP. Because volatile organic compound (VOC) emissions from the proposed facilities will be less than the significant impact levels, no additional analyses are required to address VOC impacts. The nearest nonattainment area for any other criteria pollutant is located more than 100 km from either of the proposed BCRR facilities. Because impacts from the proposed plant's emissions are not expected to be significant at such distances, potential impacts on the nearest nonattainment areas were not addressed in the analysis.

The proposed north and south BCRR facilities will be located about 57 and 75 km, respectively, from the PSD Class I area of the Everglades National Park. As a result, potential impacts on the Class I were addressed in the analysis.

Under PSD regulations, the proposed project will be a major source because it is one of the 28 named "major stationary sources" (i.e., municipal incinerator capable of charging more than 250 tons of refuse per day) which has the potential to emit more than 100 TPY of PM, SO<sub>2</sub>, nitrogen dioxide (NO<sub>2</sub>), and carbon monoxide (CO). As a result, any regulated pollutant emitted from the BCRR facilities above the significant emission rates presented in Table 2-4 is subject to PSD review.

Emissions of the following pollutants from the proposed sources will be in excess of the appropriate significant emission levels: PM, SO<sub>2</sub>, NO<sub>2</sub>, CO, lead, fluorides, beryllium, mercury, and arsenic. It should be noted that no significant emission rate has been established for arsenic, and, therefore, any emissions are considered significant. The methods and references used to estimate the emissions of the regulated pollutants are presented in Section 3.3.

As discussed in Section 2.3.4, a new major source may be exempt from preconstruction air quality monitoring requirements of the PSD regulations for those pollutants which have

air quality impacts less than the de minimis levels presented in Table 2-2. The maximum predicted impacts due to emissions from each of the proposed BCRR facilities, for regulated pollutants subject to PSD review are presented in Table 2-5. The methods used to predict the proposed facilities impacts are described in Section 5.0. Based on these results, the impacts from the proposed facilities are expected to be below the de minimis impact levels for all pollutants except lead. Currently, there is no de minimis level designated for inorganic arsenic because an appropriate monitoring method has not yet been developed for this pollutant. Therefore, no monitoring is required, and no modeling has been performed for this pollutant in this analysis.

For lead, the impacts from the proposed facilities are expected to be slightly above the de minimis impact level promulgated by the State of Florida. Based on a review of existing monitoring data in the county (see Section 5.4), there is at least one lead monitor within 8 km of each of the proposed facilities' locations. These monitoring sites, which are expected to measure general population-created pollution in the county, have measured maximum concentrations that are less than 55 percent of AAQS. Because the maximum lead impacts from the proposed facilities are expected to be low and existing ambient lead concentrations are well below AAQS, existing monitoring data should be suitable for determining preconstruction monitoring lead levels and acceptable as part of the PSD permit application. Therefore, preconstruction monitoring for lead is not considered necessary for the BCRR facilities. It should be noted that EPA has revised the de minimis level for lead from a 24-hour to calendar-quarter averaging time. Based on this revision, the maximum predicted lead construction is well below the calendar-quarter averaging time. Based on this revision, the maximum predicted lead

TABLE 2-5

Predicted Impacts for Each Proposed BCRR Facility Compared to De Minimis Air Quality Impacts

Pollutant	Averaging Period	Impacts (ug/m <sup>3</sup> )	
		Maximum Predicted Due to Each Facility	<u>De Minimis Level</u>
Particulate Matter	24-hour	0.9	10
Sulfur Dioxide	24-hour	2.4	13
Nitrogen Dioxide	Annual	0.3	14
Carbon Monoxide	8-hour	1.4	575
Lead	24-hour (Quarterly)*	0.12 (0.02)	0.1 (0.1)
Fluorides	24-hour	0.08	0.25
Beryllium	24-hour	0.000009	0.0005 (0.001)
Mercury	24-hour	0.0018	0.25

\* Values in parentheses represent results associated with revised de minimis monitoring levels.

Source: ESE, 1983.

concentration is well below the calendar-quarter average de  
minimis level and, therefore, monitoring would not be required  
as part of the PSD permit application.

### 3.0 FACILITY DESIGN

#### 3.1 Process Description

The BCRR facilities will be designed such that MSW will be delivered to each facility by collection trucks that are either municipally or privately operated. MSW will be dumped from these vehicles into a totally enclosed tipping area which will be kept under negative pressure. The drawn air will be used as combustion air in the boilers. MSW will be moved from the storage pit and fed or charged into the furnaces by means of an overhead crane-and-grapple system. The cranes and grapples will also be used to mix processable waste in the pit to produce a homogeneous mass. This system will also be capable of removing large, bulky, combustible trash items from the storage pit and feeding them to the crusher and shears process. The crusher and shears, located at one end of the storage pit, will be used for size reduction of the oversized, processable trash prior to charging them into the furnaces. Provisions will also be made for removal of salvageable, oversized, noncombustible trash from the storage pit, using the overhead crane-and-grapple system.

The furnace design will be of the mass-burn stoker-fired or stoker/rotary kiln tandem type, capable of firing as-received processable waste, without auxiliary fuel burning, on a continuous-feed basis. Each combustion system will be equipped with an individual multiple-pass, waterwall-type boiler. This system will convert feed water to steam by the heat released during combustion of the solid waste. The steam will be used to drive a steam turbine which, in turn, drives an electric generator for the production of electricity.

The combustion air systems for the furnace will be designed to control automatically the furnace temperature within  $\pm 50^{\circ}$  Fahrenheit of the set-point temperature selected by the vendor while firing processable waste with higher



heating values (HHV) varying from 3,500 to 6,000 British thermal units per pound (Btu/lb). Sampling conducted on Broward County's processable waste (Malcolm Pirnie, Inc., 1983a) indicates that the minimum and maximum extremes of the range may be realized on a sustained seasonal basis (e.g., November through April at the upper range) as a result of significant variation in moisture content associated with extremes in rainfall.

The combustion air will be vented from the refuse storage area, tipping area, and/or the outside atmosphere. This procedure will maintain negative pressure in the refuse storage and tipping areas and thereby provide odor and dust control.

Gases exiting the furnaces and boilers will enter an electrostatic precipitator for removal of particulates matter prior to release of the gases to the atmosphere.

The proposed facilities will also have a residue handling system to collect the postincineration bottom ash and fly ash while separating any recyclable materials in a dust-free manner. The systems will have ash conveyors to transport the ash to the handling areas at each facility. Provisions for an enclosed tractor-trailer loading area with ventilation and dust control will be incorporated into the design. A clam-shell-type bucket for loading ash onto trucks from an ash storage pit may be provided. The residue ash will contain less than 4.0 percent combustibles and less than 0.2 percent putrescibles.

The bottom ash or residue will be water-cooled by spray or quenched in tanks or sumps before it is handled by the conveyors. The cooled bottom ash handling system will consist of drag or vibrating conveyors designed to handle the total plant load. The fly ash may be combined with the quenched bottom ash or collected separately by the vendor to market the fly ash for reuse. The fly ash handling system will include,

but not be limited to, screw conveyors inside the precipitator hoppers, rotary or double-flap airlock valves, and dry drag-type transfer conveyors.

### 3.2 Solid Waste Composition

The proposed resource recovery facilities have been designed to process residential, commercial, institutional, and nonhazardous industrial waste. Field experience (Malcolm Pirnie, Inc., 1983a, 1983b) in Broward County has shown that the gross or HHV of municipal wastes averages 5,000 Btu/lb and ranges from 3,500 to 6,500 Btu/lb. General characteristics of the composition of the municipal waste determined from field analyses are presented in Table 3-1.

### 3.3 Emission and Stack Operating Parameters

The proposed project consists of two resource recovery facilities to be located in Broward County. The data presented in this report are based on preliminary or conceptual design of the proposed facilities. The design will be subject to certain refinements following selection of a full-service vendor scheduled for March 1984. However, the conceptual design is based on conservative or worst-case assumptions from a potential air quality impact viewpoint.

Each BCRR facility is assumed to be capable of burning 1,500 TPD of MSW. One of the facilities is to be located in north Broward County, approximately 22 km north-northeast of the other facility, located in south Broward County. Because the two facilities are assumed to be identical in stack and operating design, the data presented in Table 3-2 are applicable for each facility. The proposed stack heights for each facility will be at a Good Engineering Practice (GEP) height; therefore, building downwash conditions are not considered in this analysis.

TABLE 3-1

Proximate and Ultimate Analyses of MSW for BCRR Project

Component	Percent by Weight of MSW
<u>Proximate Analysis</u>	
Moisture	51.1
Combustibles	35.8
Ash Inert	13.1
HHV (Btu/lb)	5,000
<u>Ultimate Analysis</u>	
Carbon	53.4
Hydrogen	7.4
Nitrogen	0.0061
Oxygen	38.7
HHV (Btu/lb)	9,781

Source: Malcolm Pirnie, Inc., 1983b.

TABLE 3-2

## Stack and Operating Parameters for North and South BCRR Facilities\*

Parameter	Value
MSW charging rate (maximum)	1,500 TPD (62.5 ton/hr)
MSW heat input rate†	625 x 10 <sup>6</sup> Btu/hr
Stack height	195 ft (59.5 m)
Stack diameter	13.8 ft (4.2 m)
Exit gas temperature	450°F (505 K)
Exit gas flow rate†	438,770 acfm (207.2 m <sup>3</sup> /s) 276,585 dscfm (130.6 m <sup>3</sup> /s)
Exit gas velocity	48.9 ft/s (14.9 m/s)
Location	
North Facility	
Latitude, longitude	26.26°, 80.16°
UTM zone	17
UTM x, y coordinates	584.0 km, 2904.7 km
South Facility	
Latitude, longitude	26.07°, 80.20°
UTM zone	17
UTM x, y coordinates	579.6 km, 2883.3 km

\* Stack and operation parameters are assumed to be the same for both facilities.

† Based on average heating value of MSW of 5,000 Btu/lb for wet season.

Notes: acfm = actual cubic feet per minute  
dscfm = dry standard cubic feet per minute

Sources: Malcolm Pirnie, Inc., 1983b.  
ESE, 1983.

It should be noted that the exit gas flow rate presented in Table 3-2 is based on wet-season conditions when moisture content in MSW is relatively high. This results in the boiler exhaust gas flow rate also being the lowest during the wet season. For air dispersion modeling purposes, the flow rate presented in Table 3-2 was used to estimate ground-level concentrations because the lower flow rate will result in a lower plume rise compared to that produced with a higher flow rate. As a result, higher ground-level concentrations are predicted with the lower exit gas flow conditions.

The emission factors and literature references for the regulated pollutants that will be emitted from the proposed BCRR facilities are presented in Table 3-3. For most of the regulated pollutants, the emission factors are based on estimates derived for resource recovery facilities similar in size to the proposed facilities. The emission factors are given as a function of the amount of MSW buried. These emission factors are based on a review of the literature, such as EPA AP-42 emission factors and A.D. Little reports, or manufacturer's design specification.

The emission factor for particulate matter is based on an emission level of 0.03 gr/dscf. This emission limit will be obtained with an electrostatic precipitator that is greater than 98-percent efficient. Based on the researched emission factors, the estimated emissions for each facility are presented in Table 3-4. The maximum hourly emission rates were used in the air dispersion modeling analysis.

To Ed Svec  
Date 8/22 Time 8:30

**WHILE YOU WERE OUT**

M Mike Brandon  
of EPA  
Phone 404-881-7654  
Area Code Number Extension

<input checked="" type="checkbox"/> TELEPHONED	<input checked="" type="checkbox"/> PLEASE CALL
<input type="checkbox"/> CALLED TO SEE YOU	<input type="checkbox"/> WILL CALL AGAIN
<input type="checkbox"/> WANTS TO SEE YOU	<input type="checkbox"/> URGENT
<input type="checkbox"/> RETURNED YOUR CALL	

Message Resource Recovery  
plant in Broward Co.

LS  
Operator

TABLE 3-3

## Emission Factors of Regulated Pollutants

Pollutant	Emission Factor (lb/ton)	Reference
Particulate Matter	1.14	1
Sulfur Dioxide	3.0	2
Nitrogen Dioxide	3.0	4
Carbon Monoxide	0.6	5
Volatile Organic Compounds	0.14	3
Lead	0.15	2
Fluorides	0.1	2
Sulfuric Acid Mist	0.025	6
Beryllium	0.000011	2
Mercury	0.0023	2
Arsenic	0.00028	2
Other regulated pollutants	*	*

\* There is no evidence in the literature that total reduced sulfur, reduced sulfur compounds, hydrogen sulfides, asbestos, vinyl chloride, benzene, or radionuclides are emitted in measurable quantities.

#### References

1. PM emissions based on emission limit of 0.03 gr/dscf.
2. Little, A.D. 1981. Municipal Incinerator Emission Estimates. Report to O'Brien and Gese Engineers.
3. United States Environmental Protection Agency. 1980. Environmental Assessment of a Waste-to-Energy Process--Braintree Municipal Incinerator, Publication EPA-600/PS7-80-149.
4. United States Environmental Protection Agency. 1983. Compilation of Air Pollutant Emission Factors, Third Edition, Supplements 1-14.
5. CO emissions based on stack test results from Saugus (Mass.) municipal incinerator (Malcolm Pirnie, 1983b).
6. Battelle. 1973. Final Report on Harrisburg Municipal Incinerator, Evaluation to the Harrisburg Incinerator Authority.

TABLE 3-4

Maximum Hourly and Annual Average Emission Rates for Both North and South BCRR Facilities

Pollutant	<i>Significant</i>	Emission Rate*	
		Annual (TPY)	Maximum Hourly (lb/hr)
<u>Particulate Matter</u>	<u>25</u>	<u>312</u> 310.13	71 / 71.25
<u>Sulfur Dioxide</u>	<u>40</u>	821	188 187.5
<u>Nitrogen Dioxide</u>	<u>40</u> (819)	821 } 821.2	188 187.5
<u>Carbon Monoxide</u>	<u>100</u> (163.8)	164 166	38 37.5
<u>Volatile Organic Compounds</u>	<u>40</u> (38122)	38 38.5	8.8 8.75
<u>Lead</u>	<u>06</u> (40.95)	41 41.9	9.4 9.375
<u>Fluorides</u>	<u>3</u> (27.3)	27 27.5	6.3 6.25
<u>Sulfuric Acid Mist</u>	<u>7</u> (6.825)	6.8 6.9788	1.6 1.5625
<u>Beryllium</u>	<u>0.0004</u>	<u>0.003</u> 0.031	0.0007 0.006875
<u>Mercury</u>	<u>0.10</u>	<u>0.63</u> 6.12	0.14 1.4375
<u>Arsenic</u>		<u>0.077</u> 0.087	0.02 0.175

\* Hourly emission rate based on burning 62.5 ton/hr of MSW. Annual emission rate based on burning 1,500 TPD and a 100-percent annual availability factor, for a total of 547,500 TPY.

Source: Malcolm Pirnie, Inc., 1983b.



## 4.0 BEST AVAILABLE CONTROL TECHNOLOGY EVALUATION

### 4.1 Description of Proposed Control Technology

The source applicability analysis for the proposed BCRR facilities, presented in Section 2.0, identified the following emitted air pollutants as requiring a BACT review under federal and state PSD regulations:

- Particulate Matter (PM)
- Sulfur Dioxide (SO<sub>2</sub>)
- Nitrogen Oxides (NO<sub>x</sub>)
- Carbon Monoxide (CO)
- Lead (Pb)
- Fluorides (F<sup>-</sup>)
- Beryllium (Be)
- Mercury (Hg)
- Arsenic (As)

The State of Florida has received administrative and technical review authority for the federal PSD program. In addition, Florida has passed PSD regulations and BACT requirements similar to EPA. DER defines BACT as follows (Ch 17-2.100(22), FAC):

An emission limitation, including a visible emissions standard, based on the maximum degree of reduction of each pollutant emitted which the Department, on a case by case basis, taking into account energy, environmental and economic impacts, and other costs, determines is achievable through application of production processes and available methods, systems, and techniques (including fuel cleaning or treatment or innovative fuel combustion techniques) for control of each such pollutant... Each BACT determination shall include applicable test methods or shall provide for determining compliance with the standard(s) by means which achieve equivalent results.

The remainder of this section describes the proposed BACT, emission limit, visible emission (opacity) standard, and

compliance test methods for each pollutant subject to BACT. An analysis of alternative control technologies, including economic, energy, and environmental considerations, is presented in Section 4.2.

#### 4.1.1 Particulate Matter

PM generated by the combustion of MSW will be minimized through combustion controls and boiler design. PM exiting the boilers in the exhaust gases will be controlled by use of electrostatic precipitators (ESPs). The combustion boiler design will be of the mass-burn stoker-fired, or stoker/rotary kiln tandem, type and capable of firing as-received MSW on a continuous-feed basis without auxiliary fuel firing. The combustion efficiency of the stokers will yield a residue, or ash, containing not more than 4-percent combustibles or 0.2-percent noncombustibles. This boiler design requirement will serve to minimize the generation of ash and, therefore, PM in the furnace.

The number of boilers to be located at the north and south facilities has not been determined to date, but each facility will be capable of charging 1,500 TPD of MSW, based on a 100-percent annual availability factor. The exhaust gases of each boiler will pass through an ESP prior to discharge to the atmosphere through a common stack. Design details for the ESP are not known at this time. Design details will be supplied to DER as they become available for regulatory review. However, the following minimum criteria will have to be met by the selected manufacturer: Each ESP will be capable of reducing the exhaust gas PM concentration to 0.03 gr/dscf, corrected to 12-percent CO<sub>2</sub>, over the range of boiler operating conditions. Opacity of the emissions will not exceed 20 percent.

The ESP will be complete with all appurtenances, structural supports, foundations, external and internal walkways, platforms, access stairways, fly ash hoppers with discharge

air lock valves, power and control wiring, induced-draft fan, and other accessories for a complete operation system. Each ESP will be a multi-field type with the output of each ESP flowing into a single flue. The fields will be sized adequately considering both the volume of gases and amount of excess air. The temperature of flue gases entering the ESP will be below 600°F and at least 40°F above the dew point temperature. The maximum ESP inlet temperature is based on operating experience from ESPs at incinerator installations (EPA, 1979). The ESP design will have been successfully operated in a facility firing MSW for a minimum of 3 years.

ESP gas distributions will be accomplished via a low-velocity, multiple-vane system or a perforated-plate system. ESP collecting surface rapping will be by shaft-driven rotary hammers. Solenoid impact or vibration rapping is not acceptable. ESP high-voltage systems will have star-shaped, spiked, stainless-steel electrodes, with rigid mast mounting and high-alumina refractory-type insulators. Weighted wire systems are not acceptable. ESP discharge electrode rapping will be accomplished by shaft-mounted rotary hammers; solenoid impact or vibrating rapping is not acceptable.

ESP fly ash hopper heaters will be resistance type, extending two thirds of the ash hopper height from the bottom of the hopper (to prevent blockage). The fly ash handling systems include, but are not limited to, screw conveyors inside precipitator hoppers, rotary or double-flap air lock valves, and dry-drag type transfer conveyors.

Each furnace-boiler will be equipped with an induced-draft fan, an induced-draft fan drive, an induced-fan inlet damper, and appropriate breechings. Induced-draft fans will be centrifugal, backward-curved, inclined blade, treated radial-tip-type, designed for continuous operation at 600°F in a dusty environment.

An ESP with an outlet grain loading of 0.03 gr/dscf is considered to represent BACT for the proposed BCRR facilities, based on economic, energy, environmental, and plant operating considerations. NSPS for new incinerators charging more than 50 TPD of solid waste are applicable to this proposed project (40 CFR 601, Subpart E). The NSPS emission standard limits PM emissions to 0.08 gr/dscf, corrected to 12-percent CO<sub>2</sub>. The proposed ESP emission rate is well below this allowable level.

The MSW boilers will be used to generate steam which will drive turbine electrical generators. The boilers will not be subject to the provisions of Subpart D or D(a) of 40 CFR 60, which are the NSPS for fossil-fuel-fired steam generators and electric utility steam generating units, respectively, because MSW is not a fossil fuel.

State of Florida PM emission-limiting standards require new incinerators with a charging rate of greater than 50 TPD to meet 0.08 gr/dscf, corrected to 50-percent excess air. This standard is similar to the federal NSPS, and the proposed facilities will emit PM at a significantly lower rate. State of Florida emission regulations also require an opacity limit of 20 percent, which the proposed facilities will not exceed.

The proposed ESP maximum PM emission rate of 0.03 gr/dscf and estimated maximum exhaust gas flow rate of 276,585 dscfm (see Table 3-2) will result in a maximum PM emission rate of 71 lb/hr. Based on EPA emission factors for municipal incinerators (EPA, 1983), uncontrolled PM emissions are estimated at 30 lb/ton of solid waste fired. EPA's review of NSPS for incinerators (EPA, 1979) cites uncontrolled PM emissions in the range of 10 to 70 lb/ton. However, it is noted that these values are for municipal incinerators and may not be applicable to resource recovery units. Nevertheless, if an average value of 30 lb/ton is assumed, the proposed facilities would generate 1,875 lb/hr of PM. The ESP would then have a PM removal efficiency of at least 98 percent. Assuming an

average MSW heating value of 5,000 Btu/lb, the facilities would emit 0.11 lb/10<sup>6</sup> Btu of PM.

#### 4.1.2 Sulfur Dioxide

The control technology of firing low-sulfur fuel in the mass-burn resource recovery facility is proposed as BACT. The BACT emission limit of 3.0 lb SO<sub>2</sub>/ton of MSW fired is equivalent to 188 lb/hr or 0.30 lb/10<sup>6</sup> Btu heat input. By comparison, NSPS for fossil-fuel-fired boilers and electric utility steam generators firing solid fuel (40 CFR 60, Subparts D and D(a)) would allow up to 1.2 lb SO<sub>2</sub>/10<sup>6</sup> Btu. No SO<sub>2</sub> emission-limiting standard currently exists for incinerators or MSW-fired boilers.

#### 4.1.3 Nitrogen Oxides and Carbon Monoxide

The proposed BACT for NO<sub>x</sub> and CO emissions is boiler design and good combustion practices. The proposed BACT emission limits are 3.0 lb/ton of MSW fired for NO<sub>x</sub> (as NO<sub>2</sub>), and 0.6 lb/ton for CO. These emission factors are equivalent to 188 lb/hr or 0.30 lb/10<sup>6</sup> Btu for NO<sub>x</sub> (as NO<sub>2</sub>) and 38 lb/hr or 0.061 lb/10<sup>6</sup> Btu for CO.

By comparison, NSPS for fossil-fuel-fired boilers [40 CFR 60, Subparts D and D(a)] limit NO<sub>x</sub> (as NO<sub>2</sub>) emissions to between 0.5 and 0.7 lb/10<sup>6</sup> Btu for solid fuel. No NO<sub>x</sub> or CO emission-limiting standard currently exist for incinerators or MSW-fired boilers.

Factors that influence NO<sub>x</sub> emissions from MSW boilers consist of boiler design, excess air, and peak combustion temperatures. NO<sub>x</sub> emissions are derived from either the fuel-bound nitrogen being reduced and subsequently oxidized, or thermal oxidation of nitrogen in the combustion air. The latter source of NO<sub>x</sub> is much greater than the former source. The primary factors affecting combustion air NO<sub>x</sub> is the amount of oxygen in the combustion zone (i.e., related to excess air) and the peak combustion temperature. MSW boilers are

typically designed for low-temperature operation, about 1,800°F (EPA, 1979).

For the proposed facilities, the combustion temperature will be maintained between 1,500°F and 1,800°F. The combustion air system will be designed to automatically control the boiler temperature within 50°F of the set-point temperature selected by the operator, while firing MSW over varying moisture compositions and heating values. Consequently, NO<sub>x</sub> formation will be suppressed, with expected emissions of 3.0 lb/ton or 0.30 lb/10<sup>6</sup> Btu.

CO is produced when carbon-containing fuel is burned in an oxygen-deficient atmosphere, resulting in the carbon atoms being oxidized partially to CO instead of totally to CO<sub>2</sub>. An oxygen-deficient atmosphere may result from deficient amounts of combustion air or incomplete air/fuel mixing. High excess air, proper primary and secondary air distribution, and proper air/fuel mixing all tend to minimize unburned carbon and CO emissions.

#### 4.1.4 Other Pollutants

Other pollutants emitted from the proposed source requiring BACT review are lead, fluorides, beryllium, mercury, and inorganic arsenic. These are all trace elements contained in MSW in very minor quantities. The proposed BACT for lead, beryllium, and inorganic arsenic is the ESP selected in Section 4.1.1 for the control of PM emissions. These pollutants are emitted in the solid phase; therefore, control of PM emissions will also control these pollutants. The BACT emission limits are the emission rates presented in Table 3-4 for each pollutant.

Fluorides and mercury are emitted primarily in the gaseous phase and are not susceptible to collection by ESP. No additional control technology is proposed for these pollutants since such controls would be costly and would not provide significant environmental benefits.

#### 4.1.5 Test Methods to Demonstrate Compliance

Compliance with NSPS for PM will be demonstrated by source emission tests conducted in accordance with the Federal Reference Methods specified in 40 CFR 60, Appendix A. Reference Method 5 will be used in determination of PM emissions, grain loading, and moisture content.

#### 4.2 Comparison of Alternative Control Technologies

Federal and state PSD/BACT regulations and guidelines require that an analysis of alternative control technologies be conducted (EPA, 1980; EPA, 1978). The only alternatives that need be addressed are those "which have greater control capabilities than the system proposed as BACT and which have been used or proposed for the same or similar operations" (EPA, 1978). If no better control technology than the proposed technology exists, no further analysis is necessary. Other equipment with similar control potential need not be evaluated.

The BACT analysis must support that the identified alternative control techniques would cause unreasonably adverse energy, environmental, or economic impacts. The following sections present the alternative analysis required under BACT review and justify selection of the proposed control equipment described in Section 4.1.

##### 4.2.1 Particulate Matter

In March 1979, EPA conducted a survey of all existing and proposed incinerators in the United States (EPA, 1979). The study identified three types of control devices as potentially applicable to incinerators: ESPs, fabric filters, and venturi scrubbers. Test results for PM were compiled for 14 municipal incinerators where the federal reference method (Method 5) was known to be used for testing. MSW charging rates varied from 30 to 600 TPD. Of these installations, only one used a fabric filter for PM control, while nine used ESPs and four utilized

venturi scrubbers. Test results were as follows (corrected to 12-percent CO<sub>2</sub>):

Fabric filter:	0.024 gr/dscf
ESP:	0.018 to 0.060 gr/dscf, average of 0.041 gr/dscf
Venturi scrubber:	0.046 to 0.416 gr/dscf, average of 0.14 gr/dscf

These data indicate that fabric filter technology for incinerators is not well proven. Operational problems with filter gas were noted with the test results. However, the 0.024 gr/dscf emission rate was the second lowest of all test results; one ESP test was lower, with an emission rate of 0.018 gr/dscf.

ESPs are by far the most prevalent type of control and provide much better emission reduction than do venturi scrubbers. The venturi scrubber test results not only indicate much higher average emissions than the ESP, but scrubber deterioration due to wearing of scrubber parts has been noted on several installations. In addition, high scrubber pressure drops are required to meet the 0.08 gr/dscf NSPS, resulting in a significant energy penalty. Those venturi scrubbers meeting NSPS operated with pressure drops of 15 inches of water (in. H<sub>2</sub>O) or greater, whereas an ESP typically operates at 1 to 2 in. H<sub>2</sub>O.

Test data from eight additional municipal incinerator installations where the test method was not specified were also presented. MSW charging rates varied from 120 to 360 TPD, and ESPs were used at all of these installations. The PM emissions ranged from 0.013 to 0.108 gr/dscf and averaged 0.059 gr/dscf (excluding two facilities where test results were reported in gr/acf).

In March 1982, EPA issued a background information document for nonfossil-fuel-fired industrial boilers (EPA,



1982b). The study included a survey of MSW boilers as well as refuse-derived fuel (RDF). This study stated:

No successful scrubber applications to MSW or RDF boilers exist: the fine particulate in these boiler exhausts can be removed only by every high-energy scrubbers which must be constructed of expensive corrosion resistant materials. The only MSW boiler that used a wet scrubber replaced the scrubber with an electrostatic precipitator.

Few full-scale baghouses have been applied to nonfossil fuel fired boilers...no baghouse installations exist on bagasse, MSW or RDF boilers. However, one baghouse operates successfully on an MSW incinerator. The principal drawback to fabric filtration, as perceived by potential users, is a fire danger arising from the collection of a combustible carbonaceous fly ash.

Electrostatic precipitators are currently used on boilers fired with wood, MSW or RDF.

The data from the EPA study show that ESP is highly proven for municipal incinerator applications and is capable of achieving PM emission levels well below NSPS and State of Florida emission standards. In addition, this technology has low energy requirements (i.e., pressure drop of 1 to 2 in. H<sub>2</sub>O) and no liquid waste disposal problem. On the other hand, a high pressure drop is required across a venturi scrubber to achieve levels as low as the proposed emission rate of 0.03 gr/dscf. This requirement would increase maintenance costs because of the severe wear on the venturi and increase energy costs significantly. The fabric filter is relatively unproven on municipal incinerators; although fabric filters potentially could achieve PM levels below 0.03 gr/dscf, they have experienced maintenance and operational problems which must be overcome before they are deemed reliable. For these reasons, venturi scrubbers and fabric filters were not considered further as viable control technologies.

Test data presented in the EPA non-fossil-fuel boiler study consisted of ESP data only for MSW-fired boilers. PM emissions ranged from 0.2 to 0.05 lb/10<sup>6</sup> Btu at average

specific collection areas (SCA) of 140 to 570 ft<sup>2</sup>/1,000 acfm, respectively. Data for the most efficient control device for PM emissions from MSW boilers were also presented (obviously for an ESP; since no other test data were available). These data were for ESPs with SCAs of 240 ft<sup>2</sup>/1,000 acfm or more, and emissions averaged less than 0.1 lb/10<sup>6</sup> Btu in each of the four cases presented. Emissions in lb/10<sup>6</sup> Btu were shown to decrease as the SCA increased, the lowest test case yielding about 0.05 lb/10<sup>6</sup> Btu with an SCA of 573 ft<sup>2</sup>/1,000 acfm. The proposed BCRR facilities will achieve a PM emission level of approximately 0.11 lb/10<sup>6</sup> Btu.

A resource recovery facility similar to the BCRR facilities is now operating in Dade County, Florida. The facility fires a maximum of 3,456 YTP of refuse-derived fuel (RDF). The PM emission rate determined as BACT for this facility was 0.037 gr/dscf and 94.05 lb/hr, or 0.65 lb/ton of RDF fired in the boilers. By comparison, the proposed BCRR facilities emission limit is 0.03 gr/dscf, which is equivalent to 71 lb/hr and 1.14 lb/ton.

The environmental impact of the selected control technology is considered to be minimal. The predicted maximum 24-hour average PM impact due solely to the proposed facilities will be less than 10 percent of the de minimis air quality impact level (i.e., for monitoring exemption), less than 20 percent of the significant impact level (i.e., for modeling exemption), less than 3 percent of the PSD Class II increment, and less than 1 percent of Florida AAQS. Predicted annual average PM impacts due to the facilities are 10 percent of the significant impact level (for modeling exemption), less than 1 percent of the PSD Class II increment, and less than 1 percent of Florida AAQS. These minimal environmental impacts do not justify a lower BACT emission level.

$$\begin{array}{r} 0012 \\ 1500 \\ \hline 6000 \\ 12 \\ \hline 1,8000 \end{array}$$

$$\begin{array}{r} 5 \times 10^3 \\ 2 \times 10^2 \end{array}$$

$$\begin{array}{r} 100012 \\ 2000 \\ \hline .4000 \end{array}$$

5000 BTU/#  
#/10<sup>6</sup> BTU

#### 4.2.2 Sulfur Dioxide

Sulfur is contained in MSW in very small quantities, typically about 0.12 percent on an as-fired basis. For the proposed facilities, the resulting SO<sub>2</sub> emissions are 3.0 lb/ton or 0.30 lb/10<sup>6</sup> Btu heat input. Precombustion and postcombustion SO<sub>2</sub> control technologies have been developed for boilers firing fossil fuels. However, SO<sub>2</sub> control technologies have not been applied to boilers burning non-fossil fuels, such as MSW, due to the low SO<sub>2</sub> emissions.

Precombustion control technologies consist of: (1) using naturally occurring low-sulfur fuels, and (2) physically or chemically cleaning the fuel. The MSW fired in the proposed facility falls into this first category, with a sulfur content of 0.12 percent (i.e., 0.30 lb/10<sup>6</sup> Btu). By comparison, low-sulfur coal typically contains 0.5-percent sulfur (i.e., about 0.8 lb/10<sup>6</sup> Btu). and No. 2 distillate oil typically is as low as 0.35-percent sulfur by weight (i.e., about 0.4 lb/10<sup>6</sup> Btu).

No method of physically or chemically cleaning MSW to lower its sulfur content is known to have been developed. The naturally low sulfur content of MSW has not required such a process to be developed. Therefore, precombustion sulfur removal from MSW is deemed technologically unfeasible.

Postcombustion SO<sub>2</sub> removal techniques for boilers consist of the implementation of flue gas desulfurization (FGD) technology. Several different FGD systems have been developed, primarily for use on high-sulfur-fuel-fired boilers. These consist of sodium scrubbing, dual-alkali scrubbing, lime and limestone scrubbing, and dry scrubbing. These systems use calcium- or sodium-based scrubbing solutions which react with SO<sub>2</sub> to form sulfite and sulfate salts.

The major drawbacks to all of these systems are:

1. They produce large amounts of solid and/or liquid wastes, which must be disposed of properly.

Disposal may cause other environmental effects (i.e., ground water contamination).

2. Energy requirements to operate the FGD system are high. Typical FGD installations on electric utility boilers use 10 percent or more of the energy output of the boiler.
3. FGD systems have not been applied to incinerators where SO<sub>2</sub> concentrations are low and highly variable due to the variable nature of MSW.
4. FGD systems are costly to install and operate and require considerable maintenance; due to operational problems they are rarely available 100 percent of the time, unless costly redundancy is built into the plant.
5. FGD systems typically use large amounts of water for the scrubbing solution.

Costs of applying an FGD system to a resource recovery/incinerator facility were estimated by Environmental Research and Technology, Inc. (1981) as part of the PSD permit application for Westchester County (New York) Resource Recovery Facility. This facility is capable of firing 1,890 TPD of MSW, which is approximately the size of the proposed Broward County facilities (1,650 TPD each). Five different FGD system types were evaluated.

SO<sub>2</sub> removal efficiency of each system was assumed to be 70 percent. Capital costs of an FGD system were found to range from \$7 to \$9 million (1983 dollars). Annual costs, including fixed capital charges and operating and maintenance costs, ranged from \$0.94 to \$1.34 per 10<sup>6</sup> Btu for the first year of operation. These annual costs equate to \$4.6 to \$6.5 million, based on a 90-percent availability factor.

There are no energy penalties associated with the proposed control technology. The associated environmental impacts are minimal. The predicted maximum 24-hour SO<sub>2</sub> impacts due to the proposed facility are 18 percent of the de minimis impact level (i.e., for monitoring exemption) and less

than 48 percent of the significant impact levels (i.e., for modeling exemption). Predicted impacts for all averaging times are less than 4 percent of all PSD Class II increments and Florida AAQS. The minimal SO<sub>2</sub> emissions and environmental impacts do not justify a lower BACT emission limit.

Considering the low SO<sub>2</sub> emissions from the proposed facility and the severe economic penalties, potential additional environmental impacts due to solid/liquid waste disposal, additional water and energy requirements, and unproven ability on MSW-fired boilers, implementation of an FGD system on the proposed BCRR facilities is considered economically and environmentally unacceptable. None of the SO<sub>2</sub> removal alternatives is considered superior to that of firing low-sulfur MSW fuel in the boiler.

#### 4.2.3 Nitrogen Oxides and Carbon Monoxide

The proposed BACT control techniques for NO<sub>x</sub> and CO emissions from the proposed BCRR facilities are: (1) limit peak combustion temperature to 1,800°F, (2) proper MSW firing in the boiler, and (3) high excess air operation. These control techniques are considered the only currently available methods of control for these pollutants.

The proposed BACT emission limits for NO<sub>x</sub> result in maximum annual average predicted impacts of less than 3 percent of the de minimis impact level (i.e., for monitoring exemption), 30 percent of the significant impact level (i.e., for modeling exemption), and less than 0.5 percent of Florida AAQS. The proposed CO emission limit results in maximum predicted impacts of less than 1 percent of any de minimis impact level, significant impact level, or Florida AAQS.

Further reduction in emissions could be achieved through add-on flue gas cleaning equipment, but such equipment or processes have not been demonstrated in practice on incinerators (EPA, 1979). Flue gas cleaning methods for application to industrial/utility boilers with higher NO<sub>x</sub> emissions are

currently in the developmental stage only. Therefore, add-on NO<sub>x</sub>/CO controls are not considered technically feasible for this application. In addition, the very small air quality impacts due to NO<sub>x</sub> and CO emissions from the proposed BCRR facilities do not justify further reduction in emissions.

#### 4.2.4 Other Pollutants

As discussed in Section 4.1.4, ESP used to control PM emissions will also control emissions of lead, beryllium, and inorganic arsenic. Alternative PM control technology is discussed in Section 4.2.1. For the reasons stated therein, ESP is considered to be the best choice of PM control technology for the proposed source and, therefore, BACT for control of lead, beryllium, and arsenic. The maximum predicted air quality impacts for these pollutants are well below all applicable air quality standards and de minimis impact levels (see Table 6-2). The minimal environmental impacts of these pollutants do not justify addition controls or reduced emission levels.

Additional control technology (i.e., add-on equipment) could be used to further reduce emissions of fluorides and mercury, which are emitted primarily in the gaseous phase. For example, a wet scrubber could be used, which has been demonstrated to remove more than 99 percent of the fluorides at phosphate rock plants. However, due to the low emission rates for these pollutants and the economic and energy penalties associated with add-on control equipment, additional add-on equipment is not justified. The maximum predicted air quality impacts for these pollutants are well below all applicable air quality standards and de minimis impact levels.

## 5.0 AIR QUALITY MODELING APPROACH

### 5.1 Model Selection

The ISC dispersion model (Cramer, 1979) was used to evaluate the proposed BCRR facilities' emissions. This model is contained in EPA's User's Network for Applied Modeling of Air Pollution (UNAMAP), Version 5 (EPA, 1983). The ISC model was selected primarily for the following reasons:

1. EPA and Florida DER have approved the general use of the model for air quality dispersion analyses because the model assumptions and methods are consistent with those in the Guideline on Air Quality Models (EPA, April 1978).
2. The ISC model is capable of predicting the impacts from stack, area, and volume sources that are spatially distributed over large areas and located in flat or gently rolling terrain.
3. The results from the ISC model are appropriate for addressing compliance with AAQS and PSD Class I and Class II increments.

The ISC model has rural and urban options which affect the plume rise formulas, wind speed profile exponent law, dispersion curves, and mixing height formulations used in calculating ground-level concentrations. One of the criteria used to determine when the rural or urban mode is appropriate is based on land use near the proposed plant (Auer, 1978). If the land use is classified as heavy industrial, light-moderate industrial, commercial, or compact residential for more than 50 percent of the area within a 3-km radius circle centered on the proposed source, the urban mode should be selected. Otherwise, the rural option is more appropriate. Based on a review of the land use around both facilities, the rural mode was selected because of the general lack of or minimal industrial and commercial development.



The ISC model consists of two model codes. The first model code, the ISC short-term (ISCST) model, is an extended version of the single-source (CRSTER) model (EPA, 1977). The ISCST model is designed to calculate hourly concentrations based on hourly meteorological parameters (i.e., wind direction, wind speed, atmospheric stability, ambient temperature, and mixing heights). The hourly concentrations are processed into non-overlapping, short-term averaging periods. For example, a 24-hour average concentration is based on twenty-four 1-hour averages calculated from midnight of each day. For each short-term averaging period selected, the highest and second-highest average concentrations are calculated for each receptor. As an option, a table of the 50 highest concentrations over the entire field of receptors can be produced. For the annual averaging period, the 1-hour concentrations are summed for all hours in the year for each receptor.

The second model code is the ISC long-term (ISCLT) model, which is an extension of the Air Quality Display Model (AQDM) and the Climatological Dispersion Model (CDM). The ISCLT model uses joint frequencies of wind direction, wind speed, and atmospheric stability to calculate seasonal and/or annual average ground-level concentrations. This model code was not used because the annual average concentrations were obtained from the ISCST model.

## 5.2 Meteorological Data

Meteorological data used in the ISCST model to determine air quality impacts consisted of a 5-year period (1970 to 1974) of hourly surface weather observations and twice-daily concurrent radiosonde soundings from the NWS station in Miami, Florida.

The NWS station in Miami, located approximately 55 km south-southwest of the proposed north plant site and 35 km south-southwest of the proposed south plant site, was selected

for use in the study because it is the closest primary weather station to the study area with similar surrounding topographical features and land-water boundaries. This station also has the most readily available and complete data base which is representative of the proposed plant site. The surface observations included wind direction, wind speed, temperature, cloud cover, and cloud ceiling. The wind speed, cloud cover, and cloud ceiling values are used in the ISCST meteorological preprocessor program to determine atmospheric stability using the Turner stability scheme. Based on the temperature measurements at Miami, Florida, morning and afternoon mixing heights were calculated with the radiosonde data at Miami using the Holzworth approach (1972). Hourly mixing heights were derived from the morning and afternoon mixing heights using the interpolation method developed by EPA (Holzworth, 1972). The hourly surface data and mixing heights were used to develop a sequential series of hourly meteorological data (i.e., wind direction, wind speed, temperature, stability, and mixing heights). Because the observed hourly wind directions are classified into one of thirty-six 10-degree sectors, the wind directions are randomized within each sector using an EPA preprocessing program to account for the expected variability in air flow.

### 5.3 Receptor Grid

In the screening modeling analysis, concentrations were predicted for 360 receptor locations in a radial grid around each facility. The radial grid consisted of 36 radials located 10 degrees apart with 10 receptors located along each radial. The downwind distances of the receptors from the proposed source were 0.3, 0.7, 1.1, 1.5., 1.9, 2.3, 2.7, 3.1, 3.5, and 3.9 km along each radial. For addressing compliance with PSD Class II increments, model results were calculated for only one facility because the proposed facilities are

identical in stack and operating design; results for one facility will apply to the other.

In the refined modeling analysis, concentrations were predicted using a 700-m by 700-m receptor grid centered on the receptor that produced the highest, second-highest concentration for the short-term averaging period. Receptors were separated by 100-m intervals. Refined modeling analysis was not performed for the annual average concentration because their spatial distribution is not expected to vary significantly for the radial receptor grid.

For addressing compliance with PSD Class I impacts, the two proposed facilities were modeled in the same model run to predict maximum impacts at 30 receptor locations, spaced 2 km apart, along the northeast boundary of the Everglades National Park. These receptor locations were selected along this boundary because it is the closest portion of the Class I area to the proposed sources. No refined modeling analysis was performed for Class I impacts.

#### 5.4 Review of Existing Ambient Monitoring Data

A listing of all the ambient monitoring locations in Broward County is presented in Table 5-1. There are currently 18 sites operated by Broward County and 3 sites operated by Florida Power & Light Company (FP&L). Based on the PSD monitoring guidelines (EPA, 1981), for a proposed source located in an area of multisource emissions and flat terrain, existing ambient monitoring data may be acceptable if the existing monitor is within 10 km of the proposed source or 1 km of predicted maximum impacts.

The existing monitoring sites located within 10 km of the north and south facilities are listed in Tables 5-2 and 5-3, respectively. The maximum concentrations measured during 1982 are also presented in Tables 5-2 and 5-3. Based on these

Table 5-1. Ambient Air Monitoring Sites in Broward County

SAROAD No.	Broward County No. or Operator	Location		Pollutant Measured	Location with Respect to			
		City/Division	UIM X,Y Coordinates (km)		North Facility		South Facility	
					Direction (°)	Distance (km)	Direction (°)	Distance (km)
3700003G01	1	Pompano Beach	590.17, 2908.00	TSP	62	7.0	23	26.8
3700002G01	3	Pompano Beach	587.85, 2902.78	TSP	117	4.3	23	21.1
2270001G01/09	4	Lauderdale Lakes	579.55, 2894.76	TSP, NO <sub>2</sub> , SO <sub>2</sub> , CO	204	10.9	360	11.4
3640002G01	5	Plantation	575.52, 2891.27	TSP	212	15.9	334	9.4
1260003G01	6	Ft. Lauderdale	583.11, 2890.09	TSP, NO <sub>2</sub> , SO <sub>2</sub> , CO, Pb	183	14.7	27	7.6
4350001G01	7	Tamarac	574.44, 2897.87	TSP	234	11.8	340	15.4
0910002G01	8	Davie	576.19, 2884.99	TSP, NO <sub>2</sub> , SO <sub>2</sub>	202	21.2	296	3.81
3530001G01	9	Pembroke Pines	575.26, 2877.44	NO <sub>2</sub> , SO <sub>2</sub>	198	28.7	216	7.3
1840001G01	10	Hollywood	582.21, 2876.98	TSP, Pb	184	27.8	158	6.9
1640001G01	11	Hallandale	584.60, 2874.44	TSP	179	30.3	151	10.2
1260004G01/09	12	Ft. Lauderdale	585.20, 2887.20	TSP, NO <sub>2</sub> , SO <sub>2</sub>	176	17.6	55	6.8
0420002G01	13	Hacienda Village	579.70, 2885.34	CO	192	19.9	3	2.0
0420003G03	14	Oral Springs	571.60, 2906.88	O <sub>3</sub>	280	12.6	341	24.9
3530002G01/09	15	Pembroke Pines	570.00, 2878.40	TSP	208	29.8	297	10.8
0420004G01	16	N. Lauderdale	577.73, 2900.11	O <sub>3</sub>	234	7.8	354	16.9
3700004G01	17	Pompano Beach	585.34, 2900.13	CO	164	4.8	19	17.8
1840002G01	18	Hollywood	584.00, 2875.87	CO	180	28.9	150	8.6
2560002G01	19	Margate	578.86, 2903.51	TSP, Pb	257	5.3	358	20.2
1260005J02	FP&L	Ft. Lauderdale	579.28, 2882.35	TSP, NO <sub>2</sub> , SO <sub>2</sub>	192	22.9	199	1.0
1260006J02	FP&L	Ft. Lauderdale	583.05, 2883.85	TSP, NO <sub>2</sub> , SO <sub>2</sub>	183	20.9	81	3.5
1260007J02	FP&L	Ft. Lauderdale	589.10, 2886.85	TSP, NO <sub>2</sub> , SO <sub>2</sub>	164	18.6	70	10.1

Source: ESE, 1983.

Table 5-2. 1982 Ambient Air Quality Data for Monitoring Stations Within 10 km of the North BCRR Facility

Broward County No. or Operator	SAROAD No.	Concentration ( $\mu\text{g}/\text{m}^3$ )*							
		TSP		SO <sub>2</sub>		NO <sub>2</sub>	CO†		Pb
		24-hr	Annual	24-hr	Annual	Annual	1-hr	8-hr	Quarter
1	3700003G01	60	35	—	—	—	—	—	—
3	3700002G01	72**	31**	—	—	—	—	—	—
4	2270001G01	73	39	3**	3**	33**	13	6	—
4C††	2270001G09	66	39	3	3	34	—	—	—
17	3700004G01	—	—	—	—	—	11**	6**	—
19	2560002G01	56	28	—	—	—	—	—	0.1**
Florida AAQS		150	60	260	60	100	40	10	1.5

\* For short-term averages, second-highest concentration is shown.

† CO concentrations in  $\text{mg}/\text{m}^3$ .

\*\* Closest monitoring station for specified pollutant.

†† Colocated with Site No. 4.

Source: ESE, 1983.

Table 5-3. 1982 Ambient Air Quality Data for Monitoring Stations Within 10 km of the South BCRR Facility

Broward County No. or Operator	SAROAD No.	Concentration (ug/m <sup>3</sup> )*							
		TSP		SO <sub>2</sub>		NO <sub>2</sub>	CO†		Pb
		24-hr	Annual	24-Hr	Annual	Annual	1-hr	8-hr	Quarter
5	3640002G01	59	29	—	—	—	—	—	—
6	1260003G01	90	56	16	5	38	15	9	0.8
8	0910002G01	73	33	10	3	27	—	—	—
9	3530001G01	—	—	5	3	28	—	—	—
10	1840001G01	92	43	—	—	—	—	—	0.3**
12	1260004G01	72	36	16	4	30	—	—	—
12C††	1260004G09	—	—	16	4	30	—	—	—
13	0420002G01	—	—	—	—	—	25**	10**	—
18	1840002G01	—	—	—	—	—	12	7	—
FP&L	1260005J02	95**	38**	17**	3**	36**	—	—	—
FP&L	1260006J02	93	39	8	3	47	—	—	—
FP&L	1260007J02	78	32	5	3	21	—	—	—
Florida AAQS		150	60	260	60	100	40	10	1.5

\* For short-term averages, second-highest concentration is shown.

† CO concentrations in mg/m<sup>3</sup>.

\*\* Closest monitoring site for specified pollutant.

†† Colocated with Site No. 12.

Source: ESE, 1983.

measured maximum concentrations, pollutant concentrations within a 10-km radius from each facility are generally less than 65 percent of the national and Florida AAQS, except for CO. It should be noted that the SO<sub>2</sub> and NO<sub>2</sub> concentrations are not measured by an acceptable technique for use in PSD applications. However, based on the data presented in Tables 5-2 and 5-3, the measured SO<sub>2</sub> and NO<sub>2</sub> concentrations are well below AAQS. Also, based on the modeling results presented in Section 6.0, the maximum predicted concentrations due to each resource recovery facility are expected to be below the de minimis impact levels for all pollutants except lead; therefore, no monitoring is required for those pollutants. Currently, a de minimis impact level has not been designated for inorganic arsenic because an appropriate monitoring method has not yet been developed. As a result, no monitoring is required for that pollutant. For lead, ambient concentrations are measured at 1 monitor within 6 km from the north facility and 2 monitors within 8 km from the south facility. These monitoring sites, which are expected to measure general population-created pollution, have measured maximum concentrations that are less than 55 percent of AAQS. Because the maximum impacts from the proposed facilities are expected to be low and existing ambient lead concentrations are well below AAQS, preconstruction monitoring for lead is not considered necessary for the BCRR facilities.

The only measured pollutant that approached AAQS in 1982 was CO. Within a 10-km radius of the proposed south facility, the highest and second-highest 8-hour average CO concentrations for 1982 equalled the 8-hour AAQS at one monitor location (i.e., Broward County Site No. 13). Based on data received through August 1983 from DER and Broward County Environmental Quality Control Board (EQCB), the highest and second-highest 8-hour average concentrations measured at Broward County Site No. 13 in 1983 were 10 and 9.5 mg/m<sup>3</sup>,

respectively. Thus, the second-highest concentration at this site is slightly less than the AAQS of 10 ug/m<sup>3</sup>. Based on the model results presented in Section 6.0, the maximum predicted 8-hour average concentration due to the proposed facilities is well below the PSD significant impact level. Therefore, the proposed facilities will not have a significant impact in the vicinity of the monitor.



## 6.0 AIR QUALITY MODELING RESULTS

Predicted maximum impact concentrations for each of the proposed BCRR facilities, using screening and refined modeling receptor grids, are presented in Tables 6-1 and 6-2, respectively. These results are based on each plant charging 1,500 TPD, or 62.5 tons per hour, of MSW and using the maximum hourly emission rates presented in Table 3-4 (see Section 3.3.3).

In general, maximum pollutant concentrations increased slightly for the refined receptor grid as compared to the screening grid. For all the pollutants, the predicted maximum concentrations are below the PSD significant impact levels and de minimis monitoring levels, as a result, the proposed plants' emissions do not produce a significant impact for SO<sub>2</sub>, PM, NO<sub>2</sub>, and CO concentrations, and, therefore, do not require additional modeling analyses. For the other regulated pollutants, for which significant impact levels have not been established, the predicted maximum concentrations are well below the de minimis monitoring levels established for these pollutants. It should be noted that even if the two plants were colocated (i.e., double the concentrations presented in Tables 6-1 and 6-2), the predicted maximum concentrations are below the PSD significant impact levels and de minimis monitoring levels (i.e., combined impact would slightly exceed significant impact level). Based on these results and the existing low measured pollutant concentrations in Broward County (see Section 5.4), the proposed emissions from each of the resource recovery facilities are expected to comply with the national and Florida AAQS and PSD Class II increments.

The proposed emissions from both of the BCRR facilities, modeled together, also produce predicted maximum concentrations that are less than the PSD significant impact levels and de minimis monitoring levels in the PSD Class I area in the

TABLE 6-1

Predicted Maximum Concentrations for Each Proposed Resource Recovery Facility  
Using Screening Modeling Methods

Pollutant	Averaging Time	Maximum Concentration* ( $\mu\text{g}/\text{m}^3$ )	Receptor Location†		Period		
			Direction (°)	Distance (km)	Year	Julian Day	Hour Ending
SO <sub>2</sub>	3-hour	10.3	300	2.3	1971	126	12
		2.4	270	3.1	1970	165	24
			260	2.7	1973	107	24
	Annual	0.3	280	3.1-3.9	1970	—	—
			300	2.3-3.9	1972,1974	—	—
TSP	24-hour	0.9	270	3.1	1970	165	24
			260	2.7	1973	107	24
			Annual	0.1	280	3.1-3.9	1970
	300	2.3-3.9	1972,1974		—	—	
	NO <sub>2</sub>	Annual	0.3	280	3.1-3.9	1970	—
300				2.3-3.9	1972,1974	—	—
CO	1-hour	4.5	90	1.5	1973	191	11
	8-hour	1.3	310	1.9	1972	111	16
Pb	24-hour	0.12	270	3.1	1970	165	24
			260	2.7	1973	107	24
			(Quarterly)	(0.02)**	(280)	(3.1-3.9)	(1970)
	(300)	(2.3-3.9)	(1972,1974)		(—)	(—)	
	F	24-hour	0.08	270	3.1	1970	165
260				2.7	1973	107	24
Be	24-hour	0.000009	270	3.1	1970	165	24
			260	2.7	1973	107	24
Hg	24-hour	0.0018	270	3.1	1970	165	24
			260	2.7	1973	107	24

\* Highest, second-highest concentration for short-term period; highest concentration for annual period. Values in parentheses represent results associated with revised de minimis monitoring levels. See Section 2.2 for details.

† With respect to proposed facility.

\*\* Annual average.

Source: ESE, 1983.

TABLE 6-2

PREDICTED MAXIMUM CONCENTRATIONS FOR THE PROPOSED RESOURCE RECOVERY FACILITY  
USING REFINED MODELING METHODS

Pollu- tant	Averaging Time	Maximum* Concentration (ug/m <sup>3</sup> )	Receptor Location†		Period			Signif- icant Impact Levels <sub>3</sub> (ug/m <sup>3</sup> )	De Minimis Monitoring Levels <sub>3</sub> (ug/m <sup>3</sup> )
			Direction (°)	Distance (km)	Year	Julian Day	Hour Ending		
SO <sub>2</sub>	3-hour	10.3	301	2.44	1971	167	15	25	NA
			300	2.3	1971	126	12		
	24-hour	2.4	260,	2.6-3.1	1970	165	24	5	13
			270		1973	107	24		
	Annual	0.3	280	3.1-3.9	1970	-	-	1	NA
300			2.3-3.9		1972,74	-	-		
TSP	24-hour	0.9	260,	2.6-3.1	1970	165	24	5	10
			270		1973	107	24		
	Annual	0.1	280	3.1-3.9	1970	-	-	1	NA
			300		2.3-3.9	1972,74	-		
	NO <sub>2</sub>	Annual	0.3	280	3.1-3.9	1970	-	-	1
300				2.3-3.9		1972,74	-	-	
CO	1-hour	5.0	94	1.4	1973	189	12	2,000	NA
	8-hour	1.4	312	2.0	1972	112	16	500	575
Pb	24-hour	0.12	260,	2.6-3.1	1970	165	24	NA	0.1
			270		1973	107	24		
	(Quarterly)	(0.02)**	(280)	(3.1-3.9)	(1970)	-	-	(NA)	(0.1)
			(300)		(2.3-3.9)	(1972,74)	-		
F <sup>-</sup>	24-hour	0.08	260,	2.6-3.1	1970	165	24	NA	0.25
			270		1973	107	24		
Be	24-hour	0.000009	260,	2.6-3.1	1970	165	24	NA	0.0005 (0.001)
			270		1973	107	24		
Hg	24-hour	0.0018	260,	2.6-3.1	1970	165	24	NA	0.25
			270		1973	107	24		

NA - Not applicable.

\* Highest, second-highest concentration for short-term period; highest concentration for annual period. Values in parentheses represent results associated with revised de minimis monitoring levels. See Section 2.2 for details.

† With respect to proposed facility.

\*\* Annual average.

Source: ESE, 1983.

Everglades National Park (Table 6-3). These results are consistent with the predicted maximum concentrations within the near vicinity of the proposed facilities. Thus, the emissions for the two proposed BCRR facilities are expected to comply with national and Florida AAQS and PSD Class I increments in the Everglades National Park.

TABLE 6-3

PREDICTED MAXIMUM CONCENTRATIONS AT THE PSD CLASS I AREA DUE TO  
BOTH PROPOSED RESOURCE RECOVERY FACILITIES

Pollutant	Averaging Time	Maximum Concentration*	Receptor Location†		Period			Significant Impact Levels <sub>3</sub> (ug/m <sup>3</sup> )	De Minimis Monitoring Levels <sub>3</sub> (ug/m <sup>3</sup> )
			UIM Coord. (km)	x	y	Year	Julian Day		
SO <sub>2</sub>	3-hour	1.5	522.75	2849.4	1971	261	24	25	N/A
	24-hour	0.4	520.75	2849.4	1973	311	24	5	13
	Annual	0.0	-	-	-	-	-	1	N/A
TSP	24-hour	0.2	520.75	2849.4	1973	311	24	5	10
	Annual	0.0	-	-	-	-	-	1	N/A
NO <sub>2</sub>	Annual	0.0	-	-	-	-	-	1	14
CO	1-hour	0.6	532.75	2847.4	1971	216	20	2,000	N/A
	8-hour	0.2	532.75	2847.4	1972	346	8	500	575
Pb	24-hour (Quarterly)	0.02 (0.0)**	520.75	2849.4	1973	311	24	N/A	0.1 (0.1)
F	24-hour	0.01	520.75	2849.4	1973	311	24	N/A	0.25
Be	24-hour	0.000002	520.75	2849.4	1973	311	24	N/A	0.001 (0.0005)
Hg	24-hour	0.0003	520.75	2849.4	1973	411	24	N/A	0.25

\* Highest, second-highest concentration for short-term period; highest concentration for annual period. Values in parentheses represent results associated with revised de minimis monitoring levels. See Section 2.2 for details.

† North and south facilities UIM x,y coordinates are 583.96, 2904.7 and 579.62, 2883.45 km, respectively.

\*\* Annual average.

Source: ESE, 1983.

## 7.0 IMPACTS ON VEGETATION, SOILS, AND VISIBILITY

### 7.1 Impacts on Vegetation and Soils

The vegetation in the Broward County portion of southeastern Florida consists primarily of garden and landscape plants and weeds which occupy disturbed and undeveloped sites. Common plants for landscaping include tropical broadleaf evergreens such as Ficus species (spp.), palms, and Araucaria spp. Common species on disturbed sites include Brazilian pepper tree (Schinus terebinthefolius), Melaleuca quinquenervia, castor bean (Ricinis communis), and other quick-growing woody shrubs.

The site location for the proposed south resource recovery facility contains a combination of upland and wetland vegetation. The southern portion of the site is upland in character and contains species such as Brazilian pepper, wax myrtle, water pennywort (Hydrocatyle sp.), pickerel weed (Pontederia lanceolata), water plantain (Sagittaria sp.), water hyssop (Bacopa sp.), and spike rush (Eleocharis sp.), as well as exotic species such as Melaleuca, Brazilian pepper, and Australian pine (Casuarina equisetifolia). Deposition of dredge material from previous dredging operations along the South Fork of the New River, which flows along the southern and eastern border of the site, has created a narrow berm on which exotic and upland species grow. Much of the existing wetland area on the site has been degraded by previous site disturbances and is in a state of transition to weedy plant species.

The site location for the proposed north resource recovery facility also contains a combination of upland and wetland vegetation. Most of the site is characterized as upland, with the predominant vegetation being dense stands of Brazilian pepper. There are three identifiable stands of cypress (Taxodium distichum) on the site which probably

represent the remnants of an earlier, more extensive system. Other cypress trees and cabbage palms (*Sabal palmetto*) are scattered throughout the Brazilian pepper but are gradually being replaced by the Brazilian pepper.

The eastern border of the Everglades National Park, a PSD Class I area, is approximately 75 and 57 km southwest of the north and south plant sites, respectively. Important plant species in the park include sawgrass (*Cladium jamaicense*), Dade County slash pine (*Pinus elliotti* var. *densa*), and epiphytic vascular plants.

Plant response to atmospheric pollutants is influenced by the concentration, duration of each exposure, and the frequency of exposures. The usual pattern of pollutant exposure is that of a few episodes of relatively high concentrations for a short duration, interspersed with long periods of extremely low concentrations. Effects on most plants will be from the short-term higher doses (i.e., product of the pollutant concentration and the duration of exposure). Very little information is available on the effects of airborne pollutants on species in south Florida. Therefore, the pollutant concentrations expected as a result of each facility operation are compared with the lowest concentrations known to affect the most sensitive plants that have been tested for response to each pollutant. It should be noted that these concentration levels that adversely affect plants are based on a literature review for plants that may not grow in this part of the state. Thus, these concentration levels represent a conservative threshold for comparison with the maximum predicted concentrations.

The maximum predicted total concentration for each pollutant due to each facility is presented in Table 7-1. The total predicted concentration consists of the maximum predicted facility concentration added to a background concentration developed from the maximum concentration measured at the

Table 7-1. Maximum Predicted Concentrations Due to Proposed Resource Recovery Facilities Compared to Concentrations Known to Adversely Impact Vegetation

Pollutant	Average Period	Concentration ( $\mu\text{g}/\text{m}^3$ )			Lowest Concentration Known to Impact Vegetation ( $\mu\text{g}/\text{m}^3$ )	Reference
		Maximum Predicted Due to Facility	Background*	Total (Facility Plus Background)		
SO <sub>2</sub>	3-hour	10.3	17†	27.3	260	Tingey, 1973.
TSP	24-hour	0.9	95	95.9	1,000 g/m <sup>2</sup>	Williams, 1971.
NO <sub>2</sub>	Annual	0.3	47	47.3	120	Thompson, 1970.
	3-hour	10.3	89†	99.3	188	Tingey, 1971.
CO	1-hour	5.0	25,000	25,006	Vegetation not impacted by CO	—
Pb	3-month	0.02	0.8	0.82	Not known to be available to plants	Zimdahl, 1973.
F <sup>-</sup>	24-hour	0.01	**	0.01	0.10	NAS, 1971.
Be	24-hour	0.000011	**	0.000011	Not known to be available to plants	Gough, 1979.
Hg	24-hour	0.0024	**	0.0024	10 (Duration unknown)	Stahl, 1979.

\* Second highest 3- or 24-hour or highest annual average concentration measured within 10 km of either the north or south facility (see Section 5.4).

† 24-hour average concentration; shorter averaging period not available with monitoring technique.

\*\* Ambient monitoring data not available in Broward County.

Source: ESE, 1983.



monitoring station nearest either of the two proposed plant locations (See Section 5.4). The lowest concentrations known to adversely impact the most sensitive plants tested for effects of pollutants are also presented in Table 7-1.

As indicated in Table 7-1, the maximum concentrations of pollutants expected to result from operation of the proposed facilities are either orders of magnitude below concentrations known to adversely impact sensitive plants or are not known to impact vegetation at all. Since the maximum concentrations of the same pollutants that are expected in the Everglades National Park are even lower than those expected near the facilities, no impact on the vegetation of the Class I area due to operation of the facilities is expected.

Soils in the region of south Florida where the proposed sites are located and the Everglades National Park are highly calcareous sands or organic soils with high cation exchange capacity. Thus, the soils have the capability of neutralizing or adsorbing any acidic pollutants attributable to the proposed facilities. Again, the concentration of pollutants expected to result from operation of the BCRR facilities is so low that, in any event, effects on soils will be negligible.

## 7.2 Visibility Impacts

CAA Amendments of 1977 provide for implementation of guidelines to prevent visibility impairment in mandatory Class I areas. The guidelines are intended to protect the aesthetic quality of these pristine areas from reduction in visual range and atmospheric discoloration due to various pollutants. The nearest Class I area to the proposed plant site is the Everglades National Park, located about 57 and 75 km from south and north resource recovery facilities, respectively. Because the maximum predicted impacts are below the PSD significant and de minimis impact levels for all regulated pollutants, the

impact on visibility in Class I areas due to the proposed plants will be insignificant. To demonstrate this conclusion, a Level-1 visibility screening analysis to determine potential adverse visibility effects was performed using the procedures suggested in the Workbook for Estimating Visibility Impairment (EPA, 1980). Based on this analysis using worst-case meteorological conditions and assumptions, the three contrast parameters (i.e., plume contrast against sky plume contrast against terrain, and change in sky/terrain contrast caused by primary and secondary aerosols) were estimated for the total emissions from the proposed north and south facilities. The results of this analysis indicated that the absolute values of the contract parameters were lower than the criteria used to determine if potential adverse visibility impairment could occur in Class I areas. Based on these results, the emissions from both proposed facilities are highly unlikely to cause adverse visibility impairment in the Everglades National Park.

### 7.3 Indirect Air Quality Impacts

The indirect air quality impacts associated with the proposed facilities would be attributable to the increased automotive traffic generated by employee travel and solid waste delivery. It is anticipated that about 330 solid waste transport vehicles per day would deliver municipal refuse to each facility. The impact of the exhaust emissions from the solid waste transport vehicles is expected to be minimal. The vehicles associated with each facility would represent an increase of less than 1 percent of the traffic that travels on existing roadways (Malcolm Pirnie, 1983b). In addition, the solid waste transport vehicles would largely replace the vehicles used for the existing solid waste transport pattern. Since the operation of the proposed facilities will require only about 40 fulltime employees, the impacts associated with employee traffic also will be negligible.

## 8.0 SUMMARY AND CONCLUSIONS

The following discussions present a summary and conclusions drawn from the results of this study.

1. Each of the proposed BCRR facilities will be a major source of emissions for PM, SO<sub>2</sub>, NO<sub>2</sub>, and CO. Each facility will also have significant emissions for Pb, F, Be, Hg, and As. Therefore, these pollutants must undergo review under the new source review requirements of the PSD regulations. The other regulated pollutants are not emitted above the PSD significant emission rates and, therefore, do not require PSD review.
2. Emission control equipment to be used at each of the proposed facilities will be designed to remove more than 98 percent of PM. This will result in the emission of 0.03 gr/dscf of PM, which is about 60 percent better than existing EPA NSPS requirements for solid waste incinerators.
3. The proposed control systems included in the design and operational procedures for PM, SO<sub>2</sub>, NO<sub>2</sub>, CO and trace pollutant emissions are considered EACT. No alternative particulate and trace pollutant control device, which would be capable of a higher degree of emission reduction, is currently considered for the proposed facilities.
4. The air quality dispersion modeling results show that the proposed emissions from both facilities will comply with the national and Florida AAQS and PSD Class I and II increments. The proposed emissions from each facility produce maximum ground-level concentration that are below the established significant impact and de minimis air quality impact levels for all pollutants, except lead near the vicinity of each facility. For lead, the maximum predicted impact due to each facility slightly exceeds the de minimis air quality level (no significant impact level has been established). However, PSD monitoring is not considered necessary for any pollutants, including lead, because of the existing monitoring stations in Broward County which measure criteria pollutant concentrations and the predicted low concentrations due to each facility.

Because the maximum predicted concentrations for pollutants emitted above the PSD significant

emissions rates are below the AAQS and threshold limits that cause injury to vegetation and soils, the impacts due to each facility are not expected to have a significant impact on vegetation and soils in the PSD Class I and II areas. Also, the emissions from both proposed facilities are highly unlikely to cause adverse visibility impairment in the Everglades National Park.

## REFERENCES

- Auer, A.H. 1978. Correlation of Land Use and Cover with Meteorological Anomalies, *Journal of Applied Meteorology*. pp. 636-643.
- Briggs, G.A. 1971. Some Recent Analyses of Plume Rise Observations. *In: Proceedings of the SEcond International Clean Air Congress*. Academic Press, New York, New York.
- Briggs, G.A. 1975. Flume Rise Prediction. *In: Lectures on Air Pollution and Environmental Impact Analysis*, American Meteorological Society, Boston, Massachusetts.
- Code of Federal Regulations, Title 40, Part 50. 1982. National Primary and Secondary Ambient Air Quality Standards.
- Code of Federal Regulations, Title 40, Part 51. 1982. Requirements for Preparation, Adoption, and Submittal of Implementation Plans.
- Code of Federal Regulations, Title 40, Part 52. 1982. Approval and Promulgation of Implementation Plans.
- Code of Federal Regulations, Title 40, Part 60, Subpart D. Standards of Performance for Fossil Fuel Fired Steam Generators.
- Code of Federal Regulations, Title 40, Part 60, Subpart D(a). Standards of Performance for Electric Utility Steam Generating Units.
- Cramer, H.E. Company, Inc. 1979. Industrial Source Complex (ISC) Dispersion Model User's Guide, Volumes I and II. Prepared for EPA.
- Environmental Research & Technology, Inc. 1981. Technical Support Document for a Prevention of Significant Deterioration (PSD) Permit for a Proposed Resource Recovery Facility in Westchester County, New York.
- Gough, L.P., et al. 1979. Element Concentrations Toxic to Plants, Animals and Man. USGS Bulletin No. 14.
- Holzworth, G.C. 1972. Mixing Heights, Wind Speeds, and Potential for Urban Air Pollution Throughout the Contiguous United States. Publication No. AP-101. EPA, Research Triangle Park, North Carolina.

- Lutz, D. 1981. Personal Communications. EPA, Research Triangle park, North Carolina.
- Malcolm Pirnie, Inc. 1983a. Site Evaluation, Solid Waste Management Program, Southern Full Service Resource Recovery Facility for Broward County, Florida.
- Malcolm Pirnie, Inc. 1983b. Personal Communications from August to December 1983.
- National Academy of Science (NAS). 1971. Fluorides, Committee on Biological Effects of Atmospheric Pollution. Washington, D.C.
- Stahl, Q.R. 1969. Air Pollution Aspects of Mercury and Its Compounds. Litton Systems, Inc., Bethesda, Maryland.
- Thompson, C.R., et al. 1970. Effects of Continuous Exposure of Navel Oranges to NO<sub>2</sub>. Atmospheric Environment, 4:349-355.
- Tingey, D.T., et al. 1971. Vegetation Injury from the Interaction of Nitrogen Oxide and Sulfur Dioxide. Phytopathology, 61:1506-1511.
- Tingey, D.T., et al. 1973. Foliar Injury Responses of 11 Plant Species to Ozone/Sulfur Dioxide Mixtures. Atmospheric Environment, 7:201-208.
- Turner, D.B. 1970. Workbook of Atmospheric Dispersion Estimates. Office of Air Programs Publication No. AP-26. U.S. Environmental Protection Agency, Research Triangle Park, North Carolina.
- U.S. Environmental Protection Agency. 1977. User's Manual for Single Source (CRSTER) Model. EPA-450/2-77-013.
- U.S. Environmental Protection Agency. 1978. Guideline on Air Quality Models. EPA-450/2-78-027.
- U.S. Environmental Protection Agency. 1979. A Review of standards of Performance for New Stationary Sources--Incinerators. Office of Air Quality Planning and Standards, Research Triangle Park, North Carolina. EPA-450/3-79-009.
- U.S. Environmental Protection Agency. 1980. Ambient Air Monitoring Guidelines for Prevention of Significant Deterioration. EPA-450/4-80-12.

APPENDIX D

TYPICAL AIR POLLUTION CONTROL  
SYSTEM DESIGN DETAILS - FOR WASTE  
MANAGEMENT, INC. - BECHTEL  
CIVIL & MINERALS, INC. VENDOR

**Customer:** Bechtel WMI Joint Venture



**Project:** Solid Waste Disposal  
Broward County



**Subject:**

**Description:**

Page 1 of

POLLUTION CONTROL SYSTEM

- 9.0 Description
- 9.1 Scope of Supply
- 9.2 Specification of Areas  
to be Insulated
- 9.3 Erection and Commissioning
- 9.4 Precipitator Data
- 9.5 Scope of Supply

L1B1

VØLUND Project No. 4867

Section:

Corrected on:



**Customer:** Bechtel WMI Joint Venture



**Project:** Solid Waste Disposal  
Broward County



**Subject:**

**Description:**

Page 2 of

9.0

Description

Attached hereto:

Exploded view "Electrostatic Precipitator,  
type F300/WS/CCP"

Pages 0A-D

01A

02A

06A

09A

010A-B

011A-B

012A

013A

016A

017A

019A

F.L. SMIDTH "Electrostatic Precipitator"

FLS Newsfront "FLS Electrostatic Precipitators  
..... for incinerator plants"

L1B2

VØLUND Project No. 4867

Section:

Corrected on:

**Customer:** Bechtel WMI Joint Venture



**Project:** Solid Waste Disposal.  
Broward County



**Subject:**

**Description:**

Page 3 of

9.0.1

General Design

FLS electrostatic precipitator type F is designed for horizontal flow of flue gases. The precipitator casing is an all-welded steel construction made of prefabricated plate sections (1) welded to a rigid frame (2). (The numbers in brackets refer to sketches 9.1 and 9.2).

Depending on the tasks concerned, the precipitator is designed to withstand high temperatures, under-pressure or over-pressure, as well as wind, snow, and earthquake forces.

The precipitator is provided with longitudinal or transverse bottom hoppers (3) or, if desired, with pyramidal hoppers (4). The hoppers may be provided with heating elements (5).

One or more electrically independent fields is arranged in the precipitator casing.

In special cases each field may also be electrically divided into more electrically independent so-called bus sections.

Each precipitator field can be inspected through inspection doors fitted before and after the field (6).

L1B3

VØLUND Project No. 4867

Section:

Corrected on:

**Customer:** Bechtel WMI Joint Venture



**Project:** Solid Waste Disposal  
Broward County



**Subject:**

**Description:**

Page 4 of

Because of the high working temperatures, the precipitator is mounted in a way to ensure minimum stresses on the precipitator casing and support during repeated thermal expansions and contractions.

If a rigid support of concrete or steel is used, the precipitator is placed on roller bearings (7).

An alternative to the use of roller bearings is a pendular support, in which heat expansion is absorbed as angular movement of the individual supporting columns (8).

The precipitator casing is provided with inlet and outlet transition pieces, the design of which varies according to applications (9).

In the inlet and outlet transition pieces gas distribution devices are installed to ensure equal and uniform gas distribution over the cross-section of the precipitator (10).

The precipitator casing inclusive of bottom hoppers and inlet and outlet transition pieces are insulated with mineral wool to avoid harmful condensation which causes corrosion and reduces lifetime. The insulation also prevents uncontrollable heat expansion (11), which may cause dangerous tension in the structure.

L1B4

VØLUND Project No. 4867

Section:

Corrected on:

**Customer:** Bechtel WMI Joint Venture



**Project:** Solid Waste Disposal  
Broward County



**Subject:**

**Description:**

Page 5 of

Each field consists of an earthed collecting system and a high-voltage discharge system. Both systems are provided with independent rapping devices.

The collecting system consists of long, specially designed plate lamellae, "collecting plates" (12), which are suspended from the roof of the precipitator thus forming a number of ducts, each consisting of 5-10 plates, depending on the length of the field. The collecting plates of each row are connected at the lower end by means of rapping bars (13). The distance between the individual rows of plates is called the duct spacing which may vary according to the task.

The discharge system is a framework consisting of two transverse gables (14). Between the gables are arranged frame tubes (15) at several levels through the ducts formed by the collecting plates.

Between the frame tubes discharge electrodes (16) are suspended, the design of which may vary. The discharge system is electrically isolated from the remaining parts of the precipitator being suspended in four insulators (17) placed on top of the precipitator roof. These insulators are placed in insulator boxes (18) to which the high voltage supply for the precipitator is connected.

L1B5

VØLUND Project No. 4867

Section:

**Customer:** Bechtel WMI Joint Venture



**Project:** Solid Waste Disposal  
Broward County



**Subject:**

**Description:**

Page 6 of

The dust accumulated on the collecting plates is dislodged by means of tumbling hammers (19) mounted on a slowly rotating horizontal shaft. The tumbling hammers, the weight and consequently the rapping energy of which vary according to the type of tasks, hit the rapping bars of the collecting plates.

The dust accumulated on the discharge system is also dislodged by means of tumbling hammers (20) hitting an impact beam fixed to the framework of the discharge system.

The rapping gears of the collecting plates and the discharge systems, have drive units (21) which are mounted at the outside of the precipitator casing and consist of geared motors and sealing devices. Between the drive units for the discharge rapping gear and the high voltage rapping gear is mounted a flexible insulator shaft. On the rapping gear shaft for the collecting plates extra tumbling hammers are mounted for rapping the air distribution screens fitted in the inlet and outlet transition pieces of the precipitator. In some cases the air distribution screens may have separate rapping gears or vibrators.

The precipitated dust is removed from the bottom hoppers of the precipitator by means of a drag chain (22), screw conveyor, sluice, etc. according to the type of hopper or application.

L1B6

VØLUND Project No. 4867

Section:

Corrected on:

**Customer:** Bechtel WMI Joint Venture



**Project:** Solid Waste Disposal  
Broward County



**Subject:**

**Description:**

Page 7 of

The electrostatic precipitator is provided with platforms, staircases, and ladders for inspection and maintenance purposes (23).

9.0.2

Precipitator Casing

The primary supporting structure of the precipitator casing consists of a number of portals, so-called frames, two for each field. Each portal consists of roof beam, two columns and a bottom beam, all made of heavy I-iron. The portals and their corner joints are designed to withstand all forces due to the dead load of the precipitator, wind and snow loads, dust in bottom hoppers, under- and overpressure, etc. See sketch 02A.

With this design it is not necessary to use any sort of internal stiffenings as for instance girders, diagonal stays etc. which may give rise to uncontrolled forces during heating and cooling and which may result in deformation and fracture. Finally, internal stiffenings can cause dust build-ups.

Further, the design has the advantage that any corrosion of the thin plates of the precipitator will not influence the safety and stability of the structure.

The supporting portal structure is covered with prefabricated plate sections provided with secondary reinforcing ribs and welded gastight to the portals.

L1B7

VØLUND Project No. 4867

Section:

**Customer:** Bechtel WMI Joint Venture



**Project:** Solid Waste Disposal  
Broward County



**Subject:**

**Description:**

Page 8 of

For extraordinarily wide precipitators the portals will be provided with a centre column made of a thick-walled hollow section steel.

Inspections doors are fitted before and after each field.

9.0.3

Bottom Hopper, Longitudinal

The precipitator has one or more longitudinal bottom hoppers, depending on the width of the precipitator. The hoppers are designed to withstand normal operational and wind loads as well as total filling with dust. See sketch 02A.

Under each field are arranged two partition plates preventing the gases from passing underneath the electrode systems.

The end walls of the bottom hoppers are provided with inspection doors, and there are also doors in the dividing plates allowing passage inside the hoppers.

The lower part of the hoppers are trough-shaped for drag chains or screw conveyor, respectively. In the bottom of the trough it is possible to empty the dust through a special safety door. The hoppers can be supplied with varying angles of inclination.

L1B8

VØLUND Project No. 4867

Section:

Corrected on:

**Customer:** Bechtel WMI Joint Venture



**Project:** Solid Waste Disposal.  
Broward County



**Subject:**

**Description:**

Page 9 of

Depending on the process concerned, the lowest approx. 2 m of the hopper may be provided with thermostatically-controlled heating elements, heating an air gap between the walls of the hopper and the insulation and thus maintaining a temperature of the walls above the desired lower limit.

9.0.4

Inlet and Outlet Transition Piece, Type C

This type of inlet and outlet transition piece is used especially for moderate inlet dust concentrations. The inlet transition piece is normally provided with three subsequent vertical air distribution screens. See sketches 06A and 06B.

The two first screens consist of vertical U-shaped lamellae, between which adjustable horizontal guide and distribution plates are arranged. The design makes it possible, if necessary, to close total areas of the screen entirely and to change the angles of the guide plates. The last screen consists of perforated plates divided into modules and suspended in vertical suspension irons. The arrangement with the three screens makes it possible to obtain an efficient and even distribution of the air stream over the cross-section of the precipitator, which is of vital importance for the efficiency of the precipitator.

L1B9

VØLUND Project No. 4867

Section:



**Customer:** Bechtel WMI Joint Venture



**Project:** Solid Waste Disposal  
Broward County



**Subject:**

**Description:**

Page 10 of

The outlet transition piece is provided with one screen of the same adjustable design as the first two inlet transition pieces.

The vertical screens are normally rapped by means of extra tumbling hammers mounted on the rapping gear shafts for the collecting plates for the first and last field. In special cases with very sticky dust, separate rapping gears are installed for the inlet screens in the form of tumbling hammers or vibrators.

9.0.5

Collecting System

The collecting electrode system consists of long, specially designed plate lamellae, called collecting plates. See sketch 09A.

The plates form a number of rows, each consisting of 5-10 plates, depending on the length of the field.

Each plate is eccentrically suspended from supporting irons welded on to the roof beams of the precipitator casing.

At the bottom each plate passes through the rapping bar and rests against traverses welded on to the rapping bar.

L1B10

VØLUND Project No.

4867

Section:

**Customer:** Bechtel WMI Joint Venture



**Project:** Solid Waste Disposal.  
Broward County



**Subject:**

**Description:**

Page 1 of 1

Because of the eccentric suspension and as each plate hangs vertically, there is good contact between rapping bar and collecting plate, which ensures an efficient transmission of the rapping effect from the collecting plate rapping gear to each individual collecting plate.

If the collecting plates exceed a certain length the plates forming a row are flexibly interconnected, which prevents the plates from oscillating or twisting.

The collecting plate profile is designed with a view to obtaining maximum stiffness simultaneously with a minimum risk of flash-over and with a view to obtaining maximum level of acceleration.

Between the walls of the precipitator casing and the outermost rows of plates before and after each field, flexible, efficient guard plates are fitted to prevent the gases from passing outside the field without being cleaned.

To prevent passage of gases over and under the fields, partition plates are installed.

L1B11

VØLUND Project No. 4867

Section:

Corrected on:

**Customer:** Bechtel WMI Joint Venture



**Project:** Solid Waste Disposal  
Broward County

**Subject:**

**Description:**

Page 12 of

9.0.6

Collecting System, Rapping Gear

The rapping bars for the collecting plates are made of heavy flat bars. Between the flat bars specially shaped cross members are inserted, one for each collecting plate. At the impact end of the rapping bars a specially shaped hardened impact anvil is fixed. See sketch 010A.

The rapping bars are supported by a bearing bridge and a rapping bar guide, respectively, and there are no fixed connections between the collecting plates and the rapping bars. The level of the rapping bars can be adjusted in the supports.

The collecting plates are inserted in the rapping bars, and because of the eccentric suspension of the collecting plates, each plate will press against the specially shaped cross members of the rapping bars, thus resulting in efficient contact for transmission of impact energy. Individual heat expansion of the collecting plates is allowed by the clearance between rapping bars and collecting plates, without vertical movement of the rapping bars. As the rapping bars do not move vertically, irrespective of the varying temperatures in the precipitator, the tumbling hammers accurately hit a precalculated point on the bars, thus obtaining uniform transmission of maximum impact energy.

L1B12

VØLUND Project No. 4867

Section:

**Customer:** Bechtel WMI Joint Venture



**Project:** Solid Waste Disposal  
Broward County



**Subject:**

**Description:**

Page 13 of

The tumbling hammers, the weights of which depend on the height of the collecting plates, are made of drop-forged hardened steel to prevent forging at the impact point.

Because of the "fixed" position of the rapping bars, and as the tumbling hammers hit a precalculated point, it is ensured that no reactions occur in the centre of rotation of the hammers, this reducing wear to a minimum.

The total patented rapping mechanism ensures maximum rapping efficiency of the collecting plates as well as ensuring long life of the various components.

The tumbling hammers are mounted on a shaft, so that each hammer is turned approx. 30° in relation to the preceding hammer, so that only a few hammers hit at the same time.

The turning interval of the hammer shafts are controlled by a timer unit which may be set from 5 to 24 r/h, depending on the field in question.

The shafts, which are equipped with necessary expansion couplings, rotate in heavy cast iron bearings. Shaft with bearings are mounted in the "bearing bridge", which also serves as a gangway.

L1B13

VØLUND Project No. 4867

Section:

Corrected on:

**Customer:** Bechtel WMI Joint Venture



**Project:** Solid Waste Disposal  
Broward County

**Subject:**

**Description:**

Page 14 of

The bearing bridge which is made of heavy L-sectional iron, form a very rigid unit, which through laminated springs are suspended in the side walls of the precipitator. This design prevents damage to the rapping mechanism in case of deformations of the precipitator casings as for instance buckling due to heat or explosions.

9.0.7

Discharge System, Incl. of Insulator Chambers

Each discharge electrode system consists of transverse upper and lower supporting beams as well as - depending on the height of the precipitator - of one or more intermediate beams, all connected with vertical stay beams forming a gable for the discharge electrode system. Between two gables the discharge electrode system framework tubes are bolted on in one or more layers, depending on the height of the precipitator. See sketch 011A.

The framework tubes are placed in the ducts formed by the collecting plates and discharge electrodes are suspended between the individual tubes. The total height of the discharge electrode system is less than the height of the collecting plates, which means that no discharge electrode passes the upper or lower edge of a collecting plate with the consequent great risk of frequent high voltage flashovers and spark erosion of the electrode.

L1B14

**Customer:** Bechtel WMI Joint Venture

**Project:** Solid Waste Disposal  
Broward County



**Subject:**

**Description:**

Page 15 of

The helical discharge electrodes are made of an absolutely smooth cold-drawn stainless steel wire, dia. 2.7 mm, and are supplied as coils. During the erection these coils are stretched and erected by means of special tools to ensure uniform, mechanical tension of each single electrode.

At the ends of the electrode there is a thick-walled reinforced hook, which together with the special clamps welded on to the framework form a flexible link to prevent electrode fractures due to fatigue.

The helical discharge electrode has further the following advantages:

- 1) Because of the helical shape, the discharge electrodes are self-tightening, which means that they can withstand the electric field strengths and remain in the centres of the flue gas ducts, thus securing the highest possible operating voltage.
- 2) The helical shape of the discharge electrodes results in a large number of evenly distributed points, from which the corona discharges take place.
- 3) The tensile force of the discharge electrodes obviates the necessity to use any sort of weights to keep the electrodes taut.

L1B15

VØLUND Project No. 4867

Section:

**Customer:** Bechtel WMI Joint Venture



**Project:** Solid Waste Disposal.  
Broward County

**Subject:**

**Description:**

Page<sup>16</sup> of

- 4) The tensile force of the discharge electrodes re-sults in good transmission of the rapping effect from the discharge electrode rapping gear which again re-sults in cleaner electrodes.

Each discharge electrode system is suspended from the roof of the casing through four cylindrical supporting insulators. The supporting insulators are mounted on special flanges and with specials gaskets compensating for different coefficients of expansions of steel and the insulating material, which might otherwise cause breakage of the insulators. See sketch 011B.

The supporting insulators are provided with a top cover making it possible to clean the insulators without having to enter the precipitator. The connection between supporting insulators and discharge electrodes system is flexible so that no lateral forces are exerted on the insulators.

To facilitate replacement of the supporting insulators, a set of lifting tools is supplied, whereby it is possible to carry out replacement work without having to enter the precipitator.

L1B16

VØLUND Project No. 4867

Section:

Corrected on:

**Customer:** Bechtel WMI Joint Venture



**Project:** Solid Waste Disposal  
Broward County

**Subject:**

**Description:**

Page 17 of

All the supporting insulators are placed in the insulator chambers, which are heatinsulated and provided with a heating element for each insulator, as well as a thermostat to control the temperature in order to avoid condensation on and inside the insulators.

9.0.8

Discharge System, Rapping Gear

Depending on the height of the precipitator the discharge system is rapped at several levels.

The discharge framework tubes at the level in question is fixed to a transverse sectional iron impact beam, which distributes the impact energy of the tumbling hammers evenly over the width of the precipitator. See sketch 011A.

The tumbling hammers are made of drop-forged hardened steel and the impact point of the hammer is curved, which together with the position of the curvature ensures that no reactions occur in the centre of rotation of the hammers, thereby reducing the wear to a minimum.

The shaft on which the tumbling hammers are mounted is equipped with the necessary expansion couplings and rotates in heavy cast iron bearings.

L1B17



**Customer:** Bechtel WMI Joint Venture



**Project:** Solid Waste Disposal.  
Broward County

**Subject:**

**Description:**

Page<sup>18</sup> of

The rapping gear shaft is driven by a driving mechanism placed outside on the precipitator casing. Between the driving mechanism and the rapping gear shaft an insulator shaft is inserted, designed in such a way no axial forces occur, which might cause misalignment of the discharge system. The special couplings of the insulator shaft are made with a view to obtaining maximum flexibility in both radial and axial directions. See sketch 012A.

9.0.9

Drive Unit for Rapping Gears

The rapping gear shafts for collecting plates and discharge systems are powered by drive units fitted on the outside of the precipitator casing. Where the shafts pass through the precipitator wall, special maintenance-free slide ring seals are fitted to prevent entrance of false air into the precipitator under all conditions. The seal consists of an adjustable cast iron bearing against which a slide ring is pressed by stainless steel bellows, which means that the whole sealing arrangement is self-adjusting. See sketch 013A.

The drive unit is mounted in an heat-insulated box which is provided with inspection doors.

L1B18

VØLUND Project No. 4867

Section:

Corrected on:

**Customer:** Bechtel WMI Joint Venture



**Project:** Solid Waste Disposal  
Broward County



**Subject:**

**Description:**

Page 19 of

The drive unit, which is weather-protected, has a geared motor to drive the rapping gear shaft through a chain drive with take-up device. The chain drive has the effect that the impact from the hammer shaft is not transmitted to the gear with the consequent risk of damaging same.

9.0.10

Pendular Support

In certain situations it may be advantageous to use a pendular support. This support is a combination of vertical columns and cross diagonals, both made of square tube profiles to be welded together during erection. The heat expansion of the precipitator is absorbed in the individual columns by their angular movement in relation to the points of support on the foundations. One of the columns is fixed with cross diagonals in several directions, and the other columns move radially from this column, some of them being, however, provided with cross diagonals in one direction because of wind and possible earthquake forces. At the top and bottom each column has a semispherical journal which partly centralizes the loads from the precipitator and partly prevents the occurrence of undesired bending moments in the columns. See sketch 016A.

L1B19

VØLUND Project No. 4867

Section:

Corrected on:

**Customer:** Bechtel WMI Joint Venture



**Project:** Solid Waste Disposal  
Broward County



**Subject:**

**Description:**

Page 20 of

Unlike the precipitator itself, the support is considered as a building, and if nothing else is agreed upon, the calculations is made according to DIN standards.

9.0.11

Insulation

An important factor for the function and life of the precipitator is efficient heat-insulation. To avoid condensation with consequent corrosion and reduced lifetime as well as to avoid uncontrolled heat expansion and deformation, the total surface of the precipitator is to be insulated carefully with mineral wool from 100 to 200 mm thick. The insulation is to be covered, taking into account the heat expansion of the precipitator, with corrugated aluminium plates, if this is considered suitable. The columns of the precipitator are to be equipped with "thermal jackets" to ensure uniform temperatures at the inside and outside flanges of the columns. See sketch 017A.

The roof of the precipitator is to be insulated with tread-resistant stiff batts, to be built up with a slope of approx. 20 or in certain cases with plane normal insulation where the chequer plate covering is then supported by a sectional steel. The covering of the roof insulation is to be made with 3 mm thick steel chequer plates resting direct on the tread-resistant insulation.

L1B20

VØLUND Project No. 4867

Section:

**Customer:** Bechtel WMI Joint Venture



**Project:** Solid Waste Disposal,  
Broward County



**Subject:**

**Description:**

Page 21 of

Because of the thermal expansion of the precipitator, the plate covering is to be fastened flexibly to the roof of the precipitator. The tread-resistant and water-tight roof covering is normally to be equipped with gutters and chutes.

9.0.12

Stair Tower and Gangways

The precipitator is to be provided with the necessary access facilities for inspection and maintenance purposes.

From the level of the foundation a stair tower is to reach up to the roof of the precipitator. The stair tower should give access to gangways placed at the inspection doors and driving mechanisms for the rapping gears of the collecting system as well as to possible gangways at the rapping gears of the discharge systems. The gangways are to be mounted all the way along the precipitator. From the top of the stair tower there should be access to the tread-resistant insulation covering of the precipitator roof. Gangways and platforms are to be made of sectional steel and grating, and like the precipitator roof they are to be equipped with railing made of tubes.

If stair tower and gangways are included in the supply from FLS, they may be made according to any standard, but if no standard is specified, they will be made according to DIN or FLS standards.

L1B21

**Customer:** Bechtel WMI Joint Venture



**Project:** Solid Waste Disposal  
Broward County

**Subject:**

**Description:**

Page 22 of

9.1

Scope of Supply

7 F.L. Smidth electrostatic precipitator, type F300/H3S/3x30-72100/C/C/L1SA, with fans and ducts, each with the following elements:

	<u>Quantity</u>
External support frames	6
Casing with secondary stiffeners	1
Roofs	1
<u>Pendular supporting structure,</u> leaving 2.5 m below bottom hoppers, assuming top level of concrete is <u>0.5 m</u> above ground level	1 set
Inlets with flange, central	1
Distribution screens in each inlet, fixed	1
Distribution screens in each inlet, adjustable	2
Outlets with flange, central	1
Distribution screens in each outlet, fixed	1

L1B22

**Customer:** Bechtel WMI Joint Venture



**Project:** Solid Waste Disposal  
Broward County



**Subject:**

**Description:**

Page 23 of

	<u>Quantity</u>
Longitudinal hoppers with heating elements and flange	1
Screw conveyor, Ø 315 mm, with air sluice and common geared motor, for installation in bottom hopper	1
Collecting systems	3
Rapping systems for collecting systems, incl. geared motors	3
Discharge systems, rigid frame with spiral shaped electrodes	3
Rapping systems for discharge systems, with geared motors	3
Alumina supporting insulators for discharge systems	12
Insulator boxes for support insulators, with heating elements	8
T/R sets, silicon oil-immersed self-cooled type with automatic control system, with oil pan	3
Inspection doors, casing	4
Inspection doors, bottom hopper	1

L1B23

VØLUND Project No. 4867

Section:

Corrected on:

**Customer:** Bechtel WMI Joint Venture



**Project:** Solid Waste Disposal  
Broward County



**Subject:**

**Description:**

Page 24 of

	<u>Quantity</u>
Staircase from 2.5 m below bottom hoppers	4 for 7 chambers
Gangway at inspection door level	4 for 7 chambers
Railing for roof	1 set
Platform with ladder for bottom hopper outlet inspection door	1
Key interlocking system.	
Grounding cables	1 set
Switchboards for T/R sets. The boards contain thyristor controllers for T/R sets with instruments and signal lamps, fuses and start-stop switches. The boards are foreseen for remote control and separate power supply	3
Switchboard for heating elements and rapper drives. The board contains programmer for intermittent function of rapper drives, contactors with motor control centers, signal lamps, fuses, and start-stop switches. The board is foreseen for remote control and separate power supply	1

L1B24

**Customer:** Bechtel WMI Joint Venture



**Project:** Solid Waste Disposal.  
Broward County



**Subject:**

**Description:**

Page 25 of

Only parts not to be insulated are primed at delivery.

L1B25

VØLUND Project No. 4867

Section:

Corrected on:



**Customer:** Bechtel WMI Joint Venture



**Project:** Solid Waste Disposal.  
Broward County



**Subject:**

**Description:**

Page <sup>26</sup> of

9.2

Specifications of Areas to be Insulated (by others)

For each line:

Inlet duct: Approx. 110 sq.m

Esp casing excl. roof: Approx. 750 sq.m

Inlet: Approx. 100 sq.m

Outlet: Approx. 90 sq.m

Bottom hopper: Approx. 400 sq.m

Outlet duct (ESP - ID fan): Approx. 180 sq.m

Outlet duct (ID fan - stack): Approx. 200 sq.m

ID fan: Approx. 60 sq.m

Esp roof: Approx. 160 sq.m

Esp roof to be insulated with min. 2 x 50 mm stiff mineral wool blocks, covered with min. 3 mm steel plate, inclining 2 degr. from the middle of each casing towards the sides.

Esp frames to be insulated with 2 x 100 mm mineral wool, covered with min. 0.7 mm aluminum or galvanized steel plate.

L1B26

**Customer:** Bechtel WMI Joint Venture



**Project:** Solid Waste Disposal,  
Broward County



**Subject:**

**Description:**

Page 27 of

Ducts, casing, hoppers to be insulated with 2 x 50 mm mineral wool, covered with min. 0.7 mm aluminum or galvanized steel plate.

Bottom hopper area is also to be covered with 1 mm steel plate for the lowest 2 m, forming the heating zone, by the insulating company, before normal insulation.

Gutters and downsprouts for water and T/R sets drainage pans to be supplied by the insulating company.

L1B27

VØLUND Project No. 4867

Section:

Corrected on:

**Customer:** Bechtel WMI Joint Venture



**Project:** Solid Waste Disposal.  
Broward County



28  
Page of

**Subject:**

**Description:**

9.3

Erection (by others) and Commissioning

It is an assumption for our performance guarantee that the precipitators are erected and commissioned under supervision by one of our trained precipitator specialists. The services of these are offered under conditions as attached hereto.

9.4

Precipitator Data

Each precipitator, type F300/H3S/3x30-72100/C/C/L1SA, is dimensioned for the following data:

Gas temperature 200 degr.C

Amount of gas 120,015 Ncu.m/h

Casing design temperature 288 degr.C

Gas pressure -150 mm WG

Casing design pressure -305 mm WG

Plate in casing, hoppers,  
inlet and outlet 5 mm

Wind load 296 kp/sq.m

L1B28

VØLUND Project No. 4867

Section:

Corrected on:

**Customer:** Bechtel WMI Joint Venture



**Project:** Solid Waste Disposal  
Broward County



**Subject:**

**Description:**

Page 29 of

Live load on roof,  
platforms, etc. 200 kp/sq.m

Snow load 125 kp/sq.m

Other data:

Number of chambers 1

Number of bus  
sections in each field 1

Number of fields 3

Total number of sections 3

Effective height of  
each section 10.0 m

Effective length  
of each section 3.0 m

Effective width  
of each section 7.2 m

Total gas flow at 100% MCR 57.8 cu.m/s

Gas velocity 0.80 m/s

Retention time in  
electrical field 11.2 s

L1B29

VØLUND Project No. 4867

Section:

Corrected on:

**Customer:** Bechtel WMI Joint Venture



**Project:** Solid Waste Disposal,  
Broward County



**Subject:**

**Description:**

Page 30 of

Collecting system

Collecting plate, FLS type H, rolled steel.

Height 10.0 m

Length 0.5 m

Plate thickness 1.5 mm

Channel width 300 mm

Number of collecting plates per section 150

Total projected collecting area 4320 sq.m

Total collecting area 5616 sq.m

Number of collecting rapping systems per field 1

Type Tumbling hammer

Acceleration level 200 G

Discharge system

Type of discharge system Rigid frame

L1B30

**Customer:** Bechtel WMI Joint Venture



**Project:** Solid Waste Disposal.  
Broward County



Subject:	Description:
	Type of discharge electrode FLS spiral shaped
	Material of construction SIS 2343
	Material thickness 2.7 mm dia.
	Electrode length: 3.3 m
	Number of electrode layers 3
	Number of discharge electrodes per section 864
	Distance between discharge and collecting electrodes 150 mm
	Distance between discharge electrodes (lengthwise) 180/320 mm
	Number of discharge rapper layers per section 2 (common drive motor)
	Type Tumbling hammer
	Supporting insulators per section 4
	Material for construction Alumina
	Effect of heating element 1 kW

L1B31

**Customer:** Bechtel WMI Joint Venture



**Project:** Solid Waste Disposal  
Broward County



**Subject:**

**Description:**

Page 32 of

Temperature in  
insulator chambers 90 degr.C

Bottom hoppers

Total number 1

Type Longitudinal

Heating effect, each hopper 15 x 2 kW

Volume in each hopper 384 cu.m

T/R sets

Number 3

Type 80/600

Nominal voltage (peak) 80 kV

Nominal current (average) 600 mA

Projected collecting  
area per T/R set 1440 sq.m

Specific collecting  
area current 0.42 mA/sq.m

Installed effect,  
each T/R set 48 kVA

L1B32

VØLUND Project No. 4867

Section:

Corrected on:

**Customer:** Bechtel WMI Joint Venture



**Project:** Solid Waste Disposal.  
Broward County



**Subject:**

**Description:**

Page 33 of

Installed effect

Heating of insulator  
boxes (intermittent) 12 kW

Bottom hopper heating  
(intermittent) 30 kW

Geared motors for rapper  
drives (intermittent) 1 kW

T/R sets 144 kVA

Power requirements under  
normal and stable running  
conditions, at max. de-  
dusting efficiency 53 kW (T/R sets) +  
22 kW (heating)

For your information, filled-in data sheets  
from your inquiry are enclosed.

L1B33

VØLUND Project No. 4867

Section:

Corrected on:



**Customer:**

Bechtel WMI Joint Venture

**Vølund** 

**Project:**

Solid Waste Disposal  
Broward County

**FLS**

**Subject:**

**Description:**

Page 34 of

9.5

Scope of Supply

- 7 Electrostatic precipitators
- 7 Support steel
- 7 Electrical controls
- 7 Flyash hoppers and outlet rotary valve.

Interface Equipment Termination Points:

- Foundation bolts (concrete foundation by others to be 0.5 m above ground)
- In- and outlet fluegas hoppers including flexible connections
- Outlet flyash rotary feeder
- Power connection for control boards and remote control connections.

L1B34

VØLUND Project No.

Section:

Corrected on:

4867

ELECTROSTATIC PRECIPITATOR TYPE F  
PRECIPITATOR CASING

F. L. SMITH & Co.

SKETCH

01A

F-8870-1

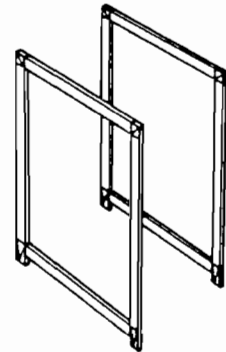
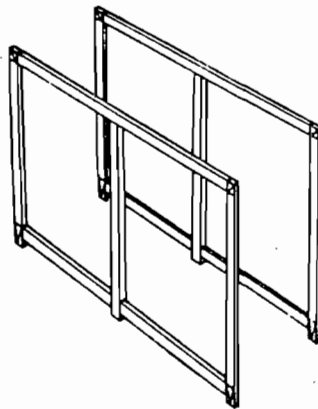
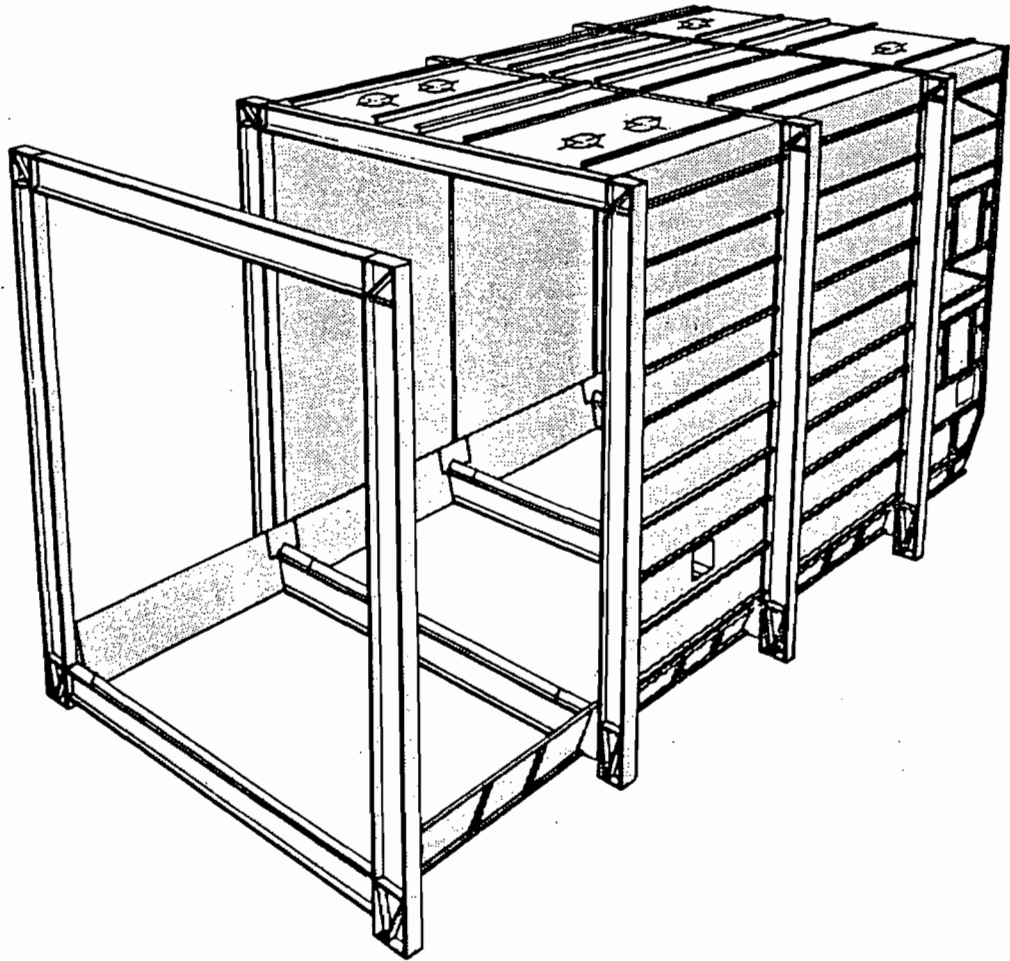

ELECTROSTATIC PRECIPITATOR TYPE F  
BOTTOM HOPPER, LONGITUDINAL

F. L. SMIDTH & CO.

SKETCH

02A

F-6670-1

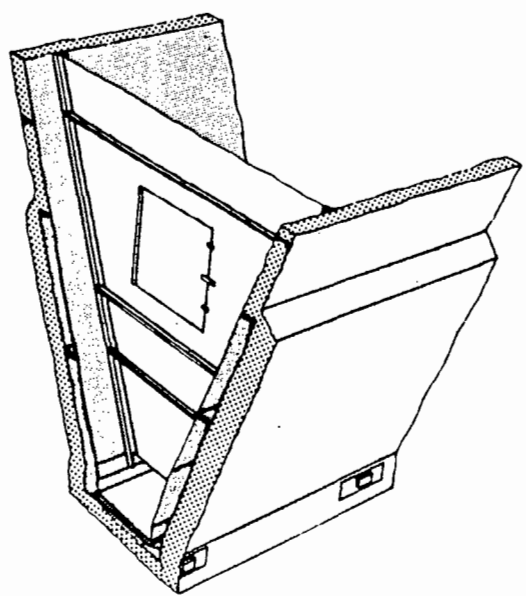
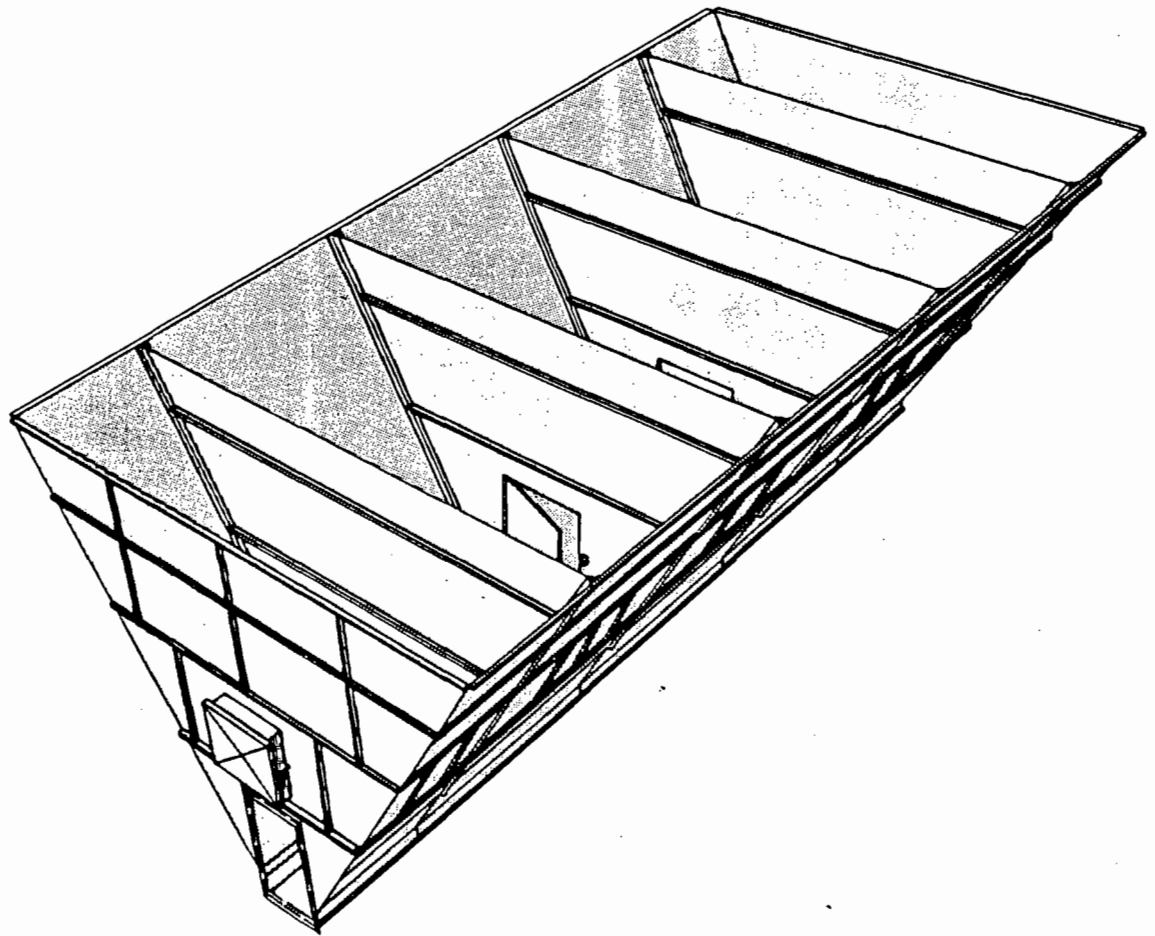

F-8870-1

ELECTROSTATIC PRECIPITATOR TYPE F.  
INLET TRANSITION PIECE, TYPE C, INCLUSIVE  
OF GAS DISTRIBUTION SCREEN

F. L. SMIDTH & CO.  
SKETCH 06A

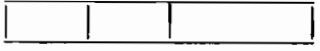
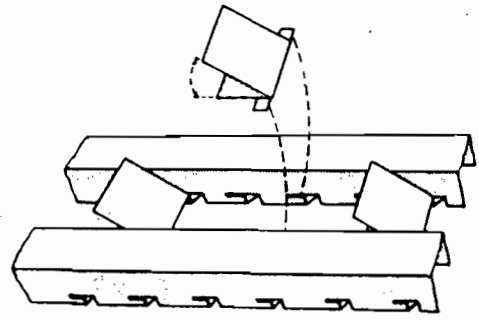
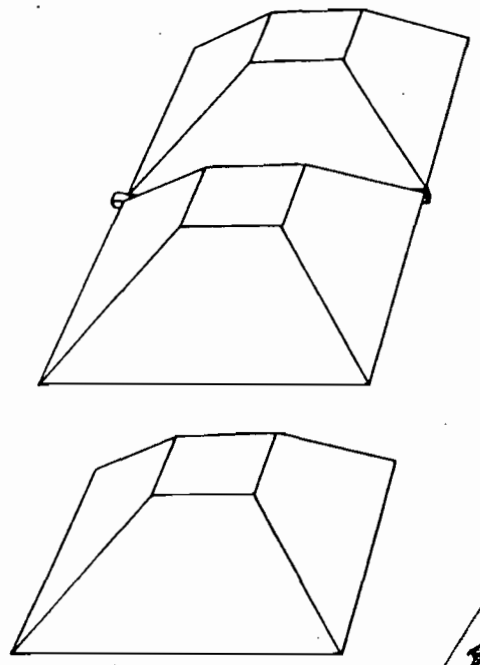
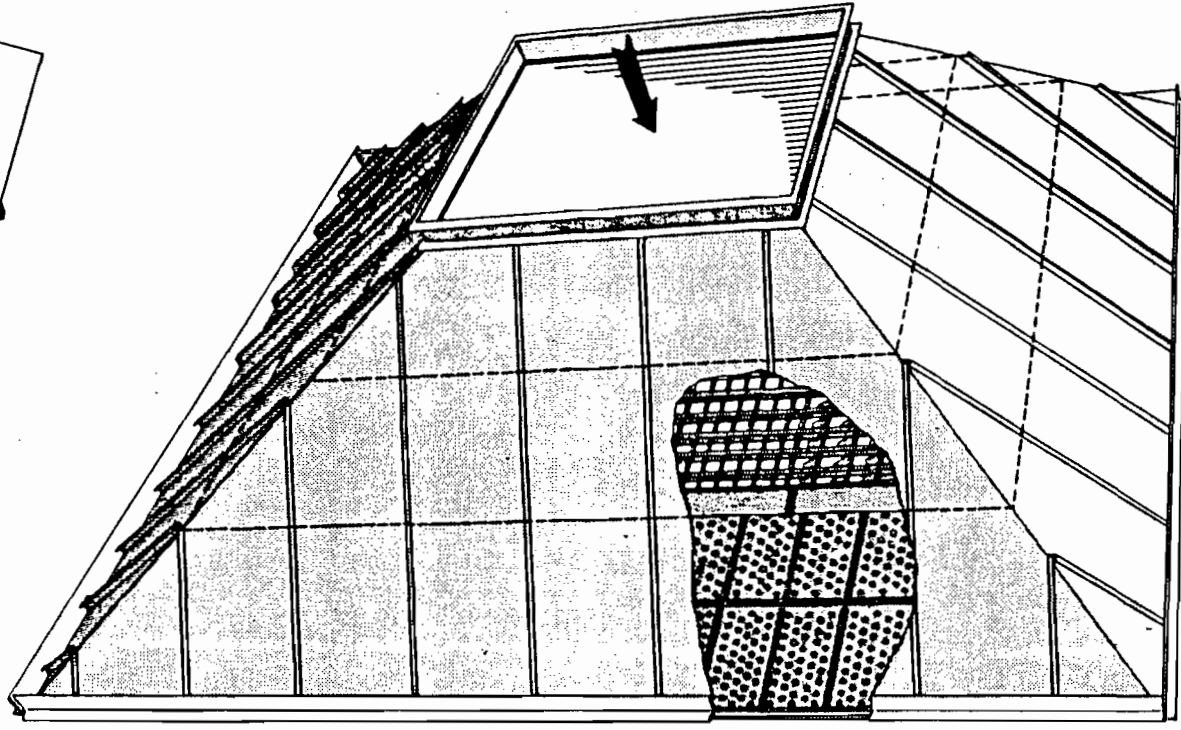

F. L. SMIDTH & CO.

SKETCH

06B

ELECTROSTATIC PRECIPITATOR TYPE F.  
OUTLET TRANSITION PIECE, TYPE C, INCLUSIVE  
OF GAS DISTRIBUTION SCREEN

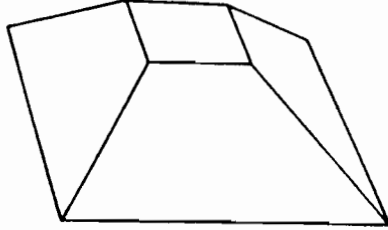
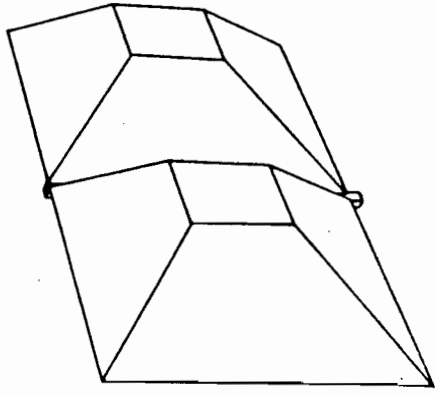
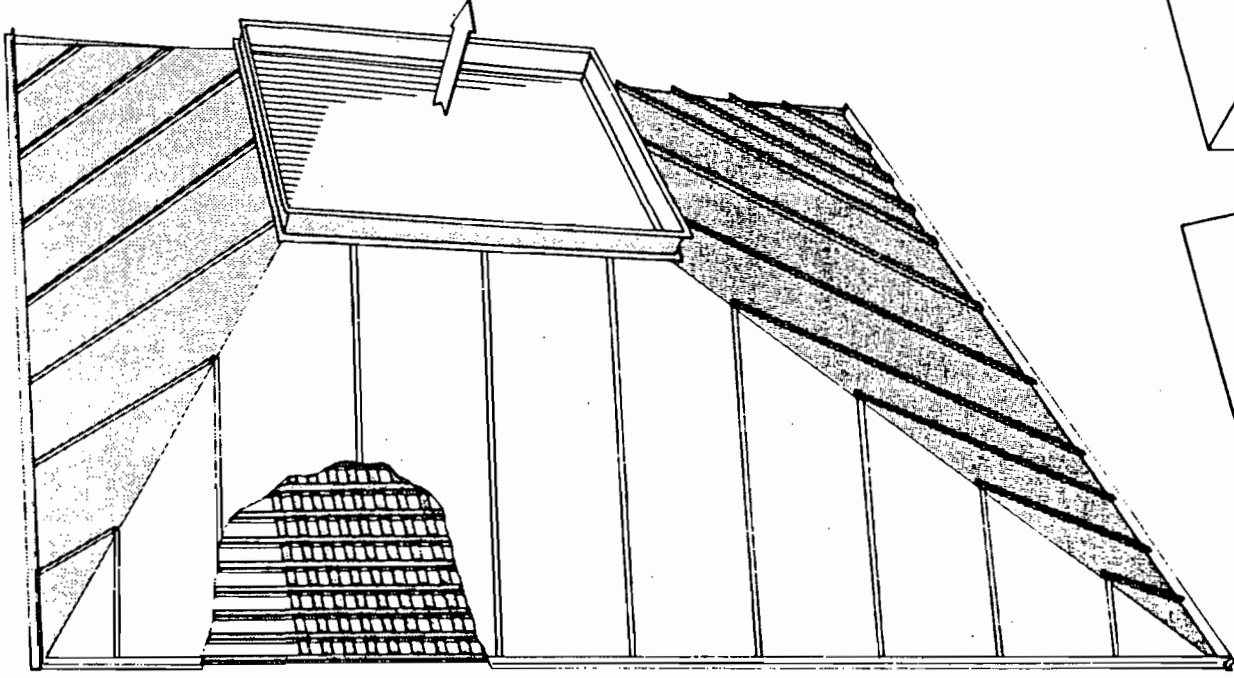

F-6870-1

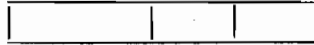

ELECTROSTATIC PRECIPITATOR TYPE F  
COLLECTING SYSTEM

F. L. SMIDTH & Co.

SKETCH

09A

F-8870-1

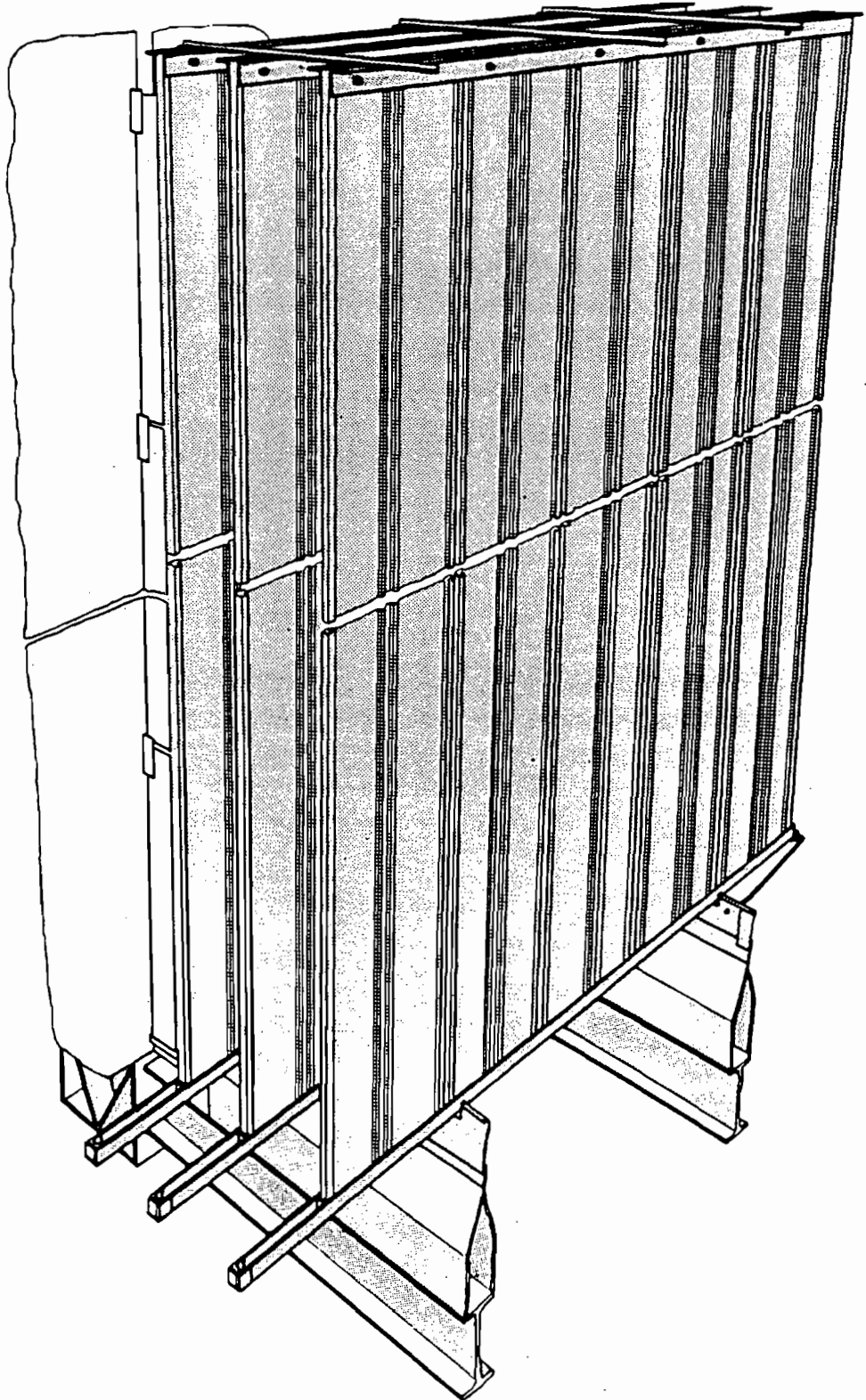

ELECTROSTATIC PRECIPITATOR TYPE F  
COLLECTING SYSTEM, RAPPING GEAR

F. L. SMITH & CO.

SKETCH

010A

F-6670-1

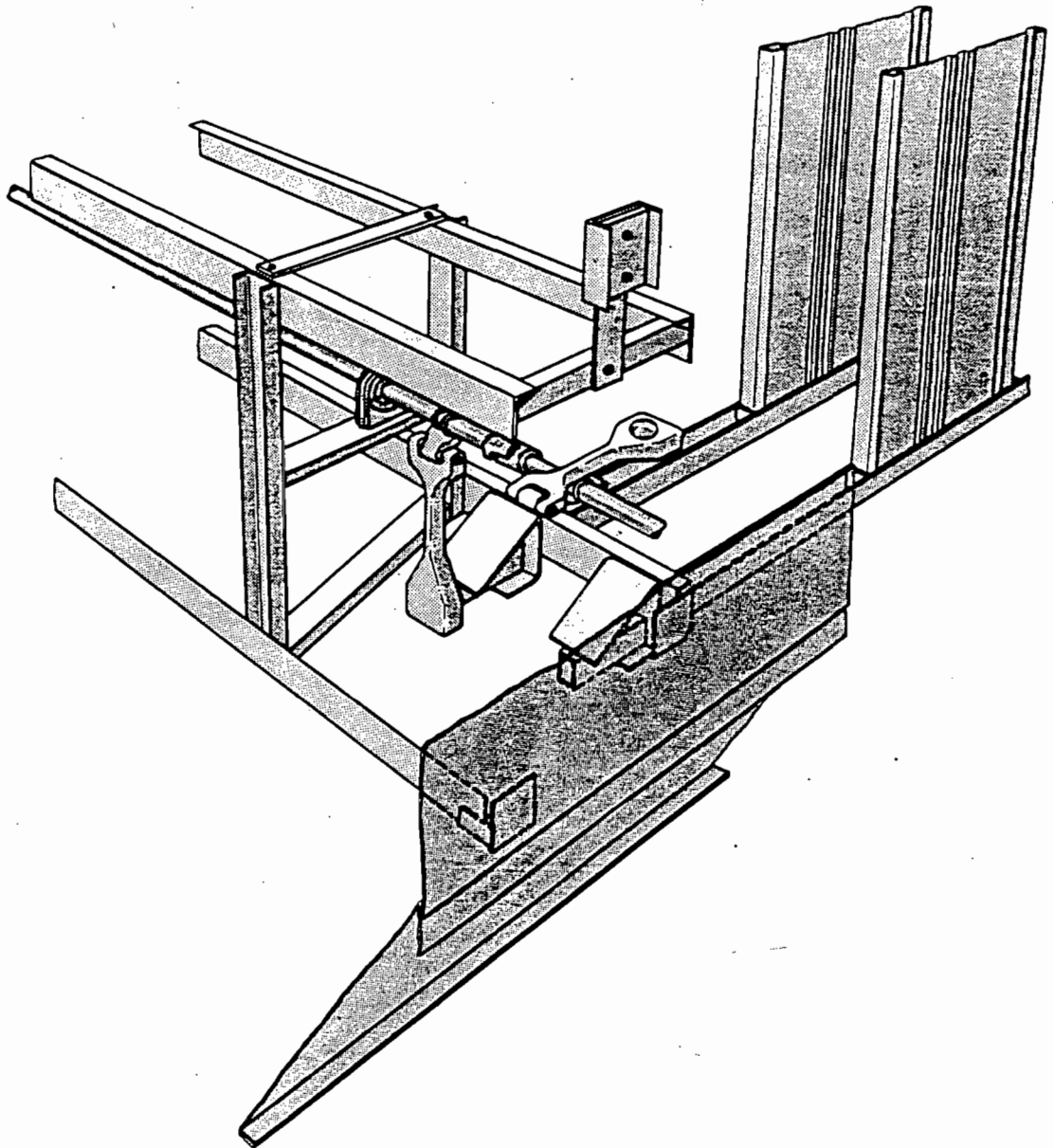

ELECTROSTATIC PRECIPITATOR TYPE F  
DISCHARGE SYSTEM, INCL. OF INSULATOR CHAMBERS

F. L. SMITH & Co.

SKETCH

011A

F-8870-1

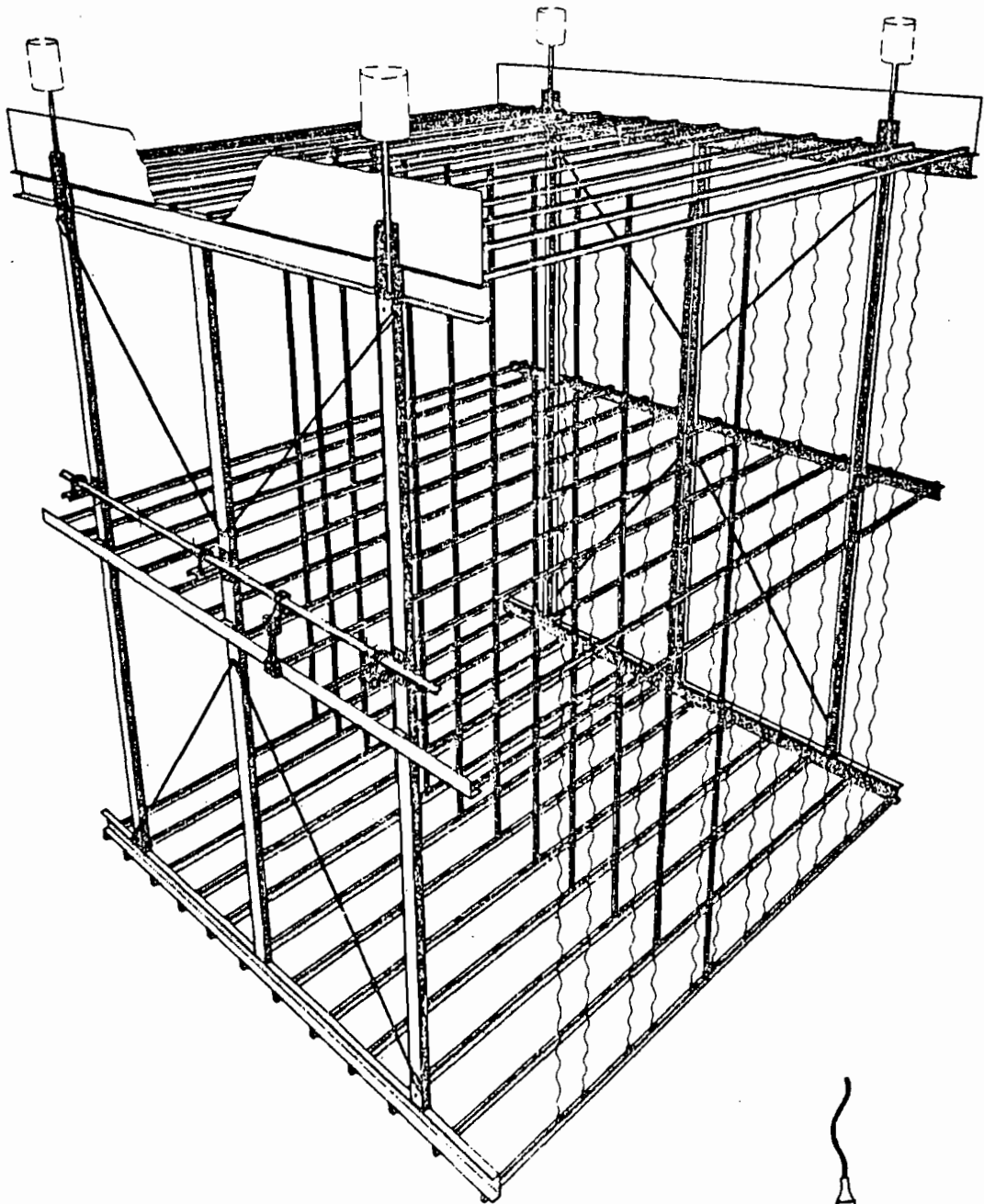

EMS 307

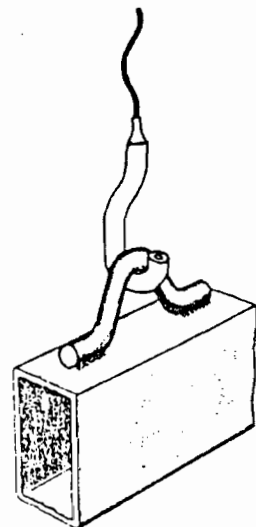



ELECTROSTATIC PRECIPITATOR TYPE F  
DISCHARGE SYSTEM, INCL. OF INSULATOR CHAMBERS

F. L. SMITH & CO.

SKETCH

011B

F-8870-1

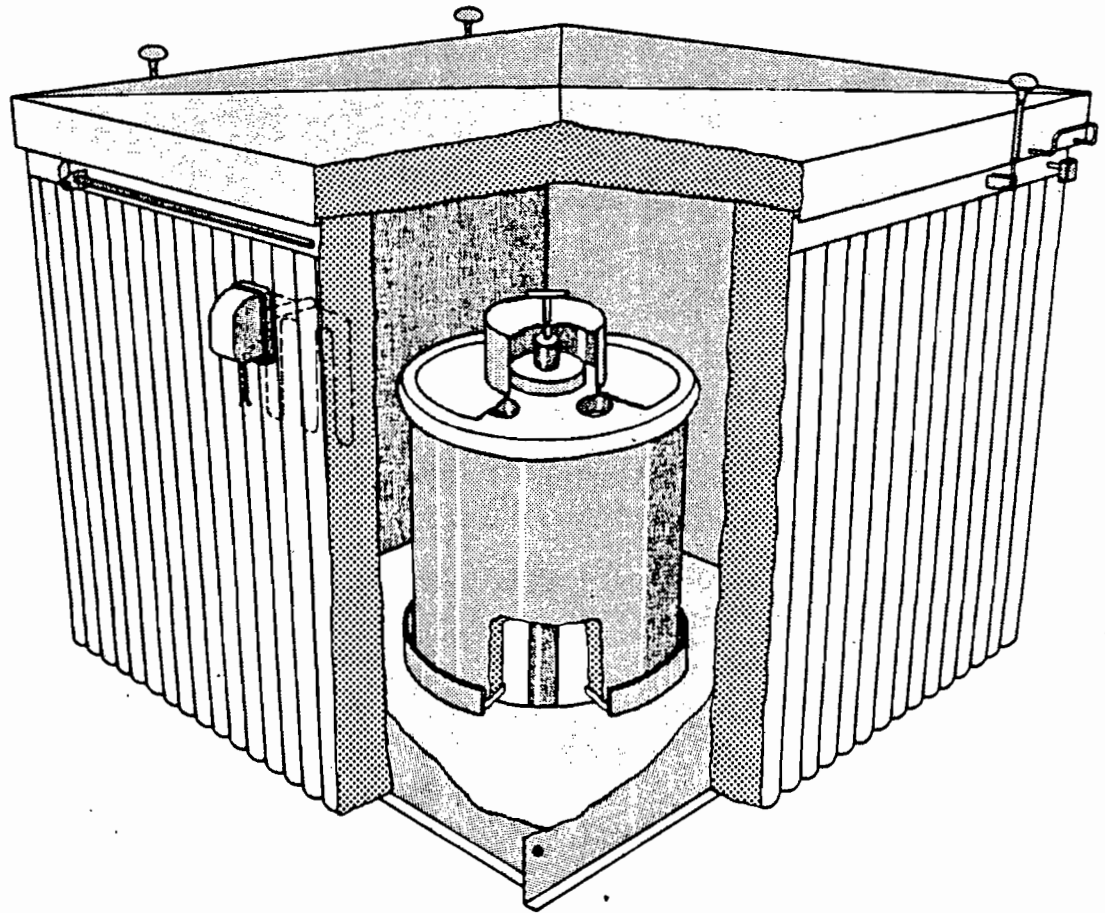

ELECTROSTATIC PRECIPITATOR TYPE F  
DISCHARGE SYSTEM, RAPPING GEAR

F. L. SMIDTH & Co.  
SKETCH D12A

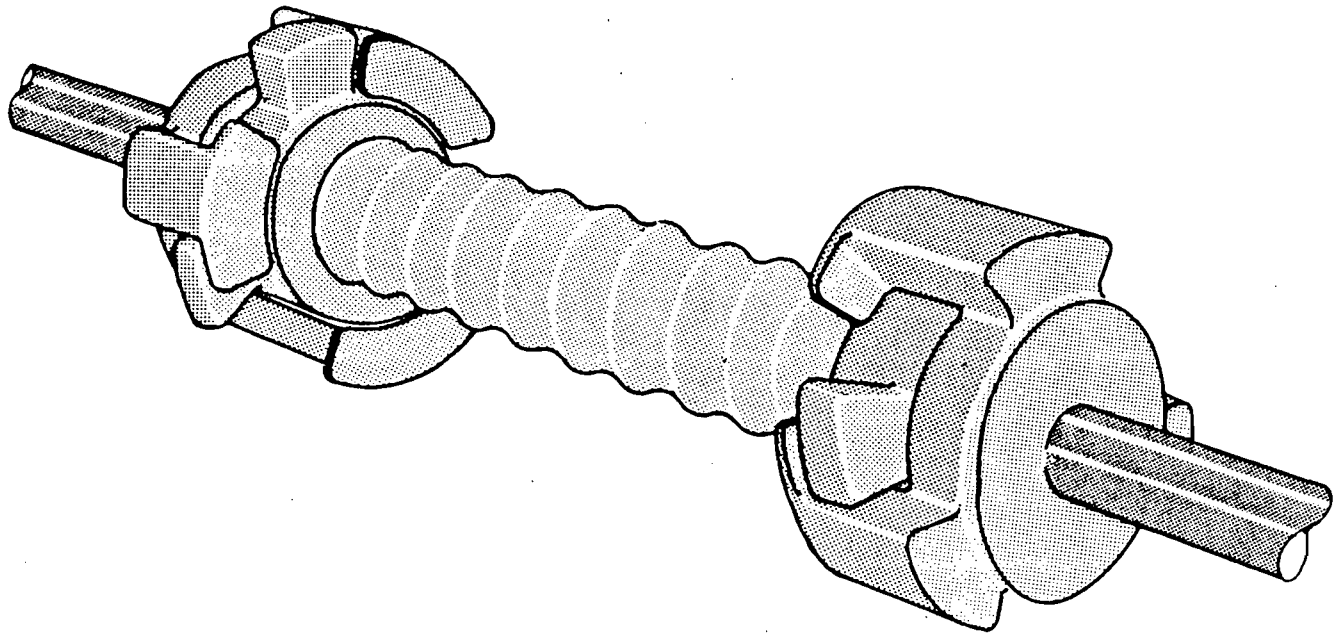

F-8870-1

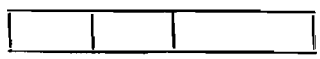

ELECTROSTATIC PRECIPITATOR TYPE F  
DRIVING MECHANISM FOR RAPPING GEARS

F. L. SMITH & CO.

SKETCH

013A

F-8870-1:

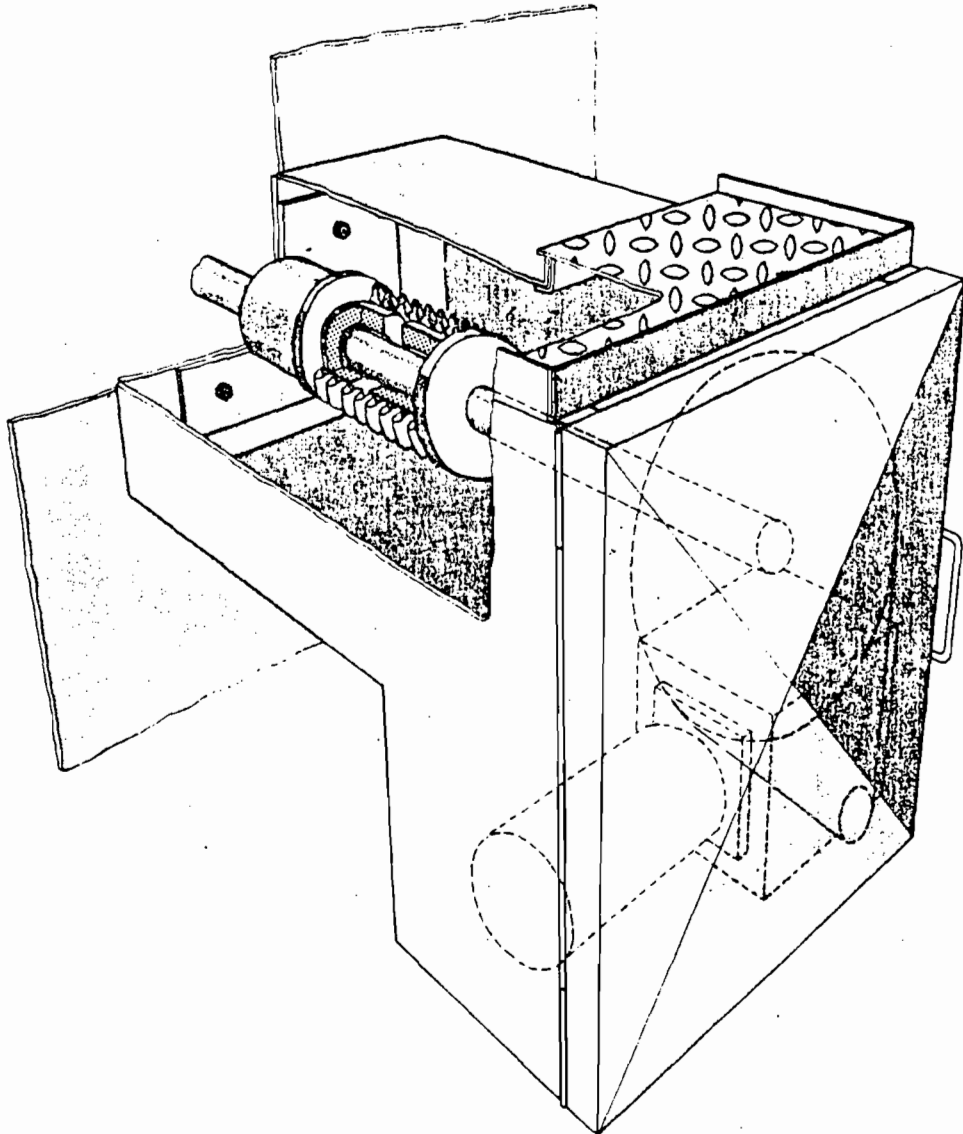

EHD 307

ELECTROSTATIC PRECIPITATOR TYPE F  
STAIR TOWER AND GANGWAYS

F. L. SMITH & Co.

SKETCH

D19A

F-6870-1

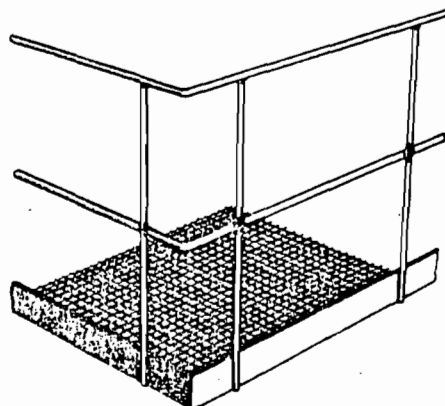
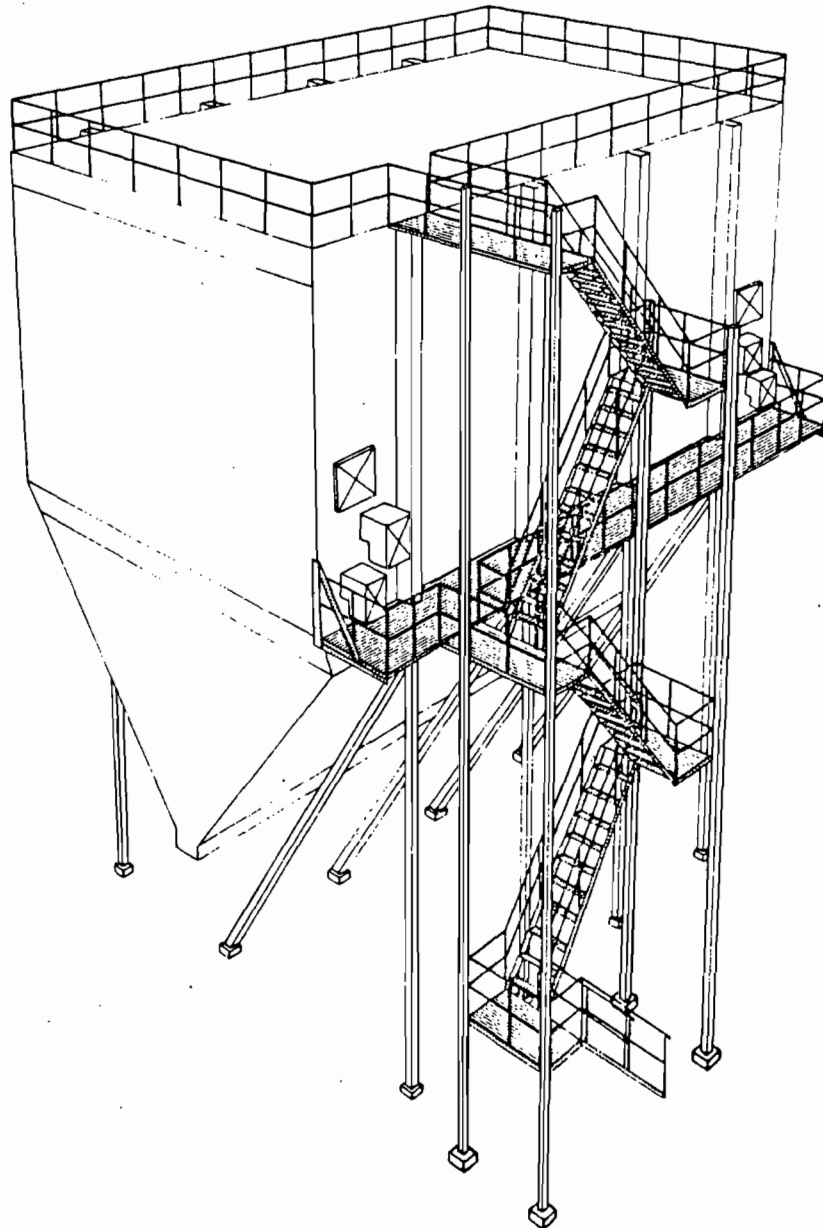

ELECTROSTATIC PRECIPITATOR TYPE F  
INSULATION

F. L. SMITH & Co.

SKETCH

017A

F-6870-1

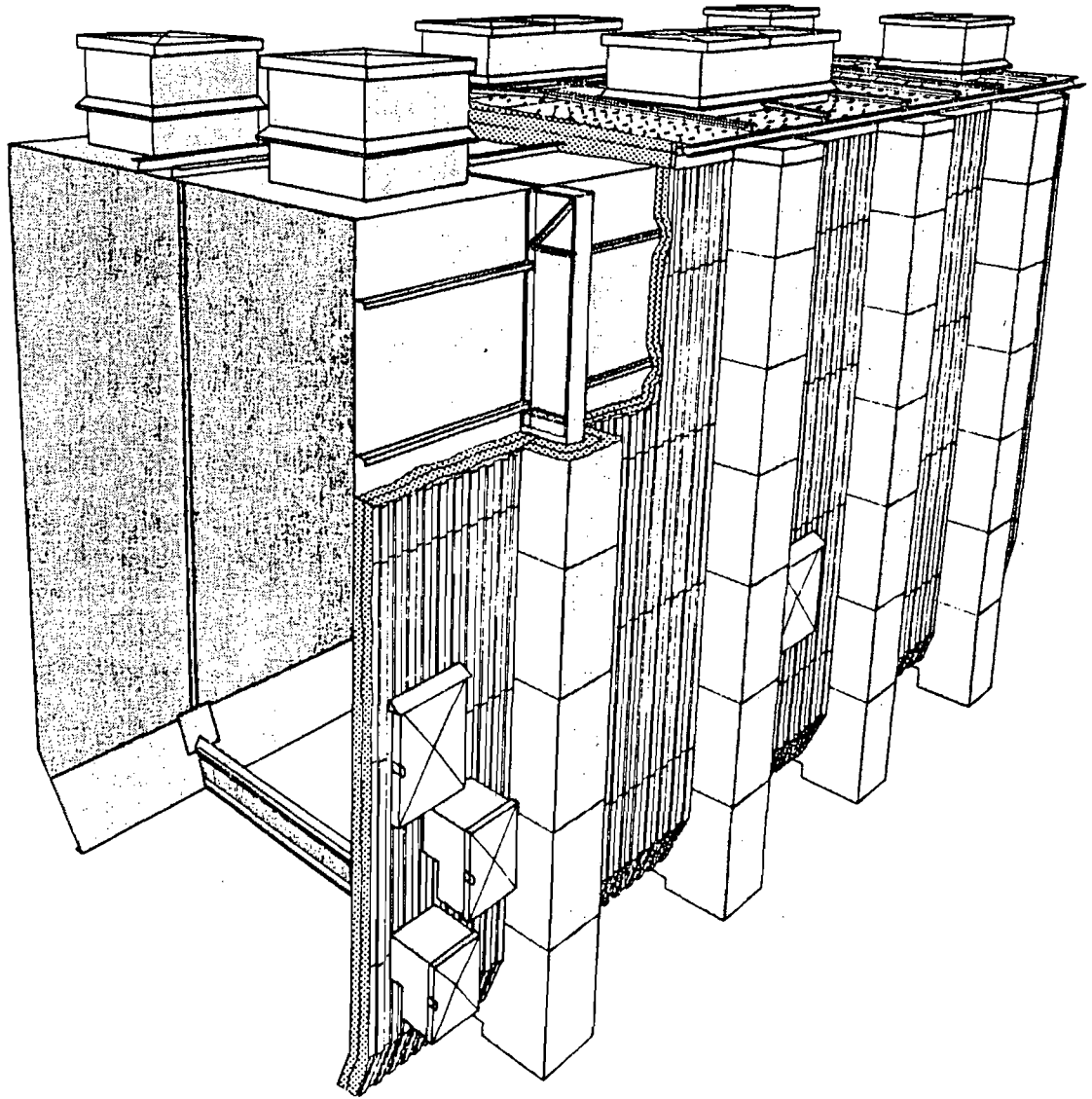

EMB 307

ELECTROSTATIC PRECIPITATOR TYPE F  
PENDULAR SUPPORT

F. L. SMITH & Co.

SKETCH

016A

F-8870-1

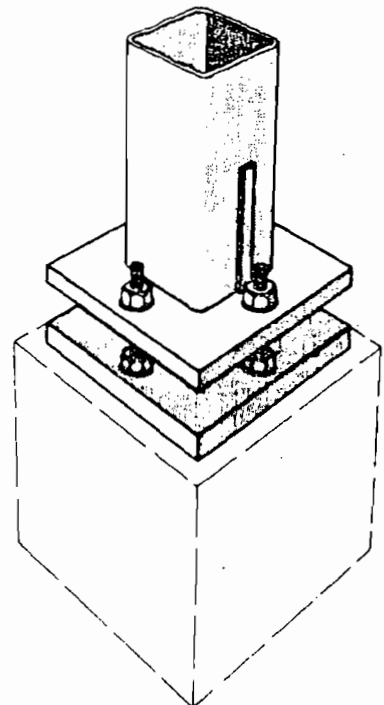
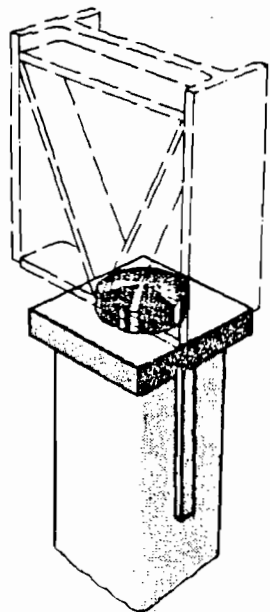
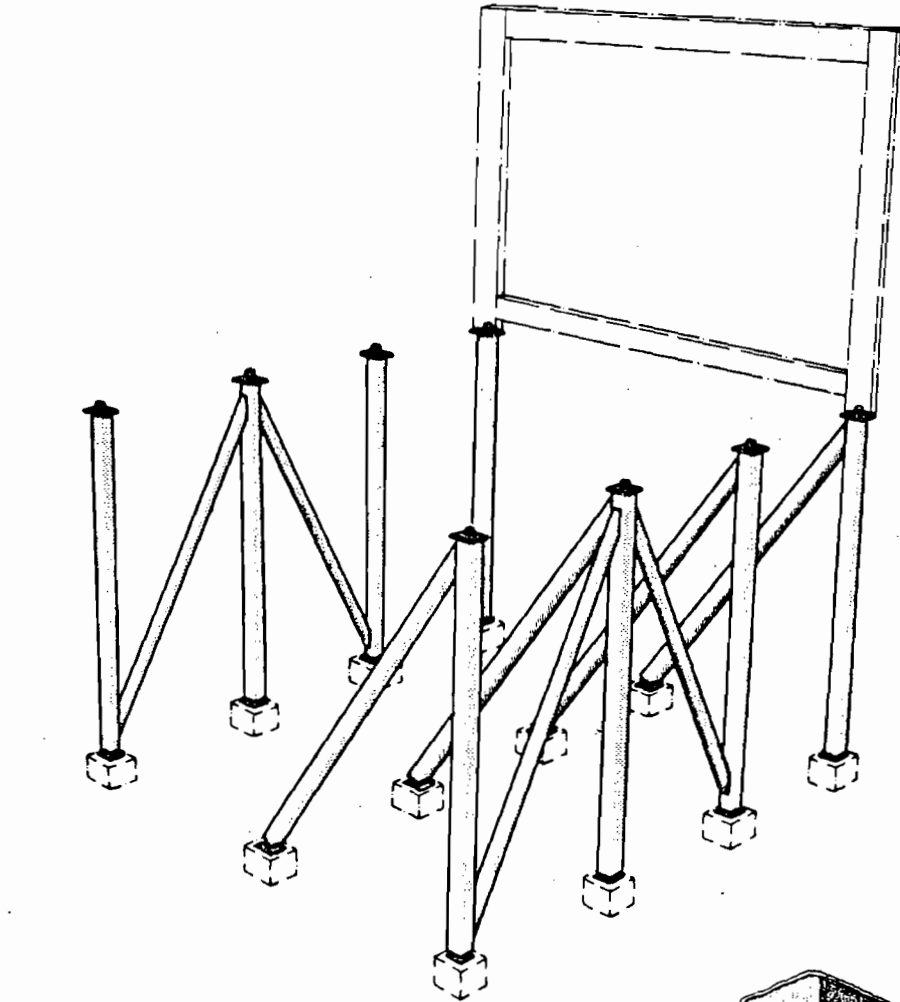

EMB 307

APPENDIX E

STATE OF FLORIDA

DEPARTMENT OF ENVIRONMENTAL REGULATION

TWIN TOWERS OFFICE BUILDING  
2600 BLAIR STONE ROAD  
TALLAHASSEE, FLORIDA 32301-8241

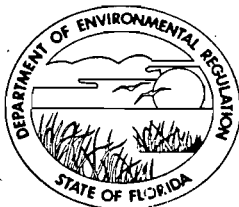

BOB GRAHAM  
GOVERNOR

VICTORIA J. TSCHINKEL  
SECRETARY

November 9, 1983

Mr. Ronald J. Mills  
Malcolm Pirnie, Inc.  
2 Corporate Park Dr.  
Box 751  
White Plains, New York 10602

Re: Broward County, Florida, Resource Recovery Project

Dear Mr. Mills:

We have reviewed the draft Air Quality Analysis report prepared by Environmental Science and Engineering, Inc., your subconsultant on the subject project. The atmospheric dispersion modeling completed for this report shows that for all air pollutants subject to PSD review the predicted maximum ground-level ambient concentrations are less than the de minimus levels that trigger the requirement of preconstruction monitoring. Based on the information contained in this draft report and subject to a more thorough review of the final application package, including the actual modeling output, we can conclude that preconstruction ambient air quality monitoring will not be necessary for any of the air pollutants emitted from this project.

In reviewing your draft report we have compared the emission factors you have used with those of similar operations and with some of the literature on the subject. We believe that the emission factors you have used for VOC's and CO may be low. Since the area in which the sources will be built is a nonattainment area for ozone, an increase in the emission factor for VOC's may trigger nonattainment review. A change in the CO emission factor will not affect the review of this pollutant. If you do change your emission factor for VOC's, check it against the applicability for nonattainment review and submit any additional required information if necessary.

In general, the modeling methodology used in the report is appropriate for PSD review. In the final report, however, be sure to include all parts of the complete PSD review including a BACT analysis, an air quality analysis, an additional impacts analysis, and a GEP stack height determination.



Mr. Ronald J. Mills  
Page Two  
November 9, 1983

If you have any questions about either the PSD or nonattainment review process please call Tom Rogers on modeling issues or Willard Hanks on the emission factor issues at (904)488-1344.

Sincerely

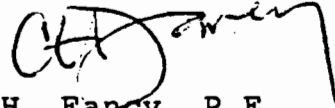

C. H. Fancy, P.E.  
Deputy Chief  
Bureau of Air Quality  
Management

CHF/TR/s

cc: Tom Tittle  
Bill Stone, Broward County  
Phyllis A. Korab, Broward County

APPENDIX F  
WASTE COMPOSITION AND TYPE

APPENDIX F  
DESCRIPTION OF WASTE

Processable Waste is that portion of the County's waste stream which is processable in a mass burn resource recovery system. Processable Waste shall include but not be limited to all forms of garbage, commercial waste, rubbish, leaves and brush, paper and cardboard, plastics, wood and lumber, rags, carpeting, a limited amount of tires, wood furniture, mattresses, stumps, wood pallets, timber, tree limbs, ties, and logs, and minor amounts of pathological and biological wastes stream), but excluding hazardous wastes, liquid wastes, pathological and biological wastes, sludges, sewage, bulk shipments of majure, explosives, chemicals, radioactive materials, and Unprocessable Wastes.

WASTE COMPOSITION AND TYPE

Based on a weighing and sampling program conducted at the County Landfill in Davie, during April 1983, the following data was compiled on garbage and trash:

PHYSICAL COMPOSITION - GARBAGE AND PROCESSABLE TRASH FRACTIONS  
(As Received Basis)

<u>Component</u>	<u>Percent by Weight</u>		
	<u>Garbage</u>	<u>Trash</u>	<u>Combined</u>
Paper, Cardboard	47	11	36
Plastics	9	3	7
Rubber, Tires	-	9	3
Textiles, Rags, Carpeting and Mattresses	2	1	2
Food Wastes	9	-	6
Garden Wastes, Stumps, Leaves and Brush	17	36	22
Wood	3	35	13
Glass	7	-	5
Metals	6	-	4
Rock, Brick	-	-	-
Other	-	5	8
	<u>100</u>	<u>100</u>	<u>106.77</u>

PROXIMATE ANALYSIS (PERCENT BY WEIGHT)

	<u>As Received Basis</u>		<u>Dry Basis</u>	
	<u>Min.</u>	<u>Max.</u>	<u>Min.</u>	<u>Max.</u>
Moisture	19.27	52.21	0.00	0.00
Volatile	NDP	NDP	48.20	82.39
Ash	NDP	NDP	9.75	36.00
Fixed Carbon	NDP	NDP	1.06	20.40
Higher Heating Value (btu/lb)	3,645	6,504	6,454	8,875

NDP - No Data Provided

**FLORIDA DEPARTMENT OF ENVIRONMENTAL REGULATION**

**APPLICATION TO OPERATE / CONSTRUCT AIR  
POLLUTION SOURCES**

**DER**

FEB 24 1984

**BAQM**

**SOUTHERN RESOURCE RECOVERY FACILITY**

**BROWARD COUNTY, FLORIDA**



**FEBRUARY 1984**

**MALCOLM  
PIRNIE**

**ENVIRONMENTAL ENGINEERS, SCIENTISTS & PLANNERS**

in association with Hazen & Sawyer, P.C. and William F. Cosulich Associates, P.C.

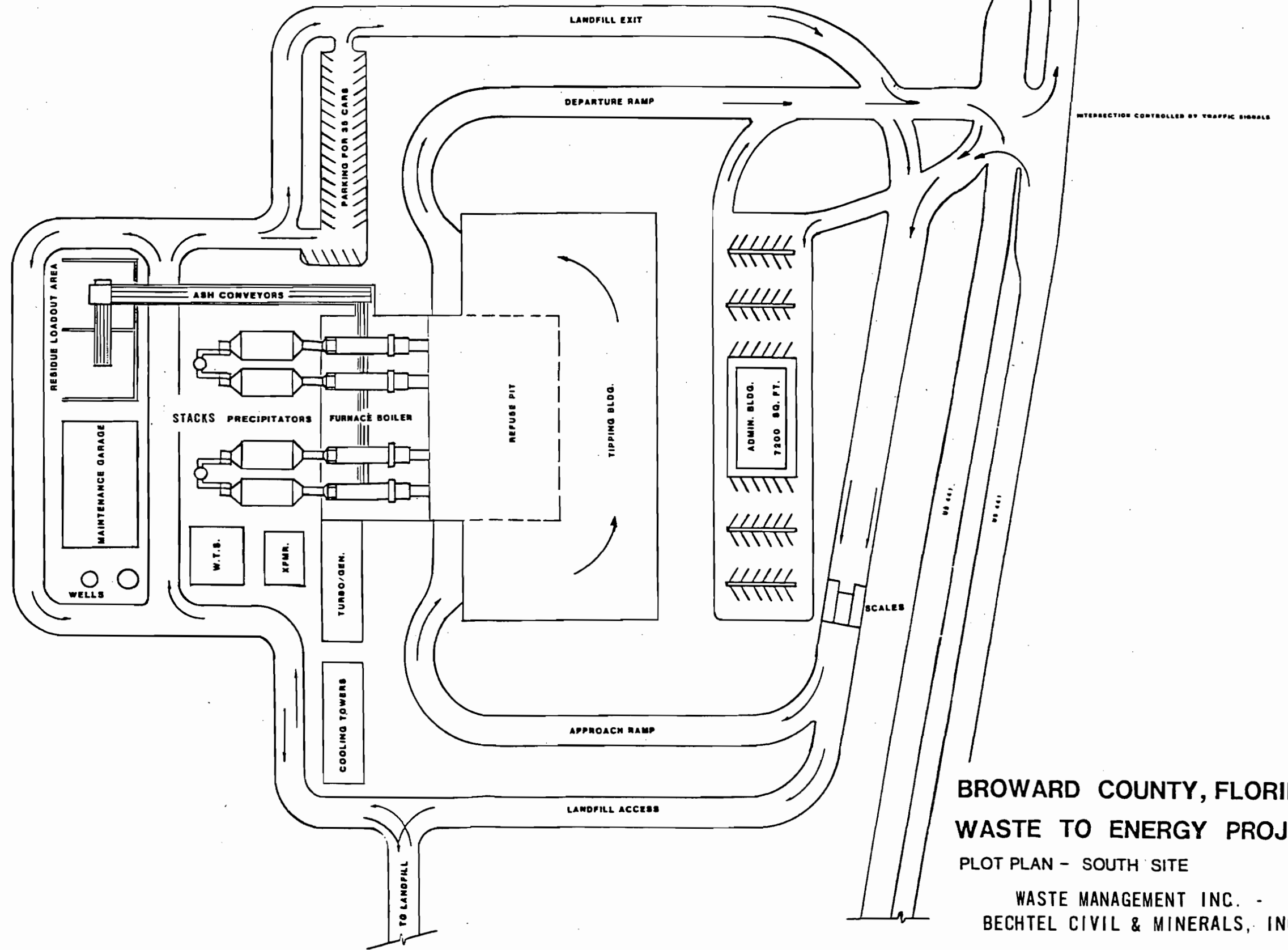
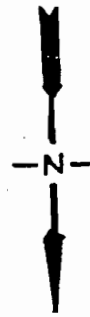

**BROWARD COUNTY, FLORIDA  
 WASTE TO ENERGY PROJECT  
 PLOT PLAN - SOUTH SITE**

WASTE MANAGEMENT INC. -  
 BECHTEL CIVIL & MINERALS, INC.

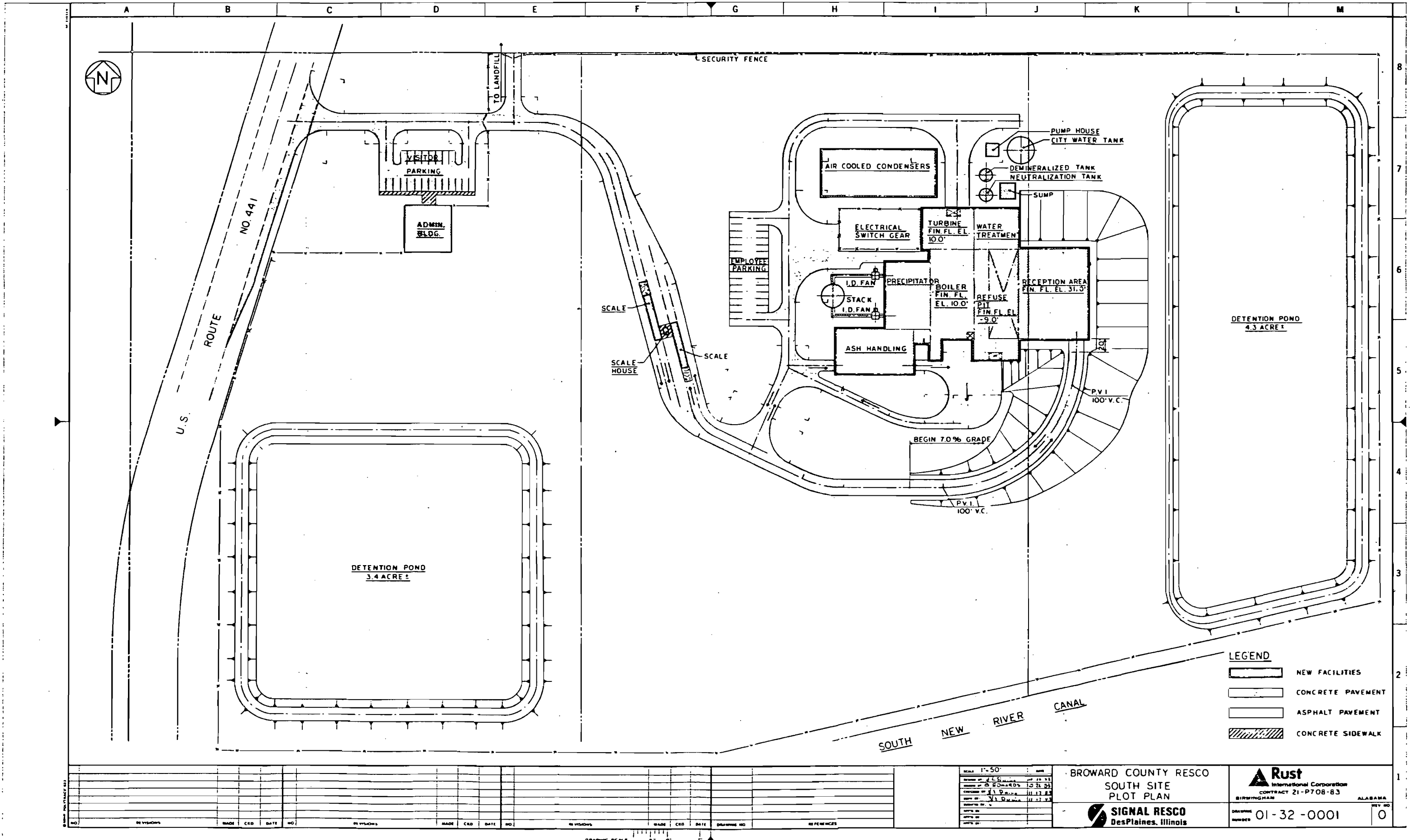

NO.	REVISIONS	DATE	NO.	REVISIONS	DATE	NO.	REVISIONS	DATE	NO.	REVISIONS	DATE	NO.

SCALE	1"=50'
DATE	12-21-83
BY	J. P. ...
CHECKED	J. P. ...
APPROVED	J. P. ...
DATE	12-21-83
BY	J. P. ...
CHECKED	J. P. ...
APPROVED	J. P. ...
DATE	12-21-83
BY	J. P. ...
CHECKED	J. P. ...
APPROVED	J. P. ...
DATE	12-21-83

BROWARD COUNTY RESCO  
 SOUTH SITE  
 PLOT PLAN

**SIGNAL RESCO**  
 DesPlaines, Illinois

- LEGEND**
- NEW FACILITIES
  - CONCRETE PAVEMENT
  - ASPHALT PAVEMENT
  - CONCRETE SIDEWALK

**Rust**  
 International Corporation  
 CONTRACT 21-P708-83  
 BIRMINGHAM ALABAMA

DRAWING NUMBER 01-32-0001  
 REV. NO. 0

Fold at line over top of envelope to the

Is your RETURN ADDRESS completed on the reverse side?

**SENDER:**

- Complete items 1 and/or 2 for additional services.
- Complete items 3, and 4a & b.
- Print your name and address on the reverse of this form so that we can return this card to you.
- Attach this form to the front of the mailpiece, or on the back if space does not permit.
- Write "Return Receipt Requested" on the mailpiece below the article number.
- The Return Receipt will show to whom the article was delivered and the date delivered.

I also wish to receive the following services (for an extra fee):

- Addressee's Address
- Restricted Delivery

Consult postmaster for fee.

3. Article Addressed to:  
 Chuck Folles  
 Wheelabrator Env. Sys  
 4400 S. State Rd 7  
 Ft. Lauderdale, FL  
 33314

4a. Article Number  
 Z 127 633 193

4b. Service Type

<input type="checkbox"/> Registered	<input type="checkbox"/> Insured
<input checked="" type="checkbox"/> Certified	<input type="checkbox"/> COD
<input type="checkbox"/> Express Mail	<input type="checkbox"/> Return Receipt for Merchandise

7. Date of Delivery  
 3/27

5. Signature (Addressee)  
 C. Hopsen

8. Addressee's Address (Only if requested and fee is paid)

6. Signature (Agent)  
 JA

PS Form 3811, December 1991 ★U.S. GPO: 1993-352-714 **DOMESTIC RETURN RECEIPT**

Thank you for using Return Receipt Service.

Z 127 633 193



**Receipt for Certified Mail**  
 No Insurance Coverage Provided  
 Do not use for International Mail  
 (See Reverse)

Sent to	Chuck Folles
Street and No.	Wheelabrator Env.
P.O. State and ZIP Code	Ft. Lauderdale, FL 33314
Postage	\$ 5.50
Certified Fee	\$
Special Delivery Fee	
Restricted Delivery Fee	
Return Receipt Showing to Whom & Date Delivered	
Return Receipt Showing to Whom, Date, and Addressee's Address	
TOTAL Postage & Fees	\$
Postmark or Date	PSD-FI-105 3-25-96 PA-86-21

PS Form 3800, March 1993

✓  
 copied