



January 31, 2014

Mr. David McNeal  
USEPA, Region 4  
Sam Nunn Federal Center  
61 Forsyth Street, SW  
Atlanta, Georgia USA 30303-3104

**Subject: NOx Analyzer Re-certification – Putnam Plant Unit 2-2 (ORIS code 006246)**

Dear Mr. McNeal:

In compliance with the Acid Rain Continuous Emission Monitoring Program (40 CFR Part 75.63), Florida Power & Light Company (FPL) is submitting the Continuous Emissions Monitoring System Re-certification Application for the NOx analyzer replacement on Putnam Unit 2-2. In order to continue to ensure CEMS data integrity and analyzer availability, FPL is currently replacing CEMS NOx and O2 analyzers on thirty-eight units throughout the State.

Putnam Unit 2-2 NOx analyzer, serial number 42C 77258-385 was removed from service on November 21, 2013 and replaced by serial number 1324258460. Re-certification test period requirements and data validation, which includes a probationary calibration error test, in accordance with 40 CFR Part 75.20(b)(3)(ii) were performed to initiate a conditional valid data period.

The re-certification of the NOx System was performed in accordance with 40 CFR Part 75, Appendix A during the period of November 21 – December 23, 2013. Enclosed are the quality assurance audits which include a RATA Report, 7 Day Calibration Error Test, Linearity, and updated Monitoring Plan.

If you have any questions with the attached, please feel free to contact me at (561) 691-2781 or Elisa Ostertag at (561) 691-2341.

I am authorized to make this submission of behalf of the owners and operators of the affected source or affected units for which the submission is made. I certify under penalty of law that I have personally examined, and am familiar with, the statements and information submitted in this document and all its attachments. Based on my inquiry of those individuals with primary responsibility for obtaining the information, I certify that the statements and information are to the best of my knowledge and belief true, accurate, and complete. I am aware that there are significant penalties for submitting false statements and information or omitting required statements and information, including the possibility of fine or imprisonment.

Sincerely,

A handwritten signature in black ink, appearing to read "CKiernan", followed by a long horizontal line extending to the right.

Christian Kiernan

Florida Power & Light Company

700 Universe Blvd., Juno Beach, FL 33408

Designated Representative

Attachment

cc: Jeff Koerner –Division of Air Resource Management, FDEP Tallahassee  
Khalid AlNahdy – FDEP Northeast District  
Jeff Smith - Plant General Manager  
Tammy Pratt - Environmental Specialist



# ECMPS Client Tool

Version 1.0 2013 Q3

# Monitoring Plan Printout Report

January 31, 2014 10:23 AM

**Facility Name:** Putnam

## Facility Details

Facility ID (ORISPL): 6246  
 Monitoring Plan Location IDs: HRSG22  
 State: FL  
 County: Putnam  
 Latitude: 29.6283  
 Longitude: -81.5856

## Reporting Frequency

Monitoring Plan Location IDs	Reporting Frequency	Begin Quarter	End Quarter
HRSG22	Q - Quarterly	1995 QTR 1	

## Monitoring Location Attributes

Unit/Stack/Pipe Identifier	Duct Indicator	Ground Elevation	Stack Height	Cross Area Exit	Cross Area Flow	Material Code	Shape Code	Begin Date	End Date
HRSG22		23	74	84				01/01/1995	

## Unit Operation Information

Unit Identifier	Non-Load Based Ind	Commence Operation Date	Commence Commercial Operation Date	Code	Boiler/Turbine Type		Value (mmBtu)	Max Heat Input
					Begin Date	End Date		
HRSG22		08/06/1977	08/06/1977	CC	08/06/1977		968.3	01/01/1995
		08/06/1977	08/06/1977	CC	08/06/1977		1232.0	12/22/2009

Unit Type Codes: CC - Combined cycle

## Unit Program Information

Unit Identifier	Program Code	Unit Class	Unit Monitor Certification Begin Date	Unit Monitor Certification Deadline
HRSG22	ARP	P2	01/01/1995	01/01/1995
	CAIRNOX	A	01/01/2008	01/01/2008
	CAIROS	A	05/01/2008	05/01/2008
	CAIRSO2	A	01/01/2009	01/01/2009
	TRNOXOS	A	05/01/2012	05/01/2012

**Monitoring Plan Printout Report**  
January 31, 2014 10:23 AM

**Facility Name:** Putnam

**Facility ID (ORISPL):** 6246

**Unit Fuel**

Unit Identifier	Fuel Type	Fuel Indicator	Demonstration Method for GCY	Demonstration Method for Daily Sulfur	Ozone Season Indicator	Begin Date	End Date
HRSG22	DSL	S				01/01/1995	
	PNG	P				01/01/1995	

**Fuel Type Codes:**  
PNG - Pipeline Natural Gas

DSL - Diesel Oil

S - Secondary

P - Primary

**Monitoring Method**

Unit/Stack/Pipe Identifier	Parameter	Methodology	Substitute Data Approach	Bypass Approach Code	Begin Date/Hour	End Date/Hour
HRSG22	CO2	AD	SPTS		01/01/1995 00	
	HI	AD	SPTS		01/01/1995 00	
	NOX	NOXR			01/01/2008 00	
	NOXR	CEM	SPTS		01/01/1995 00	
	OP	EXP			01/01/1995 00	
	SO2	AD	SPTS		01/01/1995 00	

**Parameter Codes:**  
SO2 - SO2 Hourly Mass Rate (lb/hr)

OP - Opacity

NOXR - NOx Emission Rate (lb/mmBtu)

NOX - NOx Hourly Mass Rate (lb/hr)

HI - Heat Input Rate (mmBtu/hr)

CO2 - CO2 Hourly Mass Rate (ton/hr)

NOXR - NOx Mass Calculated from NOx Emission Rate

EXP - Exempt

CEM - Continuous Emission Monitor

AD - Appendix D

SPTS - Standard Part 75 for Missing Data

**Substitute Data Codes:**

Facility Name: Putnam  
Facility ID (ORISPL): 6246

Monitoring System / Analytical Components

System				Component										
Unit/Stack /Pipe Identifier	ID	Type	Des	Begin Date/Hour	End Date/Hour	ID	Type	SAM	EAS	Manufacturer	Model or Version	Serial Number	Begin Date/Hour	End Date/Hour
HRSG22	112	NOX	P	01/01/1995 00		012	NOX	DIN	W	TECO	42	42D-49809-284	01/01/1995 00	09/30/2003 13
						013	CO2	DIN	W	CALIFORNIA ANALYTICAL	3300	N4C0307T	01/01/1995 00	11/19/2007 12
						017	NOX	DIN	W	TECO	42	42D-49809-284	01/01/1995 00	06/30/2000 23
						888	PRB	DIN		EPM	PPN22PRB04	PPN22PRB04	01/01/1995 00	
						999	DAHS			BABCOCK & WILCOX	8.3.001	NTDAHS-PPN2	01/01/1995 00	
						A12	NOX	DIN	W	TEI	42C	77258-385	09/30/2003 14	11/21/2013 11
						A13	CO2	DIN	W	CALIFORNIA ANALYTICAL	600D	U08065	11/19/2007 13	
						B12	NOX	DIN	W	THERMO	42I	1324258457	11/21/2013 12	
						LK1	NOX	DIN	W	TEI	42I	CM09330063	07/18/2010 13	
	118	GAS	P	01/01/1995 00		018	GFFM	ORF		WESTINGHOUSE	OVATION DCS	BILLFLOW	01/01/1995 00	
119						999	DAHS			BABCOCK & WILCOX	8.3.001	NTDAHS-PPN2	01/01/1995 00	
						019	OFFM	U		CONTROLTRON	990	U-6393	01/01/1995 00	08/13/2010 13
						020	OFFM	U		CONTROLTRON	990	U-5784	01/01/1995 00	01/01/1995 00
						021	OFFM	U		SEIMENS	1010	28718	08/13/2010 14	
					999	DAHS			BABCOCK & WILCOX	8.3.001	NTDAHS-PPN2	01/01/1995 00		

System Types Descriptions:

- NOX - NOx Emission Rate
- GAS - Gas Fuel Flow
- OILV - Volumetric Oil Fuel Flow
- P - Primary
- U - Ultrasonic
- ORF - Orifice
- DIN - Dilution In-Stack
- NOX - NOx Concentration
- CO2 - CO2 Concentration
- PRB - Probe
- DAHS - Data Acquisition and Handling System
- GFFM - Gas Fuel Flowmeter
- OFFM - Oil Fuel Flowmeter

System Designations Descriptions:

Sample Acquisition Method (SAM):

Component Types Descriptions:

**Facility Name:** Putnam  
**Facility ID (ORISPL):** 6246

**Monitoring System Fuel Flow**

Unit/Stack/Pipe Identifier	System ID	Fuel Code	Max Fuel Flow Rate	Units of Measure	Source Code	Begin Date/Hour	End Date/Hour
HRSG22	118	PNG	12500.0	HSCF	URV	01/01/1995 00	
	119	DSL	7500.0	GALHR	URV	01/01/1995 00	

**System Fuel Codes Descriptions:**  
 PNG - Pipeline Natural Gas  
 DSL - Diesel Oil  
**Units of Measure Descriptions:**  
 HSCF - Hundred Standard Cubic Feet / Hour  
 GALHR - Gallons / Hour  
**Source Codes Descriptions:**  
 URV - Upper Range Value

**Analyzer Range Data**

Unit/Stack/Pipe Identifier	Component Type	Component ID	Range Code	Dual Range Indicator	Begin Date/Hour	End Date/Hour
HRSG22	CO2	013	High Range		01/01/1995 00	12/31/2007 23
	CO2	A13	High Range		11/19/2007 13	
	NOX	017	Low Range		01/01/1995 00	06/30/2000 23
	NOX	012	Auto Ranging	Y	01/01/1995 00	12/31/2003 23
	NOX	LK1	Auto Ranging	Y	07/18/2010 13	
	NOX	A12	Auto Ranging	Y	09/30/2003 14	11/21/2013 11
	NOX	B12	Auto Ranging	Y	11/21/2013 12	

**Component Types Descriptions:**  
 CO2 - CO2 Concentration  
 NOX - NOx Concentration

**Emissions Formulas**

**Monitoring Plan Printout Report**  
January 31, 2014 10:23 AM

**Facility Name:** Putnam  
**Facility ID (ORISPL):** 6246

Unit/Stack/Pipe Identifier	Parameter	Formula ID	Formula Code	Formula	Begin Date/Hour	End Date/Hour
HRSG22	NOXR	012	19-7	$1.194 * 10^{**7} * S\#(B12 - 112) * F\#(018) * (100/S\#(A13-112))$	01/01/1995 00	
	CO2	014	G-4	$(1040 * (F\#(016) * (1/385) * 44.0) / 2000$	01/01/1995 00	
	HI	016	F-20	$S\#(018 - 118) * GCV\_GAS / 10^{**+6}$	01/01/1995 00	
	HI	017	F-19	$F\#(021) * GCV\_OIL / 10^{**+6}$	01/01/1995 00	
	FC	018	F-8	$X\_OIL * 1420 + X\_GAS * 1040$	01/01/1995 00	
	SO2	019	D-2	$2.0 * F\#(021) * \%SULFUR\_OIL / 100$	01/01/1995 00	
	SO2	020	D-5	$0.0006 * F\#(016)$	01/01/1995 00	
	OILM	021	D-3	$S\#(021 - 119) * DENSITY\_OIL$	01/01/1995 00	
	CO2	022	G-4	$(1420 * F\#(017) * (1/385) * 44.0) / 2000$	01/01/1995 00	
	HI	023	D-15A	$(F\#(016) * COMBUSTION\_TIME\_GAS + F\#(017) * COMBUSTION\_TIME\_OIL) / T\_HRSG22$	01/01/1995 00	
	NOX	024	F-24A	$NOX\_MASS = F\#(012) * F\#(023) * T\_UNIT$	01/01/2008 00	
	SO2	026	D-12	$SO2\_TOTAL = (F\#(019) * T\_OIL) + (F\#(020) * T\_GAS)$	01/01/1995 00	
	CO2	027	G-4A	$CO2\_TOTAL = ((F\#(022) * T\_OIL) + (F\#(014) * T\_GAS)) / T\_UNIT$	01/01/1995 00	

**Parameter Codes Descriptions:**

- NOXR - NOx Emission Rate (lb/mmBtu)
- CO2 - CO2 Hourly Mass Rate (ton/hr)
- HI - Heat Input Rate (mmBtu/hr)
- FC - F-Factor Carbon-based
- SO2 - SO2 Hourly Mass Rate (lb/hr)
- OILM - Oil Mass Flow Rate (lb/hr)
- NOX - NOx Hourly Mass Rate (lb/hr)
- G-4A - CO2 (from CO2 rate for multiple fuels)
- G-4 - CO2 (from HI, Fc)
- F-8 - FD/FC/FW (from multiple fuels)
- F-24A - NOX (from NOX rate, HI)
- F-20 - HI (same as D-6)
- F-19 - HI (same as D-8)
- D-5 - SO2 (from gas SO2 emission rate, HI)
- D-3 - OILM (from volumetric oil flow rate, density)
- D-2 - SO2 (from OILM, oil sulfur content)
- D-15A - HI (from HI rate for multiple fuels)
- D-12 - SO2 (from SO2 rate for multiple fuels)
- 19-7 - NOXR/SO2R (same as F-6)

**Formula Codes Descriptions:**

**Facility Name:** Putnam  
**Facility ID (ORISPL):** 6246

**Span Values**

Unit/Stack/Pipe Identifier	Comp Type	Scale	Method	MPC/MPF	MEC	Span Value	Full-Scale Range	Units of Measure	Scale Transition Point	Def. High Range Value	Flow Full Range (SCFH)	Flow Span Value (SCFH)	Begin Date/Hour	End Date/Hour
HRSG22	CO2	H	HD	4.0		20.000	20.000	PCT					01/01/1995 00	11/19/2007 10
	CO2	H	HD	4.0		10.000	10.000	PCT					11/19/2007 10	03/31/2011 23
	CO2	H	HD	5.0		10.000	10.000	PCT					04/01/2011 00	
	NOX	H	TB	400.0	160.0	500.000	500.000	PPM	200.0				01/01/1995 00	
	NOX	L	TR		160.0	200.000	200.000	PPM	200.0				01/01/1995 00	

**Component Types Descriptions:** CO2 - CO2 Concentration

NOX - NOx Concentration

TR - Test Results

TB - Table Defaults from Part 75

HD - Historical Data

PPM - Parts per Million

PCT - Percentage

**Span Method Codes Descriptions:**

**Units of Measure Descriptions:**

**Unit/Stack/Pipe Load or Operating Level Information**

Unit/Stack/Pipe Identifier	Maximum Hourly Load	Units of Measure	Upper Bound of Range of Operation	Lower Bound of Range of Operation	Designated Normal Op. Level	Second Most Frequently Used Op. Level	Second Normal Indicator	Load Analysis Date	Begin Date/Hour	End Date/Hour
HRSG22	135	MW	125	13	High	Mid	No	03/31/2000	01/01/1995 00	04/15/2002 23
	135	MW	135	13	High	Mid	Yes	04/16/2001	04/16/2001 00	

**Units of Measure Descriptions:** MW - Megawatt



**Monitoring Plan Printout Report**  
January 31, 2014 10:23 AM

**Facility Name:** Putnam  
**Facility ID (ORISPL):** 6246

**Monitoring Defaults**

Unit/Stack/Pipe Identifier	Parameter	Value	Units of Measure	Purpose Code	Fuel Type	Operating Condition	Source of Value	Begin Date/Hour	End Date/Hour
HRSG22	CO2N	1.0000	PCT	DC	NFS	A	DEF	01/01/1995 00	
	NORX	1.6950	LBM/MBTU	MD	NFS	A	DEF	01/01/1995 00	

**Parameter Codes Descriptions:**  
NORX - Maximum NOx Emission Rate (lb/mmBtu)

CO2N - CO2 Minimum Concentration (pct)

**Units of Measure Descriptions:**  
PCT - Percentage

LBM/MBTU - Pounds / mmBtu

**Purpose Codes Descriptions:**  
MD - Missing Data (or Unmonitored Bypass Stack or Emergency Fuel) Default

DC - Diluent Cap

**Fuel Type Codes Descriptions:**  
NFS - Non-Fuel Specific

**Operating Conditions Descriptions:**  
A - Any Hour

**Source Codes Descriptions:**  
DEF - Default Value from Part 75

**Qualifications**

Unit/Stack/Pipe Identifier	Qualification Type	Begin Date	End Date
HRSG22	GF	01/01/2004	12/31/2004

**Qualification Percentages for Qualification Type Code GF Begin Date 01/01/2004**

Qualification Year	Average Percent Value	Year 1			Year 2			Year 3		
		Data Year	Data Type Cd	Percent Value	Data Year	Data Type Cd	Percent Value	Data Year	Data Type Cd	Percent Value
2004	97.0	2002	A	97.0	2003	A	97.0	2004	P	97.0

**Qualification Types Descriptions:**  
GF - Gas-Fired Unit

**Data Type Codes Descriptions:**  
A - Actual  
D - Demonstration  
P - Projected

ATTACHMENT # SCHEMATIC DIAGRAM  
PUTNAM PLANT - UNIT 2-2  
ORIS CODE: 6246  
NADB BOILER ID: HRSG22

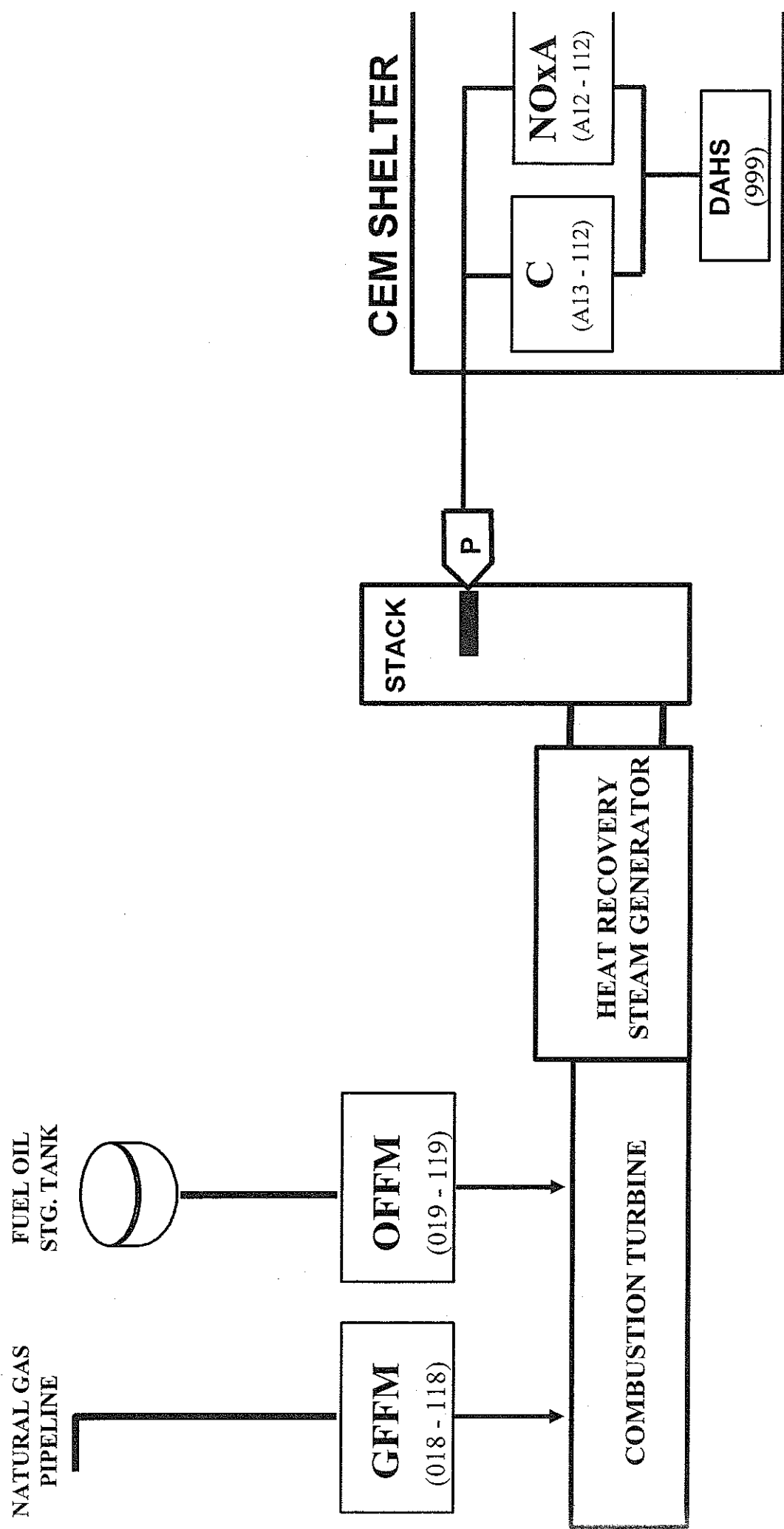

# ATTACHMENT #2

ENGINEERING DRAWING FOR PUTNAM POWER PLANT  
UNIT 2-2



ORIS CODE: 6246  
NADB BOILER ID: HRSG22

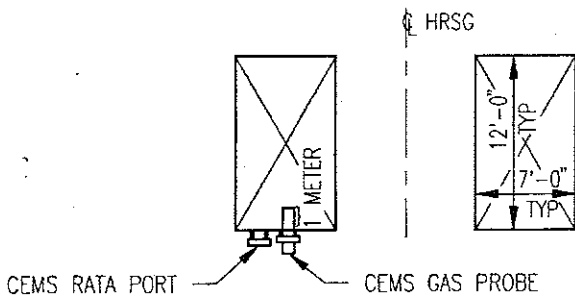

**DETAIL 1**

STACK CROSS SECTION  
AT SAMPLING LEVEL  
EL. 61'-6"

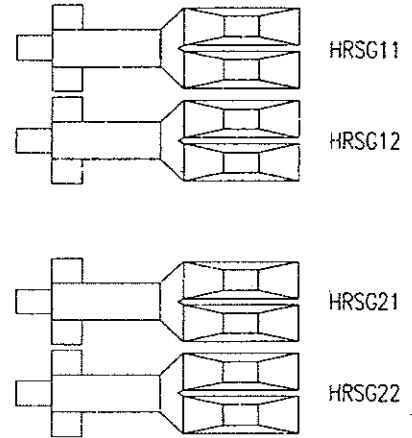

**SITE PLAN**

NTS

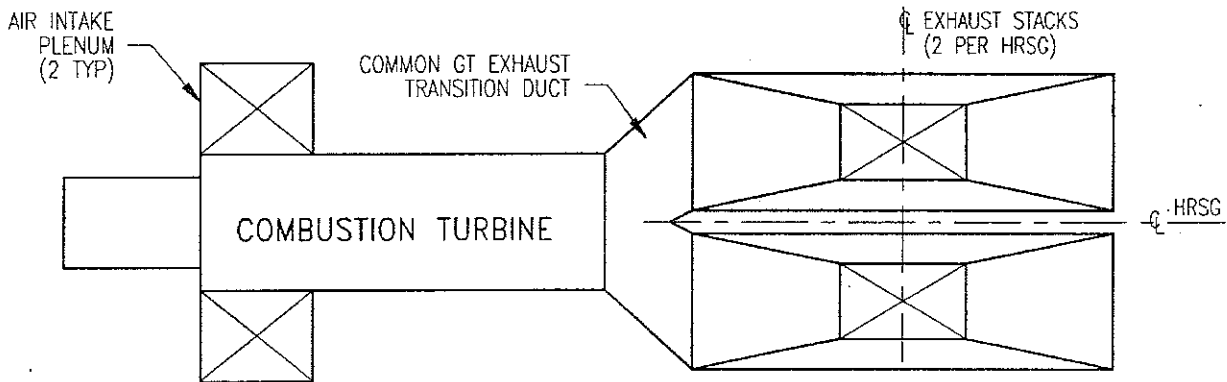

**GENERAL ARRANGEMENT  
OPERATING FLOOR PLAN**

NTS

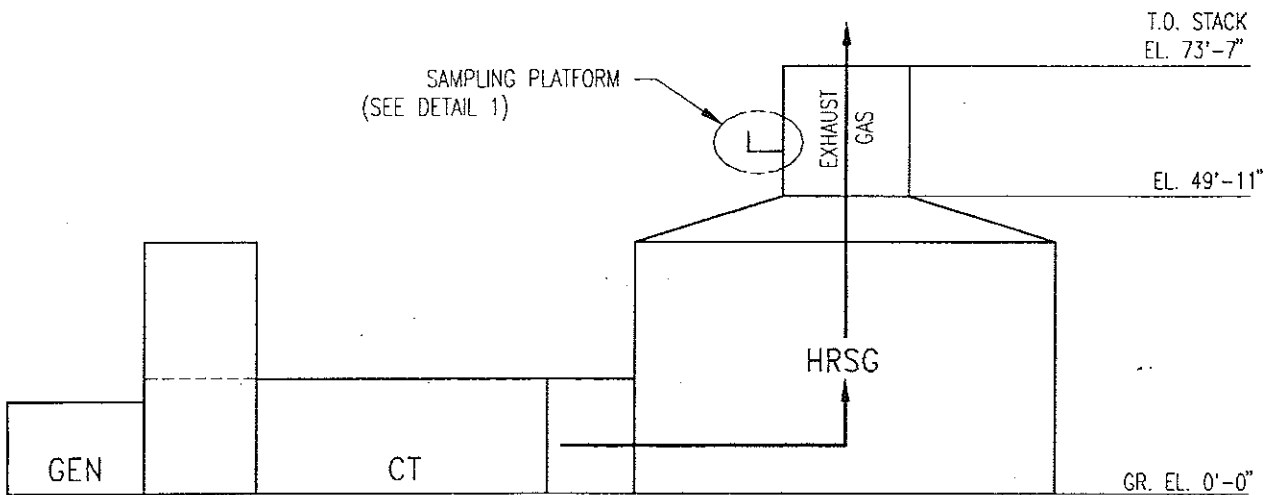

**GENERAL ARRANGEMENT  
POWER BLOCK SECTION**

NTS

ATTACHMENT #3 - DATA INFORMATION FLOW DIAGRAM  
PUTNAM PLANT - UNIT 2-2  
ORIS CODE: 6246  
NADB BOILER I.D. - HRSG22

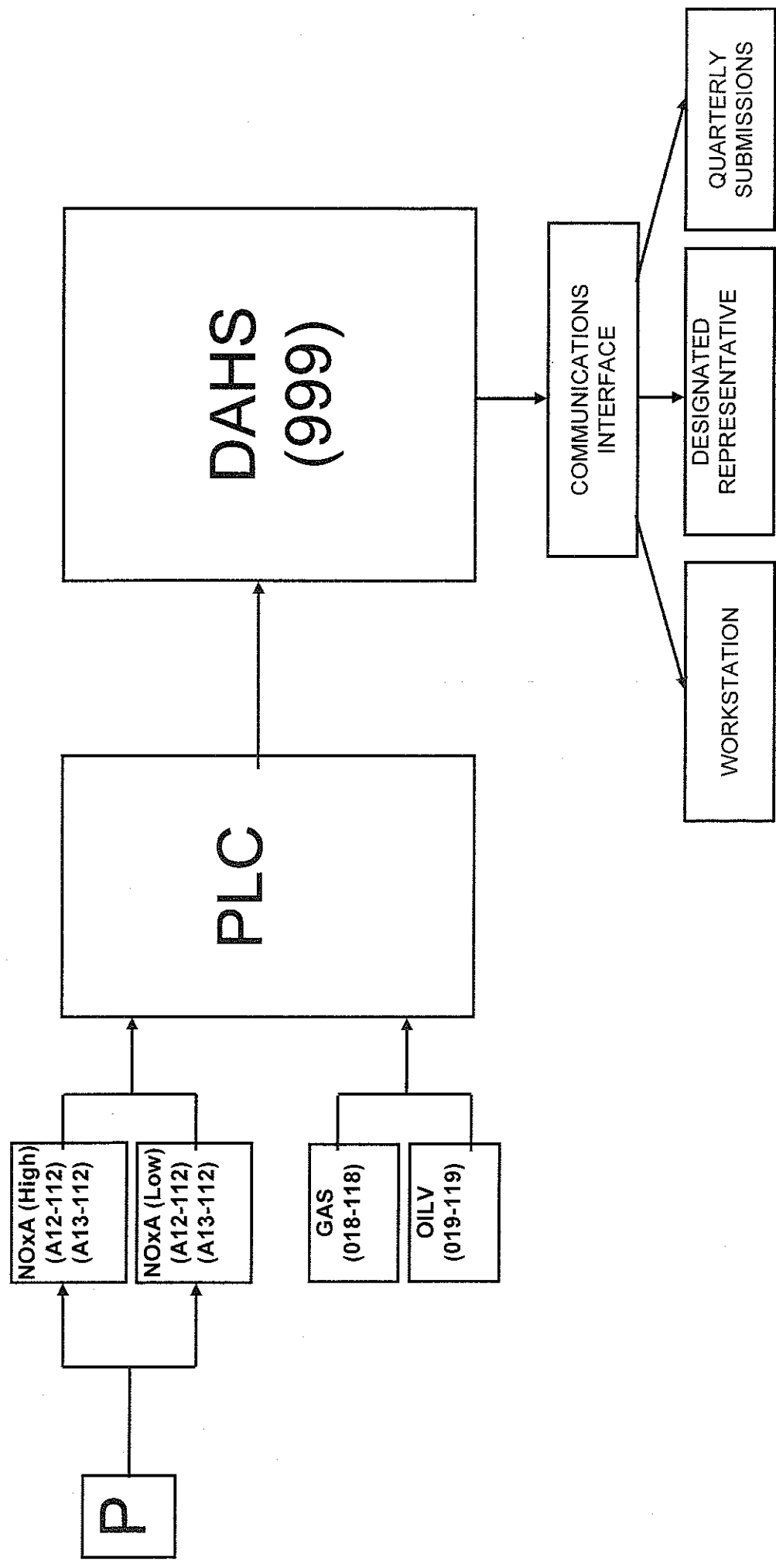





245 West Ohio Ave. • Suite A • Lake Helen, FL 32744

Phone (386) 451-0169 • coastalair123@aol.com

COMPLETE EMISSIONS TESTING SERVICES • PERMITTING ASSISTANCE • CEMS CERTIFICATION • AMBIENT AIR MONITORING

## Emissions Test Report

No. 145-018

### FLORIDA POWER & LIGHT COMPANY PUTNAM POWER PLANT

CT 2 - 2

### RELATIVE ACCURACY TEST AUDIT

Prepared for:

Florida Power & Light  
700 Universe Blvd.  
Juno Beach, FL 33408

Prepared by:

Coastal Air Consulting, Inc.  
245 West Ohio Ave. Suite A  
Lake Helen, FL 32744  
(386) 451-0169

Completed On:

December 23, 2013

## STATEMENT OF VALIDITY

---

All testing activities and results represented herein were conducted and obtained in accordance with the approved EPA protocols listed in 40 CFR Parts 60 & 75. The contents have been reviewed and verified to be true and correct.

Stephen C. Webb

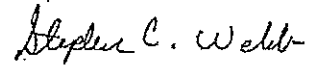

President

Coastal Air Consulting, Inc.  
245 West Ohio Ave. Suite A  
Lake Helen, FL 32744  
(386) 451-0169

## PROJECT STATISTICS

---

Client: Florida Power & Light Company

Facility: Putnam Power Plant  
CT 2 - 2

Location: 392 U S Highway 17 South  
East Palatka, FL 32131-0308

Type of Process Tested: Combined Cycle Combustion Turbine

Test Protocols Performed: Oxygen/Carbon Dioxide-EPA Method 3A  
Nitrogen Oxide-EPA Method 7E

Source Analyzers: CT 2 - 2 Thermo NOx – 42i-1324258457

Testing Firm: Coastal Air Consulting, Inc.  
245 West Ohio Ave. Suite A  
Lake Helen, FL 32744

Test Personnel: Stephen Webb Site Supervisor

Test Date: December 23, 2013

Client Representative: Tammy Pratt

Observers: None



## TABLE OF CONTENTS

---

LETTER OF TRANSMITTAL

TITLE PAGE

STATEMENT OF VALIDITY

PROJECT STATISTICS

TABLE OF CONTENTS

- 1 Introduction
- 2 Test Program Summary
- 3 Results of Testing
- 4 Description of Source
- 5 Sampling Procedures
- 6 Operating Conditions
- 7 Quality Assurance

APPENDICES

- 1 Reference Data
- 2 Plant Data
- 3 Quality Assurance
- 4 Sample Calculations
- 5 Figures
- 6 QSTI

## 1.0 Introduction

---

Coastal Air Consulting, Inc. (Coastal) was contracted by Florida Power & Light Company (FPL) to determine the relative accuracy of the Continuous Emissions Monitoring System (CEMS) at the Putnam Power Plant CT 2 - 2 in Palatka, FL. The sampling program was conducted on December 23, 2013. The RATA was performed by Coastal personnel, with the assistance of personnel assigned by the Putnam Plant.

## 2.0 Test Program Summary

---

A summary of results developed by this testing program is presented in Table 1.

**TABLE 1**  
Relative Accuracy Summary CT 2 - 2

Parameters	Relative Accuracy	Allowable (Annual)	Bias
NOx (lb/mmBtu)	4.63 %	7.5%	NB

\* Low Emitter value = + or - 0.015 lb/mmBtu of the reference value

## 3.0 Results of Testing

---

These results indicate that CT 2 - 2 passed the RATA at the time of testing under normal operating conditions.

## 4.0 Description of Source

---

FPL Putnam Plant consists of four combustion turbines, each with an associated inlet fogger and heat recovery steam generator equipped with duct burners, an auxiliary boiler and unregulated emissions units. Each combustion turbine is a Westinghouse unit rated at 70 MW generating capacity (at 85 degrees F ambient temperature), with a maximum heat input for natural gas and fuel oil of 968.3 MMBtu/ht and 910.6 MMBtu/hr, respectively. The duct burners for each HRSG are rated at a maximum heat input of 250 MMBtu/hr, and are fired with natural gas and number 2 fuel oil. The auxiliary boiler is manufactured by VA-Power and has a maximum heat input for natural gas and number 2 fuel oil of 16.275 MMBtu/hr and 14.28 MMBtu/hr, respectively.

## 5.0 Sampling Procedures

---

EPA testing protocols utilized during this test program include the following;

- EPA Method 3A Gas Analysis for CO<sub>2</sub>, O<sub>2</sub>, Excess Air and Dry Molecular Weight (Instrumental Analyzer Method)
- EPA Method 7E Determination of Nitrogen Oxides Emissions From Stationary Sources (Instrumental Analyzer Method)

## 60 Operating Conditions

---

Putnam Plant personnel monitored operating conditions throughout the duration of the sampling program. The combustion turbine CT 2 - 2 was operating at base load during the RATA test runs.

## 70 Quality Assurance Procedures

---

Quality assurance procedures followed during these testing activities were applied consistent with the requirements outlined by the EPA methods referenced in 40 CFR Parts 60 & 75. Analyzer calibrations, system bias and drift checks were completed before and after each sample run utilizing EPA Protocol 1 calibration

**APPENDIX 1**  
**Reference Data**

### NOx LB/MMBTU RELATIVE ACCURACY

PLANT: FPL-PPN  
 UNIT: 2 2  
 LOAD: 106.6  
 DATE: 12/23/2013

ANALYZER: Thermo  
 SERIAL # 42ILS-1324258457

RUN	TIME START	TIME END	REFERENCE METHOD (NOxlb/mmBTU)	CEM RESPONSE (NOxlb/mmBTU)	ARITHMETIC DIFFERENCE	DIFFERENCE SQUARED
1	10:30	10:50	0.397	0.383	0.014	0.00020
2	11:03	11:23	0.386	0.388	-0.002	0.00000
3	11:33	11:53	0.387	0.390	-0.003	0.00001
4	12:05	12:25	0.384	0.392	-0.008	0.00006
5	12:40	13:00	0.388	0.397	-0.009	0.00008
6	13:10	13:30	0.388	0.399	-0.011	0.00012
7	13:40	14:00	0.389	0.404	-0.015	0.00023
8	14:10	14:30	0.386	0.407	-0.021	0.00044
9	14:40	15:00	0.385	0.411	-0.026	0.00068
			AVERAGE	AVERAGE	SUM OF DIFF.	SUM OF THE SQUARES
			0.3878	0.3968	-0.081	0.001817

\*\*MEAN DIFFERENCE, d (Eq. A-7) -0.0090  
 \*\*STANDARD DEVIATION, Sd (Eq. A-8) 0.0117  
 \*\*CONFIDENCE COEFFICIENT, |CC| (Eq. A-9) 0.0090

\*\*PERCENT (%) RELATIVE ACCURACY, RA (Eq. A-10) 4.633

\*\*BIAS ADJUSTMENT FACTOR, BAF (Eq. A-12) 1.000

\*\* 40 CFR 75, Appendix A

DATE TESTED: 12/23/2013  
Run 1

FLORIDA POWER AND LIGHT CO.  
PUTNAM GT2-2  
ANALYZER CALIBRATION ERROR

RANGE SETTING	GAS UNITS	CERTIFIED GAS VALUE	ANALYZER VALUE	DIFF PPM	% SPAN	ANALYZER SERIAL #
250	ppm NOx	0.00	0.30	0.3	0.1	42CHL-70422-365
	ppm NOx	93.20	93.30	0.1	0.0	
	ppm NOx	213.00	212.70	-0.3	-0.1	
25	% O2	0.00	0.00	0.0	0.0	1420/B153
	% O2	11.90	11.90	0.0	0.0	
	% O2	22.70	22.60	-0.1	-0.4	
20	% CO2	0.00	0.10	0.1	0.6	1410/B139
	% CO2	8.70	8.70	0.0	0.0	
	% CO2	17.10	17.20	0.1	0.6	

SYSTEM BIAS AND SYSTEM DRIFT DATA

GAS UNITS	ANALYZER VALUE	PRETEST CHECK	% SPAN	POSTTEST CHECK	% SPAN	% DRIFT
ppm NOx	0.30	0.40	0.0	0.40	0.0	0.0
ppm NOx	93.30	92.90	-0.2	92.80	-0.2	0.0
% O2	0.00	0.00	0.0	0.00	0.0	0.0
% O2	11.90	11.90	0.0	11.90	0.0	0.0
% CO2	0.10	0.20	0.6	0.20	0.6	0.0
% CO2	8.70	8.70	0.0	8.67	-0.2	-0.2

UNCORRECTED REFERENCE DATA

Date & Time	NOx PPM	% O2	% CO2
12/23/2013 10:30	87.68	15.98	2.84
12/23/2013 10:31	87.50	15.97	2.85
12/23/2013 10:32	87.48	15.98	2.85
12/23/2013 10:33	87.37	15.97	2.85
12/23/2013 10:34	87.20	15.88	2.84
12/23/2013 10:35	87.05	15.99	2.85
12/23/2013 10:36	86.87	15.98	2.85
12/23/2013 10:37	86.80	15.99	2.87
12/23/2013 10:38	86.70	15.99	2.86
12/23/2013 10:39	86.50	15.97	2.86
12/23/2013 10:40	86.33	15.97	2.86
12/23/2013 10:41	86.30	15.98	2.85
12/23/2013 10:42	86.15	15.98	2.84
12/23/2013 10:43	86.10	15.99	2.85
12/23/2013 10:44	86.12	15.99	2.85
12/23/2013 10:45	86.18	16.01	2.88
12/23/2013 10:46	85.95	16.00	2.86
12/23/2013 10:47	85.80	15.99	2.85
12/23/2013 10:48	85.93	15.99	2.86
12/23/2013 10:49	86.00	15.99	2.85
12/23/2013 10:50	86.00	15.99	2.83
AVERAGE	86.57	15.98	2.85

NOx PPM	86.87
% O2	15.98
% CO2	2.72
LB/MMBTU NOx	0.397

F Factor 1040

Absolute Value  
0.397

DATE TESTED: 12/23/2013  
Run 2

FLORIDA POWER AND LIGHT CO.  
PUTNAM GT2-2  
ANALYZER CALIBRATION ERROR

RANGE SETTING	GAS UNITS	CERTIFIED		DIFF PPM	% SPAN	ANALYZER SERIAL #
		GAS VALUE	ANALYZER VALUE			
250	ppm NOx	0.00	0.30	0.3	0.1	42CHL-70422-365
	ppm NOx	93.20	93.30	0.1	0.0	
	ppm NOx	213.00	212.70	-0.3	-0.1	
10	% O2	0.00	0.00	0.0	0.0	1420/B153
	% O2	11.90	11.90	0.0	0.0	
	% O2	22.70	22.60	-0.1	-0.4	
20	% CO2	0.00	0.10	0.1	0.6	1410/B139
	% CO2	8.70	8.70	0.0	0.0	
	% CO2	17.10	17.20	0.1	0.6	

SYSTEM BIAS AND SYSTEM DRIFT DATA

GAS UNITS	ANALYZER VALUE	PRETEST CHECK	% SPAN	POSTTEST CHECK	% SPAN	% DRIFT
ppm NOx	0.30	0.40	0.0	0.40	0.0	0.0
ppm NOx	93.30	92.80	-0.2	92.60	-0.3	-0.1
% O2	0.00	0.00	0.0	0.00	0.0	0.0
% O2	11.90	11.90	0.0	11.90	0.0	0.0
% CO2	0.10	0.20	0.6	0.20	0.6	0.0
% CO2	8.70	8.67	-0.2	8.69	-0.1	0.1

UNCORRECTED REFERENCE DATA

Date & Time	NOx PPM	% O2	% CO2
12/23/2013 11:03	72.45	15.91	3.15
12/23/2013 11:04	82.75	15.98	2.96
12/23/2013 11:06	85.37	15.99	2.92
12/23/2013 11:06	86.05	15.99	2.88
12/23/2013 11:07	86.37	15.99	2.86
12/23/2013 11:08	86.43	15.99	2.89
12/23/2013 11:09	86.45	15.99	2.86
12/23/2013 11:10	86.50	15.99	2.87
12/23/2013 11:11	86.30	16.00	2.87
12/23/2013 11:12	86.23	16.00	2.87
12/23/2013 11:13	86.23	15.99	2.88
12/23/2013 11:14	86.45	15.99	2.88
12/23/2013 11:15	86.60	15.99	2.89
12/23/2013 11:16	86.43	16.00	2.89
12/23/2013 11:17	86.27	16.00	2.88
12/23/2013 11:18	86.18	15.99	2.86
12/23/2013 11:19	86.33	15.99	2.88
12/23/2013 11:20	86.33	15.99	2.88
12/23/2013 11:21	86.20	15.99	2.88
12/23/2013 11:22	86.02	15.98	2.87
12/23/2013 11:23	86.00	15.98	2.89
AVERAGE	85.42	15.99	2.89

NOx PPM	85.85
% O2	15.99
% CO2	2.76
LB/MMBTU NOx	0.386

F Factor 1040

DATE TESTED: 12/23/2013  
Run 3

FLORIDA POWER AND LIGHT CO.  
PUTNAM GT2-2  
ANALYZER CALIBRATION ERROR

RANGE SETTING	GAS UNITS	CERTIFIED		DIFF PPM	% SPAN	ANALYZER SERIAL #
		GAS VALUE	ANALYZER VALUE			
250	ppm NOx	0.00	0.30	0.3	0.1	42CHL-70422-365
	ppm NOx	93.20	93.30	0.1	0.0	
	ppm NOx	213.00	212.70	-0.3	-0.1	
10	% O2	0.00	0.00	0.0	0.0	1420/B153
	% O2	11.90	11.90	0.0	0.0	
	% O2	22.70	22.60	-0.1	-0.4	
20	% CO2	0.00	0.10	0.1	0.6	1410/B139
	% CO2	8.70	8.70	0.0	0.0	
	% CO2	17.10	17.20	0.1	0.6	

SYSTEM BIAS AND SYSTEM DRIFT DATA

GAS UNITS	ANALYZER VALUE	PRETEST CHECK	% SPAN	POSTTEST CHECK	% SPAN	% DRIFT
ppm NOx	0.30	0.40	0.0	0.30	0.0	0.0
ppm NOx	93.30	92.60	-0.3	92.30	-0.5	-0.1
% O2	0.00	0.00	0.0	0.00	0.0	0.0
% O2	11.90	11.90	0.0	11.90	0.0	0.0
% CO2	0.10	0.20	0.6	0.20	0.6	0.0
% CO2	8.70	8.69	-0.1	8.68	-0.1	-0.1

UNCORRECTED REFERENCE DATA

Date & Time	NOx PPM	% O2	% CO2
12/23/2013 11:33	85.68	15.98	2.89
12/23/2013 11:34	85.58	15.98	2.88
12/23/2013 11:35	85.52	15.98	2.88
12/23/2013 11:36	85.62	15.97	2.89
12/23/2013 11:37	85.73	15.98	2.89
12/23/2013 11:38	85.62	15.98	2.89
12/23/2013 11:39	85.45	15.98	2.90
12/23/2013 11:40	85.37	15.98	2.89
12/23/2013 11:41	85.30	15.98	2.89
12/23/2013 11:42	85.35	15.97	2.89
12/23/2013 11:43	85.48	15.97	2.90
12/23/2013 11:44	85.68	15.98	2.92
12/23/2013 11:45	85.55	15.98	2.89
12/23/2013 11:46	85.48	15.99	2.89
12/23/2013 11:47	85.50	15.99	2.89
12/23/2013 11:48	85.55	15.98	2.90
12/23/2013 11:49	85.62	15.99	2.91
12/23/2013 11:50	85.68	15.99	2.90
12/23/2013 11:51	85.70	15.99	2.91
12/23/2013 11:52	85.58	15.99	2.93
12/23/2013 11:53	85.40	15.98	2.92
AVERAGE	85.54	15.98	2.89

NOx PPM	86.21
% O2	15.98
% CO2	2.76
LB/MMBTU NOx	0.387

F Factor 1040

Absolute Value  
0.387



DATE TESTED: 12/23/2013  
Run 4

FLORIDA POWER AND LIGHT CO.  
PUTNAM GT2-2  
ANALYZER CALIBRATION ERROR

RANGE SETTING	GAS UNITS	CERTIFIED		DIFF PPM	% SPAN	ANALYZER SERIAL #
		GAS VALUE	ANALYZER VALUE			
250	ppm NOx	0.00	0.30	0.3	0.1	42CHL-70422-365
	ppm NOx	93.20	93.30	0.1	0.0	
	ppm NOx	213.00	212.70	-0.3	-0.1	
10	% O2	0.00	0.00	0.0	0.0	1420/B153
	% O2	11.90	11.90	0.0	0.0	
	% O2	22.70	22.60	-0.1	-0.4	
20	% CO2	0.00	0.10	0.1	0.6	1410/B139
	% CO2	8.70	8.70	0.0	0.0	
	% CO2	17.10	17.20	0.1	0.6	

SYSTEM BIAS AND SYSTEM DRIFT DATA

GAS UNITS	ANALYZER VALUE	PRETEST CHECK	% SPAN	POSTTEST CHECK	% SPAN	% DRIFT
ppm NOx	0.30	0.30	0.0	0.20	0.0	0.0
ppm NOx	93.30	92.30	-0.5	92.10	-0.6	-0.1
% O2	0.00	0.00	0.0	0.00	0.0	0.0
% O2	11.90	11.90	0.0	11.90	0.0	0.0
% CO2	0.10	0.20	0.6	0.20	0.6	0.0
% CO2	8.70	8.68	-0.1	8.65	-0.3	-0.2

UNCORRECTED REFERENCE DATA

Date & Time	NOx PPM	% O2	% CO2
12/23/2013 12:05	86.00	15.96	2.93
12/23/2013 12:06	85.85	15.96	2.93
12/23/2013 12:07	85.65	15.97	2.92
12/23/2013 12:08	85.45	15.97	2.90
12/23/2013 12:09	85.37	15.97	2.92
12/23/2013 12:10	85.37	15.96	2.93
12/23/2013 12:11	85.58	15.96	2.93
12/23/2013 12:12	85.68	15.96	2.94
12/23/2013 12:13	85.77	15.94	2.94
12/23/2013 12:14	85.95	15.95	2.93
12/23/2013 12:15	85.80	15.96	2.95
12/23/2013 12:16	85.70	15.98	2.93
12/23/2013 12:17	85.77	15.96	2.93
12/23/2013 12:18	85.93	15.95	2.93
12/23/2013 12:19	86.10	15.95	2.92
12/23/2013 12:20	86.08	15.96	2.94
12/23/2013 12:21	85.95	15.95	2.93
12/23/2013 12:22	86.02	15.96	2.92
12/23/2013 12:23	85.90	15.96	2.94
12/23/2013 12:24	85.87	15.96	2.93
12/23/2013 12:25	85.80	15.96	2.94
AVERAGE	85.79	15.96	2.93

NOx PPM	86.70
% O2	15.96
% CO2	2.80
LB/MMBTU NOx	0.384

F Factor 1040

Absolute Value  
0.384

DATE TESTED: 12/23/2013  
Run 5

FLORIDA POWER AND LIGHT CO.  
PUTNAM GT2-2  
ANALYZER CALIBRATION ERROR

RANGE SETTING	GAS UNITS	CERTIFIED		DIFF PPM	% SPAN	ANALYZER SERIAL #
		GAS VALUE	ANALYZER VALUE			
250	ppm NOx	0.00	0.30	0.3	0.1	42CHL-70422-365
	ppm NOx	93.20	93.30	0.1	0.0	
	ppm NOx	213.00	212.70	-0.3	-0.1	
10	% O2	0.00	0.00	0.0	0.0	1420/B153
	% O2	11.90	11.90	0.0	0.0	
	% O2	22.70	22.80	-0.1	-0.4	
20	% CO2	0.00	0.10	0.1	0.6	1410/B139
	% CO2	8.70	8.70	0.0	0.0	
	% CO2	17.10	17.20	0.1	0.6	

SYSTEM BIAS AND SYSTEM DRIFT DATA

GAS UNITS	ANALYZER VALUE	PRETEST CHECK	% SPAN	POSTTEST CHECK	% SPAN	% DRIFT
ppm NOx	0.30	0.20	0.0	0.20	0.0	0.0
ppm NOx	93.30	92.10	-0.6	92.20	-0.5	0.0
% O2	0.00	0.00	0.0	0.00	0.0	0.0
% O2	11.90	11.90	0.0	11.90	0.0	0.0
% CO2	0.10	0.20	0.6	0.20	0.6	0.0
% CO2	8.70	8.65	-0.3	8.70	0.0	0.3

UNCORRECTED REFERENCE DATA

Date & Time	NOx PPM	% O2	% CO2
12/23/2013 12:40	87.85	15.89	2.92
12/23/2013 12:41	87.15	15.93	2.94
12/23/2013 12:42	87.12	15.94	2.94
12/23/2013 12:43	87.00	15.94	2.95
12/23/2013 12:44	86.90	15.94	2.93
12/23/2013 12:45	86.95	15.94	2.94
12/23/2013 12:46	86.93	15.94	2.94
12/23/2013 12:47	86.85	15.95	2.95
12/23/2013 12:48	86.77	15.94	2.94
12/23/2013 12:49	86.83	15.95	2.94
12/23/2013 12:50	86.95	15.94	2.94
12/23/2013 12:51	87.08	15.94	2.95
12/23/2013 12:52	87.02	15.94	2.96
12/23/2013 12:53	87.02	15.94	2.96
12/23/2013 12:54	87.00	15.94	2.95
12/23/2013 12:55	87.05	15.94	2.95
12/23/2013 12:56	86.95	15.94	2.94
12/23/2013 12:57	86.93	15.94	2.94
12/23/2013 12:58	86.87	15.94	2.96
12/23/2013 12:59	86.80	15.94	2.94
12/23/2013 13:00	86.75	15.94	2.96
AVERAGE	86.98	15.94	2.94

NOx PPM	87.98
% O2	15.94
% CO2	2.81
LB/MMBTU NOx	0.388

F Factor 1040

Absolute Value  
0.388

DATE TESTED: 12/23/2013  
Run 6

FLORIDA POWER AND LIGHT CO.  
PUTNAM GT2-2  
ANALYZER CALIBRATION ERROR

RANGE SETTING	GAS UNITS	CERTIFIED		DIFF PPM	% SPAN	ANALYZER SERIAL #
		GAS VALUE	ANALYZER VALUE			
250	ppm NOx	0.00	0.30	0.3	0.1	42CHL-70422-365
	ppm NOx	93.20	93.30	0.1	0.0	
	ppm NOx	213.00	212.70	-0.3	-0.1	
10	% O2	0.00	0.00	0.0	0.0	1420/B153
	% O2	11.90	11.90	0.0	0.0	
	% O2	22.70	22.60	-0.1	-0.4	
20	% CO2	0.00	0.10	0.1	0.6	1410/B139
	% CO2	8.70	8.70	0.0	0.0	
	% CO2	17.10	17.20	0.1	0.6	

SYSTEM BIAS AND SYSTEM DRIFT DATA

GAS UNITS	ANALYZER VALUE	PRETEST CHECK	% SPAN	POSTTEST CHECK	% SPAN	% DRIFT
ppm NOx	0.30	0.20	0.0	0.30	0.0	0.0
ppm NOx	93.30	92.20	-0.5	92.60	-0.4	0.1
% O2	0.00	0.00	0.0	0.00	0.0	0.0
% O2	11.90	11.90	0.0	11.90	0.0	0.0
% CO2	0.10	0.20	0.8	0.20	0.8	0.0
% CO2	8.70	8.70	0.0	8.69	-0.1	-0.1

UNCORRECTED REFERENCE DATA

Date & Time	NOx PPM	% O2	% CO2
12/23/2013 13:10	86.55	15.94	2.94
12/23/2013 13:11	86.45	15.94	2.93
12/23/2013 13:12	86.62	15.93	2.92
12/23/2013 13:13	87.12	15.93	2.93
12/23/2013 13:14	87.10	15.94	2.94
12/23/2013 13:15	87.00	15.93	2.94
12/23/2013 13:16	87.10	15.93	2.95
12/23/2013 13:17	87.10	15.92	2.96
12/23/2013 13:18	87.08	15.92	2.94
12/23/2013 13:19	87.10	15.93	2.96
12/23/2013 13:20	86.93	15.93	2.94
12/23/2013 13:21	86.83	15.93	2.95
12/23/2013 13:22	87.00	15.91	2.95
12/23/2013 13:23	87.08	15.92	2.95
12/23/2013 13:24	86.98	15.93	2.94
12/23/2013 13:25	86.83	15.93	2.94
12/23/2013 13:26	86.70	15.92	2.96
12/23/2013 13:27	86.87	15.91	2.94
12/23/2013 13:28	87.00	15.93	2.95
12/23/2013 13:29	86.68	15.93	2.95
12/23/2013 13:30	86.73	15.92	2.96
AVERAGE	86.90	15.93	2.94

NOx PPM	87.68
% O2	15.93
% CO2	2.81
LB/MMBTU NOx	0.388

F Factor 1040

Absolute Value  
0.388

DATE TESTED: 12/23/2013  
Run 7

FLORIDA POWER AND LIGHT CO.  
PUTNAM GT2-2  
ANALYZER CALIBRATION ERROR

RANGE SETTING	GAS UNITS	CERTIFIED		DIFF PPM	% SPAN	ANALYZER SERIAL #
		GAS VALUE	ANALYZER VALUE			
250	ppm NOx	0.00	0.30	0.3	0.1	42CHL-70422-365
	ppm NOx	93.20	93.30	0.1	0.0	
	ppm NOx	213.00	212.70	-0.3	-0.1	
10	% O2	0.00	0.00	0.0	0.0	1420/B153
	% O2	11.90	11.90	0.0	0.0	
	% O2	22.70	22.60	-0.1	-0.4	
20	% CO2	0.00	0.10	0.1	0.6	1410/B139
	% CO2	8.70	8.70	0.0	0.0	
	% CO2	17.10	17.20	0.1	0.6	

SYSTEM BIAS AND SYSTEM DRIFT DATA

GAS UNITS	ANALYZER VALUE	PRETEST CHECK	% SPAN	POSTTEST CHECK	% SPAN	% DRIFT
ppm NOx	0.30	0.30	0.0	0.30	0.0	0.0
ppm NOx	93.30	92.50	-0.4	92.60	-0.3	0.0
% O2	0.00	0.00	0.0	0.00	0.0	0.0
% O2	11.90	11.90	0.0	11.90	0.0	0.0
% CO2	0.10	0.20	0.6	0.20	0.6	0.0
% CO2	8.70	8.69	-0.1	8.68	-0.1	-0.1

UNCORRECTED REFERENCE DATA

Date & Time	NOx PPM	% O2	% CO2
12/23/2013 13:40	89.05	15.99	2.89
12/23/2013 13:41	88.12	15.87	2.95
12/23/2013 13:42	87.68	15.90	2.95
12/23/2013 13:43	87.55	15.91	2.96
12/23/2013 13:44	87.85	15.91	2.95
12/23/2013 13:45	87.98	15.91	2.96
12/23/2013 13:46	87.85	15.91	2.95
12/23/2013 13:47	87.52	15.90	2.95
12/23/2013 13:48	87.70	15.91	2.96
12/23/2013 13:49	87.85	15.91	2.97
12/23/2013 13:50	88.02	15.91	2.96
12/23/2013 13:51	88.10	15.90	2.98
12/23/2013 13:52	88.08	15.91	2.97
12/23/2013 13:53	87.95	15.91	2.97
12/23/2013 13:54	87.77	15.91	2.96
12/23/2013 13:55	87.73	15.91	2.96
12/23/2013 13:56	87.85	15.91	2.97
12/23/2013 13:57	87.75	15.91	2.96
12/23/2013 13:58	87.87	15.91	2.96
12/23/2013 13:59	87.73	15.91	2.96
12/23/2013 14:00	87.73	15.90	2.99
AVERAGE	87.89	15.91	2.96

NOx PPM	88.49
% O2	15.91
% CO2	2.83
LB/MMBTU NOx	0.389

F Factor 1040

Absolute Value  
0.389

DATE TESTED: 12/23/2013  
Run 8

FLORIDA POWER AND LIGHT CO.  
PUTNAM GT2-2  
ANALYZER CALIBRATION ERROR

RANGE SETTING	GAS UNITS	CERTIFIED		DIFF PPM	% SPAN	ANALYZER SERIAL #
		GAS VALUE	ANALYZER VALUE			
250	ppm NOx	0.00	0.30	0.3	0.1	42CHL-70422-365
	ppm NOx	93.20	46.80	-46.4	-21.8	
	ppm NOx	213.00	212.70	-0.3	-0.1	
10	% O2	0.00	0.00	0.0	0.0	1420/B153
	% O2	11.90	11.90	0.0	0.0	
	% O2	22.70	22.60	-0.1	-0.4	
20	% CO2	0.00	0.10	0.1	0.6	1410/B139
	% CO2	8.70	8.70	0.0	0.0	
	% CO2	17.10	17.20	0.1	0.6	

SYSTEM BIAS AND SYSTEM DRIFT DATA

GAS UNITS	ANALYZER VALUE	PRETEST CHECK	% SPAN	POSTTEST CHECK	% SPAN	% DRIFT
ppm NOx	0.30	0.30	0.0	0.30	0.0	0.0
ppm NOx	93.30	92.60	-0.3	92.70	-0.3	0.0
% O2	0.00	0.00	0.0	0.00	0.0	0.0
% O2	11.90	11.90	0.0	11.90	0.0	0.0
% CO2	0.10	0.20	0.6	0.20	0.6	0.0
% CO2	8.70	8.68	-0.1	8.70	0.0	0.1

UNCORRECTED REFERENCE DATA

Date & Time	NOx PPM	% O2	% CO2
12/23/2013 14:10	87.37	15.92	2.95
12/23/2013 14:11	87.30	15.91	2.98
12/23/2013 14:12	87.43	15.91	2.96
12/23/2013 14:13	87.43	15.91	2.97
12/23/2013 14:14	87.48	15.90	2.97
12/23/2013 14:15	87.62	15.89	2.98
12/23/2013 14:16	87.52	15.90	3.00
12/23/2013 14:17	87.37	15.89	2.97
12/23/2013 14:18	87.45	15.90	2.97
12/23/2013 14:19	87.58	15.91	2.98
12/23/2013 14:20	87.75	15.91	2.98
12/23/2013 14:21	87.80	15.91	2.97
12/23/2013 14:22	88.00	15.90	2.98
12/23/2013 14:23	88.27	15.89	2.97
12/23/2013 14:24	88.35	15.89	2.98
12/23/2013 14:25	88.45	15.88	2.98
12/23/2013 14:26	88.48	15.89	2.98
12/23/2013 14:27	88.27	15.89	2.98
12/23/2013 14:28	88.18	15.89	2.95
12/23/2013 14:29	88.23	15.89	2.99
12/23/2013 14:30	88.18	15.89	2.98
AVERAGE	87.83	15.90	2.97

NOx PPM	88.34
% O2	15.90
% CO2	2.84
LB/MMBTU NOx	0.386

F Factor 1040

Absolute Value  
0.386

DATE TESTED: 12/23/2013  
Run 9

FLORIDA POWER AND LIGHT CO.  
PUTNAM GT2-2  
ANALYZER CALIBRATION ERROR

RANGE SETTING	GAS UNITS	CERTIFIED		DIFF PPM	% SPAN	ANALYZER SERIAL #
		GAS VALUE	ANALYZER VALUE			
250	ppm NOx	0.00	0.30	0.3	0.1	42CHL-70422-365
	ppm NOx	93.20	93.30	0.1	0.0	
	ppm NOx	213.00	212.70	-0.3	-0.1	
10	% O2	0.00	0.00	0.0	0.0	1420/B153
	% O2	11.90	11.90	0.0	0.0	
	% O2	22.70	22.60	-0.1	-0.4	
20	% CO2	0.00	0.10	0.1	0.6	1410/B139
	% CO2	8.70	8.70	0.0	0.0	
	% CO2	17.10	17.20	0.1	0.6	

SYSTEM BIAS AND SYSTEM DRIFT DATA

GAS UNITS	ANALYZER VALUE	PRETEST CHECK	% SPAN	POSTTEST CHECK	% SPAN	% DRIFT
ppm NOx	0.30	0.30	0.0	0.20	0.0	0.0
ppm NOx	93.30	92.70	-0.3	92.50	-0.4	-0.1
% O2	0.00	0.00	0.0	0.00	0.0	0.0
% O2	11.90	11.90	0.0	11.90	0.0	0.0
% CO2	0.10	0.20	0.6	0.20	0.6	0.0
% CO2	8.70	8.70	0.0	8.68	-0.1	-0.1

UNCORRECTED REFERENCE DATA

Date & Time	NOx PPM	% O2	% CO2
12/23/2013 14:40	87.70	15.88	3.00
12/23/2013 14:41	87.77	15.89	2.97
12/23/2013 14:42	87.85	15.88	2.98
12/23/2013 14:43	88.00	15.88	2.98
12/23/2013 14:44	88.23	15.88	3.00
12/23/2013 14:45	88.25	15.87	2.99
12/23/2013 14:46	88.20	15.88	2.99
12/23/2013 14:47	88.15	15.88	2.99
12/23/2013 14:48	88.00	15.87	2.99
12/23/2013 14:49	88.08	15.88	3.00
12/23/2013 14:50	88.25	15.88	2.99
12/23/2013 14:51	88.12	15.88	2.99
12/23/2013 14:52	88.08	15.88	2.99
12/23/2013 14:53	88.23	15.88	2.99
12/23/2013 14:54	88.20	15.88	3.01
12/23/2013 14:55	88.15	15.88	2.99
12/23/2013 14:56	88.23	15.88	2.99
12/23/2013 14:57	88.23	15.87	3.01
12/23/2013 14:58	88.27	15.88	2.99
12/23/2013 14:59	88.23	15.86	3.00
12/23/2013 15:00	88.30	15.86	3.00
AVERAGE	88.12	15.87	2.99

NOx PPM	88.68
% O2	15.87
% CO2	2.86
LB/MMBTU NOx	0.385

F Factor 1040

Absolute Value  
0.385

PUTNAM GT2-2

3 Point Traverse Port	Nox ppm Average	Nox ppm % difference	Date & Time	NOx PPM
1	85.04	-1.2	12/23/2013 9:59	84.69
			12/23/2013 10:00	84.89
			12/23/2013 10:01	85.21
			12/23/2013 10:02	85.35
2	86.23	0.2	12/23/2013 10:03	85.88
			12/23/2013 10:04	86.23
			12/23/2013 10:05	86.35
			12/23/2013 10:06	86.47
3	86.83	0.9	12/23/2013 10:07	86.66
			12/23/2013 10:08	86.75
			12/23/2013 10:09	87.02
			12/23/2013 10:10	86.87
Mean Average	86.03			

Probe Markings: 40", 76" & 112"  
 Allowable: + or - 0.5 ppm or + or - 5.0%

**APPENDIX 2  
PLANT DATA**



Babcock & Wilcox Power Generation Group NetDAHS®

Version 46.0

Average Values Report  
Generated: 12/23/2013 12:06

Company: Florida Power & Light PPN A  
Plant:  
City/St.: , FL  
Source: stack2

Period Start: 12/23/2013 10:30  
Period End: 12/23/2013 10:50  
Validation Type: 1/1 min  
Averaging Period: 1 min  
Type: Block Avg

Period Start:	Average 2CO2 %	Average 2NOx ppm	Average 2MW MW	Average 2NOx#M #/M
12/23/2013 10:30	2.97	91.8	109.6	0.384
12/23/2013 10:31	2.97	91.8	109.4	0.384
12/23/2013 10:32	2.97	91.9	109.3	0.384
12/23/2013 10:33	2.96	91.5	109.3	0.384
12/23/2013 10:34	2.96	91.5	109.3	0.384
12/23/2013 10:35	2.96	91.5	109.2	0.384
12/23/2013 10:36	2.96	91.5	109.3	0.384
12/23/2013 10:37	2.97	91.3	109.0	0.382
12/23/2013 10:38	2.96	91.3	108.8	0.383
12/23/2013 10:39	2.95	91.1	108.5	0.383
12/23/2013 10:40	2.96	91.2	108.6	0.383
12/23/2013 10:41	2.96	91.1	108.6	0.382
12/23/2013 10:42	2.95	91.0	108.6	0.383
12/23/2013 10:43	2.96	91.1	108.5	0.382
12/23/2013 10:44	2.95	91.3	108.2	0.384
12/23/2013 10:45	2.95	91.0	108.6	0.383
12/23/2013 10:46	2.95	90.9	108.5	0.383
12/23/2013 10:47	2.96	91.2	108.4	0.383
12/23/2013 10:48	2.95	91.3	108.2	0.384
12/23/2013 10:49	2.95	91.4	108.3	0.385
12/23/2013 10:50	2.96	91.2	108.2	0.383
Daily Average*	2.96	91.3	108.8	0.383
Maximum*	2.97	91.9	109.6	0.385
12/23/2013	12/23/2013	12/23/2013	12/23/2013	12/23/2013
10:37	10:32	10:30	10:49	10:49
Minimum*	2.95	90.9	108.2	0.382
12/23/2013	12/23/2013	12/23/2013	12/23/2013	12/23/2013
10:49	10:46	10:50	10:43	10:43

\* Does not include Invalid Averaging Periods ("N/A")

Babcock & Wilcox Power Generation Group NetDAHS®

Version 46.0

Average Values Report

Generated: 12/23/2013 12:08

Company: Florida Power & Light PPN-3  
 Plant:   
 City/St.: , FL  
 Source: stack2

Period Start: 12/23/2013 11:03  
 Period End: 12/23/2013 11:23  
 Validation Type: 1/1 min  
 Averaging Period: 1 min  
 Type: Block Avg

Period Start:	Average 2CO2 %	Average 2NOx ppm	Average 2MW MW	Average 2NOx*HM #/M
12/23/2013 11:03	2.95	91.3	108.0	0.384
12/23/2013 11:04	2.95	91.7	107.9	0.386
12/23/2013 11:05	2.95	91.9	108.0	0.387
12/23/2013 11:06	2.95	92.2	107.9	0.388
12/23/2013 11:07	2.95	92.1	107.9	0.388
12/23/2013 11:08	2.95	92.2	107.9	0.388
12/23/2013 11:09	2.95	92.2	107.9	0.388
12/23/2013 11:10	2.95	92.1	107.7	0.388
12/23/2013 11:11	2.95	92.2	107.8	0.388
12/23/2013 11:12	2.95	92.3	108.1	0.389
12/23/2013 11:13	2.96	92.6	107.7	0.388
12/23/2013 11:14	2.96	92.8	107.9	0.389
12/23/2013 11:15	2.95	92.5	107.7	0.389
12/23/2013 11:16	2.95	92.1	108.0	0.388
12/23/2013 11:17	2.95	92.5	107.9	0.388
12/23/2013 11:18	2.96	92.5	107.9	0.388
12/23/2013 11:19	2.97	92.9	107.8	0.388
12/23/2013 11:20	2.95	92.6	107.8	0.390
12/23/2013 11:21	2.95	92.3	107.9	0.389
12/23/2013 11:22	2.96	92.6	107.6	0.388
12/23/2013 11:23	2.95	92.6	107.8	0.390
Daily Average*	2.95	92.3	107.9	0.388
Maximum*	2.97	92.9	108.1	0.390
	12/23/2013	12/23/2013	12/23/2013	12/23/2013
Minimum*	11:19	11:19	11:12	11:23
	2.95	91.3	107.6	0.384
	12/23/2013	12/23/2013	12/23/2013	12/23/2013
	11:23	11:03	11:22	11:03

\* Does not include Invalid Averaging Periods ("N/A")



Babcock & Wilcox Power Generation Group NetDAHS®

Average Values Report  
Generated: 12/23/2013 12:48

Company: Florida Power & Light PEN A  
Plant:  
City/St.: FL  
Source: stack2

Period Start: 12/23/2013 12:05  
Period End: 12/23/2013 12:25  
Validation Type: 1/1 min  
Averaging Period: 1 min  
Type: Block Avg

Period Start:	Average 2CO2 %	Average 2NOx ppm	Average 2MW MW	Average 2NOx#M #/M
12/23/2013 12:05	2.95	93.1	106.7	0.392
12/23/2013 12:06	2.95	92.8	106.7	0.391
12/23/2013 12:07	2.95	92.3	107.0	0.389
12/23/2013 12:08	2.94	92.6	106.9	0.391
12/23/2013 12:09	2.95	92.8	107.2	0.391
12/23/2013 12:10	2.95	92.8	107.0	0.391
12/23/2013 12:11	2.96	93.0	107.3	0.390
12/23/2013 12:12	2.96	93.1	107.0	0.391
12/23/2013 12:13	2.95	93.0	106.9	0.391
12/23/2013 12:14	2.94	92.6	106.6	0.391
12/23/2013 12:15	2.93	92.6	107.0	0.392
12/23/2013 12:16	2.93	92.8	106.9	0.393
12/23/2013 12:17	2.94	93.2	106.4	0.394
12/23/2013 12:18	2.94	93.4	106.6	0.394
12/23/2013 12:19	2.94	93.1	106.5	0.393
12/23/2013 12:20	2.94	93.3	106.6	0.394
12/23/2013 12:21	2.93	93.5	106.6	0.396
12/23/2013 12:22	2.93	93.0	106.5	0.394
12/23/2013 12:23	2.93	93.3	106.4	0.395
12/23/2013 12:24	2.93	93.2	106.6	0.395
12/23/2013 12:25	2.94	93.2	106.5	0.394
Daily Average*	2.94	93.0	106.8	0.392
Maximum*	2.96	93.5	107.3	0.396
	12/23/2013	12/23/2013	12/23/2013	12/23/2013
	12:12	12:21	12:11	12:21
Minimum*	2.93	92.3	106.4	0.389
	12/23/2013	12/23/2013	12/23/2013	12/23/2013
	12:24	12:07	12:23	12:07

\* Does not include Invalid Averaging Periods ("N/A")

Babcock & Wilcox Power Generation Group NetDAS®

Average Values Report  
Generated: 12/23/2013 13:06

Company: Florida Power & Light FPN 2  
Plant:  
City/St.: , FL  
Source: stack2

Period Start:  
12/23/2013 12:40  
12/23/2013 12:41  
12/23/2013 12:42  
12/23/2013 12:43  
12/23/2013 12:44  
12/23/2013 12:45  
12/23/2013 12:46  
12/23/2013 12:47  
12/23/2013 12:48  
12/23/2013 12:49  
12/23/2013 12:50  
12/23/2013 12:51  
12/23/2013 12:52  
12/23/2013 12:53  
12/23/2013 12:54  
12/23/2013 12:55  
12/23/2013 12:56  
12/23/2013 12:57  
12/23/2013 12:58  
12/23/2013 12:59  
12/23/2013 13:00

Period Start:	Average CO2 %	Average 2NOx ppm	Average 2MW MW	Average 2NOx#M #/M
12/23/2013 12:40	2.95	94.3	106.8	0.397
12/23/2013 12:41	2.96	94.2	106.8	0.395
12/23/2013 12:42	2.95	94.3	106.7	0.397
12/23/2013 12:43	2.95	93.9	106.5	0.395
12/23/2013 12:44	2.95	94.3	106.4	0.397
12/23/2013 12:45	2.95	94.3	106.5	0.397
12/23/2013 12:46	2.94	93.9	106.6	0.397
12/23/2013 12:47	2.95	94.0	106.6	0.396
12/23/2013 12:48	2.94	94.1	106.7	0.397
12/23/2013 12:49	2.94	94.1	106.4	0.397
12/23/2013 12:50	2.95	94.5	106.5	0.398
12/23/2013 12:51	2.95	94.4	106.3	0.397
12/23/2013 12:52	2.95	94.3	106.5	0.397
12/23/2013 12:53	2.94	94.0	106.3	0.397
12/23/2013 12:54	2.94	94.3	106.2	0.398
12/23/2013 12:55	2.94	93.9	106.4	0.397
12/23/2013 12:56	2.94	94.0	106.2	0.397
12/23/2013 12:57	2.94	94.1	106.2	0.397
12/23/2013 12:58	2.93	93.9	106.1	0.398
12/23/2013 12:59	2.94	94.0	105.9	0.397
12/23/2013 13:00	2.94	94.1	106.2	0.397
Daily Average*	2.94	94.1	106.4	0.397
Maximum*	2.96	94.5	106.8	0.398
Minimum*	12:41	12:50	12:41	12:58
	12/23/2013	12/23/2013	12/23/2013	12/23/2013
	2.93	93.9	105.9	0.395
	12/23/2013	12/23/2013	12/23/2013	12/23/2013
	12:58	12:58	12:59	12:43

\* Does not include Invalid Averaging Periods ("N/A")

Babcock & Wilcox Power Generation Group NetDAHS®

Average Values Report

Generated: 12/23/2013 14:19

Company: Florida Power & Light PPN 7  
 Plant:  
 City/St.: FL  
 Source: stack2

Period Start: 12/23/2013 13:10  
 Period End: 12/23/2013 13:30  
 Validation Type: 1/1 min  
 Averaging Period: 1 min  
 Type: Block Avg

Period Start:	Average 2CO2 %	Average 2NOx ppm	Average 2MW MW	Average 2NOxHF #/M
12/23/2013 13:10	2.93	93.6	106.2	0.397
12/23/2013 13:11	2.94	94.0	105.8	0.397
12/23/2013 13:12	2.94	94.9	105.8	0.401
12/23/2013 13:13	2.92	94.3	105.9	0.401
12/23/2013 13:14	2.93	94.4	105.9	0.400
12/23/2013 13:15	2.94	94.6	105.8	0.400
12/23/2013 13:16	2.93	94.3	106.0	0.400
12/23/2013 13:17	2.93	94.3	105.8	0.400
12/23/2013 13:18	2.94	94.4	105.8	0.399
12/23/2013 13:19	2.93	94.2	106.1	0.399
12/23/2013 13:20	2.94	94.2	106.0	0.398
12/23/2013 13:21	2.95	95.0	105.9	0.400
12/23/2013 13:22	2.95	94.8	105.8	0.399
12/23/2013 13:23	2.94	94.3	105.7	0.398
12/23/2013 13:24	2.94	94.4	105.9	0.399
12/23/2013 13:25	2.93	94.4	105.9	0.400
12/23/2013 13:26	2.94	94.6	105.8	0.400
12/23/2013 13:27	2.94	94.5	105.7	0.399
12/23/2013 13:28	2.94	94.3	105.9	0.398
12/23/2013 13:29	2.94	94.5	105.9	0.399
12/23/2013 13:30	2.95	94.8	106.0	0.399
Daily Average*	2.94	94.4	105.9	0.399
Maximum*	2.95	95.0	106.2	0.401
	12/23/2013 13:30	12/23/2013 13:21	12/23/2013 13:10	12/23/2013 13:13
Minimum*	2.92	93.6	105.7	0.397
	12/23/2013 13:13	12/23/2013 13:10	12/23/2013 13:27	12/23/2013 13:11

\* Does not include Invalid Averaging Periods ("N/A")

Babcock & Wilcox Power Generation Group NetDAHS®

Average Values Report  
Generated: 12/23/2013 14:20

Company: Florida Power & Light PPN A  
Plant:  
City/St.: FL  
Source: stack2

Period Start: 12/23/2013 13:40  
Period End: 12/23/2013 14:00  
Validation Type: 1/1 min  
Averaging Period: 1 min  
Type: Block Avg

Period Start:	Average 2CO2 %	Average 2NOx ppm	Average 2MW MW	Average .2NOx#M #/M
12/23/2013 13:40	2.95	95.9	105.7	0.404
12/23/2013 13:41	2.95	95.6	105.8	0.402
12/23/2013 13:42	2.95	95.6	105.9	0.402
12/23/2013 13:43	2.94	96.2	105.8	0.405
12/23/2013 13:44	2.95	96.1	105.7	0.405
12/23/2013 13:45	2.94	95.9	105.8	0.405
12/23/2013 13:46	2.94	95.2	105.9	0.402
12/23/2013 13:47	2.95	96.0	105.8	0.404
12/23/2013 13:48	2.94	96.0	105.7	0.405
12/23/2013 13:49	2.95	96.2	106.0	0.405
12/23/2013 13:50	2.95	96.2	105.9	0.405
12/23/2013 13:51	2.95	96.3	105.6	0.405
12/23/2013 13:52	2.94	96.0	105.7	0.405
12/23/2013 13:53	2.95	96.0	105.9	0.404
12/23/2013 13:54	2.94	95.6	105.7	0.404
12/23/2013 13:55	2.94	95.9	105.8	0.405
12/23/2013 13:56	2.93	95.6	105.8	0.405
12/23/2013 13:57	2.94	95.9	105.9	0.405
12/23/2013 13:58	2.94	96.0	105.7	0.405
12/23/2013 13:59	2.95	96.0	105.8	0.404
12/23/2013 14:00	2.94	95.9	105.7	0.405
Daily Average*	2.94	95.9	105.8	0.404
Maximum*	2.95	96.3	106.0	0.406
Minimum*	13:59	13:51	13:49	13:43
	12/23/2013	12/23/2013	12/23/2013	12/23/2013
	12/23/2013	12/23/2013	12/23/2013	12/23/2013
	13:56	13:46	13:51	13:46

\* Does not include Invalid Averaging Periods ("N/A")

Babcock & Wilcox Power Generation Group NetDAHS®

Average Values Report  
Generated: 12/23/2013 14:39

Company: Florida Power & Light PPN 3  
Plant:  
City/St.: , FL  
Source: stack2

Period Start: 12/23/2013 14:10  
Period End: 12/23/2013 14:30  
Validation Type: 1/1 min  
Averaging Period: 1 min  
Type: Block Avg

Period Start:	Average 2CO2 %	Average 2NOx ppm	Average 2MW MW	Average 2NOxPM #/M
12/23/2013 14:10	2.93	95.9	105.6	0.406
12/23/2013 14:11	2.94	95.7	105.6	0.404
12/23/2013 14:12	2.94	95.9	105.7	0.405
12/23/2013 14:13	2.94	96.0	105.4	0.405
12/23/2013 14:14	2.94	96.0	105.6	0.405
12/23/2013 14:15	2.94	95.7	105.5	0.404
12/23/2013 14:16	2.94	95.6	105.5	0.404
12/23/2013 14:17	2.95	96.0	105.6	0.404
12/23/2013 14:18	2.94	96.1	105.4	0.406
12/23/2013 14:19	2.95	96.1	105.6	0.405
12/23/2013 14:20	2.94	96.5	105.5	0.408
12/23/2013 14:21	2.94	97.0	105.6	0.410
12/23/2013 14:22	2.94	97.1	105.6	0.410
12/23/2013 14:23	2.95	97.0	105.7	0.408
12/23/2013 14:24	2.95	97.5	105.5	0.410
12/23/2013 14:25	2.94	97.3	105.4	0.411
12/23/2013 14:26	2.94	97.0	105.4	0.410
12/23/2013 14:27	2.94	97.0	105.4	0.410
12/23/2013 14:28	2.94	96.9	105.3	0.409
12/23/2013 14:29	2.94	97.0	105.3	0.410
12/23/2013 14:30	2.94	96.7	105.3	0.408
Daily Average*	2.94	96.5	105.5	0.407
Maximum*	2.95	97.5	105.7	0.411
12/23/2013	2.95	97.5	105.7	0.411
14:24	14:24	14:24	14:23	12/23/2013
Minimum*	2.93	95.6	105.3	14:25
12/23/2013	12/23/2013	12/23/2013	12/23/2013	0.404
14:10	14:10	14:16	14:30	12/23/2013
				14:17

\* Does not include Invalid Averaging Periods ("N/A")



Babcock & Wilcox Power Generation Group NetDAES®

Average Values Report

Generated: 12/23/2013 15:08

Company: Florida Power & Light PPN A  
 Plant:  
 City/St.: , FL  
 Source: stack2

Period Start: 12/23/2013 14:40  
 Period End: 12/23/2013 15:00  
 Validation Type: 1/1 min  
 Averaging Period: 1 min  
 Type: Block Avg

Period Start:	Average 2CO2 %	Average 2NOx ppm	Average 2MW MW	Average 2NOxPM #/M
12/23/2013 14:40	2.93	96.6	105.3	0.409
12/23/2013 14:41	2.94	96.5	105.5	0.408
12/23/2013 14:42	2.94	97.0	105.4	0.410
12/23/2013 14:43	2.94	97.3	105.2	0.411
12/23/2013 14:44	2.94	97.3	105.4	0.411
12/23/2013 14:45	2.94	97.2	105.3	0.411
12/23/2013 14:46	2.94	97.1	105.5	0.410
12/23/2013 14:47	2.94	97.0	105.4	0.410
12/23/2013 14:48	2.95	97.3	105.0	0.410
12/23/2013 14:49	2.94	97.5	105.1	0.412
12/23/2013 14:50	2.94	97.0	105.4	0.410
12/23/2013 14:51	2.94	97.1	105.2	0.410
12/23/2013 14:52	2.94	97.3	105.2	0.411
12/23/2013 14:53	2.93	97.1	105.2	0.412
12/23/2013 14:54	2.94	97.1	105.2	0.410
12/23/2013 14:55	2.93	97.1	105.2	0.412
12/23/2013 14:56	2.94	97.3	105.2	0.411
12/23/2013 14:57	2.94	97.2	105.4	0.411
12/23/2013 14:58	2.94	97.2	105.2	0.411
12/23/2013 14:59	2.94	97.4	105.1	0.411
12/23/2013 15:00	2.95	97.4	105.2	0.410
Daily Average*	2.94	97.1	105.3	0.411
Maximum*	2.95	97.5	105.5	0.412
Minimum*	15:00	14:49	14:46	14:55
	2.93	96.5	105.0	0.408
	12/23/2013	12/23/2013	12/23/2013	12/23/2013
	14:55	14:41	14:48	14:41

\* Does not include Invalid Averaging Periods ('NN/A')

**APPENDIX 3  
QUALITY ASSURANCE**

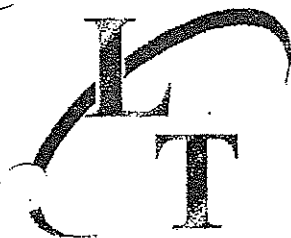

# LIQUID TECHNOLOGY CORPORATION

"INDUSTRY LEADER IN SPECIALTY GASES"

## Certificate of Analysis

Customer Coastal Air Consulting (Deland, FL)  
Date December 09, 2013  
Delivery Receipt DR-49522  
Product: Nitrogen, CEMS Grade  
Lot Number: LTM063-PG

## Mixture Specifications

Cylinder Number CC-165548

<u>Components</u>	<u>Requested</u>	<u>Actual</u>
Moisture	2.0 ppm	< 2.0 ppm
Hydrocarbons	0.1 ppm	< 0.1 ppm
Oxygen	1.0 ppm	< 1.0 ppm
Carbon Monoxide	1.0 ppm	< 1.0 ppm
Carbon Dioxide	1.0 ppm	< 1.0 ppm

## Cylinder Data

Cylinder Valve: CGA 580  
Cylinder Volume: 140 Cubic Feet  
Cylinder Pressure: 2000 psig, 70°F  
Expiration Date: December 09, 2016

Certified by:

Cole Dylewski

"UNMATCHED EXCELLENCE"

2048 APEX COURT APOPKA, FLORIDA 32703 - PHONE (407)-292-2990 FAX (407)-292-3313  
WWW.LIQUIDTECHCORP.COM  
APOPKA, FL • HOUSTON, TX



# LIQUID TECHNOLOGY CORPORATION

"INDUSTRY LEADER IN SPECIALTY GASES"

## Certificate of Analysis - EPA PROTOCOL GAS -

Customer Coastal Air Consulting (Deland, FL)  
Date November 07, 2013  
Delivery Receipt DR-49129  
Gas Standard 90-99 ppm NO, 90-99 ppm SO2, 90-99 ppm CO/Nitrogen - EPA PROTOCOL  
Final Analysis Date November 06, 2013  
Expiration Date November 06, 2021 ✓

Components Nitric Oxide, Sulfur Dioxide, Carbon Monoxide  
Balance Gas Nitrogen

Analytical Data:  
 EPA Protocol, Section No. 2.2, Procedure G-1

**DO NOT USE BELOW 100 psig**

### Reported Concentrations

**Nitric Oxide: 93.2 ppm +/- 0.22 ppm** ✓  
**Sulfur Dioxide: 92.1 ppm +/- 0.90 ppm**  
**Carbon Monoxide: 97.3 ppm +/- 0.30 ppm**

**Nitrogen: Balance**

**Total Oxides of Nitrogen: 93.2 ppm**

\*\* Total NOX for Reference Use Only \*\*

### Reference Standards:

SRM/GMIS:	GMIS	GMIS	GMIS
Cylinder Number:	CC-252014	CC-54548	EB-0015851
Concentration:	97.25 ppm NO/Nitrogen	102.43 ppm SO2/N2	104.90 ppm CO/Nitrogen
Expiration Date:	03/21/21	12/01/14	10/21/14

### Certification Instrumentation

Component:	Nitric Oxide	Sulfur Dioxide	Carbon Monoxide
Make/Model:	Nicolet 6700	Nicolet 6700	Nicolet 6700
Serial Number:	APW1100563	APW1100563	APW1100563
Principal of Measurement:	FTIR	FTIR	FTIR
Last Calibration:	October 23, 2013	October 23, 2013	October 16, 2013

### Cylinder Data

Cylinder Serial Number: CC-88806 ✓      Cylinder Outlet: CGA 660  
 Cylinder Volume: 135 Cubic Feet      Cylinder Pressure: 1925 psig, 70°F

Analytical Uncertainty and NIST Traceability are in compliance with EPA-600/R-12/531.

Certified by: *Cole Dylewski*  
 Cole Dylewski

PGVP Vendor ID: E12013 ✓

"UNMATCHED EXCELLENCE"

2048 APEX COURT APOPKA, FLORIDA 32703 ~ PHONE (407)-292-2990 FAX (407)-292-3313  
 WWW.LIQUIDTECHCORP.COM  
 APOPKA, FL • HOUSTON, TX



**LIQUID TECHNOLOGY CORPORATION**  
 "INDUSTRY LEADER IN SPECIALTY GASES"

Certificate of Analysis  
**- EPA PROTOCOL GAS -**

Customer Coastal Air Consulting (Deland, FL)  
Date November 07, 2013  
Delivery Receipt DR-49129  
Gas Standard 185-225 ppm NO, 185-225 ppm SO<sub>2</sub>, 185-225 ppm CO/Nitrogen - EPA PROTOCOL  
Final Analysis Date November 07, 2013  
Expiration Date November 07, 2021

Components Nitric Oxide, Sulfur Dioxide, Carbon Monoxide  
Balance Gas Nitrogen

Analytical Data:  
 EPA Protocol, Section No. 2.2, Procedure G-1

**DO NOT USE BELOW 100 psig**

Reported Concentrations  
**Nitric Oxide: 213 ppm +/- 1.0 ppm**  
**Sulfur Dioxide: 212 ppm +/- 1.7 ppm**  
**Carbon Monoxide: 213 ppm +/- 1.0 ppm**  
**Nitrogen: Balance**  
**Total Oxides of Nitrogen: 213 ppm**

\*\* Total NOX for Reference Use Only \*\*

Reference Standards:

SRM/GMIS:	GMIS	GMIS/GMIS	GMIS
Cylinder Number:	ND-45515	CC-54548/CC-251490	CC-185111
Concentration:	245.26 ppm NO/Nitrogen	102.43 ppm SO <sub>2</sub> /507.88 ppm SO <sub>2</sub>	257.47 ppm CO/Nitrogen
Expiration Date:	08/23/20	04/12/14 - 04/12/14	10/22/14

Certification Instrumentation

Component:	Nitric Oxide	Sulfur Dioxide	Carbon Monoxide
Make/Model:	Nicolet 6700	Nicolet 6700	Nicolet 6700
Serial Number:	APW1100563	APW1100563	APW1100563
Principal of Measurement:	FTIR	FTIR	FTIR
Last Calibration:	October 23, 2013	October 23, 2013	October 16, 2013

Cylinder Data

Cylinder Serial Number: EB-0051448  
 Cylinder Volume: 136 Cubic Feet  
 Cylinder Outlet: CGA 660  
 Cylinder Pressure: 1950 psig, 70°F

Analytical Uncertainty and NIST Traceability are in compliance with EPA-600/R-12/531.

Certified by: *Cole Dylewski*  
 Cole Dylewski

PGVP Vendor ID: E12013

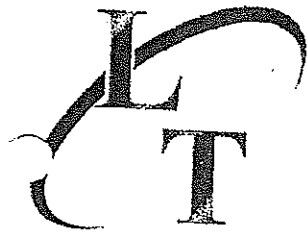

**LIQUID TECHNOLOGY CORPORATION**  
 "INDUSTRY LEADER IN SPECIALTY GASES"

Certificate of Analysis  
**- EPA PROTOCOL GAS -**

<u>Customer</u>	<u>Coastal Air Consulting (Deland, FL)</u>
<u>Date</u>	<u>September 27, 2013</u>
<u>Delivery Receipt</u>	<u>DR-48499</u>
<u>Gas Standard</u>	<u>8.00 - 10.0% CO<sub>2</sub>, 11.0 - 13.0% Oxygen/Nitrogen - EPA PROTOCOL</u>
<u>Final Analysis Date</u>	<u>September 23, 2013</u>
<u>Expiration Date</u>	<u>September 23, 2021 ✓</u>
<u>Component</u>	<u>Carbon Dioxide, Oxygen</u>
<u>Balance Gas</u>	<u>Nitrogen</u>

Analytical Data:

EPA Protocol, Section No. 2.2, Procedure G-1

**DO NOT USE BELOW 100 psig**

Reported Concentrations

**Carbon Dioxide: 8.70% +/- 0.08% ✓**

**Oxygen: 11.9% +/- 0.10% ✓**

**Nitrogen: Balance**

Reference Standards:

SRM/GMIS:	GMIS/GMIS	GMIS
Cylinder Number:	EB-0026839/CC-185129	CC-231332
Concentration:	6.847% CO <sub>2</sub> /13.92% CO <sub>2</sub>	9.97% Oxygen/Nitrogen
Expiration Date:	10/03/20 - 06/24/14	04/06/14

Certification Instrumentation

Component:	Carbon Dioxide	Oxygen
Make/Model:	Nicolet 6700	Servomex 244a
Serial Number:	APW1200289	1847
Principal of Measurement:	FTIR	Paramagnetic
Last Calibration:	September 05, 2013	September 18, 2013

Cylinder Data

Cylinder Serial Number:	CC-233289 ✓	Cylinder Outlet:	CGA 590
Cylinder Volume:	136 Cubic Feet	Cylinder Pressure:	1925 psig, 70°F

Analytical Uncertainty and NIST Traceability are in compliance with EPA-600/R-12/531.

Certified by:

David Scott

PGVP Vendor ID: B12013 ✓

"UNMATCHED EXCELLENCE"

2048 APEX COURT APOPKA, FLORIDA 32703 ~ PHONE (407)-292-2990 FAX (407)-292-3313  
 WWW.LIQUIDTECHCORP.COM  
 APOPKA, FL • HOUSTON, TX

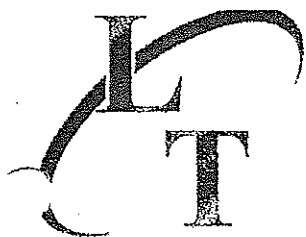

# LIQUID TECHNOLOGY CORPORATION

"INDUSTRY LEADER IN SPECIALTY GASES"

## Certificate of Analysis - EPA PROTOCOL GAS -

Customer Coastal Air Consulting (Deland, FL)  
Date November 01, 2011  
Delivery Receipt DR-39306  
Gas Standard 17.0-18.0% CO<sub>2</sub>, 22.0-23.0% Oxygen/Nitrogen - EPA PROTOCOL  
Final Analysis Date November 01, 2011  
Expiration Date November 01, 2014 ✓

Component Carbon Dioxide, Oxygen  
Balance Gas Nitrogen

Analytical Data: DO NOT USE BELOW 150 psig  
EPA Protocol, Section No. 2.2, Procedure G-1

Reported Concentrations  
**Carbon Dioxide: 17.1% +/- 0.17%** ✓  
**Oxygen: 22.7% +/- 0.22%** ✓  
**Nitrogen: Balance**

### Reference Standards:

SRM/GMIS:	GMIS/GMIS	GMIS
Cylinder Number:	CC-252091/CC-184404	CC-159090
Concentration:	15.816% CO <sub>2</sub> /19.87% CO <sub>2</sub>	20.72% Oxygen/Nitrogen
Expiration Date:	02/04/13 - 02/04/13	05/06/12

### Certification Instrumentation

Component:	Carbon Dioxide	Oxygen
Make/Model:	Horiba - VIA 510	Servomex 244a
Serial Number:	SN075GSF	1847
Principal of Measurement:	NDIR	Paramagnetic
Last Calibration:	October 10, 2011	October 09, 2011

### Cylinder Data

Cylinder Serial Number: CC-159134 ✓      Cylinder Outlet: CGA 590  
Cylinder Volume: 140 Cubic Feet      Cylinder Pressure: 2000 psig, 70°F  
Analytical Uncertainty and NIST Traceability are in compliance with EPA-600/R-97/121.

Certified by:

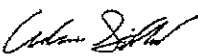
  
Adam Strickland

PGVP Vendor ID: E12011 ✓

"UNMATCHED EXCELLENCE"



LIQUID TECHNOLOGY CORPORATION  
"INDUSTRY LEADER IN SPECIALTY GASES"

Certificate of Analysis  
- EPA PROTOCOL GAS -  
\*\* Recertification \*\*

Customer Coastal Air Consulting (Deland, FL)  
Date November 14, 2013  
Delivery Receipt DR-49187  
Gas Standard 45.0 ppm Nitrogen Dioxide/Air - EPA PROTOCOL  
Final Analysis Date November 12, 2013  
Expiration Date November 12, 2016

Cylinder Data  
Cylinder Serial Number: EB-0026837  
Cylinder Volume: 70 Cubic Feet  
Expiration Date: November 12, 2016

DO NOT USE BELOW 150 psig

Cylinder Outlet: CGA 660  
Cylinder Pressure: 1000 psig, 70°F

Analytical Data  
EPA Protocol, Section No. 2.2, Procedure G-1

- Replicate Concentrations -  
Nitrogen Dioxide: 45.2 ppm +/- 0.44 ppm *N<sub>2</sub> Gas for Converter check*  
Air: Balance

Reference Standard(s):  
SRM/GMIS: GMIS  
Cylinder Number: CC-185381  
Concentration: 50.584 ppm NO<sub>2</sub>/Nitrogen  
Expiration Date: 04/21/15

Certification Instrumentation  
Component: Nitrogen Dioxide  
Make/Model: Horiba - CLA 510  
Serial Number: 43331870031  
Principal of Measurement: Chemiluminescence  
Last Calibration: October 10, 2013

Analytical uncertainty and NIST Traceability are in compliance with EPA-600/R-12/531.

Certified by: *Cole Dylewski*  
Cole Dylewski

PGVP Vendor ID: E12013

Original Data: 44.3 ppm NO<sub>2</sub>/Air (November 01, 2011)





**LIQUID TECHNOLOGY CORPORATION**  
 "INDUSTRY LEADER IN SPECIALTY GASES"

Certificate of Analysis  
**- EPA PROTOCOL GAS -**

Customer Coastal Air Consulting (Deland, FL)  
Date September 27, 2013  
Delivery Receipt DR-48499  
Gas Standard 47.0 ppm NO, 47.0 ppm SO2, 47.0 ppm CO/Nitrogen - EPA PROTOCOL  
Final Analysis Date September 27, 2013  
Expiration Date September 27, 2016

Components Nitric Oxide, Sulfur Dioxide, Carbon Monoxide  
Balance Gas Nitrogen

Analytical Data: EPA Protocol, Section No. 2.2, Procedure G-1 **DO NOT USE BELOW 100 psig**

Reported Concentrations  
**Nitric Oxide: 46.4 ppm +/- 0.46 ppm** ✓ *converter check*  
**Sulfur Dioxide: 48.3 ppm +/- 0.48 ppm**  
**Carbon Monoxide: 47.5 ppm +/- 0.40 ppm**  
Nitrogen: Balance  
**Total Oxides of Nitrogen: 46.5 ppm**  
 \*\* Total NOX for Reference Use Only \*\*

Reference Standards:

SRM/GMIS:	GMIS	GMIS	GMIS
Cylinder Number:	EB-0016740	EB-0014698	EB-0017129
Concentration:	49.69 ppm NO/Nitrogen	50.67 ppm SO2	50.81 ppm CO/Nitrogen
Expiration Date:	07/08/14	11/01/16	10/20/14

Certification Instrumentation

Component:	Nitric Oxide	Sulfur Dioxide	Carbon Monoxide
Make/Model:	Nicolet 6700	Nicolet 6700	Nicolet 6700
Serial Number:	APW1100563	APW1100563	APW1100563
Principal of Measurement:	FTIR	FTIR	FTIR
Last Calibration:	September 26, 2013	September 26, 2013	September 19, 2013

Cylinder Data

Cylinder Serial Number: CC-159097      Cylinder Outlet: CGA 660  
 Cylinder Volume: 133 Cubic Feet      Cylinder Pressure: 1900 psig, 70°F

Analytical Uncertainty and NIST Traceability are in compliance with EPA-600/R-12/531.

Certified by:   
 David Scott

PGVP Vendor ID: E12013

COASTAL AIR CONSULTING, INC.

Unit: CT 2-1

Date: 12-23-13

SYSTEM RESPONSE TIME

CT2-1

Train 1	
Analyzer Type: <u>Thermo</u>	Gas Concentration: <u>~95 ppm</u>
Serial Number: <u>42016-12772-372</u>	Span Gas Range: <u>0-25</u>
Test Method: <u>7E</u>	Train Length: <u>~100'</u>
<u>Upscale Response</u>	<u>Downscale Response</u>
1. <u>88</u> seconds	1. <u>87</u> seconds
2. <u>86</u> seconds	2. <u>84</u> seconds
3. <u>87</u> seconds	3. <u>86</u> seconds
Avg. <u>87</u> seconds	Avg. <u>85</u> seconds
SYSTEM RESPONSE TIME: <u>87</u> SECONDS (slower average time)	

CT2-2

Train 2	
Analyzer Type: <u>Thermo 420L</u>	Gas Concentration: <u>~95 ppm</u>
Serial Number: <u>70442-365</u>	Span Gas Range: <u>0-250</u>
Test Method: <u>7E</u>	Train Length: <u>~100</u>
<u>Upscale Response</u>	<u>Downscale Response</u>
1. <u>89</u> seconds	1. <u>90</u> seconds
2. <u>88</u> seconds	2. <u>90</u> seconds
3. <u>89</u> seconds	3. <u>89</u> seconds
Avg. <u>89</u> seconds	Avg. <u>90</u> seconds
SYSTEM RESPONSE TIME: <u>90</u> SECONDS (slower average time)	

Method 20 procedure:

With a stable zero reading on the analyzer, switch to stack and time until stable. Record this as the upscale response and repeat twice again. With a stable high cal gas reading, switch to stack and time until stable. Record this as the downscale response and repeat twice again.

Methods 6c and 7e procedure:

The response time is determined by switching between the zero and the upscale cal gas and noting the longer time it takes to achieve a stable reading.

Method 10 procedure:

The time to achieve 90% response after an increase (rise time) or decrease (fall time) in the inlet concentration.

Method 25a procedure:

The time from a step change in pollutant at the inlet to the measurement system until 95% of the final value is displayed on the recorder.

**COASTAL AIR CONSULTING, INC.**

Plant: FPL / PPN  
Unit: GT 2-2

Test Date: 12/23/2013  
Check Date: 12/22/2013

**NO<sub>2</sub> to NO Converter Efficiency Check**

Analyzer : Thermo 42CL		NO <sub>2</sub> Audit Gas Value (C <sub>v</sub> ):	45.2
Serial Number: 70442-365		NO Calibration Gas Value:	46.4
Method: 7E			
<u>Date &amp; Time</u>	<u>NOx ppm</u>		
12/22/2013 11:03	0.00	zero gas	NO <sub>2</sub> to NO Conversion Efficiency Test using Equation 7E-7
12/22/2013 10:08	46.60	span gas	
			$\text{Eff NO}_2 = \frac{C_{\text{Dir}}}{C_v} \times 100$
12/22/2013 11:10	44.00		
12/22/2013 11:11	43.90		
			Eff NO <sub>2</sub> = 97.2
AVERAGE	43.95	(C <sub>Dir</sub> )	

**Method 7E NO<sub>2</sub> to NO Conversion Efficiency Test**

8.2.4.1. Introduce NO<sub>2</sub> converter efficiency gas to the analyzer in direct calibration mode and record the NOx concentration displayed by the analyzer. Calculate the converter efficiency using Equation 7E-7 in Section 12.7. The specification for converter efficiency in Section 13.5 must be met. The NO<sub>2</sub> to NO conversion efficiency, calculated according to Equation 7E-7, must be greater than or equal to 90 percent.

Eff NO<sub>2</sub> = NO<sub>2</sub> to NO converter efficiency, percent.

C<sub>Dir</sub> = Measured concentration of a calibration gas when introduced in direct calibration mode, ppmv.

C<sub>v</sub> = Manufacturer certified concentration of a calibration gas, ppmv.

**APPENDIX 4  
SAMPLE CALCULATIONS**

**SAMPLE EQUATIONS  
FOR CEMS RELATIVE ACCURACY TEST AUDITS**

CALCULATIONS FOR FLUE GAS VOLUME AND MOISTURE

Time	Dry Gas	Pitot	Orifice	Dry Gas	Flue Gas	Stack
	Meter Ft <sup>3</sup>	$\Delta P$ In. H <sub>2</sub> O	$\Delta H$ In. H <sub>2</sub> O	Temp. °F In Out	Static Pressure In. H <sub>2</sub> O	
T	V <sub>m</sub>	$\Delta p$	$\Delta H$	TMI TMO	P <sub>g</sub>	t <sub>s</sub>

1. P<sub>bar</sub> = Barometric Pressure (in. Hg)
2. TT = Net Sampling Time (minutes)
3. V<sub>m</sub> = V<sub>m</sub> Final - V<sub>m</sub> Initial = Sample Gas Volume (Ft<sup>3</sup>)
4. T<sub>m</sub> = Average Dry Gas Temperature at Meter (°F)

$$T_m = \frac{Avg. TMI + Avg. TMO}{2}$$

5.  $\Delta p$  = Velocity head of stack gas (in. H<sub>2</sub>O)
6.  $\Delta H$  = Average Orifice Pressure Drop (in. H<sub>2</sub>O)
7. Volume of dry gas sampled at standard conditions<sup>a</sup> (DSCF)

$$V_{m(std)} = \frac{(17.64)(V_m)(Y) \left( P_{bar} + \frac{\Delta H}{13.6} \right)}{(T_m + 460)}$$

8. V<sub>l<sub>o</sub></sub> = Total Water Collected = gm H<sub>2</sub>O Silica gel + ml Imp. H<sub>2</sub>O = ml
9. Volume of water vapor at standard conditions<sup>b</sup> (SCF)

$$V_{v(std)} = 0.0471(V_{lc}) = SCF$$

10. Percent moisture in flue gas

$$\%M = \frac{100(V_{w(std)})}{V_{m(std)} + V_{w(std)}}$$

11. Mole fraction of water vapor in flue gas

$$B_{ws} = \frac{\%M}{100}$$

12. Molecular Weight of dry flue gas

$$M_d = 0.44(\%CO_2) + 0.32(\%O_2) + 0.28(\%N_2 + \%CO)$$

13. Molecular weight of wet flue gas

$$M_s = M_d(1 - B_{ws}) + 18(B_{ws})$$

14. A = Cross-sectional area of stack (Ft<sup>2</sup>)

$$\frac{\pi r^2}{144}$$

15. P<sub>s</sub> = Flue gas pressure (in, Hg)

$$P_s = P_{bar} + P_g$$

NOTE: 
$$P_g(Hg) = \frac{P_g(in. H_2O)}{13.6}$$

16. T<sub>s</sub> = Absolute stack temperature (°R)

$$T_s = 460 + t_s$$

17. Flue velocity at stack conditions (FT/SEC)

$$V_s = (K_p)(C_p) \left[ (\sqrt{\Delta p})_{avg} \right] \sqrt{\frac{T_s(avg)}{P_s * M_s}}$$

C<sub>p</sub> = pitot tube coefficient

K<sub>p</sub> = pitot tube constant = 85.49ft/sec

18. Flue gas volumetric flow rate at standard conditions<sup>b</sup> (SCFM)

$$Q_s = (V_s)(A) \left( \frac{528}{T_s(\text{avg.})} \right) \left( \frac{P_s}{29.92} \right) (60)$$

19. Flue gas volumetric flow rate at standard conditions<sup>c</sup> (DSCFM)

$$Q_{sd} = (1 - B_{ws})(V_s)(A) \left( \frac{528}{T_s(\text{avg.})} \right) \left( \frac{P_s}{29.92} \right) (60)$$

20. Flue gas volumetric flow rate at stack conditions (ACFM)

$$Q_a = (V_s)(A)(60)$$

NOTES:

<sup>a</sup>Dry standard cubic feet at 68°F, 29.92 in. Hg

<sup>b</sup>Standard conditions at 68°F, 29.92 in. Hg

<sup>c</sup>Dry standard cubic feet per minute at 68°F, 29.92 in. Hg

## F-FACTOR DETERMINATION

### THE WET F-FACTOR ( $F_w$ ):

Includes all components of combustion

$$F_w = \frac{10^6 \text{ Btu / mmBtu} [5.57(\%H) + 1.53(\%C) + 0.57(\%S) + 0.14(\%N) - 0.46(\%O_2) + 0.21(\%H_2O)]}{GCV_{wet}}$$

### THE DRY F-FACTOR ( $F_d$ ):

Includes all components of combustion less water

$$F_d = \frac{10^6 \text{ Btu / mmBtu} [3.64(\%H) + 1.53(\%C) + 0.57(\%S) + 0.14(\%N) - 0.46(\%O_2)]}{GCV_{dry}}$$

### THE CARBON F-FACTOR ( $F_c$ ):

Includes only Carbon Dioxide

$$F_c = \frac{10^6 \text{ Btu / mmBtu} [0.321(\%C)]}{GCV_{dry}}$$

References for the above equations (i.e. %H, %C, %N, %S, %O<sub>2</sub>) can be found in 40 CFR Part 60, Appendix A, Method 19.



## LBS/MMBTU CALCULATIONS USING THE F-FACTOR

### 1. EMISSION RATE $E(\text{lb}/\text{mmbtu})$ , $O_2$ based

$$E(\text{lb}/\text{mmbtu}) = C \times F_d \left( \frac{20.9}{20.9 - \%O_2} \right)$$

**Where:**

$C(\text{lb}/\text{dscf})$  = Pollutant concentration (ppm) x conversion factor.

**Conversion Factors:**

$$\text{NOx} = 1.194 \times 10^{-7}$$

$$\text{SO}_2 = 1.660 \times 10^{-7}$$

$$\text{CO} = 7.274 \times 10^{-8}$$

$$\text{C}_3\text{H}_8 = 1.145 \times 10^{-7}$$

$F_d(\text{dscf}/\text{mmbtu})$  = "F" Factor for fuel type, (Ref. EPA Method 19)

$$F_d(\text{Coal}) = 9780$$

$$F_d(\text{Gas}) = 8710$$

$$F_d(\text{Oil}) = 9190$$

### 2. EMISSION RATE $E(\text{lb}/\text{mmbtu})$ , $CO_2$ based

$$E(\text{lb}/\text{mmbtu}) = C \times F_c \left( \frac{100}{\%CO_2} \right)$$

**Where:**

$C(\text{lb}/\text{dscf})$  = Pollutant concentration (ppm) x conversion factor.

**Conversion Factors:**

$$\text{NOx} = 1.194 \times 10^{-7}$$

$$\text{SO}_2 = 1.660 \times 10^{-7}$$

$$\text{CO} = 7.274 \times 10^{-8}$$

$$\text{C}_3\text{H}_8 = 1.145 \times 10^{-7}$$

$F_c(\text{dscf}/\text{mmbtu})$  = "F" Factor for fuel type, (Ref. EPA Method 19)

$$F_c(\text{Coal}) = 1800$$

$$F_c(\text{Gas}) = 1040$$

$$F_c(\text{Oil}) = 1420$$

## CALCULATION FOR GAS CONCENTRATION

GAS CONCENTRATION ( $C_{gas}$ )

$$C_{gas} = (\bar{C} - C_0) \left( \frac{C_{ma}}{C_m - C_0} \right)$$

- $C_{gas}$  = Effluent gas concentration, ppm  
 $\bar{C}$  = Average gas concentration indicated by gas analyzer, dry basis, ppm  
 $C_0$  = Average of initial and final system calibration bias check responses for the zero gas, ppm  
 $C_m$  = Average of initial and final system calibration bias check responses for the upscale calibration gas, ppm  
 $C_{ma}$  = Actual concentration of the upscale calibration gas, ppm

GAS CONCENTRATION @ 15% O<sub>2</sub> ( $C_{gas} @ 15\% O_2$ )

$$C_{gas} @ 15\% O_2 = C_{gas} * ((20.9-15)/(20.9-\%O_2))$$

GAS CONCENTRATION @ 7% O<sub>2</sub> ( $C_{gas} @ 7\% O_2$ )

$$C_{gas} @ 7\% O_2 = C_{gas} * ((20.9-7)/(20.9-\%O_2))$$

## CALCULATION OF RELATIVE ACCURACY

ARITHMETIC MEAN (OF THE DIFFERENCE, {d}, OF A DATA SET)

$$\bar{d} = \frac{1}{n} \sum_{i=1}^n d_i$$

Where n = Number of data points.

ALGEBRAIC SUM (OF THE INDIVIDUAL DIFFERENCES, {d<sub>i</sub>})

$$\sum_{i=1}^n d_i$$

STANDARD DEVIATION, S<sub>d</sub>

$$S_d = \sqrt{\frac{\sum_{i=1}^n d_i^2 - \frac{\left(\sum_{i=1}^n d_i\right)^2}{n}}{n-1}}$$

CONFIDENCE COEFFICIENT, CC

$$CC = t_{0.975} \frac{S_d}{\sqrt{n}}$$

For 9 tests  $t_{0.975} = 2.306$

For 10 tests  $t_{0.975} = 2.262$

For 11 tests  $t_{0.975} = 2.228$

For 12 tests  $t_{0.975} = 2.201$

RELATIVE ACCURACY, RA

$$RA = \frac{|\bar{d}| + |CC|}{RM} \times 100$$

**APPENDIX 5  
FIGURES**

FLORIDA POWER & LIGHT CO.  
PUTNAM PLANT

STACK SPECIFICATIONS

STACK DEPTH: 12 ft.  
SAMPLING PORT DEPTH: 4 in.  
No. OF PORTS: 1  
No. OF POINTS PER TRAVERSE: 3  
TOTAL No. OF POINTS: 3  
SAMPLING TIME PER POINT: 7 min.  
TOTAL SAMPLING TIME: 21 min.  
NOTE: DRAWING IS NOT TO SCALE

TYPICAL STACK DIAGRAM

PROBE DIAGRAM

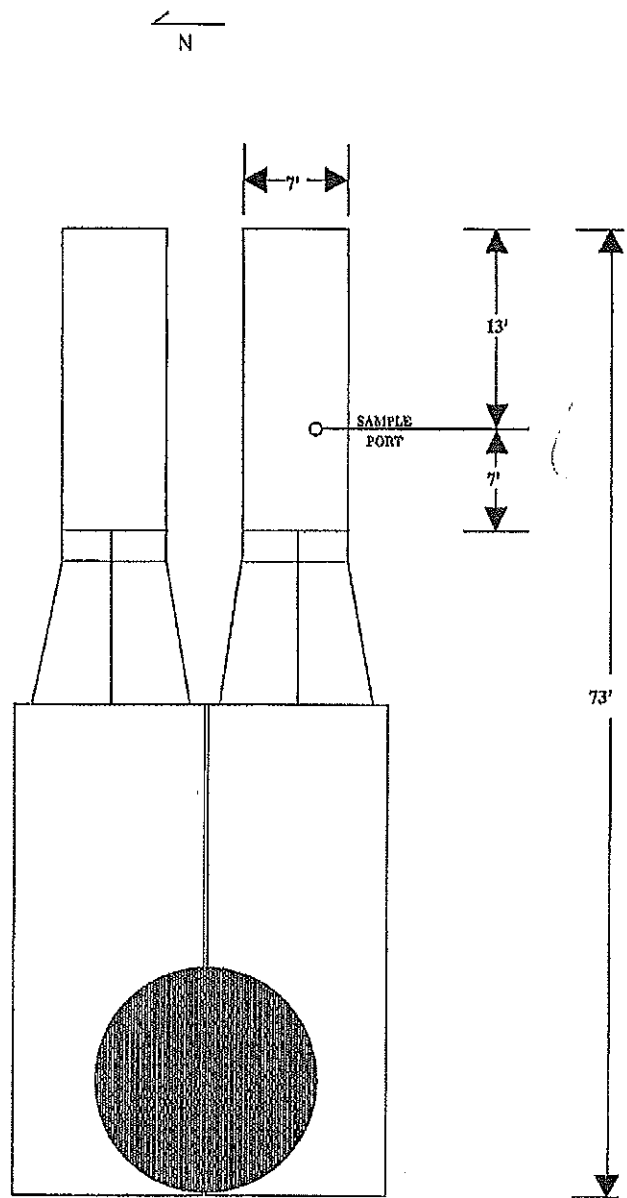
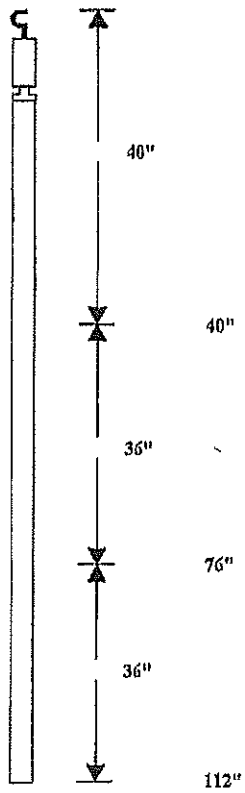

FILE: STACKPFN

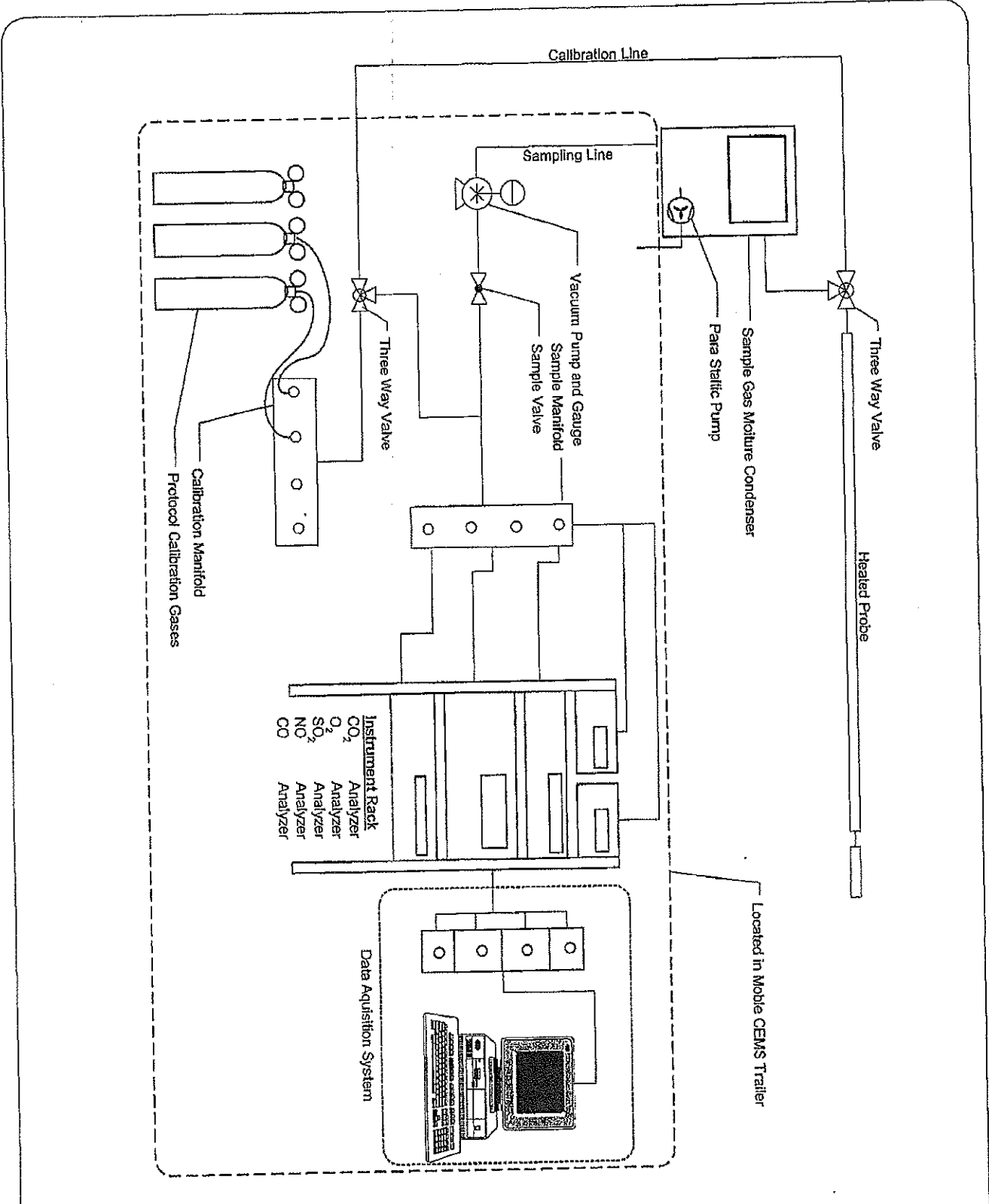

DRAWN BY R F Cobb		TITLE EPA Instrumental Sample Train
DATE 4/16/02	SCALE NONE	DESCRIPTION Sample Train Schematic

**Coastal Air Consulting, Inc**  
 1531 Wyngate Drive, Deland FL  
 (386) 943-8241 Fax (386) 943 9212

**APPENDIX 6**  
**QSTI**

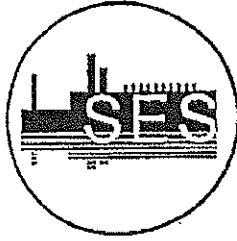

# Source Evaluation Society

P. O. Box 12124  
Research Triangle Park  
North Carolina 27709

May 1, 2012

Stephen C. Webb  
Coastal Air Consulting  
1531 Wyngate Dr.  
DeLand, FL 32724

Subject: Qualified Source Tester Application No. 2012-670  
**Qualification Notice - Manual Gas Volume Measurements and  
Isokinetic Particulate Sampling Methods**  
- Manual Gaseous Pollutants Source Sampling Methods  
- Gaseous Pollutants Instrumental Sampling Methods  
- Hazardous Metals Measurement Sampling Methods

Dear Mr. Webb:

It is my pleasure to inform you that you have satisfied the requirements of the Source Evaluation Society Qualified Source Test Individual program for group exam(s) listed above. As a member of the successful candidates in this SES program, you should be proud of this distinction within the source emissions testing community. I am confident that you will continue to uphold the standards of technical excellence and ethical conduct embodied in the SES mission statement.

The enclosed Qualification Notice(s) and SES identification card are your permanent record of this achievement. This status is valid for the period shown on the Qualification Notices.

Congratulations on your achievement and I wish you continued success in your future endeavors. Please see attached a permission letter if you wish to have your information posted on the SES web site.

Sincerely yours,

Peter R. Westlin  
SES QSTI/QSTO Review Committee Chairman

cc: Roy Owens, SES QSTI/QSTO Review Board Member  
Glenn England, SES QSTI/QSTO Review Board Member  
C. David Bagwell, SES QSTI/QSTO Review Board Member  
Karen D. Kajiya-Mills, SES QSTI/QSTO Review Board Member  
Peter S. Pakalnis, SES QSTI/QSTO Review Board Member  
Gail Westlin, SES QSTI/QSTO Review Committee Administrator



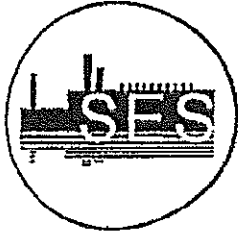

# Source Evaluation Society

P. O. Box 12124  
 Research Triangle Park  
 North Carolina 27709

An idea was introduced at the 2006 SSSAAP conference to list those individuals who have received their QSTI qualification approvals on the SES web site. The SES Board of Directors determined that individuals would have to approve in writing before making public such information. The QSTI Committee would like your permission to post the information shown below on the SES web site for public view. This information will be provided on the website as a link to an Excel spreadsheet. Your information will be listed as below or with any changes you indicate:

Name	Stephen C. Webb		
Company	Coastal Air Consulting		
City/State/Zip:	DeLand, FL 32724		
Contact Info.:	Coastalair123@aol.com		
Any Addit. Info:	qstiprogram@gmail.com		
Passed:	Group 1	Exam Date: 5/5/11	Valid From - To: 2012/05/01 to 2017/04/30
	Group 2	Exam Date: 5/5/11	Valid From - To: 2012/05/01 to 2017/04/30
	Group 3	Exam Date: 5/6/11	Valid From - To: 2012/05/01 to 2017/04/30
	Group 4	Exam Date: 5/6/11	Valid From - To: 2012/05/01 to 2017/04/30
QSTI Certificate #:	2012-670		

You may view the current spreadsheet format at the SES website at [www.sesnews.org](http://www.sesnews.org). If you agree to your name and information being posted, please sign below and fax this page to Gail Westlin at 919-572-2203 or email to [gail\\_westlin@yahoo.com](mailto:gail_westlin@yahoo.com). Also, if you wish to have your contact information listed other than your email address, please note any changes above (e.g., an address, telephone or a cell phone number, etc.). Any further changes or additions will need to be made in writing and emailed to Gail Westlin at [gail\\_westlin@yahoo.com](mailto:gail_westlin@yahoo.com). If you have any questions concerning this matter, please contact the SES QSTI/QSTO Review Committee Chairman, Peter Westlin, at [westlin.peter@epa.gov](mailto:westlin.peter@epa.gov) or myself.

Thank you,

Gail Westlin  
 SES QSTI/QSTO Review Committee Administrator

*I give the SES QSTI/QSTO Review Committee approval to have my name and information as outlined above to be posted on the SES web site. Any changes have been noted above. This approval extends to any future exams for which I receive a QSTI or QSTO Qualification Approval(s).*

Signature: \_\_\_\_\_ Date: \_\_\_\_\_

**NEW. DO YOU APPROVE SES RELEASING INFORMATION, UPON REQUEST, ABOUT WHETHER YOU HAVE PASSED A METHOD GROUP EXAM? (The information released will be if you passed an exam and the date of the exam. This information is in support of ASTM D-7036-D.) YES  NO  IF YOU AGREE, PLEASE SIGN BELOW.**

Signature: \_\_\_\_\_ Date: \_\_\_\_\_

# SOURCE EVALUATION SOCIETY



## Qualified Source Testing Individual

LET IT BE KNOWN THAT

**STEPHEN C. WEBB**

HAS SUCCESSFULLY PASSED A COMPREHENSIVE EXAMINATION AND SATISFIED EXPERIENCE REQUIREMENTS IN ACCORDANCE WITH THE GUIDELINES ISSUED BY THE SES QUALIFIED SOURCE TEST INDIVIDUAL REVIEW BOARD FOR

### MANUAL GAS VOLUME MEASUREMENTS AND ISOKINETIC PARTICULATE SAMPLING METHODS

ISSUED THIS 1<sup>st</sup> DAY OF MAY 2012 AND EFFECTIVE UNTIL APRIL 30<sup>th</sup>, 2017

  
Peter R. Westlin, QSTVQSTO Review Board

  
Peter S. Pakalnis, QSTVQSTO Review Board

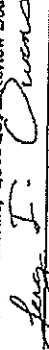
  
Greg F. Owens, QSTVQSTO Review Board

  
C. David Bagweff, QSTVQSTO Review Board

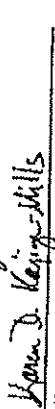
  
Karen D. Kofjya-Mills, QSTVQSTO Review Board

  
Glenn C. England, QSTVQSTO Review Board

APPLICATION  
NO.  
2012-670

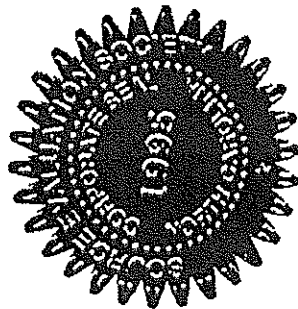

# SOURCE EVALUATION SOCIETY



## Qualified Source Testing Individual

LET IT BE KNOWN THAT

**STEPHEN C. WEBB**

HAS SUCCESSFULLY PASSED A COMPREHENSIVE EXAMINATION AND SATISFIED EXPERIENCE REQUIREMENTS IN ACCORDANCE WITH THE GUIDELINES ISSUED BY THE SES QUALIFIED SOURCE TEST INDIVIDUAL REVIEW BOARD FOR

### MANUAL GASEOUS POLLUTANTS SOURCE SAMPLING METHODS

ISSUED THIS 1<sup>ST</sup> DAY OF MAY 2012 AND EFFECTIVE UNTIL APRIL 30<sup>TH</sup>, 2017

A handwritten signature in black ink, appearing to read 'Peter R. Westlin'.

Peter R. Westlin, QST/QSTO Review Board

A handwritten signature in black ink, appearing to read 'Peter S. Pakamnis'.

Peter S. Pakamnis, QST/QSTO Review Board

A handwritten signature in black ink, appearing to read 'Gary F. Owens'.

Gary F. Owens, QST/QSTO Review Board

A handwritten signature in black ink, appearing to read 'C. David Bagwey'.

C. David Bagwey, QST/QSTO Review Board

A handwritten signature in black ink, appearing to read 'Karen D. Kallya-Mills'.

Karen D. Kallya-Mills, QST/QSTO Review Board

A handwritten signature in black ink, appearing to read 'Glenn C. England'.

Glenn C. England, QST/QSTO Review Board

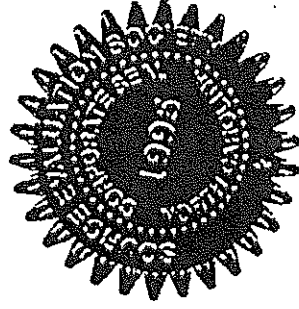

# SOURCE EVALUATION SOCIETY



## Qualified Source Testing Individual

LET IT BE KNOWN THAT

**STEPHEN C. WEBB**

HAS SUCCESSFULLY PASSED A COMPREHENSIVE EXAMINATION AND SATISFIED EXPERIENCE REQUIREMENTS IN ACCORDANCE WITH THE GUIDELINES ISSUED BY THE SES QUALIFIED SOURCE TEST INDIVIDUAL REVIEW BOARD FOR

**GASEOUS POLLUTANTS INSTRUMENTAL SAMPLING METHODS**

ISSUED THIS 1<sup>st</sup> DAY OF MAY 2012 AND EFFECTIVE UNTIL APRIL 30<sup>th</sup>, 2017

A handwritten signature in black ink, appearing to read 'Peter R. Westfall'.

Peter R. Westfall, QST/QSTO Review Board

A handwritten signature in black ink, appearing to read 'Peter S. Pakalnis'.

Peter S. Pakalnis, QST/QSTO Review Board

A handwritten signature in black ink, appearing to read 'Greg F. Owens'.

Greg F. Owens, QST/QSTO Review Board

A handwritten signature in black ink, appearing to read 'C. David Bagweiff'.

C. David Bagweiff, QST/QSTO Review Board

A handwritten signature in black ink, appearing to read 'Karen D. Kajiye-Mills'.

Karen D. Kajiye-Mills, QST/QSTO Review Board

A handwritten signature in black ink, appearing to read 'Glenn C. England'.

Glenn C. England, QST/QSTO Review Board

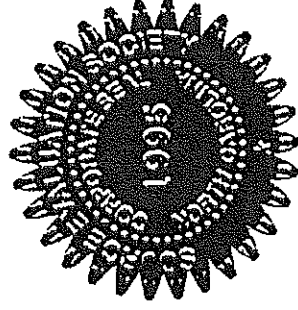

# SOURCE EVALUATION SOCIETY



## Qualified Source Testing Individual

LET IT BE KNOWN THAT

**STEPHEN C. WEBB**

HAS SUCCESSFULLY PASSED A COMPREHENSIVE EXAMINATION AND SATISFIED EXPERIENCE REQUIREMENTS IN ACCORDANCE WITH THE GUIDELINES ISSUED BY THE SES QUALIFIED SOURCE TEST INDIVIDUAL REVIEW BOARD FOR

**HAZARDOUS METALS MEASUREMENT SAMPLING METHODS**

ISSUED THIS 1<sup>st</sup> DAY OF MAY 2012 AND EFFECTIVE UNTIL APRIL 30<sup>th</sup>, 2017



Peter R. Wustlin, QST/QSTO Review Board



Peter S. Paikalis, QST/QSTO Review Board

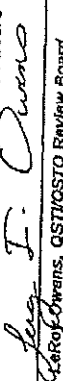

LeRoy Owens, QST/QSTO Review Board



C. David Bagwell, QST/QSTO Review Board

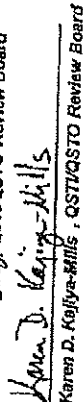

Karen D. Kojlya-Mills, QST/QSTO Review Board



Glenn C. England, QST/QSTO Review Board

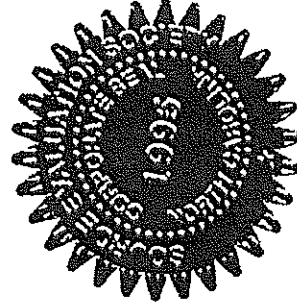

APPLICATION

NO.

2012-570

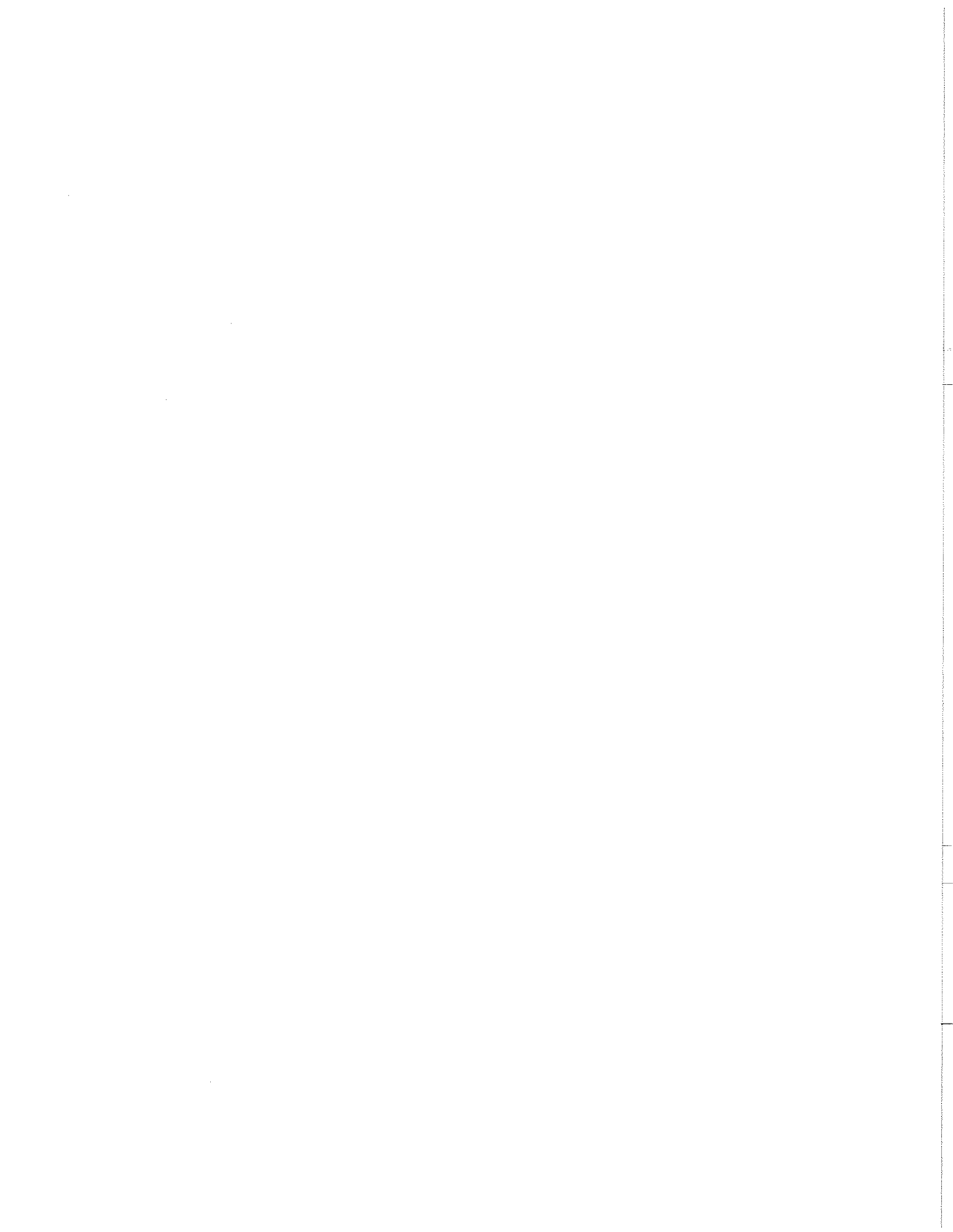



---

Inter-Office Correspondence

To: **Tammy Pratt** Date: **1/13/14**  
From: **John Schwartz** Department: **GPA - JB**  
Subject: **NOx / CO2 Linearity Check**  
**3rd Quarter 2013**  
**Putnam Power Plant**

*The Production Assurance Emission Test Group conducted the NOx & CO2 Linearity check at Putnam Power Plant unit 1-1/2-2 on November 21<sup>st</sup>, 2013. EPA Methods according to 40 CFR 75 Appendix A were used for accuracy determination.*

*A summary of the pertinent data and condition assessment of the CEM shelter is attached. Please file this report with your required CEMS documents. This report has a five-year retention requirement.*

*If you need any additional information please contact me at 579-7177.*

A handwritten signature in black ink, appearing to read "John Schwartz", written in a cursive style.

**John Schwartz**  
**Florida Power & Light**  
**Emission Technician**

Plant PAV

Unit 1-1/d-2

Date 11/21/13

### CT CEMS Condition Assessment Worksheet

	YES	NO
1. Was the control room notified prior to performing audit?	<input checked="" type="checkbox"/>	<input type="checkbox"/>
Comments _____		
2. Sample probe filter vacuum < - 7 in. HG?	<input checked="" type="checkbox"/>	<input type="checkbox"/>
Comments _____		
3. NOx and O2 analyzer sample pressure set at 3 psi?	<input checked="" type="checkbox"/>	<input type="checkbox"/>
Comments _____		
4. O2 analyzer calibration pressure at 15 psi?	<input checked="" type="checkbox"/>	<input type="checkbox"/>
Comments _____		
5. NOx sample flow rate at 1.8 LPM?	<input checked="" type="checkbox"/>	<input type="checkbox"/>
Comments _____		
6. O2 sample flow rate at 1.0 LPM?	<input checked="" type="checkbox"/>	<input type="checkbox"/>
Comments _____		
7. Calibration flow at 6 LPM?	<input checked="" type="checkbox"/>	<input type="checkbox"/>
Comments _____		
8. Are Span gas cylinders data entered correctly into the Netdahs?	<input checked="" type="checkbox"/>	<input type="checkbox"/>
Comments _____		
9. Are Span gas cylinders properly secured and pressures > 250 psi?	<input checked="" type="checkbox"/>	<input type="checkbox"/>
Comments _____		
10. Is plant calibration Zero/Span gas expired?	<input type="checkbox"/>	<input checked="" type="checkbox"/>
Comments _____		
11. Calibration span gas values (O2 & NOx) within analyzer range (85 to 90%)?	<input checked="" type="checkbox"/>	<input type="checkbox"/>
Comments _____		
12. Is the Zero/Span gas certification of analysis available?	<input checked="" type="checkbox"/>	<input type="checkbox"/>
Comments _____		
13. Does the Zero calibration gas meet Part 72 requirements? (CO<0.5ppm, CO2<1ppm, NOx<0.1ppm, SO2<0.1ppm, THC<0.1ppm)	<input checked="" type="checkbox"/>	<input type="checkbox"/>
Comments _____		



14. Are any alarm or out-of-control conditions shown on the DAHS summary screen?

Comments \_\_\_\_\_

15. Overall, is the outside of shed in good condition, inside free of dirt, debris and trash?

Comments \_\_\_\_\_

16. Is shed free of ozone odor?

Comments \_\_\_\_\_

17. On completion of LA, is regulator set between 18-20 psi (PFM) or 20-30 psi (PSN)?

Comments \_\_\_\_\_

**FLORIDA POWER & LIGHT  
CONTINUOUS EMISSION MONITORS  
LINEARITY CHECK WORKSHEET**

Plant PPN 1-1  
Unit 1-1 (Low Range)

Date 11/21/2013 Quarter 4th 2013  
Technician M. Crosby

NOx ANALYZER
Manufacturer <u>TECO</u>
Serial # <u>42C-77257-385</u>
Span Setting <u>0 - 100 ppm</u>
Component ID <u>A02</u>
Monitoring Sys. ID <u>102</u>
Unit/Stack ID <u>PPN 1-1</u>

	Time (EST)	Reference Value	Monitor Value	PPM Difference	Linearity Error	PROTOCOL 1 TANK SERIAL #	Pass/Fail
Low	1545	50.00	51.90	1.90	5%		
	1615	50.00	50.60	0.60		ALM009787	
	1641	50.00	50.90	0.90	2.3		PASS
Mid	1555	111.00	109.70	-1.30			
	1625	111.00	110.20	-0.80		ALM055501	
	1651	111.00	109.00	-2.00	1.2		PASS
High	1605	165.90	161.20	-4.70			
	1633	165.90	162.20	-3.70		CC162890	
	1701	165.90	162.10	-3.80	2.5		PASS

CO2 ANALYZER
Manufacturer <u>Cal inst.</u>
Serial # <u>U08067</u>
Span Setting <u>0 - 10 %</u>
Component ID <u>A03</u>
Monitoring Sys. ID <u>102</u>
Unit/Stack ID <u>PPN 1-1</u>

	Time (EST)	Reference Value	Monitor Value	PPM Difference	Linearity Error	PROTOCOL 1 TANK SERIAL #	Pass/Fail
Low	1545	2.52	2.63	0.11	5%		ALT
	1615	2.52	2.65	0.13		ALM009787	
	1641	2.52	2.67	0.15	5.2		0.13
Mid	1555	5.44	5.58	0.14			
	1625	5.44	5.61	0.17		ALM055501	
	1651	5.44	5.60	0.16	2.9		PASS
High	1605	8.51	8.66	0.15			
	1633	8.51	8.68	0.17		CC162890	
	1701	8.51	8.65	0.14	1.8		PASS

**FLORIDA POWER & LIGHT  
CONTINUOUS EMISSION MONITORS  
LINEARITY CHECK WORKSHEET**

Plant PPN  
Unit 1-1 (High Range)

Date 11/21/2013 Quarter 4th 2013  
Technician M. Crosby

NOx ANALYZER
Manufacturer <b>TECO</b>
Serial # <b>42C-77282-385</b>
Span Setting <b>0 - 500 ppm</b>
Component ID <b>A02</b>
Monitoring Sys. ID <b>102</b>
Unit/Stack ID <b>PFL4-1</b>

	Time (EST)	Reference Value	Monitor Value	PPM Difference	Linearity Error	PROTOCOL 1 TANK SERIAL #	Pass/Fail
Low	1716	125.90	126.90	1.00	5%		
	1744	125.90	128.80	2.90		ALM047577	
	1810	125.90	128.70	2.80	1.8		PASS
Mid	1724	277.00	278.40	1.40	0.7		
	1752	277.00	279.10	2.10		CC217297	
	1818	277.00	279.00	2.00			PASS
High	1734	427.00	428.10	1.10	0.3		
	1800	427.00	428.00	1.00		ALM021880	
	1826	427.00	428.20	1.20			PASS

**FLORIDA POWER & LIGHT  
CONTINUOUS EMISSION MONITORS  
LINEARITY CHECK WORKSHEET**

Plant PPN  
Unit 1-2 (Low Range)

Date 11/21/2013 Quarter 4th 2013  
Technician M. Crosby

NOx ANALYZER
Manufacturer <u>TECO</u>
Serial # <u>42C-77260-385</u>
Span Setting <u>0 - 100 ppm</u>
Component ID <u>A12</u>
Monitoring Sys. ID <u>112</u>
Unit/Stack ID <u>PPN 1-2</u>

	Time (EST)	Reference Value	Monitor Value	PPM Difference	Linearity Error	PROTOCOL 1 TANK SERIAL #	Pass/Fail
Low	1545	50.00	51.80	1.80	5%		
	1615	50.00	50.90	0.90		ALM009787	
	1641	50.00	51.10	1.10	2.5		PASS
Mid	1555	111.00	109.00	-2.00			
	1625	111.00	109.40	-1.60		ALM055501	
	1651	111.00	108.70	-2.30	1.8		PASS
High	1605	165.90	160.80	-5.10			
	1633	165.90	162.10	-3.80		CC162690	
	1701	165.90	162.10	-3.80	2.6		PASS

CO2 ANALYZER
Manufacturer <u>Cal Inst.</u>
Serial # <u>U08066</u>
Span Setting <u>0 - 10 %</u>
Component ID <u>A13</u>
Monitoring Sys. ID <u>112</u>
Unit/Stack ID <u>PPN 1-2</u>

	Time (EST)	Reference Value	Monitor Value	PPM Difference	Linearity Error	PROTOCOL 1 TANK SERIAL #	Pass/Fail
Low	1545	2.52	2.60	0.08	5%		
	1615	2.52	2.63	0.11		ALM009787	
	1641	2.52	2.66	0.14	4.4		PASS
Mid	1555	5.44	5.51	0.07			
	1625	5.44	5.56	0.12		ALM055501	
	1651	5.44	5.55	0.11	1.8		PASS
High	1605	8.51	8.59	0.08			
	1633	8.51	8.58	0.07		CC162690	
	1701	8.51	8.56	0.05	0.8		PASS

FLORIDA POWER & LIGHT  
CONTINUOUS EMISSION MONITORS  
LINEARITY CHECK WORKSHEET

Plant PPN  
Unit 1-2 (High Range)

Date 11/21/2013 Quarter 4th 2013  
Technician M. Crosby

NOx ANALYZER
Manufacturer <u>TECO</u>
Serial # <u>42C-77263-385</u>
Span Setting <u>0 - 500 ppm</u>
Component ID <u>A12</u>
Monitoring Sys. ID <u>112</u>
Unit/Stack ID <u>PFL4-2</u>

	Time (EST)	Reference Value	Monitor Value	PPM Difference	Linearity Error	PROTOCOL 1 TANK SERIAL #	Pass/Fail
Low	1716	125.90	127.00	1.10	5%		
	1744	125.90	129.20	3.30		ALM047577	
	1155	125.90	129.10	3.20	2.0		PASS
Mid	1724	277.00	278.00	1.00			
	1752	277.00	278.30	1.30		CC217297	
	1818	277.00	278.90	1.90	0.5		PASS
High	1734	427.00	427.70	0.70			
	1800	427.00	427.70	0.70		ALM021880	
	1826	427.00	428.30	1.30	0.2		PASS

FLORIDA POWER & LIGHT  
CONTINUOUS EMISSION MONITORS  
LINEARITY CHECK WORKSHEET

Plant PPN  
Unit 2-1 (High Range)

Date 11/21/2013 Quarter 4th 2013  
Technician M. Crosby

NOx ANALYZER
Manufacturer <u>TECO</u>
Serial # <u>42C-77264-385</u>
Span Setting <u>0 - 500 ppm</u>
Component ID <u>A02</u>
Monitoring Sys. ID <u>102</u>
Unit/Stack ID <u>PFL5-1</u>

	Time (EST)	Reference Value	Monitor Value	PPM Difference	Linearity Error	PROTOCOL 1 TANK SERIAL #	Pass/Fail
Low	1716	125.90	128.80	2.90	5%		
	1744	125.90	130.80	4.90		ALM047577	
	1810	125.90	131.00	5.10	3.4		PASS
Mid	1724	277.00	280.90	3.90			
	1752	277.00	281.90	4.90		CC217297	
	1818	277.00	282.50	5.50	1.7		PASS
High	1734	427.00	430.60	3.60			
	1800	427.00	431.60	4.60		ALM021880	
	1826	427.00	433.00	6.00	1.1		PASS

**FLORIDA POWER & LIGHT  
CONTINUOUS EMISSION MONITORS  
LINEARITY CHECK WORKSHEET**

Plant PPN  
Unit 2-1(Low Range)

Date 11/21/2013 Quarter 4th 2013  
Technician M. Crosby

NOx ANALYZER
Manufacturer <b>TECO</b>
Serial # <b>42C-77257-385</b>
Span Setting <b>0 - 100 ppm</b>
Component ID <b>A02</b>
Monitoring Sys. ID <b>102</b>
Unit/Stack ID <b>PPN 2-1</b>

	Time (EST)	Reference Value	Monitor Value	PPM Difference	Linearity Error	PROTOCOL 1 TANK SERIAL #	Pass/Fail
Low	1545	50.00	51.80	1.80	5%		
	1615	50.00	51.30	1.30		ALM009787	
	1641	50.00	51.60	1.60	3.1		PASS
Mid	1555	111.00	108.50	-2.50			
	1625	111.00	110.00	-1.00		ALM055501	
	1651	111.00	109.40	-1.60	1.5		PASS
High	1605	165.90	159.20	-6.70			
	1633	165.90	162.10	-3.80		CC162690	
	1701	165.90	162.10	-3.80	2.9		PASS

CO2 ANALYZER
Manufacturer <b>Cal Inst.</b>
Serial # <b>U08067</b>
Span Setting <b>0 - 10 %</b>
Component ID <b>A03</b>
Monitoring Sys. ID <b>102</b>
Unit/Stack ID <b>PPN 2-1</b>

	Time (EST)	Reference Value	Monitor Value	PPM Difference	Linearity Error	PROTOCOL 1 TANK SERIAL #	Pass/Fail
Low	1545	2.52	2.60	0.08	5%		
	1615	2.52	2.62	0.10		ALM009787	
	1641	2.52	2.65	0.13	4.1		PASS
Mid	1555	5.44	5.46	0.02			
	1625	5.44	5.49	0.05		ALM055501	
	1651	5.44	5.49	0.05	0.7		PASS
High	1605	8.51	8.45	-0.06			
	1633	8.51	8.45	-0.06		CC162690	
	1701	8.51	8.43	-0.08	0.8		PASS

**FLORIDA POWER & LIGHT  
CONTINUOUS EMISSION MONITORS  
LINEARITY CHECK WORKSHEET**

Plant PPN  
Unit 2-2 (Low Range)

Date 11/21/2013 Quarter 4th 2013  
Technician M. Crosby

NOx
ANALYZER
Manufacturer <u>TECO</u>
Serial # <u>42C-77257-385</u>
Span Setting <u>0 - 100 ppm</u>
Component ID <u>A12</u>
Monitoring Sys. ID <u>112</u>
Unit/Stack ID <u>PPN 2-2</u>

	Time (EST)	Reference Value	Monitor Value	PPM Difference	Linearity Error	PROTOCOL 1 TANK SERIAL #	Pass/Fail
Low	1545	50.00	51.80	1.80	5%		
	1615	50.00	50.90	0.90		ALM009787	
	1641	50.00	51.00	1.00			PASS
Mid	1555	111.00	109.20	-1.80	1.5		
	1625	111.00	109.70	-1.30		ALM055501	
	1651	111.00	109.00	-2.00			PASS
High	1605	165.90	161.40	-4.50	2.2		
	1633	165.90	162.80	-3.10		CC162690	
	1701	165.90	162.70	-3.20			PASS

CO2
ANALYZER
Manufacturer <u>Cal Inst.</u>
Serial # <u>U08067</u>
Span Setting <u>0 - 10 %</u>
Component ID <u>A13</u>
Monitoring Sys. ID <u>112</u>
Unit/Stack ID <u>PPN 2-2</u>

	Time (EST)	Reference Value	Monitor Value	PPM Difference	Linearity Error	PROTOCOL 1 TANK SERIAL #	Pass/Fail
Low	1545	2.52	2.64	0.12	5%		ALT
	1615	2.52	2.68	0.16		ALM009787	
	1641	2.52	2.69	0.17			0.15
Mid	1555	5.44	5.55	0.11	2.3		
	1625	5.44	5.58	0.14		ALM055501	
	1651	5.44	5.57	0.13			PASS
High	1605	8.51	8.60	0.09	1.0		
	1633	8.51	8.59	0.08		CC162690	
	1701	8.51	8.59	0.08			PASS



**FLORIDA POWER & LIGHT  
CONTINUOUS EMISSION MONITORS  
LINEARITY CHECK WORKSHEET**

Plant PPN  
Unit 2-2 (High Range)

Date 11/21/2013 Quarter 4th 2013  
Technician M. Crosby

NOx
ANALYZER
Manufacturer <u>TECO</u>
Serial # <u>42C-77281-385</u>
Span Setting <u>0 - 500 ppm</u>
Component ID <u>A12</u>
Monitoring Sys. ID <u>112</u>
Unit/Stack ID <u>PFLS-2</u>

	Time (EST)	Reference Value	Monitor Value	PPM Difference	Linearity Error	PROTOCOL 1 TANK SERIAL #	Pass/Fail
Low	1716	125.90	129.30	3.40	5%		
	1744	125.90	131.40	5.50		ALM047577	
	1810	125.90	131.40	5.50	3.8		PASS
Mid	1724	277.00	283.30	6.30			
	1752	277.00	283.60	6.60		CC217297	
	1818	277.00	284.00	7.00	2.4		PASS
High	1734	427.00	435.10	8.10			
	1800	427.00	435.60	8.60		ALM021880	
	1825	427.00	436.40	9.40	2.0		PASS



**AIR LIQUIDE** Air Liquide America  
Specialty Gases LLC



**RATA CLASS**

*Dual-Analyzed Calibration Standard*

6141 EASTON ROAD, BLDG 1, PLUMSTEADVILLE, PA 18949-0310 Phone: 800-331-4953 Fax: 215-766-7226

**CERTIFICATE OF ACCURACY: Interference Free™ Multi-Component EPA Protocol Gas**

Assay Laboratory - PGVP Vendor ID: A12013

AIR LIQUIDE AMERICA SPECIALTY GASES LLC  
6141 EASTON ROAD, BLDG 1  
PLUMSTEADVILLE, PA 18949-0310

P.O. No.: CEM-6035  
Document #: 50359355-001

Customer  
FLORIDA P&L-MARTIN PLT-PO#-CEM ONLY

21900 SW WARFIELD BLVD  
INDIANTOWN FL 34956  
US

**ANALYTICAL INFORMATION Gas Type : CO2,NO,BALN**

This certification was performed according to EPA Traceability Protocol For Assay & Certification of Gaseous Calibration Standards; Procedure G-1; September, 1997.

Cylinder Number: ALM009787 Certification Date: 23Apr2013 Exp. Date: 24Apr2021  
Cylinder Pressure\*\*\*: 1909 PSIG Batch No: PLU0183415

COMPONENT	CERTIFIED CONCENTRATION (Moles)	ACCURACY**	TRACEABILITY
NITRIC OXIDE	50.0 PPM	+/- 1%	Direct NIST and VSL
CARBON DIOXIDE	2.52 %	+/- 1%	Direct NIST and VSL
NITROGEN - OXYGEN FREE	BALANCE		
TOTAL OXIDES OF NITROGEN	50.2 PPM		Reference Value Only

\*\*\* Do not use when cylinder pressure is below 150 psig.  
\*\* Analytical accuracy is based on the requirements of EPA Protocol Procedure G1, September 1997.

**REFERENCE STANDARD**

TYPE/SRM NO.	EXPIRATION DATE	CYLINDER NUMBER	CONCENTRATION	COMPONENT
NTRM 1683	24Jan2016	KAL004281	51.08 PPM	NITRIC OXIDE
NTRM 2622	01Jun2013	K021249	1.981 %	CARBON DIOXIDE

**INSTRUMENTATION**

INSTRUMENT/MODEL/SERIAL#	DATE LAST CALIBRATED	ANALYTICAL PRINCIPLE
FTIR/000928781	12Apr2013	FTIR
FTIR/000928781	05Apr2013	FTIR

**ANALYZER READINGS**

(Z=Zero Gas R=Reference Gas T=Test Gas r=Correlation Coefficient)

**First Triad Analysis**

**NITRIC OXIDE**

Date: 16Apr2013 Response Unit: PPM  
Z1 = -0.04598 R1 = 50.93932 T1 = 49.72871  
R2 = 50.94629 Z2 = 0.00508 T2 = 49.97945  
Z3 = 0.05727 T3 = 49.98433 R3 = 51.15660  
Avg. Concentration: 49.98 PPM

**Second Triad Analysis**

Date: 23Apr2013 Response Unit: PPM  
Z1 = -0.02228 R1 = 50.81367 T1 = 49.94285  
R2 = 51.11142 Z2 = 0.04689 T2 = 50.00216  
Z3 = 0.10309 T3 = 50.17814 R3 = 51.34905  
Avg. Concentration: 50.03 PPM

**Calibration Curve**

Concentration = A + Bx + Cx2 + Dx3 + Ex4  
r = 9.99995E-1  
Constants: A = 0.00000E+0  
B = 9.94179E-1 C = 1.04000E-4  
D = 0.00000E+0 E = 0.00000E+0

**CARBON DIOXIDE**

Date: 16Apr2013  
Z1 = 0.00000 R1 = 0.00000 T1 = 0.00000  
R2 = 0.00000 Z2 = 0.00000 T2 = 0.00000  
Z3 = 0.00000 T3 = 0.00000 R3 = 0.00000  
Avg. Concentration: 0.000

Date: 23Apr2013 Response Unit: %  
Z1 = 0.00005 R1 = 1.98007 T1 = 2.51544  
R2 = 1.98273 Z2 = 0.00139 T2 = 2.51756  
Z3 = 0.00271 T3 = 2.52085 R3 = 1.98297  
Avg. Concentration: 2.517 %

Concentration = A + Bx + Cx2 + Dx3 + Ex4  
r = 9.99996E-1  
Constants: A = 0.00000E+0  
B = 9.14718E-1 C = 1.18560E-2  
D = 1.00000E-6 E = 0.00000E+0

APPROVED BY:

*Michael A. Kuhns*  
Michael A. Kuhns

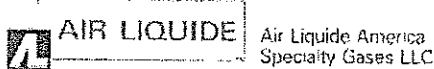

Air Liquide America  
Specialty Gases LLC

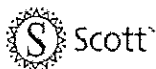

# RATA CLASS

Dual-Analyzed Calibration Standard

6141 EASTON ROAD, BLDG 1, PLUMSTEADVILLE, PA 18949-0310 Phone: 800-331-4953 Fax: 215-766-7226

## CERTIFICATE OF ACCURACY: Interference Free™ Multi-Component EPA Protocol Gas

Assay Laboratory - PGVP Vendor ID: A12013

AIR LIQUIDE AMERICA SPECIALTY GASES LLC  
6141 EASTON ROAD, BLDG 1  
PLUMSTEADVILLE, PA 18949-0310

P.O. No.: CEM-6035  
Document #: 50359355-002

Customer  
FLORIDA P&L-MARTIN PLT-PO#-CEM ONLY

21900 SW WARFIELD BLVD  
INDIANTOWN FL 34956  
US

### ANALYTICAL INFORMATION Gas Type : CO2,NO,BALN

This certification was performed according to EPA Traceability Protocol For Assay & Certification of Gaseous Calibration Standards; Procedure G-1; September, 1997.

Cylinder Number: ALM055501 Certification Date: 23Apr2013 Exp. Date: 24Apr2021  
Cylinder Pressure\*\*\*: 1936 PSIG Batch No: PLU0183538

COMPONENT	CERTIFIED CONCENTRATION (Moles)	ACCURACY**	TRACEABILITY
NITRIC OXIDE	111.0 PPM	+/- 1%	Direct NIST and VSL
CARBON DIOXIDE	5.44 %	+/- 1%	Direct NIST and VSL
NITROGEN - OXYGEN FREE	BALANCE		
TOTAL OXIDES OF NITROGEN	111.3 PPM		Reference Value Only

\*\*\* Do not use when cylinder pressure is below 150 psig.

\*\* Analytical accuracy is based on the requirements of EPA Protocol Procedure G1, September 1997.

### REFERENCE STANDARD

TYPE/SRM NO.	EXPIRATION DATE	CYLINDER NUMBER	CONCENTRATION	COMPONENT
NTRM 1684	22Jul2017	KAL003769	97.60 PPM	NITRIC OXIDE
NTRM 2000	01Jun2013	K026613	5.006 %	CARBON DIOXIDE

### INSTRUMENTATION

INSTRUMENT/MODEL/SERIAL#	DATE LAST CALIBRATED	ANALYTICAL PRINCIPLE
FTIR//000928781	12Apr2013	FTIR
FTIR//000928781	05Apr2013	FTIR

### ANALYZER READINGS

(Z = Zero Gas R = Reference Gas T = Test Gas r = Correlation Coefficient)

#### First Triad Analysis

##### NITRIC OXIDE

Date: 18Apr2013 Response Unit: PPM  
Z1 = -0.19394 R1 = 96.78066 T1 = 110.0391  
R2 = 96.99540 Z2 = -0.04826 T2 = 110.5641  
Z3 = 0.15300 T3 = 110.5722 R3 = 97.01015  
Avg. Concentration: 111.1 PPM

#### Second Triad Analysis

Date: 23Apr2013 Response Unit: PPM  
Z1 = -0.06013 R1 = 97.08241 T1 = 110.3603  
R2 = 97.22222 Z2 = 0.29407 T2 = 110.3625  
Z3 = 0.36922 T3 = 110.5288 R3 = 97.25808  
Avg. Concentration: 110.9 PPM

#### Calibration Curve

Concentration = A + Bx + Cx<sup>2</sup> + Dx<sup>3</sup> + Ex<sup>4</sup>  
r = 9.99999E-1  
Constants: A = 0.00000E+0  
B = 9.86844E-1 C = 4.60000E-5  
D = 0.00000E+0 E = 0.00000E+0

##### CARBON DIOXIDE

Date: 18Apr2013 Response Unit: %  
Z1 = -0.00102 R1 = 5.00111 T1 = 5.43543  
R2 = 5.01094 Z2 = -0.00055 T2 = 5.43978  
Z3 = 0.00012 T3 = 5.44217 R3 = 5.01384  
Avg. Concentration: 5.438 %

Concentration = A + Bx + Cx<sup>2</sup> + Dx<sup>3</sup> + Ex<sup>4</sup>  
r = 9.99998E-1  
Constants: A = 0.00000E+0  
B = 9.14718E-1 C = 1.18560E-2  
D = 1.00000E-6 E = 0.00000E+0

APPROVED BY:

Michael A. Kuhns



Air Liquide America  
Specialty Gases LLC

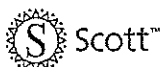

# RATA CLASS

Dual-Analyzed Calibration Standard

6141 EASTON ROAD, BLDG 1, PLUMSTEADVILLE, PA 18949-0310 Phone: 800-331-4953 Fax: 215-766-7226

## CERTIFICATE OF ACCURACY: Interference Free™ Multi-Component EPA Protocol Gas

Assay Laboratory - PGVP Vendor ID: A12013

AIR LIQUIDE AMERICA SPECIALTY GASES LLC  
6141 EASTON ROAD, BLDG 1  
PLUMSTEADVILLE, PA 18949-0310

P.O. No.: REPLENISHMENT  
Document #: 50179756-002

**Customer**

FLORIDA POWER & LIGHT - PUTNAM PLANT  
MIKE MITCHELL  
392 US HIGHWAY 17 SOUTH  
EAST PALATKA FL 32131  
US

### ANALYTICAL INFORMATION Gas Type : CO2,NO,BALN

This certification was performed according to EPA Traceability Protocol For Assay & Certification of Gaseous Calibration Standards; Procedure G-1; September, 1997.

Cylinder Number: CC162690 Certification Date: 17Apr2013 Exp. Date: 18Apr2021  
Cylinder Pressure\*\*\*: 2015 PSIG Batch No: PLU0181940

COMPONENT	CERTIFIED CONCENTRATION (Moles)	ACCURACY**	TRACEABILITY
CARBON DIOXIDE	8.51 %	+/- 1%	Direct NIST and VSL
NITRIC OXIDE	165.9 PPM	+/- 1%	Direct NIST and VSL
NITROGEN - OXYGEN FREE	BALANCE		
TOTAL OXIDES OF NITROGEN	167.2 PPM		Reference Value Only

\*\*\* Do not use when cylinder pressure is below 150 psig.

\*\* Analytical accuracy is based on the requirements of EPA Protocol Procedure G1, September 1997.

### REFERENCE STANDARD

TYPE/SRM NO.	EXPIRATION DATE	CYLINDER NUMBER	CONCENTRATION	COMPONENT
NTRM 1675 B	05Jan2018	K001453	13.94 %	CARBON DIOXIDE
NTRM 1685	04Jan2018	KAL004405	242.0 PPM	NITRIC OXIDE

### INSTRUMENTATION

INSTRUMENT/MODEL/SERIAL#	DATE LAST CALIBRATED	ANALYTICAL PRINCIPLE
FTIR//000928781	05Apr2013	FTIR
FTIR//000928781	12Apr2013	FTIR

### ANALYZER READINGS

(Z=Zero Gas R=Reference Gas T=Test Gas r=Correlation Coefficient)

#### First Triad Analysis

##### CARBON DIOXIDE

Date: 10Apr2013 Response Unit:%  
Z1=-0.00227 R1=13.82690 T1=8.44995  
R2=13.84768 Z2=0.00097 T2=8.45249  
Z3=0.00629 T3=8.45263 R3=13.86228  
Avg. Concentration: 8.508 %

#### Second Triad Analysis

##### NITRIC OXIDE

Date: 10Apr2013 Response Unit:PPM  
Z1=-0.35384 R1=240.4669 T1=164.6101  
R2=240.5530 Z2=0.02351 T2=165.1154  
Z3=0.42148 T3=165.1685 R3=240.7913  
Avg. Concentration: 165.9 PPM

Date: 17Apr2013 Response Unit: PPM  
Z1=-0.14362 R1=241.0129 T1=165.2264  
R2=241.1529 Z2=-0.06252 T2=165.3676  
Z3=0.00413 T3=165.5182 R3=241.1743  
Avg. Concentration: 166.0 PPM

#### Calibration Curve

Concentration = A + Bx + Cx<sup>2</sup> + Dx<sup>3</sup> + Ex<sup>4</sup>  
r = 9.99996E-1  
Constants: A = 0.00000E+0  
B = 9.14718E-1 C = 1.18560E-2  
D = 1.00000E-6 E = 0.00000E+0

Concentration = A + Bx + Cx<sup>2</sup> + Dx<sup>3</sup> + Ex<sup>4</sup>  
r = 9.99999E-1  
Constants: A = 0.00000E+0  
B = 9.88844E-1 C = 4.60000E-5  
D = 0.00000E+0 E = 0.00000E+0

APPROVED BY:

*Michael A. Kuhns*  
Michael A. Kuhns



AIR LIQUIDE

Air Liquide America  
Specialty Gases LLC

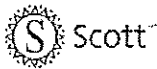

RATA CLASS

Dual-Analyzed Calibration Standard

6141 EASTON ROAD, BLDG 1, PLUMSTEADVILLE, PA 18949-0310

Phone: 800-331-4953

Fax: 215-766-7226

**CERTIFICATE OF ACCURACY: EPA Protocol Gas**

Assay Laboratory - PGVP Vendor ID: A12013

AIR LIQUIDE AMERICA SPECIALTY GASES LLC  
6141 EASTON ROAD, BLDG 1  
PLUMSTEADVILLE, PA 18949-0310

P.O. No.: CEM-6035  
Document #: 50369355-003

Customer

FLORIDA P&L-MARTIN PLT-PO#-CEM ONLY

21900 SW WARFIELD BLVD  
INDIANTOWN FL 34956  
US

**ANALYTICAL INFORMATION**

Gas Type : NO,BALN

This certification was performed according to EPA Traceability Protocol For Assay & Certification of Gaseous Calibration Standards; Procedure G-1; September, 1997.

Cylinder Number: ALM047577  
Cylinder Pressure\*\*\*: 1919 PSIG

Certification Date: 22Apr2013

Exp. Date: 23Apr2021  
Batch No: PLU0183401

COMPONENT	CERTIFIED CONCENTRATION (Moles)	ACCURACY**	TRACEABILITY
NITRIC OXIDE	125.9 PPM	+/- 1%	Direct NIST and VSL
NITROGEN - OXYGEN FREE	BALANCE		
TOTAL OXIDES OF NITROGEN	126.1 PPM		Reference Value Only

\*\*\* Do not use when cylinder pressure is below 150 psig.

\*\* Analytical accuracy is based on the requirements of EPA Protocol Procedure G1, September 1997.

**REFERENCE STANDARD**

TYPE/SRM NO.	EXPIRATION DATE	CYLINDER NUMBER	CONCENTRATION	COMPONENT
NTRM 1684	22Jul2017	KAL003769	97.60 PPM	NITRIC OXIDE

**INSTRUMENTATION**

INSTRUMENT/MODEL/SERIAL#	DATE LAST CALIBRATED	ANALYTICAL PRINCIPLE
FTIR//000928781	12Apr2013	FTIR

**ANALYZER READINGS**

(Z=Zero Gas R=Reference Gas T=Test Gas r=Correlation Coefficient)

First Triad Analysis

Second Triad Analysis

Calibration Curve

NITRIC OXIDE

Date: 15Apr2013 Response Unit:PPM  
Z1=0.00031 R1=97.25758 T1=125.2984  
R2=97.33088 Z2=0.03016 T2=125.3101  
Z3=0.14409 T3=125.4641 R3=97.36953  
Avg. Concentration: 125.7 PPM

Date: 22Apr2013 Response Unit: PPM  
Z1=-0.16088 R1=96.95466 T1=125.0259  
R2=97.01153 Z2=-0.08310 T2=125.4024  
Z3=-0.08259 T3=125.5067 R3=97.03058  
Avg. Concentration: 126.0 PPM

Concentration = A + Bx + Cx2 + Dx3 + Ex4  
r = 9.99998E-1  
Constants: A = 0.00000E+0  
B = 9.53354E-1 C = 1.76000E-4  
D = 0.00000E+0 E = 0.00000E+0

APPROVED BY:

Michael A. Kuhns



**AIR LIQUIDE** Air Liquide America  
Specialty Gases LLC

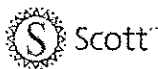

**RATA CLASS**  
*Dual-Analyzed Calibration Standard*

6141 EASTON ROAD, BLDG 1, PLUMSTEADVILLE, PA 18949-0310 Phone: 800-331-4953 Fax: 215-766-7228

**CERTIFICATE OF ACCURACY: EPA Protocol Gas**

Assay Laboratory - PGVP Vendor ID: A12013

AIR LIQUIDE AMERICA SPECIALTY GASES LLC  
6141 EASTON ROAD, BLDG 1  
PLUMSTEADVILLE, PA 18949-0310

P.O. No.: CEM-6035  
Document # : 50359355-004

Customer  
FLORIDA P&L-MARTIN PLT-PO#-CEM ONLY

21900 SW WARFIELD BLVD  
INDIANTOWN FL 34956  
US

**ANALYTICAL INFORMATION** Gas Type : NO,BALN

This certification was performed according to EPA Traceability Protocol For Assay & Certification of Gaseous Calibration Standards; Procedure G-1; September, 1997.

Cylinder Number: CC217297 Certification Date: 23Apr2013 Exp. Date: 24Apr2021  
Cylinder Pressure\*\*\*: 1936 PSIG Batch No: PLU0183414

COMPONENT	CERTIFIED CONCENTRATION (Moles)	ACCURACY**	TRACEABILITY
NITRIC OXIDE	277 PPM	+/- 1%	Direct NIST and VSL
NITROGEN - OXYGEN FREE	BALANCE		
TOTAL OXIDES OF NITROGEN	278. PPM		Reference Value Only

\*\*\* Do not use when cylinder pressure is below 150 psig.  
\*\* Analytical accuracy is based on the requirements of EPA Protocol Procedure G1, September 1997.

**REFERENCE STANDARD**

TYPE/SRM NO.	EXPIRATION DATE	CYLINDER NUMBER	CONCENTRATION	COMPONENT
NTRM 1685	04Jan2018	KAL004405	242.0 PPM	NITRIC OXIDE

**INSTRUMENTATION**

INSTRUMENT/MODEL/SERIAL#	DATE LAST CALIBRATED	ANALYTICAL PRINCIPLE
FTIR//000928781	12Apr2013	FTIR

**ANALYZER READINGS**

(Z=Zero Gas R=Reference Gas T=Test Gas r=Correlation Coefficient)

**First Triad Analysis**

**Second Triad Analysis**

**Calibration Curve**

**NITRIC OXIDE**

Date: 16Apr2013 Response Unit:PPM

Z1=0.10680 R1=241.5445 T1=276.9644

R2=241.7840 Z2=0.47468 T2=277.0008

Z3=0.56745 T3=277.2036 R3=241.9612

Avg. Concentration: 277.3 PPM

Date: 23Apr2013 Response Unit: PPM

Z1=0.02557 R1=241.0485 T1=276.4724

R2=241.4547 Z2=0.10969 T2=277.0924

Z3=0.19606 T3=277.1010 R3=241.8460

Avg. Concentration: 277.5 PPM

Concentration = A + Bx + Cx<sup>2</sup> + Dx<sup>3</sup> + Ex<sup>4</sup>  
r=9.99999E-1

Constants: A=0.00000E+0

B=9.88844E-1 C=4.60000E-5

D=0.00000E+0 E=0.00000E+0

APPROVED BY:

*Michael A. Kuhns*  
Michael A. Kuhns



AIR LIQUIDE

Air Liquide America  
Specialty Gases LLC



Scott™

# RATA CLASS

Dual-Analyzed Calibration Standard

6141 EASTON ROAD, BLDG 1, PLUMSTEADVILLE, PA 18949-0310

Phone: 800-331-4953

Fax: 215-766-7226

## CERTIFICATE OF ACCURACY: EPA Protocol Gas

Assay Laboratory - PGVP Vendor ID: A12013

AIR LIQUIDE AMERICA SPECIALTY GASES LLC  
6141 EASTON ROAD, BLDG 1  
PLUMSTEADVILLE, PA 18949-0310

P.O. No.: 06-05-2013  
Document #: 50954839-002  
Folio #: 425PPM NO/BAL N2

Customer

FLORIDA POWER & LIGHT - PUTNAM PLANT

MIKE MITCHELL  
392 US HIGHWAY 17 SOUTH  
EAST PALATKA FL 32131  
US

### ANALYTICAL INFORMATION

Gas Type : NO,BALN

This certification was performed according to EPA Traceability Protocol For Assay & Certification of Gaseous Calibration Standards; Procedure G-1; September, 1997.

Cylinder Number: ALM021880 Certification Date: 19Jun2013 Exp. Date: 20Jun2021  
Cylinder Pressure\*\*\*: 1958 PSIG Batch No: PLU0198747

COMPONENT	CERTIFIED CONCENTRATION (Moles)	ACCURACY**	TRACEABILITY
NITRIC OXIDE	427 PPM	+/- 1%	Direct NIST and VSL
NITROGEN - OXYGEN FREE	BALANCE		
TOTAL OXIDES OF NITROGEN	428 PPM		Reference Value Only

\*\*\* Do not use when cylinder pressure is below 150 psig.

\*\* Analytical accuracy is based on the requirements of EPA Protocol Procedure G1, September 1997.

### REFERENCE STANDARD

TYPE/SRM NO.	EXPIRATION DATE	CYLINDER NUMBER	CONCENTRATION	COMPONENT
NTRM 1686	26Mar2016	KAL003523	490.0 PPM	NITRIC OXIDE

### INSTRUMENTATION

INSTRUMENT/MODEL/SERIAL#	DATE LAST CALIBRATED	ANALYTICAL PRINCIPLE
FTIR/000928781	17Jun2013	FTIR

### ANALYZER READINGS

(Z=Zero Gas R=Reference Gas T=Test Gas r=Correlation Coefficient)

#### First Triad Analysis

##### NITRIC OXIDE

Date: 11Jun2013 Response Unit: PPM

Z1=-0.22368 R1=491.0015 T1=427.8518

R2=491.4463 Z2=-0.06546 T2=427.9924

Z3=0.03121 T3=428.9663 R3=491.6648

Avg. Concentration: 427.0 PPM

#### Second Triad Analysis

Date: 19Jun2013 Response Unit: PPM

Z1=0.05542 R1=491.9407 T1=428.1238

R2=491.9870 Z2=0.06296 T2=428.7148

Z3=0.65726 T3=429.2492 R3=492.1278

Avg. Concentration: 426.9 PPM

#### Calibration Curve

Concentration = A + Bx + Cx<sup>2</sup> + Dx<sup>3</sup> + Ex<sup>4</sup>  
r = 9.99998E-1

Constants: A = 0.00000E+0

B = 9.85798E-1 C = 4.20000E-5

D = 0.00000E+0 E = 0.00000E+0

APPROVED BY:

Michael A. Kuhns

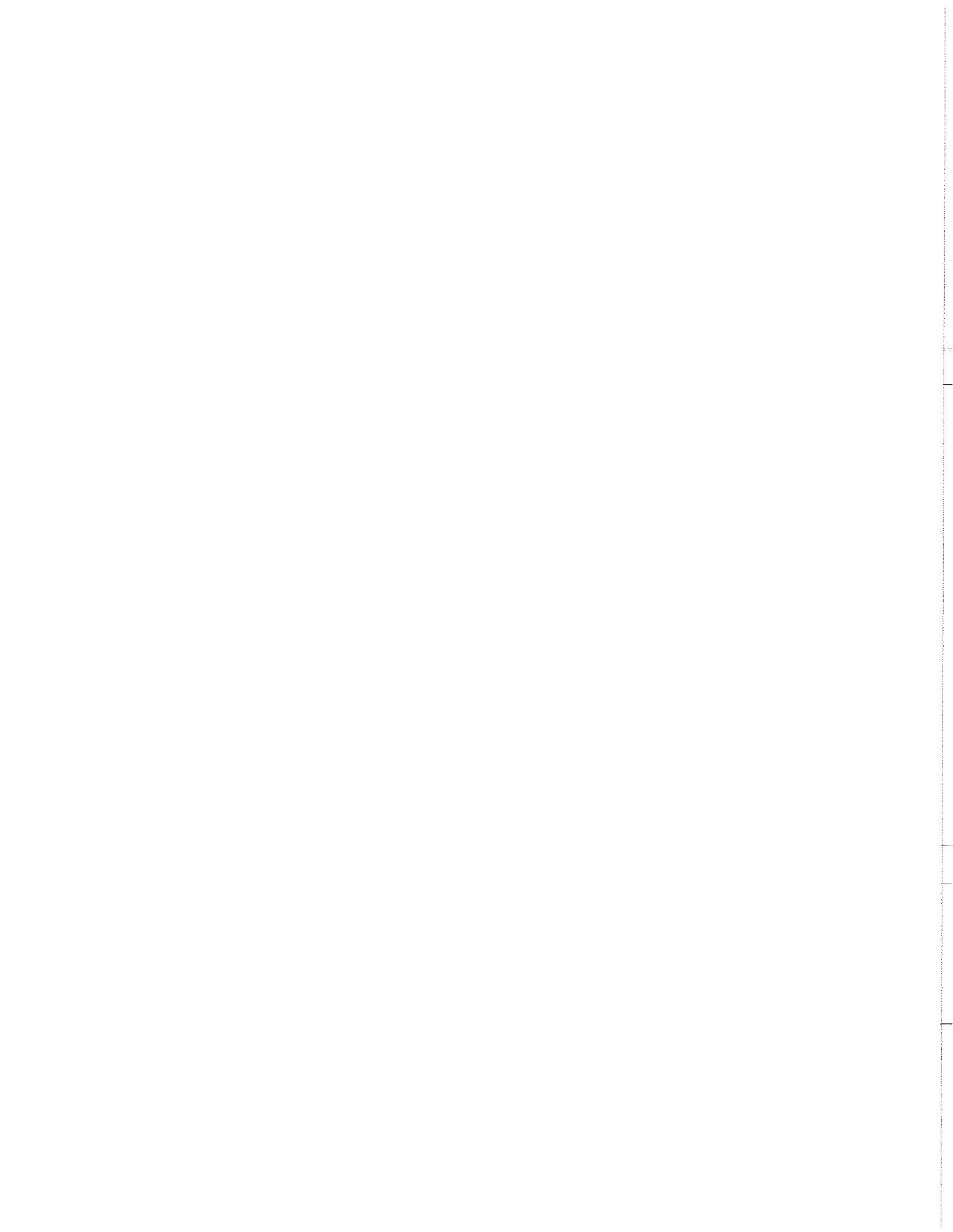



**Putnam Plant  
Seven Day Calibration Error Test**

Plant Putnam  
Unit 2GT2  
Oris Code \_\_\_\_\_

Parameter NOx  
Instrument Span 0-200 PPM  
Serial # 132425 8457 402-LS

Level	Date	Calibration Time	Reference/Cylinder value	Monitor value	Calibration Error	Adjustment made? up/down/none	New monitor value
zero				Calibrate monitors, begin test, collect and calculate drift in 24 hours (see 40 CFR 75, App. A, sec. 6.3)			
span							
zero	12/4/13	16:25	ALM 043109 0 PPM	-0.6	-0.3%	—	—
span	12/4/13	16:25	CC1102690 165.8 PPM	159.6	-3.2%	ADJ ↑	165.9
zero	12/5/13	07:55		-0.6	-0.3%	—	—
span	12/5/13	07:55		162.9	-1.5%	—	—
zero	12/6/13	07:55		-0.6	-0.3%	—	—
span	12/6/13	07:55		162.4	-1.8%	—	—
zero	12/7/13	10:17		-0.6	-0.3%	—	—
span	12/7/13	10:17		160.8	-2.6%	—	—
zero	12/8/13	11:17		-0.5	-0.3%	—	—
span	12/8/13	11:17		160.6	-2.7%	—	—
zero	12/9/13	07:55		-0.6	-0.3%	—	—
span	12/9/13	07:55		161.4	-2.3%	—	—
zero	12/10/13	07:55		-0.5	-0.3%	—	—
span	12/10/13	07:55	↓	161.0	-2.5%	—	—

Calibration Error = |Reference value - monitor value|

For NOx, the calibration error is acceptable if < 2.5%. (25.0 ppm)

6141 EASTON ROAD, BLDG 1 PO BOX 310  
 PLUMSTEADVILLE PA 18949-0310  
 Phone: 800-331-4993 Fax: 215-766-7226  
 C E R T I F I C A T E O F A N A L Y S I S  
 FLORIDA POWER & LIGHT - PUTNAM PLAN DOCUMENT#: 50954839 -001  
 MIKE MITCHELL PO#: 06-05-2013  
 392 US HIGHWAY 17 SOUTH ITEM #: P841-30AL  
 EAST PALATKA FL 32131 DATE: 17Jun2013  
 US

CYLINDER #: ALM043164 PRODUCT EXPIRATION: 21Jun2018  
 FILL PRESSURE: 2000 PSIG

PURE MATERIAL: NITROGEN CAS# 7727-37-9  
 GRADE: ACID RAIN CEM 0  
 PURITY: 99.9995%

IMPURITY		MAXIMUM CONCENTRATIONS	ACTUAL CONCENTRATIONS
SOX		0.1 PPM	< 0.1 PPM
NOX		0.1 PPM	< 0.1 PPM
CO		0.5 PPM	< 0.5 PPM
CO2		1 PPM	< 1 PPM
THC		0.1 PPM	< 0.1 PPM
H2O		2 PPM	< 2 PPM
O2		0.5 PPM	< 0.5 PPM

Received  
 8-14-13  
 ARCITE

In Service  
 11/12/13  
 ARCITE

Reused  
 from  
 Service  
 1-21-14  
 MRP

62749

ANALYST:   
 STEVEN A GANKOWSKI

LOT # : PLU0202868

**CERTIFICATE OF ACCURACY: Interference Free™ Multi-Component EPA Protocol Gas**

Assay Laboratory - PQVP Vendor ID: A12013  
 AIR LIQUIDE AMERICA SPECIALTY GASES LLC  
 6141 EASTON ROAD, BLDG 1  
 PLUMSTEADVILLE, PA 18949-0310

P.O. No.: REPLENISHMENT  
 Document #: 50179756-002

Customer  
 FLORIDA POWER & LIGHT - PUTNAM PLANT  
 MIKE MITCHELL  
 382 US HIGHWAY 17 SOUTH  
 EAST PALATKA FL 32131  
 US

**ANALYTICAL INFORMATION** Gas Type : CO2, NO, BALN

This certification was performed according to EPA Traceability Protocol For Assay & Certification of Gaseous Calibration Standards, Procedure G-1, September, 1997.

Cylinder Number: CC162690 Certification Date: 17Apr2013 Exp. Date: 18Apr2021  
 Cylinder Pressure\*\*\*: 2015 PSIG Batch No: PLU0181940

COMPONENT CERTIFIED CONCENTRATION (Moles) ACCURACY\*\* TRACEABILITY  
 CARBON DIOXIDE 155.9% +/- 1% Direct NIST and VSL  
 NITRIC OXIDE 167.2 PPM +/- 1% Direct NIST and VSL  
 NITROGEN - OXYGEN FREE BALANCE

TOTAL OXIDES OF NITROGEN 167.2 PPM Reference Value Only

\*\*\* Do not use when cylinder pressure is below 150 psig.  
 \*\* Analytical accuracy is based on the requirements of EPA Protocol Procedure G1, September 1997.

REFERENCE STANDARD  
 TYPE/SRM NO. EXPIRATION DATE  
 NTRM 1875 6 05Jan2018  
 JTRM 1685 04Jan2018

CYLINDER NUMBER CONCENTRATION  
 K001453 13.94 %  
 KAL004405 242.0 PPM

INSTRUMENTATION  
 INSTRUMENT/MODEL/SERIAL#  
 FTIR/000928781  
 FTIR/000928781

DATE LAST CALIBRATED  
 05Apr2013  
 12Apr2013

ANALYTICAL PRINCIPLE  
 FTIR  
 FTIR

**ANALYZER READINGS**

Z = Zero Gas R = Reference Gas T = Test Gas r = Correlation Coefficient

First Triad Analysis

CARBON DIOXIDE  
 Date: 10Apr2013 Response Unit: %  
 Z1 = -0.00227 R1 = 13.82690 T1 = 8.44995  
 R2 = 13.84768 Z2 = 0.00097 T2 = 8.45248  
 Z3 = 0.00629 T3 = 8.45263 R3 = 13.86228  
 Avg. Concentration: 8.508 %

NITRIC OXIDE  
 Date: 10Apr2013 Response Unit: PPM  
 Z1 = -0.35384 R1 = 240.4669 T1 = 164.6101  
 R2 = 240.5530 Z2 = 0.02351 T2 = 165.1194  
 Z3 = 0.42148 T3 = 165.1685 R3 = 240.7813  
 Avg. Concentration: 165.9 PPM

Second Triad Analysis

Concentration = A + Bx + Cx2 + Dx3 + Ex4  
 r = 9.999995E-1  
 Constants: A = 0.00000E+0  
 B = 9.14718E-1 C = 1.18560E-2  
 D = 1.00000E-6 E = 0.00000E+0

Concentration = A + Bx + Cx2 + Dx3 + Ex4  
 r = 9.999995E-1  
 Constants: A = 0.00000E+0  
 B = 9.86844E-1 C = 4.60000E-5  
 D = 0.00000E+0 E = 0.00000E+0

*Received 6-5-13 OREC III*  
*Is Service 10/16/13 OREC III*  
*Removed From Service 12/11/13 7:200# OREC III*

APPROVED BY: *Michael A. Kuhns*  
 Michael A. Kuhns

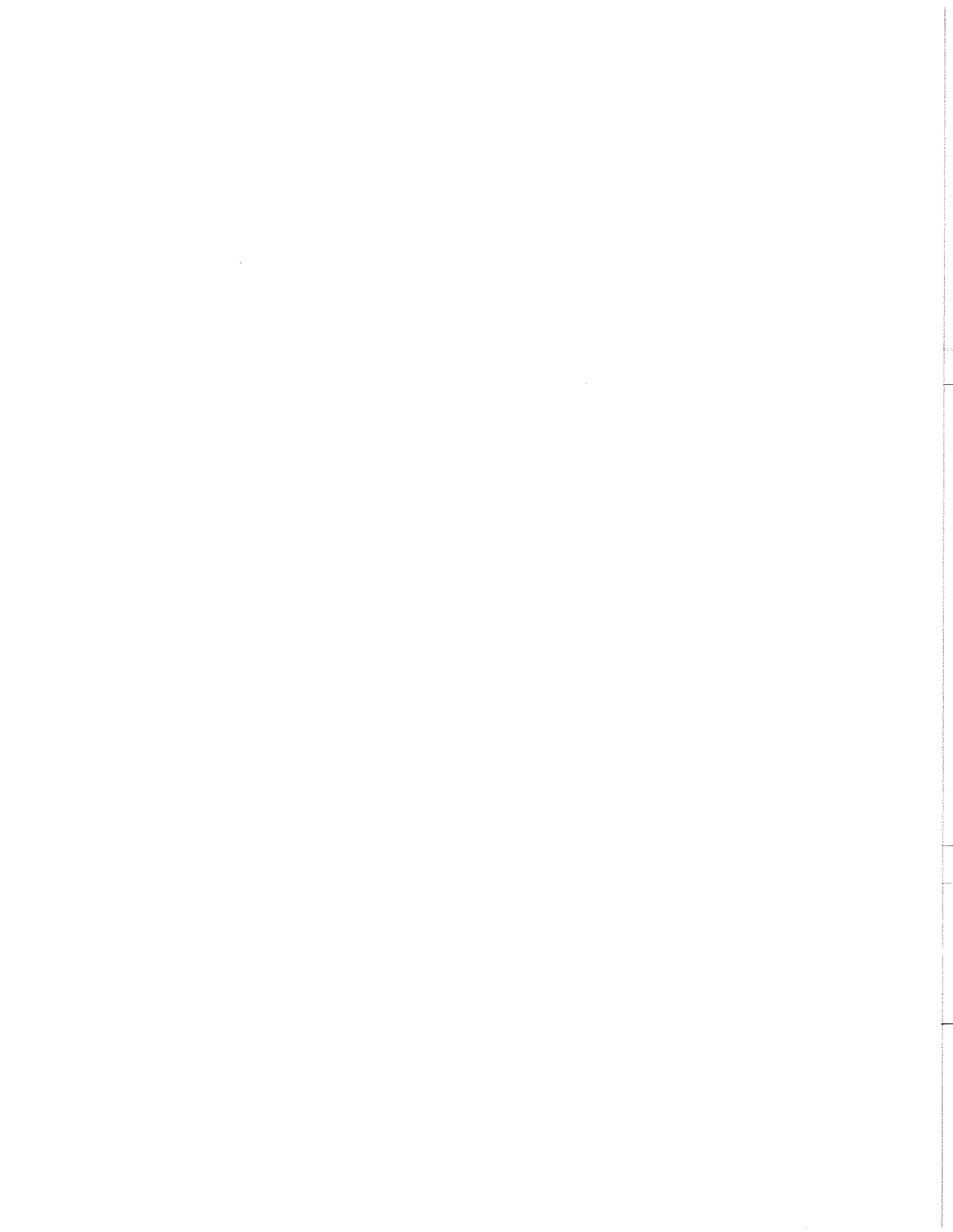



# ECMPS Client Tool

Version 1.0 2013 Q3

## Facility Name: Putnam

### Facility Details

Facility ID (ORISPL): 6246  
State: FL  
County: Putnam

Unit/Stack/Pipe ID: HRS22

### 7-Day Calibration

Component ID: B12  
Test Number: 7DAY-Q42013-B12-80  
Span Scale Level: High  
Component Type: NOX  
Reason for Test: RECERT  
Span Value: 500.000

Evaluation Status: No Errors

Test Completion: 12/10/2013 08:14  
Reported Test Results: PASSED  
EPA Calculated Result: PASSED  
Submission Status: Data loaded on EPA Host System  
Submission Date/Time: 01/31/2014 11:50:00 AM

Injection Date/Hour	Gas Level	Reference Value	Reference Value % of Span	Measured Value	Reported		Recalculated	
					Results	APS	Results	APS
12/04/2013 16	ZERO	0.000	0	-0.500	0.10		0.10	
12/04/2013 16	HIGH	427.000	85.4	420.800	1.20		1.20	
12/05/2013 07	ZERO	0.000	0	-0.600	0.10		0.10	
12/05/2013 08	HIGH	427.000	85.4	425.900	0.20		0.20	
12/06/2013 07	ZERO	0.000	0	-0.500	0.10		0.10	
12/06/2013 08	HIGH	427.000	85.4	424.900	0.40		0.40	
12/07/2013 10	ZERO	0.000	0	-0.500	0.10		0.10	
12/07/2013 10	HIGH	427.000	85.4	422.900	0.80		0.80	
12/08/2013 11	ZERO	0.000	0	-0.500	0.10		0.10	
12/08/2013 11	HIGH	427.000	85.4	421.600	1.10		1.10	
12/09/2013 07	ZERO	0.000	0	-0.500	0.10		0.10	
12/09/2013 08	HIGH	427.000	85.4	422.800	0.80		0.80	
12/10/2013 07	ZERO	0.000	0	-0.600	0.10		0.10	
12/10/2013 08	HIGH	427.000	85.4	422.600	0.90		0.90	

### Additional Information:

No comment.

\*Performance Spec: CE <= 2.5% of Span Alternate Performance Spec: |R-A| <= 5 ppm (Appendix A & 3.1)

**QA/Cert Test Detail Report**  
January 31, 2014 12:42 PM

**Facility Name:** Putnam  
**Facility ID (ORISPL):** 6246

**Unit/Stack/Pipe ID:** HRSG22  
**Linearity Check:**

**Component ID:** B12      **Component Type:** NOX      **Test Completion:** 11/21/2013 18:26

**Test Number:** LINE-Q42013-B12-1      **Reason for Test:** RECERT      **Reported Test Results:** PASSED

**Span Scale Level:** High      **Span Value:** 500.000      **EPA Calculated Result:** PASSED

**Evaluation Status:** No Errors      **Submission Status:** Data loaded on EPA Host System

**Grace period Tested?:**      **Submission Date/Time:** 01/31/2014 11:50:00 AM

**Protocol Gas Data:**

Gas Level Code	Gas Type Code	Vendor Identifier	Cylinder Identifier	Expiration Date
High	NO,BALN	A12013	ALM021880	06/21/2021
Mid	NO,BALN	A12013	CC217297	04/24/2015
Low	NO,BALN	A12013	ALM000577	10/02/2014

**Summary Statistics:**

	High		Mid		Low	
	Reported	Recalculated	Reported	Recalculated	Reported	Recalculated
Reference Value	426.667	426.667	277.000	277.000	125.900	125.900
Mass CEM Value	435.533	435.533	283.633	283.633	130.700	130.700
Alt. Perf. Indicator						
Results	2.1	2.1	2.4	2.4	3.8	3.8

**Injection Statistics:**

**QA/Cert Test Detail Report**  
January 31, 2014 12:42 PM

**Facility Name:** Putnam  
**Facility ID (ORISPL):** 6246

Date	Gas Level	Measured Value	Reference Value	Reference Value as % of Span
11/21/2013 18:26	HIGH	436.400	427.000	85.4%
11/21/2013 18:00	HIGH	435.100	427.000	85.4%
11/21/2013 17:34	HIGH	435.100	426.000	85.2%
11/21/2013 17:24	MID	283.300	277.000	55.4%
11/21/2013 18:18	MID	284.000	277.000	55.4%
11/21/2013 17:52	MID	283.600	277.000	55.4%
11/21/2013 18:10	LOW	131.400	125.900	25.2%
11/21/2013 17:16	LOW	129.300	125.900	25.2%
11/21/2013 17:44	LOW	131.400	125.900	25.2%

**Additional Information:**

No comment.

\*Performance Spec: LE <= 5.0% of Reference Value; Alternate Performance Spec: [R-A] <= 5ppm (Appendix A & 3.2)

**Unit/Stack/Pipe ID:** HRS622

**Linearity Check**

**Component ID:** A13      **Component Type:** CO2      **Test Completion:** 11/21/2013 17:01  
**Test Number:** LINE-Q42013-A13-3      **Reason for Test:** QA      **Reported Test Results:** PASSAPS  
**Span Scale Level:** High      **Span Value:** 10.000      **EPA Calculated Result:** PASSAPS

**Evaluation Status:** Informational Message      **Submission Status:** Data loaded on EPA Host System

**Grace period Tested?**      **Submission Date/Time:** 01/08/2014 4:01:00 PM

**Protocol Gas Data:**

Gas Level Code	Gas Type Code	Vendor Identifier	Cylinder Identifier	Expiration Date
High	CO2,NO,BALN	A12013	CC162690	04/18/2021
Mid	CO2,NO,BALN	A12013	ALM055501	04/24/2021
Low	CO2,NO,BALN	A12013	ALM009787	04/24/2021

**Summary Statistics:**

**QA/Cert Test Detail Report**  
January 31, 2014 12:42 PM

**Facility Name:** Putnam  
**Facility ID (ORISPL):** 6246

	High		Mid		Low	
	Reported	Recalculated	Reported	Recalculated	Reported	Recalculated
Reference Value	8.510	8.510	5.440	5.440	2.520	2.520
Mass CEM Value	8.593	8.593	5.567	5.567	2.670	2.670
Alt. Perf. Indicator					Y	Y
Results	1.0	1.0	2.3	2.3	0.2	0.2

**Injection Statistics:**

Date	Gas Level	Measured Value	Reference Value	Reference Value as % of Span
11/21/2013 16:15	LOW	2.680	2.520	25.2%
11/21/2013 16:41	LOW	2.690	2.520	25.2%
11/21/2013 15:45	LOW	2.640	2.520	25.2%
11/21/2013 16:25	MID	5.580	5.440	54.4%
11/21/2013 16:51	MID	5.570	5.440	54.4%
11/21/2013 15:55	MID	5.550	5.440	54.4%
11/21/2013 16:05	HIGH	8.600	8.510	85.1%
11/21/2013 17:01	HIGH	8.590	8.510	85.1%
11/21/2013 16:33	HIGH	8.590	8.510	85.1%

**Additional Information:**

No comment.

\*Performance Spec: LE <= 5.0% of Reference Value; Alternate Performance Spec: [R-A] <= 5ppm (Appendix A & 3.2)

**Unit/Stack/Pipe ID:** HRSG22

**Linearity Check**

**Component ID:** B12 **Component Type:** NOX **Test Completion:** 11/21/2013 17:01

**Test Number:** LINE-Q42013-B12-2 **Reason for Test:** RECERT **Reported Test Results:** PASSED

**Span Scale Level:** Low **Span Value:** 200.000 **EPA Calculated Result:** PASSED

**Evaluation Status:** No Errors **Submission Status:** Data loaded on EPA Host System

**Grace period Tested?** **Submission Date/Time:** 01/31/2014 11:50:00 AM

**Protocol Gas Data:**

Gas Level Code	Gas Type Code	Vendor Identifier	Cylinder Identifier	Expiration Date
High	CO2,NO,BALN	A12013	CC162690	04/18/2021



**QA/Cert Test Detail Report**  
January 31, 2014 12:42 PM

**Facility Name:** Putnam

**Facility ID (ORISPL):** 6246

Mid	CO2,NO,BALN	A12013	ALM055501	04/24/2021
Low	CO2,NO,BALN	A12013	ALM009787	04/24/2021

**Summary Statistics:**

	High		Mid		Low	
	Reported	Recalculated	Reported	Recalculated	Reported	Recalculated
Reference Value	165.900	165.900	111.000	111.000	50.000	50.000
Mass CEM Value	162.300	162.300	109.300	109.300	51.233	51.233
Alt. Perf. Indicator						
Results	2.2	2.2	1.5	1.5	2.5	2.5

**Injection Statistics:**

Date	Gas Level	Measured Value	Reference Value	Reference Value as % of Span
11/21/2013 17:01	HIGH	162.700	165.900	83.0%
11/21/2013 16:33	HIGH	162.800	165.900	83.0%
11/21/2013 16:05	HIGH	161.400	165.900	83.0%
11/21/2013 16:41	LOW	51.000	50.000	25.0%
11/21/2013 16:15	LOW	50.900	50.000	25.0%
11/21/2013 15:45	LOW	51.800	50.000	25.0%
11/21/2013 15:55	MID	109.200	111.000	55.5%
11/21/2013 16:51	MID	109.000	111.000	55.5%
11/21/2013 16:25	MID	109.700	111.000	55.5%

**Additional Information:**

No comment.

\*Performance Spec: LE <= 5.0% of Reference Value; Alternate Performance Spec: [R-A] <= 5ppm (Appendix A & 3.2)

**Unit/Stack/Pipe ID:** HRSRG22

**Relative Accuracy Test**

**System ID:** 112 **System Parameter:** NOX  
**Test Number:** RATA-Q42013-112-1 **Reason for Test:** QA  
**# of Op. Levels:** 1 **Grace Period Test?**

**Test Completion:** 12/23/2013 15:00  
**Reported Test Results:** PASSED  
**EPA Calculated Result:** PASSED

**Evaluation Status:** No Errors  
**Submission Status:** Data loaded on EPA Host System  
**Submission Date:** 01/31/2014 11:50:00 AM

**Reported BAF:** 1.000  
**EPA Calculated BAF:** 1.000  
**RATA Frequency:** 4QTRS

**QA/Cert Test Detail Report**  
January 31, 2014 12:42 PM

**Facility Name:** Putnam

**Facility ID (ORISPL):** 6246

**QA Name:** Steve, Webb C

**AETB Name:** Coastal Air Consulting Inc.

**Exam Date:** 05/01/2012

**AETB Phone Number:** 386-451-0169

**Provider Name:** Eastern Technical Associates (ETA)

**AETB Email:** Coastalair123@aol.com

**Provider Email:** Sherrit@smokeshool.com

**Protocol Gas Data:**

Gas Level Code	Gas Type Code	Vendor Identifier	Cylinder Identifier	Expiration Date
High	CO,NO,SO2,BALN	E12013	CC-165576	04/02/2021
Mid	CO,NO,SO2,BALN	E12013	CC-88806	11/06/2021
High	CO2,O2,BALN	E12011	CC-159134	11/01/2014
Mid	CO2,O2,BALN	E12013	CC-233289	09/23/2021
Low	ZERO			

**Operating Level:** High  
**Reference Method Used:** 7E,3A: NOX RM 7E and CO2/O2 RM 3A

**Summary Statistics:**

	Reported	Recalculated	Reported	Recalculated
<b>Mean of Monitoring System</b>	0.397	0.397	Relative Accuracy	4.63
<b>Mean of Reference Method Values</b>	0.388	0.388	Bias Adjustment Factor	1.000
<b>Mean of Difference</b>	-0.009	-0.009	APS Indicator	
<b>Standard Deviation of Difference</b>	0.012	0.012	T-Value	2.306
<b>Confidence Coefficient</b>	0.009	0.009	Gross Unit Load or Velocity	106
				107

**QA/Cert Test Detail Report**  
January 31, 2014 12:42 PM

**Facility Name:** Putnam  
**Facility ID (ORISPL):** 6246

**Run Data:**

Run	Start Date	End Date	Run Status	Monitoring System Value	Reference Method Value	Gross Load or Velocity
1	12/23/2013 10:30	12/23/2013 10:50	RUNUSED	0.383	0.397	109
2	12/23/2013 11:03	12/23/2013 11:23	RUNUSED	0.388	0.386	108
3	12/23/2013 11:33	12/23/2013 11:53	RUNUSED	0.390	0.387	107
4	12/23/2013 12:05	12/23/2013 12:25	RUNUSED	0.392	0.384	107
5	12/23/2013 12:40	12/23/2013 13:00	RUNUSED	0.397	0.388	106
6	12/23/2013 13:10	12/23/2013 13:30	RUNUSED	0.399	0.388	106
7	12/23/2013 13:40	12/23/2013 14:00	RUNUSED	0.404	0.389	106
8	12/23/2013 14:10	12/23/2013 14:30	RUNUSED	0.407	0.386	106
9	12/23/2013 14:40	12/23/2013 15:00	RUNUSED	0.411	0.385	105

**Additional Information:**

No comment.

\*Performance Spec: RA <= 10% or Mean Difference <= +/- 2.0fps.  
Reduced Frequency Spec: RA <= 7.5% or Mean Difference +/- 1.5 fps (Appendix A & 3.3.4)

**Unit/Stack/Pipe ID:** HRSQ22  
**Transmitter Transducer Test**

**Component ID:** 018  
**Test Number:** FFAT-Q42013-018-22

**Component Type:** GFFM  
**Reason for Test:** QA

**Test Completion:** 11/25/2013 12:00  
**Reported Test Results:** PASSED  
**EPA Calculated Results:** PASSED  
**Submission Status:** Data loaded on EPA Host System  
**Submission Date/Time:** 01/31/2014 11:50:00 AM

**Evaluation Status:** No Errors

High Level Accuracy	High Level Accuracy Specification	Mid Level Accuracy	Mid Level Accuracy Specification	Low Level Accuracy	Low Level Accuracy Specification
0.2	ACT	0.2	ACT	0.2	ACT

**Additional Information:**

No comment.



# ECMPS Client Tool

Version 1.0 2013 Q3

# QA/Cert Events Printout Report

January 31, 2014 12:44 PM

Facility Name: Putnam

## Facility Details

Facility ID (ORISPL): 6246  
 State: FL  
 County: Putnam

## QA Certification Events Details

Unit/Stack Identifier	Event Code	Event Date/Hour	System ID / Type	Component ID / Type	Required Tests	Conditional Data Begin Date/Hour	Last Test Completed Date/Hour	Submitted?
HRSG22	100	11/21/2013 12	112/NOX	A13/CO2	11	11/21/2013 12	12/23/2013 12	Already Submitted
				B12/NOX	11	11/21/2013 12	12/23/2013 12	Already Submitted

Event Codes: 100 - Permanent Gas Analyzer Replacement (Like-kind Analyzer)  
 Required Test Codes: 11 - Normal Load RATA, 7-day Calibration Error Test, Linearity Check