

P 938 762 885

RECEIPT FOR CERTIFIED MAIL

NO INSURANCE COVERAGE PROVIDED
NOT FOR INTERNATIONAL MAIL

(See Reverse)

PS Form 3800, June 1985

Sent to	Henry Hirschman
Origin and No.	GA Pacific Corp
P.O. State and ZIP Code	P.O. Box 919 Palatka FL
Postage	\$
Certified Fee	
Special Delivery Fee	
Restricted Delivery Fee	
Return Receipt showing to whom and Date Delivered	
Return Receipt showing to whom, Date, and Address of Delivery	
TOTAL Postage and Fees	\$
Postmark or Date	1/30/90
	mailed

SENDER: Complete items 1 and 2 when additional services are desired, and complete items 3 and 4.
Put your address in the "RETURN TO" Space on the reverse side. Failure to do this will prevent this card from being returned to you. The return receipt fee will provide you the name of the person delivered to and the date of delivery. For additional fees the following services are available. Consult postmaster for fees and check box(es) for additional service(s) requested.

1. Show to whom delivered, Date, and addressee's address. (Extra charge)
2. Restricted Delivery (Extra charge)

3. Article Addressed to: Mr. Henry Hirschman GA Pacific Corp. P.O. Box 919 Palatka, FL 32077	4. Article Number P 938 762 885
	Type of Service: <input type="checkbox"/> Registered <input type="checkbox"/> Insured <input checked="" type="checkbox"/> Certified <input type="checkbox"/> COD <input type="checkbox"/> Express Mail <input type="checkbox"/> Return Receipt for Merchandise
	Always obtain signature of addressee or agent and DATE DELIVERED .
5. Signature - Address X Georgia Pacific Corp	8. Addressee's Address (ONLY if requested and fee paid)
6. Signature - Agent X S. J. Brown	
7. Date of Delivery 1/31/90	

PS Form 3811, Mar. 1988

* U.S.G.P.O. 1988-212-865

DOMESTIC RETURN RECEIPT

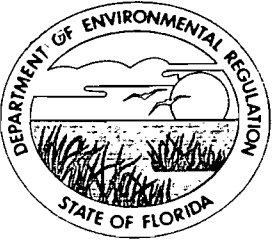

Florida Department of Environmental Regulation

Twin Towers Office Bldg. • 2600 Blair Stone Road • Tallahassee, Florida 32399-2400

Bob Martinez, Governor

Dale Twachtmann, Secretary

John Shearer, Assistant Secretary

STATE OF FLORIDA
DEPARTMENT OF ENVIRONMENTAL REGULATION
NOTICE OF PERMIT

Mr. Henry Hirschman, General Manager
Georgia-Pacific Corporation
P. O. Box 919
Palatka, Florida 32077

January 29, 1990

Enclosed is construction permit No. AC 54-170420 for Georgia-Pacific Corporation to construct/install two new batch digester systems (Nos. 10 and 13) as replacements for the existing ones (Nos. 10 and 13), with no changes allowed in the permitted allowable pollutant emission limitations and production capacities (i.e., PSD, NSPS and testing) for the total batch digester system. The project will occur at Georgia-Pacific Corporation's existing facility in Perry, Putnam County, Florida. This permit is issued pursuant to Section 403, Florida Statutes.

Any party to this permit has the right to seek judicial review of the permit pursuant to Section 120.68, Florida Statutes, by the filing of a Notice of Appeal pursuant to Rule 9.110, Florida Rules of Appellate Procedure, with the Clerk of the Department in the Office of General Counsel, 2600 Blair Stone Road, Tallahassee, Florida 32399-2400; and by filing a copy of the Notice of Appeal accompanied by the applicable filing fees with the appropriate District Court of Appeal. The Notice of Appeal must be filed within 30 days from the date this permit is filed with the Clerk of the Department.

Executed in Tallahassee, Florida.

STATE OF FLORIDA DEPARTMENT
OF ENVIRONMENTAL REGULATION

C. H. Fancy, P.E.
Chief
Bureau of Air Regulation

Copy furnished to:

- A. Kutyna, NE District
- V. Adams, G-PC
- D. Buff, P.E., KBN

CERTIFICATE OF SERVICE

The undersigned duly designated deputy clerk hereby certifies that this NOTICE OF PERMIT and all copies were mailed before the close of business on 1-30-90.

FILING AND ACKNOWLEDGEMENT
FILED, on this date, pursuant to
§120.52(9), Florida Statutes, with
the designated Department Clerk,
receipt of which is hereby
acknowledged.

Kum Doben
Clerk

1-30-90
Date

Final Determination

Georgia-Pacific Corporation
Putnam County
Palatka, Florida

Construction Permit No.
AC 54-170420

Department of Environmental Regulation
Division of Air Resources Management
Bureau of Air Regulation

January 26, 1990

Final Determination

The construction permit application has been reviewed by the Department. Public notice of the Department's Intent to Issue was published in The Palatka Daily News on January 4, 1990. The Technical Evaluation and Preliminary Determination were available for public inspection at the DER's Northeast District office and Bureau of Air Regulation office.

There were no comments received on the proposed action. Therefore, it is recommended that the proposed construction permit be issued as drafted.

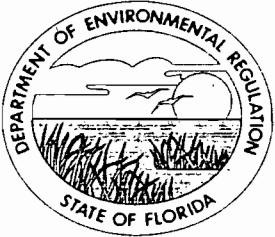

Florida Department of Environmental Regulation

Twin Towers Office Bldg. • 2600 Blair Stone Road • Tallahassee, Florida 32399-2400

Bob Martinez, Governor

Dale Twachtmann, Secretary

John Shearer, Assistant Secretary

PERMITTEE:
Georgia-Pacific Corporation
P. O. Box 919
Palatka, Florida 32077

Permit Number: AC 54-170420
Expiration Date: December 31, 1990
County: Putnam
Latitude/Longitude: 29°41'00"N
81°40'45"W
Project: Batch Digester Systems
Nos. 10 and 13

This permit is issued under the provisions of Chapter 403, Florida Statutes, Florida Administrative Code (F.A.C.) Chapters 17-2 and 17-4, and 40 CFR (July 1, 1988 version). The above named permittee is hereby authorized to perform the work or operate the facility shown on the application and approved drawing(s), plans, and other documents attached hereto or on file with the Department and made a part hereof and specifically described as follows:

For the construction of two new batch digester systems, Nos. 10 and 13, which will replace the existing ones (Nos. 10 and 13) and become a part of the total batch digester system (BDS) at the permittee's existing facility. The two new BDS are new source performance standard sources pursuant to 40 CFR 60.281(d). Each BDS will have a maximum capacity of 4900 ft³. The UTM coordinates are Zone 17, 434.0 km East and 3283.4 km North.

The Standard Classification Codes are:

o 3-07-001-01 Digester Relief and Blow Tank Tons ADUP

The sources shall be constructed in accordance with the permit application, plans, documents, amendments, drawings, and supplementary information, except as otherwise noted in the General and Specific Conditions.

Attachments are listed below:

1. Application to Construct Air Pollution Sources, DER Form 17-1.202(1), received September 20, 1989.
2. Mr. C. H. Fancy's letter dated September 29, 1989.
3. Mr. Vernon L. Adam's letter with attachment received October 27, 1989.
4. Technical Evaluation and Preliminary Determination dated December 29, 1989.
5. F.A.C. Chapter 17-2 (October, 1989).
6. F.A.C. Chapter 17-4 (September 13, 1989).
7. 40 CFR (July 1, 1988 version).

PERMITTEE:
Georgia-Pacific Corporation

Permit Number: AC 54-170420
Expiration Date: December 31, 1990

GENERAL CONDITIONS:

1. The terms, conditions, requirements, limitations, and restrictions set forth in this permit are "Permit Conditions" and are binding and enforceable pursuant to Sections 403.161, 403.727, or 403.859 through 403.861, Florida Statutes. The permittee is placed on notice that the Department will review this permit periodically and may initiate enforcement action for any violation of these conditions.
2. This permit is valid only for the specific processes and operations applied for and indicated in the approved drawings or exhibits. Any unauthorized deviation from the approved drawings, exhibits, specifications, or conditions of this permit may constitute grounds for revocation and enforcement action by the Department.
3. As provided in Subsections 403.087(6) and 403.722(5), Florida Statutes, the issuance of this permit does not convey any vested rights or any exclusive privileges. Neither does it authorize any injury to public or private property or any invasion of personal rights, nor any infringement of federal, state or local laws or regulations. This permit is not a waiver of or approval of any other Department permit that may be required for other aspects of the total project which are not addressed in the permit.
4. This permit conveys no title to land or water, does not constitute State recognition or acknowledgement of title, and does not constitute authority for the use of submerged lands unless herein provided and the necessary title or leasehold interests have been obtained from the State. Only the Trustees of the Internal Improvement Trust Fund may express State opinion as to title.
5. This permit does not relieve the permittee from liability for harm or injury to human health or welfare, animal, or plant life, or property caused by the construction or operation of this permitted source, or from penalties therefore; nor does it allow the permittee to cause pollution in contravention of Florida Statutes and Department rules, unless specifically authorized by an order from the Department.

PERMITTEE:
Georgia-Pacific Corporation

Permit Number: AC 54-170420
Expiration Date: December 31, 1990

GENERAL CONDITIONS:

6. The permittee shall properly operate and maintain the facility and systems of treatment and control (and related appurtenances) that are installed or used by the permittee to achieve compliance with the conditions of this permit, as required by Department rules. This provision includes the operation of backup or auxiliary facilities or similar systems when necessary to achieve compliance with the conditions of the permit and when required by Department rules.

7. The permittee, by accepting this permit, specifically agrees to allow authorized Department personnel, upon presentation of credentials or other documents as may be required by law and at a reasonable time, access to the premises, where the permitted activity is located or conducted to:

- a. Have access to and copy any records that must be kept under the conditions of the permit;
- b. Inspect the facility, equipment, practices, or operations regulated or required under this permit; and
- c. Sample or monitor any substances or parameters at any location reasonably necessary to assure compliance with this permit or Department rules.

Reasonable time may depend on the nature of the concern being investigated.

8. If, for any reason, the permittee does not comply with or will be unable to comply with any condition or limitation specified in this permit, the permittee shall immediately provide the Department with the following information:

- a. a description of and cause of non-compliance; and
- b. the period of noncompliance, including dates and times; or, if not corrected, the anticipated time the non-compliance is expected to continue, and steps being taken to reduce, eliminate, and prevent recurrence of the non-compliance.

PERMITTEE:
Georgia-Pacific Corporation

Permit Number: AC 54-170420
Expiration Date: December 31, 1990

GENERAL CONDITIONS:

The permittee shall be responsible for any and all damages which may result and may be subject to enforcement action by the Department for penalties or for revocation of this permit.

9. In accepting this permit, the permittee understands and agrees that all records, notes, monitoring data and other information relating to the construction or operation of this permitted source which are submitted to the Department may be used by the Department as evidence in any enforcement case involving the permitted source arising under the Florida Statutes or Department rules, except where such use is proscribed by Sections 403.73 and 403.111, Florida Statutes. Such evidence shall only be used to the extent it is consistent with the Florida Rules of Civil Procedure and appropriate evidentiary rules.

10. The permittee agrees to comply with changes in Department rules and Florida Statutes after a reasonable time for compliance, provided, however, the permittee does not waive any other rights granted by Florida Statutes or Department rules.

11. This permit is transferable only upon Department approval in accordance with Florida Administrative Code Rules 17-4.120 and 17-30.300, F.A.C., as applicable. The permittee shall be liable for any non-compliance of the permitted activity until the transfer is approved by the Department.

12. This permit or a copy thereof shall be kept at the work site of the permitted activity.

13. This permit also constitutes:

- () Determination of Best Available Control Technology (BACT)
- () Determination of Prevention of Significant Deterioration (PSD)
- (x) Compliance with New Source Performance Standards (NSPS)

14. The permittee shall comply with the following:

- a. Upon request, the permittee shall furnish all records and plans required under Department rules. During enforcement actions, the retention period for all records will be extended automatically unless otherwise stipulated by the Department.

PERMITTEE: Georgia-Pacific Corporation Permit Number: AC 54-170420
Expiration Date: December 31, 1990

GENERAL CONDITIONS:

- b. The permittee shall hold at the facility or other location designated by this permit records of all monitoring information (including all calibration and maintenance records and all original strip chart recordings for continuous monitoring instrumentation) required by the permit, copies of all reports required by this permit, and records of all data used to complete the application for this permit. These materials shall be retained at least three years from the date of the sample, measurement, report, or application unless otherwise specified by Department rule.
- c. Records of monitoring information shall include:
- the date, exact place, and time of sampling or measurements;
 - the person responsible for performing the sampling or measurements;
 - the dates analyses were performed;
 - the person responsible for performing the analyses;
 - the analytical techniques or methods used; and
 - the results of such analyses.

15. When requested by the Department, the permittee shall within a reasonable time furnish any information required by law which is needed to determine compliance with the permit. If the permittee becomes aware that relevant facts were not submitted or were incorrect in the permit application or in any report to the Department, such facts or information shall be corrected promptly.

SPECIFIC CONDITIONS:

1. The sources are permitted to operate continuously (i.e. 8760 hrs/year).
2. The emissions from the two new batch digester systems (Nos. 10 and 13), as defined in 40 CFR 60.281(d), shall be collected and transported by the noncondensable gas handling system to the incinerator in accordance with 40 CFR 60.283(a)(1)(iii).
3. Actual mass emissions from the Nos. 10 and 13 BDS shall be determined prior to and after any future changes that are not specifically authorized by this permit in accordance with 40 CFR 60.283(a)(1).

PERMITTEE:
Georgia-Pacific Corporation

Permit Number: AC 54-170420
Expiration Date: December 31, 1990

SPECIFIC CONDITIONS:

4. For testing purposes and NSPS applicability purposes, the maximum production rate of the total batch digester system will be 118 tons of air dried unbleached pulp (ADUP)/hr. Annual tests for compliance will be performed with the control device (incinerator) operating properly and with the batch digester system operating as near the maximum production rate as possible, but in no case shall the operating rate of the batch digester system be less than 85% of the maximum production rate when testing. For PSD purposes, the maximum production rate for the batch digester system will be 1850 tons of ADUP/day and based on a nominal utilization rate of 291,417 pounds dry wood chips/hour, 566,501 pounds of white liquor/hour, and 167,078 pounds of black liquor/hour.
5. Maximum SO₂ allowable emissions from the TRS incinerator shall neither exceed 1200 lbs/hr nor 3433.9 TPY.
6. All TRS gases burned in the TRS incinerator shall be subjected to a minimum temperature of at least 1200°F for at least 0.5 second. A device to continuously monitor and record the combustion temperature at the point of incineration shall be installed pursuant to all applicable requirements of 40 CFR 60.284(b)(1).
7. All excess emissions from the total batch digester system, the noncondensable gas handling (NCG) system, and the TRS incinerator shall be subject to the applicable requirements of F.A.C. Rules 17-2.240, 17-2.250, 17-2.600(4)(c)1.c., and 17-4.130. The required contingency plan shall be submitted to the DER Northeast District office.
8. Monitoring of emissions and operations shall be in accordance with 40 CFR 60.284 and F.A.C. Rule 17-2.710(4).
9. Compliance test methods shall be in accordance with 40 CFR 60.285. Any initial compliance test shall be conducted in accordance with 40 CFR 60.8.
10. The Nos. 10 and 13 batch digester systems are subject to the provisions of F.A.C. Rule 17-2.660, Standards of Performance for New Stationary Sources.
11. The Nos. 10 and 13 batch digester systems are subject to all applicable provisions of F.A.C. Chapters 17-2 and 17-4 and 40 CFR (July 1, 1988 version).

PERMITTEE:
Georgia-Pacific Corporation

Permit Number: AC 54-170420
Expiration Date: December 31, 1990

SPECIFIC CONDITIONS:

12. Objectionable odors shall not be allowed off plant property pursuant to F.A.C. Rule 17-2.620(2).

13. Notification of compliance testing to the DER's Northeast District office shall be in accordance with F.A.C. Rule 17-2.700(2)(a). Test reports shall be submitted to the DER's Northeast District office in accordance with F.A.C. Rule 17-2.700(2).

14. The permittee, for good cause, may request that this construction permit be extended. Such a request shall be submitted to the Bureau of Air Regulation prior to 60 days before the expiration of the permit (F.A.C. Rule 17-4.090).

15. An application for an operation permit must be submitted to the DER's Northeast District office at least 90 days prior to the expiration date of this construction permit or within 45 days after completion of compliance testing, whichever occurs first. To properly apply for an operation permit, the applicant shall submit the appropriate application form, fee, certification that construction was completed noting any deviations from the conditions in the construction permit, and compliance test reports as required by this permit (F.A.C. Rule 17-4.220).

Issued this 26 day
of January, 1989

STATE OF FLORIDA DEPARTMENT
OF ENVIRONMENTAL REGULATION

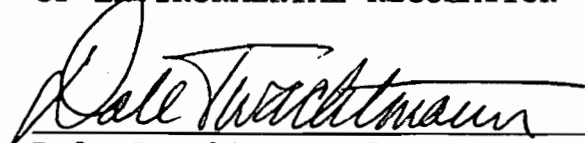
Dale Twachtmann, Secretary



RECEIVED

State of Florida
DEPARTMENT OF ENVIRONMENTAL REGULATION

For Routing To Other Than The Addressee	
To: _____	Location: _____
To: _____	Location: _____
To: _____	Location: _____
From: _____	Date: _____

Interoffice Memorandum

TO: Dale Twachtmann

for FROM: Steve Smallwood

DATE: January 26, 1990

SUBJ: Approval of Construction Permit No. AC 54-170420
Georgia-Pacific Corporation

Attached for your approval and signature is a permit prepared by the Bureau of Air Regulation for the above mentioned company to construct/install two new batch digester systems (Nos. 10 and 13) as replacements for the existing ones (Nos. 10 and 13), with no changes allowed in the permitted allowable pollutant emission limitations and production capacities (i.e., PSD, NSPS and testing) for the total batch digester system. The project will occur at the permittee's existing facility located in Palatka, Putnam County, Florida.

No comments were submitted on the Department's Intent to Issue the permit.

Day 90, after which this permit will be issued by default, is February 24, 1990.

I recommend your approval and signature.

SS/BM/plm

Attachments

Check Sheet

Company Name: Georgia Pacific Corp
Permit Number: ~~BACT Determination~~ AC 54-170420
PSD Number: _____
Permit Engineer: _____

Application:

- Initial Application
- Incompleteness Letters
- Responses
- Waiver of Department Action
- Department Response
- Other

Cross References:

- AC 54-142282
- AC 54-142283
- AC 54-142288
- AC 54-142291

Intent:

- Intent to Issue
- Notice of Intent to Issue
- Technical Evaluation
- BACT Determination
- Unsigned Permit
- Correspondence with:
 - EPA
 - Park Services
 - Other
- Proof of Publication
 - Petitions - (Related to extensions, hearings, etc.)
 - Waiver of Department Action
 - Other

Final Determination:

- Final Determination
- Signed Permit
- BACT Determination
- Other

Post Permit Correspondence:

- Extensions/Amendments/Modifications
- Other



Georgia-Pacific Corporation *Palatka Operations*
Southern Pulp & Paper Division

P.O. Box 919
Palatka, Florida 32078-0919
Telephone (904) 325-2001

RECEIVED
JAN 16 1990

January 11, 1990

DER-BA...

Mr. Bruce Mitchell
Florida Department of
Environmental Regulation
2600 Blair Stone Road
Tallahassee, Florida 32399-2400

Dear Mr. Mitchell:

Please find enclosed the certification of publication regarding the Notice of Intent to Issue for the digester replacement project.

If you have any questions or if I can be of further assistance, please call me at 904-325-2001.

Sincerely,

Vernon L. Adams
Superintendent of
Environmental Affairs

cc: W. L. Baxter
H. Hirschman
E. J. Schmidt
W. R. Wilson

B. Mitchell
A. Kutyna, NE Dist

PUBLIC NOTICE

State of Florida
Department of
Environmental
Regulation
Notice of Intent
to Issue

The Department of Environmental Regulation hereby gives notice of its intent to issue a permit to Georgia-Pacific Corporation, P.O. Box 919, Palatka, Florida 32077, to construct/install two new batch digester systems (Nos. 10 and 13) as replacements for the existing ones (Nos. 10 and 13) and there will be no changes in the permitted allowable pollutant emission limitations and production capacities (i.e., PSD, NSPS, and testing) for the total batch digester system. The proposed project will occur at the applicant's existing facility in Putnam County, Florida. A determination of Best Available Control Technology (BACT) was not required. The Department is issuing this intent to issue for the reasons stated in the Technical Evaluation and Preliminary Determination.

A person whose substantial interests are affected by the Department's proposed permitting decision may petition for an administrative proceeding (hearing) in accordance with Section 120.57, Florida Statutes. The petition must contain the information set forth below and must be filed (received) in the Office of General Counsel of the Department at 2600 Blair Stone Road, Tallahassee, Florida 32399-2400, within fourteen (14) days of publication of this notice. Petitioner shall mail a copy of the petition to the applicant at the address indicated above at the time of filing. Failure to file a petition within this time period shall constitute a waiver of any right such person may have to request an administrative determination (hearing) under Section 120.57, Florida Statutes.

The Petition shall contain the following information:

- (a) The name, address, and telephone number of each petitioner, the applicant's name and address, the Department Permit File Number and the county in which the project is proposed;
- (b) A statement of how and when each petitioner received notice of the Department's action or proposed action;
- (c) A statement of how each petitioner's substantial interests are affected by the Department's action or proposed action;
- (d) A statement of the material facts disputed by Petitioner, if any;
- (e) A statement of facts which petitioner contends warrant reversal or modification of the Department's action or proposed action;
- (f) A statement of which rules or statutes petitioner contends require reversal or modification of the Department's action or proposed action; and
- (g) A statement of the relief sought by petitioner, stating precisely the action petitioner wants the Department to take with respect to the Department's action or proposed action.

If a petition is filed, the administrative hearing process is designed to formulate agency action. Accordingly, the Department's final action may be different from the position taken by it in this Notice. Persons whose

STATE OF FLORIDA }
County of Putnam } SS:

Personally appeared before me, a Notary Public for the State of Florida at Large, ... Joyce Guthrie who deposes and says that she is Business Office Manager of The Palatka Daily News, a daily newspaper printed in the English Language and of general circulation, published in the City of Palatka, in said County and State; and that the attached order, notice, publication and/or advertisement of NOTICE OF INTENT TO ISSUE a ... permit to Georgia-Pacific Corp. to construct/install two new ... batch digester systems

..... was published in said newspaper ... The Palatka Daily News, Inc. for a period of One Insertion consecutively, Beginning January 4, 1990 and ending January 4, 1990 said publication being made on the following dates:

..... January 4, 1990

And deponent further says that The Palatka Daily News has been continuously published as a daily newspaper, and has been entered as second class mail matter at the postoffice at the City of Palatka, Putnam County, Florida, each for a period of more than one year next preceding the date of the first publication of the above described order, notice, publication and/or advertisement.

Subscribed and sworn to before me this

4th day of January, A. D. 1990

Robin Symonds

Notary Public
State of Florida at Large
My Commission Expires March 17, 1992

No. 22742

Joyce Guthrie

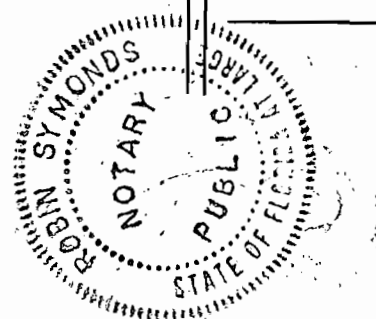

PUBLIC NOTICE

Department's Tallahassee address. All comments mailed within 14 days of the publication of this notice will be considered in the Department's final determination.
January 4, 1990

22742

substantial interests will be affected by any decision of the Department with regard to the application have the right to petition to become a party to the proceeding. The petition must conform to the requirements specified above and be filed (received) within 14 days of publication of this notice in the Office of General Counsel at the above address of the Department. Failure to petition within the allowed time frame constitutes a waiver of any right such person has to request a hearing under Section 120.57, F.S., and to participate as a party to this proceeding. Any subsequent intervention will only be at the approval of the presiding officer upon motion filed pursuant to Rule 28-5.207, F.A.C.

The application is available for public inspection during business hours, 8:00 a.m. to 5:00 p.m., Monday through Friday, except legal holidays, at:

Department of Environmental Regulation, Bureau of Air Regulation, 2600 Blair Stone Road, Tallahassee, Florida 32399-2400

Department of Environmental Regulation, Northeast District Office, 3426 Billis Road, Jacksonville, Florida 32207

Any person may send written comments on the proposed action to Mr. Bill Thomas at the

P 938 762 796

RECEIPT FOR CERTIFIED MAIL

NO INSURANCE COVERAGE PROVIDED
NOT FOR INTERNATIONAL MAIL

(See Reverse)

PS Form 3800, June 1985

\$m to Henry Hirschman, Gen. Mgr. Georgia-Pacific Corp. P.O. Box 919 Palatka, FL 32077	
Postage	\$
Certified Fee	
Special Delivery Fee	
Restricted Delivery Fee	
Return Receipt showing to whom and Date Delivered	
Return Receipt showing to whom, Date, and Address of Delivery	
TOTAL Postage and Fees	\$
Postmark or Date	
mailed: 12/29/89 AC 54-170420	

● **SENDER:** Complete items 1 and 2 when additional services are desired, and complete items 3 and 4. Put your address in the "RETURN TO" Space on the reverse side. Failure to do this will prevent this card from being returned to you. The return receipt fee will provide you the name of the person delivered to and the date of delivery. For additional fees the following service(s) are available. Consult postmaster for fees and check box(es) for additional service(s) requested.

1. Show to whom delivered, date, and addressee's address. * 2. Restricted Delivery (Extra charge)

3. Article Addressed to: Mr. Henry Hirschman, Gen. Mgr. Georgia-Pacific Corp. P.O. Box 919 Palatka, FL 32077	4. Article Number P 938 762 796 Type of Service: <input type="checkbox"/> Registered <input type="checkbox"/> Insured <input checked="" type="checkbox"/> Certified <input type="checkbox"/> COD <input type="checkbox"/> Express Mail <input type="checkbox"/> Return Receipt for Merchandise
Always obtain signature of addressee or agent and <u>DATE DELIVERED</u> .	
5. Signature - Address X <i>Gen - Pac Corp</i>	8. Addressee's Address (ONLY if requested and fee paid)
6. Signature - Agent X <i>John Palatka</i>	
7. Date of Delivery 1/3/89	



Florida Department of Environmental Regulation

Twin Towers Office Bldg. • 2600 Blair Stone Road • Tallahassee, Florida 32399-2400

Bob Martinez, Governor

Dale Twachtman, Secretary

John Shearer, Assistant Secretary

December 29, 1989

CERTIFIED MAIL-RETURN RECEIPT REQUESTED

Mr. Henry Hirschman, General Manager
Georgia-Pacific Corporation
P. O. Box 919
Palatka, Florida 32077

Dear Mr. Hirschman:

Attached is one copy of the Technical Evaluation and Preliminary Determination and proposed permit for Georgia-Pacific Corporation to construct/install two new batch digester systems (Nos. 10 and 13) as replacements for the existing ones (Nos. 10 and 13) and there will be no changes in the permitted allowable pollutant emission limitations and production capacities (i.e., PSD, NSPS and testing) for the total batch digester system.

Please submit any written comments you wish to have considered concerning the Department's proposed action to Mr. Bill Thomas of the Bureau of Air Regulation.

Sincerely,

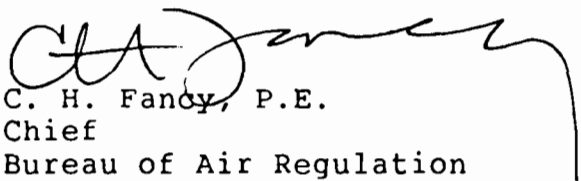
C. H. Fancy, P.E.
Chief
Bureau of Air Regulation

CHF/BM/plm

Attachments

- c: A. Kutyna, NE District
- D. A. Buff, P.E., KBN
- V. L. Adams, G-PC

Reading File
Bruce Mitchell

F.P. Subramani, O.S. (picked up)
2:31 p.m.

} 12-29-89

BEFORE THE STATE OF FLORIDA
DEPARTMENT OF ENVIRONMENTAL REGULATION

In the Matter of
Application for Permit by:

Georgia-Pacific Corporation
P. O. Box 919
Palatka, Florida 32077

DER File No. AC 54-170420

INTENT TO ISSUE

The Department of Environmental Regulation hereby gives notice of its intent to issue a permit (copy attached) for the proposed project as detailed in the application specified above. The Department is issuing this Intent to Issue for the reasons stated in the attached Technical Evaluation and Preliminary Determination.

The applicant, Georgia-Pacific Corporation, applied on September 20, 1989, to the Department of Environmental Regulation for a permit to construct/install two new batch digester systems (Nos. 10 and 13) as replacements for the existing ones (Nos. 10 and 13) and there will be no changes in the permitted allowable pollutant emission limitations and production capacities (i.e., PSD, NSPS, and testing) for the total batch digester system. The proposed project will occur at the applicant's existing facility located in Palatka, Putnam County, Florida.

The Department has permitting jurisdiction under Chapter 403, Florida Statutes, and Florida Administrative Code Rules 17-2 and 17-4. The project is not exempt from permitting procedures. The Department has determined that an air construction permit is required for the proposed work.

Pursuant to Section 403.815, F.S. and DER Rule 17-103.150, F.A.C., you (the applicant) are required to publish at your own expense the enclosed Notice of Intent to Issue Permit. The notice shall be published one time only within 30 days, in the legal ad section of a newspaper of general circulation in the area affected. For the purpose of this rule, "publication in a newspaper of general circulation in the area affected" means publication in a newspaper meeting the requirements of Sections 50.011 and 50.031, F.S., in the county where the activity is to take place. The applicant shall provide proof of publication to the Department, at the address specified within seven days of publication. Failure to publish the notice and provide proof of publication within the allotted time may result in the denial of the permit.

The Department will issue the permit with the attached conditions unless a petition for an administrative proceeding (hearing) is filed pursuant to the provisions of Section 120.57, F.S.

A person whose substantial interests are affected by the Department's proposed permitting decision may petition for an administrative proceeding (hearing) in accordance with Section 120.57, Florida Statutes. The petition must contain the information set forth below and must be filed (received) in the Office of General Counsel of the Department at 2600 Blair Stone Road, Tallahassee, Florida 32399-2400. Petitions filed by the permit applicant and the parties listed below must be filed within 14 days of receipt of this intent. Petitions filed by other persons must be filed within 14 days of publication of the public notice or within 14 days of receipt of this intent, whichever first occurs. Petitioner shall mail a copy of the petition to the applicant at the address indicated above at the time of filing. Failure to file a petition within this time period shall constitute a waiver of any right such person may have to request an administrative determination (hearing) under Section 120.57, Florida Statutes.

The Petition shall contain the following information;

(a) The name, address, and telephone number of each petitioner, the applicant's name and address, the Department Permit File Number and the county in which the project is proposed;

(b) A statement of how and when each petitioner received notice of the Department's action or proposed action;

(c) A statement of how each petitioner's substantial interests are affected by the Department's action or proposed action;

(d) A statement of the material facts disputed by Petitioner, if any;

(e) A statement of facts which petitioner contends warrant reversal or modification of the Department's action or proposed action;

(f) A statement of which rules or statutes petitioner contends require reversal or modification of the Department's action or proposed action; and

(g) A statement of the relief sought by petitioner, stating precisely the action petitioner wants the Department to take with respect to the Department's action or proposed action.

If a petition is filed, the administrative hearing process is designed to formulate agency action. Accordingly, the Department's final action may be different from the position taken by it in this notice. Persons whose substantial interests will be affected by any decision of the Department with regard to the application(s) have the right to petition to become a party to the proceeding. The petition must conform to the requirements specified above and be filed (received) within 14 days of publication of this notice in the Office in General Counsel at the above address of the Department. Failure to petition within the allowed time frame constitutes a waiver of any right such

person has to request a hearing under Section 120.57, F.S., and to participate as a party to this proceeding. Any subsequent intervention will only be at the approval of the presiding officer upon motion filed pursuant to Rule 28-5.207, F.A.C.

Executed in Tallahassee, Florida.

STATE OF FLORIDA DEPARTMENT
OF ENVIRONMENTAL REGULATION



C. H. Fancy, P.E.

Chief

Bureau of Air Regulation

Copies furnished to:

- A. Kutyna, NE District
- D. A. Buff, P.E., KBN
- V. L. Adams, G-PC

CERTIFICATE OF SERVICE

The undersigned duly designated deputy clerk hereby certifies that this NOTICE OF INTENT TO ISSUE and all copies were mailed before the close of business on 12-29-89.

FILING AND ACKNOWLEDGEMENT
FILED, on this date, pursuant to
§120.52(9), Florida Statutes, with
the designated Department Clerk,
receipt of which is hereby
acknowledged.

Martha J. Wise 12-29-89
Clerk Date

State of Florida
Department of Environmental Regulation
Notice of Intent to Issue

The Department of Environmental Regulation hereby gives notice of its intent to issue a permit to Georgia-Pacific Corporation, P. O. Box 919, Palatka, Florida 32077, to construct/install two new batch digester systems (Nos. 10 and 13) as replacements for the existing ones (Nos. 10 and 13) and there will be no changes in the permitted allowable pollutant emission limitations and production capacities (i.e., PSD, NSPS, and testing) for the total batch digester system. The proposed project will occur at the applicant's existing facility in Putnam County, Florida. A determination of Best Available Control Technology (BACT) was not required. The Department is issuing this Intent to Issue for the reasons stated in the Technical Evaluation and Preliminary Determination.

A person whose substantial interests are affected by the Department's proposed permitting decision may petition for an administrative proceeding (hearing) in accordance with Section 120.57, Florida Statutes. The petition must contain the information set forth below and must be filed (received) in the Office of General Counsel of the Department at 2600 Blair Stone Road, Tallahassee, Florida 32399-2400, within fourteen (14) days of publication of this notice. Petitioner shall mail a copy of the petition to the applicant at the address indicated above at the time of filing. Failure to file a petition within this time period shall constitute a waiver of any right such person may have to request an administrative determination (hearing) under Section 120.57, Florida Statutes.

The Petition shall contain the following information:

- (a) The name, address, and telephone number of each petitioner, the applicant's name and address, the Department Permit File Number and the county in which the project is proposed;
- (b) A statement of how and when each petitioner received notice of the Department's action or proposed action;
- (c) A statement of how each petitioner's substantial interests are affected by the Department's action or proposed action;
- (d) A statement of the material facts disputed by Petitioner, if any;
- (e) A statement of facts which petitioner contends warrant reversal or modification of the Department's action or proposed action;
- (f) A statement of which rules or statutes petitioner contends require reversal or modification of the Department's action or proposed action; and
- (g) A statement of the relief sought by petitioner, stating precisely the action petitioner wants the Department to take with respect to the Department's action or proposed action.

If a petition is filed, the administrative hearing process is designed to formulate agency action. Accordingly, the Department's final action may be different from the position taken by it in this Notice. Persons whose substantial interests will be affected by any decision of the Department with regard to the application have the right to petition to become a party to the proceeding. The petition must conform to the requirements specified above and be filed (received) within 14 days of publication of this notice in the Office of General Counsel at the above address of the Department. Failure to petition within the allowed time frame constitutes a waiver of any right such person has to request a hearing under Section 120.57, F.S., and to participate as a party to this proceeding. Any subsequent intervention will only be at the approval of the presiding officer upon motion filed pursuant to Rule 28-5.207, F.A.C.

The application is available for public inspection during business hours, 8:00 a.m. to 5:00 p.m., Monday through Friday, except legal holidays, at:

Department of Environmental Regulation
Bureau of Air Regulation
2600 Blair Stone Road
Tallahassee, Florida 32399-2400

Department of Environmental Regulation
Northeast District Office
3426 Bills Road
Jacksonville, Florida 32207

Any person may send written comments on the proposed action to Mr. Bill Thomas at the Department's Tallahassee address. All comments mailed within 14 days of the publication of this notice will be considered in the Department's final determination.

Technical Evaluation
and
Preliminary Determination

Georgia-Pacific Corporation
Putnam County
Palatka, Florida

Construction Permit No.
AC 54-170420

Department of Environmental Regulation
Division of Air Resources Management
Bureau of Air Regulation

December 29, 1989

I. Application

A. Applicant

Georgia-Pacific Corporation
Post Office Box 919
Palatka, Florida 32077

B. Project

The applicant intends to construct/install two new batch digester systems (Nos. 10 and 13) as replacements for the existing ones (Nos. 10 and 13) and there will be no changes in the permitted allowable pollutant emission limitations and production capacities (i.e. PSD, NSPS and testing) for the total batch digester system. The pollutant emissions from these sources are total reduced sulfur (TRS) and are not projected to increase. The project will occur at the applicant's existing facility located in Putnam County, Florida.

The UTM coordinates are Zone 17, 434.0 km East and 3283.4 km North.

C. Process and Controls

The new batch digester systems will each have a maximum capacity of 4900 ft³. The two new batch digester systems will become a part of a total batch digester system containing thirteen (13) batch digesters, a turpentine condenser, three (3) blow tanks (Nos. 1-3), and the No. 3 accumulator tank. The total system has a maximum 24-hr permitted processing capacity of 1850 tons per day air dried pulp (TPD ADP) at 10% water moisture.

The TRS emissions from the entire batch digester system are controlled by a noncondensable gas (NCG) system that collects and delivers the TRS emissions to an incinerator, which itself has no associated control device. The TRS emissions are oxidized to SO₂ emissions by the incinerator.

D. Source Classification Codes (SCC)

The SCC for this operation are:

- o 3-07-001-01 Digester Relief and Blow Tank Tons ADUP

II. Rule Applicability

The proposed project is subject to preconstruction review in accordance with Chapter 403, Florida Statutes, Florida Administrative Code (F.A.C.) Chapters 17-2 and 17-4, and 40 CFR (July 1, 1988 version).

The application package was deemed complete on October 27, 1989.

Putnam County is designated attainment for all of the criteria pollutants pursuant to F.A.C. Chapter 17-2, Part IV, Area Designation and Attainment Dates.

The existing mill is a major emitting facility for the pollutant TRS in accordance with F.A.C. Rule 17-2.100(115).

The new batch digester systems (2) have the potential to emit TRS emissions and, after incineration, SO₂ emissions.

Even though the two new batch digester systems will each be larger vessels by an increase in capacity of 1000 ft³ (3900 ft³ to 4900 ft³), the total batch digester system has a PSD (Prevention of Significant Deterioration) restriction, for review purposes, of 1850 tons per day air dried pulp at 10% water moisture. Since the newly modified batch digester system will be capable of achieving this production level and there will not be a change made to the permitted level, the new sources' potential pollutant emissions will not, therefore, increase.

Since the applicant assumes and projects that there will be no increase in TRS (and, therefore, SO₂) emissions, the project is subject to review in accordance with F.A.C. Rule 17-2.520, Sources Not Subject to PSD or Nonattainment Requirements, and considered a minor modification to a major facility.

The two new batch digester systems (BDS), as defined in 40 CFR 60.281(d), are subject to all applicable provisions of F.A.C. Chapters 17-2 and 17-4, and 40 CFR (July 1, 1988 version). Pursuant to F.A.C. Rule 17-2.660, the two new BDS are subject to the Standards of Performance for Kraft Pulp Mills, 40 CFR 60, Subpart BB. The two new BDS are subject to the applicable provisions of 40 CFR 60.280, 40 CFR 60.281, 40 CFR 60.283, 40 CFR 60.284, and 40 CFR 60.285.

The applicant elected to incinerate the TRS emissions from the two new BDS in the existing incinerator via the NCG handling system pursuant to 40 CFR 60.283(a)(1)(iii). The incinerator is permitted in the construction permit, No. AC 54-142291.

Monitoring of emissions and operations shall be in accordance with 40 CFR 60.284 and F.A.C. Rule 17-2.710(4).

If required, compliance test methods and procedures shall be in accordance with 40 CFR 60.285. Any initial compliance test shall be conducted in accordance with 40 CFR 60.8.

The two new BDS are subject to the provisions of F.A.C. Rule 17-2.660, Standards of Performance for New Stationary Sources (NSPS).

The two new BDS and their associated control system are subject to the provisions of F.A.C. Rule 17-2.600(4)(c)1.c.

Objectionable odors shall not be allowed off plant property pursuant to F.A.C. Rule 17-2.620(2).

The two new BDS are subject to the provisions of F.A.C. Rules 17-2.240: Circumvention; 17-2.250: Excess Emissions; and, 17-4.130: Plant Operations-Problems.

III. Summary of Emission and Air Quality Analysis

A. Emission Limitations

Pursuant to 40 CFR 60.283(a)(1)(iii), there will not be any TRS emissions allowed, since the applicant will be capturing, transporting, and incinerating all of the TRS emissions from the two new BDS. Also, there will not be any change in the allowable SO₂ emissions, as limited in the construction permit, No. AC 54-142291, and is as follows:

Table 1

Source	Pollutant	Maximum Allowable Emission Limitations
Incinerator	TRS	None allowed
	SO ₂	1200 lbs/hr; 3433.9 TPY
	VE	5% opacity (no visible emissions), except 20% opacity \leq 3-min/hr

- Note:
1. Operation is continuous (i.e., 8760 hours per year).
 2. The total BDS is limited for PSD purposes to a maximum daily average pulp production of 1850 TPD ADP (@ 10% H₂O).
 3. The total BDS is limited for testing and NSPS purposes to a maximum 1-hour pulp production of 118.0 TPH ADP (@10% H₂O).

If there is a volumetric flow increase to the incinerator, thus increasing the potential pollutant emissions (i.e., SO₂, etc.), then an application along with the appropriate fee to modify the existing facility would be required.

The emission limiting standards/limitations are consistent with the applicable requirements of F.A.C. Chapters 17-2 and 17-4 and 40 CFR (July 1, 1988 version). However, if the facility, for whatever reason, has to abandon the NCG incinerator system for the control of TRS emissions from the total BDS, then the TRS emission limiting standard for the two new BDS shall be in accordance with 40 CFR 60.283(a)(1) (July 1, 1988 version). If required, compliance test methods and procedures would be in accordance with 40 CFR 60.285.

B. Air Quality Analysis

From a review of the application package and supplementary material, an air quality analysis was not required.

IV. Conclusion

The emission limiting standards are in compliance with F.A.C. Chapter 17-2. The General and Specific Conditions listed in the proposed permit (attached) will assure compliance with all requirements of F.A.C. Chapters 17-2 and 17-4 and 40 CFR (July 1, 1988 version).

Based on the information provided by Georgia-Pacific Corporation, the Department has reasonable assurance that the proposed construction of two new batch digester systems (Nos. 10 and 13), as described in this evaluation, and subject to the conditions proposed herein, will not cause or contribute to a violation of any air quality standard, PSD increment, or any other technical provision of Chapter 17-2 of the Florida Administrative Code.

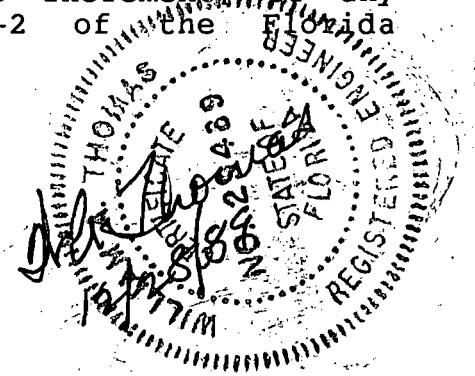

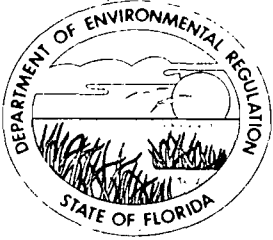

Florida Department of Environmental Regulation

Twin Towers Office Bldg. • 2600 Blair Stone Road • Tallahassee, Florida 32399-2400

Bob Martinez, Governor

Dale Twachtman, Secretary

John Shearer, Assistant Secretary

PERMITTEE:
Georgia-Pacific Corporation
P. O. Box 919
Palatka, Florida 32077

Permit Number: AC 54-170420
Expiration Date: December 31, 1990
County: Putnam
Latitude/Longitude: 29°41'00"N
81°40'45"W

Project: Batch Digester Systems
Nos. 10 and 13

This permit is issued under the provisions of Chapter 403, Florida Statutes, Florida Administrative Code (F.A.C.) Chapters 17-2 and 17-4, and 40 CFR (July 1, 1988 version). The above named permittee is hereby authorized to perform the work or operate the facility shown on the application and approved drawing(s), plans, and other documents attached hereto or on file with the Department and made a part hereof and specifically described as follows:

For the construction of two new batch digester systems, Nos. 10 and 13, which will replace the existing ones (Nos. 10 and 13) and become a part of the total batch digester system (BDS) at the permittee's existing facility. The two new BDS are new source performance standard sources pursuant to 40 CFR 60.281(d). Each BDS will have a maximum capacity of 4900 ft³. The UTM coordinates are Zone 17, 434.0 km East and 3283.4 km North.

The Standard Classification Codes are:

o 3-07-001-01 Digester Relief and Blow Tank Tons ADUP

The sources shall be constructed in accordance with the permit application, plans, documents, amendments, drawings, and supplementary information, except as otherwise noted in the General and Specific Conditions.

Attachments are listed below:

1. Application to Construct Air Pollution Sources, DER Form 17-1.202(1), received September 20, 1989.
2. Mr. C. H. Fancy's letter dated September 29, 1989.
3. Mr. Vernon L. Adam's letter with attachment received October 27, 1989.
4. Technical Evaluation and Preliminary Determination dated December 29, 1989.
5. F.A.C. Chapter 17-2 (October, 1989).
6. F.A.C. Chapter 17-4 (September 13, 1989).
7. 40 CFR (July 1, 1988 version).

PERMITTEE:
Georgia-Pacific Corporation

Permit Number: AC 54-170420
Expiration Date: December 31, 1990

GENERAL CONDITIONS:

1. The terms, conditions, requirements, limitations, and restrictions set forth in this permit are "Permit Conditions" and are binding and enforceable pursuant to Sections 403.161, 403.727, or 403.859 through 403.861, Florida Statutes. The permittee is placed on notice that the Department will review this permit periodically and may initiate enforcement action for any violation of these conditions.
2. This permit is valid only for the specific processes and operations applied for and indicated in the approved drawings or exhibits. Any unauthorized deviation from the approved drawings, exhibits, specifications, or conditions of this permit may constitute grounds for revocation and enforcement action by the Department.
3. As provided in Subsections 403.087(6) and 403.722(5), Florida Statutes, the issuance of this permit does not convey any vested rights or any exclusive privileges. Neither does it authorize any injury to public or private property or any invasion of personal rights, nor any infringement of federal, state or local laws or regulations. This permit is not a waiver of or approval of any other Department permit that may be required for other aspects of the total project which are not addressed in the permit.
4. This permit conveys no title to land or water, does not constitute State recognition or acknowledgement of title, and does not constitute authority for the use of submerged lands unless herein provided and the necessary title or leasehold interests have been obtained from the State. Only the Trustees of the Internal Improvement Trust Fund may express State opinion as to title.
5. This permit does not relieve the permittee from liability for harm or injury to human health or welfare, animal, or plant life, or property caused by the construction or operation of this permitted source, or from penalties therefore; nor does it allow the permittee to cause pollution in contravention of Florida Statutes and Department rules, unless specifically authorized by an order from the Department.

PERMITTEE:
Georgia-Pacific Corporation

Permit Number: AC 54-170420
Expiration Date: December 31, 1990

GENERAL CONDITIONS:

6. The permittee shall properly operate and maintain the facility and systems of treatment and control (and related appurtenances) that are installed or used by the permittee to achieve compliance with the conditions of this permit, as required by Department rules. This provision includes the operation of backup or auxiliary facilities or similar systems when necessary to achieve compliance with the conditions of the permit and when required by Department rules.

7. The permittee, by accepting this permit, specifically agrees to allow authorized Department personnel, upon presentation of credentials or other documents as may be required by law and at a reasonable time, access to the premises, where the permitted activity is located or conducted to:

- a. Have access to and copy any records that must be kept under the conditions of the permit;
- b. Inspect the facility, equipment, practices, or operations regulated or required under this permit; and
- c. Sample or monitor any substances or parameters at any location reasonably necessary to assure compliance with this permit or Department rules.

Reasonable time may depend on the nature of the concern being investigated.

8. If, for any reason, the permittee does not comply with or will be unable to comply with any condition or limitation specified in this permit, the permittee shall immediately provide the Department with the following information:

- a. a description of and cause of non-compliance; and
- b. the period of noncompliance, including dates and times; or, if not corrected, the anticipated time the non-compliance is expected to continue, and steps being taken to reduce, eliminate, and prevent recurrence of the non-compliance.

PERMITTEE:
Georgia-Pacific Corporation

Permit Number: AC 54-170420
Expiration Date: December 31, 1990

GENERAL CONDITIONS:

The permittee shall be responsible for any and all damages which may result and may be subject to enforcement action by the Department for penalties or for revocation of this permit.

9. In accepting this permit, the permittee understands and agrees that all records, notes, monitoring data and other information relating to the construction or operation of this permitted source which are submitted to the Department may be used by the Department as evidence in any enforcement case involving the permitted source arising under the Florida Statutes or Department rules, except where such use is proscribed by Sections 403.73 and 403.111, Florida Statutes. Such evidence shall only be used to the extent it is consistent with the Florida Rules of Civil Procedure and appropriate evidentiary rules.

10. The permittee agrees to comply with changes in Department rules and Florida Statutes after a reasonable time for compliance, provided, however, the permittee does not waive any other rights granted by Florida Statutes or Department rules.

11. This permit is transferable only upon Department approval in accordance with Florida Administrative Code Rules 17-4.120 and 17-30.300, F.A.C., as applicable. The permittee shall be liable for any non-compliance of the permitted activity until the transfer is approved by the Department.

12. This permit or a copy thereof shall be kept at the work site of the permitted activity.

13. This permit also constitutes:

- () Determination of Best Available Control Technology (BACT)
- () Determination of Prevention of Significant Deterioration (PSD)
- (x) Compliance with New Source Performance Standards (NSPS)

14. The permittee shall comply with the following:

- a. Upon request, the permittee shall furnish all records and plans required under Department rules. During enforcement actions, the retention period for all records will be extended automatically unless otherwise stipulated by the Department.

PERMITTEE:
Georgia-Pacific Corporation

Permit Number: AC 54-170420
Expiration Date: December 31, 1990

GENERAL CONDITIONS:

b. The permittee shall hold at the facility or other location designated by this permit records of all monitoring information (including all calibration and maintenance records and all original strip chart recordings for continuous monitoring instrumentation) required by the permit, copies of all reports required by this permit, and records of all data used to complete the application for this permit. These materials shall be retained at least three years from the date of the sample, measurement, report, or application unless otherwise specified by Department rule.

c. Records of monitoring information shall include:

- the date, exact place, and time of sampling or measurements;
- the person responsible for performing the sampling or measurements;
- the dates analyses were performed;
- the person responsible for performing the analyses;
- the analytical techniques or methods used; and
- the results of such analyses.

15. When requested by the Department, the permittee shall within a reasonable time furnish any information required by law which is needed to determine compliance with the permit. If the permittee becomes aware that relevant facts were not submitted or were incorrect in the permit application or in any report to the Department, such facts or information shall be corrected promptly.

SPECIFIC CONDITIONS:

1. The sources are permitted to operate continuously (i.e. 8760 hrs/year).

2. The emissions from the two new batch digester systems (Nos. 10 and 13), as defined in 40 CFR 60.281(d), shall be collected and transported by the noncondensable gas handling system to the incinerator in accordance with 40 CFR 60.283(a)(1)(iii).

3. Actual mass emissions from the Nos. 10 and 13 BDS shall be determined prior to and after any future changes that are not specifically authorized by this permit in accordance with 40 CFR 60.283(a)(1).

PERMITTEE:
Georgia-Pacific Corporation

Permit Number: AC 54-170420
Expiration Date: December 31, 1990

SPECIFIC CONDITIONS:

4. For testing purposes and NSPS applicability purposes, the maximum production rate of the total batch digester system will be 118 tons of air dried unbleached pulp (ADUP)/hr. Annual tests for compliance will be performed with the control device (incinerator) operating properly and with the batch digester system operating as near the maximum production rate as possible, but in no case shall the operating rate of the batch digester system be less than 85% of the maximum production rate when testing. For PSD purposes, the maximum production rate for the batch digester system will be 1850 tons of ADUP/day and based on a nominal utilization rate of 291,417 pounds dry wood chips/hour, 566,501 pounds of white liquor/hour, and 167,078 pounds of black liquor/hour.
5. Maximum SO₂ allowable emissions from the TRS incinerator shall neither exceed 1200 lbs/hr nor 3433.9 TPY.
6. All TRS gases burned in the TRS incinerator shall be subjected to a minimum temperature of at least 1200°F for at least 0.5 second. A device to continuously monitor and record the combustion temperature at the point of incineration shall be installed pursuant to all applicable requirements of 40 CFR 60.284(b)(1).
7. All excess emissions from the total batch digester system, the noncondensable gas handling (NCG) system, and the TRS incinerator shall be subject to the applicable requirements of F.A.C. Rules 17-2.240, 17-2.250, 17-2.600(4)(c)l.c., and 17-4.130. The required contingency plan shall be submitted to the DER Northeast District office.
8. Monitoring of emissions and operations shall be in accordance with 40 CFR 60.284 and F.A.C. Rule 17-2.710(4).
9. Compliance test methods shall be in accordance with 40 CFR 60.285. Any initial compliance test shall be conducted in accordance with 40 CFR 60.8.
10. The Nos. 10 and 13 batch digester systems are subject to the provisions of F.A.C. Rule 17-2.660, Standards of Performance for New Stationary Sources.
11. The Nos. 10 and 13 batch digester systems are subject to all applicable provisions of F.A.C. Chapters 17-2 and 17-4 and 40 CFR (July 1, 1988 version).

PERMITTEE: Georgia-Pacific Corporation Permit Number: AC 54-170420
Expiration Date: December 31, 1990

SPECIFIC CONDITIONS:

12. Objectionable odors shall not be allowed off plant property pursuant to F.A.C. Rule 17-2.620(2).

13. Notification of compliance testing to the DER's Northeast District office shall be in accordance with F.A.C. Rule 17-2.700(2)(a). Test reports shall be submitted to the DER's Northeast District office in accordance with F.A.C. Rule 17-2.700(2).

14. The permittee, for good cause, may request that this construction permit be extended. Such a request shall be submitted to the Bureau of Air Regulation prior to 60 days before the expiration of the permit (F.A.C. Rule 17-4.090).

15. An application for an operation permit must be submitted to the DER's Northeast District office at least 90 days prior to the expiration date of this construction permit or within 45 days after completion of compliance testing, whichever occurs first. To properly apply for an operation permit, the applicant shall submit the appropriate application form, fee, certification that construction was completed noting any deviations from the conditions in the construction permit, and compliance test reports as required by this permit (F.A.C. Rule 17-4.220).

Issued this _____ day
of _____, 1989

STATE OF FLORIDA DEPARTMENT
OF ENVIRONMENTAL REGULATION

Dale Twachtman, Secretary

ATTACHMENTS AVAILABLE UPON REQUEST



Georgia-Pacific Corporation *Palatka Operations*
Southern Pulp & Paper Division

P.O. Box 919
Palatka, Florida 32078-0919
Telephone (904) 325-2001

RECEIVED

October 26, 1989 OCT 27 1989

Mr. Clair Fancy, P.E.
Deputy Chief
Bureau of Air Quality Management
Florida Department of Environmental Regulation
2600 Blair Stone Road
Tallahassee, Florida 32399-2400

DER-BAQM

Re: AC 54-170420

Dear Mr. Fancy:

We appreciate your quick response to our application to rebuild two of our existing digesters. As mentioned in our application, we need to complete construction on these units in February. The information requested in your letter of September 29, 1989 is supplied below and numbered to correspond to the request of your letter. I met with Messrs. Bruce Mitchell, Bill Thomas, and Mike Harley on October 11th in an effort to assure a better understanding of the issues and completeness of this response .

1. Each of the digesters Nos. 1-9 are 4,900 cu. ft. digesters Nos. 11 and 12 are 3,900 cu. ft. each.
2. The total digester system is permitted for testing purposes and NSPS applicability purposes to produce 1850 tons/day of pulp, this federally enforceable permit is not based on the ability of any one digester to produce but is based on the ability to process the NCG's at the mill. The mill's ability to handle the NCG's limits the capability of the total system. The monitoring of the TRS system provides the assurance that the environment is being protected.
3. Figure A-1 correctly depicts the piping as it currently exist. The change which took place in February of 1989 increases operating flexibility with out increasing potential emissions. These digesters are permitted to and have cooked different types of wood in the past. If anything the change decreases potential emissions since in the past all gaseous emissions from digesters 12 and 13 went to the incinerator and we now have the potential to remove the turpentine vapors from these gasses prior to incineration.

Georgia-Pacific



P. O. Box 919
Palatka, Florida 32078-0919



Mr. Clair Fancy, P.E.
Deputy Chief
Bureau of Air Quality Management
Florida Department of Environmental Regulation
2600 Blair Stone Road
Tallahassee, Florida 32399-2400

010100
010100

4. Figure A-1 correctly depicts the piping as it currently exist. The change which took place in February of 1989 increases operating flexibility with out increasing potential emissions. These digesters are permitted to and have cooked different types of wood in the past. If anything the change decreases potential emissions since in the past all gaseous emissions from digesters 12 and 13 went to the incinerator and we now have the potential to remove the turpentine vapors from these gasses prior to incineration.
5. Figure A-1 correctly depicts the piping as it currently exist. The change which took place in February of 1989 increases operating flexibility with out increasing potential emissions. These digesters are permitted to and have cooked different types of wood in the past. If anything the change decreases potential emissions since in the past all gaseous emissions from digesters 12 and 13 went to the incinerator and we now have the potential to remove the turpentine vapors from these gasses prior to incineration.
6. We are replacing two existing digesters without increasing production. The operating rate of the condensate stripper will not change since the production rate is not changing.
7. The modification to digester No. 12 will not affect the operating rate of the condensate stripper. This digester is permitted to and has cooked different types of wood in the past. If anything the change decreases potential emissions since in the past all gaseous emissions from digesters 12 went to the incinerator and we now have the potential to remove the turpentine vapors from these gasses prior to incineration.
8. We are replacing two existing digesters without increasing production. The operating rate of the systems and sources at the mill will not change since the production rate is not changing.
9. The mill will assure that the incinerator maintains a temperature of at least 1200 degrees F and a retention time of 0.5 seconds. 17-2.600(4)(c) requires monitoring of incinerator conditions to

assure efficient combustion. The records from these monitors assure compliance with 17-2.600(4)(c). 17-2.600(1) FAC requires that this unit comply with a visible emission limit and a no objectionable odor regulation, the monitoring required by 17-2.600(4)(c) will assure efficient combustion and destruction of the TRS gasses thus assuring compliance with the visible emission and objectionable odor standards. Compliance with these standards can also be verified by trained observers from the highway.

10. Your letter requested that we respond to the request contained in the July 10, 1989 letter from Mr. Stewart. Several parts of the TRS system including the incinerator were placed in operation in late 1988 for start up and shakedown purposes. The total system was not placed in operation till May 12, 1989, this was later than anticipated due to a catastrophic failure of the accumulator (see the attached letter to Mr. Stewart dated May 9, 1989). Mr. Stewart also requested an acceptable test report that shows compliance with permit AC54-142291. As you are aware Georgia-Pacific requested and you granted an extension of the construction permit to allow time for the Department to consider information we had gained during the start up process and possibly amend the permit conditions. We have met with you and Mr. Harley on this subject and have submitted our request in writing. We are in compliance with the requirements of the TRS rule and will submit verification as soon as the permit amendments are considered.

Again, we wish to thank you for your efforts to handle this matter as rapidly as possible. If you have any questions please call me at 904-325-2001.

Sincerely,



Vernon L. Adams
Superintendent of
Environmental Affairs

cc: W. L. Baxter
H. Hirschman
B. Mitchell
E. Schmidt

*copied: M. Benjamin
CHF/BT*



Georgia-Pacific Corporation *Palatka Operations*
Southern Pulp & Paper Division
P.O. Box 919
Palatka, Florida 32078-0919
Telephone (904) 325-2001

May 9, 1989

Mr. William Stewart
Florida Department of Environmental Regulation
3426 Bills Rd.
Jacksonville, Florida 32207

Dear Bill,

Please find enclosed the certification of completion for the NCG system and the list of surrogate parameters to be monitored as required by permits AC 54-142282, AC 54-142283, AC 54-142288, AC 54-142291. I apologize for the delay in submitting this information, it was my oversight. The construction was complete on time and the certification is attached. The list of surrogate parameters to be monitored to determine compliance is in reality a very short one and was agreed upon during the construction permit negotiations. Georgia-Pacific will monitor the incinerator temperature as a surrogate parameter to assure compliance. Since virtually all of the TRS gasses from the above-mentioned sources are destroyed in the incinerator, and subpart BB of 40 CFR part 60 recognizes that temperature is the key parameter in insuring TRS destruction monitoring the incinerator temperature will insure TRS destruction.

Georgia-Pacific completed most of the required construction late last year and has been burning most of the mill's noncondensable gasses since that time. We have been making every effort to assure that the NCG system will be in full compliance according to schedule. It was our intent to not only have the system fully operational but to also have completed testing and certified compliance by May 12, 1989. We were prepared to meet that schedule until the system's accumulator vessel suffered a structural failure on April 20th. It seems that the tank itself collapsed inward due to a high vacuum. A team of engineers has been working on the problem to try to understand the cause, to fix the system and to prevent a similar occurrence. We have been working diligently to correct the problems and are now at the point where we have rebuilt the tank and added additional stiffeners. Strategies to avoid future problems are being

developed. The system has not become functional as rapidly as expected, and the time we lost during the repairs was time we planned to use for fine tuning the system. It appears now that the system will be up and destroying the TRS gasses by the 12th but will not be ready for testing soon enough that we can complete testing and submit the test reports by that date. Pursuant to my conversations with you and your staff of May 5th in your office, it is our understanding that due to the force major situation and the fact that the system has been operating ahead of schedule and will be operating on May 12th, the Department views the system to be in compliance with the intent of our permit conditions. We understand that we are required to complete testing as soon as possible and submit the results of these tests along with an application for an operating permit by June 9th.

We regret that the recent, unanticipated, and unavoidable developments with regard to our accumulator have resulted in a delay in submitting compliance tests. Georgia-Pacific appreciates the Department's willingness to work with us and commits to continue the spirit of cooperation which led us to incinerating the TRS gasses several months ahead of schedule. If you or any of your staff have any questions, please call me.

Sincerely,



Vernon L. Adams
Superintendent of
Environmental Affairs

cc: W. L. Baxter
J. Cole
H. Hirschman
E. Schmidt

Certification of Completion

I hereby certify that the construction of the noncondensable gas handling system at the Georgia-Pacific Pulp Mill in Palatka, Florida was complete as of March 1, 1989.



Vernon L. Adams
Superintendent of
Environmental Affairs

The above was sworn in my presence on the 9th day of May, 1989.

Notary Public, State of Florida at Large
My Commission Expires April 22, 1990
Bonded thru Huckleberry, Sibley &
Harvey Insurance and Bonds, Inc.



Julie Prisner
Notary Public

P 938 762 694

RECEIPT FOR CERTIFIED MAIL

NO INSURANCE COVERAGE PROVIDED
NOT FOR INTERNATIONAL MAIL
(See Reverse)

PS Form 3800, June 1985

Sent to Mr. Henry Hirschman, GP Corp.	
Street and No. P.O. Box 919	
P.O. State and ZIP Code Palatka, FL 32077	
Postage	\$
Certified Fee	
Special Delivery Fee	
Restricted Delivery Fee	
Return Receipt showing to whom and Date Delivered	
Return Receipt showing to whom, Date, and Address of Delivery	
TOTAL Postage and Fees	\$
Postmark or Date	
Permit: AC 54-170420	
Mailed: 9-29-89	

SENDER: Complete items 1 and 2 when additional services are desired, and complete items 3 and 4.
Put your address in the "RETURN TO" Space on the reverse side. Failure to do this will prevent this card from being returned to you. The return receipt fee will provide you the name of the person delivered to and the date of delivery. For additional fees the following services are available. Consult postmaster for fees and check box(es) for additional service(s) requested.

1. Show to whom delivered, date, and addressee's address. 2. Restricted Delivery (Extra charge)

3. Article Addressed to: Mr. Henry Hirschman General Manager Georgia-Pacific Corporation P. O. Box 919 Palatka, Florida 32077	4. Article Number P 938 762 694
	Type of Service: <input type="checkbox"/> Registered <input type="checkbox"/> Insured <input checked="" type="checkbox"/> Certified <input type="checkbox"/> COD <input type="checkbox"/> Express Mail <input type="checkbox"/> Return Receipt for Merchandise
Always obtain signature of addressee or agent and DATE DELIVERED.	
5. Signature - Address X <i>Georgia Pacific</i>	8. Addressee's Address (ONLY if requested and fee paid)
6. Signature - Agent X <i>A. Brown</i>	
7. Date of Delivery <i>10/2/89</i>	



Florida Department of Environmental Regulation

Twin Towers Office Bldg. • 2600 Blair Stone Road • Tallahassee, Florida 32399-2400

Bob Martinez, Governor

Dale Twachtman, Secretary

John Shearer, Assistant Secretary

September 29, 1989

CERTIFIED MAIL - RETURN RECEIPT REQUESTED

Mr. Henry Hirschman
General Manager
Georgia-Pacific Corporation
Post Office Box 919
Palatka, Florida 32077

Dear Mr. Hirschman:

Re: Completeness Review for Application to Construct
AC 54-170420

The Department received the above referenced application package on September 20, 1989, for the construction of two new batch digesters. Based on a review of the package, it is deemed incomplete. Therefore, submit to the Bureau of Air Regulation, including all assumptions, calculations and reference material, the following information and the status will, again, be ascertained:

1. What are the volumes of each of the digesters Nos. 1-9, 11 & 12 in ft³?
2. Since the volume of the existing Nos. 10 and 13 batch digesters are 3900 ft³ and the proposed new Nos. 10 and 13 batch digesters are to be 4900 ft³, provide the operational methodology that will be utilized to prevent an increase in production/through-put rate of raw materials and associated pollutant emissions; also, provide the methodology that the Department can use for verification.
3. It is noted that the No. 12 batch digester will be vented to the turpentine condenser (see Figure A-1). Is this modification correct as depicted? If so, please provide all of the particulars (i.e., raw material usage and capacity, emissions, operational rates, etc.).

Mr. Henry Hirschman
Page Two
September 29, 1989

4. It is noted that the No. 13 batch digester will be vented to the turpentine condenser (see Figure A-1). Is this modification correct as depicted? If so, please provide all of the particulars (i.e., raw material usage and capacity, emissions, operational rates, etc.).
5. If the Nos. 12 and 13 batch digesters are being modified to vent to the turpentine condenser, please provide all of the particulars for the turpentine condenser (i.e., capacity, operational rates, emissions, etc.).
6. Please explain how the installation of the two new batch digesters will have an affect upon the operation rate of the condensate stripper system. Please provide all of the particulars.
7. Please explain how the proposed modification to the No. 12 batch digester will have an affect upon the operation rate of the condensate stripper system. Please provide all of the particulars.
8. With regard to requests Nos. 3, 4, and 5 above, please explain how the proposed changes will affect the other sources and systems at your facility.
9. Submit the operational and procedural measures that will be implemented by the mill to provide reasonable assurance to the Department that the TRS incinerator will comply with the applicable emission limitations pursuant to F.A.C. Rules 17-2.600(1) and 17-2.600(4)(c); also, provide the methodology that the Department can use for verification.
10. Please respond to the requests contained in the July 10, 1989, letter from Mr. William P. Stewart, which is attached.

If there are any questions, please call Bruce Mitchell at (904)488-1344 or write to me at the above address.

Sincerely,

C. H. Fancy, P.E.
Bureau of Air Regulation

CHF/BM/t

attachment

cc: M. Benjamin, NE District
V. Adams, G-P.C.
D. Buff, P.E., KBN

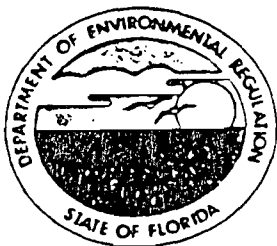

Florida Department of Environmental Regulation

Northeast District • 3426 Bills Road • Jacksonville, Florida 32207 • 904-796-4111

Bob Martinez, Governor

Dale Twachtmann, Secretary

John Shearer, Assistant Secretary

Ernest Frey, Deputy Assistant Secretary

July 10, 1989

File

Mr. Vernon Adams
Superintendent of Environmental Affairs
Georgia-Pacific Corporation
Post Office Box 919
Palatka, Florida 32078-0919

Dear Mr. Adams:

Putnam County - AP
Georgia-Pacific Corporation
Pulp and Paper Mill
TRS Incinerator

This is a request for the following additional information by July 31, 1989, which is required to complete the permit application for the referenced source. It is requested in accordance with Florida Administrative Code Rule 17-4.055.

Please submit:

1. Date TRS system including the incinerator was placed in operation.
2. An acceptable test report that shows compliance with permit No. AC54-142291.

If there are any questions please contact Johnny Cole at the letterhead address or phone number.

Very truly yours,

William P. Stewart, P.E.
District Air Program
Administrator

WPS:jck

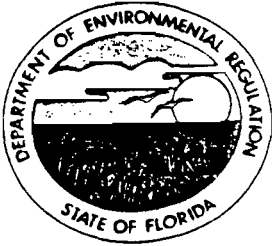

Florida Department of Environmental Regulation

Northeast District • 3426 Bills Road • Jacksonville, Florida 32207 • 904-798-4200

Bob Martinez, Governor

Dale Twachtmann, Secretary

John Shearer, Assistant Secretary
Ernest Frey, Deputy Assistant Secretary

July 10, 1989

Mr. Vernon Adams
Superintendent of Environmental Affairs
Georgia-Pacific Corporation
Post Office Box 919
Palatka, Florida 32078-0919

Dear Mr. Adams:

Putnam County - AP
Georgia-Pacific Corporation
Pulp and Paper Mill
TRS Incinerator

This is a request for the following additional information by July 31, 1989, which is required to complete the permit application for the referenced source. It is requested in accordance with Florida Administrative Code Rule 17-4.055.

Please submit:

1. Date TRS system including the incinerator was placed in operation.
2. An acceptable test report that shows compliance with permit No. AC54-142291.

If there are any questions please contact Johnny Cole at the letterhead address or phone number.

Very truly yours,

William P. Stewart, P.E.
District Air Program
Administrator

WPS:jck

DEPARTMENT OF ENVIRONMENTAL REGULATION

ROUTING AND TRANSMITTAL SLIP

ACTION NO

ACTION DUE DATE

1. TO: (NAME, OFFICE, LOCATION)

Bruce Mitchell, BAQM, CAPS

Initial

Date

2.

Initial

Date

3.

RECEIVED

Initial

Date

4.

SEP 28 1989

Initial

Date

REMARKS:

Per our 9/27 telecon.

DER BAQM

INFORMATION

Review & Return

Review & File

Initial & Forward

DISPOSITION

Review & Respond

Prepare Response

For My Signature

For Your Signature

Let's Discuss

Set Up Meeting

Investigate & Report

Initial & Forward

Distribute

Concurrence

For Processing

Initial & Return

FROM:

Johnny Cole

DATE

09-27-89

PHONE

Best Available Copy

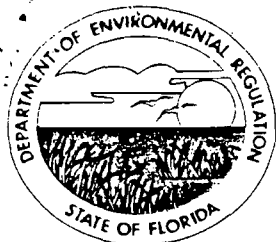

Florida Department of Environmental Regulation

Twin Towers Office Bldg. • 2600 Blair Stone Road • Tallahassee, Florida 32399-2400

Bob Martinez, Governor

Dale Twachtmann, Secretary

John Shearer, Assistant Secretary

July 28, 1989

CERTIFIED MAIL - RETURN RECEIPT REQUESTED

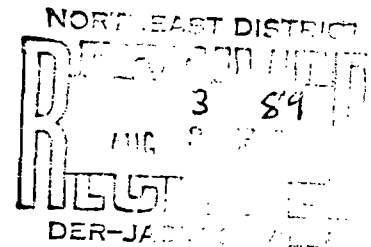

Mr. Henry Hirschman
General Manager
Georgia-Pacific Corporation
P. O. Box 919
Palatka, Florida 32078-0919

RE: Construction Permits Numbers AC 54-142282, AC 54-142283, AC 54-142288, AC 54-142291 for the Batch Digester System, the Multiple Effect Evaporation System, the Condensate Stripper System, and the TRS Incinerator, Respectively

The Department has received and reviewed Georgia-Pacific's July 24, 1989, petition for an extension of the expiration dates for the above referenced permits. The Department grants the extension of time with the understanding that none of the compliance dates for the affected sources will be extended by this action. The applicable compliance dates are set forth in Part IX of F.A.C. Chapter 17-2 as well as the above referenced permits.

The following shall be changed and added to the permits:

Expiration Date Change:

From: September 9, 1989

To: March 9, 1990

Attachments to be Added:

12. Georgia-Pacific Corporation's petition for an extension of time, dated July 24, 1989, and received July 24, 1989.

Mr. Henry Hirschman
Page Two
July 28, 1989

This letter shall be attached to the construction permits, AC 54-142282, AC 54-142283, AC 54-142288, and AC 54-142291, and shall become a part of these permits.

Sincerely,

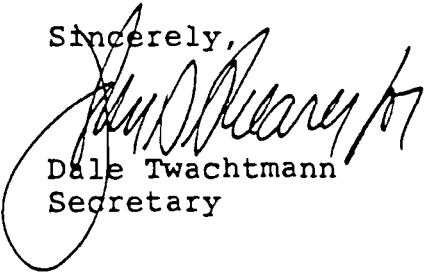

Dale Twachtmann
Secretary

DT/mdh

cc: W. Stewart, NE District
D. Buff, P.E.
V. Adams
T. Cole



Georgia-Pacific Corporation

Palatka Operations
Southern Pulp & Paper Division

P.O. Box 919
Palatka, Florida 32078-0919
Telephone (904) 325-2001

RECEIVED

SEP 20 1989

DER-BAQM

September 18, 1989

Certified Mail

Mr. Mike Harley
Florida Department of Environmental Regulation
2600 Blairstone Rd.
Tallahassee, Florida 32399-2400

Dear Mike:

Pursuant to our phone discussion, please find enclosed the application to rebuild digesters number 10 and 13 at our Palatka mill and a check in the amount of \$2,500.00 to cover the application fee. The project involves the rebuild of two existing digesters and will not result in an increase in emissions. We request that this application be processed as rapidly as possible since we hope to complete construction in February.

If you have any questions or need additional information, please contact me by phone at 904-325-2001.

Sincerely,

Vernon L. Adams
Superintendent of
Environmental Affairs

cc: W. L. Baxter
D. Buff
H. Hirschman
E. Schmidt

M. Benjamin, NE Dist.
B. Mitchell

1989 SEP 20 PM 3:58
RECEIVED
DER-MAIL ROOM

FIRST CLASS MAIL

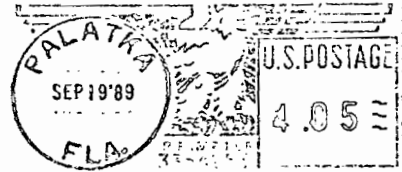

Georgia-Pacific

Palatka Operations
Southern Pulp & Paper Division
P.O. Box 919
Palatka, FL 32078-0919



CERTIFIED MAIL

Mr. Mike Harley
Florida Department of
Environmental Regulation
2600 Blirstone Road
Tallahassee, Florida 32399-2400

103

STATE OF FLORIDA
DEPARTMENT OF ENVIRONMENTAL REGULATION

\$2,500 pd.
9-20-89
Receipt # 117660

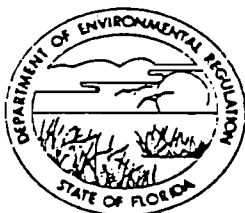

AC54-170420

APPLICATION TO OPERATE/CONSTRUCT AIR POLLUTION SOURCES

SOURCE TYPE: Digester Accumulator Tank [] New¹ [X] Existing¹

APPLICATION TYPE: [X] Construction [] Operation [X] Modification

COMPANY NAME: Georgia-Pacific Corporation COUNTY: Putnam

Identify the specific emission point source(s) addressed in this application (i.e. Lime Kiln No. 4 with Venturi Scrubber; Peaking Unit No. 2, Gas Fired) No.3 Digesting Accumulator Tank

SOURCE LOCATION: Street Highway 216 City Palatka

UTM: East 434.0 North 3283.4

Latitude 29 ° 41' 00"N Longitude 81 ° 40' 45"W

APPLICANT NAME AND TITLE: Henry Hirschman, General Manager

APPLICANT ADDRESS: P.O. Box 919, Palatka, Florida 32077

SECTION I: STATEMENTS BY APPLICANT AND ENGINEER

A. APPLICANT

I am the undersigned owner or authorized representative* of Georgia-Pacific Corporation

I certify that the statements made in this application for a construction permit are true, correct and complete to the best of my knowledge and belief. Further, I agree to maintain and operate the pollution control source and pollution control facilities in such a manner as to comply with the provision of Chapter 403, Florida Statutes, and all the rules and regulations of the department and revisions thereof. I also understand that a permit, if granted by the department, will be non-transferable and I will promptly notify the department upon sale or legal transfer of the permitted establishment.

*Attach letter of authorization

Signed: Henry Hirschman

Henry Hirschman, General Manager
Name and Title (Please Type)

Date: 9-18-89 Telephone No. (904) 325-2001

B. PROFESSIONAL ENGINEER REGISTERED IN FLORIDA (where required by Chapter 471, F.S.)

This is to certify that the engineering features of this pollution control project have been designed/examined by me and found to be in conformity with modern engineering principles applicable to the treatment and disposal of pollutants characterized in the permit application. There is reasonable assurance, in my professional judgment, that

¹ See Florida Administrative Code Rule 17-2.100(57) and (104)

the pollution control facilities, when properly maintained and operated, will discharge an effluent that complies with all applicable statutes of the State of Florida and the rules and regulations of the department. It is also agreed that the undersigned will furnish, if authorized by the owner, the applicant a set of instructions for the proper maintenance and operation of the pollution control facilities and, if applicable, pollution sources.



Signed David A. Buff

David A. Buff
Name (Please Type)

KBN Engineering and Applied Sciences, Inc.
Company Name (Please Type)

P.O. Box 14288, Gainesville, Florida 32604
Mailing Address (Please Type)

Florida Registration No. 19011 Date: 9/1/89 Telephone No. (904) 375-8000

SECTION II: GENERAL PROJECT INFORMATION

A. Describe the nature and extent of the project. Refer to pollution control equipment, and expected improvements in source performance as a result of installation. State whether the project will result in full compliance. Attach additional sheet if necessary.

See Attachments

B. Schedule of project covered in this application (Construction Permit Application Only)
Start of Construction upon permit issuance Completion of Construction November 12, 1989

C. Costs of pollution control system(s): (Note: Show breakdown of estimated costs only for individual components/units of the project serving pollution control purposes. Information on actual costs shall be furnished with the application for operation permit.)

N/A

D. Indicate any previous DER permits, orders and notices associated with the emission point, including permit issuance and expiration dates.

Permit: AC54-142282

Issued: 4/26/88

Expires: 9/9/89

E. Requested permitted equipment operating time: hrs/day 24 ; days/wk 7 ; wks/yr 52
if power plant, hrs/yr _____; if seasonal, describe: _____

F. If this is a new source or major modification, answer the following questions.
(Yes or No)

1. Is this source in a non-attainment area for a particular pollutant? No
a. If yes, has "offset" been applied? _____
b. If yes, has "Lowest Achievable Emission Rate" been applied? _____
c. If yes, list non-attainment pollutants. _____

2. Does best available control technology (BACT) apply to this source?
If yes, see Section VI. No

3. Does the State "Prevention of Significant Deterioration" (PSD)
requirement apply to this source? If yes, see Sections VI and VII. No

4. Do "Standards of Performance for New Stationary Sources" (NSPS)
apply to this source? No

5. Do "National Emission Standards for Hazardous Air Pollutants"
(NESHAP) apply to this source? No

H. Do "Reasonably Available Control Technology" (RACT) requirements apply
to this source? No

a. If yes, for what pollutants? _____

b. If yes, in addition to the information required in this form,
any information requested in Rule 17-2.650 must be submitted.

Attach all supportive information related to any answer of "Yes". Attach any justifi-
cation for any answer of "No" that might be considered questionable.

SECTION III: AIR POLLUTION SOURCES & CONTROL DEVICES (Other than Incinerators)

A. Raw Materials and Chemicals Used in your Process, if applicable:

Description	Contaminants		Utilization Rate - lbs/hr	Relate to Flow Diagram
	Type	% Wt		
Wood chips			291,417 *	Figure A-1 (1)
White liquor			566,501 *	Figure A-1 (2)
Black liquor			167,078 *	Figure A-1 (3)

*Maximum 24-hr average

B. Process Rate, if applicable: (See Section V, Item 1)

- Total Process Input Rate (lbs/hr): 1,024,996 (max 24-hr average)
- Product Weight (lbs/hr): 154,167 lb/hr ADP; 238,958 lb/hr BLS (max 24-hr average)

C. Airborne Contaminants Emitted: (Information in this table must be submitted for each emission point, use additional sheets as necessary)

Name of Contaminant	Emission ¹		Allowed ² Emission Rate per Rule 17-2	Allowable ³ Emission lbs/hr	Potential ⁴ Emission		Relate to Flow Diagram
	Maximum lbs/hr	Actual T/yr			lbs/XX hr	T/yr	
TRS (as sulfur)*							
Max 24-hr avg	196	858	600(4)(c)1	Incineration	196	858	Fig A-1(4)
Max 3-hr avg	300	NA	600(4)(c)1	Incineration	300	NA	Fig A-1(4)

¹See Section V, Item 2.

²Reference applicable emission standards and units (e.g. Rule 17-2.600(5)(b)2. Table II, E. (1) - 0.1 pounds per million BTU heat input)

³Calculated from operating rate and applicable standard.

⁴Emission, if source operated without control (See Section V, Item 3).

* All TRS emissions will be incinerated (refer to TRS Incinerator application)

D. Control Devices: (See Section V, Item 4)

Name and Type (Model & Serial No.)	Contaminant	Efficiency	Range of Particles Size Collected (in microns) (If applicable)	Basis for Efficiency (Section V Item 5)
TRS Incinerator	TRS	+99%	N/A	Design

E. Fuels Not Applicable

Type (Be Specific)	Consumption*		Maximum Heat Input (MMBTU/hr)
	avg/hr	max./hr	

*Units: Natural Gas--MMCF/hr; Fuel Oils--gallons/hr; Coal, wood, refuse, other--lbs/hr.

Fuel Analysis:

Percent Sulfur: _____ Percent Ash: _____

Density: _____ lbs/gal Typical Percent Nitrogen: _____

Heat Capacity: _____ BTU/lb _____ BTU/gal

Other Fuel Contaminants (which may cause air pollution): _____

F. If applicable, indicate the percent of fuel used for space heating.

Annual Average Not Applicable Maximum _____

G. Indicate liquid or solid wastes generated and method of disposal.

Not Applicable

H. Emission Stack Geometry and Flow Characteristics (Provide data for each stack):

Refer to TRS Incinerator permit application

Stack Height: _____ ft. Stack Diameter: _____ ft.

Gas Flow Rate: _____ ACFM _____ DSCFM Gas Exit Temperature: _____ °F.

Water Vapor Content: _____ % Velocity: _____ FPS

SECTION IV: INCINERATOR INFORMATION

Not Applicable

Type of Waste	Type 0 (Plastics)	Type I (Rubbish)	Type II (Refuse)	Type III (Garbage)	Type IV (Pathological)	Type V (Liq. & Gas By-prod.)	Type VI (Solid By-prod.)
Actual lb/hr Incinerated							
Uncontrolled (lbs/hr)							

Description of Waste _____

Total Weight Incinerated (lbs/hr) _____ Design Capacity (lbs/hr) _____

Approximate Number of Hours of Operation per day _____ day/wk _____ wks/yr. _____

Manufacturer _____

Date Constructed _____ Model No. _____

	Volume (ft) ³	Heat Release (BTU/hr)	Fuel		Temperature (°F)
			Type	BTU/hr	
Primary Chamber					
Secondary Chamber					

Stack Height: _____ ft. Stack Diameter: _____ Stack Temp. _____

Gas Flow Rate: _____ ACFM _____ DSCFM* Velocity: _____ FPS

*If 50 or more tons per day design capacity, submit the emissions rate in grains per standard cubic foot dry gas corrected to 50% excess air.

Type of pollution control device: Cyclone Wet Scrubber Afterburner

Other (specify) _____

Brief description of operating characteristics of control devices: _____

Ultimate disposal of any effluent other than that emitted from the stack (scrubber water, ash, etc.):

NOTE: Items 2, 3, 4, 6, 7, 8, and 10 in Section V must be included where applicable.

SECTION V: SUPPLEMENTAL REQUIREMENTS

Please provide the following supplements where required for this application.

1. Total process input rate and product weight -- show derivation [Rule 17-2.100(127)]
2. To a construction application, attach basis of emission estimate (e.g., design calculations, design drawings, pertinent manufacturer's test data, etc.) and attach proposed methods (e.g., FR Part 60 Methods 1, 2, 3, 4, 5) to show proof of compliance with applicable standards. To an operation application, attach test results or methods used to show proof of compliance. Information provided when applying for an operation permit from a construction permit shall be indicative of the time at which the test was made.
3. Attach basis of potential discharge (e.g., emission factor, that is, AP42 test).
4. With construction permit application, include design details for all air pollution control systems (e.g., for baghouse include cloth to air ratio; for scrubber include cross-section sketch, design pressure drop, etc.)
5. With construction permit application, attach derivation of control device(s) efficiency. Include test or design data. Items 2, 3 and 5 should be consistent: actual emissions = potential (1-efficiency).
6. An 8 1/2" x 11" flow diagram which will, without revealing trade secrets, identify the individual operations and/or processes. Indicate where raw materials enter, where solid and liquid waste exit, where gaseous emissions and/or airborne particles are evolved and where finished products are obtained.
7. An 8 1/2" x 11" plot plan showing the location of the establishment, and points of airborne emissions, in relation to the surrounding area, residences and other permanent structures and roadways (Example: Copy of relevant portion of USGS topographic map).
8. An 8 1/2" x 11" plot plan of facility showing the location of manufacturing processes and outlets for airborne emissions. Relate all flows to the flow diagram.

9. The appropriate application fee in accordance with Rule 17-4.05. The check should be made payable to the Department of Environmental Regulation.
10. With an application for operation permit, attach a Certificate of Completion of Construction indicating that the source was constructed as shown in the construction permit.

SECTION VI: BEST AVAILABLE CONTROL TECHNOLOGY

Not Applicable

- A. Are standards of performance for new stationary sources pursuant to 40 C.F.R. Part 60 applicable to the source?

Yes No

Contaminant	Rate or Concentration

- B. Has EPA declared the best available control technology for this class of sources (If yes, attach copy)

Yes No

Contaminant	Rate or Concentration

- C. What emission levels do you propose as best available control technology?

Contaminant	Rate or Concentration

- D. Describe the existing control and treatment technology (if any).

- | | |
|---------------------------|--------------------------|
| 1. Control Device/System: | 2. Operating Principles: |
| 3. Efficiency:* | 4. Capital Costs: |

*Explain method of determining.

- 5. Useful Life:
- 7. Energy:
- 9. Emissions:

- 6. Operating Costs:
- 8. Maintenance Cost:

Contaminant	Rate or Concentration

10. Stack Parameters

- a. Height: ft. b. Diameter: ft.
- c. Flow Rate: ACFM d. Temperature: °F.
- e. Velocity: FPS

E. Describe the control and treatment technology available (As many types as applicable use additional pages if necessary).

1.

- a. Control Device: b. Operating Principles:
- c. Efficiency:¹ d. Capital Cost:
- e. Useful Life: f. Operating Cost:
- g. Energy:² h. Maintenance Cost:
- i. Availability of construction materials and process chemicals:
- j. Applicability to manufacturing processes:
- k. Ability to construct with control device, install in available space, and operate within proposed levels:

2.

- a. Control Device: b. Operating Principles:
- c. Efficiency:¹ d. Capital Cost:
- e. Useful Life: f. Operating Cost:
- g. Energy:² h. Maintenance Cost:
- i. Availability of construction materials and process chemicals:

¹Explain method of determining efficiency.

²Energy to be reported in units of electrical power - KWH design rate.

j. Applicability to manufacturing processes:

k. Ability to construct with control device, install in available space, and operate within proposed levels:

3.

a. Control Device:

b. Operating Principles:

c. Efficiency:¹

d. Capital Cost:

e. Useful Life:

f. Operating Cost:

g. Energy:²

h. Maintenance Cost:

i. Availability of construction materials and process chemicals:

j. Applicability to manufacturing processes:

k. Ability to construct with control device, install in available space, and operate within proposed levels:

4.

a. Control Device:

b. Operating Principles:

c. Efficiency:¹

d. Capital Costs:

e. Useful Life:

f. Operating Cost:

g. Energy:²

h. Maintenance Cost:

i. Availability of construction materials and process chemicals:

j. Applicability to manufacturing processes:

k. Ability to construct with control device, install in available space, and operate within proposed levels:

F. Describe the control technology selected:

1. Control Device:

2. Efficiency:¹

3. Capital Cost:

4. Useful Life:

5. Operating Cost:

6. Energy:²

7. Maintenance Cost:

8. Manufacturer:

9. Other locations where employed on similar processes:

a. (1) Company:

(2) Mailing Address:

(3) City:

(4) State:

¹Explain method of determining efficiency.

²Energy to be reported in units of electrical power - KWH design rate.

- (5) Environmental Manager:
- (6) Telephone No.:
- (7) Emissions:¹

Contaminant	Rate or Concentration

(8) Process Rate:¹

b. (1) Company:

(2) Mailing Address:

(3) City:

(4) State:

(5) Environmental Manager:

(6) Telephone No.:

(7) Emissions:¹

Contaminant	Rate or Concentration

(8) Process Rate:¹

10. Reason for selection and description of systems:

¹Applicant must provide this information when available. Should this information not be available, applicant must state the reason(s) why.

SECTION VII - PREVENTION OF SIGNIFICANT DETERIORATION

Not Applicable

A. Company Monitored Data

1. _____ no. sites _____ TSP _____ () SO₂* _____ Wind spd/dir

Period of Monitoring _____ / _____ / _____ to _____ / _____ / _____
month day year month day year

Other data recorded _____

Attach all data or statistical summaries to this application.

*Specify bubbler (B) or continuous (C).

2. Instrumentation, Field and Laboratory

- a. Was instrumentation EPA referenced or its equivalent? Yes No
- b. Was instrumentation calibrated in accordance with Department procedures?
 Yes No Unknown

B. Meteorological Data Used for Air Quality Modeling

- 1. _____ Year(s) of data from _____ / _____ / _____ to _____ / _____ / _____
month day year month day year
- 2. Surface data obtained from (location) _____
- 3. Upper air (mixing height) data obtained from (location) _____
- 4. Stability wind rose (STAR) data obtained from (location) _____

C. Computer Models Used

- 1. _____ Modified? If yes, attach description.
- 2. _____ Modified? If yes, attach description.
- 3. _____ Modified? If yes, attach description.
- 4. _____ Modified? If yes, attach description.

Attach copies of all final model runs showing input data, receptor locations, and principle output tables.

D. Applicants Maximum Allowable Emission Data

Pollutant	Emission Rate
TSP	_____ grams/sec
SO ²	_____ grams/sec

E. Emission Data Used in Modeling

Attach list of emission sources. Emission data required is source name, description of point source (on NEDS point number), UTM coordinates, stack data, allowable emissions, and normal operating time.

F. Attach all other information supportive to the PSD review.

G. Discuss the social and economic impact of the selected technology versus other applicable technologies (i.e., jobs, payroll, production, taxes, energy, etc.). Include assessment of the environmental impact of the sources.

H. Attach scientific, engineering, and technical material, reports, publications, journals, and other competent relevant information describing the theory and application of the requested best available control technology.

ATTACHMENT A
PROCESS DESCRIPTION

Georgia-Pacific Corporation (G-P) owns and operates a kraft pulp mill located in Palatka, Florida. On April 29, 1988, the Florida Department of Environmental Regulation (FDER) issued a construction permit (AC54-142282) to G-P to allow certain changes to its existing digester system in order to comply with the FDER's total reduced sulfur (TRS) rules. A flow diagram of the modified digester system, which is now in operation at G-P, is shown in Figure A-1. A typical batch digester/blow tank/accumulator flow sheet is presented in Figure A-2.

As shown in Figure A-1, the digesting system at G-P consists of thirteen (13) batch digesters, three (3) blow tanks, and one (1) accumulator tank. The system is arranged such that No. 1 through No. 6 Digesters can discharge either to No. 1 or No. 2 Blow Tank, No. 7 and No. 8 Digesters can discharge to either of the three blow tanks, and No. 9 through No. 13 Digesters can discharge to either No. 2 or No. 3 Blow Tank. All three blow tanks discharge to the No. 3 Accumulator Tank. Non-condensable gases from the No. 3 Accumulator Tank are collected and sent to the TRS Incinerator for destruction of TRS.

G-P is currently proposing to replace two of the existing digesters due to wall thickness on the pressure vessels (Digester Nos. 10 and 13). As part of the replacement, these digesters will be increased in size from the present 3,900 ft³ to 4,900 ft³, to standardize them with the majority of the other digesters. The maximum process rate of the digester system will not increase as a result of this change.

The current and future maximum input of raw materials to the digesters and the maximum product weights are based upon the following:

Maximum 24-hour average pulp production:

- = 1,850 TPD air dried pulp (ADP) (@10% H₂O)
- = 154,167 lb/hr ADP, daily average (@10% H₂O)

- = 1,665 TPD ADP (dry)
- = 138,750 lb/hr ADP, daily average (dry)

Maximum 1-hour pulp production:

- = 235,970 lb/hr ADP (@10% H₂O)
- = 118.0 TPH ADP (@10% H₂O)

0.5 tons pulp (dry) = 1.05 tons wood chips (dry)
White liquor (S.G.=1.16)= 9.67 lb/gal
White liquor usage (avg)= 760 gal/ton ADP
Black liquor (S.G.=1.04)= 8.67 lb/gal
Black liquor usage (avg)= 250 gal/ton ADP

Input Rates (Maximum 24-hour average):

- (1) Wood chips
 $1,665 \text{ TPD pulp (dry)} \times 1.05 \text{ ton chips}/0.5 \text{ tons pulp (dry)}$
 $= 3,497 \text{ TPD wood chips (dry)}$
 $3,497 \text{ TPD wood chips (dry)} / 24\text{-hr/day} \times 2000 \text{ lb/ton}$
 $= 291,417 \text{ lb/hr wood chips (dry)}$
- (2) White liquor
 $1,850 \text{ TPD ADP} \times 760 \text{ gal/ton ADP} \times 9.67 \text{ lb/gal} / 24\text{-hr/day}$
 $= 566,501 \text{ lb/hr}$
- (3) Black liquor
 $1,850 \text{ TPD ADP} \times 250 \times 8.67 / 24$
 $= 167,078 \text{ lb/hr}$
- (4) Total input rate
 $291,417 + 566,501 + 167,078 = 1,024,996 \text{ lb/hr}$

Product Rates (Maximum 24-hour average):

- (1) Pulp
 $1,850 \text{ TPD ADP} \times 2000 \text{ lb/ton} / 24\text{-hr/day}$
 $= 154,167 \text{ lb/hr ADP}$
 $1,665 \text{ TPD Pulp (dry)} \times 2000 / 24$
 $= 138,750 \text{ lb/hr pulp (dry)}$
- (2) Black liquor
Black liquor solids (BLS) produced = 3100 lb/ton ADUP
 $1,850 \text{ TPD ADP} \times 3100 \text{ lb/ton} = 5.735 \times 10^6 \text{ lb/day BLS}$
 $= 238,958 \text{ lb/hr BLS}$

ATTACHMENT B
TRS EMISSION ESTIMATES

TRS emission estimates are based upon TRS testing at other pulp mills, published data and engineering judgment. The design flow of non-condensable gases from the No. 3 Accumulator Tank, as provided by A.H. Lundberg Associates, Inc., is as follows:

440 acfm @ 120°F

TRS (as sulfur) emissions - 196 lb/hr

Because of the potential variability in TRS emissions from the process, maximum TRS emissions (as sulfur) for permitting purposes are as follows:

Maximum 24-hr average: 196 lb/hr

Maximum 3-hr average: 300 lb/hr

Maximum annual average: $196 \text{ lb/hr} \times 8,760 \text{ hr/yr} / 2,000 \text{ lb/ton}$
= 858 TPY

The TRS emissions from the digester system are controlled by venting the gases to the TRS incinerator.

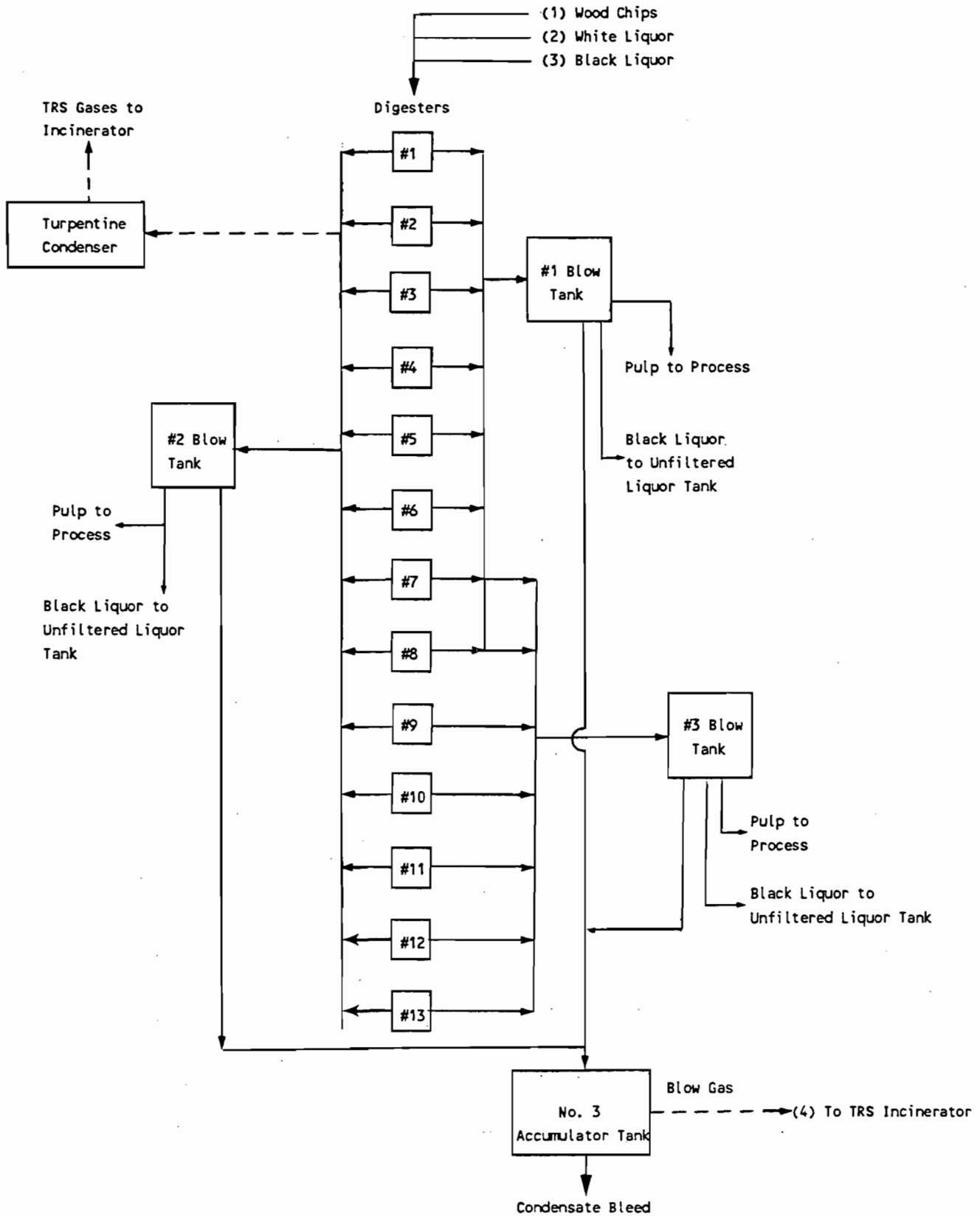

Figure A-1. Flow Diagram of G-P Digester System

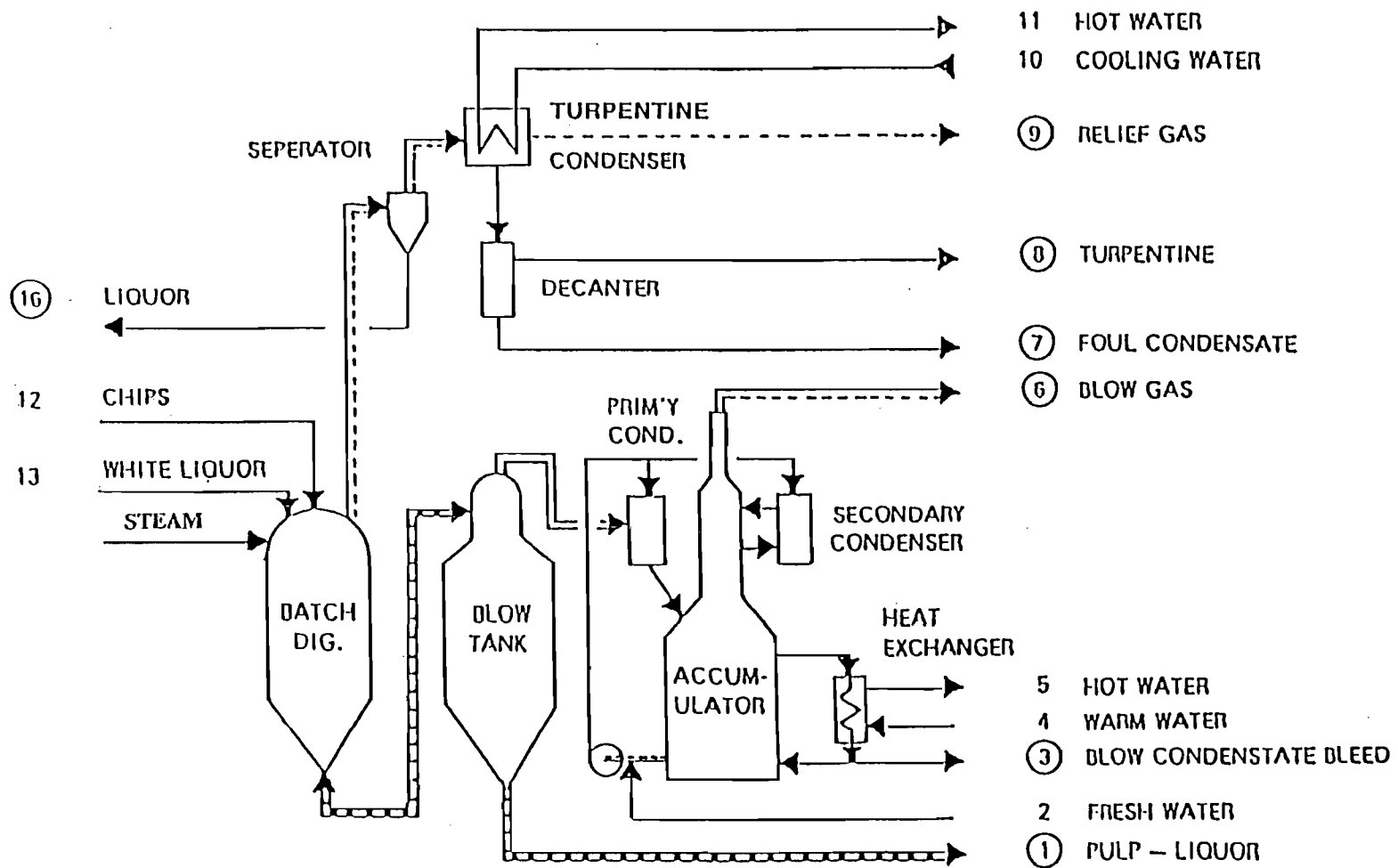

FIGURE A-2. BATCH DIGESTER FLOW SHEET (TYPICAL)



Georgia-Pacific

PULP AND PAPER MANUFACTURING DIVISION
PALATKA OPERATIONS • PALATKA, FL 32077



FIRSTATLANTA
The First National Bank of Atlanta
Augusta, Georgia

64-1327
611

No. 010154

VOID AFTER 60 DAYS

NET AMOUNT

\$ ****2,500.00

CHECK NO.	VENDOR NO.	DATE
010154	S7055	09/13/89

PAY EXACTLY

****2,500 DOLLARS AND 00 CENTS

PERSONAL SIGNATURE REQUIRED IF
AMOUNT IS \$25,000.00 OR OVER

TO THE ORDER OF
STATE OF FLA, DEPT OF ENVIRONMENTAL
3426 BILLS ROAD
JACKSONVILLE, FLORIDA 32207

Georgia-Pacific Corporation
PULP AND PAPER MANUFACTURING DIVISION
PALATKA OPERATIONS • GENERAL ACCOUNT

[Signature]
[Signature]

FIRST CLASS

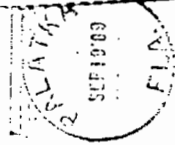

Georgia-Pacific

Palatka Operations
Southern Pulp & Paper Division
P.O. Box 919
Palatka, FL 32078-0919

CERTIFIED MAIL

Mr. Mike Harley
Florida Department of
Environmental Regulation
2600 Blairstone Road
Tallahassee, Florida 32399-2

1031

CERTIFIED MAIL

RETURN RECEIPT REQUESTED



IC