



Jeb Bush  
Governor

# Department of Environmental Protection

Twin Towers Office Building  
2600 Blair Stone Road  
Tallahassee, Florida 32399-2400

Colleen M. Castille  
Secretary

August 31, 2005

Mr. John Bunyak, Chief  
Policy, Planning & Permit Review Branch  
NPS – Air Quality Division  
P. O. Box 25287  
Denver, Colorado 80225

RE: Mosaic Fertilizer, Inc.  
Green Bay Facility  
1050053-041-AC, PSD-FL-359

Dear Mr. Bunyak:

Enclosed for your review and comment is a PSD application submitted by Mosaic Fertilizer, Inc. for a modification to their ammoniated phosphate plants at the Green Bay facility in Polk County, Florida.

Your comments may be forwarded to my attention at the letterhead address or faxed to the Bureau of Air Regulation at 850/921-9533. If you have any questions, please contact Syed Arif, review engineer, at 850/921-9528.

Sincerely,

*for* Jeffrey F. Koerner, P.E., Administrator  
North Permitting Section

JFK/pa

Enclosure

cc: S. Arif

"More Protection, Less Process"

Printed on recycled paper.



Jeb Bush  
Governor

# Department of Environmental Protection

Twin Towers Office Building  
2600 Blair Stone Road  
Tallahassee, Florida 32399-2400

Colleen M. Castille  
Secretary

August 31, 2005

Mr. Gregg M. Worley, Chief  
Air Permits Section  
U.S. EPA, Region 4  
61 Forsyth Street  
Atlanta, Georgia 30303-8960

RE: Mosaic Fertilizer, Inc.  
Green Bay Facility  
1050053-041-AC, PSD-FL-359

Dear Mr. Worley:

Enclosed for your review and comment is a PSD application submitted by Mosaic Fertilizer, Inc. for a modification to their ammoniated phosphate plants at the Green Bay facility in Polk County, Florida.

Your comments may be forwarded to my attention at the letterhead address or faxed to the Bureau of Air Regulation at 850/921-9533. If you have any questions, please contact Syed Arif, review engineer, at 850/921-9528.

Sincerely,

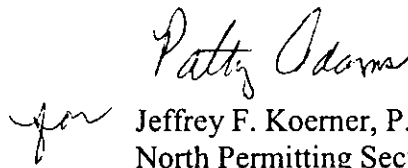

Jeffrey F. Koerner, P.E., Administrator  
North Permitting Section

JFK/pa

Enclosure

cc: S. Arif

"More Protection, Less Process"

Printed on recycled paper.

**Golder Associates Inc.**

6241 NW 23rd Street, Suite 500  
Gainesville, FL USA 32653  
Telephone (352) 336-5600  
Fax (352) 336-6603  
www.golder.com

August 24, 2005

Florida Department of Environmental Protection  
Division of Air Resource Management  
2600 Blair Stone Road MS 5500  
Tallahassee, Florida 32399-2400

Attention: Syed Arif, Air Permitting

RE: MOSAIC FERTILIZER, INC.  
GREEN BAY FACILITY  
PSD APPLICATION FOR THE AMMONIATED PHOSPHATES  
FERTILIZER PLANTS  
FACILITY ID NO. 1050053

Dear Mr. Arif:

Please find enclosed seven (7) copies of the PSD permit application for the modification of the ammoniated phosphates plants at the Mosaic Fertilizer Green Bay facility. If you have any questions, please do not hesitate to call me at (352) 336-5600.

Sincerely,

GOLDER ASSOCIATES INC.

*SAL MOHAMMAD*

<sup>for</sup>  
David A. Buff, P.E., Q.E.P.  
Principal Engineer

cc: Elizabeth Foeller

Y:\Projects\2005\0537573 Mosaic Green Bay\4.1\1.082405.doc



RECEIVED

0537573

AUG 25 2005

BUREAU OF AIR REGULATION





**EXP**

Parcels:

**1/1**

DEP AIR RESOURCE MGMT  
P. Adams  
DIRECTOR OFFICE STE 23  
111 S MAGNOLIA DR  
TALLAHASSEE, FL 32301  
UNITED STATES Tel: 850-921-9505  
DEP Southwest District Office  
W. Jason Waters  
3804 Coconut Palm Drive  
Air Resources  
Tampa, FL 33619  
UNITED STATES

ORIGIN:  
**TLH**

Sender's ref  
37550201000 A7 AP255

POSTCODE:  
**33619**

Tel: 813-744-6100

Description: PSD-FL-359 application

Weight: 4 lbs for 1 pcs  
Date: 2005-08-31

DHL standard terms and conditions apply.

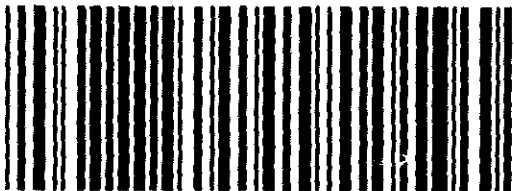

**ALEX 7D  
FSC**

(2L)US33619

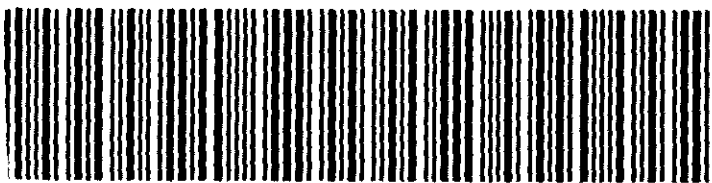

WAYBILL: 27678123852

(Non-Negotiable)





Please fold or cut in half  
**DO NOT PHOTOCOPY**

Using a photocopy could delay the delivery of your package and will result in additional shipping charge

**SENDER'S RECEIPT**

Waybill #: 27678223355

To(Company):  
U.S. EPA Region 4  
Air Permits Section  
61 Forsyth Street

Atlanta, GA 30303  
UNITED STATES

Attention To: Mr. Gregg M. Worley  
Phone#: 404-562-9141

Sent By: P. Adams  
Phone#: 850-921-9505

Rate Estimate: 6.1  
Protection: Not Required  
Description: PSD-FL-359 application

Weight (lbs.): 4  
Dimensions: 0 x 0 x 0

Ship Ref: 37550201000 A7 AP255  
Service Level: Next Day 12:00 (Next  
business day by 12 PM)

Special Svc:

Date Printed: 8/31/2005  
Bill Shipment To: Sender  
Bill To Acct: 778941286

DHL Signature (optional) \_\_\_\_\_ Route \_\_\_\_\_ Date \_\_\_\_\_ Time \_\_\_\_\_

For Tracking, please go to [www.dhl-usa.com](http://www.dhl-usa.com) or call 1-800-225-5345

Thank you for shipping with DHL

Create new shipment

View pending shipments

Print waybill



PEEL HERE

PEEL HERE ▲

Please fold or cut in half  
**DO NOT PHOTOCOPY**

Using a photocopy could delay the delivery of your package and will result in additional shipping charge

**SENDER'S RECEIPT**

Waybill #: 27678123852

To(Company):  
DEP Southwest District Office  
Air Resources  
3804 Coconut Palm Drive  
Tampa, FL 33619  
UNITED STATES

Attention To: Mr. Jason Waters  
Phone#: 813-744-6100

Sent By: P. Adams  
Phone#: 850-921-9505

Rate Estimate: 6.1  
Protection: Not Required  
Description: PSD-FL-359 application

Weight (lbs.): 4  
Dimensions: 0 x 0 x 0

Ship Ref: 37550201000 A7 AP255  
Service Level: Next Day 12:00 (Next  
business day by 12 PM)

Special Svc:

Date Printed: 8/31/2005  
Bill Shipment To: Sender  
Bill To Acct: 778941286

DHL Signature (optional) \_\_\_\_\_ Route \_\_\_\_\_ Date \_\_\_\_\_ Time \_\_\_\_\_

For Tracking, please go to [www.dhl-usa.com](http://www.dhl-usa.com) or call 1-800-225-5345

Thank you for shipping with DHL

Create new shipment ▶

▶ View pending shipments

Print waybill ▶



**RECEIVED**

AUG 25 2005

BUREAU OF AIR REGULATION

**PSD APPLICATION FOR  
AMMONIATED PHOSPHATES PLANTS  
MOSAIC FERTILIZER, INC.  
GREENBAY FACILITY  
BARTOW, FLORIDA**

**Prepared For:  
Mosaic Fertilizer, Inc.  
4390 C.R. 640 West  
Bartow, Florida 33830**

**Prepared By:  
Golder Associates Inc.  
6241 NW 23rd Street, Suite 500  
Gainesville, Florida 32653-1500**

**August 2005**

**0537573**

**DISTRIBUTION:  
7 Copies – FDEP  
2 Copies – Mosaic Fertilizer, Inc.  
1 Copy – Golder Associates Inc.**

**APPLICATION FORM**



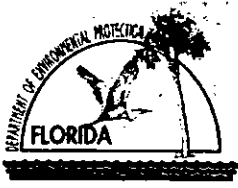

# Department of Environmental Protection

## Division of Air Resource Management

### APPLICATION FOR AIR PERMIT - LONG FORM

#### I. APPLICATION INFORMATION

**Air Construction Permit** – Use this form to apply for an air construction permit for a proposed project:

- subject to prevention of significant deterioration (PSD) review, nonattainment area (NAA) new source review, or maximum achievable control technology (MACT) review; or
- where the applicant proposes to assume a restriction on the potential emissions of one or more pollutants to escape a federal program requirement such as PSD review, NAA new source review, Title V, or MACT; or
- at an existing federally enforceable state air operation permit (FESOP) or Title V permitted facility.

**Air Operation Permit** – Use this form to apply for:

- an initial federally enforceable state air operation permit (FESOP); or
- an initial/revised/renewal Title V air operation permit.

**Air Construction Permit & Revised/Renewal Title V Air Operation Permit (Concurrent Processing Option)** – Use this form to apply for both an air construction permit and a revised or renewal Title V air operation permit incorporating the proposed project.

To ensure accuracy, please see form instructions.

#### Identification of Facility

1. Facility Owner/Company Name: <b>Mosaic Fertilizer, LLC</b>	
2. Site Name: <b>Green Bay Facility</b>	
3. Facility Identification Number: <b>1050053</b>	
4. Facility Location...: Street Address or Other Locator: <b>4390 C.R. 640 West</b> City: <b>Bartow</b> County: <b>Polk</b> Zip Code: <b>33830</b>	
5. Relocatable Facility? <input type="checkbox"/> Yes <input checked="" type="checkbox"/> No	6. Existing Title V Permitted Facility? <input checked="" type="checkbox"/> Yes <input type="checkbox"/> No

#### Application Contact

1. Application Contact Name: <b>Elizabeth Foeller, Environmental Superintendent</b>	
2. Application Contact Mailing Address... Organization/Firm: <b>Mosaic Fertilizer, LLC</b> Street Address: <b>4390 C.R. 640 West</b> City: <b>Bartow</b> State: <b>Florida</b> Zip Code: <b>33830</b>	
3. Application Contact Telephone Numbers... Telephone: <b>(863) 519- 1371</b> ext.      Fax: <b>(863) 519- 1213</b>	
4. Application Contact Email Address: <b>Elizabeth.Foeller@mosaicco.com</b>	

#### Application Processing Information (DEP Use)

1. Date of Receipt of Application:	<i>8-25-05</i>
2. Project Number(s):	<i>1050053-041-AL</i>
3. PSD Number (if applicable):	<i>PSD-FL-359</i>
4. Siting Number (if applicable):	

**APPLICATION INFORMATION**

**Purpose of Application**

**This application for air permit is submitted to obtain: (Check one)**

**Air Construction Permit**

Air construction permit.

**Air Operation Permit**

- Initial Title V air operation permit.
- Title V air operation permit revision.
- Title V air operation permit renewal.
- Initial federally enforceable state air operation permit (FESOP) where professional engineer (PE) certification is required.
- Initial federally enforceable state air operation permit (FESOP) where professional engineer (PE) certification is not required.

**Air Construction Permit and Revised/Renewal Title V Air Operation Permit  
(Concurrent Processing)**

- Air construction permit and Title V permit revision, incorporating the proposed project.
- Air construction permit and Title V permit renewal, incorporating the proposed project.

**Note: By checking one of the above two boxes, you, the applicant, are requesting concurrent processing pursuant to Rule 62-213.405, F.A.C. In such case, you must also check the following box:**

- I hereby request that the department waive the processing time requirements of the air construction permit to accommodate the processing time frames of the Title V air operation permit.

**Application Comment**

**Application is for the proposed modification of the South AP Fertilizer Plant and the North MAP/DAP Granulation Plant. The North MAP/DAP granulation Plant will be renamed as the North AP Fertilizer Plant. Both plants are capable of producing MAP and DAP.**



**APPLICATION INFORMATION**

**Owner/Authorized Representative Statement**

**Complete if applying for an air construction permit or an initial FESOP.**

1. Owner/Authorized Representative Name : <b>Mr. Doug Belle, Plant Manager</b>
2. Owner/Authorized Representative Mailing Address... Organization/Firm: <b>Mosaic Fertilizer, LLC</b> Street Address: <b>4390 County Road 640</b> City: <b>Bartow</b> State: <b>FL</b> Zip Code: <b>33830</b>
3. Owner/Authorized Representative Telephone Numbers... Telephone: <b>(863) 519-1321</b> ext. Fax: <b>(863) 519-1213</b>
4. Owner/Authorized Representative Email Address: <b>d.belle@mosaicco.com</b>
5. Owner/Authorized Representative Statement:  <i>I, the undersigned, am the owner or authorized representative of the facility addressed in this air permit application. I hereby certify, based on information and belief formed after reasonable inquiry, that the statements made in this application are true, accurate and complete and that, to the best of my knowledge, any estimates of emissions reported in this application are based upon reasonable techniques for calculating emissions. The air pollutant emissions units and air pollution control equipment described in this application will be operated and maintained so as to comply with all applicable standards for control of air pollutant emissions found in the statutes of the State of Florida and rules of the Department of Environmental Protection and revisions thereof and all other requirements identified in this application to which the facility is subject. I understand that a permit, if granted by the department, cannot be transferred without authorization from the department, and I will promptly notify the department upon sale or legal transfer of the facility or any permitted emissions unit.</i>   _____ Signature  <u>8/23/05</u> _____ Date

**APPLICATION INFORMATION**

**Application Responsible Official Certification**

**Complete if applying for an initial/ revised/ renewal Title V permit or concurrent processing of an air construction permit and a revised/ renewal Title V permit. If there are multiple responsible officials, the "application responsible official" need not be the "primary responsible official."**

1. Application Responsible Official Name:
2. Application Responsible Official Qualification (Check one or more of the following options, as applicable): <input type="checkbox"/> For a corporation, the president, secretary, treasurer, or vice-president of the corporation in charge of a principal business function, or any other person who performs similar policy or decision-making functions for the corporation, or a duly authorized representative of such person if the representative is responsible for the overall operation of one or more manufacturing, production, or operating facilities applying for or subject to a permit under Chapter 62-213, F.A.C. <input type="checkbox"/> For a partnership or sole proprietorship, a general partner or the proprietor, respectively. <input type="checkbox"/> For a municipality, county, state, federal, or other public agency, either a principal executive officer or ranking elected official. <input type="checkbox"/> The designated representative at an Acid Rain source.
3. Application Responsible Official Mailing Address... Organization/Firm: Street Address: <div style="display: flex; justify-content: space-between; margin-top: 10px;"> <span>City:</span> <span>State:</span> <span>Zip Code:</span> </div>
4. Application Responsible Official Telephone Numbers... Telephone: (    )                      ext.                      Fax:    (    )
5. Application Responsible Official Email Address:
6. Application Responsible Official Certification:  <i>I, the undersigned, am a responsible official of the Title V source addressed in this air permit application. I hereby certify, based on information and belief formed after reasonable inquiry, that the statements made in this application are true, accurate and complete and that, to the best of my knowledge, any estimates of emissions reported in this application are based upon reasonable techniques for calculating emissions. The air pollutant emissions units and air pollution control equipment described in this application will be operated and maintained so as to comply with all applicable standards for control of air pollutant emissions found in the statutes of the State of Florida and rules of the Department of Environmental Protection and revisions thereof and all other applicable requirements identified in this application to which the Title V source is subject. I understand that a permit, if granted by the department, cannot be transferred without authorization from the department, and I will promptly notify the department upon sale or legal transfer of the facility or any permitted emissions unit. Finally, I certify that the facility and each emissions unit are in compliance with all applicable requirements to which they are subject, except as identified in compliance plan(s) submitted with this application.</i>  <div style="display: flex; justify-content: space-between; margin-top: 20px;"> <span>_____</span> <span>_____</span> </div> <div style="display: flex; justify-content: space-between; margin-top: 5px;"> <span>Signature</span> <span>Date</span> </div>

# APPLICATION INFORMATION

## Professional Engineer Certification

1. Professional Engineer Name: <b>David A. Buff</b> Registration Number: <b>19011</b>
2. Professional Engineer Mailing Address... Organization/Firm: <b>Golder Associates Inc.**</b> Street Address: <b>6241 NW 23<sup>rd</sup> Street, Suite 500</b> City: <b>Gainesville</b> State: <b>FL</b> Zip Code: <b>32653-1500</b>
3. Professional Engineer Telephone Numbers... Telephone: <b>(352) 336-5600</b> ext. <b>545</b> Fax: <b>(352) 336-6603</b>
4. Professional Engineer Email Address: <b>dbuff@golder.com</b>
5. Professional Engineer Statement: <i>I, the undersigned, hereby certify, except as particularly noted herein*, that:</i>  <i>(1) To the best of my knowledge, there is reasonable assurance that the air pollutant emissions unit(s) and the air pollution control equipment described in this application for air permit, when properly operated and maintained, will comply with all applicable standards for control of air pollutant emissions found in the Florida Statutes and rules of the Department of Environmental Protection; and</i>  <i>(2) To the best of my knowledge, any emission estimates reported or relied on in this application are true, accurate, and complete and are either based upon reasonable techniques available for calculating emissions or, for emission estimates of hazardous air pollutants not regulated for an emissions unit addressed in this application, based solely upon the materials, information and calculations submitted with this application.</i>  <i>(3) If the purpose of this application is to obtain a Title V air operation permit (check here <input type="checkbox"/>, if so), I further certify that each emissions unit described in this application for air permit, when properly operated and maintained, will comply with the applicable requirements identified in this application to which the unit is subject, except those emissions units for which a compliance plan and schedule is submitted with this application.</i>  <i>(4) If the purpose of this application is to obtain an air construction permit (check here <input checked="" type="checkbox"/>, if so) or concurrently process and obtain an air construction permit and a Title V air operation permit revision or renewal for one or more proposed new or modified emissions units (check here <input type="checkbox"/>, if so), I further certify that the engineering features of each such emissions unit described in this application have been designed or examined by me or individuals under my direct supervision and found to be in conformity with sound engineering principles applicable to the control of emissions of the air pollutants characterized in this application.</i>  <i>(5) If the purpose of this application is to obtain an initial air operation permit or operation permit revision or renewal for one or more newly constructed or modified emissions units (check here <input type="checkbox"/>, if so), I further certify that, with the exception of any changes detailed as part of this application, each such emissions unit has been constructed or modified in substantial accordance with the information given in the corresponding application for air construction permit and with all provisions contained in such permit.</i>  _____ Signature <i>David A. Buff</i> Date <i>8/22/05</i>  (seal)

\* Attach any exception to certification statement.

\*\* Board of Professional Engineers Certificate of Authorization #00001670

## II. FACILITY INFORMATION

### A. GENERAL FACILITY INFORMATION

**Facility Location and Type**

1. Facility UTM Coordinates... Zone 17      East (km) <b>409.5</b> North (km) <b>3080.1</b>		2. Facility Latitude/Longitude... Latitude (DD/MM/SS) <b>27/50/39</b> Longitude (DD/MM/SS) <b>81/56/26</b>	
3. Governmental Facility Code: <b>0</b>	4. Facility Status Code: <b>A</b>	5. Facility Major Group SIC Code: <b>28</b>	6. Facility SIC(s): <b>2874, 2819</b>
7. Facility Comment :			

**Facility Contact**

1. Facility Contact Name: <b>Elizabeth Foeller, Environmental Superintendent</b>
2. Facility Contact Mailing Address... Organization/Firm: <b>Mosaic Fertilizer, LLC</b> Street Address: <b>4390 C.R. 640 West</b> <div style="text-align: center; margin-top: 5px;">                     City: <b>Bartow</b>                      State: <b>FL</b>                      Zip Code: <b>33830</b> </div>
3. Facility Contact Telephone Numbers: Telephone: <b>(863) 519-1371</b> ext.      Fax: <b>(863) 519-1213</b>
4. Facility Contact Email Address: <b>Elizabeth.Foeller@mosaicco.com</b>

**Facility Primary Responsible Official**

**Complete if an "application responsible official" is identified in Section I. that is not the facility "primary responsible official."**

1. Facility Primary Responsible Official Name:
2. Facility Primary Responsible Official Mailing Address... Organization/Firm: Street Address: <div style="text-align: center; margin-top: 5px;">                     City:                      State:                      Zip Code:                 </div>
3. Facility Primary Responsible Official Telephone Numbers... Telephone: (    ) -                      ext.      Fax: (    ) -
4. Facility Primary Responsible Official Email Address:

**Facility Regulatory Classifications**

Check all that would apply *following* completion of all projects and implementation of all other changes proposed in this application for air permit. Refer to instructions to distinguish between a “major source” and a “synthetic minor source.”

1. <input type="checkbox"/> Small Business Stationary Source	<input type="checkbox"/> Unknown
2. <input type="checkbox"/> Synthetic Non-Title V Source	
3. <input checked="" type="checkbox"/> Title V Source	
4. <input checked="" type="checkbox"/> Major Source of Air Pollutants, Other than Hazardous Air Pollutants (HAPs)	
5. <input type="checkbox"/> Synthetic Minor Source of Air Pollutants, Other than HAPs	
6. <input checked="" type="checkbox"/> Major Source of Hazardous Air Pollutants (HAPs)	
7. <input type="checkbox"/> Synthetic Minor Source of HAPs	
8. <input checked="" type="checkbox"/> One or More Emissions Units Subject to NSPS (40 CFR Part 60)	
9. <input type="checkbox"/> One or More Emissions Units Subject to Emission Guidelines (40 CFR Part 60)	
10. <input checked="" type="checkbox"/> One or More Emissions Units Subject to NESHAP (40 CFR Part 61 or Part 63)	
11. <input type="checkbox"/> Title V Source Solely by EPA Designation (40 CFR 70.3(a)(5))	
12. Facility Regulatory Classifications Comment:	



**List of Pollutants Emitted by Facility**

1. Pollutant Emitted	2. Pollutant Classification	3. Emissions Cap [Y or N]?
Particulate Matter Total - PM	A	No
Particulate Matter - PM <sub>10</sub>	A	No
Sulfur Dioxide - SO <sub>2</sub>	A	No
Nitrogen Oxides - NO <sub>x</sub>	A	No
Sulfuric Acid Mist - SAM	A	No
Fluoride - FL	A	No
Hydrogen Fluoride - H107	A	No
Total Hazardous Air Pollutants – HAPs	A	No



### C. FACILITY ADDITIONAL INFORMATION

#### Additional Requirements for All Applications, Except as Otherwise Stated

1. Facility Plot Plan: (Required for all permit applications, except Title V air operation permit revision applications if this information was submitted to the department within the previous five years and would not be altered as a result of the revision being sought) <input checked="" type="checkbox"/> Attached, Document ID: <b>PSD Report</b> <input type="checkbox"/> Previously Submitted, Date: _____
2. Process Flow Diagram(s): (Required for all permit applications, except Title V air operation permit revision applications if this information was submitted to the department within the previous five years and would not be altered as a result of the revision being sought) <input checked="" type="checkbox"/> Attached, Document ID: <b>MGB-FI-C2</b> <input type="checkbox"/> Previously Submitted, Date: _____
3. Precautions to Prevent Emissions of Unconfined Particulate Matter: (Required for all permit applications, except Title V air operation permit revision applications if this information was submitted to the department within the previous five years and would not be altered as a result of the revision being sought) <input type="checkbox"/> Attached, Document ID: _____ <input checked="" type="checkbox"/> Previously Submitted, Date: <b>April 2003</b>

#### Additional Requirements for Air Construction Permit Applications

1. Area Map Showing Facility Location: <input checked="" type="checkbox"/> Attached, Document ID: <b>PSD Report</b> <input type="checkbox"/> Not Applicable (existing permitted facility)
2. Description of Proposed Construction or Modification: <input checked="" type="checkbox"/> Attached, Document ID: <b>PSD Report</b>
3. Rule Applicability Analysis: <input checked="" type="checkbox"/> Attached, Document ID: <b>PSD Report</b>
4. List of Exempt Emissions Units (Rule 62-210.300(3)(a) or (b)1., F.A.C.): <input type="checkbox"/> Attached, Document ID: _____ <input checked="" type="checkbox"/> Not Applicable (no exempt units at facility)
5. Fugitive Emissions Identification (Rule 62-212.400(2), F.A.C.): <input type="checkbox"/> Attached, Document ID: _____ <input checked="" type="checkbox"/> Not Applicable
6. Preconstruction Air Quality Monitoring and Analysis (Rule 62-212.400(5)(f), F.A.C.): <input checked="" type="checkbox"/> Attached, Document ID: <b>PSD Report</b> <input type="checkbox"/> Not Applicable
7. Ambient Impact Analysis (Rule 62-212.400(5)(d), F.A.C.): <input checked="" type="checkbox"/> Attached, Document ID: <b>PSD Report</b> <input type="checkbox"/> Not Applicable
8. Air Quality Impact since 1977 (Rule 62-212.400(5)(h)5., F.A.C.): <input checked="" type="checkbox"/> Attached, Document ID: <b>PSD Report</b> <input type="checkbox"/> Not Applicable
9. Additional Impact Analyses (Rules 62-212.400(5)(e)1. and 62-212.500(4)(e), F.A.C.): <input checked="" type="checkbox"/> Attached, Document ID: <b>PSD Report</b> <input type="checkbox"/> Not Applicable
10. Alternative Analysis Requirement (Rule 62-212.500(4)(g), F.A.C.): <input type="checkbox"/> Attached, Document ID: _____ <input checked="" type="checkbox"/> Not Applicable

**Additional Requirements for FESOP Applications**

1. List of Exempt Emissions Units (Rule 62-210.300(3)(a) or (b)1., F.A.C.):  
 Attached, Document ID: \_\_\_\_\_  Not Applicable (no exempt units at facility)

**Additional Requirements for Title V Air Operation Permit Applications**

1. List of Insignificant Activities (Required for initial/renewal applications only):  
 Attached, Document ID: \_\_\_\_\_  Not Applicable (revision application)
2. Identification of Applicable Requirements (Required for initial/renewal applications, and for revision applications if this information would be changed as a result of the revision being sought):  
 Attached, Document ID: \_\_\_\_\_  
 Not Applicable (revision application with no change in applicable requirements)
3. Compliance Report and Plan (Required for all initial/revision/renewal applications):  
 Attached, Document ID: \_\_\_\_\_  
Note: A compliance plan must be submitted for each emissions unit that is not in compliance with all applicable requirements at the time of application and/or at any time during application processing. The department must be notified of any changes in compliance status during application processing.
4. List of Equipment/Activities Regulated under Title VI (If applicable, required for initial/renewal applications only):  
 Attached, Document ID: \_\_\_\_\_  
 Equipment/Activities On site but Not Required to be Individually Listed  
 Not Applicable
5. Verification of Risk Management Plan Submission to EPA (If applicable, required for initial/renewal applications only) :  
 Attached, Document ID: \_\_\_\_\_  Not Applicable
6. Requested Changes to Current Title V Air Operation Permit:  
 Attached, Document ID: \_\_\_\_\_  Not Applicable

**Additional Requirements Comment**

[Empty box for Additional Requirements Comment]

**ATTACHMENT MGB-FI-C2**

**PROCESS FLOW DIAGRAM**

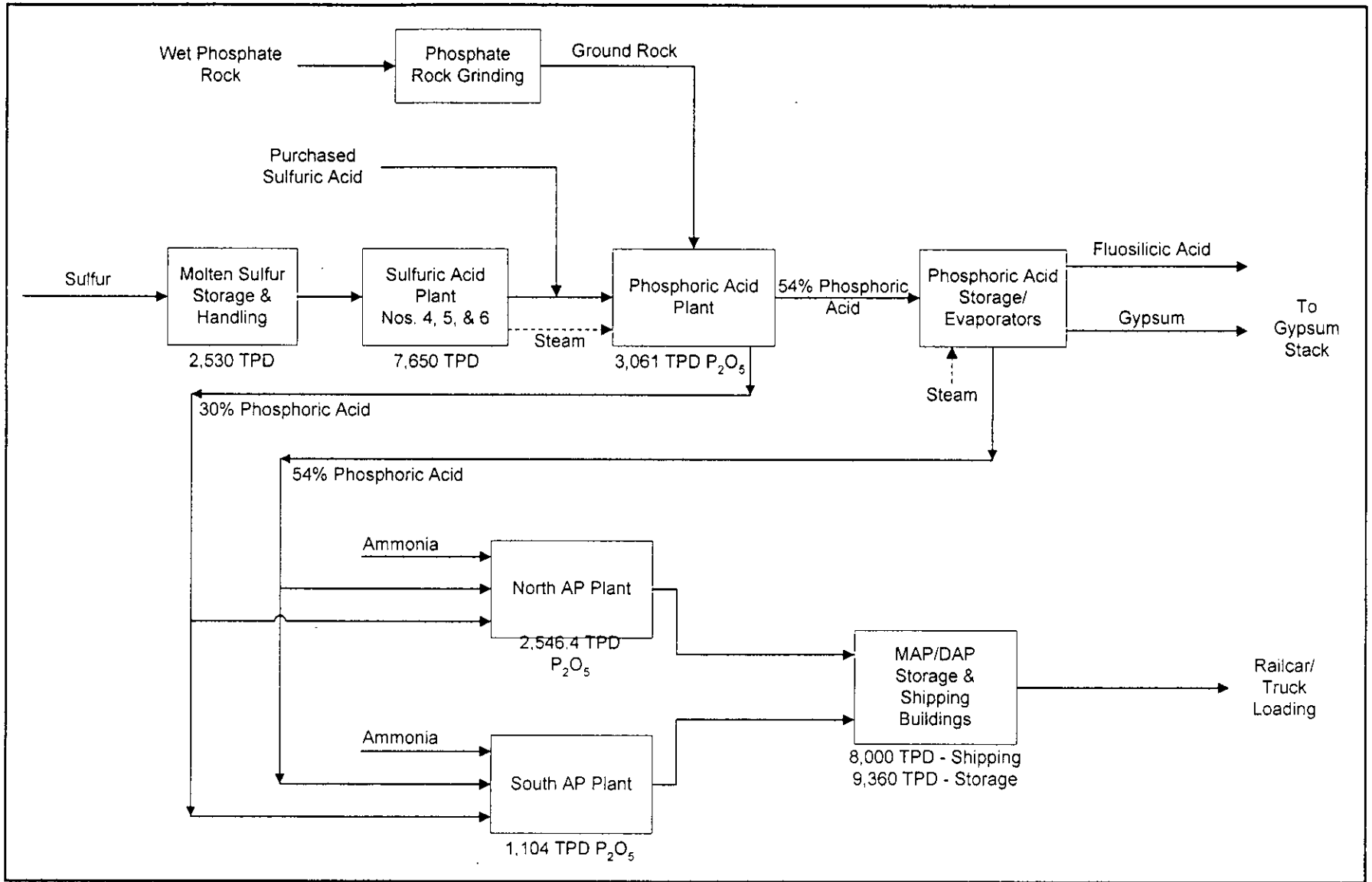

Attachment MGB-FI-C2  
 Mosaic Fertilizer, LLC - Green Bay  
 Future Facility Flow Diagram

**Process Flow Legend**

Solid/Liquid —————>  
 Gas - - - - ->  
 Steam - - - - ->

Filename: 0537573/4.4/MGB-FI-C2.VSD

Date: 08/23/05



## EMISSIONS UNIT INFORMATION

Section [1]  
South AP Plant

### III. EMISSIONS UNIT INFORMATION

**Title V Air Operation Permit Application** - For Title V air operation permitting only, emissions units are classified as regulated, unregulated, or insignificant. If this is an application for Title V air operation permit, a separate Emissions Unit Information Section (including subsections A through I as required) must be completed for each regulated and unregulated emissions unit addressed in this application for air permit. Some of the subsections comprising the Emissions Unit Information Section of the form are optional for unregulated emissions units. Each such subsection is appropriately marked. Insignificant emissions units are required to be listed at Section II, Subsection C.

**Air Construction Permit or FESOP Application** - For air construction permitting or federally enforceable state air operation permitting, emissions units are classified as either subject to air permitting or exempt from air permitting. The concept of an "unregulated emissions unit" does not apply. If this is an application for air construction permit or FESOP, a separate Emissions Unit Information Section (including subsections A through I as required) must be completed for each emissions unit subject to air permitting addressed in this application for air permit. Emissions units exempt from air permitting are required to be listed at Section II, Subsection C.

**Air Construction Permit and Revised/Renewal Title V Air Operation Permit Application** - Where this application is used to apply for both an air construction permit and a revised/renewal Title V air operation permit, each emissions unit is classified as either subject to air permitting or exempt from air permitting for air construction permitting purposes and as regulated, unregulated, or insignificant for Title V air operation permitting purposes. **The air construction permitting classification must be used to complete the Emissions Unit Information Section of this application for air permit.** A separate Emissions Unit Information Section (including subsections A through I as required) must be completed for each emissions unit subject to air permitting addressed in this application for air permit. Emissions units exempt from air construction permitting and insignificant emissions units are required to be listed at Section II, Subsection C.

If submitting the application form in hard copy, the number of this Emissions Unit Information Section and the total number of Emissions Unit Information Sections submitted as part of this application must be indicated in the space provided at the top of each page.

**EMISSIONS UNIT INFORMATION**

Section [1]  
South AP Plant

**A. GENERAL EMISSIONS UNIT INFORMATION**

**Title V Air Operation Permit Emissions Unit Classification**

1. Regulated or Unregulated Emissions Unit? (Check one, if applying for an initial, revised or renewal Title V air operation permit. Skip this item if applying for an air construction permit or FESOP only.)
- The emissions unit addressed in this Emissions Unit Information Section is a regulated emissions unit.
  - The emissions unit addressed in this Emissions Unit Information Section is an unregulated emissions unit.

**Emissions Unit Description and Status**

1. Type of Emissions Unit Addressed in this Section: (Check one)
- This Emissions Unit Information Section addresses, as a single emissions unit, a single process or production unit, or activity, which produces one or more air pollutants and which has at least one definable emission point (stack or vent).
  - This Emissions Unit Information Section addresses, as a single emissions unit, a group of process or production units and activities which has at least one definable emission point (stack or vent) but may also produce fugitive emissions.
  - This Emissions Unit Information Section addresses, as a single emissions unit, one or more process or production units and activities which produce fugitive emissions only.

2. Description of Emissions Unit Addressed in this Section:  
**South AP Fertilizer Plant (Ammoniated Phosphates Fertilizers Manufacturing)**

3. Emissions Unit Identification Number: **007**

4. Emissions Unit Status Code: <b>A</b>	5. Commence Construction Date:	6. Initial Startup Date:	7. Emissions Unit Major Group SIC Code: <b>28</b>	8. Acid Rain Unit? <input type="checkbox"/> Yes <input checked="" type="checkbox"/> No
--	--------------------------------	--------------------------	--	--

9. Package Unit:  
Manufacturer: \_\_\_\_\_ Model Number: \_\_\_\_\_

10. Generator Nameplate Rating: **MW**

11. Emissions Unit Comment:



**EMISSIONS UNIT INFORMATION**

**Section [1]  
South AP Plant**

**Emissions Unit Control Equipment**

1. Control Equipment/Method(s) Description:

**053 Four Venturi/Cyclonic Scrubbers**

**141 One Wet Scrubber**

2. Control Device or Method Code(s): **053, 141**



**EMISSIONS UNIT INFORMATION**

Section [1]  
 South AP Plant

**C. EMISSION POINT (STACK/VENT) INFORMATION**  
 (Optional for unregulated emissions units.)

**Emission Point Description and Type**

1. Identification of Point on Plot Plan or Flow Diagram: <b>AP Plants</b>		2. Emission Point Type Code: <b>3</b>	
3. Descriptions of Emission Points Comprising this Emissions Unit for VE Tracking: <b>Stack A</b> <b>Stack B</b>			
4. ID Numbers or Descriptions of Emission Units with this Emission Point in Common:			
5. Discharge Type Code: <b>V</b>	6. Stack Height: <b>129.5 feet</b>	7. Exit Diameter: <b>7.5 feet</b>	
8. Exit Temperature: <b>108 °F</b>	9. Actual Volumetric Flow Rate: <b>139,500 acfm</b>	10. Water Vapor: <b>%</b>	
11. Maximum Dry Standard Flow Rate: <b>dscfm</b>		12. Nonstack Emission Point Height: <b>feet</b>	
13. Emission Point UTM Coordinates... Zone: East (km): North (km):		14. Emission Point Latitude/Longitude... Latitude (DD/MM/SS) Longitude (DD/MM/SS)	
15. Emission Point Comment:  <b>Stack/vent information represents Stack B. Refer to Table 2-5 in PSD Report for a summary of stack/vent information for the South AP Plant.</b>			

**EMISSIONS UNIT INFORMATION**

Section [1]  
South AP Plant

**D. SEGMENT (PROCESS/FUEL) INFORMATION**

**Segment Description and Rate: Segment 1 of 4**

1. Segment Description (Process/Fuel Type):  <b>Chemical Manufacturing; Ammonium Phosphates; Ammoniator/Granulator.</b>		
2. Source Classification Code (SCC): <b>3-01-030-02</b>		3. SCC Units: <b>Tons P<sub>2</sub>O<sub>5</sub> Produced</b>
4. Maximum Hourly Rate: <b>46</b>	5. Maximum Annual Rate: <b>402,960</b>	6. Estimated Annual Activity Factor:
7. Maximum % Sulfur:	8. Maximum % Ash:	9. Million Btu per SCC Unit:
10. Segment Comment: <b>Maximum hourly rate of 46 TPH is the feed rate of material, expressed as 100% P<sub>2</sub>O<sub>5</sub>, which corresponds to 100 TPH of DAP and 92 TPH of MAP. Annual rate = 46 tons/hr x 8,760 hrs/yr = 402,960 TPY.</b>		

**Segment Description and Rate: Segment 2 of 4**

1. Segment Description (Process/Fuel Type):  <b>In-Process Fuel Use; Distillate Oil; Phosphoric Fertilizer Dryer</b>		
2. Source Classification Code (SCC): <b>3-90-005-99</b>		3. SCC Units: <b>1000 Gallons Burned</b>
4. Maximum Hourly Rate: <b>0.444</b>	5. Maximum Annual Rate: <b>3,893</b>	6. Estimated Annual Activity Factor:
7. Maximum % Sulfur: <b>0.05</b>	8. Maximum % Ash:	9. Million Btu per SCC Unit: <b>135</b>
10. Segment Comment: <b>Maximum hourly rate based on heat input rate of 60 MMBtu/hr.</b>		

**EMISSIONS UNIT INFORMATION**

Section [1]  
South AP Plant

**D. SEGMENT (PROCESS/FUEL) INFORMATION**

**Segment Description and Rate: Segment 3 of 4**

1. Segment Description (Process/Fuel Type):  <b>In-Process Fuel Use; Natural Gas; Phosphoric Fertilizer Dryer</b>		
2. Source Classification Code (SCC): <b>3-90-006-99</b>		3. SCC Units: <b>Million Cubic Feet Burned</b>
4. Maximum Hourly Rate: <b>0.06</b>	5. Maximum Annual Rate: <b>525.6</b>	6. Estimated Annual Activity Factor:
7. Maximum % Sulfur:	8. Maximum % Ash:	9. Million Btu per SCC Unit: <b>1,000</b>
10. Segment Comment: <b>Maximum hourly rate based on heat input rate of 60 MMBtu/hr.</b>		

**Segment Description and Rate: Segment 4 of 4**

1. Segment Description (Process/Fuel Type):  <b>In-Process Fuel Use; Liquified Petroleum Gas; Phosphoric Fertilizer Dryer</b>		
2. Source Classification Code (SCC): <b>3-90-010-99</b>		3. SCC Units: <b>1000 Gallons Burned</b>
4. Maximum Hourly Rate: <b>0.663</b>	5. Maximum Annual Rate: <b>5,808</b>	6. Estimated Annual Activity Factor:
7. Maximum % Sulfur: <b>*</b>	8. Maximum % Ash:	9. Million Btu per SCC Unit: <b>90.5</b>
10. Segment Comment: <b>Maximum hourly rate based on heat input rate of 60 MMBtu/hr.</b> <b>* Maximum sulfur content = 15 grains/100 ft<sup>3</sup>.</b>		



**EMISSIONS UNIT INFORMATION**

**POLLUTANT DETAIL INFORMATION**

Section [1]  
South AP Plant

Page [1] of [6]  
Particulate Matter Total - PM

**F1. EMISSIONS UNIT POLLUTANT DETAIL INFORMATION –  
POTENTIAL/ESTIMATED FUGITIVE EMISSIONS**

(Optional for unregulated emissions units.)

Potential/Estimated Fugitive Emissions

Complete for each pollutant identified in Subsection E if applying for an air construction permit or concurrent processing of an air construction permit and a revised or renewal Title V permit. Complete for each emissions-limited pollutant identified in Subsection E if applying for an air operation permit.

1. Pollutant Emitted: <b>PM</b>		2. Total Percent Efficiency of Control:	
3. Potential Emissions: <b>11.5 lb/hour                      50.4 tons/year</b>		4. Synthetically Limited? <input type="checkbox"/> Yes <input checked="" type="checkbox"/> No	
5. Range of Estimated Fugitive Emissions (as applicable): to                      tons/year			
6. Emission Factor: <b>0.25 lb/ton P<sub>2</sub>O<sub>5</sub></b>  Reference: <b>Proposed BACT</b>		7. Emissions Method Code: <b>0</b>	
8. Calculation of Emissions:  <b>0.25 lb/ton P<sub>2</sub>O<sub>5</sub> x 46 ton/hr P<sub>2</sub>O<sub>5</sub> = 11.5 lb/hr</b> <b>11.5 lb/hr x 8,760 hr/yr /2,000 lb/ton = 50.4 TPY</b>			
9. Pollutant Potential/Estimated Fugitive Emissions Comment: <b>Represents total emissions from Stacks A and B combined.</b>			

**EMISSIONS UNIT INFORMATION**

Section [1]  
South AP Plant

**POLLUTANT DETAIL INFORMATION**

Page [1] of [6]  
Particulate Matter Total - PM

**F2. EMISSIONS UNIT POLLUTANT DETAIL INFORMATION -  
ALLOWABLE EMISSIONS**

Complete if the pollutant identified in Subsection F1 is or would be subject to a numerical emissions limitation.

Allowable Emissions Allowable Emissions 1 of 1

1. Basis for Allowable Emissions Code: <b>OTHER</b>	2. Future Effective Date of Allowable Emissions:
3. Allowable Emissions and Units: <b>0.25 lb/ton P<sub>2</sub>O<sub>5</sub></b>	4. Equivalent Allowable Emissions: <b>11.5 lb/hour      50.4 tons/year</b>
5. Method of Compliance: <b>Annual stack emission test using EPA Method 5.</b>	
6. Allowable Emissions Comment (Description of Operating Method): <b>Proposed BACT limit.</b>	

Allowable Emissions Allowable Emissions \_\_\_\_ of \_\_\_\_

1. Basis for Allowable Emissions Code:	2. Future Effective Date of Allowable Emissions:
3. Allowable Emissions and Units:	4. Equivalent Allowable Emissions: lb/hour      tons/year
5. Method of Compliance:	
6. Allowable Emissions Comment (Description of Operating Method):	

Allowable Emissions Allowable Emissions \_\_\_\_ of \_\_\_\_

1. Basis for Allowable Emissions Code:	2. Future Effective Date of Allowable Emissions:
3. Allowable Emissions and Units:	4. Equivalent Allowable Emissions: lb/hour      tons/year
5. Method of Compliance:	
6. Allowable Emissions Comment (Description of Operating Method):	



**EMISSIONS UNIT INFORMATION**

**POLLUTANT DETAIL INFORMATION**

Section [1]  
South AP Plant

Page [2] of [6]  
Particulate Matter - PM<sub>10</sub>

**F1. EMISSIONS UNIT POLLUTANT DETAIL INFORMATION –  
POTENTIAL/ESTIMATED FUGITIVE EMISSIONS**

**(Optional for unregulated emissions units.)**

**Potential/Estimated Fugitive Emissions**

**Complete for each pollutant identified in Subsection E if applying for an air construction permit or concurrent processing of an air construction permit and a revised or renewal Title V permit. Complete for each emissions-limited pollutant identified in Subsection E if applying for an air operation permit.**

1. Pollutant Emitted: <b>PM<sub>10</sub></b>		2. Total Percent Efficiency of Control:	
3. Potential Emissions: <b>11.5 lb/hour                      50.4 tons/year</b>		4. Synthetically Limited? <input type="checkbox"/> Yes <input checked="" type="checkbox"/> No	
5. Range of Estimated Fugitive Emissions (as applicable): to                      tons/year			
6. Emission Factor: <b>0.25 lb/ton P<sub>2</sub>O<sub>5</sub></b>  Reference: <b>Proposed BACT</b>		7. Emissions Method Code: <b>0</b>	
8. Calculation of Emissions:  <b>0.25 lb/ton P<sub>2</sub>O<sub>5</sub> x 46 ton/hr P<sub>2</sub>O<sub>5</sub> = 11.5 lb/hr</b> <b>11.5 lb/hr x 8,760 hr/yr /2,000 lb/ton = 50.4 TPY</b>			
9. Pollutant Potential/Estimated Fugitive Emissions Comment: <b>Represents total emissions from Stacks A and B combined.</b>			

**EMISSIONS UNIT INFORMATION**

Section [1]  
South AP Plant

**POLLUTANT DETAIL INFORMATION**

Page [2] of [6]  
Particulate Matter - PM<sub>10</sub>

**F2. EMISSIONS UNIT POLLUTANT DETAIL INFORMATION -  
ALLOWABLE EMISSIONS**

Complete if the pollutant identified in Subsection F1 is or would be subject to a numerical emissions limitation.

Allowable Emissions Allowable Emissions 1 of 1

1. Basis for Allowable Emissions Code: <b>OTHER</b>	2. Future Effective Date of Allowable Emissions:
3. Allowable Emissions and Units: <b>0.25 lb/ton P<sub>2</sub>O<sub>5</sub></b>	4. Equivalent Allowable Emissions: <b>11.5 lb/hour      50.4 tons/year</b>
5. Method of Compliance: <b>Annual stack emission test using EPA Method 5.</b>	
6. Allowable Emissions Comment (Description of Operating Method): <b>Proposed BACT limit.</b>	

Allowable Emissions Allowable Emissions \_\_\_\_ of \_\_\_\_

1. Basis for Allowable Emissions Code:	2. Future Effective Date of Allowable Emissions:
3. Allowable Emissions and Units:	4. Equivalent Allowable Emissions: lb/hour      tons/year
5. Method of Compliance:	
6. Allowable Emissions Comment (Description of Operating Method):	

Allowable Emissions Allowable Emissions \_\_\_\_ of \_\_\_\_

1. Basis for Allowable Emissions Code:	2. Future Effective Date of Allowable Emissions:
3. Allowable Emissions and Units:	4. Equivalent Allowable Emissions: lb/hour      tons/year
5. Method of Compliance:	
6. Allowable Emissions Comment (Description of Operating Method):	

**EMISSIONS UNIT INFORMATION**

Section [1]  
South AP Plant

**POLLUTANT DETAIL INFORMATION**

Page [3] of [6]  
Sulfur Dioxide - SO<sub>2</sub>

**F1. EMISSIONS UNIT POLLUTANT DETAIL INFORMATION –  
POTENTIAL/ESTIMATED FUGITIVE EMISSIONS**

(Optional for unregulated emissions units.)

Potential/Estimated Fugitive Emissions

Complete for each pollutant identified in Subsection E if applying for an air construction permit or concurrent processing of an air construction permit and a revised or renewal Title V permit. Complete for each emissions-limited pollutant identified in Subsection E if applying for an air operation permit.

1. Pollutant Emitted: <b>SO<sub>2</sub></b>		2. Total Percent Efficiency of Control:	
3. Potential Emissions: <b>3.16 lb/hour                      13.82 tons/year</b>		4. Synthetically Limited? <input checked="" type="checkbox"/> Yes <input type="checkbox"/> No	
5. Range of Estimated Fugitive Emissions (as applicable): to                      tons/year			
6. Emission Factor: <b>142*S lb/10<sup>3</sup> gal</b>  Reference: <b>AP-42</b>		7. Emissions Method Code: <b>0</b>	
8. Calculation of Emissions:  <b>444.4 gal/hr x (142 x 0.05)/1000 = 3.16 lb/hr</b> <b>3.16 lb/hr x 8,760 hr/yr x ton/2000 lb = 13.82 TPY</b>			
9. Pollutant Potential/Estimated Fugitive Emissions Comment: <b>S = 0.05%</b>			

**EMISSIONS UNIT INFORMATION**

**POLLUTANT DETAIL INFORMATION**

Section [1]  
South AP Plant

Page [3] of [6]  
Sulfur Dioxide - SO<sub>2</sub>

**F2. EMISSIONS UNIT POLLUTANT DETAIL INFORMATION -  
ALLOWABLE EMISSIONS**

**Complete if the pollutant identified in Subsection F1 is or would be subject to a numerical emissions limitation.**

**Allowable Emissions** Allowable Emissions 1 of 1

1. Basis for Allowable Emissions Code: <b>OTHER</b>	2. Future Effective Date of Allowable Emissions:
3. Allowable Emissions and Units: <b>0.05% Sulfur Fuel Oil</b>	4. Equivalent Allowable Emissions: <b>3.16 lb/hour      13.82 tons/year</b>
5. Method of Compliance: <b>Fuel oil analysis and usage.</b>	
6. Allowable Emissions Comment (Description of Operating Method): <b>Based on fuel oil firing.</b>	

**Allowable Emissions** Allowable Emissions \_\_\_\_ of \_\_\_\_

1. Basis for Allowable Emissions Code:	2. Future Effective Date of Allowable Emissions:
3. Allowable Emissions and Units:	4. Equivalent Allowable Emissions: lb/hour      tons/year
5. Method of Compliance:	
6. Allowable Emissions Comment (Description of Operating Method):	

**Allowable Emissions** Allowable Emissions \_\_\_\_ of \_\_\_\_

1. Basis for Allowable Emissions Code:	2. Future Effective Date of Allowable Emissions:
3. Allowable Emissions and Units:	4. Equivalent Allowable Emissions: lb/hour      tons/year
5. Method of Compliance:	
6. Allowable Emissions Comment (Description of Operating Method):	

**EMISSIONS UNIT INFORMATION**

Section [1]  
South AP Plant

**POLLUTANT DETAIL INFORMATION**

Page [4] of [6]  
Fluorides - FL

**F1. EMISSIONS UNIT POLLUTANT DETAIL INFORMATION –  
POTENTIAL/ESTIMATED FUGITIVE EMISSIONS**

(Optional for unregulated emissions units.)

**Potential/Estimated Fugitive Emissions**

**Complete for each pollutant identified in Subsection E if applying for an air construction permit or concurrent processing of an air construction permit and a revised or renewal Title V permit. Complete for each emissions-limited pollutant identified in Subsection E if applying for an air operation permit.**

1. Pollutant Emitted: <b>FL</b>	2. Total Percent Efficiency of Control:
3. Potential Emissions: <b>2.76 lb/hour                      12.1 tons/year</b>	4. Synthetically Limited? <input type="checkbox"/> Yes <input checked="" type="checkbox"/> No
5. Range of Estimated Fugitive Emissions (as applicable): to                      tons/year	
6. Emission Factor: <b>0.06 lb/ton P<sub>2</sub>O<sub>5</sub></b>  Reference: <b>Proposed BACT</b>	7. Emissions Method Code: <b>0</b>
8. Calculation of Emissions:  <b>0.06 lb/ton P<sub>2</sub>O<sub>5</sub> x 46 ton/hr P<sub>2</sub>O<sub>5</sub> = 2.76 lb/hr</b> <b>2.76 lb/hr x 8,760 hr/yr /2,000 lb/ton = 12.1 TPY</b>	
9. Pollutant Potential/Estimated Fugitive Emissions Comment: <b>Represents total emissions from Stacks A and B combined.</b>	

**EMISSIONS UNIT INFORMATION**

Section [1]  
South AP Plant

**POLLUTANT DETAIL INFORMATION**

Page [4] of [6]  
Fluorides - FL

**F2. EMISSIONS UNIT POLLUTANT DETAIL INFORMATION -  
ALLOWABLE EMISSIONS**

Complete if the pollutant identified in Subsection F1 is or would be subject to a numerical emissions limitation.

Allowable Emissions Allowable Emissions 1 of 1

1. Basis for Allowable Emissions Code: <b>RULE</b>	2. Future Effective Date of Allowable Emissions:
3. Allowable Emissions and Units: <b>0.06 lb/ton P<sub>2</sub>O<sub>5</sub></b>	4. Equivalent Allowable Emissions: <b>2.76 lb/hour      12.1 tons/year</b>
5. Method of Compliance: <b>Annual stack emissions test using EPA Method 13 or 13B.</b>	
6. Allowable Emissions Comment (Description of Operating Method): <b>Proposed BACT.</b>	

Allowable Emissions Allowable Emissions \_\_\_\_\_ of \_\_\_\_\_

1. Basis for Allowable Emissions Code:	2. Future Effective Date of Allowable Emissions:
3. Allowable Emissions and Units:	4. Equivalent Allowable Emissions: lb/hour      tons/year
5. Method of Compliance:	
6. Allowable Emissions Comment (Description of Operating Method):	

Allowable Emissions Allowable Emissions \_\_\_\_\_ of \_\_\_\_\_

1. Basis for Allowable Emissions Code:	2. Future Effective Date of Allowable Emissions:
3. Allowable Emissions and Units:	4. Equivalent Allowable Emissions: lb/hour      tons/year
5. Method of Compliance:	
6. Allowable Emissions Comment (Description of Operating Method):	

**EMISSIONS UNIT INFORMATION**

Section [1]  
South AP Plant

**POLLUTANT DETAIL INFORMATION**

Page [5] of [6]  
Nitrogen Oxides - NO<sub>x</sub>

**F1. EMISSIONS UNIT POLLUTANT DETAIL INFORMATION –  
POTENTIAL/ESTIMATED FUGITIVE EMISSIONS**

(Optional for unregulated emissions units.)

Potential/Estimated Fugitive Emissions

Complete for each pollutant identified in Subsection E if applying for an air construction permit or concurrent processing of an air construction permit and a revised or renewal Title V permit. Complete for each emissions-limited pollutant identified in Subsection E if applying for an air operation permit.

1. Pollutant Emitted: <b>NO<sub>x</sub></b>		2. Total Percent Efficiency of Control:	
3. Potential Emissions: <b>12.6 lb/hour                      55.17 tons/year</b>		4. Synthetically Limited? <input type="checkbox"/> Yes <input checked="" type="checkbox"/> No	
5. Range of Estimated Fugitive Emissions (as applicable): to                      tons/year			
6. Emission Factor: <b>19 lb/10<sup>3</sup> gal LPG</b>  Reference: <b>AP-42</b>		7. Emissions Method Code: <b>3</b>	
8. Calculation of Emissions:  <b>663 gal/hr x 19 lb/1000 gal = 12.6 lb/hr</b>  <b>12.6 lb/hr x 8,760 hr/yr x ton/2000 lb = 55.17 TPY</b>			
9. Pollutant Potential/Estimated Fugitive Emissions Comment: <b>Based on Liquefied Petroleum Gas (LPG) firing.</b>			

**EMISSIONS UNIT INFORMATION**Section [1]  
South AP Plant**POLLUTANT DETAIL INFORMATION**Page [5] of [6]  
Nitrogen Oxides - NO<sub>x</sub>**F2. EMISSIONS UNIT POLLUTANT DETAIL INFORMATION -  
ALLOWABLE EMISSIONS****Complete if the pollutant identified in Subsection F1 is or would be subject to a numerical emissions limitation.****Allowable Emissions** Allowable Emissions of

1. Basis for Allowable Emissions Code:	2. Future Effective Date of Allowable Emissions:
3. Allowable Emissions and Units:	4. Equivalent Allowable Emissions: lb/hour                      tons/year
5. Method of Compliance:	
6. Allowable Emissions Comment (Description of Operating Method):	

**Allowable Emissions** Allowable Emissions of

1. Basis for Allowable Emissions Code:	2. Future Effective Date of Allowable Emissions:
3. Allowable Emissions and Units:	4. Equivalent Allowable Emissions: lb/hour                      tons/year
5. Method of Compliance:	
6. Allowable Emissions Comment (Description of Operating Method):	

**Allowable Emissions** Allowable Emissions of

1. Basis for Allowable Emissions Code:	2. Future Effective Date of Allowable Emissions:
3. Allowable Emissions and Units:	4. Equivalent Allowable Emissions: lb/hour                      tons/year
5. Method of Compliance:	
6. Allowable Emissions Comment (Description of Operating Method):	



**EMISSIONS UNIT INFORMATION**

Section [1]  
South AP Plant

**POLLUTANT DETAIL INFORMATION**

Page [6] of [6]  
Carbon Monoxide - CO

**F1. EMISSIONS UNIT POLLUTANT DETAIL INFORMATION –  
POTENTIAL/ESTIMATED FUGITIVE EMISSIONS**

(Optional for unregulated emissions units.)

**Potential/Estimated Fugitive Emissions**

Complete for each pollutant identified in Subsection E if applying for an air construction permit or concurrent processing of an air construction permit and a revised or renewal Title V permit. Complete for each emissions-limited pollutant identified in Subsection E if applying for an air operation permit.

1. Pollutant Emitted: CO		2. Total Percent Efficiency of Control:	
3. Potential Emissions: 5.04 lb/hour                      22.08 tons/year		4. Synthetically Limited? <input type="checkbox"/> Yes <input checked="" type="checkbox"/> No	
5. Range of Estimated Fugitive Emissions (as applicable): to                      tons/year			
6. Emission Factor: 84 lb/10 <sup>6</sup> ft <sup>3</sup> natural gas  Reference: AP-42		7. Emissions Method Code: 3	
8. Calculation of Emissions:  60,000 scf/hr x 84 lb/10 <sup>6</sup> scf = 5.04 lb/hr  5.04 lb/hr x 8,760 hr/yr x ton/2000 lb = 22.08 TPY			
9. Pollutant Potential/Estimated Fugitive Emissions Comment: Based on Natural Gas firing.			

**EMISSIONS UNIT INFORMATION**

Section [1]  
South AP Plant

**POLLUTANT DETAIL INFORMATION**

Page [6] of [6]  
Carbon Monoxide - CO

**F2. EMISSIONS UNIT POLLUTANT DETAIL INFORMATION -  
ALLOWABLE EMISSIONS**

Complete if the pollutant identified in Subsection F1 is or would be subject to a numerical emissions limitation.

Allowable Emissions Allowable Emissions of

1. Basis for Allowable Emissions Code:	2. Future Effective Date of Allowable Emissions:
3. Allowable Emissions and Units:	4. Equivalent Allowable Emissions: lb/hour                      tons/year
5. Method of Compliance:	
6. Allowable Emissions Comment (Description of Operating Method):	

Allowable Emissions Allowable Emissions of

1. Basis for Allowable Emissions Code:	2. Future Effective Date of Allowable Emissions:
3. Allowable Emissions and Units:	4. Equivalent Allowable Emissions: lb/hour                      tons/year
5. Method of Compliance:	
6. Allowable Emissions Comment (Description of Operating Method):	

Allowable Emissions Allowable Emissions \_\_\_\_ of \_\_\_\_

1. Basis for Allowable Emissions Code:	2. Future Effective Date of Allowable Emissions:
3. Allowable Emissions and Units:	4. Equivalent Allowable Emissions: lb/hour                      tons/year
5. Method of Compliance:	
6. Allowable Emissions Comment (Description of Operating Method):	

**EMISSIONS UNIT INFORMATION**

Section [1]  
South AP Plant

**G. VISIBLE EMISSIONS INFORMATION**

Complete if this emissions unit is or would be subject to a unit-specific visible emissions limitation.

**Visible Emissions Limitation:** Visible Emissions Limitation 1 of 1

1. Visible Emissions Subtype: <b>VE20</b>	2. Basis for Allowable Opacity: <input checked="" type="checkbox"/> Rule <input type="checkbox"/> Other
3. Allowable Opacity: Normal Conditions: <b>20 %</b> Exceptional Conditions: % Maximum Period of Excess Opacity Allowed: min/hour	
4. Method of Compliance: <b>Annual VE test using EPA Method 9.</b>	
5. Visible Emissions Comment: <b>Rule 62.296.320(4)(b), F.A.C. and Permit No. 1050053-034-AC. Applies to both Stacks A and B.</b>	

**Visible Emissions Limitation:** Visible Emissions Limitation \_\_\_\_\_ of \_\_\_\_\_

1. Visible Emissions Subtype:	2. Basis for Allowable Opacity: <input type="checkbox"/> Rule <input type="checkbox"/> Other
3. Allowable Opacity: Normal Conditions: % Exceptional Conditions: % Maximum Period of Excess Opacity Allowed: min/hour	
4. Method of Compliance:	
5. Visible Emissions Comment:	

# EMISSIONS UNIT INFORMATION

Section [1]  
South AP Plant

## H. CONTINUOUS MONITOR INFORMATION

Complete if this emissions unit is or would be subject to continuous monitoring.

**Continuous Monitoring System:** Continuous Monitor 1 of 16

1. Parameter Code: <b>PRS</b>	2. Pollutant(s):
3. CMS Requirement:	<input checked="" type="checkbox"/> Rule <input type="checkbox"/> Other
4. Monitor Information... Manufacturer: Model Number: Serial Number:	
5. Installation Date:	6. Performance Specification Test Date:
7. Continuous Monitor Comment:  <b>Pressure drop across R/G Primary Venturi Acid Scrubber. Alternative Monitoring Plan (AMP) Administrative Order 03-C-AP.</b>	

**Continuous Monitoring System:** Continuous Monitor 2 of 16

1. Parameter Code: <b>PRS</b>	2. Pollutant(s):
3. CMS Requirement:	<input checked="" type="checkbox"/> Rule <input type="checkbox"/> Other
4. Monitor Information... Manufacturer: Model Number: Serial Number:	
5. Installation Date:	6. Performance Specification Test Date:
7. Continuous Monitor Comment:  <b>Pressure drop across Dryer Primary Venturi/Cyclonic Acid Scrubber. Alternative Monitoring Plan (AMP) Administrative Order 03-C-AP.</b>	

# EMISSIONS UNIT INFORMATION

Section [1]  
South AP Plant

## H. CONTINUOUS MONITOR INFORMATION

Complete if this emissions unit is or would be subject to continuous monitoring.

**Continuous Monitoring System:** Continuous Monitor 3 of 16

1. Parameter Code: <b>PRS</b>	2. Pollutant(s):
3. CMS Requirement:	<input checked="" type="checkbox"/> Rule <input type="checkbox"/> Other
4. Monitor Information... Manufacturer: Model Number:	Serial Number:
5. Installation Date:	6. Performance Specification Test Date:
7. Continuous Monitor Comment:  <b>Pressure drop across Screens and Mills Primary Venturi/Cyclonic Acid Scrubber. Alternative Monitoring Plan (AMP) Administrative Order 03-C-AP.</b>	

**Continuous Monitoring System:** Continuous Monitor 4 of 16

1. Parameter Code: <b>PRS</b>	2. Pollutant(s):
3. CMS Requirement:	<input checked="" type="checkbox"/> Rule <input type="checkbox"/> Other
4. Monitor Information... Manufacturer: Model Number:	Serial Number:
5. Installation Date:	6. Performance Specification Test Date:
7. Continuous Monitor Comment:  <b>Pressure drop across Rotary Cooler Venturi/Cyclonic Acid Scrubber. Alternative Monitoring Plan (AMP) Administrative Order 03-C-AP.</b>	

# EMISSIONS UNIT INFORMATION

Section [1]  
South AP Plant

## H. CONTINUOUS MONITOR INFORMATION

Complete if this emissions unit is or would be subject to continuous monitoring.

**Continuous Monitoring System:** Continuous Monitor 5 of 16

1. Parameter Code: <b>PRS</b>	2. Pollutant(s):
3. CMS Requirement:	<input checked="" type="checkbox"/> Rule <input type="checkbox"/> Other
4. Monitor Information... Manufacturer: Model Number:	Serial Number:
5. Installation Date:	6. Performance Specification Test Date:
7. Continuous Monitor Comment:  <b>Pressure drop across Dryer and Screens and Mills secondary pond water (cross flow) scrubber before Stack B. Alternative Monitoring Plan (AMP) Administrative Order 03-C-AP.</b>	

**Continuous Monitoring System:** Continuous Monitor 6 of 16

1. Parameter Code: <b>FLOW</b>	2. Pollutant(s):
3. CMS Requirement:	<input checked="" type="checkbox"/> Rule <input type="checkbox"/> Other
4. Monitor Information... Manufacturer: Model Number:	Serial Number:
5. Installation Date:	6. Performance Specification Test Date:
7. Continuous Monitor Comment:  <b>Scrubbing liquid flow rate of R/G Primary Venturi Acid Scrubber. Alternative Monitoring Plan (AMP) Administrative Order 03-C-AP.</b>	

**EMISSIONS UNIT INFORMATION**

Section [1]  
South AP Plant

**H. CONTINUOUS MONITOR INFORMATION**

Complete if this emissions unit is or would be subject to continuous monitoring.

**Continuous Monitoring System:** Continuous Monitor 7 of 16

1. Parameter Code: <b>FLOW</b>	2. Pollutant(s):
3. CMS Requirement:	<input checked="" type="checkbox"/> Rule <input type="checkbox"/> Other
4. Monitor Information... Manufacturer: Model Number:	Serial Number:
5. Installation Date:	6. Performance Specification Test Date:
7. Continuous Monitor Comment:  <b>Scrubbing liquid flow rate of Dryer Primary Venturi/Cyclonic Acid Scrubber. Alternative Monitoring Plan (AMP) Administrative Order 03-C-AP.</b>	

**Continuous Monitoring System:** Continuous Monitor 8 of 16

1. Parameter Code: <b>FLOW</b>	2. Pollutant(s):
3. CMS Requirement:	<input checked="" type="checkbox"/> Rule <input type="checkbox"/> Other
4. Monitor Information... Manufacturer: Model Number:	Serial Number:
5. Installation Date:	6. Performance Specification Test Date:
7. Continuous Monitor Comment:  <b>Scrubbing liquid flow rate of Screens and Mills Primary Venturi/Cyclonic Acid Scrubber. Alternative Monitoring Plan (AMP) Administrative Order 03-C-AP.</b>	

**EMISSIONS UNIT INFORMATION**

Section [1]  
South AP Plant

**H. CONTINUOUS MONITOR INFORMATION**

**Complete if this emissions unit is or would be subject to continuous monitoring.**

**Continuous Monitoring System:** Continuous Monitor 9 of 16

1. Parameter Code: <b>FLOW</b>	2. Pollutant(s):
3. CMS Requirement:	<input checked="" type="checkbox"/> Rule <input type="checkbox"/> Other
4. Monitor Information... Manufacturer: Model Number:	Serial Number:
5. Installation Date:	6. Performance Specification Test Date:
7. Continuous Monitor Comment:  <b>Scrubbing liquid flow rate of Rotary Cooler Primary Venturi/Cyclonic Acid Scrubber. Alternative Monitoring Plan (AMP) Administrative Order 03-C-AP.</b>	

**Continuous Monitoring System:** Continuous Monitor 10 of 16

1. Parameter Code: <b>FLOW</b>	2. Pollutant(s):
3. CMS Requirement:	<input checked="" type="checkbox"/> Rule <input type="checkbox"/> Other
4. Monitor Information... Manufacturer: Model Number:	Serial Number:
5. Installation Date:	6. Performance Specification Test Date:
7. Continuous Monitor Comment:  <b>Scrubbing liquid flow rate of Dryer and Screens and Mills secondary pond water (cross flow) scrubber before Stack B. Alternative Monitoring Plan (AMP) Administrative Order 03-C-AP.</b>	



**EMISSIONS UNIT INFORMATION**Section [1]  
South AP Plant**H. CONTINUOUS MONITOR INFORMATION**

Complete if this emissions unit is or would be subject to continuous monitoring.

**Continuous Monitoring System:** Continuous Monitor 11 of 16

1. Parameter Code: <b>Fan Amperage</b>	2. Pollutant(s):
3. CMS Requirement:	<input checked="" type="checkbox"/> Rule <input type="checkbox"/> Other
4. Monitor Information... Manufacturer: Model Number:	Serial Number:
5. Installation Date:	6. Performance Specification Test Date:
7. Continuous Monitor Comment:  <b>Fan amperage for the R/G Primary Venturi Acid Scrubber. Alternative Monitoring Plan (AMP) Administrative Order 03-C-AP.</b>	

**Continuous Monitoring System:** Continuous Monitor 12 of 16

1. Parameter Code: <b>Fan Amperage</b>	2. Pollutant(s):
3. CMS Requirement:	<input checked="" type="checkbox"/> Rule <input type="checkbox"/> Other
4. Monitor Information... Manufacturer: Model Number:	Serial Number:
5. Installation Date:	6. Performance Specification Test Date:
7. Continuous Monitor Comment:  <b>Fan amperage for the Dryer Primary Venturi/Cyclonic Acid Scrubber. Alternative Monitoring Plan (AMP) Administrative Order 03-C-AP.</b>	

**EMISSIONS UNIT INFORMATION**

Section [1]  
South AP Plant

**H. CONTINUOUS MONITOR INFORMATION**

Complete if this emissions unit is or would be subject to continuous monitoring.

**Continuous Monitoring System:** Continuous Monitor 13 of 16

1. Parameter Code: <b>Fan Amperage</b>	2. Pollutant(s):
3. CMS Requirement:	<input checked="" type="checkbox"/> Rule <input type="checkbox"/> Other
4. Monitor Information... Manufacturer: Model Number:	Serial Number:
5. Installation Date:	6. Performance Specification Test Date:
7. Continuous Monitor Comment:  <b>Fan amperage for the Screens and Mills Primary Venturi/Cyclonic Acid Scrubber. Alternative Monitoring Plan (AMP) Administrative Order 03-C-AP.</b>	

**Continuous Monitoring System:** Continuous Monitor 14 of 16

1. Parameter Code: <b>Fan Amperage</b>	2. Pollutant(s):
3. CMS Requirement:	<input checked="" type="checkbox"/> Rule <input type="checkbox"/> Other
4. Monitor Information... Manufacturer: Model Number:	Serial Number:
5. Installation Date:	6. Performance Specification Test Date:
7. Continuous Monitor Comment:  <b>Fan amperage for the Rotary Cooler Primary Venturi/Cyclonic Acid Scrubber. Alternative Monitoring Plan (AMP) Administrative Order 03-C-AP.</b>	

# EMISSIONS UNIT INFORMATION

Section [1]  
South AP Plant

## H. CONTINUOUS MONITOR INFORMATION

Complete if this emissions unit is or would be subject to continuous monitoring.

**Continuous Monitoring System:** Continuous Monitor 15 of 16

1. Parameter Code: FLOW	2. Pollutant(s):
3. CMS Requirement:	<input type="checkbox"/> Rule <input checked="" type="checkbox"/> Other
4. Monitor Information... Manufacturer: Model Number:	Serial Number:
5. Installation Date:	6. Performance Specification Test Date:
7. Continuous Monitor Comment:  Water flow rate of R/G Primary Venturi Acid Scrubber.	

**Continuous Monitoring System:** Continuous Monitor 16 of 16

1. Parameter Code: Mass Flow	2. Pollutant(s):
3. CMS Requirement:	<input checked="" type="checkbox"/> Rule <input type="checkbox"/> Other
4. Monitor Information... Manufacturer: Model Number:	Serial Number:
5. Installation Date:	6. Performance Specification Test Date:
7. Continuous Monitor Comment:  40 CFR 63.325(a). Mass flow of phosphorus bearing feed material. Alternative Monitoring Plan (AMP) Administrative Order 03-C-AP.	

**EMISSIONS UNIT INFORMATION**

**Section [1]  
South AP Plant**

**I. EMISSIONS UNIT ADDITIONAL INFORMATION**

**Additional Requirements for All Applications, Except as Otherwise Stated**

1. Process Flow Diagram (Required for all permit applications, except Title V air operation permit revision applications if this information was submitted to the department within the previous five years and would not be altered as a result of the revision being sought) <input checked="" type="checkbox"/> Attached, Document ID: <b>PSD Report</b> <input type="checkbox"/> Previously Submitted, Date _____
2. Fuel Analysis or Specification (Required for all permit applications, except Title V air operation permit revision applications if this information was submitted to the department within the previous five years and would not be altered as a result of the revision being sought) <input checked="" type="checkbox"/> Attached, Document ID: <b>MGB-EU1-I2</b> <input type="checkbox"/> Previously Submitted, Date _____
3. Detailed Description of Control Equipment (Required for all permit applications, except Title V air operation permit revision applications if this information was submitted to the department within the previous five years and would not be altered as a result of the revision being sought) <input checked="" type="checkbox"/> Attached, Document ID: <b>PSD Report</b> <input type="checkbox"/> Previously Submitted, Date _____
4. Procedures for Startup and Shutdown (Required for all operation permit applications, except Title V air operation permit revision applications if this information was submitted to the department within the previous five years and would not be altered as a result of the revision being sought) <input type="checkbox"/> Attached, Document ID: _____ <input type="checkbox"/> Previously Submitted, Date _____ <input checked="" type="checkbox"/> Not Applicable (construction application)
5. Operation and Maintenance Plan (Required for all permit applications, except Title V air operation permit revision applications if this information was submitted to the department within the previous five years and would not be altered as a result of the revision being sought) <input type="checkbox"/> Attached, Document ID: _____ <input type="checkbox"/> Previously Submitted, Date _____ <input checked="" type="checkbox"/> Not Applicable
6. Compliance Demonstration Reports/Records <input type="checkbox"/> Attached, Document ID: _____ Test Date(s)/Pollutant(s) Tested: _____ <input type="checkbox"/> Previously Submitted, Date: _____ Test Date(s)/Pollutant(s) Tested: _____ <input type="checkbox"/> To be Submitted, Date (if known): _____ Test Date(s)/Pollutant(s) Tested: _____ <input checked="" type="checkbox"/> Not Applicable  Note: For FESOP applications, all required compliance demonstration records/reports must be submitted at the time of application. For Title V air operation permit applications, all required compliance demonstration reports/records must be submitted at the time of application, or a compliance plan must be submitted at the time of application.
7. Other Information Required by Rule or Statute <input type="checkbox"/> Attached, Document ID: _____ <input checked="" type="checkbox"/> Not Applicable

## EMISSIONS UNIT INFORMATION

Section [1]  
South AP Plant

### Additional Requirements for Air Construction Permit Applications

1. Control Technology Review and Analysis (Rules 62-212.400(6) and 62-212.500(7), F.A.C.; 40 CFR 63.43(d) and (e)) <input checked="" type="checkbox"/> Attached, Document ID: <b>PSD Report</b> <input type="checkbox"/> Not Applicable
2. Good Engineering Practice Stack Height Analysis (Rule 62-212.400(5)(h)6., F.A.C., and Rule 62-212.500(4)(f), F.A.C.) <input checked="" type="checkbox"/> Attached, Document ID: <b>PSD Report</b> <input type="checkbox"/> Not Applicable
3. Description of Stack Sampling Facilities (Required for proposed new stack sampling facilities only) <input type="checkbox"/> Attached, Document ID: _____ <input checked="" type="checkbox"/> Not Applicable

### Additional Requirements for Title V Air Operation Permit Applications

1. Identification of Applicable Requirements <input type="checkbox"/> Attached, Document ID: _____ <input type="checkbox"/> Not Applicable
2. Compliance Assurance Monitoring <input type="checkbox"/> Attached, Document ID: _____ <input type="checkbox"/> Not Applicable
3. Alternative Methods of Operation <input type="checkbox"/> Attached, Document ID: _____ <input type="checkbox"/> Not Applicable
4. Alternative Modes of Operation (Emissions Trading) <input type="checkbox"/> Attached, Document ID: _____ <input type="checkbox"/> Not Applicable
5. Acid Rain Part Application <input type="checkbox"/> Certificate of Representation (EPA Form No. 7610-1) <input type="checkbox"/> Copy Attached, Document ID: _____ <input type="checkbox"/> Acid Rain Part (Form No. 62-210.900(1)(a)) <input type="checkbox"/> Attached, Document ID: _____ <input type="checkbox"/> Previously Submitted, Date: _____ <input type="checkbox"/> Repowering Extension Plan (Form No. 62-210.900(1)(a)1.) <input type="checkbox"/> Attached, Document ID: _____ <input type="checkbox"/> Previously Submitted, Date: _____ <input type="checkbox"/> New Unit Exemption (Form No. 62-210.900(1)(a)2.) <input type="checkbox"/> Attached, Document ID: _____ <input type="checkbox"/> Previously Submitted, Date: _____ <input type="checkbox"/> Retired Unit Exemption (Form No. 62-210.900(1)(a)3.) <input type="checkbox"/> Attached, Document ID: _____ <input type="checkbox"/> Previously Submitted, Date: _____ <input type="checkbox"/> Phase II NOx Compliance Plan (Form No. 62-210.900(1)(a)4.) <input type="checkbox"/> Attached, Document ID: _____ <input type="checkbox"/> Previously Submitted, Date: _____ <input type="checkbox"/> Phase II NOx Averaging Plan (Form No. 62-210.900(1)(a)5.) <input type="checkbox"/> Attached, Document ID: _____ <input type="checkbox"/> Previously Submitted, Date: _____ <input type="checkbox"/> Not Applicable

**EMISSIONS UNIT INFORMATION**

**Section [1]  
South AP Plant**

**Additional Requirements Comment**

**ATTACHMENT MGB-EU1-I2**

**FUEL ANALYSIS OR SPECIFICATIONS**

**ATTACHMENT MGB-EU1-12**  
**SOUTH AP PLANT FUEL ANALYSIS**

Fuel	Density	Moisture (%)	Weight % Sulfur	Weight % Nitrogen	Weight % Ash	Heat Capacity
Natural Gas	0.048 lb/scf	<0.01	<0.001	0.62	--	1,000 Btu/scf
No. 2 Fuel Oil	6.83 lb/gal	<0.01	0.05	0.006	<0.01	135,000 Btu/gal
LPG	4.20 lb/gal	0	15 grains/ 100 ft <sup>3</sup>	0	0	90,500 Btu/gal



## EMISSIONS UNIT INFORMATION

Section [2]  
North AP Plant

### III. EMISSIONS UNIT INFORMATION

**Title V Air Operation Permit Application** - For Title V air operation permitting only, emissions units are classified as regulated, unregulated, or insignificant. If this is an application for Title V air operation permit, a separate Emissions Unit Information Section (including subsections A through I as required) must be completed for each regulated and unregulated emissions unit addressed in this application for air permit. Some of the subsections comprising the Emissions Unit Information Section of the form are optional for unregulated emissions units. Each such subsection is appropriately marked. Insignificant emissions units are required to be listed at Section II, Subsection C.

**Air Construction Permit or FESOP Application** - For air construction permitting or federally enforceable state air operation permitting, emissions units are classified as either subject to air permitting or exempt from air permitting. The concept of an "unregulated emissions unit" does not apply. If this is an application for air construction permit or FESOP, a separate Emissions Unit Information Section (including subsections A through I as required) must be completed for each emissions unit subject to air permitting addressed in this application for air permit. Emissions units exempt from air permitting are required to be listed at Section II, Subsection C.

**Air Construction Permit and Revised/Renewal Title V Air Operation Permit Application** - Where this application is used to apply for both an air construction permit and a revised/renewal Title V air operation permit, each emissions unit is classified as either subject to air permitting or exempt from air permitting for air construction permitting purposes and as regulated, unregulated, or insignificant for Title V air operation permitting purposes. **The air construction permitting classification must be used to complete the Emissions Unit Information Section of this application for air permit.** A separate Emissions Unit Information Section (including subsections A through I as required) must be completed for each emissions unit subject to air permitting addressed in this application for air permit. Emissions units exempt from air construction permitting and insignificant emissions units are required to be listed at Section II, Subsection C.

If submitting the application form in hard copy, the number of this Emissions Unit Information Section and the total number of Emissions Unit Information Sections submitted as part of this application must be indicated in the space provided at the top of each page.

**EMISSIONS UNIT INFORMATION**

Section [2]  
North AP Plant

**A. GENERAL EMISSIONS UNIT INFORMATION**

**Title V Air Operation Permit Emissions Unit Classification**

1. Regulated or Unregulated Emissions Unit? (Check one, if applying for an initial, revised or renewal Title V air operation permit. Skip this item if applying for an air construction permit or FESOP only.)

The emissions unit addressed in this Emissions Unit Information Section is a regulated emissions unit.

The emissions unit addressed in this Emissions Unit Information Section is an unregulated emissions unit.

**Emissions Unit Description and Status**

1. Type of Emissions Unit Addressed in this Section: (Check one)

This Emissions Unit Information Section addresses, as a single emissions unit, a single process or production unit, or activity, which produces one or more air pollutants and which has at least one definable emission point (stack or vent).

This Emissions Unit Information Section addresses, as a single emissions unit, a group of process or production units and activities which has at least one definable emission point (stack or vent) but may also produce fugitive emissions.

This Emissions Unit Information Section addresses, as a single emissions unit, one or more process or production units and activities which produce fugitive emissions only.

2. Description of Emissions Unit Addressed in this Section:  
**North AP Fertilizer Plant (Ammoniated Phosphates Fertilizers Manufacturing)**

3. Emissions Unit Identification Number: **029**

4. Emissions Unit Status Code: <b>A</b>	5. Commence Construction Date:	6. Initial Startup Date:	7. Emissions Unit Major Group SIC Code: <b>28</b>	8. Acid Rain Unit? <input type="checkbox"/> Yes <input checked="" type="checkbox"/> No
--	--------------------------------	--------------------------	--	--

9. Package Unit:  
Manufacturer: \_\_\_\_\_ Model Number: \_\_\_\_\_

10. Generator Nameplate Rating: **MW**

11. Emissions Unit Comment:

\_\_\_\_\_

**EMISSIONS UNIT INFORMATION**

**Section [2]  
North AP Plant**

**Emissions Unit Control Equipment**

1. Control Equipment/Method(s) Description:

- 132 Ammonia Vaporizer (Condenser)
- 053 Four Venturi/Cyclonic Scrubbers
- 141 Two Wet Scrubbers

2. Control Device or Method Code(s): **053, 132, 141**



**EMISSIONS UNIT INFORMATION**

Section [2]  
 North AP Plant

**C. EMISSION POINT (STACK/VENT) INFORMATION**  
 (Optional for unregulated emissions units.)

**Emission Point Description and Type**

1. Identification of Point on Plot Plan or Flow Diagram: <b>AP Plants</b>		2. Emission Point Type Code: <b>3</b>	
3. Descriptions of Emission Points Comprising this Emissions Unit for VE Tracking: <b>Main Stack</b> <b>R/G Stack</b>			
4. ID Numbers or Descriptions of Emission Units with this Emission Point in Common:			
5. Discharge Type Code: <b>V</b>	6. Stack Height: <b>129.5 feet</b>	7. Exit Diameter: <b>7.5 feet</b>	
8. Exit Temperature: <b>105 °F</b>	9. Actual Volumetric Flow Rate: <b>180,800 acfm</b>	10. Water Vapor: <b>%</b>	
11. Maximum Dry Standard Flow Rate: <b>dscfm</b>		12. Nonstack Emission Point Height: <b>feet</b>	
13. Emission Point UTM Coordinates... Zone:            East (km): North (km):		14. Emission Point Latitude/Longitude... Latitude (DD/MM/SS) Longitude (DD/MM/SS)	
15. Emission Point Comment:  <b>Stack/vent information represents the Main Stack. Refer to Table 2-5 in PSD Report for a summary of stack/vent information for the North AP Plant.</b>			

**EMISSIONS UNIT INFORMATION**

Section [2]  
North AP Plant

**D. SEGMENT (PROCESS/FUEL) INFORMATION**

**Segment Description and Rate: Segment 1 of 3**

1. Segment Description (Process/Fuel Type):  <b>Chemical Manufacturing; Ammonium Phosphates; Ammoniator/Granulator.</b>		
2. Source Classification Code (SCC): <b>3-01-030-02</b>		3. SCC Units: <b>Tons P<sub>2</sub>O<sub>5</sub> Produced</b>
4. Maximum Hourly Rate: <b>106.1</b>	5. Maximum Annual Rate: <b>929,436</b>	6. Estimated Annual Activity Factor:
7. Maximum % Sulfur:	8. Maximum % Ash:	9. Million Btu per SCC Unit:
10. Segment Comment: <b>Maximum hourly rate of 106.1 TPH is the feed rate of material, expressed as 100% P<sub>2</sub>O<sub>5</sub>, which corresponds to 200 TPH of MAP. For DAP, maximum hourly rate is 70.4 TPH of 100% P<sub>2</sub>O<sub>5</sub>, which corresponds to 150 TPH of DAP. Annual rate corresponding to MAP production= 106.1 tons/hr x 8,760 hr/yr = 929,436 TPY.</b>		

**Segment Description and Rate: Segment 2 of 3**

1. Segment Description (Process/Fuel Type):  <b>In-Process Fuel Use; Distillate Oil; Phosphoric Fertilizer Dryer</b>		
2. Source Classification Code (SCC): <b>3-90-005-99</b>		3. SCC Units: <b>1000 Gallons Burned</b>
4. Maximum Hourly Rate: <b>0.37</b>	5. Maximum Annual Rate: <b>3,244.4</b>	6. Estimated Annual Activity Factor:
7. Maximum % Sulfur: <b>0.05</b>	8. Maximum % Ash:	9. Million Btu per SCC Unit: <b>135</b>
10. Segment Comment: <b>Maximum hourly rate based on heat input rate of 50 MMBtu/hr.</b>		

**EMISSIONS UNIT INFORMATION**

Section [2]  
North AP Plant

**D. SEGMENT (PROCESS/FUEL) INFORMATION**

**Segment Description and Rate: Segment 3 of 3**

1. Segment Description (Process/Fuel Type):  <b>In-Process Fuel Use; Natural Gas; Phosphoric Fertilizer Dryer</b>		
2. Source Classification Code (SCC): <b>3-90-006-99</b>		3. SCC Units: <b>Million Cubic Feet Burned</b>
4. Maximum Hourly Rate: <b>0.05</b>	5. Maximum Annual Rate: <b>438</b>	6. Estimated Annual Activity Factor:
7. Maximum % Sulfur:	8. Maximum % Ash:	9. Million Btu per SCC Unit: <b>1,000</b>
10. Segment Comment: <b>Maximum hourly rate based on heat input rate of 50 MMBtu/hr.</b>		

**Segment Description and Rate: Segment \_\_\_\_ of \_\_\_\_**

1. Segment Description (Process/Fuel Type):		
2. Source Classification Code (SCC):		3. SCC Units:
4. Maximum Hourly Rate:	5. Maximum Annual Rate:	6. Estimated Annual Activity Factor:
7. Maximum % Sulfur:	8. Maximum % Ash:	9. Million Btu per SCC Unit:
10. Segment Comment:		





**EMISSIONS UNIT INFORMATION**

**POLLUTANT DETAIL INFORMATION**

Section [2]  
North AP Plant

Page [1] of [8]  
Particulate Matter Total - PM

**F1. EMISSIONS UNIT POLLUTANT DETAIL INFORMATION –  
POTENTIAL/ESTIMATED FUGITIVE EMISSIONS**

(Optional for unregulated emissions units.)

**Potential/Estimated Fugitive Emissions**

Complete for each pollutant identified in Subsection E if applying for an air construction permit or concurrent processing of an air construction permit and a revised or renewal Title V permit. Complete for each emissions-limited pollutant identified in Subsection E if applying for an air operation permit.

1. Pollutant Emitted: <b>PM</b>		2. Total Percent Efficiency of Control:	
3. Potential Emissions: <b>30.8 lb/hour                      134.8 tons/year</b>		4. Synthetically Limited? <input type="checkbox"/> Yes <input checked="" type="checkbox"/> No	
5. Range of Estimated Fugitive Emissions (as applicable): to                      tons/year			
6. Emission Factor: <b>0.29 lb/ton P<sub>2</sub>O<sub>5</sub></b>  Reference: <b>Proposed BACT</b>		7. Emissions Method Code: <b>0</b>	
8. Calculation of Emissions:  <b>MAP Production:</b> <b>0.29 lb/ton P<sub>2</sub>O<sub>5</sub> x 106.1 ton/hr P<sub>2</sub>O<sub>5</sub> = 30.8 lb/hr</b> <b>30.8 lb/hr x 8,760 hr/yr / 2,000 lb/ton = 134.8 TPY</b>  <b>DAP Production:</b> <b>0.29 lb/ton P<sub>2</sub>O<sub>5</sub> x 70.4 ton/hr P<sub>2</sub>O<sub>5</sub> = 20.4 lb/hr</b> <b>20.4 lb/hr x 8,760 hr/yr / 2,000 lb/ton = 89.4 TPY</b>			
9. Pollutant Potential/Estimated Fugitive Emissions Comment: <b>Represents total emissions from both stacks combined.</b>			

**EMISSIONS UNIT INFORMATION**

Section [2]  
North AP Plant

**POLLUTANT DETAIL INFORMATION**

Page [1] of [8]  
Particulate Matter Total - PM

**F2. EMISSIONS UNIT POLLUTANT DETAIL INFORMATION -  
ALLOWABLE EMISSIONS**

Complete if the pollutant identified in Subsection F1 is or would be subject to a numerical emissions limitation.

**Allowable Emissions** Allowable Emissions 1 of 2

1. Basis for Allowable Emissions Code: <b>OTHER</b>	2. Future Effective Date of Allowable Emissions:
3. Allowable Emissions and Units: <b>0.29 lb/ton P<sub>2</sub>O<sub>5</sub></b>	4. Equivalent Allowable Emissions: <b>30.8 lb/hour      134.8 tons/year</b>
5. Method of Compliance: <b>Annual stack emission test using EPA Method 5.</b>	
6. Allowable Emissions Comment (Description of Operating Method): <b>Proposed BACT limit. Allowable emissions represent MAP production.</b>	

**Allowable Emissions** Allowable Emissions 2 of 2

1. Basis for Allowable Emissions Code: <b>OTHER</b>	2. Future Effective Date of Allowable Emissions:
3. Allowable Emissions and Units: <b>0.29 lb/ton P<sub>2</sub>O<sub>5</sub></b>	4. Equivalent Allowable Emissions: <b>20.4 lb/hour      89.4 tons/year</b>
5. Method of Compliance: <b>Annual stack emission test using EPA Method 5.</b>	
6. Allowable Emissions Comment (Description of Operating Method): <b>Proposed BACT limit. Allowable emissions represent DAP production.</b>	

**Allowable Emissions** Allowable Emissions of

1. Basis for Allowable Emissions Code:	2. Future Effective Date of Allowable Emissions:
3. Allowable Emissions and Units:	4. Equivalent Allowable Emissions: lb/hour      tons/year
5. Method of Compliance:	
6. Allowable Emissions Comment (Description of Operating Method):	

**EMISSIONS UNIT INFORMATION**

Section [2]  
North AP Plant

**POLLUTANT DETAIL INFORMATION**

Page [2] of [8]  
Particulate Matter - PM<sub>10</sub>

**F1. EMISSIONS UNIT POLLUTANT DETAIL INFORMATION –  
POTENTIAL/ESTIMATED FUGITIVE EMISSIONS**

(Optional for unregulated emissions units.)

Potential/Estimated Fugitive Emissions

Complete for each pollutant identified in Subsection E if applying for an air construction permit or concurrent processing of an air construction permit and a revised or renewal Title V permit. Complete for each emissions-limited pollutant identified in Subsection E if applying for an air operation permit.

1. Pollutant Emitted: <b>PM<sub>10</sub></b>		2. Total Percent Efficiency of Control:	
3. Potential Emissions: <b>30.8 lb/hour                      134.8 tons/year</b>		4. Synthetically Limited? <input type="checkbox"/> Yes <input checked="" type="checkbox"/> No	
5. Range of Estimated Fugitive Emissions (as applicable): to                      tons/year			
6. Emission Factor: <b>0.29 lb/ton P<sub>2</sub>O<sub>5</sub></b>  Reference: <b>Proposed BACT</b>		7. Emissions Method Code: <b>0</b>	
8. Calculation of Emissions:  <b>MAP Production:</b> <b>0.29 lb/ton P<sub>2</sub>O<sub>5</sub> x 106.1 ton/hr P<sub>2</sub>O<sub>5</sub> = 30.8 lb/hr</b> <b>30.8 lb/hr x 8,760 hr/yr / 2,000 lb/ton = 134.8 TPY</b>  <b>DAP Production:</b> <b>0.29 lb/ton P<sub>2</sub>O<sub>5</sub> x 70.4 ton/hr P<sub>2</sub>O<sub>5</sub> = 20.4 lb/hr</b> <b>20.4 lb/hr x 8,760 hr/yr / 2,000 lb/ton = 89.4 TPY</b>			
9. Pollutant Potential/Estimated Fugitive Emissions Comment: <b>Represents total emissions from both stacks combined.</b>			

**EMISSIONS UNIT INFORMATION**

Section [2]  
North AP Plant

**POLLUTANT DETAIL INFORMATION**

Page [1] of [8]  
Particulate Matter - PM<sub>10</sub>

**F2. EMISSIONS UNIT POLLUTANT DETAIL INFORMATION -  
ALLOWABLE EMISSIONS**

**Complete if the pollutant identified in Subsection F1 is or would be subject to a numerical emissions limitation.**

**Allowable Emissions Allowable Emissions 1 of 2**

1. Basis for Allowable Emissions Code: <b>OTHER</b>	2. Future Effective Date of Allowable Emissions:
3. Allowable Emissions and Units: <b>0.29 lb/ton P<sub>2</sub>O<sub>5</sub></b>	4. Equivalent Allowable Emissions: <b>30.8 lb/hour      134.8 tons/year</b>
5. Method of Compliance: <b>Annual stack emission test using EPA Method 5.</b>	
6. Allowable Emissions Comment (Description of Operating Method): <b>Proposed BACT limit. Allowable emissions represent MAP production.</b>	

**Allowable Emissions Allowable Emissions 2 of 2**

1. Basis for Allowable Emissions Code: <b>OTHER</b>	2. Future Effective Date of Allowable Emissions:
3. Allowable Emissions and Units: <b>0.29 lb/ton P<sub>2</sub>O<sub>5</sub></b>	4. Equivalent Allowable Emissions: <b>20.4 lb/hour      89.4 tons/year</b>
5. Method of Compliance: <b>Annual stack emission test using EPA Method 5.</b>	
6. Allowable Emissions Comment (Description of Operating Method): <b>Proposed BACT limit. Allowable emissions represent DAP production.</b>	

**Allowable Emissions Allowable Emissions of**

1. Basis for Allowable Emissions Code:	2. Future Effective Date of Allowable Emissions:
3. Allowable Emissions and Units:	4. Equivalent Allowable Emissions: lb/hour      tons/year
5. Method of Compliance:	
6. Allowable Emissions Comment (Description of Operating Method):	

F1. EMISSIONS UNIT POLLUTANT DETAIL INFORMATION –  
POTENTIAL/ESTIMATED FUGITIVE EMISSIONS

(Optional for unregulated emissions units.)

Potential/Estimated Fugitive Emissions

Complete for each pollutant identified in Subsection E if applying for an air construction permit or concurrent processing of an air construction permit and a revised or renewal Title V permit. Complete for each emissions-limited pollutant identified in Subsection E if applying for an air operation permit.

1. Pollutant Emitted: <b>SO<sub>2</sub></b>		2. Total Percent Efficiency of Control:	
3. Potential Emissions: <b>2.63 lb/hour                      11.5 tons/year</b>		4. Synthetically Limited? <input checked="" type="checkbox"/> Yes <input type="checkbox"/> No	
5. Range of Estimated Fugitive Emissions (as applicable): to                      tons/year			
6. Emission Factor: <b>142*S lb/10<sup>3</sup> gal</b>  Reference: <b>AP-42</b>		7. Emissions Method Code: <b>0</b>	
8. Calculation of Emissions:  <b>370 gal/hr x (142 x 0.05)/1000 = 2.63 lb/hr</b> <b>2.63 lb/hr x 8,760 hr/yr x ton/2000 lb = 11.51 TPY</b>			
9. Pollutant Potential/Estimated Fugitive Emissions Comment: <b>S = 0.05%</b>			

**EMISSIONS UNIT INFORMATION**

**POLLUTANT DETAIL INFORMATION**

Section [2]  
North AP Plant

Page [3] of [8]  
Sulfur Dioxide - SO<sub>2</sub>

**F2. EMISSIONS UNIT POLLUTANT DETAIL INFORMATION -  
ALLOWABLE EMISSIONS**

**Complete if the pollutant identified in Subsection F1 is or would be subject to a numerical emissions limitation.**

**Allowable Emissions** Allowable Emissions 1 of 1

1. Basis for Allowable Emissions Code: <b>OTHER</b>	2. Future Effective Date of Allowable Emissions:
3. Allowable Emissions and Units: <b>0.05% Sulfur Fuel Oil</b>	4. Equivalent Allowable Emissions: <b>2.63 lb/hour      11.5 tons/year</b>
5. Method of Compliance: <b>Fuel oil analysis and usage.</b>	
6. Allowable Emissions Comment (Description of Operating Method): <b>Based on fuel oil firing.</b>	

**Allowable Emissions** Allowable Emissions \_\_\_\_ of \_\_\_\_

1. Basis for Allowable Emissions Code:	2. Future Effective Date of Allowable Emissions:
3. Allowable Emissions and Units:	4. Equivalent Allowable Emissions: lb/hour      tons/year
5. Method of Compliance:	
6. Allowable Emissions Comment (Description of Operating Method):	

**Allowable Emissions** Allowable Emissions \_\_\_\_ of \_\_\_\_

1. Basis for Allowable Emissions Code:	2. Future Effective Date of Allowable Emissions:
3. Allowable Emissions and Units:	4. Equivalent Allowable Emissions: lb/hour      tons/year
5. Method of Compliance:	
6. Allowable Emissions Comment (Description of Operating Method):	

**F1. EMISSIONS UNIT POLLUTANT DETAIL INFORMATION –  
POTENTIAL/ESTIMATED FUGITIVE EMISSIONS**

(Optional for unregulated emissions units.)

**Potential/Estimated Fugitive Emissions**

Complete for each pollutant identified in Subsection E if applying for an air construction permit or concurrent processing of an air construction permit and a revised or renewal Title V permit. Complete for each emissions-limited pollutant identified in Subsection E if applying for an air operation permit.

1. Pollutant Emitted: FL		2. Total Percent Efficiency of Control:	
3. Potential Emissions: 4.77 lb/hour                      20.91 tons/year		4. Synthetically Limited? <input type="checkbox"/> Yes <input checked="" type="checkbox"/> No	
5. Range of Estimated Fugitive Emissions (as applicable): to                      tons/year			
6. Emission Factor: 0.045 lb/ton P <sub>2</sub> O <sub>5</sub> (MAP)  Reference: Proposed BACT		7. Emissions Method Code: 0	
8. Calculation of Emissions:  MAP Production: 0.045 lb/ton P <sub>2</sub> O <sub>5</sub> x 106.1 ton/hr P <sub>2</sub> O <sub>5</sub> = 4.77 lb/hr 4.77 lb/hr x 8,760 hr/yr / 2000 lb/ton = 20.91 TPY  DAP Production: 0.0417 lb/ton P <sub>2</sub> O <sub>5</sub> x 70.4 ton/hr P <sub>2</sub> O <sub>5</sub> = 2.94 lb/hr 2.94 lb/hr x 8,760 hr/yr / 2000 lb/ton = 12.9 TPY			
9. Pollutant Potential/Estimated Fugitive Emissions Comment: Represents total emissions from both stacks (main stack and R/G stack) combined.			

**EMISSIONS UNIT INFORMATION**

**POLLUTANT DETAIL INFORMATION**

Section [2]  
North AP Plant

Page [4] of [8]  
Fluorides - FL

**F2. EMISSIONS UNIT POLLUTANT DETAIL INFORMATION -  
ALLOWABLE EMISSIONS**

Complete if the pollutant identified in Subsection F1 is or would be subject to a numerical emissions limitation.

**Allowable Emissions** Allowable Emissions 1 of 2

1. Basis for Allowable Emissions Code: <b>OTHER</b>	2. Future Effective Date of Allowable Emissions:
3. Allowable Emissions and Units: <b>0.045 lb/ton P<sub>2</sub>O<sub>5</sub> (MAP)</b>	4. Equivalent Allowable Emissions: <b>4.77 lb/hour      20.91 tons/year</b>
5. Method of Compliance: <b>Annual stack emissions test using EPA Method 13 or 13B.</b>	
6. Allowable Emissions Comment (Description of Operating Method): <b>Proposed BACT. Allowable emissions representative of MAP production.</b>	

**Allowable Emissions** Allowable Emissions 2 of 2

1. Basis for Allowable Emissions Code: <b>OTHER</b>	2. Future Effective Date of Allowable Emissions:
3. Allowable Emissions and Units: <b>0.0417 lb/ton P<sub>2</sub>O<sub>5</sub> (DAP)</b>	4. Equivalent Allowable Emissions: <b>2.94 lb/hour      12.9 tons/year</b>
5. Method of Compliance: <b>Annual stack emissions test using EPA Method 13 or 13B.</b>	
6. Allowable Emissions Comment (Description of Operating Method): <b>Proposed BACT. Allowable emissions representative of DAP production.</b>	

**Allowable Emissions** Allowable Emissions \_\_\_\_ of \_\_\_\_

1. Basis for Allowable Emissions Code:	2. Future Effective Date of Allowable Emissions:
3. Allowable Emissions and Units:	4. Equivalent Allowable Emissions: lb/hour      tons/year
5. Method of Compliance:	
6. Allowable Emissions Comment (Description of Operating Method):	



**F1. EMISSIONS UNIT POLLUTANT DETAIL INFORMATION –  
POTENTIAL/ESTIMATED FUGITIVE EMISSIONS**

(Optional for unregulated emissions units.)

**Potential/Estimated Fugitive Emissions**

Complete for each pollutant identified in Subsection E if applying for an air construction permit or concurrent processing of an air construction permit and a revised or renewal Title V permit. Complete for each emissions-limited pollutant identified in Subsection E if applying for an air operation permit.

1. Pollutant Emitted: <b>NO<sub>x</sub></b>	2. Total Percent Efficiency of Control:
3. Potential Emissions: <b>7.41 lb/hour                      32.4 tons/year</b>	4. Synthetically Limited? <input type="checkbox"/> Yes <input checked="" type="checkbox"/> No
5. Range of Estimated Fugitive Emissions (as applicable): to                      tons/year	
6. Emission Factor: <b>20 lb/1000 gal</b>  Reference: <b>AP-42</b>	7. Emissions Method Code: <b>3</b>
8. Calculation of Emissions:  <b>370 gal/hr x 20 lb/1000 gal = 7.41 lb/hr</b> <b>7.41 lb/hr x 8,760 hr/yr x ton/2000 lb = 32.4 TPY</b>	
9. Pollutant Potential/Estimated Fugitive Emissions Comment: <b>Based on natural Gas firing.</b>	

**EMISSIONS UNIT INFORMATION**Section [2]  
North AP Plant**POLLUTANT DETAIL INFORMATION**Page [5] of [8]  
Nitrogen Oxides - NO<sub>x</sub>**F2. EMISSIONS UNIT POLLUTANT DETAIL INFORMATION -  
ALLOWABLE EMISSIONS****Complete if the pollutant identified in Subsection F1 is or would be subject to a numerical emissions limitation.****Allowable Emissions** Allowable Emissions of

1. Basis for Allowable Emissions Code:	2. Future Effective Date of Allowable Emissions:
3. Allowable Emissions and Units:	4. Equivalent Allowable Emissions: lb/hour                      tons/year
5. Method of Compliance:	
6. Allowable Emissions Comment (Description of Operating Method):	

**Allowable Emissions** Allowable Emissions of

1. Basis for Allowable Emissions Code:	2. Future Effective Date of Allowable Emissions:
3. Allowable Emissions and Units:	4. Equivalent Allowable Emissions: lb/hour                      tons/year
5. Method of Compliance:	
6. Allowable Emissions Comment (Description of Operating Method):	

**Allowable Emissions** Allowable Emissions of

1. Basis for Allowable Emissions Code:	2. Future Effective Date of Allowable Emissions:
3. Allowable Emissions and Units:	4. Equivalent Allowable Emissions: lb/hour                      tons/year
5. Method of Compliance:	
6. Allowable Emissions Comment (Description of Operating Method):	

**EMISSIONS UNIT INFORMATION**

**POLLUTANT DETAIL INFORMATION**

Section [2]  
North AP Plant

Page [6] of [8]  
Carbon Monoxide - CO

**F1. EMISSIONS UNIT POLLUTANT DETAIL INFORMATION –  
POTENTIAL/ESTIMATED FUGITIVE EMISSIONS**

(Optional for unregulated emissions units.)

**Potential/Estimated Fugitive Emissions**

Complete for each pollutant identified in Subsection E if applying for an air construction permit or concurrent processing of an air construction permit and a revised or renewal Title V permit. Complete for each emissions-limited pollutant identified in Subsection E if applying for an air operation permit.

1. Pollutant Emitted: <b>CO</b>	2. Total Percent Efficiency of Control:
3. Potential Emissions: <b>4.2 lb/hour                      18.4 tons/year</b>	4. Synthetically Limited? <input type="checkbox"/> Yes <input checked="" type="checkbox"/> No
5. Range of Estimated Fugitive Emissions (as applicable): to                      tons/year	
6. Emission Factor: <b>84 lb/10<sup>6</sup> ft<sup>3</sup></b>  Reference: <b>AP-42</b>	7. Emissions Method Code: <b>3</b>
8. Calculation of Emissions:  <b>50,000 scf/hr x 84 lb/10<sup>6</sup> scf = 4.2 lb/hr</b> <b>4.2 lb/hr x 8,760 hr/yr x ton/2000 lb = 18.4 TPY</b>	
9. Pollutant Potential/Estimated Fugitive Emissions Comment: <b>Based on Natural Gas firing.</b>	

**EMISSIONS UNIT INFORMATION**

**POLLUTANT DETAIL INFORMATION**

Section [2]  
North AP Plant

Page [6] of [8]  
Carbon Monoxide - CO

**F2. EMISSIONS UNIT POLLUTANT DETAIL INFORMATION -  
ALLOWABLE EMISSIONS**

Complete if the pollutant identified in Subsection F1 is or would be subject to a numerical emissions limitation.

Allowable Emissions Allowable Emissions \_\_\_\_\_ of \_\_\_\_\_

1. Basis for Allowable Emissions Code:	2. Future Effective Date of Allowable Emissions:
3. Allowable Emissions and Units:	4. Equivalent Allowable Emissions: lb/hour                      tons/year
5. Method of Compliance:	
6. Allowable Emissions Comment (Description of Operating Method):	

Allowable Emissions Allowable Emissions \_\_\_\_\_ of \_\_\_\_\_

1. Basis for Allowable Emissions Code:	2. Future Effective Date of Allowable Emissions:
3. Allowable Emissions and Units:	4. Equivalent Allowable Emissions: lb/hour                      tons/year
5. Method of Compliance:	
6. Allowable Emissions Comment (Description of Operating Method):	

Allowable Emissions Allowable Emissions \_\_\_\_\_ of \_\_\_\_\_

1. Basis for Allowable Emissions Code:	2. Future Effective Date of Allowable Emissions:
3. Allowable Emissions and Units:	4. Equivalent Allowable Emissions: lb/hour                      tons/year
5. Method of Compliance:	
6. Allowable Emissions Comment (Description of Operating Method):	

**EMISSIONS UNIT INFORMATION**

Section [2]  
North AP Plant

**G. VISIBLE EMISSIONS INFORMATION**

Complete if this emissions unit is or would be subject to a unit-specific visible emissions limitation.

**Visible Emissions Limitation:** Visible Emissions Limitation 1 of 1

1. Visible Emissions Subtype: <b>VE20</b>	2. Basis for Allowable Opacity: <input checked="" type="checkbox"/> Rule <input type="checkbox"/> Other
3. Allowable Opacity: Normal Conditions: <b>20 %</b> Exceptional Conditions:                      % Maximum Period of Excess Opacity Allowed:                      min/hour	
4. Method of Compliance: <b>Annual VE test using EPA Method 9.</b>	
5. Visible Emissions Comment: <b>Rule 62.296.320(4)(b), F.A.C. and Permit No. 1050053-012-AV. Applies to both Main Stack and the R/G Stack.</b>	

**Visible Emissions Limitation:** Visible Emissions Limitation \_\_\_\_ of \_\_\_\_

1. Visible Emissions Subtype:	2. Basis for Allowable Opacity: <input type="checkbox"/> Rule <input type="checkbox"/> Other
3. Allowable Opacity: Normal Conditions:                      %                      Exceptional Conditions:                      % Maximum Period of Excess Opacity Allowed:                      min/hour	
4. Method of Compliance:	
5. Visible Emissions Comment:	

# EMISSIONS UNIT INFORMATION

Section [2]  
North AP Plant

## II. CONTINUOUS MONITOR INFORMATION

Complete if this emissions unit is or would be subject to continuous monitoring.

**Continuous Monitoring System:** Continuous Monitor 1 of 19

1. Parameter Code: <b>PRS</b>	2. Pollutant(s):
3. CMS Requirement:	<input checked="" type="checkbox"/> Rule <input type="checkbox"/> Other
4. Monitor Information... Manufacturer: Model Number:	Serial Number:
5. Installation Date:	6. Performance Specification Test Date:
7. Continuous Monitor Comment:  <b>Pressure drop across R/G Primary Venturi/Cyclonic Acid Scrubber. Alternative Monitoring Plan (AMP) Administrative Order 03-C-AP.</b>	

**Continuous Monitoring System:** Continuous Monitor 2 of 19

1. Parameter Code: <b>PRS</b>	2. Pollutant(s):
3. CMS Requirement:	<input checked="" type="checkbox"/> Rule <input type="checkbox"/> Other
4. Monitor Information... Manufacturer: Model Number:	Serial Number:
5. Installation Date:	6. Performance Specification Test Date:
7. Continuous Monitor Comment:  <b>Pressure drop across R/G Secondary Venturi/Cyclonic Acid Scrubber. Alternative Monitoring Plan (AMP) Administrative Order 03-C-AP.</b>	

**EMISSIONS UNIT INFORMATION**Section [2]  
North AP Plant**H. CONTINUOUS MONITOR INFORMATION**

Complete if this emissions unit is or would be subject to continuous monitoring.

**Continuous Monitoring System:** Continuous Monitor 3 of 19

1. Parameter Code: <b>PRS</b>	2. Pollutant(s):
3. CMS Requirement:	<input checked="" type="checkbox"/> Rule <input type="checkbox"/> Other
4. Monitor Information... Manufacturer: Model Number:	Serial Number:
5. Installation Date:	6. Performance Specification Test Date:
7. Continuous Monitor Comment:  <b>Pressure drop across Ammonia Vaporizer Scrubber. Alternative Monitoring Plan (AMP) Administrative Order 03-C-AP.</b>	

**Continuous Monitoring System:** Continuous Monitor 4 of 19

1. Parameter Code: <b>PRS</b>	2. Pollutant(s):
3. CMS Requirement:	<input checked="" type="checkbox"/> Rule <input type="checkbox"/> Other
4. Monitor Information... Manufacturer: Model Number:	Serial Number:
5. Installation Date:	6. Performance Specification Test Date:
7. Continuous Monitor Comment:  <b>Pressure drop across Dryer Primary Venturi/Cyclonic Acid Scrubber. Alternative Monitoring Plan (AMP) Administrative Order 03-C-AP.</b>	

# EMISSIONS UNIT INFORMATION

Section [2]  
North AP Plant

## H. CONTINUOUS MONITOR INFORMATION

Complete if this emissions unit is or would be subject to continuous monitoring.

**Continuous Monitoring System:** Continuous Monitor 5 of 19

1. Parameter Code: <b>PRS</b>	2. Pollutant(s):
3. CMS Requirement:	<input checked="" type="checkbox"/> Rule <input type="checkbox"/> Other
4. Monitor Information... Manufacturer: Model Number: Serial Number:	
5. Installation Date:	6. Performance Specification Test Date:
7. Continuous Monitor Comment:  <b>Pressure drop across Screens and Mills Primary Venturi/Cyclonic Acid Scrubber. Alternative Monitoring Plan (AMP) Administrative Order 03-C-AP.</b>	

**Continuous Monitoring System:** Continuous Monitor 6 of 19

1. Parameter Code: <b>PRS</b>	2. Pollutant(s):
3. CMS Requirement:	<input checked="" type="checkbox"/> Rule <input type="checkbox"/> Other
4. Monitor Information... Manufacturer: Model Number: Serial Number:	
5. Installation Date:	6. Performance Specification Test Date:
7. Continuous Monitor Comment:  <b>Pressure drop across Cooler Primary Venturi/Cyclonic Acid Scrubber. Alternative Monitoring Plan (AMP) Administrative Order 03-C-AP.</b>	



# EMISSIONS UNIT INFORMATION

Section [2]  
North AP Plant

## H. CONTINUOUS MONITOR INFORMATION

Complete if this emissions unit is or would be subject to continuous monitoring.

**Continuous Monitoring System:** Continuous Monitor 7 of 19

1. Parameter Code: <b>PRS</b>	2. Pollutant(s):
3. CMS Requirement:	<input checked="" type="checkbox"/> Rule <input type="checkbox"/> Other
4. Monitor Information... Manufacturer: Model Number: Serial Number:	
5. Installation Date:	6. Performance Specification Test Date:
7. Continuous Monitor Comment:  <b>Pressure drop across Dryer and Screens and Mills secondary cross-flow scrubber before the Main Stack. Alternative Monitoring Plan (AMP) Administrative Order 03-C-AP.</b>	

**Continuous Monitoring System:** Continuous Monitor 8 of 19

1. Parameter Code: <b>FLOW</b>	2. Pollutant(s):
3. CMS Requirement:	<input checked="" type="checkbox"/> Rule <input type="checkbox"/> Other
4. Monitor Information... Manufacturer: Model Number: Serial Number:	
5. Installation Date:	6. Performance Specification Test Date:
7. Continuous Monitor Comment:  <b>Scrubbing liquid flow rate of R/G Primary Venturi/Cyclonic Acid Scrubber. Alternative Monitoring Plan (AMP) Administrative Order 03-C-AP.</b>	

**EMISSIONS UNIT INFORMATION**Section [2]]  
North AP Plant**H. CONTINUOUS MONITOR INFORMATION**

Complete if this emissions unit is or would be subject to continuous monitoring.

**Continuous Monitoring System:** Continuous Monitor 9 of 19

1. Parameter Code: <b>FLOW</b>	2. Pollutant(s):
3. CMS Requirement:	<input checked="" type="checkbox"/> Rule <input type="checkbox"/> Other
4. Monitor Information... Manufacturer: Model Number:	Serial Number:
5. Installation Date:	6. Performance Specification Test Date:
7. Continuous Monitor Comment:  <b>Scrubbing liquid flow rate of R/G Secondary Venturi/Cyclonic Acid Scrubber. Alternative Monitoring Plan (AMP) Administrative Order 03-C-AP.</b>	

**Continuous Monitoring System:** Continuous Monitor 10 of 19

1. Parameter Code: <b>FLOW</b>	2. Pollutant(s):
3. CMS Requirement:	<input checked="" type="checkbox"/> Rule <input type="checkbox"/> Other
4. Monitor Information... Manufacturer: Model Number:	Serial Number:
5. Installation Date:	6. Performance Specification Test Date:
7. Continuous Monitor Comment:  <b>Scrubbing liquid flow rate of Ammonia Vaporizer Scrubber. Alternative Monitoring Plan (AMP) Administrative Order 03-C-AP.</b>	

**EMISSIONS UNIT INFORMATION**

Section [2]  
 North AP Plant

**H. CONTINUOUS MONITOR INFORMATION**

Complete if this emissions unit is or would be subject to continuous monitoring.

**Continuous Monitoring System:** Continuous Monitor 11 of 19

1. Parameter Code: <b>FLOW</b>	2. Pollutant(s):
3. CMS Requirement:	<input checked="" type="checkbox"/> Rule <input type="checkbox"/> Other
4. Monitor Information... Manufacturer: Model Number: <span style="float: right;">Serial Number:</span>	
5. Installation Date:	6. Performance Specification Test Date:
7. Continuous Monitor Comment:  <b>Scrubbing liquid flow rate of Dryer Primary Venturi/Cyclonic Acid Scrubber. Alternative Monitoring Plan (AMP) Administrative Order 03-C-AP.</b>	

**Continuous Monitoring System:** Continuous Monitor 12 of 19

1. Parameter Code: <b>FLOW</b>	2. Pollutant(s):
3. CMS Requirement:	<input checked="" type="checkbox"/> Rule <input type="checkbox"/> Other
4. Monitor Information... Manufacturer: Model Number: <span style="float: right;">Serial Number:</span>	
5. Installation Date:	6. Performance Specification Test Date:
7. Continuous Monitor Comment:  <b>Scrubbing liquid flow rate of Screens and Mills Primary Venturi/Cyclonic Acid Scrubber. Alternative Monitoring Plan (AMP) Administrative Order 03-C-AP.</b>	

# EMISSIONS UNIT INFORMATION

Section [2]  
North AP Plant

## H. CONTINUOUS MONITOR INFORMATION

Complete if this emissions unit is or would be subject to continuous monitoring.

**Continuous Monitoring System:** Continuous Monitor 13 of 19

1. Parameter Code: <b>FLOW</b>	2. Pollutant(s):
3. CMS Requirement:	<input checked="" type="checkbox"/> Rule <input type="checkbox"/> Other
4. Monitor Information... Manufacturer: Model Number:	Serial Number:
5. Installation Date:	6. Performance Specification Test Date:
7. Continuous Monitor Comment:  <b>Scrubbing liquid flow rate of Cooler Primary Venturi/Cyclonic Acid Scrubber. Alternative Monitoring Plan (AMP) Administrative Order 03-C-AP.</b>	

**Continuous Monitoring System:** Continuous Monitor 14 of 19

1. Parameter Code: <b>FLOW</b>	2. Pollutant(s):
3. CMS Requirement:	<input checked="" type="checkbox"/> Rule <input type="checkbox"/> Other
4. Monitor Information... Manufacturer: Model Number:	Serial Number:
5. Installation Date:	6. Performance Specification Test Date:
7. Continuous Monitor Comment:  <b>Scrubbing liquid flow rate of Dryer and Screens and Mills secondary cross-flow scrubber before the Main Stack. Alternative Monitoring Plan (AMP) Administrative Order 03-C-AP.</b>	

**EMISSIONS UNIT INFORMATION**Section [2]  
North AP Plant**H. CONTINUOUS MONITOR INFORMATION**

Complete if this emissions unit is or would be subject to continuous monitoring.

**Continuous Monitoring System:** Continuous Monitor 15 of 19

1. Parameter Code: <b>Fan Amperage</b>	2. Pollutant(s):
3. CMS Requirement:	<input checked="" type="checkbox"/> Rule <input type="checkbox"/> Other
4. Monitor Information... Manufacturer: Model Number:	Serial Number:
5. Installation Date:	6. Performance Specification Test Date:
7. Continuous Monitor Comment:  <b>Fan amperage for the Ammonia Vaporizer Scrubber before the R/G stack. Alternative Monitoring Plan (AMP) Administrative Order 03-C-AP.</b>	

**Continuous Monitoring System:** Continuous Monitor 16 of 19

1. Parameter Code: <b>Fan Amperage</b>	2. Pollutant(s):
3. CMS Requirement:	<input checked="" type="checkbox"/> Rule <input type="checkbox"/> Other
4. Monitor Information... Manufacturer: Model Number:	Serial Number:
5. Installation Date:	6. Performance Specification Test Date:
7. Continuous Monitor Comment:  <b>Fan amperage for the Dryer Primary Venturi/Cyclonic Acid Scrubber. Alternative Monitoring Plan (AMP) Administrative Order 03-C-AP.</b>	

**EMISSIONS UNIT INFORMATION**Section [2]  
North AP Plant**H. CONTINUOUS MONITOR INFORMATION**

Complete if this emissions unit is or would be subject to continuous monitoring.

**Continuous Monitoring System:** Continuous Monitor 17 of 19

1. Parameter Code: <b>Fan Amperage</b>	2. Pollutant(s):
3. CMS Requirement:	<input checked="" type="checkbox"/> Rule <input type="checkbox"/> Other
4. Monitor Information... Manufacturer: Model Number:	Serial Number:
5. Installation Date:	6. Performance Specification Test Date:
7. Continuous Monitor Comment:  <b>Fan amperage for the Screens and Mills Primary Venturi/Cyclonic Acid Scrubber. Alternative Monitoring Plan (AMP) Administrative Order 03-C-AP.</b>	

**Continuous Monitoring System:** Continuous Monitor 18 of 19

1. Parameter Code: <b>Fan Amperage</b>	2. Pollutant(s):
3. CMS Requirement:	<input checked="" type="checkbox"/> Rule <input type="checkbox"/> Other
4. Monitor Information... Manufacturer: Model Number:	Serial Number:
5. Installation Date:	6. Performance Specification Test Date:
7. Continuous Monitor Comment:  <b>Fan amperage for the Cooler Primary Venturi/Cyclonic Acid Scrubber. Alternative Monitoring Plan (AMP) Administrative Order 03-C-AP.</b>	

**EMISSIONS UNIT INFORMATION**

Section [2]  
North AP Plant

**H. CONTINUOUS MONITOR INFORMATION**

**Complete if this emissions unit is or would be subject to continuous monitoring.**

**Continuous Monitoring System:** Continuous Monitor 19 of 19

1. Parameter Code: <b>Mass Flow</b>	2. Pollutant(s):
3. CMS Requirement:	<input checked="" type="checkbox"/> Rule <input type="checkbox"/> Other
4. Monitor Information... Manufacturer: Model Number: Serial Number:	
5. Installation Date:	6. Performance Specification Test Date:
7. Continuous Monitor Comment:  <b>40 CFR 63.325(a). Mass flow of phosphorus bearing feed material. Alternative Monitoring Plan (AMP) Administrative Order 03-C-AP.</b>	

**Continuous Monitoring System:** Continuous Monitor \_\_\_\_ of \_\_\_\_

1. Parameter Code:	2. Pollutant(s):
3. CMS Requirement:	<input type="checkbox"/> Rule <input type="checkbox"/> Other
4. Monitor Information... Manufacturer: Model Number: Serial Number:	
5. Installation Date:	6. Performance Specification Test Date:
7. Continuous Monitor Comment:	

**EMISSIONS UNIT INFORMATION**

Section [2]  
North AP Plant

**I. EMISSIONS UNIT ADDITIONAL INFORMATION**

**Additional Requirements for All Applications, Except as Otherwise Stated**

1. Process Flow Diagram (Required for all permit applications, except Title V air operation permit revision applications if this information was submitted to the department within the previous five years and would not be altered as a result of the revision being sought) <input checked="" type="checkbox"/> Attached, Document ID: <b>PSD Report</b> <input type="checkbox"/> Previously Submitted, Date _____
2. Fuel Analysis or Specification (Required for all permit applications, except Title V air operation permit revision applications if this information was submitted to the department within the previous five years and would not be altered as a result of the revision being sought) <input checked="" type="checkbox"/> Attached, Document ID: <b>MGB-EU1-12</b> <input type="checkbox"/> Previously Submitted, Date _____
3. Detailed Description of Control Equipment (Required for all permit applications, except Title V air operation permit revision applications if this information was submitted to the department within the previous five years and would not be altered as a result of the revision being sought) <input checked="" type="checkbox"/> Attached, Document ID: <b>PSD Report</b> <input type="checkbox"/> Previously Submitted, Date _____
4. Procedures for Startup and Shutdown (Required for all operation permit applications, except Title V air operation permit revision applications if this information was submitted to the department within the previous five years and would not be altered as a result of the revision being sought) <input type="checkbox"/> Attached, Document ID: _____ <input type="checkbox"/> Previously Submitted, Date _____ <input checked="" type="checkbox"/> Not Applicable (construction application)
5. Operation and Maintenance Plan (Required for all permit applications, except Title V air operation permit revision applications if this information was submitted to the department within the previous five years and would not be altered as a result of the revision being sought) <input type="checkbox"/> Attached, Document ID: _____ <input type="checkbox"/> Previously Submitted, Date _____ <input checked="" type="checkbox"/> Not Applicable
6. Compliance Demonstration Reports/Records <input type="checkbox"/> Attached, Document ID: _____ Test Date(s)/Pollutant(s) Tested: _____ <input type="checkbox"/> Previously Submitted, Date: _____ Test Date(s)/Pollutant(s) Tested: _____ <input type="checkbox"/> To be Submitted, Date (if known): _____ Test Date(s)/Pollutant(s) Tested: _____ <input checked="" type="checkbox"/> Not Applicable Note: For FESOP applications, all required compliance demonstration records/reports must be submitted at the time of application. For Title V air operation permit applications, all required compliance demonstration reports/records must be submitted at the time of application, or a compliance plan must be submitted at the time of application.
7. Other Information Required by Rule or Statute <input type="checkbox"/> Attached, Document ID: _____ <input checked="" type="checkbox"/> Not Applicable



**EMISSIONS UNIT INFORMATION**

**Section [2]  
North AP Plant**

**Additional Requirements for Air Construction Permit Applications**

1. Control Technology Review and Analysis (Rules 62-212.400(6) and 62-212.500(7), F.A.C.; 40 CFR 63.43(d) and (e)) <input checked="" type="checkbox"/> Attached, Document ID: <b>PSD Report</b> <input type="checkbox"/> Not Applicable
2. Good Engineering Practice Stack Height Analysis (Rule 62-212.400(5)(h)6., F.A.C., and Rule 62-212.500(4)(f), F.A.C.) <input checked="" type="checkbox"/> Attached, Document ID: <b>PSD Report</b> <input type="checkbox"/> Not Applicable
3. Description of Stack Sampling Facilities (Required for proposed new stack sampling facilities only) <input type="checkbox"/> Attached, Document ID: _____ <input checked="" type="checkbox"/> Not Applicable

**Additional Requirements for Title V Air Operation Permit Applications**

1. Identification of Applicable Requirements <input type="checkbox"/> Attached, Document ID: _____ <input type="checkbox"/> Not Applicable
2. Compliance Assurance Monitoring <input type="checkbox"/> Attached, Document ID: _____ <input type="checkbox"/> Not Applicable
3. Alternative Methods of Operation <input type="checkbox"/> Attached, Document ID: _____ <input type="checkbox"/> Not Applicable
4. Alternative Modes of Operation (Emissions Trading) <input type="checkbox"/> Attached, Document ID: _____ <input type="checkbox"/> Not Applicable
5. Acid Rain Part Application <input type="checkbox"/> Certificate of Representation (EPA Form No. 7610-1) <input type="checkbox"/> Copy Attached, Document ID: _____ <input type="checkbox"/> Acid Rain Part (Form No. 62-210.900(1)(a)) <input type="checkbox"/> Attached, Document ID: _____ <input type="checkbox"/> Previously Submitted, Date: _____ <input type="checkbox"/> Repowering Extension Plan (Form No. 62-210.900(1)(a)1.) <input type="checkbox"/> Attached, Document ID: _____ <input type="checkbox"/> Previously Submitted, Date: _____ <input type="checkbox"/> New Unit Exemption (Form No. 62-210.900(1)(a)2.) <input type="checkbox"/> Attached, Document ID: _____ <input type="checkbox"/> Previously Submitted, Date: _____ <input type="checkbox"/> Retired Unit Exemption (Form No. 62-210.900(1)(a)3.) <input type="checkbox"/> Attached, Document ID: _____ <input type="checkbox"/> Previously Submitted, Date: _____ <input type="checkbox"/> Phase II NOx Compliance Plan (Form No. 62-210.900(1)(a)4.) <input type="checkbox"/> Attached, Document ID: _____ <input type="checkbox"/> Previously Submitted, Date: _____ <input type="checkbox"/> Phase II NOx Averaging Plan (Form No. 62-210.900(1)(a)5.) <input type="checkbox"/> Attached, Document ID: _____ <input type="checkbox"/> Previously Submitted, Date: _____ <input type="checkbox"/> Not Applicable

**EMISSIONS UNIT INFORMATION**

**Section [2]  
North AP Plant**

**Additional Requirements Comment**

**PSD REPORT**

## TABLE OF CONTENTS

<u>SECTION</u>	<u>PAGE</u>
1.0 INTRODUCTION .....	1-1
2.0 PROJECT DESCRIPTION .....	2-1
2.1 SOUTH AP PLANT .....	2-1
2.1.1 GENERAL .....	2-1
2.1.2 PROCESS DESCRIPTION .....	2-1
2.1.3 POLLUTION CONTROL EQUIPMENT AND AIR EMISSIONS .....	2-2
2.2 NORTH MAP/DAP FERTILIZER PLANT .....	2-3
2.2.1 GENERAL .....	2-3
2.2.2 PROCESS DESCRIPTION .....	2-3
2.2.3 POLLUTION CONTROL EQUIPMENT AND AIR EMISSIONS .....	2-4
2.3 AFFECTS ON OTHER EMISSIONS UNITS .....	2-5
2.3.1 MAP/DAP STORAGE AND SHIPPING BUILDINGS .....	2-5
2.3.2 NOS. 4, 5, AND 6 SULFURIC ACID PLANTS .....	2-6
2.3.3 PHOSPHORIC ACID PLANTS .....	2-6
2.4 STACK DATA .....	2-6
3.0 AIR QUALITY REVIEW REQUIREMENTS .....	3-1
3.1 NATIONAL AND STATE AMBIENT AIR QUALITY STANDARDS (AAQs) .....	3-1
3.2 PSD REQUIREMENTS .....	3-1
3.2.1 GENERAL REQUIREMENTS .....	3-1
3.2.2 CONTROL TECHNOLOGY REVIEW .....	3-3
3.2.3 SOURCE IMPACT ANALYSIS .....	3-4
3.2.4 AIR QUALITY MONITORING REQUIREMENTS .....	3-7
3.2.5 SOURCE INFORMATION/GEP STACK HEIGHT .....	3-7
3.2.6 ADDITIONAL IMPACT ANALYSIS .....	3-8
3.3 NONATTAINMENT RULES .....	3-8
3.4 EMISSION STANDARDS .....	3-9
3.4.1 NEW SOURCE PERFORMANCE STANDARDS .....	3-9
3.4.2 NESHAPS FOR SOURCE CATEGORIES .....	3-9
3.4.3 FLORIDA RULES .....	3-9
3.5 SOURCE APPLICABILITY .....	3-10
3.5.1 AREA CLASSIFICATION .....	3-10
3.5.2 PSD REVIEW .....	3-10
3.5.3 EMISSION STANDARDS .....	3-11
4.0 AMBIENT MONITORING ANALYSIS .....	4-1
4.1 MONITORING REQUIREMENTS .....	4-1
4.2 PM <sub>10</sub> AMBIENT MONITORING ANALYSIS .....	4-2

## TABLE OF CONTENTS (continued)

4.3	FLUORIDE AMBIENT MONITORING ANALYSIS .....	4-2
4.4	NO <sub>x</sub> AMBIENT MONITORING ANALYSIS .....	4-2
5.0	BEST AVAILABLE CONTROL TECHNOLOGY ANALYSIS .....	5-1
5.1	REQUIREMENTS .....	5-1
5.2	SOUTH AND NORTH AP PLANTS—PARTICULATE MATTER (PM/PM <sub>10</sub> ).....	5-1
5.2.1	PROPOSED CONTROL TECHNOLOGY .....	5-1
5.2.2	BACT ANALYSIS .....	5-2
5.2.3	BACT SELECTION .....	5-10
5.3	SOUTH AND NORTH AP PLANTS—FLUORIDES.....	5-11
5.3.1	PROPOSED CONTROL TECHNOLOGY .....	5-11
5.3.2	BACT ANALYSIS .....	5-11
5.3.3	BACT SELECTION .....	5-13
5.4	SOUTH AND NORTH AP PLANTS—NITROGEN OXIDES.....	5-14
5.4.1	PROPOSED CONTROL TECHNOLOGY .....	5-14
5.4.2	BACT ANALYSIS .....	5-14
5.4.3	BACT SELECTION .....	5-18
6.0	AIR QUALITY IMPACT ANALYSIS .....	6-1
6.1	GENERAL APPROACH.....	6-1
6.2	SIGNIFICANT IMPACT ANALYSIS.....	6-2
6.3	AAQS AND PSD CLASS II ANALYSES.....	6-3
6.4	PSD CLASS I ANALYSIS.....	6-3
6.5	MODEL SELECTION.....	6-3
6.6	METEOROLOGICAL DATA.....	6-4
6.7	EMISSION INVENTORY .....	6-5
6.7.1	SIGNIFICANT IMPACT ANALYSIS.....	6-5
6.7.2	AAQS AND PSD CLASS II ANALYSES.....	6-5
6.7.3	MOSAIC GREEN BAY PSD BASELINE INVENTORY FOR 1974.....	6-6
6.7.4	MOSAIC GREEN BAY PSD BASELINE INVENTORY FOR 1988.....	6-6
6.7.5	PSD CLASS I ANALYSIS.....	6-6
6.8	RECEPTOR LOCATIONS.....	6-6
6.8.1	SITE VICINITY .....	6-6
6.8.2	CLASS I AREA.....	6-7
6.9	BACKGROUND CONCENTRATIONS .....	6-7
6.10	BUILDING DOWNWASH EFFECTS .....	6-7
6.11	MODEL RESULTS .....	6-8
6.11.1	SIGNIFICANT IMPACT ANALYSIS.....	6-8
6.11.2	AAQS ANALYSIS.....	6-8

TABLE OF CONTENTS (continued)

	6.11.3 PSD CLASS II ANALYSIS .....	6-8
	6.11.4 PSD CLASS I SIGNIFICANT IMPACT ANALYSIS.....	6-9
	6.11.5 FLUORIDE IMPACTS IN THE SITE VICINITY AND CLASS I AREA.....	6-9
7.0	ADDITIONAL IMPACT ANALYSIS .....	7-1
7.1	INTRODUCTION .....	7-1
7.2	SOIL, VEGETATION, AND AQRV ANALYSIS METHODOLOGY.....	7-1
7.3	IMPACTS IN THE VICINITY OF THE MOSAIC GREEN BAY PLANT .....	7-2
	7.3.1 IMPACTS TO SOILS AND VEGETATION.....	7-2
	7.3.2 IMPACTS ON VISIBILITY.....	7-2
	7.3.3 IMPACTS DUE TO ASSOCIATED POPULATION GROWTH .....	7-2
7.4	CLASS I AREA IMPACT ANALYSIS .....	7-3
	7.4.1 IDENTIFICATION OF AQRVS AND METHODOLOGY .....	7-3
	7.4.2 VEGETATION.....	7-4
	7.4.3 WILDLIFE.....	7-7
	7.4.4 SOILS .....	7-8
	7.4.5 IMPACTS UPON VISIBILITY .....	7-10
	7.4.6 NITROGEN DEPOSITION.....	7-12
7.5	IMPACTS DUE TO ASSOCIATED DIRECT GROWTH .....	7-13
	7.5.1 INTRODUCTION .....	7-13
	7.5.2 RESIDENTIAL GROWTH.....	7-14
	7.5.3 COMMERCIAL GROWTH.....	7-15
	7.5.4 INDUSTRIAL GROWTH.....	7-17
	7.5.5 AIR QUALITY DISCUSSION .....	7-18
8.0	REFERENCES .....	8-1

APPENDICES

APPENDIX A ACTUAL EMISSIONS FOR 2003 AND 2004, MOSAIC GREEN BAY

APPENDIX B PM<sub>10</sub> AND NO<sub>x</sub> EMISSION INVENTORIES FOR THE AACQ AND PSD CLASS  
II INCREMENT ANALYSES

APPENDIX C CALPUFF MODEL DESCRIPTION AND METHODOLOGY

APPENDIX D BPIP INPUT AND OUTPUT FILES WITH SOURCE, BUILDINGS AND  
RECEPTOR LOCATIONS

APPENDIX E ISCST3 MODEL SUMMARY AND EXAMPLE INPUT FILES

---

**TABLE OF CONTENTS (continued)****LIST OF TABLES**

Table 2-1	Summary of Existing and Proposed Allowable Emission Rates for the AP Plants, Mosaic Green Bay
Table 2-2	Maximum Emission Rates Due to Fuel Combustion for the Dryer at the South AP Plant, Mosaic Green Bay
Table 2-3	Actual Annual (2003-2004) Emissions for Sources Affected by the Proposed Project, Mosaic Green Bay
Table 2-4	Maximum Emission Rates Due to Fuel Combustion for the Dryer at the North AP Plant, Mosaic Green Bay
Table 2-5	Stack and Operating Data for the Proposed Project Sources Only – Mosaic Green Bay
Table 3-1	National and State AAQS, Allowable PSD Increments, and Significant Impact Levels
Table 3-2	PSD Significant Emission Rates and <i>de Minimis</i> Monitoring Concentrations
Table 3-3	Contemporaneous Debottlenecking Emissions Analysis and PSD Applicability
Table 3-4	Predicted Impacts Due to the Proposed Project Compared to Class II Significant Impact Levels and Ambient Monitoring <i>de Minimis</i> Levels
Table 4-1	Summary of PM <sub>10</sub> Monitoring Data Collected Near Mosaic Green Bay
Table 4-2	Summary of NO <sub>2</sub> Monitoring Data Collected Near Mosaic Green Bay
Table 5-1	Summary of BACT Determination for Particulate Emissions from GTSP, MAP, and DAP Manufacturing Facilities
Table 5-2	PM/PM <sub>10</sub> Control Technology Feasibility Analysis for South and North AP Plants, Mosaic Green Bay
Table 5-3	Cost Analysis for Adding Venturi Scrubbers for PM Control, South and North AP Plants, Mosaic Green Bay
Table 5-4	Summary of Recent South AP Plant Emission Tests at Mosaic Green Bay
Table 5-5	Summary of Recent North AP Plant Emissions Tests at Mosaic Green Bay
Table 5-6	Summary of BACT Determinations for Fluoride Emissions from GTSP, MAP and DAP Manufacturing Facilities
Table 5-7	Fluoride Control Technology Feasibility Analysis for the Ammoniated Phosphate Fertilizer Plants at Mosaic Green Bay
Table 5-8	Cost Analysis for Additional Controls for Fluoride Removal, South and North AP Plants, Mosaic Green Bay

---

**TABLE OF CONTENTS (continued)**

Table 5-9	Summary of Recent North MAP/DAP Fertilizer Plant Emissions Tests at Mosaic Green Bay
Table 5-10	Summary of BACT Determinations for Nitrogen Oxide Emissions from GTSP, MAP and DAP Manufacturing Facilities
Table 5-11	NO <sub>x</sub> Control Technology Feasibility Analysis for South and North AP Plant Dryers, Mosaic Green Bay
Table 6-1	Major Features of the ISCST3 Model
Table 6-2	Major Features of the CALPUFF Model, Version 5.711a
Table 6-3	Summary of PM <sub>10</sub> , F, and NO <sub>x</sub> Current Actual and Future Potential Emission Rates for the Proposed Project – Mosaic Green Bay
Table 6-4	Stack and Operating Data for Current and Future Operations for All Sources – Mosaic Green Bay
Table 6-5	Summary of Future Potential PM/PM <sub>10</sub> and NO <sub>x</sub> Emission Rates for all Sources – Mosaic Green Bay
Table 6-6	Summary of all PM <sub>10</sub> -Emitting Facilities in the Vicinity of the Mosaic Green Bay Plant
Table 6-7	Summary of Facilities with NO <sub>x</sub> Emission Sources in the Vicinity of the Mosaic Green Bay Plant
Table 6-8	Baseline (1974) PM/PM <sub>10</sub> and SO <sub>2</sub> Emission Rates and Stack and Operating Data for All Sources – Mosaic Green Bay
Table 6-9	Baseline (1988) NO <sub>x</sub> Emission Rates and Stack and Operating Data for All Sources – Mosaic Green Bay
Table 6-10	Summary of SO <sub>2</sub> and SAM Emission Rates for the Proposed Project–Mosaic Green Bay
Table 6-11	Mosaic Green Bay Property Boundary Receptors Used in Modeling Analysis
Table 6-12	Chassahowitzka NWA Receptors Used in the Modeling Analysis
Table 6-13	Building Dimensions Used in the Modeling Analysis, Mosaic Green Bay
Table 6-14	Maximum Predicted Increase in Pollutant Impacts Due to the Proposed Project Only, Mosaic Green Bay
Table 6-15	Maximum Predicted AAQS Impacts for the Screening Analysis, Mosaic Green Bay
Table 6-16	Maximum Predicted AAQS Impacts for the Refined Analysis, Mosaic Green Bay



**TABLE OF CONTENTS (continued)**

Table 6-17	Maximum Predicted PSD Class II Increment Consumption for the Screening Analysis, Mosaic Green Bay
Table 6-18	Maximum Predicted PSD Class II Increment Consumption for the Refined Analysis, Mosaic Green Bay
Table 6-19	Maximum Predicted Impacts for the Proposed Project Only at the Chassahowitzka PSD Class I Area Using the CALPUFF Model, Mosaic Green Bay
Table 6-20	Maximum Predicted Increase in Fluoride Impacts Due to the Proposed Project at the Site Vicinity, Mosaic Green Bay
Table 6-21	Maximum Predicted Increase in Fluoride Impacts Due to the Proposed Project at the Chassahowitzka PSD Class I Area, Mosaic Green Bay
Table 7-1	Summary of Maximum Predicted Impacts Due to the Proposed Project Only at the Chassahowitzka NWA Class I Area, Mosaic Green Bay
Table 7-2	Examples of Reported Effects of Air Pollutants at Concentrations Below the National Secondary Ambient Air Quality Standards
Table 7-3	Maximum 24-hour Average Visibility Impairment Predicted for the Project Only at the PSD Class I Area of the Chassahowitzka NWA, Mosaic Green Bay
Table 7-4	Maximum Nitrogen Annual Deposition Predicted for the Project Only at the PSD Class I Area of the Chassahowitzka NWA, Mosaic Green Bay

**LIST OF FIGURES**

Figure 2-1	Facility Location Map of Mosaic Green Bay
Figure 2-2	Facility Plot Plan
Figure 2-3	South AP Fertilizer Plant, Process Flow Diagram, Mosaic Green Bay
Figure 2-4	North AP Fertilizer Plant, Process Flow Diagram, Mosaic Green Bay
Figure 6-1	Property Boundary and Receptor Grid Used for the Air Modeling Analyses, Mosaic Green Bay, Bartow, Florida
Figure 6-2	Building and Stack Locations, Mosaic Green Bay, Bartow, Florida
Figure 7-1	Population and Household Unit Trends in Polk County
Figure 7-2	Retail and Wholesale Trade Trends in Polk County
Figure 7-3	Labor Force Trend in Polk County
Figure 7-4	Hotel and Motel Trend in Polk County

---

**TABLE OF CONTENTS (continued)**

Figure 7-5	Vehicle Miles Traveled (VMT) Estimates for Motor Vehicles for Polk County
Figure 7-6	Mining, Manufacturing and Citrus Industry Trends in Polk County
Figure 7-7	Electrical Power Generation Capacity in Polk County
Figure 7-8	Mobile Source Emissions (Tons per Day) of CO, VOC, and NO <sub>x</sub> in Polk County
Figure 7-9	Measured Annual Average PM <sub>10</sub> Concentrations (1988 to 2004) and Total Suspended Particulate Concentrations (1977 to 1987) – Mulberry, Polk County
Figure 7-10	Measured 24-Hour Average PM <sub>10</sub> Concentrations (1988 to 2004) and Total Suspended Particulate Concentrations (1977 to 1987) (2 <sup>nd</sup> Highest Values) – Mulberry, Polk County
Figure 7-11	Measured Annual Average Nitrogen Dioxide Concentrations from 1981 to 2004 – Hillsborough County

## 1.0 INTRODUCTION

Mosaic Fertilizer, LLC (Mosaic) operates the Green Bay phosphate fertilizer manufacturing facility located in Bartow, Polk County, Florida. The plant is currently operating under Title V Permit No. 1050053-012-AV. The existing Green Bay plant consists of molten sulfur (rail and truck unloading and truck loading) and wet phosphate rock handling systems, phosphoric acid production, sulfuric acid production, two fertilizer plants, and a fertilizer shipping and storage unit. Phosphate rock, along with sulfuric acid produced in the Nos. 4, 5, and 6 Sulfuric Acid Plants, are fed to the Phosphoric Acid Plant, where phosphoric acid is manufactured, concentrated, clarified, aged, blended, and stored. The phosphoric acid along with ammonia is fed to the South Ammonium Phosphate (AP) Plant and the North Monoammonium/Diammonium Phosphate (MAP/DAP) Fertilizer Plant in order to manufacture MAP and DAP fertilizer products. The MAP/DAP fertilizer is then transferred to the storage and shipping buildings, where it is then loaded into trucks or railcars and shipped out.

In July 2003, Mosaic was issued Air Construction Permit No. 1050053-034-AC to modify what was then the Green Bay South DAP Fertilizer Plant so it could also produce MAP fertilizer. This modification involved the installation of a pipe so that phosphoric acid, normally only fed to the reactor, could be fed to the granulator. An added benefit of this modification was the reduction of losses of insoluble phosphorous pentoxide ( $P_2O_5$ ) and improvements in product quality. At the time of this permitting action, there were extreme market demands for MAP fertilizer. To quickly respond to these market pressures, Mosaic accepted an annual limit on production of 277,667 tons per year (TPY) for total MAP/DAP product, expressed as 100-percent  $P_2O_5$ , to avoid the inherent delays associated with obtaining a Prevention of Significant Deterioration (PSD) permit. Through this permitting action, the South DAP Fertilizer Plant was renamed as the South AP Plant.

The purpose of the present PSD permit application is to increase the annual production limit for the South AP Plant from 277,667 to 402,960 TPY of MAP/DAP, expressed as 100-percent  $P_2O_5$ . This annual production limit is based on continuous operation of the South AP Plant at the currently permitted hourly production limit of 46 tons per hour (TPH) of  $P_2O_5$  input. No physical changes to the South AP Plant will be required to implement this change.

This PSD permit application is also request to modify the North MAP/DAP Plant making a physical change similar to the South AP Plant, i.e., by adding a pipe that can be used to divert a portion of the phosphoric acid, normally fed only to the reactor, to also feed the granulator. Mosaic is also proposing a minor change to one of the venturi scrubbers in the plant. Through this permitting action, the North MAP/DAP Fertilizer Plant will be renamed the North AP Plant.

Based on the potential increase in actual emissions of particulate matter (PM), particulate matter less than or equal to 10 micrometers (PM<sub>10</sub>), nitrogen oxides (NO<sub>x</sub>), and fluorides (F) due to the proposed modifications, the proposed project will constitute a major modification to a major stationary source and thus, trigger new source review (NSR) under the provisions of the federal and state PSD regulations.

For each pollutant subject to PSD review, the following analyses are required:

1. Ambient monitoring analysis, unless the net increase in emissions due to the modification causes impacts that are below specified significant impact levels;
2. Application of best available control technology (BACT) for each new or modified emissions unit;
3. Air quality impact analysis, unless the net increase in emissions due to the modification causes impacts which are below specified significant impact levels; and
4. Additional impact analysis (impact on soils, vegetation, visibility), including impacts on PSD Class I areas.

This PSD permit application addresses these requirements and is organized into six additional sections, followed by the appendices. A description of the project, including air emission sources and pollution control equipment, is presented in Section 2.0. A regulatory applicability analysis of the proposed project is presented in Section 3.0. The ambient air monitoring analysis is presented in Section 4.0. The BACT analysis for applicable pollutants is presented in Section 5.0. The air quality impact analysis and additional impact analysis are presented in Sections 6.0 and 7.0, respectively. Supporting documentation is presented in the appendices.

## 2.0 PROJECT DESCRIPTION

Mosaic is proposing to increase the currently permitted annual production limit for the South AP Fertilizer Plant from 277,667 to 402,960 TPY of MAP/DAP, expressed as 100-percent  $P_2O_5$ . Additionally, Mosaic is proposing to physically modify the North DAP/MAP Fertilizer Plant in a manner similar to the South AP Plant, by adding a pipe to allow phosphoric acid to be fed to the granulator. Currently, phosphoric acid can only be fed to the reactor.

The plant is located in Bartow, Florida, on County Road (CR) 640 West in Polk County (refer to Figure 2-1). A plot plan of the facility, showing stack locations, is presented in Figure 2-2. The following section describes the proposed physical modifications to the North DAP/MAP Fertilizer Plant in more detail. No physical modifications are proposed for the South AP Plant.

### 2.1 SOUTH AP PLANT

#### 2.1.1 GENERAL

Mosaic currently operates a South AP Fertilizer Plant. The South AP Fertilizer Plant has a maximum permitted feed rate of 46 TPH of  $P_2O_5$  and a maximum permitted annual production rate of 277,667 TPY of  $P_2O_5$ . Mosaic is requesting to increase its maximum permitted annual production rate from 277,667 to 402,960 TPY of  $P_2O_5$ , based on continuous operation at the currently permitted hourly production rate of 46 TPH. No physical changes to South AP Plant are proposed by this project.

#### 2.1.2 PROCESS DESCRIPTION

In the existing South AP Plant manufacturing process, phosphoric acid and anhydrous ammonia are reacted in a sealed reaction tank to produce MAP or DAP. Ammonia can further be added to the ammoniated acid in a rotary reactor-granulator (R/G). The granulated, unsized DAP/MAP is then dried in a rotary dryer. The dryer is fired at a maximum heat input rate of 60 million British thermal units per hour (MMBtu/hr) by natural gas as the primary fuel and No. 2 fuel oil or liquefied petroleum gas (LPG) as the backup fuels.

The dried DAP/MAP material is sized and screened, and the oversized and undersized material is recycled back to the granulator. The product is then cooled, screened, and sent to storage in the MAP/DAP Storage Buildings. A dedusting agent is applied to the product prior to storage in the buildings. A flow diagram of the existing South AP Plant is presented in Figure 2-3.

### 2.1.3 POLLUTION CONTROL EQUIPMENT AND AIR EMISSIONS

The South AP Fertilizer Plant currently utilizes five scrubbers to control emissions. Evacuated gases from the reactor and granulator are vented to the R/G venturi/cyclonic scrubber and then vented through a pond water scrubber. This gas stream is then vented through "Stack A". Emissions from the dryer are evacuated through the dryer venturi/cyclonic scrubber. Emissions from the screens and mills are evacuated through the screens and mills venturi/cyclonic scrubber. The gas streams exiting the dryer venturi scrubber and the mills and screens venturi scrubber are combined and vented through a cross-flow pond water scrubber. The gas stream is then evacuated through "Stack B". The cooler and associated equipment are vented through the cooler venturi/cyclonic scrubber, which then discharges through "Stack B". Refer to Figure 2-3 for the process flow diagram.

There are no physical modifications to the South AP Plant or its associated pollution control equipment proposed by this project.

The current maximum allowable F emission rates for the South AP Plant are 0.06 lb/ton  $P_2O_5$ , 2.76 lb/hr, and 8.33 TPY. The current maximum allowable PM/ $PM_{10}$  emission rates are 0.256 lb/ton  $P_2O_5$ , 11.8 lb/hr and 35.5 TPY. The allowable emissions apply to the combined emissions from Stacks A and B.

A summary of the current allowable emission rates for the South AP Plant is presented in Table 2-1. This table also presents the proposed allowable emission rates for PM/ $PM_{10}$  and F. Proposed maximum allowable F emission rates for the South AP Plant are 0.06 lb/ton  $P_2O_5$ , 2.76 lb/hr, and 12.1 TPY. Proposed maximum allowable PM/ $PM_{10}$  emission rates are 0.25 lb/ton  $P_2O_5$ , 11.5 lb/hr and 50.4 TPY. The allowable emissions apply to the combined emissions from Stacks A and B. The basis for these proposed emissions rates based on application of best available control technology (BACT) is presented in Section 5.0.

Maximum future emissions due to fuel combustion in the dryer are presented in Table 2-2. These emissions are based on 60 MMBtu/hr heat input and burning natural gas, No. 2 fuel oil, or LPG. The maximum sulfur content of the No. 2 fuel oil is limited to 0.05 percent. The current Title V permit limits usage of No. 2 fuel oil to 148,000 gallons per year. Mosaic requests that the South AP Plant be permitted to continuously (8,760 hours per year) fire No. 2 fuel oil.

The past actual emissions for the South AP Plant for calendar years 2003 and 2004 and the average actual emissions for this 2-year period are presented in Table 2-3.

## **2.2 NORTH MAP/DAP FERTILIZER PLANT**

### **2.2.1 GENERAL**

The existing North DAP/MAP Fertilizer Plant has a maximum permitted production rate of 200 TPH of MAP, corresponding to 106.1 TPH  $P_2O_5$  input, and 150 TPH of DAP, corresponding to 70.4 TPH  $P_2O_5$  input. The North MAP/DAP Fertilizer Plant currently consists of a reactor, granulator, dryer, screens and mills, cooler, and associated equipment.

Mosaic is proposing to modify the North MAP/DAP Fertilizer Plant to improve product quality of the MAP/DAP by adding the capability to add phosphoric acid in the granulator. Currently, phosphoric acid is only added in the reactor. This change will be similar to the change made to the South AP Plant in 2003. No other physical changes to the plant will be made as part of this project. The modified plant will be renamed the North AP Plant.

### **2.2.2 PROCESS DESCRIPTION**

In the existing manufacturing process, phosphoric acid and anhydrous ammonia are combined in a reactor. The material is then introduced into the rotary granulator. Ammonia can be further added to the ammoniated acid in the granulator, depending on the grade of ammoniated phosphate being manufactured. The granulated, unsized ammoniated phosphate is then dried in a rotary dryer. The dryer is fired at a maximum heat input rate of 50 MMBtu/hr, using natural gas as the primary fuel and No. 2 fuel oil as the backup fuel.

The dried ammoniated phosphate is then sized and screened, and the oversized and undersized material is recycled back to the granulator. The product is then passed to a product cooler, which uses chilled air from the vaporization of incoming liquid ammonia. Material is screened and sent to storage in the Storage/Shipping Buildings. A flow diagram of the existing North MAP/DAP Fertilizer Plant is presented in Figure 2-4.

The proposed project includes installation of a pipe allowing phosphoric acid to be fed to the granulator. Currently, phosphoric acid can only be added to the reactor. The purpose of this change is to improve product quality, and allow more flexibility in producing MAP/DAP products. The plant will be renamed the North Ammoniated Phosphates (AP) Plant.

Mosaic is not requesting a change in the permitted production rates for the North AP Plant from the current 106.1 TPH  $P_2O_5$  when producing MAP and 70.4 TPH  $P_2O_5$  when producing DAP. No other changes to the plant will be made as part of this project.

### 2.2.3 POLLUTION CONTROL EQUIPMENT AND AIR EMISSIONS

The North DAP/MAP Fertilizer Plant currently utilizes seven scrubbers to control emissions. Evacuated gases from the reactor and granulator are vented to the reactor/granulator (R/G) venturi/cyclonic scrubbing system and then vented through an ammonia vaporizer. The ammonia vaporizer acts as a scrubber/condenser, since it condenses water present in the gas stream, and this water scrubs out F emissions. The gas stream is then vented through the R/G stack.

Emissions from the dryer are evacuated through the dryer venturi scrubber. Emissions from the screens/mills are evacuated through the screens/mills venturi scrubber. The cooler gases are vented through the cooler venturi/cyclonic scrubber. The gas streams exiting the dryer venturi scrubber, the screens/mills venturi scrubber, and the cooler venturi scrubber are vented through a single cross-flow pond water scrubber. The gas stream is then evacuated through the Main stack. The process flow diagram is presented in Figure 2-4.

As part of this project, Mosaic will be upgrading the RG venturi/cyclonic scrubber by replacing the variable throat venturi with a fixed throat venturi. Due to operational restrictions imposed by the maximum achievable control technology (MACT) regulations for phosphate fertilizer production, contained in Subpart BB of Title 40 of the Code of Federal Regulations (40 CFR), and the current Title V permit, including the range of allowable pressure drop across the scrubber, it cannot be operated as a variable throat unit. Given this fact, and the fact that components of the variable throat design induce scaling potential which increases maintenance costs, the upgrade is desirable.

The current maximum allowable emission rates are presented in Table 2-1. The current maximum allowable F emission rates for the North DAP/MAP Fertilizer Plant are 0.06 lb/ton  $P_2O_5$ , 6.4 lb/hr, and 27.9 TPY when producing MAP, and 0.0417 lb/ton  $P_2O_5$ , 2.9 lb/hr, and 12.7 TPY when producing DAP. The current maximum allowable PM/ $PM_{10}$  emission rates are 31.8 lb/hr and 139.3 TPY, equivalent to 0.3 lb/ton  $P_2O_5$  when producing MAP, and 21.1 lb/hr and 92.5 TPY, equivalent to 0.3 lb/ton  $P_2O_5$ , when producing DAP. The allowable emissions apply to the combined emissions from the RG and the Main stacks.



A summary of the proposed allowable PM/PM<sub>10</sub> and F emission rates for the North AP Plant is presented in Table 2-1. The proposed maximum allowable F emission rates are 0.045 lb/ton P<sub>2</sub>O<sub>5</sub>, 4.77 lb/hr, and 20.9 TPY when producing MAP, and 0.0417 lb/ton P<sub>2</sub>O<sub>5</sub>, 2.9 lb/hr, and 12.9 TPY when producing DAP. Proposed maximum allowable PM/PM<sub>10</sub> emission rates are 30.8 lb/hr and 134.8 TPY, equivalent to 0.29 lb/ton P<sub>2</sub>O<sub>5</sub> when producing MAP, and 20.4 lb/hr and 89.4 TPY, equivalent to 0.29 lb/ton P<sub>2</sub>O<sub>5</sub>, when producing DAP. The allowable emissions apply to the combined emissions from the RG and the Main stacks. The basis for these proposed emissions rates based on application of BACT is presented in Section 5.0.

Maximum future emissions due to fuel combustion in the dryer are presented in Table 2-4. These emissions are based on 50 MMBtu/hr heat input and burning natural gas or No. 2 fuel oil. The maximum sulfur content of the No. 2 fuel oil will be limited to 0.05 percent.

The past actual emissions for the North AP Plant for calendar years 2003 and 2004 and the average actual emissions for this 2-year period are presented in Table 2-3 (also refer to Appendix A).

### **2.3 AFFECTS ON OTHER EMISSIONS UNITS**

Due to the proposed modifications to the South AP Plant and the North AP Plant, other emissions units at the Green Bay plant may be potentially affected (i.e., increased production rates or actual emission rates). The following section describes the other emissions unit at Mosaic Green Bay and the potential affect of the proposed modifications.

#### **2.3.1 MAP/DAP STORAGE AND SHIPPING BUILDINGS**

The MAP/DAP Storage and Shipping Buildings are used to store and ship the granulated fertilizer products (MAP and DAP). Process operations in the shipping building include product screening, product transfer by conveyor belts, a product shipping bin, and truck and railcar loading. The increase in production rates at the South AP Plant may result in an increase in operation at the MAP/DAP Storage and Shipping Buildings. Mosaic is not requesting a change in the current permitted loading rates for the Storage Building of 390 TPH and 3,416,400 TPY of fertilizer established in Air Construction Permit No. 1050053-036-AC. This permit additionally allowed the use of dedusting agents, in lieu of the existing scrubber, to control PM/PM<sub>10</sub> emissions. This scrubber was taken out of service in December 2004. There are currently no PM/PM<sub>10</sub> emission limits for the Storage and Shipping Buildings, only a work practice standard requiring use of a dedusting agent.

Past actual emissions (2003 through 2004) are presented in Table 2-3. Maximum future fugitive PM/PM<sub>10</sub> emissions from the Storage and Shipping Buildings were estimated to be 1.6 lb/hr and 7 TPY (Application for Permit No. 10050053-036-AC).

### **2.3.2 NOS. 4, 5, AND 6 SULFURIC ACID PLANTS**

The Nos. 4, 5, and 6 Sulfuric Acid Plants will not be modified as part of this project. Although sulfuric acid is used in the phosphoric acid production process, there will not be an increase in the amount of sulfuric acid produced at Green Bay due to this project. Green Bay is currently a net exporter of sulfuric acid. For example, in 2004 the facility exported 244,277 tons of sulfuric acid. In 2003, the facility exported 213,868 tons. Furthermore, Mosaic acquired a sulfuric acid plant in Mulberry, Florida, that can supply supplemental sulfuric acid to all of the Mosaic facilities or ship to a third party. Lastly, the Green Bay facility can also purchase sulfuric acid from third parties. Therefore, even if the actual amount of phosphoric acid production increases as part of this project, the actual amount of sulfuric acid produced will not increase. Decreasing exports and/or increasing import of sulfuric acid will offset any additional amount of sulfuric acid needed.

### **2.3.3 PHOSPHORIC ACID PLANTS**

The Phosphoric Acid Plant (PAP) No. 1 – North, No. 1 – South, and No. 2, and the Phosphoric Acid Storage Tanks and Blend Tanks will not be modified as part of this project. However, additional phosphoric acid, beyond that actually produced in 2003 and 2004, will be required to attain the production capacity requested in this application for the South and North AP Plants. As a result, actual emissions from the sources may increase. Current actual F emissions (2003 through 2004) for the phosphoric acid plants and tanks are presented in Table 2-3. Current permitted F emissions from the PAP No. 1 – North and PAP No. 1 - South are 2.41 and 3.94 TPY, respectively. Permitted F emissions from PAP No. 2 are 4.82 TPY. Permitted F emissions from the Phosphoric Acid Storage and Blend Tanks total 0.62 TPY.

## **2.4 STACK DATA**

Stack and operating data for the current and future proposed project sources only are presented in Table 2-5.

Table 2-1. Summary of Existing and Proposed Allowable Emission Rates for the AP Plants, Mosaic Green Bay

Source	EU ID	Operating Hours	Maximum Process Rate (TPH P <sub>2</sub> O <sub>5</sub> )	Fluoride Emission Rate			PM/PM <sub>10</sub> Emission Rate		
				Equivalent lb/ton P <sub>2</sub> O <sub>5</sub>	lb/hr	TPY	Equivalent lb/ton P <sub>2</sub> O <sub>5</sub>	lb/hr	TPY
<u>Existing Allowable Rates</u>									
South AP Fertilizer Plant <sup>a</sup>	007	6,036	46.0	0.06	2.76	8.3	0.256	11.8	35.5
North AP Fertilizer Plant <sup>b</sup> - MAP	029	8,760	106.1	0.06	6.4	27.9	0.30	31.8	139.4
	- DAP 029	8,760	70.4	0.0417	2.94	12.9	0.30	21.1	92.5
<u>Proposed Allowable Rates</u>									
South AP Fertilizer Plant <sup>a</sup>	007	8,760	46.0	0.06	2.76	12.1	0.25	11.5	50.4
North AP Fertilizer Plant <sup>b</sup> - MAP	029	8,760	106.1	0.045	4.77	20.9	0.29	30.8	134.8
	- DAP 029	8,760	70.4	0.0417	2.94	12.9	0.29	20.4	89.4

Notes: DAP = Diammonium Phosphate; MAP = Monoammonium Phosphate

PM/PM<sub>10</sub> = Particulate Matter/Particulate Matter with aerodynamic diameter less than or equal to 10 micrometers

<sup>a</sup> Total of Reactor / Granulator - Stack A and Dryer, Screen & Mills, Cooler - Stack B

<sup>b</sup> Total of Dryer, Screens & Mills, Cooler - Main Stack and Reactor / Granulator - R/G Stack

Table 2-2. Maximum Emission Rates Due to Fuel Combustion for the Dryer at the South AP Plant, Mosaic Green Bay

Parameter	Units	No. 2 Fuel Oil	Natural Gas	LPG
<b>Operating Data</b>				
Annual Operating Hours	hr/yr	8760	8,760	8,760
Maximum Heat Input Rate	10 <sup>6</sup> Btu/hr	60	60	60
Hourly Fuel Oil Usage <sup>a</sup>	10 <sup>3</sup> gal/hr	0.44	N/A	N/A
Annual Fuel Oil Usage	10 <sup>3</sup> gal/yr	3,893	N/A	N/A
Maximum Sulfur Content	Weight %	0.05	N/A	N/A
Hourly Natural Gas Usage <sup>b</sup>	10 <sup>6</sup> scf/hr	N/A	0.060	N/A
Annual Natural Gas Usage	10 <sup>6</sup> scf/yr	N/A	525.6	N/A
Maximum Sulfur Content	gr/100 ft <sup>3</sup>	N/A	N/A	15
Hourly LPG Usage <sup>f</sup>	10 <sup>3</sup> gal/hr	N/A	N/A	0.663
Annual LPG Usage	10 <sup>3</sup> gal/yr	N/A	N/A	5,808

Pollutant	AP-42 Emissions Factor <sup>c</sup>	No. 2 Fuel Oil		Natural gas		LPG		Maximum Emission Rate	
		Hourly Emission Rate (lb/hr)	Annual Emission Rate (TPY)	Hourly Emission Rate (lb/hr)	Annual Emission Rate (TPY)	Hourly Emission Rate (lb/hr)	Annual Emission Rate (TPY)	Hourly Emission Rate (lb/hr)	Annual Emission Rate (TPY)
<b>Sulfur Dioxide</b>									
Fuel oil	142 *(S) lb/10 <sup>3</sup> gal <sup>d</sup>	3.16	13.82	--	--	--	--	--	--
Natural gas	0.6 lb/10 <sup>6</sup> ft <sup>3</sup>	--	--	0.04	0.16	--	--	--	--
LPG	0.1 *(S) lb/10 <sup>3</sup> gal <sup>e</sup>	--	--	--	--	0.994	4.36	--	--
Worse-Case Combination of Fuels		--	--	--	--	--	--	3.16	13.82
<b>Sulfuric Acid Mist</b>									
Fuel oil	2.4 *(S) lb/10 <sup>3</sup> gal <sup>h</sup>	0.05	0.23	--	--	--	--	0.053	0.234
<b>Nitrogen Oxides</b>									
Fuel oil	20 lb/10 <sup>3</sup> gal	8.89	38.93	--	--	--	--	--	--
Natural gas	100 lb/10 <sup>6</sup> ft <sup>3</sup>	--	--	6.00	26.28	--	--	--	--
LPG	19 lb/10 <sup>3</sup> gal	--	--	--	--	12.60	55.17	--	--
Worse-Case Combination of Fuels		--	--	--	--	--	--	12.60	55.17
<b>Carbon Monoxide</b>									
Fuel oil	5 lb/10 <sup>3</sup> gal	2.22	9.73	--	--	--	--	--	--
Natural gas	84 lb/10 <sup>6</sup> ft <sup>3</sup>	--	--	5.04	22.08	--	--	--	--
LPG	3.2 lb/10 <sup>3</sup> gal	--	--	--	--	2.12	9.29	--	--
Worse-Case Combination of Fuels		--	--	--	--	--	--	5.04	22.08
<b>Volatile Organic Compounds</b>									
Fuel oil	0.2 lb/10 <sup>3</sup> gal	0.09	0.39	--	--	--	--	--	--
Natural gas	5.5 lb/10 <sup>6</sup> ft <sup>3</sup> <sup>i</sup>	--	--	0.33	1.45	--	--	--	--
LPG	0.2 lb/10 <sup>3</sup> gal	--	--	--	--	0.133	0.58	--	--
Worse-Case Combination of Fuels		--	--	--	--	--	--	0.33	1.45

## Footnotes:

Particulate matter emissions rates through the common plant stack are included in Table 2-1.

<sup>a</sup> Based on the heat content of fuel oil of 135,000 Btu/gallon.<sup>b</sup> Based on the heat content of natural gas of 1,000 Btu/scf.<sup>c</sup> Emission factors for fuel oil are based on AP-42, Section 1.3, September 1998. Emission factors for natural gas are based on AP-42, Section 1.4, July 1998.<sup>d</sup> S denotes the weight-percent of Sulfur in fuel oil; Maximum sulfur content = 0.05%.<sup>e</sup> Sulfuric acid mist emission factor based on emission factor for SO<sub>3</sub> (AP-42, Section 1.3) converted to H<sub>2</sub>SO<sub>4</sub> using molecular weight.<sup>f</sup> Based on methane comprised 52% of total VOC.<sup>g</sup> Based on the heat content of propane of 90,500 Btu/gallon.<sup>h</sup> S denotes the amount of sulfur in propane; maximum sulfur content = 15 grains/100 ft<sup>3</sup>.

Table 2-3. Actual Annual (2003-2004) Emissions for Sources Affected by the Proposed Project, Mosaic Green Bay

Source Description	EU ID	Pollutant Emission Rate <sup>a</sup> (TPY)								
		SO <sub>2</sub>	NO <sub>x</sub>	CO	PM	PM <sub>10</sub>	VOC	TRS	SAM	Fluoride
<b>2003 Actual Emissions</b>										
Phosphoric Acid Plant No. 1-North Train	016	--	--	--	--	--	--	--	--	0.21
Phosphoric Acid Plant No. 1-South Train	017	--	--	--	--	--	--	--	--	0.16
Phosphoric Acid Plant No. 2	013	--	--	--	--	--	--	--	--	0.11
Phosphoric Acid Storage Tanks-2 (PAP 1, R-R)	014	--	--	--	--	--	--	--	--	0.01
Phosphoric Acid Storage Tanks-2 (PAP 2, N-N)	015	--	--	--	--	--	--	--	--	0.05
Phosphoric Acid Blend Tanks-4	037	--	--	--	--	--	--	--	--	0.0004
South DAP Fertilizer Plant	007	0.01	1.28	1.08	9.37	9.37	0.07	--	--	2.37
North MAP/DAP Fertilizer Plant	029	0.03	5.01	4.21	18.86	18.86	0.28	--	--	3.73
MAP/DAP Shipping & Storage Buildings	020	--	--	--	17.60	17.60	--	--	--	0.44
<b>2004 Actual Emissions</b>										
Phosphoric Acid Plant No. 1-North Train	016	--	--	--	--	--	--	--	--	1.15
Phosphoric Acid Plant No. 1-South Train	017	--	--	--	--	--	--	--	--	0.49
Phosphoric Acid Plant No. 2	013	--	--	--	--	--	--	--	--	0.30
Phosphoric Acid Storage Tanks-2 (PAP 1, R-R)	014	--	--	--	--	--	--	--	--	0.11
Phosphoric Acid Storage Tanks-2 (PAP 2, N-N)	015	--	--	--	--	--	--	--	--	0.05
Phosphoric Acid Blend Tanks-4	037	--	--	--	--	--	--	--	--	0.0004
South DAP Fertilizer Plant	007	0.03	4.79	4.02	27.85	27.85	0.26	--	--	3.13
North MAP/DAP Fertilizer Plant	029	0.02	3.19	2.68	29.14	29.14	0.18	--	--	5.24
MAP/DAP Shipping & Storage Buildings	020	--	--	--	4.98	4.98	--	--	--	0.03
<b>Average 2004 &amp; 2003 Actual Emissions</b>										
Phosphoric Acid Plant No. 1-North Train	016	--	--	--	--	--	--	--	--	0.68
Phosphoric Acid Plant No. 1-South Train	017	--	--	--	--	--	--	--	--	0.32
Phosphoric Acid Plant No. 2	013	--	--	--	--	--	--	--	--	0.20
Phosphoric Acid Storage Tanks-2 (PAP 1, R-R)	014	--	--	--	--	--	--	--	--	0.06
Phosphoric Acid Storage Tanks-2 (PAP 2, N-N)	015	--	--	--	--	--	--	--	--	0.05
Phosphoric Acid Blend Tanks-4	037	--	--	--	--	--	--	--	--	0.0004
South DAP Fertilizer Plant	007	0.02	3.03	2.55	18.61	18.61	0.17	--	--	2.75
North MAP/DAP Fertilizer Plant	029	0.02	4.10	3.45	24.00	24.00	0.23	--	--	4.49
MAP/DAP Shipping & Storage Buildings	020	--	--	--	11.29	11.29	--	--	--	0.24

<sup>a</sup> From the 2004 and 2003 Annual Operating Reports, Farmland Industries and Mosaic Fertilizer, Inc.

Table 2-4. Maximum Emission Rates Due to Fuel Combustion for the Dryer at the North AP Plant, Mosaic Green Bay

Parameter	Units	No. 2 Fuel Oil		Natural Gas		Maximum Emission Rate	
		Hourly Emission Rate (lb/hr)	Annual Emission Rate (TPY)	Hourly Emission Rate (lb/hr)	Annual Emission Rate (TPY)	Hourly Emission Rate (lb/hr)	Annual Emission Rate (TPY)
<u>Operating Data</u>							
Annual Operating Hours	hr/yr	8,760	8,760				
Maximum Heat Input Rate	10 <sup>6</sup> Btu/hr	50	50				
Hourly Fuel Oil Usage <sup>a</sup>	10 <sup>3</sup> gal/hr	0.370	N/A				
Annual Fuel Oil Usage	10 <sup>3</sup> gal/yr	3,244	N/A				
Maximum Sulfur Content	Weight %	0.05	N/A				
Hourly Natural Gas Usage <sup>b</sup>	10 <sup>6</sup> scf/hr	N/A	0.050				
Annual Natural Gas Usage	10 <sup>6</sup> scf/yr	N/A	438				
Hourly LPG Usage	10 <sup>3</sup> gal/hr	N/A	N/A				
Annual LPG Usage	10 <sup>3</sup> gal/yr	N/A	N/A				
Pollutant	AP-42 Emissions Factor <sup>c</sup>	No. 2 Fuel Oil		Natural gas		Maximum Emission Rate	
		Hourly Emission Rate (lb/hr)	Annual Emission Rate (TPY)	Hourly Emission Rate (lb/hr)	Annual Emission Rate (TPY)	Hourly Emission Rate (lb/hr)	Annual Emission Rate (TPY)
<u>Sulfur Dioxide</u>							
Fuel oil	142 *(S) lb/10 <sup>3</sup> gal <sup>d</sup>	2.630	11.52	--	--	--	--
Natural gas	0.6 lb/10 <sup>6</sup> ft <sup>3</sup>	--	--	0.030	0.131	--	--
Worse-Case Combination of Fuels		--	--	--	--	2.63	11.52
<u>Sulfuric Acid Mist</u>							
Fuel oil	2.4 *(S) lb/10 <sup>3</sup> gal <sup>d,e</sup>	0.044	0.195	--	--	0.044	0.195
<u>Nitrogen Oxides</u>							
Fuel oil	20 lb/10 <sup>3</sup> gal	7.407	32.44	--	--	--	--
Natural gas	100 lb/10 <sup>6</sup> ft <sup>3</sup>	--	--	5.000	21.900	--	--
Worse-Case Combination of Fuels		--	--	--	--	7.41	32.44
<u>Carbon Monoxide</u>							
Fuel oil	5 lb/10 <sup>3</sup> gal	1.852	8.11	--	--	--	--
Natural gas	84 lb/10 <sup>6</sup> ft <sup>3</sup>	--	--	4.200	18.396	--	--
Worse-Case Combination of Fuels		--	--	--	--	4.20	18.40
<u>Volatile Organic Compounds</u>							
Fuel oil	0.2 lb/10 <sup>3</sup> gal	0.074	0.324	--	--	--	--
Natural gas	5.5 lb/10 <sup>6</sup> ft <sup>3</sup> <sup>f</sup>	--	--	0.275	1.205	--	--
Worse-Case Combination of Fuels		--	--	--	--	0.28	1.20

## Footnotes:

Particulate matter emissions rates through the common plant stack are included in Table 2-1.

<sup>a</sup> Based on the heat content of fuel oil of 135,000 Btu/gallon.

<sup>b</sup> Based on the heat content of natural gas of 1,000 Btu/scf.

<sup>c</sup> Emission factors for fuel oil are based on AP-42, Section 1.3, September 1998. Emission factors for natural gas are based on AP-42, Section 1.4, July 1998.

<sup>d</sup> S denotes the weight-percent of Sulfur in fuel oil; Maximum sulfur content = 0.5%.

<sup>e</sup> Sulfuric acid mist emission factor based on emission factor for SO<sub>2</sub> (AP-42, Section 1.3) converted to H<sub>2</sub>SO<sub>4</sub> using molecular weight.

<sup>f</sup> Based on methane comprised of 52% total VOC.

Table 2-5. Stack and Operating Data for the Proposed Project Sources Only--Mosaic Green Bay

Source	EU ID	Location <sup>a</sup>				Stack/Vent		Stack/Vent		Exhaust Flow Rate (acfm)	Exhaust Gas Exit Temperature		Exhaust Gas Velocity	
		X		Y		Release Height		Diameter			°F	K	ft/s	m/s
		ft	m	ft	m	ft	m	ft	m					
<b>Current Operations</b>														
Phosphoric Acid Plant No. 1--North	016	397.1	121.0	645.8	196.9	100.5	30.6	3.5	1.07	26,400	110	316	45.7	13.94
Phosphoric Acid Plant No. 1--South	017	405.9	123.7	446.9	136.2	100.5	30.6	3.5	1.07	21,200	108	315	36.7	11.19
Phosphoric Acid Plant No. 2	013	244.9	74.7	848.4	258.6	110.0	33.5	3.0	0.91	21,300	114	319	50.2	15.31
Phosphoric Acid Tanks (2, R-R)	014	443.1	135.1	400.8	122.2	59.3	18.1	0.8	0.25	113	94	308	3.5	1.05
Phosphoric Acid Tanks (2, N-N)	015	457.1	139.3	966.9	294.7	62.8	19.1	1.3	0.41	109	91	306	1.3	0.40
Phosphoric Acid Blend Tanks	037	707.3	215.6	538.1	164.0	22.5	6.9	0.5	0.15	94	77	298	8.0	2.43
South DAP Plant--Stack A	007	417.1	127.1	8.1	2.5	130.0	39.62	5.0	1.52	19,900	151	339	16.89	5.15
South DAP Plant--Stack B	007	522.8	159.3	10.9	3.3	129.5	39.47	7.5	2.29	130,900	108	315	49.38	15.05
North MAP/DAP Plant--Main Stack	029	522.4	159.2	127.8	39.0	129.5	39.47	7.5	2.29	168,400	105	313	63.53	19.36
North MAP/DAP Plant--RG Stack	029	433.1	132.0	130.6	39.8	117.0	35.66	5.5	1.68	51,600	204	368	36.20	11.03
MAP/DAP Shipping & Storage Buildings	020	313.0	95.4	199.0	60.67	131.5	40.08	8.0	2.44	137,100	92	306	45.46	13.86
<b>Future Operations</b>														
Phosphoric Acid Plant No. 1--North	016	397.1	121.0	645.8	196.9	100.5	30.6	3.5	1.07	26,400	110	316	45.7	13.94
Phosphoric Acid Plant No. 1--South	017	405.9	123.7	446.9	136.2	100.5	30.6	3.5	1.07	21,200	108	315	36.7	11.19
Phosphoric Acid Plant No. 2	013	244.9	74.7	848.4	258.6	110.0	33.5	3.0	0.91	21,300	114	319	50.2	15.31
Phosphoric Acid Tanks (2, R-R)	014	443.1	135.1	400.8	122.2	59.3	18.1	0.8	0.25	113	94	308	3.5	1.05
Phosphoric Acid Tanks (2, N-N)	015	457.1	139.3	966.9	294.7	62.8	19.1	1.3	0.41	109	91	306	1.3	0.40
Phosphoric Acid Blend Tanks	037	707.3	215.6	538.1	164.0	22.5	6.9	0.5	0.15	94	77	298	8.0	2.43
South DAP Plant--Stack A <sup>b</sup>	007	417.1	127.1	8.1	2.46	130.0	39.62	5.0	1.52	24,400	151	339	20.71	6.31
South DAP Plant--Stack B <sup>b</sup>	007	522.8	159.3	10.9	3.32	129.5	39.47	7.5	2.29	139,500	108	315	52.63	16.04
North AP Plant--Main Stack <sup>b</sup>	029	522.4	159.2	127.8	38.95	129.5	39.47	7.5	2.29	180,800	105	313	68.21	20.79
North AP Plant--RG Stack <sup>b</sup>	029	433.1	132.0	130.6	39.80	117.0	35.66	5.5	1.68	56,100	204	368	39.35	12.00
<b>Volume Source<sup>c</sup></b>														
MAP/DAP Ship & Storage Buildings--Vol 1	020	93.5	28.50	93.5	28.50	34.0	10.36	$\sigma_y$ -Init		32	9.64			
								ft	m			ft	m	
MAP/DAP Ship & Storage Buildings--Vol 2	020	273.5	83.36	86.5	26.37	34.0	10.36	$\sigma_y$ -Init		32	9.64			
								ft	m			ft	m	
MAP/DAP Ship & Storage Buildings--Vol 3	020	261.0	79.55	214.0	65.23	56.0	17.07	$\sigma_y$ -Init		52	15.88			
								ft	m			ft	m	

<sup>a</sup> Relative to the SW corner of the DAP/MAP Storage Building.

<sup>b</sup> Operating parameters represent the worst-case for either MAP or DAP mode.

<sup>c</sup> Fugitive emissions from shipping and storage buildings are modeled as 3 volume sources.

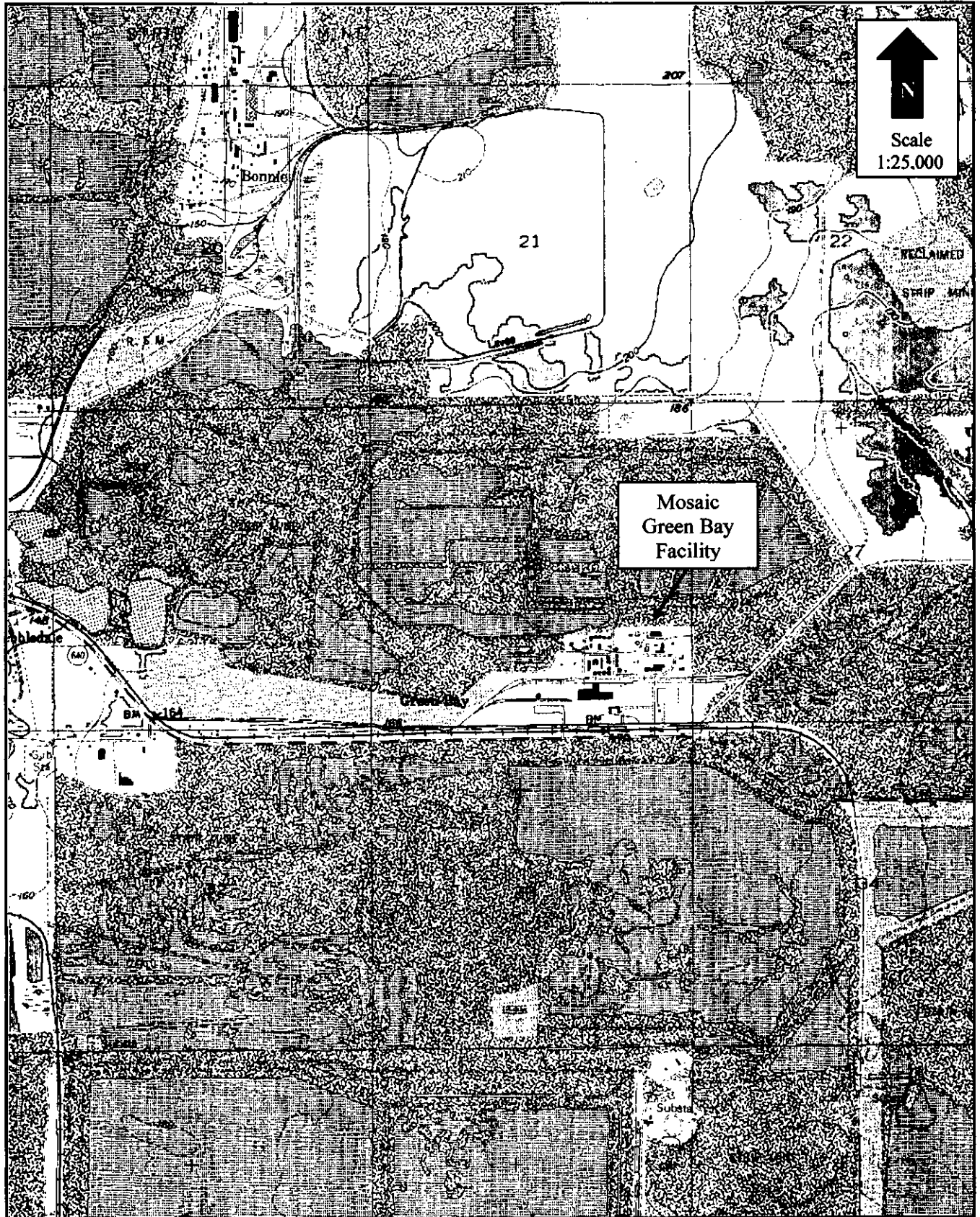

Figure 2-1  
Facility Location Map of Mosaic Green Bay

Source: DeLorme, 1999.





910-9-06

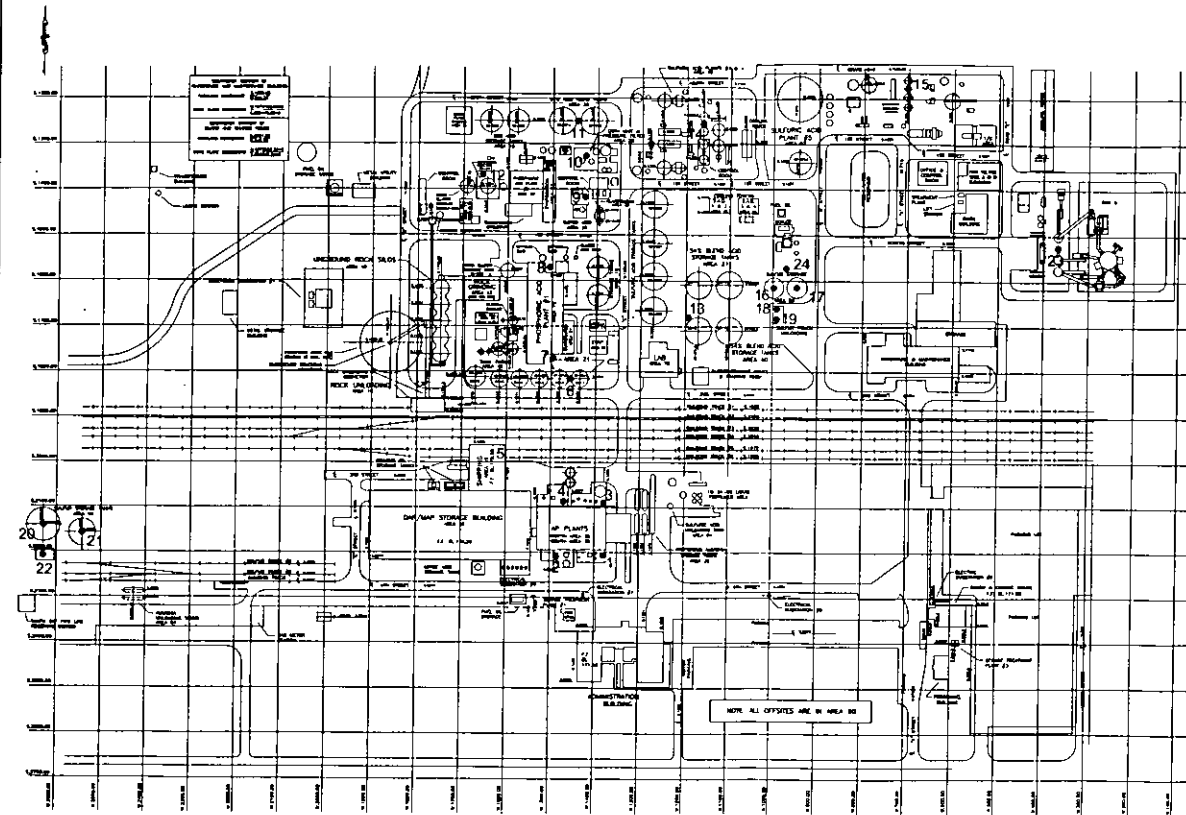

- 1 SOUTH DRY PRODUCTS-DRYER SCRUBBER STACK (STACK B)
- 2 SOUTH DRY PRODUCTS-REACTOR/GRANULATOR SCRUBBER STACK (STACK A)
- 3 NORTH DRY PRODUCTS-DRYER SCRUBBER STACK
- 4 NORTH DRY PRODUCTS-REACTOR/GRANULATOR SCRUBBER STACK
- 5 SHIPPING BUILDING
- 6 PHOSPHORIC ACID STORAGE TANK VENT
- 7 NO 1 PHOSPHORIC ACID PLANT-NORTH SCRUBBER STACK
- 8 NO 1 PHOSPHORIC ACID PLANT-NORTH SCRUBBER STACK
- 9 SUPER PHOSPHORIC ACID PLANT-THERMOPH. HEATER STACK
- 10 GREEN SUPER ACID PLANT-SCRUBBER STACK (NOT IN USE)
- 11 PHOSPHORIC ACID TANK VENT
- 12 NO 2 PHOSPHORIC ACID PLANT-SCRUBBER STACK
- 13 BLEND ACID TANK SCRUBBER
- 14 SULFURIC ACID PLANT NO 1 STACK
- 15 SULFURIC ACID PLANT NO 2 STACK
- 16 WEST SULFUR STORAGE TANK VENT
- 17 EAST SULFUR STORAGE TANK VENT
- 18 SULFUR UNLOADING PIT VENT
- 19 SULFUR UNLOADING PIT VENT
- 20 WEST SULFUR TANK VENT
- 21 EAST SULFUR TANK VENT
- 22 SULFUR PIT VENT
- 23 SULFURIC ACID PLANT NO 2 STACK
- 24 SULFUR PIT VENT

FIGURE 2-2. FACILITY PLOT PLAN

REVISIONS NO. DATE BY 1 10/10/06 JLM 2 11/15/06 JLM 3 12/15/06 JLM 4 01/15/07 JLM 5 02/15/07 JLM 6 03/15/07 JLM 7 04/15/07 JLM 8 05/15/07 JLM 9 06/15/07 JLM 10 07/15/07 JLM 11 08/15/07 JLM 12 09/15/07 JLM 13 10/15/07 JLM 14 11/15/07 JLM 15 12/15/07 JLM 16 01/15/08 JLM 17 02/15/08 JLM 18 03/15/08 JLM 19 04/15/08 JLM 20 05/15/08 JLM 21 06/15/08 JLM 22 07/15/08 JLM 23 08/15/08 JLM 24 09/15/08 JLM 25 10/15/08 JLM 26 11/15/08 JLM 27 12/15/08 JLM 28 01/15/09 JLM 29 02/15/09 JLM 30 03/15/09 JLM 31 04/15/09 JLM 32 05/15/09 JLM 33 06/15/09 JLM 34 07/15/09 JLM 35 08/15/09 JLM 36 09/15/09 JLM 37 10/15/09 JLM 38 11/15/09 JLM 39 12/15/09 JLM 40 01/15/10 JLM 41 02/15/10 JLM 42 03/15/10 JLM 43 04/15/10 JLM 44 05/15/10 JLM 45 06/15/10 JLM 46 07/15/10 JLM 47 08/15/10 JLM 48 09/15/10 JLM 49 10/15/10 JLM 50 11/15/10 JLM 51 12/15/10 JLM 52 01/15/11 JLM 53 02/15/11 JLM 54 03/15/11 JLM 55 04/15/11 JLM 56 05/15/11 JLM 57 06/15/11 JLM 58 07/15/11 JLM 59 08/15/11 JLM 60 09/15/11 JLM 61 10/15/11 JLM 62 11/15/11 JLM 63 12/15/11 JLM 64 01/15/12 JLM 65 02/15/12 JLM 66 03/15/12 JLM 67 04/15/12 JLM 68 05/15/12 JLM 69 06/15/12 JLM 70 07/15/12 JLM 71 08/15/12 JLM 72 09/15/12 JLM 73 10/15/12 JLM 74 11/15/12 JLM 75 12/15/12 JLM 76 01/15/13 JLM 77 02/15/13 JLM 78 03/15/13 JLM 79 04/15/13 JLM 80 05/15/13 JLM 81 06/15/13 JLM 82 07/15/13 JLM 83 08/15/13 JLM 84 09/15/13 JLM 85 10/15/13 JLM 86 11/15/13 JLM 87 12/15/13 JLM 88 01/15/14 JLM 89 02/15/14 JLM 90 03/15/14 JLM 91 04/15/14 JLM 92 05/15/14 JLM 93 06/15/14 JLM 94 07/15/14 JLM 95 08/15/14 JLM 96 09/15/14 JLM 97 10/15/14 JLM 98 11/15/14 JLM 99 12/15/14 JLM 100 01/15/15 JLM 101 02/15/15 JLM 102 03/15/15 JLM 103 04/15/15 JLM 104 05/15/15 JLM 105 06/15/15 JLM 106 07/15/15 JLM 107 08/15/15 JLM 108 09/15/15 JLM 109 10/15/15 JLM 110 11/15/15 JLM 111 12/15/15 JLM 112 01/15/16 JLM 113 02/15/16 JLM 114 03/15/16 JLM 115 04/15/16 JLM 116 05/15/16 JLM 117 06/15/16 JLM 118 07/15/16 JLM 119 08/15/16 JLM 120 09/15/16 JLM 121 10/15/16 JLM 122 11/15/16 JLM 123 12/15/16 JLM 124 01/15/17 JLM 125 02/15/17 JLM 126 03/15/17 JLM 127 04/15/17 JLM 128 05/15/17 JLM 129 06/15/17 JLM 130 07/15/17 JLM 131 08/15/17 JLM 132 09/15/17 JLM 133 10/15/17 JLM 134 11/15/17 JLM 135 12/15/17 JLM 136 01/15/18 JLM 137 02/15/18 JLM 138 03/15/18 JLM 139 04/15/18 JLM 140 05/15/18 JLM 141 06/15/18 JLM 142 07/15/18 JLM 143 08/15/18 JLM 144 09/15/18 JLM 145 10/15/18 JLM 146 11/15/18 JLM 147 12/15/18 JLM 148 01/15/19 JLM 149 02/15/19 JLM 150 03/15/19 JLM 151 04/15/19 JLM 152 05/15/19 JLM 153 06/15/19 JLM 154 07/15/19 JLM 155 08/15/19 JLM 156 09/15/19 JLM 157 10/15/19 JLM 158 11/15/19 JLM 159 12/15/19 JLM 160 01/15/20 JLM 161 02/15/20 JLM 162 03/15/20 JLM 163 04/15/20 JLM 164 05/15/20 JLM 165 06/15/20 JLM 166 07/15/20 JLM 167 08/15/20 JLM 168 09/15/20 JLM 169 10/15/20 JLM 170 11/15/20 JLM 171 12/15/20 JLM 172 01/15/21 JLM 173 02/15/21 JLM 174 03/15/21 JLM 175 04/15/21 JLM 176 05/15/21 JLM 177 06/15/21 JLM 178 07/15/21 JLM 179 08/15/21 JLM 180 09/15/21 JLM 181 10/15/21 JLM 182 11/15/21 JLM 183 12/15/21 JLM 184 01/15/22 JLM 185 02/15/22 JLM 186 03/15/22 JLM 187 04/15/22 JLM 188 05/15/22 JLM 189 06/15/22 JLM 190 07/15/22 JLM 191 08/15/22 JLM 192 09/15/22 JLM 193 10/15/22 JLM 194 11/15/22 JLM 195 12/15/22 JLM 196 01/15/23 JLM 197 02/15/23 JLM 198 03/15/23 JLM 199 04/15/23 JLM 200 05/15/23 JLM 201 06/15/23 JLM 202 07/15/23 JLM 203 08/15/23 JLM 204 09/15/23 JLM 205 10/15/23 JLM 206 11/15/23 JLM 207 12/15/23 JLM 208 01/15/24 JLM 209 02/15/24 JLM 210 03/15/24 JLM 211 04/15/24 JLM 212 05/15/24 JLM 213 06/15/24 JLM 214 07/15/24 JLM 215 08/15/24 JLM 216 09/15/24 JLM 217 10/15/24 JLM 218 11/15/24 JLM 219 12/15/24 JLM 220 01/15/25 JLM 221 02/15/25 JLM 222 03/15/25 JLM 223 04/15/25 JLM 224 05/15/25 JLM 225 06/15/25 JLM 226 07/15/25 JLM 227 08/15/25 JLM 228 09/15/25 JLM 229 10/15/25 JLM 230 11/15/25 JLM 231 12/15/25 JLM 232 01/15/26 JLM 233 02/15/26 JLM 234 03/15/26 JLM 235 04/15/26 JLM 236 05/15/26 JLM 237 06/15/26 JLM 238 07/15/26 JLM 239 08/15/26 JLM 240 09/15/26 JLM 241 10/15/26 JLM 242 11/15/26 JLM 243 12/15/26 JLM 244 01/15/27 JLM 245 02/15/27 JLM 246 03/15/27 JLM 247 04/15/27 JLM 248 05/15/27 JLM 249 06/15/27 JLM 250 07/15/27 JLM 251 08/15/27 JLM 252 09/15/27 JLM 253 10/15/27 JLM 254 11/15/27 JLM 255 12/15/27 JLM 256 01/15/28 JLM 257 02/15/28 JLM 258 03/15/28 JLM 259 04/15/28 JLM 260 05/15/28 JLM 261 06/15/28 JLM 262 07/15/28 JLM 263 08/15/28 JLM 264 09/15/28 JLM 265 10/15/28 JLM 266 11/15/28 JLM 267 12/15/28 JLM 268 01/15/29 JLM 269 02/15/29 JLM 270 03/15/29 JLM 271 04/15/29 JLM 272 05/15/29 JLM 273 06/15/29 JLM 274 07/15/29 JLM 275 08/15/29 JLM 276 09/15/29 JLM 277 10/15/29 JLM 278 11/15/29 JLM 279 12/15/29 JLM 280 01/15/30 JLM 281 02/15/30 JLM 282 03/15/30 JLM 283 04/15/30 JLM 284 05/15/30 JLM 285 06/15/30 JLM 286 07/15/30 JLM 287 08/15/30 JLM 288 09/15/30 JLM 289 10/15/30 JLM 290 11/15/30 JLM 291 12/15/30 JLM 292 01/15/31 JLM 293 02/15/31 JLM 294 03/15/31 JLM 295 04/15/31 JLM 296 05/15/31 JLM 297 06/15/31 JLM 298 07/15/31 JLM 299 08/15/31 JLM 300 09/15/31 JLM 301 10/15/31 JLM 302 11/15/31 JLM 303 12/15/31 JLM 304 01/15/32 JLM 305 02/15/32 JLM 306 03/15/32 JLM 307 04/15/32 JLM 308 05/15/32 JLM 309 06/15/32 JLM 310 07/15/32 JLM 311 08/15/32 JLM 312 09/15/32 JLM 313 10/15/32 JLM 314 11/15/32 JLM 315 12/15/32 JLM 316 01/15/33 JLM 317 02/15/33 JLM 318 03/15/33 JLM 319 04/15/33 JLM 320 05/15/33 JLM 321 06/15/33 JLM 322 07/15/33 JLM 323 08/15/33 JLM 324 09/15/33 JLM 325 10/15/33 JLM 326 11/15/33 JLM 327 12/15/33 JLM 328 01/15/34 JLM 329 02/15/34 JLM 330 03/15/34 JLM 331 04/15/34 JLM 332 05/15/34 JLM 333 06/15/34 JLM 334 07/15/34 JLM 335 08/15/34 JLM 336 09/15/34 JLM 337 10/15/34 JLM 338 11/15/34 JLM 339 12/15/34 JLM 340 01/15/35 JLM 341 02/15/35 JLM 342 03/15/35 JLM 343 04/15/35 JLM 344 05/15/35 JLM 345 06/15/35 JLM 346 07/15/35 JLM 347 08/15/35 JLM 348 09/15/35 JLM 349 10/15/35 JLM 350 11/15/35 JLM 351 12/15/35 JLM 352 01/15/36 JLM 353 02/15/36 JLM 354 03/15/36 JLM 355 04/15/36 JLM 356 05/15/36 JLM 357 06/15/36 JLM 358 07/15/36 JLM 359 08/15/36 JLM 360 09/15/36 JLM 361 10/15/36 JLM 362 11/15/36 JLM 363 12/15/36 JLM 364 01/15/37 JLM 365 02/15/37 JLM 366 03/15/37 JLM 367 04/15/37 JLM 368 05/15/37 JLM 369 06/15/37 JLM 370 07/15/37 JLM 371 08/15/37 JLM 372 09/15/37 JLM 373 10/15/37 JLM 374 11/15/37 JLM 375 12/15/37 JLM 376 01/15/38 JLM 377 02/15/38 JLM 378 03/15/38 JLM 379 04/15/38 JLM 380 05/15/38 JLM 381 06/15/38 JLM 382 07/15/38 JLM 383 08/15/38 JLM 384 09/15/38 JLM 385 10/15/38 JLM 386 11/15/38 JLM 387 12/15/38 JLM 388 01/15/39 JLM 389 02/15/39 JLM 390 03/15/39 JLM 391 04/15/39 JLM 392 05/15/39 JLM 393 06/15/39 JLM 394 07/15/39 JLM 395 08/15/39 JLM 396 09/15/39 JLM 397 10/15/39 JLM 398 11/15/39 JLM 399 12/15/39 JLM 400 01/15/40 JLM 401 02/15/40 JLM 402 03/15/40 JLM 403 04/15/40 JLM 404 05/15/40 JLM 405 06/15/40 JLM 406 07/15/40 JLM 407 08/15/40 JLM 408 09/15/40 JLM 409 10/15/40 JLM 410 11/15/40 JLM 411 12/15/40 JLM 412 01/15/41 JLM 413 02/15/41 JLM 414 03/15/41 JLM 415 04/15/41 JLM 416 05/15/41 JLM 417 06/15/41 JLM 418 07/15/41 JLM 419 08/15/41 JLM 420 09/15/41 JLM 421 10/15/41 JLM 422 11/15/41 JLM 423 12/15/41 JLM 424 01/15/42 JLM 425 02/15/42 JLM 426 03/15/42 JLM 427 04/15/42 JLM 428 05/15/42 JLM 429 06/15/42 JLM 430 07/15/42 JLM 431 08/15/42 JLM 432 09/15/42 JLM 433 10/15/42 JLM 434 11/15/42 JLM 435 12/15/42 JLM 436 01/15/43 JLM 437 02/15/43 JLM 438 03/15/43 JLM 439 04/15/43 JLM 440 05/15/43 JLM 441 06/15/43 JLM 442 07/15/43 JLM 443 08/15/43 JLM 444 09/15/43 JLM 445 10/15/43 JLM 446 11/15/43 JLM 447 12/15/43 JLM 448 01/15/44 JLM 449 02/15/44 JLM 450 03/15/44 JLM 451 04/15/44 JLM 452 05/15/44 JLM 453 06/15/44 JLM 454 07/15/44 JLM 455 08/15/44 JLM 456 09/15/44 JLM 457 10/15/44 JLM 458 11/15/44 JLM 459 12/15/44 JLM 460 01/15/45 JLM 461 02/15/45 JLM 462 03/15/45 JLM 463 04/15/45 JLM 464 05/15/45 JLM 465 06/15/45 JLM 466 07/15/45 JLM 467 08/15/45 JLM 468 09/15/45 JLM 469 10/15/45 JLM 470 11/15/45 JLM 471 12/15/45 JLM 472 01/15/46 JLM 473 02/15/46 JLM 474 03/15/46 JLM 475 04/15/46 JLM 476 05/15/46 JLM 477 06/15/46 JLM 478 07/15/46 JLM 479 08/15/46 JLM 480 09/15/46 JLM 481 10/15/46 JLM 482 11/15/46 JLM 483 12/15/46 JLM 484 01/15/47 JLM 485 02/15/47 JLM 486 03/15/47 JLM 487 04/15/47 JLM 488 05/15/47 JLM 489 06/15/47 JLM 490 07/15/47 JLM 491 08/15/47 JLM 492 09/15/47 JLM 493 10/15/47 JLM 494 11/15/47 JLM 495 12/15/47 JLM 496 01/15/48 JLM 497 02/15/48 JLM 498 03/15/48 JLM 499 04/15/48 JLM 500 05/15/48 JLM 501 06/15/48 JLM 502 07/15/48 JLM 503 08/15/48 JLM 504 09/15/48 JLM 505 10/15/48 JLM 506 11/15/48 JLM 507 12/15/48 JLM 508 01/15/49 JLM 509 02/15/49 JLM 510 03/15/49 JLM 511 04/15/49 JLM 512 05/15/49 JLM 513 06/15/49 JLM 514 07/15/49 JLM 515 08/15/49 JLM 516 09/15/49 JLM 517 10/15/49 JLM 518 11/15/49 JLM 519 12/15/49 JLM 520 01/15/50 JLM 521 02/15/50 JLM 522 03/15/50 JLM 523 04/15/50 JLM 524 05/15/50 JLM 525 06/15/50 JLM 526 07/15/50 JLM 527 08/15/50 JLM 528 09/15/50 JLM 529 10/15/50 JLM 530 11/15/50 JLM 531 12/15/50 JLM 532 01/15/51 JLM 533 02/15/51 JLM 534 03/15/51 JLM 535 04/15/51 JLM 536 05/15/51 JLM 537 06/15/51 JLM 538 07/15/51 JLM 539 08/15/51 JLM 540 09/15/51 JLM 541 10/15/51 JLM 542 11/15/51 JLM 543 12/15/51 JLM 544 01/15/52 JLM 545 02/15/52 JLM 546 03/15/52 JLM 547 04/15/52 JLM 548 05/15/52 JLM 549 06/15/52 JLM 550 07/15/52 JLM 551 08/15/52 JLM 552 09/15/52 JLM 553 10/15/52 JLM 554 11/15/52 JLM 555 12/15/52 JLM 556 01/15/53 JLM 557 02/15/53 JLM 558 03/15/53 JLM 559 04/15/53 JLM 560 05/15/53 JLM 561 06/15/53 JLM 562 07/15/53 JLM 563 08/15/53 JLM 564 09/15/53 JLM 565 10/15/53 JLM 566 11/15/53 JLM 567 12/15/53 JLM 568 01/15/54 JLM 569 02/15/54 JLM 570 03/15/54 JLM 571 04/15/54 JLM 572 05/15/54 JLM 573 06/15/54 JLM 574 07/15/54 JLM 575 08/15/54 JLM 576 09/15/54 JLM 577 10/15/54 JLM 578 11/15/54 JLM 579 12/15/54 JLM 580 01/15/55 JLM 581 02/15/55 JLM 582 03/15/55 JLM 583 04/15/55 JLM 584 05/15/55 JLM 585 06/15/55 JLM 586 07/15/55 JLM 587 08/15/55 JLM 588 09/15/55 JLM 589 10/15/55 JLM 590 11/15/55 JLM 591 12/15/55 JLM 592 01/15/56 JLM 593 02/15/56 JLM 594 03/15/56 JLM 595 04/15/56 JLM 596 05/15/56 JLM 597 06/15/56 JLM 598 07/15/56 JLM 599 08/15/56 JLM 600 09/15/56 JLM 601 10/15/56 JLM 602 11/15/56 JLM 603 12/15/56 JLM 604 01/15/57 JLM 605 02/15/57 JLM 606 03/15/57 JLM 607 04/15/57 JLM 608 05/15/57 JLM 609 06/15/57 JLM 610 07/15/57 JLM 611 08/15/57 JLM 612 09/15/57 JLM 613 10/15/57 JLM 614 11/15/57 JLM 615 12/15/57 JLM 6
---

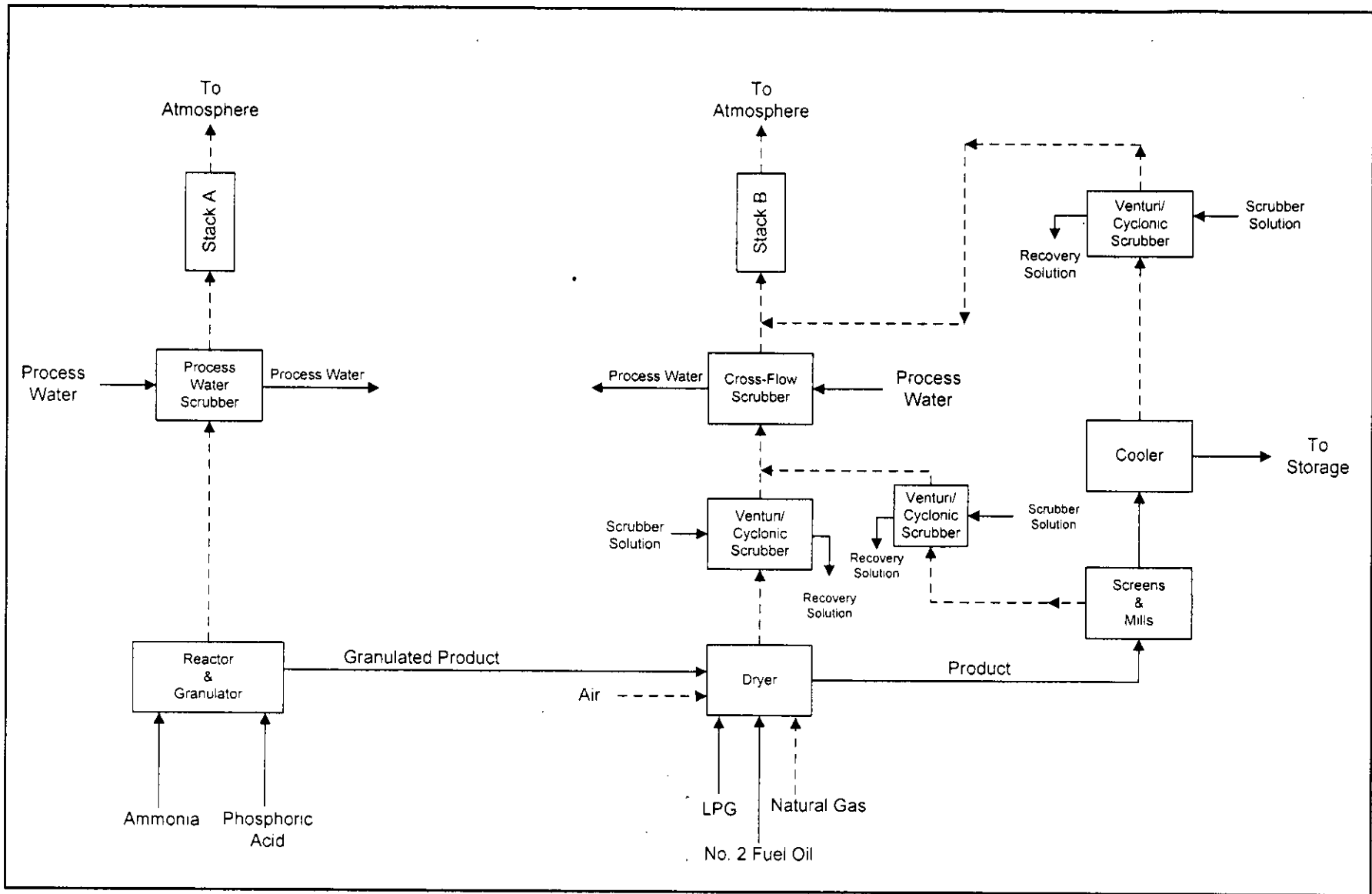

Figure 2-3  
 South AP Fertilizer Plant  
 Process Flow Diagram  
 Mosaic Green Bay

**Process Flow Legend**

Material Flow ———→  
 Air Flow - - - - -→

Filename: 0537573/4.4 PSD/Figure 2-3.vsd

Date: 08/23/05



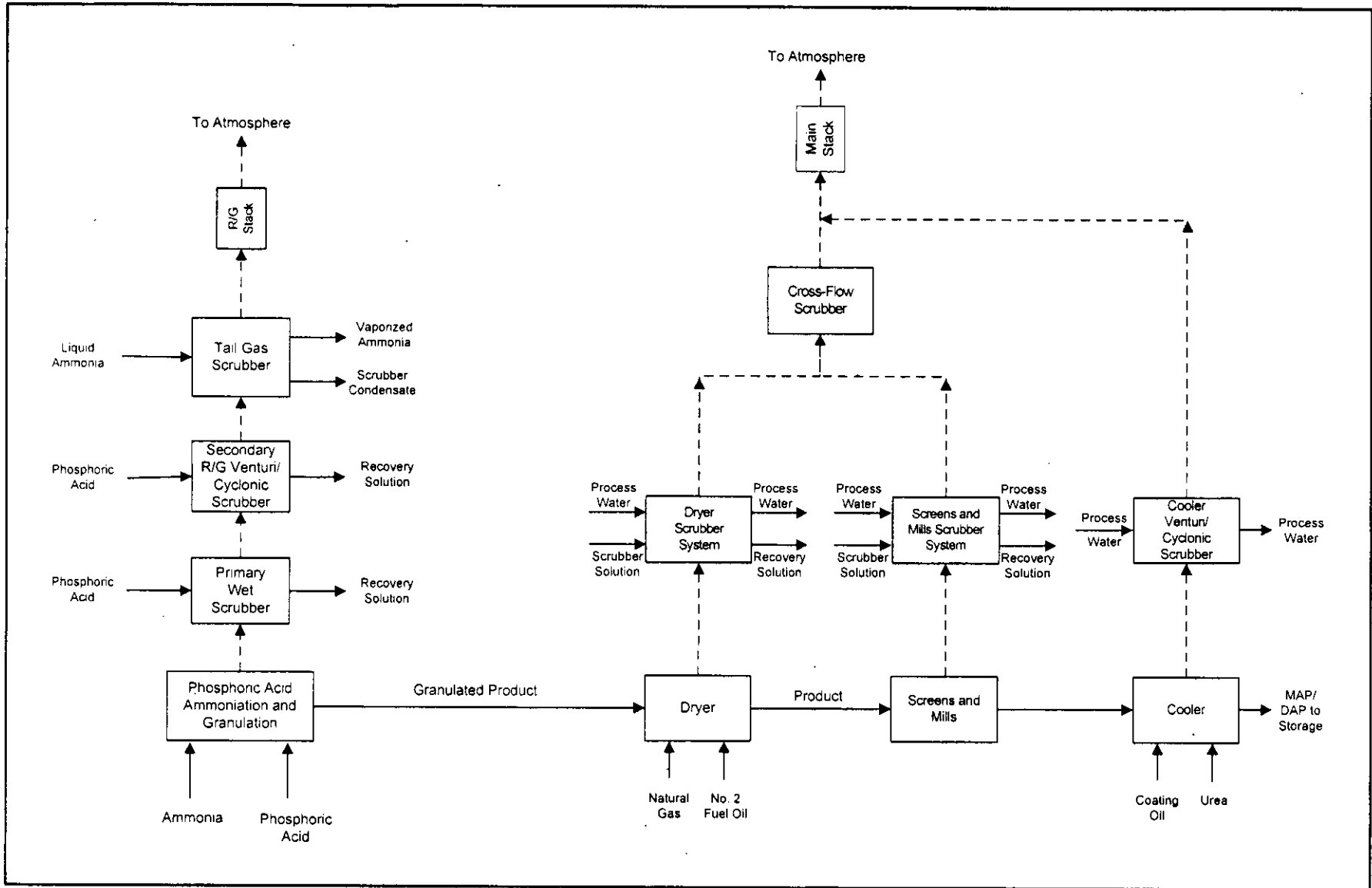

Figure 2-4  
 North AP Fertilizer Plant  
 Process Flow Diagram  
 Mosaic Green Bay

**Process Flow Legend**  
 Material Flow —————>  
 Air Flow - - - - ->

Filename: 0537573/4.4 PSD/Figure 2-4.vsd  
 Date: 08/23/05



### 3.0 AIR QUALITY REVIEW REQUIREMENTS

Federal and state air regulatory requirements for a major new or modified source of air pollution are discussed in Sections 3.1 through 3.4. The applicability of these regulations to the proposed Mosaic Green Bay modification is presented in Section 3.5. These regulations must be satisfied before the proposed project can be approved.

#### 3.1 NATIONAL AND STATE AMBIENT AIR QUALITY STANDARDS (AAQS)

The existing applicable national and Florida ambient air quality standards (AAQS) are presented in Table 3-1. Primary national AAQS were promulgated to protect the public health, and secondary national AAQS were promulgated to protect the public welfare from any known or anticipated adverse effects associated with the presence of pollutants in the ambient air. Areas of the country in violation of AAQS are designated as nonattainment areas, and new or modified sources to be located in or near these areas may be subject to more stringent air permitting requirements.

Florida has adopted state AAQS in Rule 62-204.240, Florida Administrative Code (F.A.C.). These standards are the same as the national AAQS, except in the case of SO<sub>2</sub>. For SO<sub>2</sub>, Florida has adopted the former 24-hour secondary standard of 260 micrograms per cubic meter ( $\mu\text{g}/\text{m}^3$ ) and former annual average secondary standard of 60  $\mu\text{g}/\text{m}^3$ .

#### 3.2 PSD REQUIREMENTS

##### 3.2.1 GENERAL REQUIREMENTS

Under Federal and State of Florida PSD review requirements, all major new or modified sources of air pollutants regulated under the Clean Air Act (CAA) must be reviewed and a pre-construction permit issued. Florida's State Implementation Plan (SIP), which contains PSD regulations, has been approved by the U.S. Environmental Protection Agency (EPA); therefore, PSD approval authority has been granted to the Florida Department of Environmental Protection (FDEP).

A "major facility" is defined as any one of 28 named source categories that have the potential to emit 100 TPY or more of any pollutant regulated under the CAA, or any other stationary facility that has the potential to emit 250 TPY or more of any pollutant regulated under the CAA. "Potential to emit" means the capability, at maximum design capacity, to emit a pollutant after the application of control equipment. Any federally enforceable restriction on production rate, hours of operations, fuel usage, etc., can be taken into account in determining the potential to emit of the source.

Once a new source is determined to be a "major facility" for a particular pollutant, any pollutant emitted in amounts greater than the PSD significant emission rates is subject to PSD review. For an existing source for which a modification is proposed, the modification is subject to PSD review if the net increase in emissions due to the modification is greater than the PSD significant emission rates. The PSD significant emission rates are shown in Table 3-2.

The EPA class designations and allowable PSD increments are presented in Table 3-1. The magnitude of the allowable increment depends on the classification of the area in which a new source (or modification) will be located or have an impact. Three classifications are designated based on criteria established in the 1990 CAA Amendments. Congress promulgated areas as Class I (international parks, national wilderness areas, and memorial parks larger than 5,000 acres and national parks larger than 6,000 acres), or as Class II (all areas not designated as Class I). No Class III areas, which would be allowed greater deterioration than Class II areas, were designated. The State of Florida has adopted the EPA class designations and allowable PSD increments for SO<sub>2</sub>, PM<sub>10</sub>, and NO<sub>2</sub>.

PSD review is used to determine whether significant air quality deterioration will result from the new or modified facility. Federal PSD requirements are contained in 40 CFR 52.21, Prevention of Significant Deterioration of Air Quality. The State of Florida has adopted PSD regulations that are equivalent to the federal PSD regulations (Rule 62-212.400, F.A.C.). Major facilities and major modifications are required to undergo the following analyses related to PSD for each pollutant emitted in significant amounts:

1. Control technology review,
2. Source impact analysis,
3. Air quality analysis (monitoring),
4. Source information, and
5. Additional impact analyses.

In addition to these analyses, a new or modified facility must also be reviewed with respect to Good Engineering Practice (GEP) stack height regulations. Discussions concerning each of these requirements are presented in the following sections.

### 3.2.2 CONTROL TECHNOLOGY REVIEW

The control technology review requirements of the federal and state PSD regulations require that all applicable federal and state emission-limiting standards be met, and that best available control technology (BACT) be applied to control emissions from the source. The BACT requirements are applicable to all regulated pollutants for which the increase in emissions from the new major source or major modification exceeds the significant emission rate (see Table 3-2). BACT is only required for new emissions units or emissions units for which there is a physical change or a change in the method of operation.

BACT is defined in 40 CFR 52.21(b)(12), as:

*An emissions limitation (including a visible emission standard) based on the maximum degree of reduction of each pollutant subject to regulation under the Act which would be emitted by any proposed major stationary source of major modification which the Administrator, on a case-by-case basis, taking into account energy, environmental, and economic impacts, and other costs, determination is achievable through application of production processes and available methods, systems, and techniques (including fuel cleaning or treatment or innovative fuel combustion techniques) for control of such pollutant. In no event shall application of best available control technology result in emissions of any pollutant, which would exceed the emissions allowed by any applicable standard under 40 CFR Parts 60 and 61. If the Administrator determines that technological or economic limitations on the application of measurement methodology to a particular part of a source or facility would make the imposition of an emission standard infeasible, a design, equipment, work practice, operational standard or combination thereof, may be prescribed instead to satisfy the requirement for the application of BACT. Such standard shall, to the degree possible, set forth the emissions reductions achievable by implementation of such design, equipment, work practice, or operation and shall provide for compliance by means, which achieve equivalent results.*

BACT was promulgated within the framework of the PSD requirements in the 1977 amendments of the CAA [Public Law 95-95; Part C, Section 165(a)(4)]. The primary purpose of BACT is to optimize consumption of PSD air quality increments and thereby enlarge the potential for future economic growth without significantly degrading air quality (EPA, 1978; 1980). Guidelines for the evaluation of BACT can be found in EPA's *Guidelines for Determining Best Available Control*

*Technology (BACT)* (EPA, 1978) and in the *PSD Workshop Manual* (EPA, 1980). These guidelines were promulgated by EPA to provide a consistent approach to BACT and to ensure that the impacts of alternative emission control systems are measured by the same set of parameters. In addition, through implementation of these guidelines, BACT in one area may not be identical to BACT in another area. According to EPA (1980), "BACT analyses for the same types of emissions unit and the same pollutants in different locations or situations may determine that different control strategies should be applied to the different sites, depending on site-specific factors. Therefore, BACT analyses must be conducted on a case-by-case basis."

The BACT requirements are intended to ensure that the control systems incorporated in the design of a proposed facility reflect the latest in control technologies used in a particular industry and take into consideration existing and future air quality in the vicinity of the proposed facility. BACT must, as a minimum, demonstrate compliance with New Source Performance Standards (NSPS) for a source (if applicable). An evaluation of the air pollution control techniques and systems, including a cost-benefit analysis of alternative control technologies capable of achieving a higher degree of emission reduction than the proposed control technology, is required. The cost-benefit analysis requires the documentation of the materials, energy, and economic penalties associated with the proposed and alternative control systems, as well as the environmental benefits derived from these systems. A decision on BACT is to be based on sound judgment, balancing environmental benefits with energy, economic, and other impacts (EPA, 1978).

### 3.2.3 SOURCE IMPACT ANALYSIS

A source impact analysis must be performed for a proposed major source or major modification subject to PSD review and for each pollutant for which the increase in emissions exceeds the PSD significant emission rate (Table 3-2). The PSD regulations specifically provide for the use of atmospheric dispersion models in performing impact analyses, estimating baseline and future air quality levels, and determining compliance with AAQS and allowable PSD increments. Designated EPA models normally must be used in performing the impact analysis. Specific applications for other than EPA-approved models require EPA's consultation and prior approval. Guidance for the use and application of dispersion models is presented in the EPA publication *Guideline on Air Quality Models* (EPA, 1980).

To address compliance with AAQS and PSD Class II increments, a source impact analysis must be performed for the criteria pollutants. However, this analysis is not required for a specific pollutant if

the net increase in impacts as a result of the new source or modification is below significant impact levels, as presented in Table 3-1. The significant impact levels are threshold levels that are used to determine the level of air impact analyses needed for the project. If the new or modified source's impacts are predicted to be less than significant, then the source's impacts are assumed not to have a significant adverse affect on air quality and additional modeling with other sources is not required. However, if the source's impacts are predicted to be greater than the significant impact levels, additional modeling with other sources is required to demonstrate compliance with AAQS and PSD increments.

EPA has proposed significant impact levels for Class I areas as follows:

SO <sub>2</sub>	3-hour	1 µg/m <sup>3</sup>
	24-hour	0.2 µg/m <sup>3</sup>
	Annual	0.1 µg/m <sup>3</sup>
PM <sub>10</sub>	24-hour	0.3 µg/m <sup>3</sup>
	Annual	0.2 µg/m <sup>3</sup>
NO <sub>2</sub>	Annual	0.1 µg/m <sup>3</sup>

Although these levels have not been officially promulgated as part of the PSD review process and may not be binding for states in performing PSD review, the proposed levels serve as a guideline in assessing a source's impact in a Class I area. The EPA action to incorporate Class I significant impact levels in the PSD process is part of implementing the NSR provisions of the 1990 CAA Amendments. Because the process of developing the regulations will be lengthy, EPA believes that the proposed rules concerning the significant impact levels is appropriate to assist states in implementing the PSD permit process.

Various lengths of record for meteorological data can be used for impact analysis. A 5-year period is normally used with corresponding evaluation of highest, second-highest short-term concentrations for comparison to AAQS or PSD increments. The meteorological data are selected based on an evaluation of measured weather data from a nearby weather station that represents weather conditions at the project site. The criteria used in this evaluation include determining the distance of the project site to the weather station; comparing topographical and land use features between the locations; and determining availability of necessary weather parameters.



The term "highest, second-highest" (HSH) refers to the highest of the second-highest concentrations at all receptors (i.e., the highest concentration at each receptor is discarded). The second-highest concentration is important because short-term AAQS specify that the standard should not be exceeded at any location more than once a year. If fewer than 5 years of meteorological data are used in the modeling analysis, the highest concentration at each receptor normally must be used for comparison to air quality standards.

The term "baseline concentration" evolves from federal and state PSD regulations and refers to a concentration level corresponding to a specified baseline date and certain additional baseline sources. By definition, in the PSD regulations as amended August 7, 1980, baseline concentration means the ambient concentration level that exists in the baseline area at the time of the applicable baseline date. A baseline concentration is determined for each pollutant for which a baseline date is established and includes:

1. The actual emissions representative of facilities in existence on the applicable baseline date; and
2. The allowable emissions of major stationary facilities that commenced construction before January 6, 1975, for SO<sub>2</sub> and PM<sub>10</sub> concentrations, or February 8, 1988, for NO<sub>2</sub> concentrations, but that were not in operation by the applicable baseline date.

The following emissions are not included in the baseline concentration, and therefore, affect PSD increment consumption:

1. Actual emissions from any major stationary facility on which construction commenced after January 6, 1975, for SO<sub>2</sub> and PM<sub>10</sub> concentrations, and after February 8, 1988, for NO<sub>2</sub> concentrations; and
2. Actual emission increases and decreases at any stationary facility occurring after the baseline date.

In reference to the baseline concentration, the term "baseline date" actually includes three different dates:

1. The major facility baseline date, which is January 6, 1975, in the cases of SO<sub>2</sub> and PM<sub>10</sub>, and February 8, 1988, in the case of NO<sub>2</sub>;
2. The minor facility baseline date, which is the earliest date after the trigger date on which a major stationary facility or major modification subject to PSD regulations submits a complete PSD application; and

3. The trigger date, which is August 7, 1977, for SO<sub>2</sub> and PM<sub>10</sub>, and February 8, 1988, for NO<sub>2</sub>.

### 3.2.4 AIR QUALITY MONITORING REQUIREMENTS

In accordance with requirements of 40 CFR 52.21(m), any application for a PSD permit must contain an analysis of continuous ambient air quality data in the area affected by the proposed major stationary facility or major modification. For a new major facility, the affected pollutants are those that the facility potentially would emit in significant amounts. For a major modification, the pollutants are those for which the net emissions increase exceeds the significant emission rate (see Table 3-2).

Ambient air monitoring for a period of up to 1 year generally is appropriate to satisfy the PSD monitoring requirements. A minimum of 4 months of data is required. Existing data from the vicinity of the proposed source may be used if the data meet certain quality assurance requirements; otherwise, additional data may need to be gathered. Guidance in designing a PSD monitoring network is provided in EPA's *Ambient Monitoring Guidelines for Prevention of Significant Deterioration* (EPA, 1987a).

The regulations include an exemption that excludes or limits the pollutants for which an air quality analysis must be conducted. This exemption states that FDEP may exempt a proposed major stationary facility or major modification from the monitoring requirements, with respect to a particular pollutant, if the emissions increase of the pollutant from the facility or modification would cause, in any area, air quality impacts less than the *de minimis* levels presented in Table 3-2.

### 3.2.5 SOURCE INFORMATION/GEP STACK HEIGHT

Source information must be provided to adequately describe the proposed project. The type of information required for this project is presented in Section 2.0.

The 1977 CAA Amendments require that the degree of emission limitation required for control of any pollutant not be affected by a stack height that exceeds GEP or any other dispersion technique. On July 8, 1985, EPA promulgated final stack height regulations (EPA, 1985a). The FDEP has adopted identical regulations (Rule 62-210.550, F.A.C.). GEP stack height is defined as the highest of:

1. 65 meters (m); or

2. A height established by applying the formula:

$$H_g = H + 1.5L$$

where:  $H_g$  = GEP stack height,

$H$  = Height of the structure or nearby structure, and

$L$  = Lesser dimension (height or projected width) of nearby structure(s); or

3. A height demonstrated by a fluid model or field study.

"Nearby" is defined as a distance up to five times the lesser of the height or width dimensions of a structure or terrain feature, but not greater than 0.8 kilometer (km). Although GEP stack height regulations require that the stack height used in modeling for determining compliance with AAQS and PSD increments not exceed the GEP stack height, the actual stack height may be greater.

The stack height regulations also allow increased GEP stack height beyond that resulting from the above formula in cases where plume impaction occurs. Plume impaction is defined as concentrations measured or predicted to occur when the plume interacts with elevated terrain. Elevated terrain is defined as terrain that exceeds the height calculated by the GEP stack height formula.

### **3.2.6 ADDITIONAL IMPACT ANALYSIS**

In addition to air quality impact analyses, federal and State of Florida regulations require analyses of the impairment to visibility and the impacts on soils and vegetation that would occur as a result of the proposed source [40 CFR 52.21(o) and Rule 62-212.400, F.A.C.]. These analyses are to be conducted primarily for PSD Class I areas. Impacts as a result of general commercial, residential, industrial, and other growth associated with the source also must be addressed. These analyses are required for each pollutant emitted in significant amounts (Table 3-2).

### **3.3 NONATTAINMENT RULES**

Based on the current nonattainment provisions, all major new facilities and modifications to existing major facilities located in a nonattainment area must undergo nonattainment review. A new major facility is required to undergo this review if the proposed pieces of equipment have the potential to emit 100 TPY or more of the nonattainment pollutant.

### **3.4 EMISSION STANDARDS**

#### **3.4.1 NEW SOURCE PERFORMANCE STANDARDS**

The NSPS are a set of national emission standards that apply to specific categories of new sources. As stated in the CAA Amendments of 1977, these standards "shall reflect the degree of emission limitation and the percentage reduction achievable through application of the best technological system of continuous emission reduction the Administrator determines has been adequately demonstrated."

NSPS applies to new sources constructed after the specified applicability date in each subpart. NSPS applies to existing sources if it is modified after the specified applicability date.

Federal NSPS exist for facilities producing phosphoric acid and phosphate fertilizer products (40 CFR 60, Subparts T through X). Specifically, Subpart V applies to DAP plants. The NSPS apply to all facilities constructed or modified after October 22, 1974. Subpart V regulates F emissions from DAP plants. The F emission standard is 0.060 lb/ton  $P_2O_5$ . It is also noted that any affected source subject to the National Emission Standards for Hazardous Air Pollutants (NESHAPs) for source categories (refer to Subsection 3.4.2) is exempted from Subpart V.

#### **3.4.2 NESHAPS FOR SOURCE CATEGORIES**

Maximum Achievable Control Technologies (MACT) standards applicable to the Mosaic Green Bay facility are codified in Subparts AA and BB of 40 CFR Part 63. Subpart BB is applicable to Phosphate Fertilizer Production Plants. The MACT standards set limits for total F emissions and require certain monitoring requirements for existing sources subject to the rule. For existing MAP/DAP plants, F emissions are limited to 0.06 lb/ton  $P_2O_5$ .

#### **3.4.3 FLORIDA RULES**

The North DAP/MAP and South AP Plants are subject to the emission limitations of Rule 62-296.403, F.A.C., pertaining to F emissions from phosphate processing plants. The provisions of Rule 62-296.403(1)(f) apply to the fertilizer plants for DAP production, which limits F emissions to 0.06 lb/ton  $P_2O_5$ , equivalent to the MACT Subpart BB standard. The South AP Plant is subject to Rule 62-296.403(2), which limits F emissions from the entire facility to 0.40 lb/ton  $P_2O_5$  input to the wet process phosphoric acid section.

### **3.5 SOURCE APPLICABILITY**

#### **3.5.1 AREA CLASSIFICATION**

The project site is located in Polk County, which has been designated by EPA and FDEP as an attainment area for all criteria pollutants. Polk County and surrounding counties are designated as PSD Class II areas for all criteria pollutants. The site is located about 110 km from a PSD Class I area [Chassahowitzka National Wilderness Area (NWA)].

#### **3.5.2 PSD REVIEW**

##### **3.5.2.1 Pollutant Applicability**

The Mosaic Green Bay facility is considered to be an existing major stationary facility because potential emissions of certain regulated pollutants exceed 100 TPY (for example, potential SO<sub>2</sub> emissions currently exceeds 100 TPY). Therefore, PSD review is required for any pollutant for which the net increase in emissions due to the modification is greater than the PSD significant emission rates (see Table 3-2).

The net increase in emissions due to the proposed modification at the facility is shown in Table 3-3. The future potential emissions are based on information from Section 2.0. The past actual emissions for all affected sources are presented in Table 2-2. These include the Phosphoric Acid Plants, and the MAP/DAP Storage/Shipping Buildings.

Also included in Table 3-3 are contemporaneous emission increases and decreases that have occurred at Green Bay in the last 5 years. This includes the 2003 modification to the South AP Plant, which did not trigger PSD review.

As shown in Table 3-3, the net increase in emissions exceeds the PSD significant emission rates for PM, PM<sub>10</sub>, NO<sub>x</sub>, and F. As a result, PSD review applies for these pollutants.

##### **3.5.2.2 Source Impact Analysis**

A source impact analysis was performed for PM<sub>10</sub>, NO<sub>x</sub>, and F emissions resulting from the proposed modification. This analysis is presented in Section 6.0.

##### **3.5.2.3 Ambient Monitoring**

Based on the increase in emissions from the proposed modification (see Table 3-3), a pre-construction ambient monitoring analysis is required for PM<sub>10</sub>, NO<sub>x</sub>, and F, and monitoring data is required to be

submitted as part of the application. However, if the net increase in impacts of a pollutant is less than the applicable *de minimis* monitoring concentration, then an exemption from submittal of pre-construction ambient monitoring data may be obtained [40 CFR 52.21(i)(8)]. In addition, if EPA has not established an acceptable ambient monitoring method for the pollutant, monitoring is not required.

Pre-construction monitoring data for NO<sub>x</sub> may be exempted for this project because, as shown in Table 3-4 and Section 6.0, the proposed modification's impacts are predicted to be below the applicable *de minimis* monitoring concentration for NO<sub>x</sub>. In addition, no air monitoring data is presented for F since AAQS have not been established for this pollutant. A pre-construction ambient monitoring analysis is required for PM<sub>10</sub>. This analysis is presented in Section 4.0.

#### **3.5.2.4 GEP Stack Height Impact Analysis**

No existing stacks at the Mosaic facility currently exceed the *de minimis* GEP stack height of 213 feet (ft). None of the existing stacks will be modified as a result of the proposed project. Therefore, the proposed modification will comply with the GEP stack height regulations.

### **3.5.3 EMISSION STANDARDS**

#### **3.5.3.1 New Source Performance Standards**

The North and South fertilizer plants are not currently subject to NSPS requirements. Subpart V applies to all DAP plants, constructed or modified after October 22, 1974. These plants are not now being modified as defined in 40 CFR 60.14, since Mosaic will not be increasing emissions on a kilogram-per-hour basis. Nevertheless, the NESHAP Subpart BB exempts sources subject to Subpart BB from complying with the NSPS.

#### **3.5.3.2 NESHAPs for Source Categories**

The MACT standard applicable to emission units affected by the proposed project at the Mosaic Green Bay facility, the North DAP/MAP and South AP Plants, are codified in Subpart BB of 40 CFR Part 63. Subpart BB is applicable to Phosphate Fertilizer Production Plants.

The MACT standards limit emissions of total F from the specified plant types. The F emission standard for both the South AP Plant (EU 007), and the North MAP/DAP Fertilizer Plant are 0.060 lb/ton P<sub>2</sub>O<sub>5</sub> input.

The MACT standards require monitoring for wet scrubber emission control systems for existing sources subject to the rule. A summary of the scrubber monitoring requirements under Subpart BB is provided below. Plants using a wet scrubbing emission control system shall install, calibrate, maintain, and operate the following monitoring systems:

1. A monitoring system that continuously measures and permanently records the **pressure drop across each scrubber** in the process scrubbing system in 15-minute block averages. The monitoring system shall be certified by the manufacturer to have an accuracy of  $\pm 5$  percent over its operating range.
2. A monitoring system that continuously measures and permanently records the **flow rate of the scrubbing liquid to each scrubber** in the process scrubbing system in 15-minute block averages. The monitoring system shall be certified by the manufacturer to have an accuracy of  $\pm 5$  percent over its operating range.

For each source using a wet scrubbing emission control system and subject to emissions limitations for total F or PM contained in this subpart, the source must establish allowable ranges for operating parameters for each scrubber in the process scrubbing system, using either of the following methodologies:

1. The allowable range for the daily averages is  $\pm 20$  percent of the baseline average value determined from performance testing. The allowable range could be adjusted downward to  $\pm 10$  percent based on test results. The baseline average value can be readjusted based on subsequent performance testing.
2. The source can establish, and provide to the Administrator for approval, allowable ranges for the daily averages based on performance testing. The source shall certify that the control devices and processes have not been modified subsequent to the testing upon which the data used to establish the allowable ranges were obtained. The owner or operator must request and obtain approval of the Administrator for changes to the allowable ranges. When a source using the methodology of this paragraph is retested, the owner or operator shall determine new allowable ranges of baseline average values unless the retest indicates no change in the operating parameters outside the previously established ranges.

However, the General Provisions of the MACT standards (40 CFR 63, Subpart A) provide for approval of an alternative monitoring method. Section 63.8(f) sets forth the requirements. Section 63.8(f)(2) states, "After receipt and consideration of written application, the Administrator may approve alternatives to any monitoring methods or procedures of this part..." The application

may be submitted at any time provided the monitoring procedure is not the performance test method used to demonstrate compliance.

Mosaic has previously submitted a request for alternative MACT monitoring plan for the Green Bay facility. This request was approved by FDEP on January 22, 2004.

Additional requirements of the MACT standards include performance test and compliance provisions (40 CFR 63.606 and 63.626) and notification, recordkeeping, and reporting requirements (40 CFR 63.607 and 63.627). Mosaic will comply with these requirements for the subject plants.

### **3.5.3.3 State of Florida Standards**

The applicable State of Florida F emissions limits for new phosphate processing plants or plant sections [Rule 62-296.403(1)] are 0.06 lb/ton P<sub>2</sub>O<sub>5</sub> for DAP production. The applicable State of Florida F emissions limit for existing phosphate processing plants or plant sections [Rule 62-296.403(2)] is 0.4 lb/ton P<sub>2</sub>O<sub>5</sub>. According to Permit No. 1050053-034-AC, the South AP Plant is considered an "existing" source and is subject to Rule 62-296.403(2). The North MAP/DAP Plant is considered a new source and subject to Rule 62-296.403(1)(f). Mosaic Green Bay will comply with the Florida standards contained in Rule 62-296.403(2).



Table 3-1. National and State AAQS, Allowable PSD Increments, and Significant Impact Levels

Pollutant	Averaging Time	AAQS ( $\mu\text{g}/\text{m}^3$ )			PSD Increments ( $\mu\text{g}/\text{m}^3$ )		Significant Impact Levels ( $\mu\text{g}/\text{m}^3$ ) <sup>d</sup>
		National Primary Standard	National Secondary Standard	State of Florida	Class I	Class II	
Particulate Matter <sup>a</sup> (PM <sub>10</sub> )	Annual Arithmetic Mean	50	50	50	4	17	1
	24-Hour Maximum <sup>b</sup>	150 <sup>b</sup>	150 <sup>b</sup>	150 <sup>b</sup>	8	30	5
Sulfur Dioxide	Annual Arithmetic Mean	80	NA	60	2	20	1
	24-Hour Maximum <sup>c</sup>	365 <sup>b</sup>	NA	260 <sup>b</sup>	5	91	5
	3-Hour Maximum <sup>b</sup>	NA	1,300 <sup>b</sup>	1,300 <sup>b</sup>	25	512	25
Carbon Monoxide	8-Hour Maximum <sup>b</sup>	10,000 <sup>b</sup>	10,000 <sup>b</sup>	10,000 <sup>b</sup>	NA	NA	500
	1-Hour Maximum <sup>b</sup>	40,000 <sup>b</sup>	40,000 <sup>b</sup>	40,000 <sup>b</sup>	NA	NA	2,000
Nitrogen Dioxide	Annual Arithmetic Mean	100	100	100	2.5	25	1
Ozone <sup>a</sup>	1-Hour Maximum	235 <sup>c</sup>	235 <sup>c</sup>	235 <sup>c</sup>	NA	NA	NA
	1-Hour Maximum	235	235	NA	NA	NA	NA
Lead	Calendar Quarter Arithmetic Mean	1.5	1.5	1.5	NA	NA	NA

Note: NA = Not applicable, i.e., no standard exists.

PM<sub>10</sub> = particulate matter with aerodynamic diameter less than or equal to 10 micrometers.

<sup>a</sup> On July 18, 1997, EPA promulgated revised AAQS for particulate matter and ozone. For particulate matter, PM<sub>2.5</sub> standards were introduced with a 24-hour standard of 65  $\mu\text{g}/\text{m}^3$  (3-year average of 98th percentile) and an annual standard of 15  $\mu\text{g}/\text{m}^3$  (3-year average at community monitors). Implementation of these standards are many years away. The ozone standard was modified to be 0.08 ppm for 8-hour average; achieved when 3-year average of 99th percentile is 0.08 ppm or less. FDEP has not yet adopted these standards.

<sup>b</sup> Short-term maximum concentrations are not to be exceeded more than once per year except for the PM<sub>10</sub> AAQS (these do not apply to significant impact levels). The PM<sub>10</sub> 24-hour AAQS is attained when the expected number of days per year with a 24-hour concentration above 150  $\mu\text{g}/\text{m}^3$  is equal to or less than 1. For modeling purposes, compliance is based on the sixth highest 24-hour average value over a 5-year period.

<sup>c</sup> Achieved when the expected number of days per year with concentrations above the standard is fewer than 1.

<sup>d</sup> Maximum concentrations.

Sources: Federal Register, Vol. 43, No. 118, June 19, 1978. 40 CFR 50. 40 CFR 52.21. Rule 62-204, F.A.C.

Table 3-2. PSD Significant Emission Rates and *De Minimis* Monitoring Concentrations

Pollutant	Regulated Under	Significant Emission Rate (TPY)	De Minimis Monitoring Concentration <sup>a</sup> ( $\mu\text{g}/\text{m}^3$ )
Sulfur Dioxide	NAAQS, NSPS	40	13, 24-hour
Particulate Matter [PM(TSP)]	NSPS	25	NA
Particulate Matter (PM <sub>10</sub> )	NAAQS	15	10, 24-hour
Nitrogen Dioxide	NAAQS, NSPS	40	14, annual
Carbon Monoxide	NAAQS, NSPS	100	575, 8-hour
Volatile Organic Compounds (Ozone)	NAAQS, NSPS	40	100 TPY <sup>b</sup>
Lead	NAAQS	0.6	0.1, 3-month
Sulfuric Acid Mist	NSPS	7	NM
Total Fluorides	NSPS	3	0.25, 24-hour
Total Reduced Sulfur	NSPS	10	10, 1-hour
Reduced Sulfur Compounds	NSPS	10	10, 1-hour
Hydrogen Sulfide	NSPS	10	0.2, 1-hour
Mercury	NESHAP	0.1	0.25, 24-hour
Asbestos	NESHAP	0.007	NM
Vinyl Chloride	NESHAP	1	15, 24-hour
MWC Organics	NSPS	$3.5 \times 10^{-6}$	NM
MWC Metals	NSPS	15	NM
MWC Acid Gases	NSPS	40	NM
MSW Landfill Gases	NSPS	50	NM

Note: Ambient monitoring requirements for any pollutant may be exempted if the impact of the increase in emissions is below de minimis monitoring concentrations.

NA = Not applicable.

NAAQS = National Ambient Air Quality Standards.

NM = No ambient measurement method established; therefore, no *de minimis* concentration has been established.

NSPS = New Source Performance Standards.

NESHAP = National Emission Standards for Hazardous Air Pollutants.

$\mu\text{g}/\text{m}^3$  = micrograms per cubic meter.

MWC = Municipal waste combustor

MSW = Municipal solid waste

<sup>a</sup> Short-term concentrations are not to be exceeded.

<sup>b</sup> No de minimis concentration; an increase in VOC emissions of 100 TPY or more will require monitoring analysis for ozone.

Sources: 40 CFR 52.21.  
Rule 62-212.400

Table 3-3. Contemporaneous and Debottlenecking Emissions Analysis and PSD Applicability

Source Description	Pollutant Emission Rate (TPY)								
	SO <sub>2</sub>	NO <sub>x</sub>	CO	PM	PM <sub>10</sub>	VOC	TRS	SAM	Fluoride
<b>Potential Emissions From Modified/New/Affected Sources</b>									
South AP Fertilizer Plant	13.82	55.17	22.08	50.40	50.40	1.45	--	0.234	12.10
North AP Fertilizer Plant	11.52	32.44	18.40	134.80	134.80	1.20	--	0.195	20.90
Phosphoric Acid Plant No. 1-North Train	--	--	--	--	--	--	--	--	2.41
Phosphoric Acid Plant No. 1-South Train	--	--	--	--	--	--	--	--	3.94
Phosphoric Acid Plant No. 2	--	--	--	--	--	--	--	--	4.82
Phosphoric Acid Storage Tanks-2 (PAP 1, R-R)	--	--	--	--	--	--	--	--	0.09
Phosphoric Acid Storage Tanks-2 (PAP 2, N-N)	--	--	--	--	--	--	--	--	0.09
Phosphoric Acid Blend Tanks-4	--	--	--	--	--	--	--	--	0.44
MAP/DAP Storage and Shipping Building <sup>a</sup>	--	--	--	6.95	3.29	--	--	--	--
<b>Total Potential Emission Rates</b>	<b>25.34</b>	<b>87.61</b>	<b>40.48</b>	<b>185.20</b>	<b>185.20</b>	<b>2.65</b>	<b>0.00</b>	<b>0.43</b>	<b>44.17</b>
<b>Actual Emissions from Current Operations<sup>b</sup></b>									
South DAP Fertilizer Plant	0.02	3.03	2.55	18.61	18.61	0.17	--	--	2.75
North MAP/DAP Fertilizer Plant	0.02	4.10	3.45	24.00	24.00	0.23	--	--	4.49
MAP/DAP Storage and Shipping Building	--	--	--	11.29	11.29	--	--	--	0.24
Phosphoric Acid Plant No. 1-North Train	--	--	--	--	--	--	--	--	0.68
Phosphoric Acid Plant No. 1-South Train	--	--	--	--	--	--	--	--	0.32
Phosphoric Acid Plant No. 2	--	--	--	--	--	--	--	--	0.20
Phosphoric Acid Storage Tanks-2 (PAP 1, R-R)	--	--	--	--	--	--	--	--	0.06
Phosphoric Acid Storage Tanks-2 (PAP 2, N-N)	--	--	--	--	--	--	--	--	0.05
Phosphoric Acid Blend Tanks-4	--	--	--	--	--	--	--	--	0.0004
<b>Total Actual Emission Rates</b>	<b>0.04</b>	<b>7.14</b>	<b>6.00</b>	<b>53.90</b>	<b>53.90</b>	<b>0.39</b>	<b>0.00</b>	<b>0.00</b>	<b>8.68</b>
<b>TOTAL CHANGE DUE TO PROPOSED PROJECT</b>	<b>25.30</b>	<b>80.47</b>	<b>34.48</b>	<b>131.30</b>	<b>131.30</b>	<b>2.26</b>	<b>0.00</b>	<b>0.43</b>	<b>35.49</b>
<b>Contemporaneous Emission Changes<sup>c</sup></b>									
Shutdown of Green Phosphoric Acid Plant (November 2002) <sup>c</sup>	--	-4.10	--	-0.14	-0.12	--	--	--	-0.01
Shutdown of Thermanol Heater (November 2002) <sup>c</sup>	-0.003	-0.77	-0.19	-0.08	-0.08	-0.02	0.00	0.00	0.00
South DAP - Modification for MAP (July 2003) <sup>d</sup>	13.790	31.56	19.15	13.28	14.88	1.20	--	0.23	2.89
<b>Total Contemporaneous Emission Changes</b>	<b>13.79</b>	<b>26.69</b>	<b>18.96</b>	<b>13.06</b>	<b>14.68</b>	<b>1.18</b>	<b>0.00</b>	<b>0.23</b>	<b>2.88</b>
<b>TOTAL NET CHANGE</b>	<b>39.08</b>	<b>107.16</b>	<b>53.44</b>	<b>144.36</b>	<b>145.98</b>	<b>3.44</b>	<b>0.00</b>	<b>0.66</b>	<b>38.37</b>
<b>PSD SIGNIFICANT EMISSION RATE</b>	<b>40</b>	<b>40</b>	<b>100</b>	<b>25</b>	<b>15</b>	<b>40</b>	<b>10</b>	<b>7</b>	<b>3</b>
<b>PSD REVIEW TRIGGERED?</b>	<b>No</b>	<b>Yes</b>	<b>No</b>	<b>Yes</b>	<b>Yes</b>	<b>No</b>	<b>No</b>	<b>No</b>	<b>Yes</b>

**Footnotes:**<sup>a</sup> Debottlenecking analysis revealed that emissions from these sources could potentially increase as part of this project.<sup>b</sup> Based on actual emissions for 2003 and 2004 from Table 2-3 (see also Appendix A).<sup>c</sup> Emissions are based on the average of 2001 and 2002 actual emissions as reported in the AORs.<sup>d</sup> Based on Permit No. 1050053-034-AC and associated permit application.<sup>e</sup> SO<sub>2</sub>, CO, VOC, and SAM not subject to netting since the project increase is not significant. Contemporaneous emissions for these pollutants shown for information only.

Table 3-4. Predicted Impacts Due to the Proposed Project Compared to Class II Significant Impact Levels and Ambient Monitoring *De Minimis* Levels

Pollutant	Averaging Time	Maximum Concentration <sup>a</sup> ( $\mu\text{g}/\text{m}^3$ )	EPA Class II Significant Impact Levels ( $\mu\text{g}/\text{m}^3$ )	<i>De Minimis</i> Monitoring Concentration ( $\mu\text{g}/\text{m}^3$ )	Ambient Monitoring Review Applies?
Particulate (PM <sub>10</sub> )	Annual	6.5	1	NA	NA
	24-hour	39.0	5	10	Yes
Nitrogen Dioxide (NO <sub>2</sub> )	Annual	1.5	1	14	No
Fluorides	24-hour	7.9	NA	0.25	Yes

<sup>a</sup> Highest concentration from significant impact analysis (see Section 6.0).

Note: NA = Not Applicable

## 4.0 AMBIENT MONITORING ANALYSIS

### 4.1 MONITORING REQUIREMENTS

In accordance with requirements of 40 CFR 52.21(m) and Rule 62-212.400(5)(f), F.A.C., any application for a PSD permit must contain an analysis of continuous ambient air quality data in the area affected by the proposed major stationary facility or major modification. For a new major facility, the affected pollutants are those that the facility potentially would emit in significant amounts. For a major modification, the pollutants are those for which the net emissions increase exceeds the significant emission rate (see Table 3-1). As discussed in Subsection 3.5.2, PM/PM<sub>10</sub>, NO<sub>x</sub>, and F require an air quality analysis to meet PSD pre-construction monitoring requirements for the proposed Mosaic expansion.

Ambient air monitoring for a period of up to 1 year is generally appropriate to satisfy the PSD monitoring requirements. A minimum of 4 months of data is required. Existing data from the vicinity of the proposed source may be used if the data meet certain quality assurance requirements; otherwise, additional data may need to be gathered. Guidance in designing a PSD monitoring network is provided in EPA's *Ambient Monitoring Guidelines for Prevention of Significant Deterioration* (1987).

An exemption from the pre-construction ambient monitoring requirements is also available if certain criteria are met. If the predicted increase in ambient concentrations, due to the proposed modification, is less than specified *de minimis* concentrations, then the modification can be exempted from the pre-construction air monitoring requirements for that pollutant.

The PSD *de minimis* monitoring concentration for PM<sub>10</sub> is 10 µg/m<sup>3</sup>, 24-hour average; for NO<sub>x</sub> is 14 µg/m<sup>3</sup>, annual average; and for F is 0.25 µg/m<sup>3</sup>, 24-hour average. The predicted increase in PM<sub>10</sub>, NO<sub>x</sub>, and F concentrations due to the proposed modification only are presented in Section 6.0 and in Table 3-4. Since the predicted increases of PM<sub>10</sub> and F impacts due to the proposed modification are greater than the *de minimis* monitoring concentration levels, a pre-construction air monitoring analysis must be conducted for these pollutants. A pre-construction air monitoring analysis is not required for NO<sub>x</sub>. However, background concentrations for NO<sub>x</sub> are presented in Section 4.4 to support the air dispersion modeling analysis.

#### **4.2 PM<sub>10</sub> AMBIENT MONITORING ANALYSIS**

The PSD ambient monitoring guidelines allow the use of existing data to satisfy pre-construction review requirements. Presented in Table 4-1 is a summary of existing ambient PM<sub>10</sub> data for monitors located in the vicinity of Mosaic's Green Bay facility. Data are presented for 2002 through 2004. As shown, two PM<sub>10</sub> monitors were operational in the vicinity of Mosaic's Green Bay facility during this period. Both of these stations are located in the town of Mulberry.

The monitors show that the ambient PM<sub>10</sub> concentration measurements were below the AAQS of 150 µg/m<sup>3</sup>, maximum 24-hour average, and 50 µg/m<sup>3</sup>, annual average. For purposes of an ambient PM<sub>10</sub> background concentration for use in the modeling analysis, the highest annual average concentration and the higher of the sixth-highest 24-hour average concentrations occurring over the 3-year period at the two sites were selected. These concentrations are 21 and 50 µg/m<sup>3</sup>, respectively, measured at the NW 4<sup>th</sup> Circle monitoring site. These monitors are likely impacted by several existing point sources that are already included explicitly in the modeling dispersion analysis. As a result, these background concentrations are conservatively high.

#### **4.3 FLUORIDE AMBIENT MONITORING ANALYSIS**

There are no known existing F monitors in the vicinity of Mosaic's Green Bay facility. No AAQS for F emissions have been promulgated. Typically, pre-construction monitoring has not been required for pollutants for which no AAQS exist. However, potential effects of F impacts are addressed in Section 7.0.

#### **4.4 NO<sub>x</sub> AMBIENT MONITORING ANALYSIS**

A background NO<sub>x</sub> concentration must be estimated to account for NO<sub>x</sub> sources, which are not explicitly included in the atmospheric dispersion modeling analysis. To estimate reasonable background NO<sub>x</sub> concentrations, a review of recent, available NO<sub>x</sub> monitoring data in the area of Mosaic Green Bay was performed. Presented in Table 4-2 is a summary of ambient NO<sub>x</sub> data available for 2002 through 2004, for the two closest monitors to the Green Bay site. The two stations are located in Tampa.

The monitors show that ambient NO<sub>x</sub> annual average concentrations were well below the AAQS of 100 µg/m<sup>3</sup>. For purposes of an ambient NO<sub>x</sub> background concentration for use in the modeling analysis, the highest annual average concentration occurring over the 3-year period was selected. This concentration is 20 µg/m<sup>3</sup>, measured in Tampa (Gandy Boulevard). This background is

conservatively high, since it is likely impacted by several existing point sources, such as Mosaic Riverview and Tampa Electric's Big Bend power station, which are already included explicitly in the dispersion modeling analysis. The monitor is also impacted significantly by vehicular traffic in the Tampa area.

Table 4-1. Summary of PM10 Monitoring Data Collected Near Mosaic Green Bay

County	Station ID	Monitor Location	Year	Number of Observations	Reported Concentration (ug/m <sup>3</sup> )				Annual Average
					24-hour Average				
					Highest	Second-Highest	Third-Highest	Fourth-Highest	
Polk	12-105-0010	Mulberry, Anderson & Pine Crest Road	2004	349	66 (1)	51 (2)	43 (4)	42 (6)	21
			2003	346	51 (3)	42	39	39	20
			2002	357	43 (5)	38	38	37	18
Polk	12-105-2006	Mulberry, NW 4th Circle	2004	347	68 (3)	50 (6)	42	41	21
			2003	355	59 (5)	49	45	42	20
			2002	362	165 (1)	78 (2)	64 (4)	45	21

<sup>a</sup> Number in parenthesis represents rank of 24-hour average concentration (highest to sixth-highest).

Source: EPA Air Data, 2002 through 2004.



Table 4-2. Summary of NO<sub>2</sub> Monitoring Data Collected Near Mosaic Green Bay

County	Station ID	Monitor Location	Year	Number of Observations	Reported Concentration Annual Average	
					(ug/m <sup>3</sup> )	(ppm)
Hillsborough	12-057-0081	Tampa, E.G. Simmons County Road	2004	8171	11	0.006
			2003	8444	13	0.007
			2002	8692	13	0.007
Hillsborough	12-057-1065	Tampa, 5121 Gandy Blvd.	2004	8182	17	0.009
			2003	8636	19	0.010
			2002	8000	20	0.011

Source: EPA Air Data, 2002 through 2004.

## 5.0 BEST AVAILABLE CONTROL TECHNOLOGY ANALYSIS

### 5.1 REQUIREMENTS

The 1977 CAA Amendments established requirements for the approval of pre-construction permit applications under the PSD program. As discussed in Section 3.2.2, one of these requirements is that BACT be installed for applicable pollutants. BACT determinations must be made on a case-by-case basis considering technical, economic, energy, and environmental impacts for various BACT alternatives. To bring consistency to the BACT process, the EPA developed the "top-down" approach to BACT determinations.

The first step in a top-down BACT analysis is to determine, for each applicable pollutant, the most stringent control alternative available for a similar source or source category. If it can be shown that this level of control is not feasible on the basis of technical, economic, energy, or environmental impacts for the source in question, then the next most stringent level of control is identified and similarly evaluated. This process continues until the BACT level under consideration cannot be eliminated by any technical, economic, energy, or environmental consideration.

In the case of the proposed project, PM/PM<sub>10</sub>, NO<sub>x</sub>, and F emissions require a BACT analysis. The BACT analysis is presented in the following sections.

### 5.2 SOUTH AND NORTH AP PLANTS—PARTICULATE MATTER (PM/PM<sub>10</sub>)

#### 5.2.1 PROPOSED CONTROL TECHNOLOGY

The proposed BACT for PM/PM<sub>10</sub> from the South and the North AP plants is the continued use of the existing PM/PM<sub>10</sub> emission control equipment at these plants. The existing control equipment is described below:

##### South AP Plant

- One venturi/cyclonic scrubber controlling PM/PM<sub>10</sub> emissions from the Reactor and Granulator, used as the primary control device;
- One venturi/cyclonic scrubber controlling PM/PM<sub>10</sub> emissions from the Dryer;
- One venturi/cyclonic scrubber controlling PM/PM<sub>10</sub> from the Screens and Mills;
- One venturi/cyclonic scrubber controlling PM/PM<sub>10</sub> emissions from the Cooler; and
- One cross-flow scrubber utilizing pond water as a secondary control device and controlling F emissions from the Dryer, Screens, and Mills.

**North AP Plant**

- One venturi/cyclonic scrubber controlling PM/PM<sub>10</sub> emissions from the Reactor and Granulator;
- One wet scrubber controlling PM/PM<sub>10</sub> emissions from the Reactor and Granulator;
- One ammonia vaporizer tailgas scrubber controlling F emissions from the Reactor and Granulator;
- One venturi scrubber controlling PM/PM<sub>10</sub> emissions from the Dryer;
- One venturi scrubber controlling PM/PM<sub>10</sub> from the Screens and Mills;
- One venturi/cyclonic scrubber controlling PM/PM<sub>10</sub> emissions from the Cooler; and
- One cross-flow scrubber utilizing pond water used as a secondary control device and controlling F emissions from the Dryer, Screens, and Mills.

Refer to Section 2.0 for further information pertaining to the existing control equipment for the North and South AP Plants. The proposed maximum PM/PM<sub>10</sub> emission rate for the South AP Plant is 0.25 lb/ton P<sub>2</sub>O<sub>5</sub>, equivalent to 11.5 lb/hr. The maximum PM/PM<sub>10</sub> emission rate proposed for the North AP Plant is 0.29 lb/ton P<sub>2</sub>O<sub>5</sub>, equivalent to 30.8 lb/hr and 20.4 lb/hr while producing MAP and DAP, respectively.

**5.2.2 BACT ANALYSIS****5.2.2.1 Previous BACT Determinations**

As part of the BACT analysis, a review was performed of previous PM/PM<sub>10</sub> BACT determinations for GTSP, MAP, and DAP manufacturing facilities listed in the RACT/BACT/LAER Clearinghouse on the EPA web page. BACT determinations from previous Mosaic (Mosaic Fertilizer) and Golder permitting projects were also identified. A summary of BACT determinations for GTSP, MAP, and DAP manufacturing facilities from this review are presented in Table 5-1. Determinations issued during the last 10 years are shown in the table.

From the review of previous BACT determinations, it is evident that PM/PM<sub>10</sub> BACT determinations for GTSP, MAP, and DAP manufacturing facilities have been based on wet scrubber technology. BACT determinations have been in the range of 0.15 to 0.40 lb/ton P<sub>2</sub>O<sub>5</sub> for PM/PM<sub>10</sub> emissions, with the most recent determinations being issued at 0.15 lb/ton P<sub>2</sub>O<sub>5</sub>.

### **5.2.2.2 Control Technology Feasibility**

The control technology feasibility analysis for PM/PM<sub>10</sub> controls for the South and North AP Plants is presented in Table 5-2. As shown, there are five types of PM/PM<sub>10</sub> abatement methods with various techniques within each method. Each available technique was listed with its associated efficiency estimate, identified as feasible or infeasible, and ranked based on control efficiency.

### **5.2.2.3 Potential Control Method Descriptions**

#### ***Fuel Techniques***

Fuel Substitution, or fuel switching, is a common means of reducing emissions from combustion sources; such as electric utilities and industrial boilers. It involves replacing the current fuel with a fuel, which emits less of a given pollutant when burned. Since the PM/PM<sub>10</sub> emissions from the AP Plants are mainly due to the manufacturing and handling of the ammoniated phosphates fertilizer, not fuel combustion, this is not a feasible means of particulate control. Therefore, this method is not considered further.

#### ***Pretreatment Devices***

The performance of particulate control devices can often be improved through pretreatment of the gas stream. For PM control, pretreatment consists of the following techniques:

- Settling Chambers,
- Elutriators,
- Momentum Separators,
- Mechanically-Aided Separators, and
- Cyclones.

Of these five techniques, cyclones offer the most control efficiency, typically in the range of 60 to 90 percent. All of the other techniques have control efficiencies less than 30 percent.

Cyclones use inertia to remove particles from a spinning gas stream. Within a cyclone, the gas stream is forced to spin within a usually conical-shaped chamber. The gas spirals down the cyclone near the inner surface of the cyclone tube. At the bottom of the cyclone, the gas turns and spirals up through the center of the tube and out the top of the cyclone.

Particles in the gas stream are forced toward the cyclone walls by centrifugal forces. For particles that are large, typically greater than 10 microns, inertial momentum overcomes the fluid drag forces

so that the particles reach the cyclone walls and are collected. For smaller particles, the fluid drag forces are greater than the momentum forces and the particles follow the gas out of the cyclone. Inside the cyclone gravity forces the large particles down the sidewalls of the cyclone to a hopper where they are collected.

Pretreatment devices are technically feasible for application to the AP Fertilizer Plants. Mosaic Green Bay currently utilizes cyclones at its North and South Fertilizer Plants as an integral part of the process. The cyclones are used primarily for product recovery, and achieve particulate control prior to the air streams entering the wet scrubbers.

#### *Electrostatic Precipitators (ESPs)*

Collection of PM by electrostatic precipitators involves the ionization of the gas stream passing through the ESP, the charging, migration, and collection of particles on oppositely charged surfaces, and the removal of particles from the collection surfaces. There are two basic types of ESPs, dry and wet. In dry ESPs, the particulate is removed by rappers, which vibrate the collection surface, dislodging the material and allowing it to fall into the collection hoppers. Wet ESPs use water to rinse the particulates off of the collection surfaces.

Electrostatic precipitators have several advantages when compared with other control devices. They are very efficient collectors, even for small particles, with greater than 97-percent control efficiency. ESPs can also treat large volumes of gas with a low-pressure drop. ESPs can operate over a wide range of temperatures and generally have low operating cost. The disadvantages of ESPs are large capital cost, large space requirements and difficulty in controlling particles with high resistivity.

While ESPs may be a feasible method of controlling PM, there are no known applications of ESPs at MAP, DAP, or GTSP plants. Since wet scrubbers are necessary to remove F and ammonia emissions, using wet scrubbers to control PM as well is logical. Furthermore, the "stickiness" of the particles after the ammonia has been scrubbed out of the air stream could potentially cause problems with the ESP. This may be part of the reason ESPs have never been used for this type of application. Therefore, ESPs were not further considered.

#### *Fabric Filters*

Baghouses, or fabric filters, utilize porous fabric to clean an airstream. They include types such as reverse-air, shaker, and pulse-jet baghouses. The dust that accumulates on the surface of the filter

aids in the filtering of fine dust particles. PM/PM<sub>10</sub> control efficiencies for fabric filters are typically greater than 99 percent.

During fabric filtration, dusty gas is sent through the fabric by forced-draft fans. The fabric is responsible for some filtration, but more significantly it acts as support for the dust layer that accumulates. The layer of dust, also known as the filter cake, is a highly efficient filter, even for submicron particles. Woven fabrics rely on the filtration of the dust cake much more than felted fabrics.

Fabric filters offer high efficiencies, are flexible to treat many types of dusts and a wide range of volumetric gas flow rates. In addition, fabric filters can be operated with low pressure drop. Some potential disadvantages are:

- High moisture gas streams and sticky particles can plug the fabric and blind the filter, requiring bag replacement;
- High temperatures can damage fabric bags; and
- Fabric filters have a potential for fire or explosion.

Fabric filters are considered technically infeasible for application to the AP Fertilizer Plants. There is no known application of a baghouse to a MAP, DAP, or GTSP fertilizer plant, and therefore the technology is unproven. Serious concerns exist over the ability of a baghouse to operate with a flue gas containing significant moisture. As a result, fabric filter technology was not further considered.

#### *Wet Scrubbers*

Wet scrubbers are devices that achieve particle collection by contacting the particles to a liquid, usually water. The aerosol particles are transferred from the gaseous airstream to the surface of the liquid by several different mechanisms. Wet scrubbers create a liquid waste that must be treated prior to disposal. PM/PM<sub>10</sub> control efficiencies for wet scrubbing systems range from about 50 to 95 percent, depending on the type of scrubbing system used. Typical wet scrubbers are as follows:

- Venturi;
- Spray Chamber;
- Impingement Plate;
- Mechanically-Aided;
- Orifice;

- Condensation; and
- Packed bed.

The advantages of wet scrubbers compared to other PM collection devices are that they can collect flammable and explosive dusts safely, absorb gaseous pollutants, collect "sticky particles", and collect mists. Scrubbers can also cool hot gas streams. The disadvantages are the potential for corrosion and freezing, the potential of water and solid waste pollution problems, and high energy costs.

A venturi scrubber accelerates the gas stream to atomize the scrubbing liquid and to improve gas-liquid contact. In a venturi scrubber, a "throat" section is built into the duct that forces the gas stream to accelerate as the duct narrows and then expands. As the gas enters the venturi throat, both gas velocity and turbulence increase. The scrubbing liquid is introduced at this point and is atomized into small droplets by the turbulence in the throat, and droplet-particle interaction is increased. Typically, after the throat section in a venturi scrubber, the wetted PM, and excess liquid droplets are separated from the gas stream by cyclonic motion and/or a mist eliminator. Venturi scrubbers have the advantage of being simple in design, easy to install, and with low-maintenance requirements. To increase the control efficiency of a venturi scrubber, the pressure drop must be increased, which in turn increases the energy consumption. Medium-energy venturi scrubbers have pressure drops up to 15 inches, and high-energy venturi scrubbers have pressure drops from 15 to 30 inches.

Spray chambers are very simple, low-energy wet scrubbers. In these scrubbers, the particulate-laden gas stream is introduced into a chamber where it comes into contact with liquid droplets generated by spray nozzles. These scrubbers are also known as pre-formed spray scrubbers, since the liquid is formed into droplets prior to contact with the gas stream. The size of the droplets generated by the spray nozzles is controlled to maximize liquid-particle contact, and consequently, scrubber collection efficiency.

The two common types of spray chambers are spray towers and cyclonic chambers. Spray towers are cylindrical or rectangular chambers that can be installed vertically or horizontally. The scrubber liquid is sprayed into the chamber. A de-mister at the top of the spray tower removes liquid droplets and wetted PM from the exiting gas stream. A cyclonic spray chamber is similar to a spray tower with one major difference. The gas stream is introduced to produce cyclonic motion inside the

chamber. This motion contributes to higher gas velocities, more effective particle and droplet separation, and higher collection efficiency.

An impingement plate scrubber is a vertical chamber with plates mounted horizontally inside a hollow shell. Impingement plate scrubbers operate as countercurrent PM collection devices. The scrubbing liquid flows down the tower while the gas stream flows upward. Contact between the liquid and the particle-laden gas occurs on the plates. The plates are equipped with openings that allow the gas to pass through. The scrubbing liquid flows across each plate and down the inside of the tower onto the plate below. After the bottom plate, the liquid and collected PM flow out of the bottom of the tower. Impingement plate scrubbers are usually designed to provide operator access to each tray, making them relatively easy to clean and maintain. Consequently, impingement plate scrubbers are more suitable for PM collection than packed-bed scrubbers. Particles greater than 1 micrometer ( $\mu\text{m}$ ) in diameter can be collected effectively by impingement plate scrubbers, but many particles  $<1 \mu\text{m}$  will penetrate these devices.

Mechanically-aided scrubbers (MAS) employ a motor driven fan or impeller to enhance gas-liquid contact. Generally in MAS, the scrubbing liquid is sprayed onto the fan or impeller blades. Fans and impellers are capable of producing very fine liquid droplets with high velocities. These droplets are effective in contacting fine PM. Once PM has impacted on the droplets, it is normally removed by cyclonic motion. MAS are capable of high collection efficiencies, but only with a commensurate high-energy consumption. Because many moving parts are exposed to gas and scrubbing liquid in a MAS, these scrubbers have high maintenance requirements. Mechanical parts are susceptible to corrosion, PM buildup, and wear. Consequently, mechanical scrubbers have limited applications for PM control.

Orifice scrubbers, also known as entrainment or self-induced spray scrubbers, force the particle-laden gas stream to pass over the surface of a pool of scrubbing liquid as it enters an orifice. With the high gas velocities typical of this type of scrubber, the liquid from the pool becomes entrained in the gas stream as droplets. As the gas velocity and turbulence increases with the passing of the gas through the narrow orifice, the interaction between the PM and liquid droplets also increases. PM and droplets are then removed from the gas stream by impingement on a series of baffles that the gas encounters after the orifice. The collected liquid and PM drain from the baffles back into the liquid pool below the orifice. Orifice scrubbers usually have low liquid demands, have relatively simple designs, and have few moving parts. The major maintenance concern is the removal of the sludge,



which collects at the bottom of the scrubber. Orifice scrubbers are only effective at collecting particles larger than 2  $\mu\text{m}$  in diameter.

Condensation scrubbing is a relatively recent development in wet scrubber technology. Most conventional scrubbers rely on the mechanisms of impaction and diffusion to achieve contact between the PM and liquid droplets. In a condensation scrubber, the PM acts as condensation nuclei for the formation of droplets. Generally, condensation scrubbing depends on first establishing saturation conditions in the gas stream. Once saturation is achieved, steam is injected into the gas stream. The steam creates a condition of super-saturation and leads to condensation of water on the fine PM in the gas stream. The large condensed droplets can be removed by several conventional devices. Typically, a high efficiency mist eliminator is used for this purpose.

Packed-bed scrubbers consist of a chamber containing layers of variously shaped packing material, such as raschig rings, spiral rings, and berl saddles that provide a large surface area for liquid-particle contact. The packing is held in place by wire mesh retainers and supported by a plate near the bottom of the scrubber. Scrubbing liquid is evenly introduced above the packing and flows down through the bed. The liquid coats the packing and establishes a thin film. In a packed-bed scrubber, high PM concentrations can clog the bed, hence, the limitation of these devices to streams with relatively low dust loadings. Plugging is a serious problem for packed-bed scrubbers because the packing is more difficult to access and clean than other scrubber designs. In general, packed-bed scrubbers are more suitable for gas scrubbing than particulate scrubbing because of the high maintenance requirements for control of PM.

The PM abatement method most commonly utilized at existing MAP, DAP, and GTSP plants is medium-energy venturi scrubbers (refer to Table 5-1). Cross-flow and packed bed scrubbers are also utilized at a few facilities. Of the technically feasible control technologies, venturi scrubbers are considered to have the highest control efficiencies for controlling PM/PM<sub>10</sub>. Spray chambers, impingement plate, mechanically aided, orifice, and condensation scrubbers also have fairly high control efficiencies and are considered technically feasible. Of these types of scrubbers only spray chambers have been applied to MAP, DAP, or GTSP plants. Therefore, the other control techniques are considered unproven for this type of application. Packed-bed scrubbers have the lowest control efficiencies of any of the wet scrubbers for PM control. Mosaic Green Bay currently utilizes medium-energy venturi scrubbers to control PM from the North and South AP Plants.

#### 5.2.2.4 Economic Analysis

To achieve PM emissions below those proposed for the North and South AP Plants, modifications to the existing scrubbing system would be required and new high-energy venturi scrubbers will have to be installed. The South and North AP Plants are currently using multiple medium-energy venturi scrubbers to control PM.

To evaluate the cost effectiveness of modifying the existing scrubbing system by adding new high-energy venturi scrubbers, cost estimates were obtained, which included new equipment cost, installation, demolition, and electrical cost. The cost quotes were originally obtained in 2003, which were converted to 2005 dollars using the U.S. Department of Labor Bureau of Labor Statistics Producer Price Index for Phosphatic Fertilizer Manufacturing. Separate cost estimates were obtained for the South and North Plants. These factors resulted in a capital cost of \$13.7 million for both the South and North AP Plants.

Annual operating costs were developed considering the annualized capital recovery cost and other direct and indirect operating costs, which are based on standard cost factors and engineering estimates. Capital recovery costs are based on an interest rate of 7 percent and a 20-year equipment life. The cost analysis is presented in Table 5-3.

Baseline PM emissions, for the purpose of determining the cost effectiveness of adding new high-energy venturi scrubbers is based on the proposed allowable PM emission limit of 0.25 lb/ton of P<sub>2</sub>O<sub>5</sub> for the South AP Plant and 0.29 lb/ton P<sub>2</sub>O<sub>5</sub> for the North AP Plant, which can be achieved by the existing medium-energy venturi scrubbing systems at both plants. It is assumed that the new scrubbers would achieve a PM emission rate of 0.15 lb/ton P<sub>2</sub>O<sub>5</sub>, equivalent to the lowest BACT determination for PM to date. These new controls would mean a reduction of 85.3 TPY of PM/PM<sub>10</sub> for the two plants together.

Based on the annualized cost of \$2.76 million per year for converting the existing scrubbing system and installing additional high-energy venturi scrubbers and a PM reduction of 85.3 TPY, the resulting cost effectiveness is \$32,400 per ton of PM removed. This cost is considered to be unreasonable and, as a result, installing replacement high-energy venturi scrubbers in the South AP Plant and North AP Plant was found to be economically infeasible.

### 5.2.2.5 Environmental Impacts

High-energy venturi scrubbers would consume more energy than the existing medium-energy venturi scrubbers. Water consumption with the new scrubbers would not change significantly. Water discharges also would not be affected.

As shown in Tables 6-16, 6-18, and 6-19, the maximum predicted PM<sub>10</sub> impacts for the proposed project are well below the AAQS and PSD Class II increment levels, and insignificant at the Class I area. Additional PM/PM<sub>10</sub> controls would result in an insignificant reduction of ambient impacts that are already below the AAQS and PSD Class I and Class II increment levels.

### 5.2.3 BACT SELECTION

Mosaic will utilize its existing medium-energy venturi/cyclonic scrubbers since they will yield the greatest control efficiencies with a proven technology. Mosaic Green Bay's proposed PM/PM<sub>10</sub> control technology and emission limit is reasonable based on previous BACT determinations for similar facilities. Although Mosaic's proposed PM/PM<sub>10</sub> emission limit of 0.25 lb/ton P<sub>2</sub>O<sub>5</sub> for the South AP Plant and 0.29 lb/ton P<sub>2</sub>O<sub>5</sub> for the North AP Plant is higher than the most recent BACT determination of 0.15 lb/ton P<sub>2</sub>O<sub>5</sub>, it is consistent with using the existing control technology. Green Bay is only making a piping change on one plant in this project.

The Riverview and the Bartow Fertilizer plants are achieving the 0.15 lb/ton P<sub>2</sub>O<sub>5</sub> limit based on different technology compared to the AP Plants at Mosaic Green Bay. It is demonstrated to be economically infeasible to replace the existing scrubbers with high-energy venturi scrubbers. A factor affecting the actual emissions from the plants will be the particulate loading to the scrubbers, which will be higher from an older plant than a newer plant. The proposed emission rate of 0.25 lb/ton P<sub>2</sub>O<sub>5</sub> for the South AP Plant is less than the current permit limit of 0.256 lb/ton P<sub>2</sub>O<sub>5</sub>. Similarly, the proposed emission rate of 0.29 lb/ton P<sub>2</sub>O<sub>5</sub> for the North AP Plant is less than the current permit limit of 0.30 lb/ton P<sub>2</sub>O<sub>5</sub>.

Summaries of recent PM and F emissions tests for the South AP and North MAP/DAP Plants are presented in Tables 5-4 and 5-5, respectively. The historic PM emission test results for the South AP Plant ranged from 0.053 to 0.265 lb/ton P<sub>2</sub>O<sub>5</sub>. The PM emission test results for the North AP Plant have ranged from 0.033 to 0.471 lb/ton P<sub>2</sub>O<sub>5</sub>. Using the upper 95-percent confidence limits for these data, a PM/PM<sub>10</sub> limit of 0.25 lb/ton P<sub>2</sub>O<sub>5</sub> is proposed for the South AP Plant and 0.29 lb/ton P<sub>2</sub>O<sub>5</sub> is proposed for the North AP Plant.

### **5.3 SOUTH AND NORTH AP PLANTS—FLUORIDES**

#### **5.3.1 PROPOSED CONTROL TECHNOLOGY**

Similar to the BACT for PM/PM<sub>10</sub>, BACT for F emissions from the South and the North AP Plants is also the continued use of the existing emission control equipment at these plants, which are described in Subsection 5.2.1.

Refer to Section 2.0 for further information pertaining to the existing control equipment for the North and South AP Plants. The proposed maximum F emission rate for the South AP Plant is 0.06 lb/ton P<sub>2</sub>O<sub>5</sub>. For the North AP Plant, the proposed maximum emissions are 0.045 lb/ton P<sub>2</sub>O<sub>5</sub> for MAP and 0.0417 lb/ton P<sub>2</sub>O<sub>5</sub> for DAP. These rates are equivalent to 2.76 lb/hr for the South AP Plant, and 4.77 lb/hr and 3.17 lb/hr for the North AP Plant while producing MAP and DAP, respectively. The emission limit of 0.06 lb/ton P<sub>2</sub>O<sub>5</sub> for the South AP Plant is also the current permit limit for the plant.

#### **5.3.2 BACT ANALYSIS**

##### **5.3.2.1 Previous BACT Determinations**

As part of the BACT analysis, a review was performed of previous BACT determinations for F emissions from GTSP, MAP, and DAP manufacturing facilities listed in the RACT/BACT/LAER Clearinghouse on the EPA web page, and BACT determinations available to Golder. A summary of BACT determinations for GTSP, MAP, and DAP manufacturing facilities from this review are presented in Table 5-6. Determinations issued during the last 10 years are shown in the table.

From the review of previous BACT determinations, it is evident that F BACT determinations for GTSP, MAP, and DAP manufacturing facilities have all been based on wet scrubber technology. With one exception, BACT determinations have been in the range of 0.035 to 0.06 lb/ton P<sub>2</sub>O<sub>5</sub> of F emissions. The most recent determinations are in the range of 0.035 to 0.04 lb/ton P<sub>2</sub>O<sub>5</sub>. The lowest emission limit of 0.019 lb/ton P<sub>2</sub>O<sub>5</sub> was for a prilled MAP plant, which is a different process compared to Mosaic's granular MAP/DAP plants. The next lowest emission limit from previous BACT determinations was 0.035 lb/ton P<sub>2</sub>O<sub>5</sub>, which is also the most recent.

##### **5.3.2.2 Control Technology Feasibility**

The control technology feasibility analysis for F emission controls for the South and North AP Plants is presented in Table 5-7. As shown, there are six types of abatement methods for F, all of which are

wet scrubber techniques. Each available technique was listed with its associated efficiency estimate, identified as feasible or infeasible, and ranked based on control efficiency.

### **5.3.2.3 Potential Control Method Descriptions**

The technically feasible wet scrubbers for the AP Fertilizer Plants at Mosaic Green Bay are as follows:

- Packed Tower;
- Wet Cyclonic;
- Orifice/Impingement Tray;
- Spray Chamber;
- Venturi; and
- Ammonia Vaporizer.

Packed towers, wet cyclonic, orifice/impingement trays, spray chambers, and venturi scrubbers were described in Section 5.2.2.

In an ammonia vaporizer, the gas stream passes through the tubes of a shell and tube heat exchanger. On the shell side, ammonia is vaporized while moisture condenses from the air stream on the tube side. In Green Bay's existing ammonia vaporizer system in the North AP Plant, the gas stream consists of gases from the reactor and granulator of the North AP Plant. The condensed moisture on the tube side absorbs the majority of the F present in the gas stream. In order to properly wet all surfaces and promote improved operation, a portion of the condensate is continuously re-circulated over the tube sheet and through the tubes.

### **5.3.2.4 Economic Analysis**

To achieve F emissions below those proposed for the North and South AP Plants, modifications to the existing scrubbing system would be required and packed bed scrubbers or an ammonia vaporizer system will have to be installed. The South AP Plant is currently using a venture scrubber and cross-flow scrubber to control F emissions. The North AP Plant uses an ammonia vaporizer system and a cross-flow scrubber.

To evaluate the cost effectiveness of modifying the existing scrubbing system by adding scrubbers or an ammonia vaporizer, cost estimates were obtained, which included new equipment cost, installation, services, engineering, demolition, and electrical cost. The cost quotes were originally

obtained in 2003, which were converted to 2005 dollars using an escalator of 30 percent, estimated by Mosaic due to recent increases in the cost of metal. Separate cost estimates were obtained for the South and North Plants, since the North AP Plant already utilizes an ammonia vaporizer system. The cost analysis was performed for the following changes to the South AP Plant:

- Adding an ammonia vaporizer to control F emissions from the reactor/granulator (Stack A); and
- Replacing the existing cross-flow scrubber with a new packed bed scrubber (Stack B).

For the North AP Plant, the cost analysis consisted of replacing the existing cross-flow scrubber with a packed bed scrubber for the Dryer/Screens and Mills (Main Stack).

Annual operating costs were developed considering the annualized capital recovery cost and other direct and indirect operating costs, which are based on standard cost factors and engineering estimates. Capital recovery costs are based on an interest rate of 7 percent and a 20-year equipment life. The cost analysis is presented in Table 5-8.

Baseline F emissions, for the purpose of determining the cost effectiveness of adding new packed bed venturi scrubbers or an ammonia vaporizer is based on the proposed allowable F emission limit of 0.06 lb/ton of  $P_2O_5$  for the South AP Plant and 0.045 lb/ton  $P_2O_5$  for the North AP Plant, which can be achieved by the existing control technology. It is assumed that the new scrubbers would achieve a F emission rate of 0.035 lb/ton  $P_2O_5$ , equivalent to the lowest BACT determination for F to date. These new controls would mean a reduction of TPY of F for the South AP Plant and 4.6 TPY for the North AP Plant.

Based on the annualized costs for modifying the existing scrubbing systems, the resulting cost effectiveness is \$59,000 per ton of F removed for the South AP Plant and \$38,000 per ton of F removed for the North AP Plant. This cost is considered to be unreasonable and, as a result, installing control equipment in the South AP Plant and North AP Plant was found to be economically infeasible.

### 5.3.3 BACT SELECTION

In conclusion, Mosaic Green Bay's proposed F technology and emission limit is reasonable based on previous BACT determinations for similar facilities. Although Mosaic's proposed F emission limits of 0.06 lb/ton  $P_2O_5$  for the South AP Plant, and 0.045 lb/ton  $P_2O_5$  for MAP and 0.0417 lb/ton  $P_2O_5$  for

DAP for the North AP Plant, are consistent with the existing technology, they are lower than the most recent range of BACT determinations from 0.035 to 0.04 lb/ton  $P_2O_5$ . The AP Plants are using an existing control technology, which is not able to achieve these lower emissions. The Riverview or the Bartow Fertilizer plants that are achieving the 0.035 to 0.04 lb/ton  $P_2O_5$  based on different technology than the AP Plants at Mosaic Green Bay. Green Bay is only making piping changes in this project.

Recent F stack test data for the South AP and North AP Plants are presented in Tables 5-4 and 5-5. The F emissions test data for the South AP Plant have ranged from 0.015 lb/ton  $P_2O_5$  to 0.068 lb/ton  $P_2O_5$ . The F emissions test data for the North AP Plant ranged from 0.005 to 0.064 lb/ton  $P_2O_5$ . Using a 95-percent upper confidence limit for these data, a limit of 0.06 lb/ton  $P_2O_5$  is proposed for the South AP Plant, and 0.045 lb/ton  $P_2O_5$  for MAP and 0.0417 lb/ton  $P_2O_5$  for DAP is proposed for the North AP Plant, based on the existing control technology.

#### **5.4 SOUTH AND NORTH AP PLANTS—NITROGEN OXIDES**

##### **5.4.1 PROPOSED CONTROL TECHNOLOGY**

Emissions of  $NO_x$  from the South and North AP Plants will occur from the dryers due to fuel combustion. The proposed BACT for  $NO_x$  is based on good combustion practices and low nitrogen fuel. The proposed maximum  $NO_x$  emissions for the South and North AP Plants are 12.60 lb/hr or 55.17 TPY; and 7.41 lb/hr or 32.44 TPY, respectively. These are equivalent to 0.21 lb/MMBtu and 0.15 lb/MMBtu for the South and North AP Plants, respectively, based on the worst-case fuel.

A condition of Title Permit No. 1050053-037-AV for the North MAP/DAP Plant was a requirement for an initial compliance test for  $NO_x$ . The testing data, which was performed in 2000, is presented in Table 5-9. The  $NO_x$  test results for the North AP Plant were 0.41 lb/hr and 0.00 lb/hr for MAP and DAP mode, respectively.

##### **5.4.2 BACT ANALYSIS**

###### **5.4.2.1 Previous BACT Determinations**

As part of the BACT analysis, a review was performed of previous  $NO_x$  BACT determinations for GTSP, MAP, and DAP manufacturing facilities listed in the RACT/BACT/LAER Clearinghouse on EPA's web page. There have only been two BACT determinations made for  $NO_x$  from GTSP, MAP, and DAP manufacturing facilities in the past 10 years. These determinations are presented in Table 5-10.

From the review of the previous BACT determinations, it is evident that NO<sub>x</sub> BACT determinations for GTSP, MAP, and DAP manufacturing facilities have relied on good combustion practices without any control equipment. The BACT determination for IMC-Agrico from 1998 was based on 12.6 lb/hr of NO<sub>x</sub>. The BACT determination for Mosaic Riverview from 2001 was based on good combustion practices and did not include an emission limit.

#### **5.4.2.2 Control Technology Feasibility**

The control technology feasibility analysis for NO<sub>x</sub> controls for the AP Plant dryers are shown in Table 5-11. As shown in the table, there are five types of NO<sub>x</sub> abatement methods with various techniques of each method. Each available technique was listed with its associated efficiency estimate, identified as feasible or infeasible, and ranked based on control efficiency.

#### **5.4.2.3 Potential Control Method Descriptions**

##### ***Removal of Nitrogen***

**Ultra-Low Nitrogen Fuel** -- The fuels combusted in the dryers at the South and North AP Plants will be No. 2 fuel oil and natural gas. Liquefied petroleum gas (LPG) may also be combusted in the South AP Plant. Combustion of these fuels results in emissions of NO<sub>x</sub> that are lower than conventional fuels due to the characteristically low levels of nitrogen associated with these fuels. Mosaic Green Bay will control NO<sub>x</sub> emissions from the dryers through the use of low-nitrogen content fuels.

##### ***Oxidation of NO<sub>x</sub> with Subsequent Absorption***

**Inject Oxidant** -- The oxidation of nitrogen to its higher valence states makes NO<sub>x</sub> soluble in water. When this is done a gas absorber can be effective. Oxidants that have been injected into the gas stream are ozone, ionized oxygen, or hydrogen peroxide. This NO<sub>x</sub> reduction technique has not been demonstrated on this type of process, and as such is not considered to be a proven technique for the AP Plant dryers.

**Non-Thermal Plasma Reactor (NTPR)** -- This technique generates electron energies in the gas stream that generate gas-phased radicals, such as hydroxyl (OH) and atomic oxygen (O) through collision of electrons with water and oxygen molecules present in the flue gas stream. In the flue gas stream, these radicals oxidize NO<sub>x</sub> to form nitric acid (HNO<sub>3</sub>), which can then be condensed out through a wet condensing precipitator. NTPR has not been demonstrated on this type of application, and as such is not considered to be a proven technique for the AP Plant dryers.



***Chemical Reduction of NO<sub>x</sub>***

**Selective Catalytic Reduction (SCR)** -- SCR uses a catalyst to react injected ammonia to chemically reduce NO<sub>x</sub>. The catalyst has a finite life in flue gas and some ammonia slips through without being reacted. SCR has historically used precious metal catalysts, but can now also use base metal and zeolite catalyst materials. High-moisture-content flue gases can cause problems with catalyst operation. An SCR requires a flue gas temperature of 600 to 1,000 degrees Fahrenheit (°F). The flue gases exiting the AP Plant dryers contain high moisture levels, particulate, ammonium compounds, and F. The gas temperature is about 200°F leaving the dryer. The high moisture content of the air stream and the high flue gas temperature requirement excludes SCR as an option for NO<sub>x</sub> control for the South and North AP Plant dryers.

**Selective Non-Catalytic Reduction (SNCR)** -- In SNCR, ammonia or urea is injected within the boiler or in ducts in a region where the temperature is between 1,650 and 2,010°F. This technology is based on temperature ionizing the ammonia or urea instead of using a catalyst or non-thermal plasma. The temperature window for SNCR is very important because outside of it either more ammonia slips through the system or more NO<sub>x</sub> is generated than is being chemically reduced. SNCR has been demonstrated as a feasible technology for natural gas and fuel oil combustion and can achieve NO<sub>x</sub> reductions up to 50 percent. The high flue gas temperature requirement also excludes SNCR as an option for NO<sub>x</sub> control for the South and North AP Plant dryers.

**Catalytic Absorption (SCONO<sub>x</sub>)** -- SCONO<sub>x</sub>, unlike SCR, also removes other pollutants such as CO and VOC, while simultaneously absorbing NO<sub>x</sub> on a propriety catalyst sorber. This sorber is periodically regenerated using a superheated steam/dilute hydrogen gas mixture which is produced on site and in an automated "on demand" basis, using the same fuel utilized by the turbine. The regeneration process results in the chemical reduction of NO<sub>x</sub> compounds which remain on the catalyst and are essential to its chemistry. The SCONO<sub>x</sub> system is applicable to natural gas-fired combined cycle turbines using water injection. The performance of the system is sensitive to sulfur in the flue gas and requires periodic regeneration with dilute hydrogen. SCONO<sub>x</sub> requires a flue gas temperature between 450 and 700°F. Operation at temperatures as low as 300°F is possible with additional equipment and process changes. Since this technology has only been applied to gas turbines, it is considered an unproven technology for the AP Plant dryers. Another issue is the temperature requirement flue gas. Therefore, SCONO<sub>x</sub> is excluded as an option for the AP Plant dryers.

### ***Reducing Residence Time at Peak Temperature***

**Air Staging of Combustion** -- Combustion air is divided into two streams. The first stream is mixed with fuel in a ratio that produces a reducing flame. The second stream is injected downstream of the flame and creates an oxygen-rich zone. This NO<sub>x</sub> reduction technique is already utilized by the AP Plant dryers.

**Fuel Staging of Combustion** -- This is staging of combustion using fuel instead of air. Fuel is divided into two streams. The first stream feeds primary combustion that operates in a reducing fuel-to-air ratio. The second stream is injected downstream of primary combustion, causing the net fuel to air ratio to be slightly oxidizing. Excess fuel in the primary combustion zone dilutes heat to reduce temperature. The second stream oxidizes the fuel while reducing the NO<sub>x</sub> to N<sub>2</sub>. This NO<sub>x</sub> reduction technique may not be possible with an existing dryer. This would alter the temperature profile and affect the drying of the product. Therefore, this technique is not considered technically feasible for the AP Plant dryers.

**Inject Steam** -- Injection of steam causes the stoichiometry of the mixture to be changed and dilutes calories generated by combustion. These actions cause combustion temperature to be lower, and in turn reduces the amount of thermal NO<sub>x</sub> formed. This technique would not be possible with this type of dryer. Injecting steam would affect the product. Therefore, this NO<sub>x</sub> reduction technique is not considered technically feasible for the AP Plant dryers.

### ***Reducing Peak Temperature***

**Flue Gas Recirculation (FGR)** -- Recirculation of cooled flue gas reduces combustion temperature by diluting the oxygen content of the combustion air and by causing heat to be diluted in a greater mass of flue gas. Heat in the flue gas can be recovered by a heat exchanger. This reduction of temperature lowers the thermal NO<sub>x</sub> concentration that is generated. Although technically feasible, this NO<sub>x</sub> reduction technique would affect the dryer operation. Therefore, FGR is excluded as a NO<sub>x</sub> control technique for the AP Plant dryers.

**Reburn** -- In a boiler outfitted with reburn technology, a set of natural gas burners are installed above the primary combustion zone. Natural gas is injected to form a fuel-rich, oxygen-deficient combustion zone above the main firing zone. Nitrogen oxides, created by the combustion process in the main portion of the boiler, drift upward into the reburn zone and are converted to molecular nitrogen. The technology requires no catalysts, chemical reagents, or changes to any existing burners.

Typical reburn systems also incorporate redesign of the combustion air system to provide less excess air (LEA). Although technically feasible, this NO<sub>x</sub> reduction technique would affect the dryer operation. Therefore, reburn is excluded as a NO<sub>x</sub> control technique for the AP Plant dryers.

**Over-Fire Air (OFA)** -- When primary combustion uses a fuel-rich mixture, use of OFA completes the combustion. Because the mixture is always off-stoichiometric when combustion is occurring, the temperature is reduced. After all other stages of combustion, the remainder of the fuel is oxidized in the OFA. Although technically feasible, this NO<sub>x</sub> reduction technique would affect the dryer operation. Therefore, OFA is excluded as a NO<sub>x</sub> control technique for the AP Plant dryers.

**Less Excess Air (LEA)** -- Excess airflow combustion has been correlated to the amount of NO<sub>x</sub> generated. Limiting the net excess airflow can limit NO<sub>x</sub> content of the flue gas. Although technically feasible, this NO<sub>x</sub> reduction technique would affect the dryer operation. Therefore, LEA is excluded as a NO<sub>x</sub> control technique for the AP Plant dryers.

**Combustion Optimization** -- Combustion optimization refers to the active control of combustion. The active combustion control measures seek to find optimum combustion efficiency and to control combustion at that efficiency. The AP Plant dryers at Mosaic Green Bay will be optimized for maximum combustion efficiency.

**Low NO<sub>x</sub> Burners (LNB)** -- A LNB provides a stable flame that has several different zones. For example, the first zone can be primary combustion. The second zone can be Fuel Reburning (FR) with fuel added to chemically reduce NO<sub>x</sub>. The third zone can be the final combustion in low excess air to limit the temperature.

#### 5.4.2.4 Environmental Impacts

As shown in Tables 6-16, 6-18 and 6-19, the maximum predicted NO<sub>2</sub> impacts are below the AAQS and PSD Class II increment levels, and insignificant at the PSD Class I area. Additional NO<sub>x</sub> controls would result in insignificant reduction of ambient impacts that are already below the AAQS and PSD Class I and Class II increment levels.

#### 5.4.3 BACT SELECTION

The only demonstrated control techniques for controlling NO<sub>x</sub> emissions from this type of process are good combustion practices. Mosaic is proposing to use good combustion practices along with low-

nitrogen fuel to achieve NO<sub>x</sub> control. Any different control equipment would significantly alter the existing dryer operation at Mosaic Green Bay. From the test data that was presented in Table 5-9 and the actual emission data presented in Section 2.0 from the AORs, it is evident that Mosaic is achieving extremely low NO<sub>x</sub> emission levels with the use of good combustion practices. Therefore, no further controls are justified. In conclusion, the use of good combustion practices and low nitrogen fuel constitutes BACT for the AP Plant dryers.

Table 5-1. Summary of BACT Determinations for Particulate Emissions from GTSP, MAP, and DAP Manufacturing Facilities

Company Name	State	Permit Number	Permit Issue Date	Throughput	Emission Limits	Control Equipment
MOSAIC FERTILIZER--RIVERVIEW	FL	PSD-FL-336	3/16/2004	4478 TPD AP	0.15 LB/TON P <sub>2</sub> O <sub>5</sub>	VENTURI SCRUBBER (Medium Energy)
MOSAIC FERTILIZER--BARTOW	FL	PSD-FL-322	3/20/2002	261 TPH	0.15 LB/TON P <sub>2</sub> O <sub>5</sub>	SCRUBBERS--2 VENTURI & 1 CROSS-FLOW
US AGRI-CHEMICALS--FT. MEADE	FL	PSD-FL-321	3/15/2002	60 TPH	0.17 LB/TON P <sub>2</sub> O <sub>5</sub>	VENTURI SCRUBBER
MOSAIC FERTILIZER--RIVERVIEW	FL	PSD-FL-315	11/21/2001	73.5 TPH P <sub>2</sub> O <sub>5</sub>	0.17 LB/TON P <sub>2</sub> O <sub>5</sub>	3 VENTURI SCRUBBERS
MOSAIC FERTILIZER--BARTOW	FL	PSD-FL-255	4/21/1999	125 TPH	0.18 LB/TON P <sub>2</sub> O <sub>5</sub>	VENTURI SCRUBBER W/CYCLONE
US AGRI-CHEMICALS	FL	PSD-FL-222	10/16/1998	60 TPH MAP	0.40 LB/TON P <sub>2</sub> O <sub>5</sub>	MED. ENERGY VENTURI SCRUBBER USING NEUTRALIZED SCRUBBING WATER
FARMLAND HYDRO L.P. (NOW MOSAIC GREEN BAY)	FL	PSD-FL-246	9/11/1998	200 TPH MAP	0.30 LB/TON P <sub>2</sub> O <sub>5</sub>	2-STAGE SCRUBBERS USING ACID PONDWATER
MOSAIC PHOSPHATES CO.	FL	PSD-FL-241	1/21/1998	150 TPH DAP	0.30 LB/TON P <sub>2</sub> O <sub>5</sub>	2-STAGE SCRUBBERS USING ACID PONDWATER
				80 TPH	0.156 LB/TON P <sub>2</sub> O <sub>5</sub>	VENTURI/PACKED BED SCRUBBER

Notes: GTSP = Granular Triple Super Phosphate.

MAP= Monoammonium Phosphate.

DAP= Diammonium Phosphate.

MOSAIC Fertilizer facilities are now owned by Mosaic Fertilizers, LLC.

Reference: RACT/BACT/LAER Clearinghouse on EPA's Webpage, 2005.

Table 5-2. PM/PM<sub>10</sub> Control Technology Feasibility Analysis for the South and North AP Plants, Mosaic Green Bay

PM Abatement Method	Technique Now Available	Estimated Efficiency	Feasible and Demonstrated? (Y/N)	Rank Based on Control Efficiency	Employed by the AP Plants? (Y/N)
Fuel Techniques	Fuel Substitution	NA	NTF	NTF	N
Pretreatment	Settling Chambers	< 10%	NTF	NTF	N
	Elutriators	< 10%	NTF	NTF	N
	Momentum Separators	10 - 20%	NTF	NTF	N
	Mechanically-Aided Separators	20 - 30%	NTF	NTF	N
	Cyclones	60 - 90%	Y	3	Y
Electrostatic Precipitators (ESP)	Dry ESP	>99%	N	NA	N
	Wet ESP	>99%	N	NA	N
	Wire-Plate ESP	>99%	N	NA	N
	Wire-Pipe ESP	>99%	N	NA	N
Fabric Filters	Shaker-Cleaned	>99%	NTF	NTF	N
	Reverse-Air	>99%	NTF	NTF	N
	Pulse-Jet	>99%	NTF	NTF	N
Wet Scrubbers	Venturi	50 - 99 %	Y	1	Y
	Spray Chambers	50 - 95 %	Y	2	N
	Impingement Plate	50 - 95 %	N	NA	N
	Mechanically-Aided	50 - 95 %	N	NA	N
	Orifice	50 - 95 %	N	NA	N
	Condensation	50 - 95 %	N	NA	N
	Packed-Bed	50 - 90 %	Y	4	N

Note: NTF = Not Technically Feasible  
NA = Not Applicable

Table 5-3. Cost Analysis for Adding Venturi Scrubbers for PM Control, South and North AP Plants, Mosaic Green Bay

Cost Items	Cost Factors <sup>a</sup>	Cost Per Plant (\$)		Total
		South Plant (new)	North Plant (new)	
<b>DIRECT CAPITAL COSTS (DCC):</b>				
Purchased Equipment Cost (PEC)				
R/G Scrubber	Mosaic Green Bay Estimate <sup>b</sup>	1,837,641	1,837,641	--
Dryer Scrubber	Mosaic Green Bay Estimate <sup>b</sup>	580,004	602,609	--
Screens and Mills Scrubbebr	Mosaic Green Bay Estimate <sup>b</sup>	671,361	792,469	--
Cooler Scrubber Ventura and Fan	Mosaic Green Bay Estimate <sup>b</sup>	179,202	483,727	--
Freight	5%	42,528	63,810	--
Taxes	6%	51,034	76,572	--
<b>Total PEC:</b>		<b>3,361,770</b>	<b>3,856,828</b>	<b>7,218,598</b>
Direct Installation Costs				
Total Installation	Mosaic Green Bay Estimate <sup>b</sup>	1,379,717	924,937	--
Demolition	Mosaic Green Bay Estimate <sup>b</sup>	610,269	418,418	--
Electrical	Mosaic Green Bay Estimate <sup>b</sup>	521,207	433,363	--
<b>Total Direct Installation Costs</b>		<b>2,511,193</b>	<b>1,776,719</b>	<b>4,287,912</b>
<b>Total DCC:</b>		<b>5,872,963</b>	<b>5,633,546</b>	<b>11,506,509</b>
<b>INDIRECT CAPITAL COSTS (ICC):</b>				
Contractor Fees	10% of PEC	336,177	385,683	--
Performance test	1% of PEC	33,618	38,568	--
Contingencies	20% of PEC, OAQPS Retrofit Cost Factor	672,354	771,366	--
<b>Total ICC:</b>		<b>1,042,149</b>	<b>1,195,617</b>	<b>2,237,765</b>
<b>TOTAL CAPITAL INVESTMENT (TCI):</b>	<b>DCC + ICC</b>	<b>6,915,112</b>	<b>6,829,163</b>	<b>13,744,275</b>
<b>DIRECT OPERATING COSTS (DOC):</b>				
(1) Operating Labor				
Operator	16 hours/week, \$16/hr, 26 weeks/yr	6,656	6,656	--
Supervisor	15% of operator cost	998	998	--
(2) Maintenance	Engineering estimate, 1% PEC	33,618	38,568	--
(3) Electricity - Fan	\$0.06/kWh, 7,340 hr/yr	461,778	315,184	--
<b>Total DOC:</b>		<b>503,051</b>	<b>361,407</b>	<b>864,458</b>
<b>INDIRECT OPERATING COSTS (IOC):</b>				
Overhead	60% of oper. labor & maintenance	24,763	27,734	--
Property Taxes	1% of total capital investment	69,151	68,292	--
Insurance	1% of total capital investment	69,151	68,292	--
Administration	2% of total capital investment	138,302	136,583	--
<b>Total IOC:</b>		<b>301,368</b>	<b>300,900</b>	<b>602,268</b>
<b>CAPITAL RECOVERY COSTS (CRC):</b>	<b>CRF of 0.0944 times TCI (20 yrs @ 7%)</b>	<b>652,787</b>	<b>644,673</b>	<b>1,297,460</b>
<b>ANNUALIZED COSTS (AC):</b>	<b>DOC + IOC + CRC</b>	<b>1,457,205</b>	<b>1,306,980</b>	<b>2,764,185</b>
<b>BASELINE PM EMISSIONS (TPY) :</b>		<b>50.4</b>	<b>134.8</b>	
<b>MAXIMUM PM EMISSIONS (TPY) :</b>	<b>0.15 lb/ton P<sub>2</sub>O<sub>5</sub></b>	<b>30.2</b>	<b>69.7</b>	
<b>REDUCTION IN PM EMISSIONS (TPY):</b>		<b>20.2</b>	<b>65.1</b>	<b>85.3</b>
<b>COST EFFECTIVENESS:</b>	<b>\$ per ton of PM Removed</b>			<b>\$32,417</b>

Footnotes:

<sup>a</sup> Unless otherwise specified, factors and cost estimates reflect OAQPS Cost Manual, Section 3, Sixth edition.

<sup>b</sup> Mosaic Green Bay estimates made in 2003 have been upgraded to 2005 dollars using the Producers Price Index obtained from the Bureau of Labor Statistics, U.S. Department of Labor for Phosphatic Fertilizer Manufacturing.

Table 5-4. Summary of Recent South AP Plant Emission Tests at Mosaic Green Bay

Date	Run	Average Production Rate <sup>a</sup> (tons/hr)	Average Process Rate <sup>b</sup> (tons/hr)	PM <sup>c</sup>		Fluoride <sup>c</sup>	
				avg lb/hr	avg lb/ton <sup>b</sup>	avg lb/hr	avg lb/ton <sup>b</sup>
4/20/05-4/21/05	Run 1	-- (MAP)	43.9	7.9	0.180	1.91	0.0435
	Run 2	-- (MAP)	43.9	8.5	0.193	1.83	0.0416
	Run 3	-- (MAP)	43.9	6.7	0.153	1.84	0.0419
4/19/05-4/20/05	Run 1	-- (MAP)	43.7	5.6	0.128	2.23	0.0510
	Run 2	-- (MAP)	43.7	5.8	0.132	2.41	0.0553
	Run 3	-- (MAP)	43.7	5.7	0.131	1.97	0.0451
3/25/04-3/26/04	Run 1	-- (DAP)	42.5	7.5	0.175	0.63	0.0149
	Run 2	-- (DAP)	42.5	8.2	0.192	1.16	0.0274
	Run 3	-- (DAP)	42.5	7.1	0.166	0.80	0.0189
9/11/03	Run 1	72 (DAP)	33.2	3.8	0.116	0.55	0.0166
	Run 2	72 (DAP)	33.2	1.8	0.053	0.64	0.0192
	Run 3	72 (DAP)	33.2	2.6	0.079	0.87	0.0262
3/13/2002	Run 1	72 (DAP)	43.6	18.7	0.428 <sup>d</sup>	1.78	0.0408
	Run 2	72 (DAP)	43.6	21.6	0.496 <sup>d</sup>	2.54	0.0583
	Run 3	72 (DAP)	43.6	20.3	0.465 <sup>d</sup>	2.98	0.0683
3/20/01	Run 1	-- (DAP)	41.5	11.0	0.265	2.16	0.0520
	Run 2	-- (DAP)	41.5	4.4	0.106	1.82	0.0437
	Run 3	-- (DAP)	41.5	5.7	0.136	1.86	0.0449
3/8/00-3/9/00	Run 1	88 (DAP)	40.6	4.3	0.106	1.14	0.0281
	Run 2	88 (DAP)	40.6	2.9	0.072	1.87	0.0461
	Run 3	88 (DAP)	40.6	4.7	0.116	1.23	0.0304
3/24/99-3/25/99	Run 1	87 (DAP)	40.1	6.88	0.172	6.74	0.1680 <sup>d</sup>
	Run 2	87 (DAP)	40.1	7.29	0.182	4.53	0.1130 <sup>d</sup>
	Run 3	87 (DAP)	40.1	8.28	0.207	4.98	0.1243 <sup>d</sup>
<b>Number of Runs</b>					21	21	
<b>Maximum</b>					0.265	0.068	
<b>Minimum</b>					0.053	0.015	
<b>Mean</b>					<b>0.146</b>	<b>0.039</b>	
<b>Standard Deviation</b>					0.050	0.015	
<b>95% Upper Confidence Limit for Data<sup>e</sup></b>					<b>0.251</b>	<b>0.070</b>	
Current limit MAP/DAP =					<b>0.256</b>	<b>0.06</b>	

<sup>a</sup> As MAP or DAP.<sup>b</sup> As P<sub>2</sub>O<sub>5</sub>.<sup>c</sup> Represents both stacks combined.<sup>d</sup> Data considered to be an outlier and therefore not included in statistical analysis.<sup>e</sup> Upper confidence limit with 95% probability is based on the t-distribution and calculated using the formula  $X + (t_{0.05} * s)$  where, X is mean,  $t_{0.05}$  is the t value for 95% probability and n-1 degrees of freedom, and s is standard deviation.



Table 5-5. Summary of Recent North AP Plant Emission Tests at Mosaic Green Bay

Date	Run	Average Production Rate <sup>a</sup>	Average Process Rate <sup>b</sup>	PM <sup>c</sup>		Fluoride <sup>c</sup>	
		(tons/hr)	(tons/hr)	avg lb/hr	avg lb/ton <sup>b</sup>	avg lb/hr	avg lb/ton <sup>b</sup>
9/16/2004	Run 1	117 (DAP)	62.2	6.8	0.110	1.83	0.0295
	Run 2	117 (DAP)	62.2	8.6	0.138	1.87	0.0301
	Run 3	117 (DAP)	62.2	8.8	0.141	1.41	0.0226
9/9/03-9/10/03	Run 1	78 (MAP)	41.2	2.4	0.058	0.69	0.0168
	Run 2	78 (MAP)	41.2	2.6	0.062	0.51	0.0123
	Run 3	78 (MAP)	41.2	6.3	0.153	1.01	0.0244
8/1/02-8/2/02	Run 1	164 (MAP)	81.8	11.2	0.136	2.05	0.0251
	Run 2	164 (MAP)	81.8	8.0	0.098	1.79	0.0219
	Run 3	164 (MAP)	81.8	7.7	0.094	2.28	0.0279
5/1/02-5/2/02	Run 1	-- (MAP)	43.6	11.3	0.259	1.26	0.0289
	Run 2	-- (MAP)	43.6	20.5	0.471	1.70	0.0389
	Run 3	-- (MAP)	43.6	9.7	0.224	0.83	0.0191
2/13/01-2/14/01	Run 1	106 (DAP)	48.8	3.0	0.062	0.91	0.0186
	Run 2	106 (DAP)	48.8	6.5	0.133	1.20	0.0246
	Run 3	106 (DAP)	48.8	11.1	0.227	2.15	0.0441
3/27/01-3/28/01	Run 1	171 (MAP)	85.3	7.29	0.085	2.02	0.0237
	Run 2	171 (MAP)	85.3	8.1	0.095	1.72	0.0202
	Run 3	171 (MAP)	85.3	7.0	0.082	1.99	0.0233
4/6/00-4/7/00	Run 1	98 (DAP)	45.0	1.6	0.035	0.25	0.0055
	Run 2	98 (DAP)	45	2.0	0.045	0.22	0.0050
	Run 3	98 (DAP)	45	5.5	0.122	0.35	0.0079
3/16/00-3/17/00	Run 1	147 (MAP)	76.6	27.7	0.361	2.59	0.0338
	Run 2	147 (MAP)	76.6	9.7	0.126	0.52	0.0067
	Run 3	147 (MAP)	76.6	13.7	0.179	0.53	0.0069
3/31/99-4/1/99	Run 1	-- (DAP)	62.5	6.8	0.108	1.03	0.0164
	Run 2	-- (DAP)	62.5	6.4	0.103	0.80	0.0128
	Run 3	-- (DAP)	62.5	7.0	0.112	0.89	0.0142
3/17/99-3/18/99	Run 1	-- (DAP)	43.7	1.5	0.033	0.96	0.0220
	Run 2	-- (DAP)	43.7	2.7	0.061	0.61	0.0139
	Run 3	-- (DAP)	43.7	1.9	0.045	0.55	0.0126
1/20/99-1/21/99	Run 1	-- (DAP)	43.3	4.9	0.113	0.65	0.0149
	Run 2	-- (DAP)	43.3	7.3	0.170	0.73	0.0168
	Run 3	-- (DAP)	43.3	3.1	0.071	0.31	0.0071
4/12/99-4/14/99	Run 1	-- (MAP)	80.6	6.3	0.078	1.99	0.0246
	Run 2	-- (MAP)	80.6	6.4	0.079	1.32	0.0164
	Run 3	-- (MAP)	80.6	7.7	0.096	2.59	0.0321
6/30/99-7/2/99	Run 1	-- (MAP)	73.2	7.5	0.103	2.34	0.0320
	Run 2	-- (MAP)	73.2	7.1	0.097	4.70	0.0642
	Run 3	-- (MAP)	73.2	6.0	0.082	0.88	0.0121
10/26/99-10/27/99	Run 1	-- (MAP)	71.3	10.5	0.148	1.78	0.0250
	Run 2	-- (MAP)	71.3	9.8	0.137	1.91	0.0268
	Run 3	-- (MAP)	71.3	6.9	0.097	1.72	0.0241
<b>Number of Runs</b>						42	
<b>Maximum</b>						0.471	
<b>Minimum</b>						0.033	
<b>Mean</b>						<b>0.124</b>	
<b>Standard Deviation</b>						0.083	
<b>95% Upper Confidence Limit for Data<sup>d</sup></b>						<b>0.293</b>	
				Current limit MAP =		<b>0.30</b>	
				Current limit DAP =		<b>0.30</b>	

<sup>a</sup> As MAP or DAP.

<sup>b</sup> As P<sub>2</sub>O<sub>5</sub>.

<sup>c</sup> Represents both stacks combined.

<sup>d</sup> Upper confidence limit with 95% probability is based on the t-distribution and calculated using the formula  $X + (t_{0.05} * s)$  where, X is mean,  $t_{0.05}$  is the t value for 95% probability and n-1 degrees of freedom, and s is standard deviation.

Table 5-6. Summary of BACT Determinations for Fluoride Emissions from GTSP, MAP, and DAP Manufacturing Facilities

Company Name	State	Permit Number	Permit Issue Date	Throughput	Emission Limits	Control Equipment
MOSAIC FERTILIZER--RIVERVIEW	FL	PSD-FL-336	3/16/2004	4478 TPD AP	0.035 LB/TON P <sub>2</sub> O <sub>5</sub>	VENTURI SCRUBBER
MOSAIC FERTILIZER--BARTOW	FL	PSD-FL-322	3/20/2002	261 TPH	0.04 LB/TON P <sub>2</sub> O <sub>5</sub>	CROSS-FLOW PACKED TOWER SCRUBBER
US AGRI-CHEMICALS	FL	PSD-FL-321	3/15/2002	60 TPH	0.037 LB/TON P <sub>2</sub> O <sub>5</sub>	VENTURI SCRUBBER
MOSAIC FERTILIZER--RIVERVIEW	FL	PSD-FL-315	11/21/2001	73.5 TPH P <sub>2</sub> O <sub>5</sub>	0.04 LB/TON P <sub>2</sub> O <sub>5</sub>	2 TAILGAS SCRUBBERS
MOSAIC FERTILIZER--BARTOW	FL	PSD-FL-255	4/21/1999	125 TPH	0.041 LB/TON P <sub>2</sub> O <sub>5</sub>	PACKED SCRUBBER USING POND WATER
US AGRI-CHEMICALS	FL	PSD-FL-222	10/16/1998	49 TPH MAP	0.019 LB/TON P <sub>2</sub> O <sub>5</sub> *	MED. ENERGY VENTURI USING NEUTR. SCRUBBING WATER
FARMLAND HYDRO L.P. (NOW MOSAIC GREEN BAY)	FL	PSD-FL-246	9/11/1998	200 TPH MAP	0.06 LB/TON P <sub>2</sub> O <sub>5</sub>	2-STAGE SCRUBBERS USING ACID/POND WATER
				150 TPH DAP	0.0417 LB/TON P <sub>2</sub> O <sub>5</sub>	2-STAGE SCRUBBERS USING ACID/POND WATER
MOSAIC PHOSPHATES CO	FL	PSD-FL-241	1/21/1998	80 TPH	0.0417 LB/TON P <sub>2</sub> O <sub>5</sub>	VENTURI SCRUBBER AND PACKED BED SCRUBBER

Reference: RACT/BACT/LAER Clearinghouse on EPA's Webpage, 2005.

Note: MOSAIC Fertilizer facilities are now owned by Mosaic Fertilizer, LLC.

\* For a prilled MAP plant, not granular MAP.

Table 5-7. Fluoride Control Technology Feasibility Analysis for the Ammoniated Phosphate Fertilizer Plants at Mosaic Green Bay

F Abatement Method	Technique Now Available	Estimated Efficiency	Feasible and Demonstrated? (Y/N)	Rank Based on Control Efficiency	Employed by the AP Plants? (Y/N)
Wet Scrubbers	Packed Tower	95-99%	Y	1	N
	Wet Cyclonic	90-95%	Y	2	Y
	Orifice (impingement) Tray	95-99%	N	NA	N
	Spray Chamber	90-95%	Y	2	Y
	Venturi	90-95%	Y	2	Y
	Ammonia Vaporizer	95-99%	Y	1	Y

Note: NTF = Not Technically Feasible  
NA = Not Applicable

Table 5-8. Cost Analysis for Additional Controls for Fluoride Removal, South and North AP Plants, Mosaic Green Bay

Cost Items	Cost Factors <sup>a</sup>	Cost Per Plant (\$)		
		South Plant	North Plant	Total
<b>DIRECT CAPITAL COSTS (DCC):</b>				
Purchased Equipment Cost (PEC)				
Ammonia Vaporizer Scrubber	Mosaic Green Bay Estimate <sup>b</sup>	245,700	--	--
Ammonia Vaporizer Scrubber Tank	Mosaic Green Bay Estimate <sup>b</sup>	35,100	--	--
Ammonia Vaporizer Scrubber Pump	Mosaic Green Bay Estimate <sup>b</sup>	32,500	--	--
Packed Bed Scrubber	Mosaic Green Bay Estimate <sup>b</sup>	383,903	383,903	--
Freight	5%	34,860	19,195	--
Taxes	7%	48,804	26,873	--
<b>Total PEC:</b>		<b>780,867</b>	<b>429,971</b>	<b>1,210,839</b>
Direct Installation Costs				
Total Installation (Amun. Vaporizer)	Mosaic Green Bay Estimate <sup>b</sup>	102,440	--	--
Foundation	Mosaic Green Bay Estimate <sup>b</sup>	29,120	29,120	--
Electrical	Mosaic Green Bay Estimate <sup>b</sup>	183,017	155,250	--
Structural	Mosaic Green Bay Estimate <sup>b</sup>	24,180	24,180	--
Mechanical	Mosaic Green Bay Estimate <sup>b</sup>	192,400	45,500	--
<b>Total Direct Installation Costs</b>		<b>531,157</b>	<b>254,050</b>	<b>785,207</b>
<b>Total DCC:</b>		<b>1,312,024</b>	<b>684,021</b>	<b>1,996,045</b>
<b>INDIRECT CAPITAL COSTS (ICC):</b>				
Engineering	Mosaic Green Bay Estimate <sup>b</sup>	126,407	87,412	--
Contractor Fees	10% of PEC	78,087	42,997	--
Startup/Performance test	2% of PEC	15,617	8,599	--
Contingencies	10% of PEC, OAQPS Retrofit Cost Factor	78,087	42,997	--
<b>Total ICC:</b>		<b>298,198</b>	<b>182,006</b>	<b>480,203</b>
<b>TOTAL CAPITAL INVESTMENT (TCI):</b>	<b>DCC + ICC</b>	<b>1,610,222</b>	<b>866,027</b>	<b>2,476,249</b>
<b>DIRECT OPERATING COSTS (DOC):</b>				
(1) Operating Labor				
Operator	16 hours/week, \$16/hr, 52 weeks/yr	13,312	13,312	--
Supervisor	15% of operator cost	1,997	1,997	--
(2) Maintenance	Engineering estimate, 1% PEC	7,809	4,300	--
(3) Electricity - Fan	\$0.06/kWh, 8760 hr/yr	45,854	29,491	--
<b>Total DOC:</b>		<b>68,972</b>	<b>49,100</b>	<b>118,072</b>
<b>INDIRECT OPERATING COSTS (IOC):</b>				
Overhead	60% of oper. labor & maintenance	13,870	11,765	--
Property Taxes	1% of total capital investment	16,102	8,660	--
Insurance	1% of total capital investment	16,102	8,660	--
Administration	2% of total capital investment	32,204	17,321	--
<b>Total IOC:</b>		<b>78,279</b>	<b>46,406</b>	<b>124,686</b>
<b>CAPITAL RECOVERY COSTS (CRC):</b>	<b>CRF of 0.0944 times TCI (20 yrs @ 7%)</b>	<b>152,005</b>	<b>81,753</b>	<b>233,758</b>
<b>ANNUALIZED COSTS (AC):</b>	<b>DOC + IOC + CRC</b>	<b>299,256</b>	<b>177,259</b>	<b>476,515</b>
<b>BASELINE FL EMISSIONS (TPY):</b>		<b>12.1</b>	<b>20.9</b>	
<b>MAXIMUM FL EMISSIONS (TPY):</b>	<b>0.035 lb/ton P<sub>2</sub>O<sub>5</sub></b>	<b>7.1</b>	<b>16.3</b>	
<b>REDUCTION IN FL EMISSIONS (TPY):</b>		<b>5.0</b>	<b>4.6</b>	<b>9.7</b>
<b>COST EFFECTIVENESS:</b>	<b>\$ per ton of FL Removed</b>	<b>\$59,280</b>	<b>\$38,245</b>	<b>\$49,211</b>

Footnotes:

<sup>a</sup> Unless otherwise specified, factors and cost estimates reflect OAQPS Cost Manual, Section 5, Sixth edition.

<sup>b</sup> Mosaic Green Bay 2005 estimates

Table 5-9. Summary of Recent North MAP/DAP Fertilizer Plant  
Emission Tests at Mosaic Green Bay

Date	Average Production Rate (tons/hr)	Average Process Rate <sup>a</sup> (tons/hr)	NO <sub>x</sub> (avg lb/hr)
3/17/2000	147 (MAP)	76.6	0.408
4/7/2000	98 (DAP)	45.0	0.000

<sup>a</sup> As P<sub>2</sub>O<sub>5</sub>.

Table 5-10. Summary of BACT Determinations for Nitrogen Oxide Emissions from GTSP, MAP, and DAP Manufacturing Facilities

Company Name	State	Permit Number	Permit Issue Date	Throughput	Emission Limits	Control Equipment
MOSAIC FERTILIZER INC.--RIVERVIEW	FL	PSD-FL-315	11/21/2001	170 TPH	N/A	Good combustion practices.
MOSAIC PHOSPHATES, INC.	FL	PSD-FL-241	1/21/1998	80 TPH	12.6 lb/hr	None

Reference: RACT/BACT/LAER Clearinghouse on EPA's Webpage, 2003.

Note: NA = not applicable

Table 5-11. NO<sub>x</sub> Control Technology Feasibility Analysis for the South and North AP Plant Dryers, Mosaic Green Bay

NO <sub>x</sub> Abatement Method	Technique Now Available	Estimated Efficiency	Feasible and Demonstrated? (Y/N)	Rank Based on Control Efficiency	Employed by Cargill Green Bay? (Y/N)
1. Removal of nitrogen	Ultra-Low Nitrogen Fuel	< 70%	Y	1	N
2. Oxidation of NO <sub>x</sub> with subsequent absorption.	Inject Oxidant	60 - 80%	NTF	NTF	N
	Non-Thermal Plasma Reactor (NTPR)	60 - 80%	NTF	NTF	N
3. Chemical reduction of NO <sub>x</sub>	Selective Catalytic Reduction (SCR)	35 - 80%	NTF	NTF	N
	Selective Non-Catalytic Reduction (SNCR)	35 - 80%	NTF	NTF	N
	SCONO <sub>x</sub> <sup>TM</sup>	35 - 80%	NTF	NTF	N
4. Reducing residence time at peak temperature	Air Staging of Combustion	50 - 65%	Y	2	Y
	Fuel Staging of Combustion	50 - 65%	N	NA	N
	Inject Steam	50 - 65%	N	NA	N
5. Reducing peak temperature	Flue Gas Recirculation (FGR)	15 -25%	N	NA	N
	Natural Gas Reburning (NGR)	15 -25%	N	NA	N
	Over Fire Air (OFA)	15 -25%	N	NA	N
	Less Excess Air (LEA)	15 -25%	N	NA	N
	Combustion Optimization	15 -25%	Y	3	Y
	Reduce Air Preheat	15 -25%	N	NA	N
	Low NO <sub>x</sub> Burners (LNB)	15 -25%	Y	3	N

Note: NTF = Not Technically Feasible  
 NA = Not Applicable

## 6.0 AIR QUALITY IMPACT ANALYSIS

### 6.1 GENERAL APPROACH

The general modeling approach followed EPA and FDEP modeling guidelines for determining compliance with AAQS and PSD increments. For all criteria pollutants that will be emitted in excess of the PSD significant emission rate due to a proposed project, a significant impact analysis is performed to determine whether the emission and/or stack configuration changes due to the project alone will result in predicted impacts that are in excess of the EPA significant impact levels at any location beyond the plant's restricted boundaries.

Generally, if the facility undergoing the modification is within 200 km of a PSD Class I area, then a significant impact analysis is also performed to evaluate the impact due to the project alone at the PSD Class I area. Because the Chassahowitzka NWA is a PSD Class I area that is located within 200 km of the proposed project, the maximum predicted impacts at the Chassahowitzka NWA are compared to EPA's proposed significant impact levels for PSD Class I areas. These recommended levels have never been promulgated as rules but are the currently accepted criteria for determine whether a proposed project will incur a significant impact on a PSD Class I area.

If the project-only impacts are above the significant impact levels in the vicinity of the facility, then two additional and more detailed air modeling analyses are required. The first analysis demonstrates compliance with federal and Florida ambient air quality standards (AAQS), and the second analysis demonstrates compliance with allowable PSD Class II increments.

If the project-only impacts at the PSD Class I area are above the proposed EPA PSD Class I significant impact levels, then an analysis is performed to demonstrate compliance with allowable PSD Class I impacts at the PSD Class I area. The proposed project's maximum emission increases are evaluated at the PSD Class I area to support the air quality related values (AQRV) analysis that includes an evaluation of regional haze degradation.

Generally, when using 5-years of meteorological data for the analysis, the highest annual and the highest, second-highest (HSH) short-term concentrations are compared to the applicable AAQS and allowable PSD increments. [Note that for determining compliance with the 24-hour AAQS for particulate matter only, the sixth highest predicted concentration in 5 years (i.e., H6H), instead of the HSH, is used to compare to the applicable 24-hour AAQS.]



The HSH concentration is calculated for a receptor field by:

1. Eliminating the highest concentration predicted at each receptor,
2. Identifying the second-highest concentration at each receptor, and
3. Selecting the highest concentration among these second-highest concentrations.

The HSH approach is consistent with air quality standards and allowable PSD increments, which permit a short-term average concentration to be exceeded once per year at each receptor.

To develop the maximum short-term concentrations for the proposed project, the modeling approach was divided into screening and refined phases to reduce the computation time required to perform the modeling analysis. For this study, the only difference between the two modeling phases is the density of the receptor grid spacing employed when predicting concentrations. Concentrations are predicted for the screening phase using a coarse receptor grid and a 5-year meteorological data record.

If the original screening analysis indicates that the highest concentrations are occurring in a selected area(s) of the grid and, if the area's total coverage is too vast to directly apply a refined receptor grid, then an additional screening grid(s) will be used over that area. The additional screening grid(s) will employ a greater receptor density than the original screening grid.

Refinements of the maximum predicted concentrations are typically performed for the receptors of the screening receptor grid at which the highest and/or HSH concentrations occurred over the 5-year period. Generally, if the maximum concentrations from other years in the screening analysis are within 10 percent of the overall maximum concentration, then those other concentrations are refined as well. Typically, if the highest and HSH concentrations are in different locations, concentrations in both areas are refined.

A more detailed description of the model, along with the emission inventory, meteorological data, and screening receptor grids, is presented in the following sections.

## **6.2 SIGNIFICANT IMPACT ANALYSES**

FDEP policies stipulate that the highest annual average and highest short-term (i.e., 24 hours or less) concentrations are to be compared to the applicable significant impact levels both in the vicinity of the project and at the PSD Class I area. Based on the screening modeling analysis results in the

vicinity of the project, additional modeling refinements are performed, if necessary, to obtain the maximum concentration with a receptor grid spacing of 100 meters (m) or less.

### **6.3 AAQS AND PSD CLASS II ANALYSES**

For each pollutant for which a significant impact is predicted in the vicinity of the project, AAQS and PSD Class II analyses are required. The AAQS analysis is a cumulative source analysis that evaluates whether the post-project concentrations from all sources will comply with the AAQS. All sources include the post-project source configuration at the project site, the impacts from other nearby facility sources, plus a background concentration to account for sources not included in the modeling analysis.

The PSD Class II analysis is a cumulative source analysis that evaluates whether the post-project PSD increment for all increment-affecting sources will comply with the allowable PSD Class II increments. All sources include the post-project PSD increment-affecting sources at the project site, plus the impacts from all nearby PSD increment-affecting sources at other facilities.

### **6.4 PSD CLASS I ANALYSIS**

For each pollutant for which a significant impact is predicted at the PSD Class I area, a PSD Class I analysis is required. The PSD Class I analysis is a cumulative source analysis that evaluates whether the post-project PSD increment for all increment-affecting sources within the impact distance of the PSD Class I area will comply with the allowable PSD Class I increments. All sources include the post-project PSD increment-affecting sources at the project site, plus the impacts from all PSD increment-affecting sources at other facilities that are within impact distances of the PSD Class I area.

### **6.5 MODEL SELECTION**

The Industrial Source Complex Short-term (ISCST3, Version 02035) dispersion model (EPA, 2002) was used to evaluate the pollutant impacts due to the proposed project in areas within 50-km of the proposed facility. This model is maintained by the EPA on its Internet website, Support Center for Regulatory Air Models (SCRAM), within the Technical Transfer Network (TTN). A listing of ISCST3 model features is presented in Table 6-1. The ISCST3 model is designed to calculate hourly concentrations based on hourly meteorological data (i.e., wind direction, wind speed, atmospheric stability, ambient temperature, and mixing heights). The ISCST3 model is applicable to sources located in either flat or rolling terrain where terrain heights do not exceed stack heights. These areas

are referred to as simple terrain. The model can also be applied in areas where the terrain exceeds the stack heights. These areas are referred to as complex terrain.

In this analysis, the EPA regulatory default options were used to predict all maximum impacts. The ISCST3 model can be executed in the rural or urban land use mode that affects stability dispersion coefficients, wind speed profiles, and mixing heights. Land use can be characterized based on a scheme recommended by EPA (Auer, 1978). If more than 50 percent land use within a 3-km radius around a project is classified as industrial or commercial, or high-density residential, then the urban option should be selected. Otherwise, the rural option is appropriate. Based on the land-use within a 3-km radius of the Mosaic plant site (see Figure 2-1), the rural dispersion coefficients were used in the modeling analysis. Also, since the terrain around the facility is flat to gently rolling, the simple terrain feature of the model was selected.

The ISCST3 model was used to provide maximum concentrations for the annual and 24-, 8-, 3-, and 1-hour averaging times.

For predicting maximum impacts at the Chassahowitzka NWA PSD Class I area, the California Puff (CALPUFF, Version 5.711a) modeling system was used. CALPUFF (EPA, 2002), is a Lagrangian puff model that is recommended by the FDEP, in coordination with the Federal Land Manager (FLM) for the Chassahowitzka NWA, for predicting pollutant impacts at PSD Class I areas that are beyond 50 km from a project site. A listing of CALPUFF model features is presented in Table 6-2. A more detailed discussion of the CALPUFF model is provided in Appendix C.

## **6.6 METEOROLOGICAL DATA**

Meteorological data used in the ISCST3 model to determine air quality impacts consisted of a concurrent 5-year period of hourly surface weather observations and twice-daily upper air soundings from the NWS stations at the Tampa International Airport in Tampa, Florida, and at Ruskin, Florida, respectively. The 5-year period of meteorological data was from 1991 through 1995. The NWS stations at Tampa and Ruskin are located approximately 62 and 50 km and to the west-northwest and southwest, respectively, of the Mosaic Green Bay plant site. The surface meteorological data from Tampa are assumed to be representative of the project site because both the project site and the weather station are located in similar climatological areas in west central Florida. They are, therefore, expected to experience similar weather conditions, such as frontal passages and sea-breeze fronts.

Meteorological data used with the CALPUFF model consisted of CALMET-developed meteorological data. A refined CALPUFF analysis was performed with mesoscale meteorological data for the following 3 years: 1990 with 80-km MM4 data, 1992 with 80-km MM5 data, and 1996 with 36-km MM5 data. A detailed description of the meteorological data is provided in Appendix C.

## **6.7 EMISSION INVENTORY**

### **6.7.1 SIGNIFICANT IMPACT ANALYSIS**

The PM<sub>10</sub>, NO<sub>x</sub>, and F emission rates and the physical and operational stack parameters for all project-affected sources are summarized in Tables 6-3 to 6-4. These tables are based on emissions and stack parameters presented in Section 2.0. The current actual and future potential PM<sub>10</sub>, NO<sub>x</sub>, and F emissions for all Mosaic sources affected by the project are presented in Table 6-3. The bases of the emissions are also provided in Table 6-3. The current and future stack and operating parameters for all Mosaic sources are included in Table 6-4.

A summary of the future potential PM<sub>10</sub> and NO<sub>x</sub> emission rates for all Mosaic sources that were used in the AAQS and PSD Class II increment analyses is presented in Table 6-5. The bases of the emissions is also provided in Table 6-5.

All sources were modeled at locations that are relative to the location of the southwest corner of the MAP/DAP storage building.

### **6.7.2 AAQS AND PSD CLASS II ANALYSES**

A listing of background PM<sub>10</sub> and NO<sub>x</sub> sources and their locations relative to the Mosaic Green Bay facility is provided in Tables 6-6 and 6-7, respectively. All facilities were evaluated using the North Carolina screening technique. Based on this technique, facilities whose annual (i.e., tons per year) emissions are less than the threshold quantity, Q, are eliminated from the modeling analysis. Q is equal to  $20 \times (D-SIA)$ , where D is the distance in km from the facility to Mosaic Green Bay and SIA is the distance of the proposed project's PM<sub>10</sub> or NO<sub>x</sub> significant impact area (5.0 and 2.0 km, respectively). The PM<sub>10</sub> and NO<sub>x</sub> facilities that were not eliminated in the screening analysis are included in the AAQS and/or PSD Class II analyses.

Summaries of the PM<sub>10</sub> and NO<sub>x</sub> background source data that were used for the AAQS and/or PSD Class II analyses are presented in Appendix B.

Non-Mosaic PM<sub>10</sub> and NO<sub>x</sub> PSD sources were obtained from FDEP and were supplemented with current and historical information obtained from Golder.

### **6.7.3 MOSAIC GREEN BAY PSD BASELINE INVENTORY FOR 1974**

A summary of Mosaic's PM<sub>10</sub> sources for the PSD baseline year of 1974 is provided in Table 6-8. These sources were used with Mosaic's future PM<sub>10</sub> sources from Table 6-5 to determine the PSD increment consumption after completion of the proposed project.

### **6.7.4 MOSAIC GREEN BAY PSD BASELINE INVENTORY FOR 1988**

A summary of Mosaic's NO<sub>x</sub> sources for the PSD baseline year of 1988 is provided in Table 6-9. These sources were used with Mosaic's future NO<sub>x</sub> sources from Table 6-5, to determine the PSD increment consumption after completion of the proposed project.

### **6.7.5 PSD CLASS I ANALYSIS**

The proposed project's PM<sub>10</sub> and NO<sub>2</sub> impacts were predicted to not exceed any significant impact level at the Chassahowitzka NWA PSD Class I area. Therefore, a PSD Class I increment consumption analysis was not required for either pollutant. However, the proposed project's emissions of PM<sub>10</sub> and F were evaluated at the Class I area to support the AQRV analysis, and emissions of SO<sub>2</sub>, PM<sub>10</sub>, SAM, and NO<sub>x</sub> were evaluated at the Class I area in support of the regional haze analysis. The increase in SO<sub>2</sub> and SAM emissions due to the proposed project, for use in the regional haze analysis, is presented in Table 6-10. The AQRV and regional haze analysis are presented in Section 7.0.

## **6.8 RECEPTOR LOCATIONS**

### **6.8.1 SITE VICINITY**

A screening receptor grid comprised of Cartesian receptors was developed that consisted of the following:

- Property boundary receptors, spaced at 100-m intervals;
- Receptors from the property boundary to 2 km, spaced at 100-m intervals;
- Receptors from 2 to 5 km, spaced at 250-m intervals; and
- Receptors from 5 to 10 km, spaced at 500 m intervals.

The modeling origin of the receptor grid was the southwestern corner of the MAP/DAP Storage Building and all source and receptor locations are relative to this location. A summary of the property boundary receptors is presented in Table 6-11.

The receptor locations in the vicinity of the plant, as well as the current sources and building locations are shown in Figures 6-1 and 6-2. Based on the results of the significant impact analyses, a maximum receptor distance of 5 km was used for the PM<sub>10</sub> AAQS and PSD Class II analyses, and a distance of 2 km was used for the NO<sub>x</sub> AAQS and PSD Class II analyses.

### **6.8.2 CLASS I AREA**

Maximum PM<sub>10</sub>, NO<sub>x</sub>, and F concentrations were predicted at the Chassahowitzka NWA with the CALPUFF model using 58 discrete receptors located along the border of the Chassahowitzka NWA PSD Class I area. Impacts for the proposed project only were compared to both the proposed EPA PSD Class I significance levels for PM<sub>10</sub> and NO<sub>x</sub>, the regional haze degradation criteria of 5 percent, and the nitrogen and sulfur deposition analysis thresholds of 0.01 kilogram per hectare per year. The F impacts were used to assess the proposed project's impacts on the Chassahowitzka NWA AQRVs. A listing of Class I receptors is provided in Table 6-12.

### **6.9 BACKGROUND CONCENTRATIONS**

To estimate total air quality concentrations in the site vicinity, a background concentration must be added to the AAQS modeling results. The background concentration is considered to be the air quality concentration contributed by sources not included in the modeling evaluation.

The derivation of the background concentration for the modeling analysis was presented in Section 4.0. Based on this analysis, the annual NO<sub>2</sub> background concentration was determined to be 20 µg/m<sup>3</sup> for the annual averaging period. The PM<sub>10</sub> background concentrations were determined to be 21 and 50 µg/m<sup>3</sup> for the annual and 24-hour averaging periods, respectively. These background levels were added to model-predicted concentrations to estimate total air quality levels for comparison to AAQS.

### **6.10 BUILDING DOWNWASH EFFECTS**

All significant building structures within Mosaic's existing plant area were determined by a site plot plan. The plot plan of the proposed project was presented in Section 2.0 (Figure 2-2). A total of 14 current and 9 structures for the baseline year of 1974 were evaluated. Several of the future

structures were storage tanks that are in the immediate vicinity of stack vents. All structures were processed in the EPA Building Input Profile (BPIP, Version 04274) program to determine direction-specific building heights and projected widths for each 10-degree azimuth direction for each source that was included in the modeling analysis. A listing of dimensions for each structure is presented in Table 6-13.

## **6.11 MODEL RESULTS**

### **6.11.1 SIGNIFICANT IMPACT ANALYSIS**

A summary of the predicted maximum PM<sub>10</sub> and NO<sub>2</sub> concentrations due to the proposed project only from the screening analysis are presented in Table 6-14. The modeling results indicate that the maximum predicted concentrations are above the significant impact levels for both pollutants. It was further determined that the significant impact areas for PM<sub>10</sub> and NO<sub>2</sub> are 5.0 and 2.0 km, respectively. As a result, detailed modeling analyses were performed for PM<sub>10</sub> and NO<sub>x</sub> to address compliance with AAQS and PSD Class II increments.

### **6.11.2 AAQS ANALYSIS**

A summary of the maximum annual and H6H 24-hour average PM<sub>10</sub> and maximum annual NO<sub>2</sub> concentrations predicted for all sources for the screening analysis is presented in Table 6-15. Based on the screening analysis results, maximum annual concentrations of PM<sub>10</sub> and NO<sub>x</sub> occurred in locations covered with dense 100-m-spaced receptors and additional modeling refinements were not required. Similarly, the H6H 24-hour average PM<sub>10</sub> impact occurred in a location modeled with dense 100-m-spaced receptors and additional modeling refinements were not required. The final results of the modeling analysis are presented in Table 6-16 where they are compared to the AAQS.

The predicted total annual and H6H 24-hour PM<sub>10</sub> concentrations of 32.8 and 89.5 µg/m<sup>3</sup>, respectively, are less than the respective AAQS of 50 and 150 µg/m<sup>3</sup>.

The predicted total annual NO<sub>2</sub> concentration of 29.0 µg/m<sup>3</sup> is well below the AAQS concentration of 100 µg/m<sup>3</sup>. These maximum concentrations include the appropriate background concentrations.

### **6.11.3 PSD CLASS II ANALYSIS**

Summaries of the maximum PM<sub>10</sub> and NO<sub>x</sub> PSD increment consumption predicted for all sources for the screening analysis is presented in Table 6-17. Based on the screening analysis results, maximum annual concentrations of NO<sub>2</sub> occurred in locations modeled with dense 100-m-spaced receptors and

additional modeling refinements were not required. The annual and HSH 24-hour average PM<sub>10</sub> impacts occurred in locations modeled with 250-m-spaced receptors and additional modeling refinements were conducted near these locations by placing additional 100-m-spaced receptors and predicting the HSH 24-hour average PM<sub>10</sub> concentrations for these receptors. The final modeling results are presented in Table 6-18.

The maximum annual average PM<sub>10</sub> increment consumption was predicted to be 3.3 µg/m<sup>3</sup>, well below the allowable PSD Class II increment of 17 µg/m<sup>3</sup>. The maximum predicted HSH 24-hour PM<sub>10</sub> increment consumption concentration of was predicted to be 22.5 µg/m<sup>3</sup>, well below the allowable PSD Class II increment of 30 µg/m<sup>3</sup>.

The maximum predicted annual NO<sub>2</sub> increment consumption concentration of 2.3 µg/m<sup>3</sup> is below the allowable PSD Class II increments of 25 µg/m<sup>3</sup>.

#### **6.11.4 PSD CLASS I SIGNIFICANT IMPACT ANALYSIS**

The maximum PM<sub>10</sub> and NO<sub>2</sub> concentrations, predicted for the proposed project only at the Chassahowitzka NWA PSD Class I area, are compared with the EPA's proposed PSD Class I significance levels in Table 6-19. All maximum predicted impacts were below the significant impact levels. Therefore, a full PSD Class I incremental analysis was not performed for these pollutants.

#### **6.11.5 FLUORIDE IMPACTS IN THE SITE VICINITY AND CLASS I AREA**

Maximum F concentrations due to the proposed project in the site vicinity and the Chassahowitzka NWA PSD Class I area are presented in Tables 6-20 and 6-21, respectively, for the annual, 24-, 8-, 3-, and 1-hour averaging times. There are no AAQS or PSD increments for F. However, F impacts are required for the additional impact analysis and AQRV analysis for the Class I area, presented in Section 7.0.

At the site vicinity, the maximum predicted annual and 24-, 8-, and 1-hour F concentrations are 1.4, 7.9, 11.1, and 19.5 µg/m<sup>3</sup>, respectively. The maximum predicted annual and 24-, 8-, 3-, and 1-hour F concentrations at the Chassahowitzka NWA are 0.0006, 0.010, 0.026, 0.039, and 0.046 µg/m<sup>3</sup>, respectively.



Table 6-1. Major Features of the ISCST3 Model

ISCST3 Model Features <sup>a</sup>	
•	Polar or Cartesian coordinate systems for receptor locations.
•	Rural or one of three urban options which affect wind speed profile exponent, dispersion rates, and mixing height calculations.
•	Plume rise due to momentum and buoyancy as a function of downwind distance for stack emissions (Briggs, 1969, 1971, 1972, and 1975; Bowers, et al., 1979).
•	Procedures suggested by Huber and Snyder (1976); Huber (1977); and Schulman and Scire (1980) for evaluating building wake effects.
•	Procedures suggested by Briggs (1974) for evaluating stack-tip downwash.
•	Separation of multiple emission sources.
•	Consideration of the effects of gravitational settling and dry deposition on ambient particulate concentrations.
•	Capability of simulating point, line, volume, area, and open pit sources.
•	Capability to calculate dry and wet deposition, including both gaseous and particulate precipitation scavenging for wet deposition.
•	Variation of wind speed with height (wind speed-profile exponent law).
•	Concentration estimates for 1 hour to annual average times.
•	Terrain-adjustment procedures for elevated terrain including a terrain truncation algorithm for ISCST3; a built-in algorithm for predicting concentrations in complex terrain.
•	Consideration of time-dependent exponential decay of pollutants.
•	The method of Pasquill (1976) to account for buoyancy-induced dispersion.
•	A regulatory default option to set various model options and parameters to EPA recommended values (see text for regulatory options used).
•	Procedure for calm-wind processing including setting wind speeds less than 1 m/s to 1 m/s.

Note: ISCST3 = Industrial Source Complex Short-Term.

## References:

- Bowers, J.F., J.R. Bjorklund and C.S. Cheney. 1979. Industrial Source Complex (ISC) Dispersion Model User's Guide. Volume I, EPA-450/4-79-030; Volume II, EPA-450/4-79-031. U.S. Environmental Protection Agency, Research Triangle Park, North Carolina 27711.
- Briggs, G.A. 1969. Plume Rise, USAEC Critical Review Series, TID-25075. National Technical Information Service, Springfield, Virginia 22161.
- Briggs, G.A. 1972. Discussion on Chimney Plumes in Neutral and Stable Surroundings. *Atmos. Environ.*, Q, 507-510.
- Briggs, G.A. 1974. Diffusion Estimation for Small Emissions. In: ERL, ARL USAEC Report ATDL-106. U.S. Atomic Energy Commission, Oak Ridge, Tennessee.
- Briggs, G.A. 1975. Plume Rise Predictions. In Lectures on Air Pollution and Environmental Impact Analysis. American Meteorological Society, Boston, Massachusetts.
- Briggs, G.A. 1979. Some Recent Analyses of Plume Rise Observations. In: Proceedings of the Second International Clean Air Congress. Academic Press, New York.
- Huber, A.H. 1977. Incorporating Building/Terrain Wake Effects on Stack Effluents. Preprint Volume for the Joint Conference on Applications of Air Pollution Meteorology, American Meteorological Society, Boston, Massachusetts.
- Huber, A.H. and W.H. Snyder. 1976. Building Wake Effects on Short Stack Effluents. Preprint Volume for the Third Symposium on Atmospheric Diffusion and Air Quality, American Meteorological Society, Boston, Massachusetts.
- Pasquill, F. 1976. Atmospheric Dispersion Parameters in Gaussian Plume Modeling - Part II. Possible Requirements for Change in the Turner Workbook Values. EPA-600/4-76-030b, U.S. Environmental Protection Agency, Research Triangle Park, North Carolina 27711.
- Schulman, L.L. and J.S. Scire. 1980. Buoyant Line and Point Source (BLP) Dispersion Model User's Guide. Document P-7304B. Environmental Research and Technology, Inc., Concord, MA.

Table 6-2. Major Features of the CALPUFF Model, Version 5.711a

---

**CALPUFF Model Features**

---

- ! Source types: Point, line (including buoyancy effects), volume, area (buoyant, non-buoyant).
  - ! Non-steady-state emissions and meteorological conditions (time-dependent source and emission data; gridded 3-dimensional wind and temperature fields; spatially-variable fields of mixing heights, friction velocity, precipitation, Monin-Obukhov length; vertically and horizontally-varying turbulence and dispersion rates; time-dependent source and emission data for point, area, and volume sources; temporal or wind-dependent scaling factors for emission rates).
  - ! Efficient sampling function (integrated puff formulation; elongated puff (slug) formation).
  - ! Dispersion coefficient options (Pasquill-Gifford (PG) values for rural areas; McElroy-Pooler values (MP) for urban areas; CTDM values for neutral/stable; direct measurements or estimated values).
  - ! Vertical wind shear (puff splitting; differential advection and dispersion).
  - ! Plume rise (buoyant and momentum rise; stack-tip effects; building downwash effects; partial plume penetration above mixing layer).
  - ! Building downwash effects (Huber-Snyder method; Schulman-Scire method).
  - ! Complex terrain effects (steering effects in CALMET wind field; puff height adjustments using ISC model method or plume path coefficient; enhanced vertical dispersion used in CTDMPLUS).
  - ! Subgrid scale complex terrain (CTSG option) (CTDM flow module; dividing streamline as in CTDMPLUS).
  - ! Dry deposition (gases and particles; options for diurnal cycle per pollutant, space and time variations with a resistance model, or none).
  - ! Overwater and coastal interaction effects (overwater boundary layer parameters; abrupt change in meteorological conditions, plume dispersion at coastal boundary; fumigation; option to use Thermal Internal Boundary Layers (TIBL) into coastal grid cells).
  - ! Chemical transformation options (Pseudo-first-order chemical mechanisms for SO<sub>2</sub>, SO<sub>4</sub>, HNO<sub>3</sub>, and NO<sub>3</sub>; Pseudo-first-order chemical mechanisms for SO<sub>2</sub>, SO<sub>4</sub>, NO, NO<sub>2</sub>, HNO<sub>3</sub>, and NO<sub>3</sub> (RIVAD/ARM3 method); user-specified diurnal cycles of transformation rates; no chemical conversions).
  - ! Wet removal (scavenging coefficient approach; removal rate as a function of precipitation intensity and type).
  - ! Graphical user interface.
  - ! Interface utilities (scan ISCST3 and AUSPLUME meteorological data files for problems; translate ISCST3 and AUSPLUME input files to CALPUFF input files).
- 

Note: CALPUFF = California Puff Model

Source: EPA, 2001.

Table 6-3. Summary of PM<sub>10</sub>, F, and NO<sub>x</sub> Current Actual and Future Potential Emission Rates for the Proposed Project--Mosaic Green Bay

Source	EU ID	Average Actual Operating Hours <sup>d</sup> (hr/yr)	PM <sub>10</sub> Emissions				F Emissions				NO <sub>x</sub> Emissions	
			Hourly		Annual		Hourly		Annual		Annual	
			lb/hr	g/s	TPY	g/s	lb/hr	g/s	TPY	g/s	TPY	g/s
<b>Current Actual Emissions<sup>a</sup></b>												
Phosphoric Acid Plant No. 1-North Train	016	7,280	--	--	--	--	0.19	0.024	0.68	0.024	--	--
Phosphoric Acid Plant No. 1-South Train	017	7,147	--	--	--	--	0.09	0.011	0.32	0.011	--	--
Phosphoric Acid Plant No. 2	013	7,546	--	--	--	--	0.05	0.0068	0.20	0.0068	--	--
Phosphoric Acid Storage Tanks-2 (PAP 1, R-R)	014	8,760	--	--	--	--	0.0127	0.0016	0.056	0.0016	--	--
Phosphoric Acid Storage Tanks-2 (PAP 2, N-N)	015	8,760	--	--	--	--	0.01	0.0014	0.05	0.0014	--	--
Phosphoric Acid Blend Tanks-4	037	8,760	--	--	--	--	0.00009	0.000012	0.00040	0.000012	--	--
South AP Plant--Stack A (R/G) <sup>h</sup>	007	7,253	3.85	0.485	9.31	0.323	0.38	0.048	1.38	0.048	--	--
South AP Plant--Stack B (Dryer) <sup>h</sup>	007	7,253	3.85	0.485	9.31	0.323	0.38	0.048	1.38	0.048	3.03	0.105
North AP Plant--Main Stack <sup>h</sup>	029	7,253	4.05	0.510	12.00	0.417	0.62	0.078	2.24	0.078	4.10	0.143
North AP Plant--RG Stack <sup>h</sup>	029	7,253	4.05	0.510	12.00	0.417	0.62	0.078	2.24	0.078	--	--
MAP/DAP Shipping & Storage Buildings	020	7,491	3.01	0.380	11.29	0.380	0.063	0.0079	0.24	0.0079	--	--
<b>Future Potential Emissions<sup>c</sup></b>												
Phosphoric Acid Plant No. 1-North Train	016	--	--	--	--	--	0.55	0.069	2.41	0.069	--	--
Phosphoric Acid Plant No. 1-South Train	017	--	--	--	--	--	0.9	0.113	3.94	0.113	--	--
Phosphoric Acid Plant No. 2	013	--	--	--	--	--	1.10	0.139	4.82	0.139	--	--
Phosphoric Acid Storage Tanks-2 (PAP 1, R-R)	014	--	--	--	--	--	0.02	0.003	0.088	0.0025	--	--
Phosphoric Acid Storage Tanks-2 (PAP 2, N-N)	015	--	--	--	--	--	0.02	0.003	0.088	0.0025	--	--
Phosphoric Acid Blend Tanks-4	037	--	--	--	--	--	0.10	0.013	0.44	0.013	--	--
South AP Plant--Stack A (R/G) <sup>h</sup>	007	--	5.75	0.725	25.20	0.725	1.38	0.174	6.05	0.174	--	--
South AP Plant--Stack B (Dryer) <sup>h</sup>	007	--	5.75	0.725	25.20	0.725	1.38	0.174	6.05	0.174	55.17	1.587
North AP Plant--Main Stack <sup>h</sup>	029	--	15.4	1.94	67.40	1.94	2.39	0.301	10.45	0.301	32.444	0.933
North AP Plant--RG Stack <sup>h</sup>	029	--	15.4	1.94	67.40	1.94	2.39	0.301	10.45	0.301	--	--
MAP/DAP Shipping & Storage Buildings	020	--	1.60	0.20	7.00	0.20	--	--	--	--	--	--

<sup>a</sup> Emissions from Table 2-3. Hourly emissions were calculated based on the actual annual numbers and the average actual operating hours.

<sup>b</sup> Plant emissions for PM<sub>10</sub> and F were split between both plant stacks.

<sup>c</sup> Emissions from Tables 2-1, 2-2, 2-4 and Title V Permit No. 1050053-012-AV.

<sup>d</sup> From the 2004 and 2003 AORs.

Table 6-4. Stack and Operating Data for Current and Future Operations for All Sources--Mosaic Green Bay

Source	EU ID	ISCST3 ID Name	Location				Stack/Vent Release Height		Stack/Vent Diameter		Actual Exhaust Flow Rate (acfm)	Exhaust Gas Exit Temperature		Exhaust Gas Velocity			
			X		Y		ft	m	ft	m		°F	K	ft/s		m/s	
			ft	m	ft	m								ft/s	m/s		
<b>Current Operations</b>																	
No. 4 Sulfuric Acid Plant	004	SAP4	738.5	225.11	960.9	292.88	100.0	30.48	7.5	2.29	151,100	180	355	57.00	17.37		
No. 5 Sulfuric Acid Plant	005	SAP5	1199.0	365.44	1040.6	317.16	150.0	45.72	8.0	2.44	148,000	169	350	49.07	14.96		
No. 6 Sulfuric Acid Plant	038	SAP6	1534.8	467.82	691.9	210.88	150.0	45.72	9.0	2.74	144,500	174	352	37.86	11.54		
Phosphoric Acid Plant No. 1--North	016	NPHOS1	397.1	121.03	645.8	196.85	100.5	30.63	3.5	1.07	26,400	110	316	45.73	13.94		
Phosphoric Acid Plant No. 1--South	017	SPHOS1	405.9	123.71	446.9	136.20	100.5	30.63	3.5	1.07	21,200	108	315	36.72	11.19		
Phosphoric Acid Plant No. 2	013	PHOS2	244.9	74.66	848.4	258.59	110.0	33.53	3.0	0.91	21,300	114	319	50.22	15.31		
Phosphoric Acid Tanks (2, R-R)	014	STORPAD1	443.1	135.06	400.8	122.17	59.3	18.08	0.8	0.25	113	94	308	3.45	1.05		
Phosphoric Acid Tanks (2, N-N)	015	STORPAD2	457.1	139.33	966.9	294.71	62.8	19.13	1.3	0.41	109	91	306	1.31	0.40		
Phosphoric Acid Blend Tanks	037	BLENDTNK	707.3	215.60	538.1	164.02	22.5	6.86	0.5	0.15	94	77	298	7.98	2.43		
South DAP Plant--Stack A	007	SDAPGRAN	417.1	127.13	8.1	2.46	130.0	39.62	5.0	1.52	19,900	151	339	16.89	5.15		
South DAP Plant--Stack B	007	SDAPMAIN	522.8	159.34	10.9	3.32	129.5	39.47	7.5	2.29	130,900	108	315	49.38	15.05		
North MAP/DAP Plant--Main Stack	029	NDAPMAIN	522.4	159.22	127.8	38.95	129.5	39.47	7.5	2.29	168,400	105	313	63.53	19.36		
North MAP/DAP Plant--RG Stack	029	NDAPGRAN	433.1	132.01	130.6	39.80	117.0	35.66	5.5	1.68	51,600	204	368	36.20	11.03		
MAP/DAP Shipping & Storage Buildings	020	DAPSHIP	313.0	95.4	199.0	60.67	131.5	40.08	8.0	2.44	137,100	92	306	45.46	13.86		
Molten Sulfur Railcar/Backup Truck Pit	034	RAILPIT	-722.1	-220.10	7.4	2.26	11.0	3.35	0.8	0.24	16,000	68	293	530.52	161.70		
<b>Area Sources</b>																	
Molten Sulfur Tank No. 1 (9 Vents)	030	MOLTTNK1	-670.1	-204.26	29.2	8.90	33.0	10.06	60.0	18.29	60.0	18.29	0				
Molten Sulfur Tank No. 2 (10 Vents)	031	MOLTTNK2	881.2	268.58	580.7	177.00	33.0	10.06	45.0	13.72	45.0	13.72	0				
Molten Sulfur Tank No. 3 (10 Vents)	032	MOLTTNK3	933.5	284.54	580.7	177.00	33.0	10.06	45.0	13.72	45.0	13.72	0				
Molten Sulfur Tank No. 4 (1 Vent)	039	MOLTTNK4	-756.2	-230.49	45.2	13.79	37.0	11.28	59.1	18.00	59.1	18.00	0				
Molten Sulfur Pit No. 4	036	SULFPIT4	926.9	282.53	640.0	195.07	9.5	2.90	10.0	3.05	10.0	3.05	0				
Molten Sulfur Pit No. 5	035	SULFPIT5	884.0	269.44	552.6	168.42	11.3	3.45	9.1	2.76	9.1	2.76	0				
Molten Sulfur Pit No. 6	039	SULFPIT6	885.1	269.78	640.0	195.07	8.0	2.44	10.0	3.05	10.0	3.05	0				
Molten Sulfur Truck Pit	033	TRUCKUNL	902.4	275.06	525.3	160.11	11.3	3.45	24.7	7.53	37.6	11.47	0				



Table 6-5. Summary of Future Potential PM/PM<sub>10</sub> and NO<sub>x</sub> Emission Rates for all Sources--Mosaic Green Bay

Source	EU ID	PM <sub>10</sub> Emissions				NO <sub>x</sub> Emissions		Ref.
		Hourly		Annual		Annual		
		lb/hr	g/s	TPY	g/s	TPY	g/s	
<u>Molten Sulfur Handling System</u>								
Molten Sulfur Tank No. 1 (9 Vents)	030	0.320	0.040	1.40	0.040	--	--	(1)
Molten Sulfur Tank No. 2 (10 Vents)	031	0.327	0.041	1.43	0.041	--	--	(1)
Molten Sulfur Tank No. 3 (10 Vents)	032	0.327	0.041	1.43	0.041	--	--	(1)
Molten Sulfur Tank No. 4 (1 Vent)	039	0.176	0.022	0.77	0.022	--	--	(1)
Molten Sulfur Pit No. 4	036	0.011	0.0014	0.05	0.0014	--	--	(1)
Molten Sulfur Pit No. 5	035	0.011	0.0014	0.05	0.0014	--	--	(1)
Molten Sulfur Pit No. 6	039	0.011	0.0014	0.05	0.0014	--	--	(1)
Molten Sulfur Truck Pit	033	0.011	0.0014	0.05	0.0014	--	--	(1)
Molten Sulfur Railcar/Backup Truck Pit	034	0.320	0.040	1.40	0.040	--	--	(1)
<u>Sulfuric Acid Plants</u>								
No. 4 Sulfuric Acid Plant	004	--	--	--	--	45.99	1.323	(4)
No. 5 Sulfuric Acid Plant	005	--	--	--	--	61.32	1.764	(4)
No. 6 Sulfuric Acid Plant	038	--	--	--	--	60.0	1.726	(2)
South DAP Plant--Stack A (R/G) <sup>a</sup>	007	5.75	0.725	25.20	0.725	--	--	(3)
South DAP Plant--Stack B (Dryer) <sup>a</sup>	007	5.75	0.725	25.20	0.725	55.17	1.587	(3)
MAP/DAP Shipping & Storage Buildings	020	1.60	0.20	7.00	0.20	--	--	(5)
North MAP/DAP Plant-Main Stack <sup>a</sup>	029	15.4	1.940	67.40	1.94	32.44	0.933	(3)
North MAP/DAP Plant-RG Stack <sup>a</sup>	029	15.4	1.940	67.40	1.94	--	--	(3)

<sup>a</sup> Plant emissions for PM/PM<sub>10</sub> were split between both plant stacks.

#### References:

1. Based on actual emissions from the 2003 and 2004 AORs (refer to Appendix A).
2. Emission rates from Title V Permit No. 1050053-012-AV.
3. Based on the proposed future potential emission rates. Refer to Tables 2-1, 2-2, and 2-4 for derivation.
4. Calculated based on the emission limit for the No. 6 SAP (0.12 lb/ton H<sub>2</sub>SO<sub>4</sub>).
5. Emission rates from the permit application for permit 1050053-036-AC.

Table 6-6: Summary of all PM<sub>10</sub> Emitting Facilities in the Vicinity of the Mosaic Green Bay Plant

Plant ID	Facility Name	County	UTM Coordinates		Relative to Mosaic Green Bay <sup>a</sup>				Maximum PM Emissions (TPY)	Q, (TPY) Emission Threshold <sup>b,c</sup> (Dist - SID) x 20	Include in Modeling Analysis ?
			East (km)	North (km)	X (km)	Y (km)	Direction (deg.)	Distance (km)			
<u>Modeling Area <sup>d</sup></u>											
	Mosaic Green Bay Fertilizer, Inc.	Polk	409.5	3,080.1	0.0	0.0	NA	0.0		SIA	YES
<u>Screening Area <sup>d</sup></u>											
	Bartow Phosphate Cnt. (Uranium Rec.)	Polk	408.4	3,082.2	-1.1	2.1	332	2.4	-828	SIA	YES
1050052	C.F. Industries, Bartow	Polk	408.3	3,082.5	-1.2	2.4	333	2.7	64	SIA	YES
1050217	Polk Power Partners, L.P. Mulberry	Polk	413.6	3,080.6	4.1	0.5	83	4.1	35	SIA	YES
1050229	Parallel Products Of Florida	Polk	413.9	3,080.7	4.4	0.6	82	4.4	31	SIA	YES
1050097	Custom Chemicals Corporation	Polk	408.0	3,085.5	-1.5	5.4	344	5.6	2	12	NO
1050048	Mosaic Phosphates (formerly Mulberry Phosphat	Polk	406.8	3,085.1	-2.7	5.0	332	5.7	3	14	NO
1050021	Ashland Specialty Chemical Co.	Polk	411.1	3,085.9	1.6	5.8	15	6.0	1	20	NO
1050148	Grand Eagle Service, Inc.	Polk	404.9	3,084.1	-4.6	4.0	311	6.1	1	22	NO
1050046	Mosaic Fertilizer LLC- Bartow	Polk	409.8	3,086.6	0.3	6.5	3	6.5	257	30	YES
1050146	Pavex Corporation	Polk	413.0	3,086.2	3.5	6.1	30	7.0	14	41	NO
1050050	U S Agri-Chemicals - Bartow	Polk	413.2	3,086.3	3.7	6.2	31	7.2	268	44	YES
1050312	Master Containers, Inc.	Polk	404.3	3,085.6	-5.3	5.5	316	7.6	2	52	NO
1050234	Progress Energy Hines Energy Complex	Polk	414.3	3,073.9	4.8	-6.2	142	7.9	200	57	YES
	Organic Matters Inc.	Polk	417.9	3,083.0	8.4	2.9	71	8.9	21	78	NO
1050055	Mosaic Phosphates (South Pierce)	Polk	407.5	3,071.4	-2.0	-8.7	193	8.9	770	79	YES
1050064	Florida Rock Ind. - Bartow	Polk	416.8	3,085.8	7.3	5.7	52	9.3	57	85	NO
1050145	Bartow Ethanol, Inc.	Polk	418.8	3,078.8	9.3	-1.3	98	9.3	281	87	YES
1050056	CD Global Prairie Mine (Mosaic Agrico)	Polk	402.9	3,087.0	-6.6	6.9	316	9.5	607	91	YES
1050182	Geologic Recovery Systems	Polk	401.8	3,085.8	-7.7	5.7	307	9.6	20	92	NO
1050231	Orange Cogeneration Facility	Polk	418.7	3,083.0	9.2	2.9	73	9.6	48	93	NO
1050198	Palex - Homeland	Polk	419.1	3,078.1	9.6	-2.0	102	9.8	97	96	YES
1050045	Peace River Citrus Products, Inc.	Polk	418.7	3,083.6	9.2	3.5	69	9.8	95	97	NO
1050128	Ridge - Bartow	Polk	418.6	3,084.1	9.1	4.0	66	9.9	47	99	NO
1050157	Purina Mills, Inc.	Polk	402.0	3,087.0	-7.5	6.9	313	10.2	22	104	NO
1050066	K.C. Industries, L.L.C.	Polk	401.5	3,086.5	-8.0	6.4	309	10.2	16	105	NO
1050319	Clark Environmental Inc	Polk	401.2	3,086.6	-8.3	6.5	308	10.5	13	111	NO
1050057	Mosaic Phosphates (Nichols)	Polk	398.4	3,084.2	-11.1	4.1	290	11.8	1,337	137	YES
1050199	Vigiron	Polk	420.4	3,075.2	10.9	-4.9	114	12.0	88	139	NO
1050047	Agrifos Mining, L.L.C. - Nichols	Polk	398.7	3,085.3	-10.8	5.2	296	12.0	557	140	YES
1050034	Mosaic Phosphates (CFMO)	Polk	398.2	3,075.7	-11.3	-4.4	249	12.1	1,781	143	YES
1050223	Progress Energy- Tiger Bay Cogeneration Facility	Polk	416.3	3,069.3	6.8	-10.8	148	12.8	46	155	NO
1050059	Mosaic Phosphates (New Wales)	Polk	396.7	3,079.4	-12.8	-0.7	267	12.8	1,521	156	YES
1050051	U.S. Agri-Chemicals - Ft. Meade	Polk	416.0	3,069.0	6.5	-11.1	150	12.9	119	157	NO

Table 6-6: Summary of all PM<sub>10</sub> Emitting Facilities in the Vicinity of the Mosaic Green Bay Plant

Plant ID	Facility Name	County	UTM Coordinates		Relative to Mosaic Green Bay <sup>a</sup>				Maximum PM Emissions (TPY)	Q. (TPY) Emission Threshold <sup>b,c</sup> (Dist - SID) x 20	Include in Modeling Analysis?
			East (km)	North (km)	X (km)	Y (km)	Direction (deg.)	Distance (km)			
<u>Modeling Area<sup>d</sup></u>											
1050026	Alcoa , L.L.C.	Polk	416.8	3,069.5	7.3	-10.6	145	12.9	69	157	NO
0570448	North Star Recycling--Port Sutton		398.3	3,086.7	-11.2	6.59	300	13.0	2	160	NO
1050314	Supermag Processing Facility	Polk	405.1	3,067.8	-4.4	-12.3	200	13.0	0.1	161	NO
1050200	Phosphate Rock Dryer	Polk	399.1	3,070.6	-10.4	-9.5	228	14.1	5	182	NO
1050211	General Plastics Division Of PMC, Inc.	Polk	413.5	3,093.8	4.0	13.7	16	14.3	4	185	NO
1050233	Polk Power Station-TECO	Polk	402.5	3,067.4	-7.1	-12.8	209	14.6	149	191	NO
1050228	Sadler Drum Company	Polk	396.2	3,089.3	-13.3	9.2	305	16.2	0	223	NO
1050244	Sunbelt Forest Products Corp.	Polk	422.1	3,092.1	12.6	12.0	46	17.4	4	247	NO
1050151	Central Florida Hot-Mix, Inc.	Polk	412.5	3,097.7	3.0	17.6	10	17.9	45	257	NO
1050106	Citrus World, Inc.--Florida's Natural Growers-Ba	Polk	422.7	3,092.6	13.2	12.5	47	18.2	89	264	NO
1050196	O. K. West & Son	Polk	411.5	3,098.2	2.0	18.1	6	18.2	1	264	NO
1050100	Shell Epoxy Resins LLC	Polk	410.7	3,098.9	1.2	18.8	4	18.8	25	277	NO
1050073	Rinker Materials Corporation	Polk	412.5	3,099.0	3.0	18.9	9	19.1	38	283	NO
1050316	McGee Tire Stores, Inc.	Polk	413.7	3,098.8	4.2	18.7	13	19.2	18	283	NO
1050081	Quikrete Of Florida, Inc.	Polk	412.8	3,099.0	3.3	18.9	10	19.2	1	284	NO
1050127	Juice Bowl Products	Polk	409.4	3,099.9	-0.1	19.8	360	19.8	1	296	NO
1050226	Pops Painting, Inc.	Polk	399.3	3,097.2	-10.2	17.1	329	19.9	0	298	NO
1050297	Polk Co. Animal Services	Polk	418.4	3,098.4	8.9	18.3	26	20.3	2	306	NO
1050240	International Beverage Systems, Inc.	Polk	398.0	3,097.0	-11.5	16.9	326	20.4	0.3	309	NO
1050298	Polk Co. No. Central Landfill	Polk	418.9	3,098.5	9.4	18.4	27	20.7	3	314	NO
1050134	Heath Funeral Chapel	Polk	407.1	3,101.9	-2.4	21.8	354	21.9	1	339	NO
1050003	Lakeland Electric, Larsen Power Plant	Polk	408.9	3,102.5	-0.6	22.4	358	22.4	488	348	YES
1050213	Florida Favorite Fertilizer Company	Polk	403.5	3,101.7	-6.0	21.6	344	22.4	3	348	NO
1050120	Cement Products & Supply Co., Inc.	Polk	405.5	3,102.2	-4.0	22.1	350	22.5	1	349	NO
0570075	Coronet Industries, Inc.		393.8	3,096.3	-15.7	16.2	316	22.6	9	351	NO
1050009	Florida Tile Industries, Inc.	Polk	405.4	3,102.4	-4.1	22.3	350	22.7	14	353	NO
1050137	Monier, Inc.	Polk	414.0	3,102.5	4.5	22.4	11	22.8	44	357	NO
1050177	Publix Super Markets-Lakeland Danish Bakery	Polk	400.8	3,101.5	-8.7	21.4	338	23.1	5	362	NO
1050139	Maxpak Corporation	Polk	402.0	3,102.0	-7.5	21.9	341	23.1	16	363	NO
0490015	Hardee Power Station		404.8	3,057.4	-4.7	-22.7	192	23.2	247	364	NO
1050272	Lakeland Crematory	Polk	419.9	3,101.0	10.4	20.9	26	23.3	4	366	NO
0570220	Southern Culvert		391.5	3,095.0	-18.0	14.9	310	23.4	14	367	NO
1050034	Mosaic Phosphates, Ft. Lonesome	Polk	389.5	3,068.0	-20.0	-12.1	239	23.4	-443	368	NO
1050114	Ewell Industries - Lakeland	Polk	398.9	3,101.2	-10.6	21.1	333	23.6	0.4	372	NO
1050236	Weyerhaeuser Company	Polk	396.0	3,100.1	-13.5	20.0	326	24.1	0.002	382	NO
7770037	Apac - Florida, Inc., Tampa Div.		392.6	3,097.3	-16.9	17.2	316	24.1	22	382	NO



Table 6-6: Summary of all PM<sub>10</sub> Emitting Facilities in the Vicinity of the Mosaic Green Bay Plant

Plant ID	Facility Name	County	UTM Coordinates		Relative to Mosaic Green Bay <sup>a</sup>				Maximum PM Emissions (TPY)	Q, (TPY) Emission Threshold <sup>b,c</sup> (Dist - SID) x 20	Include in Modeling Analysis?
			East (km)	North (km)	X (km)	Y (km)	Direction (deg.)	Distance (km)			
<u>Modeling Area<sup>d</sup></u>											
1050015	US Beverage Packing Lakeland Plant	Polk	399.0	3,101.8	-10.5	21.7	334	24.1	140	382	NO
1050230	Breed Technologies Inc.	Polk	396.3	3,100.3	-13.2	20.2	327	24.1	1	383	NO
0570460	Hardie Building Products Inc.		387.1	3,089.5	-22.4	9.4	293	24.3	5	387	NO
1050095	Lakeland Regional Medical Center	Polk	406.4	3,104.3	-3.1	24.2	353	24.4	2	388	NO
1050158	High Performance Systems, Inc.	Polk	428.1	3,096.1	18.6	16.0	49	24.5	1	390	NO
1050252	Mosaic Fertilizer LLC	Polk	425.2	3,061.2	15.7	-18.9	140	24.6	0.2	391	NO
0570474	T-R Drum & Freight Co.		389.0	3,094.0	-20.5	13.9	304	24.8	1	395	NO
1050208	Lakeland Drum Service, Inc.	Polk	418.8	3,103.6	9.3	23.5	22	25.3	50	405	NO
1050017	Pursell Industries, Inc.	Polk	428.0	3,097.4	18.5	17.3	47	25.3	6	407	NO
1050174	Pepperidge Farm, Inc	Polk	403.3	3,104.8	-6.2	24.7	346	25.5	1	409	NO
1050096	Florida Distillers - Auburndale	Polk	421.4	3,102.9	11.9	22.8	28	25.7	1	414	NO
1050221	Auburndale Power Partners	Polk	420.6	3,103.3	11.3	23.2	26	25.8	553	416	YES
1050334	Auburndale Power Osprey	Polk	420.8	3,103.3	11.3	23.2	26	25.8	204	416	NO
1050143	City Of Lakeland	Polk	403.7	3,105.3	-5.8	25.2	347	25.9	3	417	NO
1050175	Ennis Drum Service, Inc./Ennis Container, Inc.	Polk	422.5	3,102.5	13.0	22.4	30	25.9	2	418	NO
1050082	APAC-Florida, Inc., Macasphalt Div.	Polk	423.7	3,101.9	14.2	21.8	33	26.0	81	419	NO
1050004	Lakeland Electric, McIntosh Power Plant	Polk	409.0	3,106.2	-0.5	26.1	359	26.1	2,308	422	YES
0570388	Hardee Manufacturing Co.		392.2	3,099.7	-17.3	19.6	319	26.1	7	423	NO
0570417	International Paper		391.7	3,099.3	-17.8	19.2	317	26.2	0.01	424	NO
0571016	Consolidated Fabricating, Inc.		392.4	3,100.1	-17.1	20.0	319	26.3	6	426	NO
0570124	Rinker Materials Corporation		392.2	3,100.0	-17.3	19.9	319	26.4	2	427	NO
1050203	Fleetwood Homes Of Florida Inc.	Polk	422.4	3,103.2	12.9	23.1	29	26.5	0.1	429	NO
1050023	Cutrale Citrus Juices USA, Inc	Polk	421.6	3,103.7	12.1	23.6	27	26.5	673	430	YES
0570318	Southdown, Inc.		390.2	3,098.3	-19.3	18.2	313	26.5	6	431	NO
1050007	Owens-Brockway Glass Container Inc.	Polk	423.4	3,102.8	13.9	22.7	31	26.6	123	432	NO
1050022	Tenneco Packaging, Inc.	Polk	423.4	3,102.8	13.9	22.7	31	26.6	0.3	432	NO
1050216	Ridge Generating Station, L.P. <sup>d</sup>	Polk	427.0	3,100.3	17.5	20.2	41	26.8	61	435	NO
1050227	Central Florida Crematory Of Polk Co.	Polk	405.0	3,106.5	-4.5	26.4	350	26.8	2	436	NO
1050037	All-Temp Storage LLC	Polk	421.7	3,104.2	12.2	24.1	27	27.0	87	440	NO
1050076	International Paper - Auburndale	Polk	421.7	3,104.3	12.2	24.2	27	27.1	4	442	NO
0571289	North Star Recycling--Dover Street		362.3	3,086.5	-47.2	6.4	278	47.7	20	854	NO
1050072	Winterhaven Hospital	Polk	428.7	3,100.4	19.2	20.3	43	27.9	1	459	NO
0490017	Singletery Concrete Prod Inc		418.5	3,053.5	9.0	-26.6	161	28.1	8	463	NO
1050122	Auburndale Facility	Polk	423.5	3,104.6	14.0	24.5	30	28.2	5	464	NO
0570370	Paradise, Inc.		388.5	3,099.0	-21.0	18.9	312	28.3	2	465	NO
0571115	Redman Homes, Inc.		387.0	3,097.4	-22.5	17.3	308	28.3	15	466	NO

Table 6-6: Summary of all PM<sub>10</sub> Emitting Facilities in the Vicinity of the Mosaic Green Bay Plant

Plant ID	Facility Name	County	UTM Coordinates		Relative to Mosaic Green Bay <sup>a</sup>				Maximum PM Emissions (TPY)	Q. (TPY) Emission Threshold <sup>b,c</sup> (Dist - SID) x 20	Include in Modeling Analysis?
			East (km)	North (km)	X (km)	Y (km)	Direction (deg.)	Distance (km)			
<u>Modeling Area<sup>d</sup></u>											
0570468	Gatsby Spas Inc.		387.1	3,097.6	-22.4	17.5	308	28.4	15	469	NO
0490041	CF Industries, Inc.		406.8	3,051.5	-2.7	-28.6	185	28.7	1	475	NO
1050067	Florida Mining & Materials Corp.	Polk	428.1	3,102.0	18.6	21.9	40	28.7	6	475	NO
0570249	Alcoa Extrusions		385.6	3,097.0	-23.9	16.9	305	29.3	200	485	NO
	Mosaic (Pierce)		404.1	3,079.0	-16.7	-24.3	214	29.5	-311	490	NO
1050099	AOC, L.L.C.	Polk	401.0	3,108.5	-8.5	28.4	343	29.6	36	493	NO
0571021	Dunco Rock & Gravel Inc		386.2	3,098.7	-23.3	18.6	309	29.8	5	496	NO
0570230	Florida Brick & Clay Co		384.9	3,097.1	-24.6	17.0	305	29.9	3	498	NO
0570374	Southern Grouts & Mortars		386.0	3,098.7	-23.5	18.6	308	30.0	5	499	NO
0570320	Dart Container Corp.Of FL		384.9	3,098.2	-24.6	18.1	306	30.5	1	511	NO
1050333	Human Crematory	Polk	433.6	3,099.7	24.1	19.6	51	31.0	1	521	NO
1050091	Florida Rock Ind. - Winter Haven	Polk	428.0	3,105.2	18.5	25.1	36	31.2	55	524	NO
0570438	Florida Gas Transmission Co.		391.9	3,106.6	-17.6	26.5	326	31.8	0.3	536	NO
0570091	Terra Asgrow		388.6	3,104.6	-20.9	24.5	320	32.2	5	544	NO
1050002	Citrus World, Inc.	Polk	441.1	3,087.3	31.6	7.2	77	32.4	40	548	NO
1050090	Florida Distillers - Lake Alfred	Polk	428.0	3,108.1	18.5	28.0	33	33.6	0.4	571	NO
0490043	IPS Vandolah Power Project		408.8	3,044.5	-0.8	-35.6	181	35.6	164	612	NO
1050209	Florida Treatt, Inc.	Polk	434.8	3,109.2	25.3	29.1	41	38.6	0.1	671	NO
1050019	Cargill Citro-America, Inc.	Polk	447.9	3,068.3	38.4	-11.8	107	40.2	248	703	NO
1050276	Ytong Florida, Ltd.	Polk	440.3	3,106.2	30.8	26.1	50	40.4	1	707	NO
1050263	FL Dept Of Corrections	Polk	423.0	3,118.2	13.5	38.1	20	40.4	1	708	NO
1050166	Scanamerican Holdings Corporation	Polk	430.1	3,115.4	20.6	35.3	30	40.9	3	717	NO
1050113	Lake Wales Mine	Polk	450.2	3,085.4	40.7	5.3	83	41.0	96	721	NO
0490003	The Mancini Packing Company		421.4	3,040.8	11.9	-39.3	163	41.1	25	721	NO
0570005	CF Industries--Plant City		388.0	3,116.0	-21.5	35.9	329	41.8	705	737	NO
0570180	FECPC/CAST Crete Division		371.9	3,099.2	-37.6	19.1	297	42.2	11	743	NO
1050001	Citrusuco North America, Inc.	Polk	451.6	3,085.5	42.1	5.4	83	42.4	67	749	NO
0570259	Ewell Industries, Inc.		368.6	3,092.1	-40.9	12.0	286	42.6	5	752	NO
0570261	Hillsborough Cty. RRF		368.2	3,092.7	-41.3	12.6	287	43.2	92	764	NO
7770380	Kearney Development Company		368.7	3,094.8	-40.8	14.7	290	43.4	1	767	NO
0570069	Industrial Galvanizers America, Inc.		368.5	3,094.5	-41.0	14.4	289	43.5	11	769	NO
0571196	Havatampa, Inc.		368.7	3,095.4	-40.8	15.3	291	43.6	0.0007	772	NO
0570090	Southeastern Wire		368.2	3,094.6	-41.3	14.5	289	43.8	14	775	NO
0570279	Florida Rock Industries, Inc.		365.8	3,085.0	-43.7	4.9	276	44.0	22	779	NO
0570025	Trademark Nitrogen Corp		367.3	3,092.6	-42.2	12.5	286	44.0	1,463	780	YES
0570280	Ewell Industries, Inc.		367.1	3,092.7	-42.4	12.6	287	44.2	24	785	NO

Table 6-6: Summary of all PM<sub>10</sub> Emitting Facilities in the Vicinity of the Mosaic Green Bay Plant

Plant ID	Facility Name	County	UTM Coordinates		Relative to Mosaic Green Bay <sup>a</sup>				Maximum PM Emissions (TPY)	Q, (TPY) Emission Threshold <sup>b,c</sup> (Dist - SID) x 20	Include in Modeling Analysis?
			East (km)	North (km)	X (km)	Y (km)	Direction (deg.)	Distance (km)			
<b>Modeling Area<sup>d</sup></b>											
0570240	Ewell Industries		367.0	3,092.8	-42.5	12.7	287	44.4	4	787	NO
0570241	Rinker Materials Corporation		364.9	3,084.4	-44.6	4.3	276	44.8	3	796	NO
0550035	Sunpure, Limited		448.3	3,057.6	38.8	-22.5	120	44.9	1	798	NO
0570260	Gaylord Container Corporation		366.3	3,092.3	-43.2	12.2	286	44.9	5	798	NO
0571242	National Gypsum		364.7	3,075.6	-44.8	-4.5	264	45.0	14	800	NO
0570405	Goodyear Tire & Rubber Company		366.4	3,093.2	-43.1	13.1	287	45.0	10	801	NO
0570076	Delta Asphalt		372.1	3,105.4	-37.4	25.3	304	45.2	62	803	NO
1010076	Plaza Materials Corporation		388.4	3,120.1	-21.1	40.0	332	45.2	1	804	NO
0570061	Tampa Armature Works		365.6	3,091.7	-43.9	11.6	285	45.4	0.3	808	NO
0570121	Ewell Industries, Inc.		364.0	3,075.0	-45.5	-5.1	264	45.8	12	816	NO
0570373	Howard F. Curren AWT Plant		364.0	3,089.5	-45.5	9.4	282	46.5	53	829	NO
0570321	Mantua Manufacturing Co.		364.7	3,092.5	-44.8	12.4	285	46.5	1	830	NO
0570364	Manna Pro Corporation		364.7	3,092.6	-44.8	12.5	286	46.5	11	830	NO
0570008	Mosaic Riverview Facility		362.9	3,082.5	-46.6	2.4	273	46.7	329	833	NO
0570317	Janet & Charles Wood Recycling Fac.		363.1	3,085.3	-46.4	5.2	276	46.7	100	834	NO
0570119	Gulf Coast Metals		364.7	3,093.6	-44.8	13.5	287	46.8	1	836	NO
0570150	Dravo Lime, Inc.		362.9	3,084.7	-46.6	4.6	276	46.8	42	837	NO
0570401	Florida Mega-Mix, Inc.		364.5	3,093.4	-45.0	13.3	286	46.9	8	838	NO
7771101	Woodruff And Sons Inc		364.3	3,093.2	-45.2	13.1	286	47.0	5	841	NO
0570409	Coniglio Construction & Demolition		368.9	3,104.2	-40.6	24.1	301	47.2	24	844	NO
1050061	Holly Hill Fruit Products		441.0	3,115.4	31.5	35.3	42	47.3	114	846	NO
0570344	Pops Painting, Inc. Tampa Tank		362.8	3,087.9	-46.7	7.8	279	47.3	38	847	NO
0570057	Gulf Coast Recycling, Inc.		364.0	3,093.5	-45.5	13.4	286	47.4	17	849	NO
7775052	Woodruff & Sons, Inc.		363.6	3,092.3	-45.9	12.2	285	47.4	5	849	NO
7775053	Woodruff & Sons, Inc.		363.6	3,092.3	-45.9	12.2	285	47.4	5	849	NO
7775054	Woodruff & Sons, Inc.		363.6	3,092.3	-45.9	12.2	285	47.4	7	849	NO
0570094	Mosaic Phosphates Co. (Big Bend)		362.1	3,076.1	-47.4	-4.0	265	47.6	76	851	NO
0570224	Reed Minerals Division		362.2	3,085.5	-47.3	5.4	277	47.6	32	852	NO
1010075	Matt Stone Inc.		385.3	3,121.1	-24.2	41.0	329	47.6	0.3	852	NO
0570092	Kinder Morgan Port Sutton Terminal LLC		362.4	3,087.1	-47.1	7.0	278	47.6	141	853	NO
0570022	Marathon Tampa Asphalt		362.2	3,087.2	-47.3	7.1	279	47.8	0.1	857	NO
0570056	Building Materials Manf. Corp.		362.2	3,087.2	-47.3	7.1	279	47.8	45	857	NO
0570029	Nitram, Inc.		362.5	3,089.0	-47.0	8.9	281	47.8	291	857	NO
0570039	TECO, Big Bend Station		361.9	3,075.0	-47.6	-5.1	264	47.9	5,942	857	YES
0570033	CSX Transportation, Inc.		362.4	3,089.0	-47.1	8.9	281	47.9	369	859	NO
0550022	Fountain Funeral Home		449.0	3,052.8	39.5	-27.3	125	48.0	0	860	NO

Table 6-6: Summary of all PM<sub>10</sub> Emitting Facilities in the Vicinity of the Mosaic Green Bay Plant

Plant ID	Facility Name	County	UTM Coordinates		Relative to Mosaic Green Bay <sup>a</sup>				Maximum PM Emissions (TPY)	Q, (TPY) Emission Threshold <sup>b,c</sup> (Dist - SID) x 20	Include in Modeling Analysis?
			East (km)	North (km)	X (km)	Y (km)	Direction (deg.)	Distance (km)			
<u>Modeling Area<sup>d</sup></u>											
0550016	Jahna Concrete, Inc.		450.1	3,054.3	40.6	-25.8	122	48.1	28	862	NO
0570238	Keys Concrete Industries, Inc.		363.2	3,093.3	-46.3	13.2	286	48.1	7	863	NO
0570163	Griffin Industries		364.1	3,096.4	-45.4	16.3	290	48.2	4	865	NO
0570281	Metro Redi-Mix Company		363.1	3,066.0	-46.4	-14.1	253	48.5	9	871	NO
0570024	Mosaic Phosphates Co.(Port Sutton Terminal)		361.5	3,087.5	-48.0	7.4	279	48.6	391	872	NO
1050249	Ewell Industries, Inc.		441.1	3,117.1	31.6	37.0	41	48.6	4	872	NO
0570299	Premdor Inc		362.1	3,092.5	-47.4	12.4	285	49.0	13	880	NO
0550007	Jahna Concrete		450.0	3,052.2	40.5	-27.9	125	49.2	39	884	NO
0570255	Lehigh Portland Cement Company		360.7	3,086.8	-48.8	6.7	278	49.3	11	885	NO
0570097	W R Bonsal Co		363.6	3,098.1	-45.9	18.0	291	49.3	2	886	NO
0570436	Bay City Sand, Inc.		362.8	3,096.1	-46.7	16.0	289	49.4	9	887	NO
0550024	Highlands Crematory, Inc.		450.7	3,052.8	41.2	-27.3	124	49.4	3	888	NO
0810010	FPL - Manatee Power Plant		367.3	3,054.2	-42.3	-25.9	238	49.6	9,472	892	YES
0570185	Rinker Materials Corporation		363.2	3,098.1	-46.3	18.0	291	49.7	15	894	NO
1050014	Davenport Mine-Standard Sand & Silica Co.	Polk	441.5	3,118.2	32.0	38.1	40	49.8	301	895	NO
0570087	Coreslab Structures (Tampa), Inc.		363.2	3,098.4	-46.3	18.3	292	49.8	2	896	NO
0570136	Verlite Co		363.0	3,098.1	-46.5	18.0	291	49.9	30	897	NO
0571217	Sea 3 Of FL, Inc. (Tampa LPG Terminal)		360.1	3,087.1	-49.4	7.0	278	49.9	1	898	NO
0570040	TECO, Gannon		360.1	3,087.5	-49.4	7.4	279	50.0	5,267	899	YES
0570014	Eastern Association Terminal Rock Port		360.2	3,088.9	-49.3	8.8	280	50.1	249	902	NO
0571151	Weyerhaeuser Company		362.8	3,098.3	-46.7	18.2	291	50.1	9	902	NO
0570003	CF Industries, Inc.		362.8	3,098.4	-46.7	18.3	291	50.2	8	903	NO
0570079	Ewell Industries, Inc.		362.8	3,098.4	-46.7	18.3	291	50.2	1	903	NO
0570459	Bausch & Lomb Pharmaceuticals		366.4	3,105.7	-43.1	25.6	301	50.2	1	903	NO
0571209	Apac-Florida, Inc.		359.9	3,088.1	-49.6	8.0	279	50.3	38	906	NO
0570052	Florida Rock Industries		362.3	3,097.5	-47.2	17.4	290	50.3	21	906	NO
0570031	Holnam Inc.		359.5	3,087.3	-50.0	7.2	278	50.5	29	910	NO
7770473	Conrad Yelvington Distributors		361.8	3,096.9	-47.7	16.8	289	50.6	27	912	NO
0570442	Gulf Marine Repair		360.3	3,091.9	-49.2	11.8	283	50.6	9	912	NO
0570252	Southdown, Inc.		359.3	3,087.1	-50.2	7.0	278	50.7	53	914	NO
0570127	Mckay Bay Refuse-To-Energy Facility		360.2	3,092.2	-49.3	12.1	284	50.8	172	915	NO
0570413	Kimmins Recycling Corporation		360.4	3,093.1	-49.1	13.0	285	50.8	15	916	NO
0570032	Southdown Inc.		360.1	3,092.2	-49.4	12.1	284	50.9	18	917	NO
0570226	Industrial Chemical & Supply Co		360.2	3,092.9	-49.3	12.8	285	50.9	0	919	NO
0570077	Verlite Company		360.2	3,093.0	-49.3	12.9	285	51.0	11	919	NO
0570229	General Chemical Corp		359.9	3,092.3	-49.6	12.2	284	51.1	5	922	NO

Table 6-6: Summary of all PM<sub>10</sub> Emitting Facilities in the Vicinity of the Mosaic Green Bay Plant

Plant ID	Facility Name	County	UTM Coordinates		Relative to Mosaic Green Bay <sup>a</sup>				Maximum PM Emissions (TPY)	Q, (TPY) Emission Threshold <sup>b,c</sup> (Dist - SID) x 20	Include in Modeling Analysis?
			East (km)	North (km)	X (km)	Y (km)	Direction (deg.)	Distance (km)			
<u>Modeling Area<sup>d</sup></u>											
0570466	Bulk Intermodal Services		360.1	3,093.2	-49.4	13.1	285	51.1	15	923	NO
0570103	Mosaic-Tampa		359.6	3,091.7	-49.9	11.6	283	51.2	8	925	NO
0570051	CF Industries		359.1	3,089.8	-50.4	9.7	281	51.3	15	926	NO
<u>Beyond Screening Area out to 100 km<sup>d</sup></u>											
0570038	TECO, Hookers Point		358.0	3,091.0	-51.5	10.9	282	52.6	1,536	953	YES
0970014	Progress Energy- Intercession City Plant		446.3	3,126.0	36.8	45.9	39	58.8	1,229	1077	YES
1030012	Progress Energy- Higgins Plant		336.5	3,098.4	-73.0	18.3	284	75.3	1,260	1405	NO
1030244	A-American Rent All		324.1	3,079.2	-85.4	-0.9	269	85.4	2,190	1608	YES
1010017	Progress Energy- Anclote Power Plant		324.4	3,118.7	-85.1	38.6	294	93.4	3,761	1769	YES

Note: NA = Not applicable, ND = No data, SID = Significant impact distance for the project

<sup>a</sup> The Mosaic Green Bay facility is located at UTM Coordinates: East 409.5 km  
North 3,080.1 km

<sup>b</sup> The significant impact distance (SID) for the project is estimated to be 5 km

<sup>c</sup> Based on the North Carolina Screening Threshold method, a background facility is included in the modeling analysis if the facility is beyond the modeling area and its emission rate is greater than the product of (Distance-SID) x 20.

<sup>d</sup> "Modeling Area" is the area in which the Project is predicted to have a significant impact. EPA recommends that all sources within this area be modeled.

"Screening Area" is the area that is 50 km beyond the modeling area. EPA recommends that sources be modeled that are expected to have a significant impact in the modeling area.

"Beyond Screening Area out to 100 km" is the area beyond the screening area and out to 100 km in which only large sources are included in the modeling.

Table 6-7. Summary of Facilities with NO<sub>x</sub> Emission Sources in the Vicinity of the Mosaic Green Bay Plant

Facility ID	Facility Name	County	Facility Location		Relative to Mosaic Green Bay <sup>a</sup>				Maximum NO <sub>x</sub> Emissions (TPY)	Q <sub>x</sub> (TPY) Emission Threshold <sup>b,c</sup> (Dist - SID) x 20	Include in Modeling Analysis ?
			East (km)	North (km)	X (km)	Y (km)	Direction (deg.)	Distance (km)			
<u>Modeling Area<sup>a</sup></u>											
1050217	MOSAIC GREEN BAY FERTILIZER, INC.	Polk	409.5	3,080.1	0.0	0.0	NA	0.0		SIA	YES
<u>Screening Area<sup>a</sup></u>											
1050217	POLK POWER PARTNERS, L.P.-MULBERRY	Polk	413.6	3,080.6	4.1	0.5	83	4.1	311	43	YES
1050097	CUSTOM CHEMICALS CORP.	Polk	408.0	3,085.5	-1.5	5.4	344	5.6	2	72	NO
1050048	MOSAIC PHOSPHATES (formerly MULBERRY PHOSPHATES, INC.	Polk	406.8	3,085.1	-2.7	5.0	332	5.7	78	74	YES
1050021	ASHLAND SPECIALTY CHEMICAL CO.	Polk	411.1	3,085.9	1.6	5.8	15	6.0	7	80	NO
1050148	GRAND EAGLE SERVICE, INC.	Polk	404.9	3,084.1	-4.6	4.0	311	6.1	2	82	NO
1050046	MOSIAC FERTILIZER LLC- BARTOW	Polk	409.8	3,086.6	0.3	6.5	3	6.5	246	90	YES
1050146	PAVEX CORP.	Polk	413.0	3,086.2	3.5	6.1	30	7.0	24	101	NO
1050234	HINES ENERGY COMPLEX (PROGRESS ENERGY)	Polk	414.3	3,073.9	4.8	-6.2	142	7.9	917	117	YES
1050055	MOSAIC PHOSPHATES CO. (S. PIERCE)	Polk	407.5	3,071.4	-2.0	-8.7	193	8.9	209	139	YES
1050056	MOSIAC PHOSPHATES CO. (PRAIRIE)	Polk	402.9	3,087.0	-6.6	6.9	316	9.5	61	151	NO
1050182	GEOLOGIC RECOVERY SYSTEMS	Polk	401.8	3,085.8	-7.7	5.7	307	9.6	70	152	NO
1050231	ORANGE COGENERATION LIMITED PARTNERSHIP	Polk	418.7	3,083.0	9.2	2.9	73	9.6	381	153	YES
1050319	CLARK ENVIRONMENTAL INC	Polk	401.2	3,086.6	-8.3	6.5	308	10.5	15	171	NO
1050057	MOSIAC PHOSPHATES CO. (NICHOLS)	Polk	398.4	3,084.2	-11.1	4.1	290	11.8	55	197	NO
1050047	AGRIFOS, L.L.C. (NICHOLS)	Polk	398.7	3,085.3	-10.8	5.2	296	12.0	311	200	YES
1050223	PROGRESS ENERGY- TIGER BAY	Polk	416.3	3,069.3	6.8	-10.8	148	12.8	802	215	YES
1050059	MOSIAC PHOSPHATES (NEW WALES)	Polk	396.7	3,079.4	-12.8	-0.7	267	12.8	640	216	YES
1050051	U.S. AGRI-CHEMICALS - FT. MEADE	Polk	416.0	3,069.0	6.5	-11.1	150	12.9	345	217	YES
1050026	ALCOA ALUMINA AND CHEMICALS, L.L.C.	Polk	416.8	3,069.5	7.3	-10.6	145	12.9	100	217	NO
1050233	TECO - POLK POWER STATION	Polk	402.5	3,067.4	-7.1	-12.8	209	14.6	2,507	251	YES
1050228	SADLER DRUM CO.	Polk	396.2	3,089.3	-13.3	9.2	305	16.2	0	283	NO
1050106	CITRUS WORLD, INC.	Polk	422.7	3,092.6	13.2	12.5	47	18.2	46	324	NO
1050100	SHELL EPOXY RESINS LLC	Polk	410.7	3,098.9	1.2	18.8	4	18.8	495	337	YES
1050127	JUICE BOWL PRODUCTS	Polk	409.4	3,099.9	-0.1	19.8	360	19.8	109	356	NO
1050297	POLK CO ANIMAL SERVICES	Polk	418.4	3,098.4	8.9	18.3	26	20.3	0	366	NO
1050298	POLK COUNTY NO. CENTRAL LANDFILL	Polk	418.9	3,098.5	9.4	18.4	27	20.7	58	374	NO
1050134	HEATH FUNERAL CHAPEL	Polk	407.1	3,101.9	-2.4	21.8	354	21.9	1	399	NO
1050003	LAKELAND ELECTRIC - LARSON	Polk	408.9	3,102.5	-0.6	22.4	358	22.4	3,825	408	YES
1050352	WINSTON PEAKING STATION	Polk	400.2	3,100.6	-9.3	20.5	336	22.5	240	410	NO
0570075	CORONET INDUSTRIES, INC.		393.8	3,096.3	-15.7	16.2	316	22.6	228	411	NO
1050009	FLORIDA TILE INDUSTRIES, INC.	Polk	405.4	3,102.4	-4.1	22.3	350	22.7	17	413	NO
0490015	HARDEE POWER PARTNERS,LTD		404.8	3,057.4	-4.7	-22.7	192	23.2	5,183	424	YES
1050272	LAKEVIEW CREMATORY	Polk	419.9	3,101.0	10.4	20.9	26	23.3	2	426	NO

Table 6-7. Summary of Facilities with NO<sub>x</sub> Emission Sources in the Vicinity of the Mosaic Green Bay Plant

Facility ID	Facility Name	County	Facility Location		Relative to Mosaic Green Bay <sup>a</sup>				Maximum NO <sub>x</sub> Emissions (TPY)	Q <sub>i</sub> (TPY) Emission Threshold <sup>b,c</sup> (Dist - SID) x 20	Include in Modeling Analysis ?
			East (km)	North (km)	X (km)	Y (km)	Direction (deg.)	Distance (km)			
<u>Modeling Area <sup>d</sup></u>											
1050034	MOSAIC PHOSPHATES- FORT LONESOME RD.	Polk	389.5	3,068.0	-20.0	-12.1	239	23.4	-576	428	NO
7770037	APAC - FLORIDA, INC. - TAMPA DIVISION		392.6	3,097.3	-16.9	17.2	316	24.1	0	442	NO
1050015	METLIFE - LAKELAND PLANT	Polk	399.0	3,101.8	-10.5	21.7	334	24.1	54	442	NO
0570460	JAMES HARDIE BUILDING PRODUCTS INC.		387.1	3,089.5	-22.4	9.4	293	24.3	27	447	NO
1050095	LAKELAND REGIONAL MEDICAL CENTER	Polk	406.4	3,104.3	-3.1	24.2	353	24.4	27	448	NO
1050158	HIGH PERFORMANCE SYSTEMS, INC.	Polk	428.1	3,096.1	18.6	16.0	49	24.5	1	450	NO
1050208	LAKELAND DRUM SERVICE, INC.	Polk	418.8	3,103.6	9.3	23.5	22	25.3	1	465	NO
1050174	PEPPERIDGE FARM, INC	Polk	403.3	3,104.8	-6.2	24.7	346	25.5	29	469	NO
1050096	FLORIDA DISTILLERS COMPANY	Polk	421.4	3,102.9	11.9	22.8	28	25.7	27	474	NO
1050221	AUBURNDALE POWER PARTNERS, LP	Polk	420.8	3,103.3	11.3	23.2	26	25.8	574	476	YES
1050334	AUBURNDALE POWER OSPREY	Polk	420.8	3,103.3	11.3	23.2	26	25.8	227	476	NO
1050004	LAKELAND ELECTRIC - MCINTOSH	Polk	409.0	3,106.2	-0.5	26.1	359	26.1	14,331	482	YES
0570417	INTERNATIONAL PAPER		391.7	3,099.3	-17.8	19.2	317	26.2	1	484	NO
1050023	CUTRALE CITRUS JUICES USA, INC	Polk	421.6	3,103.7	12.1	23.6	27	26.5	333	490	NO
1050007	OWENS-BROCKWAY GLASS CONTAINER INC.	Polk	423.4	3,102.8	13.9	22.7	31	26.6	300	492	NO
1050022	TENNECO PACKAGING (PCA)	Polk	423.4	3,102.8	13.9	22.7	31	26.6	4	492	NO
1050216	RIDGE GENERATING STATION, L.P.	Polk	427.0	3,100.3	17.5	20.2	41	26.8	394	495	NO
1050037	ALL TEMP STORAGE LLC	Polk	421.7	3,104.2	12.2	24.1	27	27.0	91	500	NO
1050076	INTERNATIONAL PAPER COMPANY-AUBURNDALE	Polk	421.7	3,104.3	12.2	24.2	27	27.1	6	502	NO
1050072	WINTERHAVEN HOSPITAL	Polk	428.7	3,100.4	19.2	20.3	43	27.9	11	519	NO
0570370	PARADISE, INC.		388.5	3,099.0	-21.0	18.9	312	28.3	3	525	NO
0570249	ALCOA EXTRUSIONS		385.6	3,097.0	-23.9	16.9	305	29.3	34	545	NO
1050099	AOC, L.L.C. (WAS ALPHA OWENS CORN'G)	Polk	401.0	3,108.5	-8.5	28.4	343	29.6	46	553	NO
0570320	DART CONTAINER CORP. OF FLORIDA		384.9	3,098.2	-24.6	18.1	306	30.5	15	571	NO
1050333	STEELE'S FAMILY FUNERAL SERVICES	Polk	433.6	3,099.7	24.1	19.6	51	31.0	1	581	NO
0570438	FLORIDA GAS TRANSMISSION CO.		391.9	3,106.6	-17.6	26.5	326	31.8	46	596	NO
0570091	TERRA ASGROW		388.6	3,104.6	-20.9	24.5	320	32.2	2	604	NO
1050002	CITRUS WORLD, INC.	Polk	441.0	3,087.3	31.5	7.2	77	32.3	1,086	606	YES
1050090	FLORIDA DISTILLERS	Polk	428.0	3,108.1	18.5	28.0	33	33.6	26	631	NO
0490043	VANDOLAH POWER COMPANY, LLC		408.8	3,044.5	-0.8	-35.6	181	35.6	1,008	672	YES
1050019	CARGILL CITRO-AMERICA, INC.	Polk	447.9	3,068.3	38.4	-11.8	107	40.2	412	763	NO
1050263	POLK CORRECTIONAL INSTITUTION	Polk	423.0	3,118.2	13.5	38.1	20	40.4	0	768	NO
0490003	THE MANCINI PACKING COMPANY		421.4	3,040.8	11.9	-39.3	163	41.1	3	781	NO
0570005	CF INDUSTRIES, INC., PLANT CITY PHOS		388.0	3,116.0	-21.5	35.9	329	41.8	694	797	NO
1050001	CITROSUCO NORTH AMERICA, INC.	Polk	451.6	3,085.5	42.1	5.4	83	42.4	86	809	NO

Table 6-7. Summary of Facilities with NO<sub>x</sub> Emission Sources in the Vicinity of the Mosaic Green Bay Plant

Facility ID	Facility Name	County	Facility Location		Relative to Mosaic Green Bay <sup>a</sup>				Maximum NO <sub>x</sub> Emissions (TPY)	Q <sub>i</sub> (TPY) Emission Threshold <sup>b,c</sup> (Dist - SID) x 20	Include in Modeling Analysis ?
			East (km)	North (km)	X (km)	Y (km)	Direction (deg.)	Distance (km)			
<u>Modeling Area<sup>d</sup></u>											
0570261	HILLSBOROUGH CO. R.R.F.		368.2	3,092.7	-41.3	12.6	287	43.2	1,542	824	YES
7770380	KEARNEY DEVELOPMENT CO.		368.7	3,094.8	-40.8	14.7	290	43.4	12	827	NO
0550035	SUNPURE, LIMITED		448.3	3,057.6	38.8	-22.5	120	44.9	48	858	NO
0571242	NATIONAL GYPSUM		364.7	3,075.6	-44.8	-4.5	264	45.0	10	860	NO
0570076	DELTA ASPHALT		372.1	3,105.4	-37.4	25.3	304	45.2	192	863	NO
0570061	TAMPA ARMATURE WORKS		365.6	3,091.7	-43.9	11.6	285	45.4	15	868	NO
0570321	MANTUA MANUFACTURING CO.		364.7	3,092.5	-44.8	12.4	285	46.5	13	890	NO
0570343	HOWARD F. CURREN AWT PLANT		364.0	3,089.5	-45.5	9.4	282	46.5	91	889	NO
0570008	MOSIAC FERTILIZER LLC- RIVERVIEW		362.9	3,082.5	-46.6	2.4	273	46.7	332	893	NO
0570317	JANET & CHARLIES WOOD RECYCLING FAC.		363.1	3,085.3	-46.4	5.2	276	46.7	200	894	NO
0570119	GULF COAST METALS		364.7	3,093.6	-44.8	13.5	287	46.8	13	896	NO
7771101	WOODRUFF AND SONS INC.		364.3	3,093.2	-45.2	13.1	286	47.0	6	901	NO
0570409	CONIGLIO C&D DEB		368.9	3,104.2	-40.6	24.1	301	47.2	49	904	NO
0570057	GULF COAST RECYCLING, INC.		364.0	3,093.5	-45.5	13.4	286	47.4	7	909	NO
7775052 <sup>e</sup>	WOODRUFF & SONS, INC.		363.6	3,092.3	-45.9	12.2	285	47.4	15	909	NO
0570022	MARATHON, ASHLAND PETROLEUM LLC		362.2	3,087.2	-47.3	7.1	279	47.8	3	917	NO
0570029	NITRAM, INC.		362.5	3,089.0	-47.0	8.9	281	47.8	302	917	NO
0570039	TECO - BIG BEND		361.9	3,075.0	-47.6	-5.1	264	47.9	82,624	917	YES
0550022	FOUNTAIN FUNERAL HOME		449.0	3,052.8	39.5	-27.3	125	48.0	0	920	NO
0570163	GRIFFIN INDUSTRIES		364.1	3,096.4	-45.4	16.3	290	48.2	60	925	NO
0810010	FP & L - MANATEE PLANT		367.3	3,054.2	-42.3	-25.9	238	49.6	22,732	952	YES
1050014	STANDARD SAND & SILICA--DAVENPORT MINE	Polk	441.5	3,118.2	32.0	38.1	40	49.8	91	955	NO
0571217	SEA 3 OF FLORIDA, INC.		360.1	3,087.1	-49.4	7.0	278	49.9	21	958	NO
0570040	BAYSIDE POWER STATION (TECO - GANNON)		360.1	3,087.5	-49.4	7.4	279	50.0	51,088	959	YES
<u>Beyond Screening Area out to 100 km<sup>d</sup></u>											
0570038	TECO - HOOKERS POINT		358.0	3,091.0	-51.5	10.9	282	52.6	4,558	1,013	YES
0970014	PROGRESS ENERGY- INTERCESSION CITY		446.3	3,126.0	36.8	45.9	39	58.8	15,035	1,137	YES
1030011	PROGRESS ENERGY- BARTOW PLANT		342.4	3,082.6	-67.1	2.5	272	67.1	15,374	1,303	YES
0270016	IPS AVON PARK CORPORATION (DESOTO COUNTY)		419.8	3,011.5	10.3	-68.6	172	69.4	4,612	1,347	YES
1030013	PROGRESS ENERGY- BAYBORO PLANT		338.8	3,071.3	-70.7	-8.8	263	71.2	3,838	1,385	YES
0810007	TROPICANA PRODUCTS, INC.-BRADENTON		346.8	3,040.9	-62.7	-39.2	238	73.9	1,220	1,439	NO
1030012	PROGRESS ENERGY- HIGGINS PLANT		336.5	3,098.4	-73.0	18.3	284	75.3	10,027	1,465	YES
1010056	PASCO COUNTY RESOURCE RECOVERY		348.8	3,138.8	-60.7	58.7	314	84.4	1,184	1,648	NO
1010017	PROGRESS ENERGY- ANCLOTE POWER PLANT		324.4	3,118.7	-85.1	38.6	294	93.4	13,292	1,829	YES



Table 6-7. Summary of Facilities with NO<sub>x</sub> Emission Sources in the Vicinity of the Mosaic Green Bay Plant

Facility ID	Facility Name	County	Facility Location		Relative to Mosaic Green Bay <sup>a</sup>				Maximum NO <sub>x</sub> Emissions (TPY)	Q <sub>x</sub> (TPY) Emission Threshold <sup>b,c</sup> (Dist - SID) x 20	Include in Modeling Analysis ?
			East (km)	North (km)	X (km)	Y (km)	Direction (deg.)	Distance (km)			
<u>Modeling Area<sup>d</sup></u>											
0530021	FLORIDA CRUSHED STONE CO., INC.		360.0	3,162.5	-49.5	82.4	329	96.1	6,557	1,882	YES
0530032	CENTRAL POWER & LIME, INC.		360.0	3,162.5	-49.5	82.4	329	96.1	13,846	1,882	YES

Note: NA = Not applicable, ND = No data, SID = Significant impact distance for the project

<sup>a</sup> The Mosaic Green Bay facility is located at UTM Coordinates:

East	409.5	km
North	3,080.1	km

<sup>b</sup> The significant impact distance (SID) for the project is estimated to be

2.0	km
-----	----

<sup>c</sup> Based on the North Carolina Screening Threshold method, a background facility is included in the modeling analysis if the facility is beyond the modeling area and its emission rate is greater than the product of (Distance-SID) x 20.

<sup>d</sup> "Modeling Area" is the area in which the Project is predicted to have a significant impact. EPA recommends that all sources within this area be modeled.

"Screening Area" is the area that is 50 km beyond the modeling area. EPA recommends that sources be modeled that are expected to have a significant impact in the modeling area.

"Beyond Screening Area out to 100 km" is the area beyond the screening area and out to 100 km in which only large sources are included in the modeling.

<sup>e</sup> Combined 7775052, 7775053, 7775054 into one facility since all located at same place and have same company name.

Table 6-8 Baseline (1974) PM-PM<sub>10</sub> and SO<sub>2</sub> Emission Rates and Stack and Operating Data for All Sources--Mosaic Green Bay

Source	PM-PM <sub>10</sub> Emissions				SO <sub>2</sub> Emissions				Location				Stack/Vent Release		Stack Vent		Actual Exhaust		Exhaust Gas Exit		Exhaust Gas Velocity	
	Hourly		Annual		Hourly		Annual		X		Y		Height		Diameter		Flow Rate		Temperature		Velocity	
	lb/hr	g/s	TPY	g/s	lb/hr	g/s	TPY	g/s	ft	m	ft	m	ft	m	ft	m	acfm	°F	K	ft/s	m/s	
Sulfuric Acid Plant No. 1	--	--	--	--	492.86	62.10	2,158.73	62.10 <sup>b</sup>					100	30.48	7.00	2.13	43,698	168.8	349	18.92	5.77	
Sulfuric Acid Plant No. 2	--	--	--	--	532.77	67.13	2,333.53	67.13 <sup>b</sup>					100	30.48	7.00	2.13	43,488	170.6	350	18.83	5.74	
Sulfuric Acid Plant No. 3	--	--	--	--	652.64	82.23	2,858.56	82.23 <sup>b</sup>	225.2	274.3			100	30.48	7.50	2.29	80,360	161.6	345	30.32	9.24	
Sulfuric Acid Plant No. 4	--	--	--	--	542.39	68.34	2,375.67	68.34 <sup>b</sup>	225.1	292.9			100	30.48	7.50	2.29	60,123	123.8	324	22.68	6.91	
Phosphate Rock Unloading and Storage-Scrubber (A-A)	3.87	0.49	16.95	0.49 <sup>a</sup>	--	--	--	--					90	27.43	3.00	0.91	420	77.0	298	35.71	10.89	
Unground Rock Storage Silo Filter Pt. 3 (B-B)	4.00	0.50	17.52	0.50 <sup>a</sup>	--	--	--	--					90	27.43	0.50	0.15	410	77.0	298	34.86	10.63	
Unground Rock Storage Silo Filter Pt. 4 (C-C)	3.43	0.43	15.02	0.43 <sup>a</sup>	--	--	--	--					90	27.43	0.50	0.15	416	75.2	297	35.37	10.78	
Unground Rock Storage Silo Filter Pt. 5 (D-D)	4.19	0.53	18.35	0.53 <sup>a</sup>	--	--	--	--					90	27.43	0.50	0.15	406	75.2	297	34.52	10.52	
Unground Rock Storage Silo Filter Pt. 6 (E-E)	3.81	0.48	16.69	0.48 <sup>a</sup>	--	--	--	--					90	27.43	0.50	0.15	420	75.2	297	35.71	10.89	
Unground Rock Storage Silo Filter Pt. 7 (F-F)	3.60	0.45	15.77	0.45 <sup>a</sup>	--	--	--	--					100	30.48	1.67	0.51	5,492	77.0	298	41.61	12.68	
Rock Grinding Filter Pt. 8 (G-G)	17.95	2.26	78.62	2.26 <sup>a</sup>	--	--	--	--					165	50.29	2.31	0.70	14,886	77.0	298	59.07	18.00	
100-Ton Ball Mill Dust Collector (H-H)	18.67	2.35	81.77	2.35 <sup>a</sup>	--	--	--	--					50	15.24	1.67	0.51	4,070	127.0	326	31.09	9.48	
40-Ton Ball Mill Dust Collector (H <sub>1</sub> -H <sub>2</sub> )	25.98	3.27	113.79	3.27 <sup>a</sup>	--	--	--	--					90	27.43	0.84	0.26	1,298	77.0	298	38.98	11.88	
Ground Rock Storage Silos Pt. 10 (I-I)	9.27	1.23	42.79	1.23 <sup>a</sup>	--	--	--	--					40	12.19	1.00	0.30	2,188	77.0	298	46.45	14.16	
Fluid Bed Calciner Feed Bin Filter Pt. 11 (J-J)	3.53	0.44	15.46	0.44 <sup>a</sup>	--	--	--	--					100	30.48	1.50	0.46	5,068	77.0	298	47.80	14.57	
Rock Storage Silo--No. 2 Phosphoric Acid Plant Feed (L-L)	3.61	0.45	15.81	0.45 <sup>a</sup>	--	--	--	--					185	56.39	5.00	1.52	11,476	149.0	338	9.74	2.97	
DAP Plant-R.G. Scrubber (S-S)	1.25	0.16	5.48	0.16 <sup>c</sup>	--	--	--	--					129	39.32	7.50	2.29	59,655	139.0	333	22.51	6.86	
DAP Plant-Dryer Scrubber (U-U)	19.00	2.39	83.22	2.39 <sup>c</sup>	--	--	--	--					120	36.58	5.00	1.52	70,436	139.0	333	59.79	18.22	
DAP Plant-Cooler Scrubber	19.00	2.39	83.22	2.39 <sup>c</sup>	--	--	--	--					110.5	33.68	2.50	0.76	5,789	130.0	328	19.66	5.99	
TSP Plant-Reactor & Blunger Scrubber (W-W)	1.01	0.13	4.43	0.13 <sup>c</sup>	--	--	--	--					129	39.32	7.50	2.29	91,324	190.0	361	34.45	10.50	
TSP Plant-Dryer Scrubber (Y <sub>1</sub> -Y <sub>2</sub> )	11.40	1.44	49.93	1.44 <sup>c</sup>	--	--	--	--					130.5	39.78	8.00	2.44	122,975	69.8	204	40.78	12.43	
Shipping & Storage-Storage Scrubbers <sup>d</sup> (Z <sub>1</sub> -Z <sub>2</sub> )	4.52	0.57	19.80	0.57 <sup>c</sup>	--	--	--	--					130.5	39.78	4.00	1.22	24,879	88.0	304	33.00	10.06	
Shipping & Storage-Shipping Scrubbers (Z <sub>1</sub> -Z <sub>2</sub> )	3.45	0.43	15.11	0.43 <sup>c</sup>	--	--	--	--														

<sup>a</sup> From the 1975 AOR submitted by Lamland Industries to the Dept. of Air and Water Pollution Control, West Central Region, March 1, 1976. PM was not reported in the 1974 AOR

<sup>b</sup> From the 1974 AOR submitted by Lamland Industries to the Dept. of Air and Water Pollution Control, West Central Region, March 24, 1975

<sup>c</sup> Emissions and stack and operating data based on stack test data from September 1978

<sup>d</sup> Stack and operating data from the 1974 AOR (see reference <sup>b</sup> above)

Table 6-9. Baseline (1988) NO<sub>x</sub> Emission Rates and Stack and Operating Data for All Sources--Mosaic Green Bay

Source	NO <sub>x</sub> Emissions (TPY)	Location				Stack/Vent Release Height		Stack/Vent Diameter		Actual Exhaust Flow Rate (acfm)	Exhaust Gas Exit Temperature		Exhaust Gas Velocity	
		X		Y		ft	m	ft	m		°F	K	ft/s	m/s
		ft	m	ft	m									
MAP/DAP/TSP Dryer <sup>b</sup>	6.43 <sup>a</sup>					129.0	39.32	7.5	2.29	68,878	630.0	605	25.98	7.92
DAP Plant Dryer <sup>c</sup>	14.93 <sup>a</sup>		159.3		3.32	129.5	39.47	7.5	2.29	92,000	133.7	330	34.71	10.58
Therminol Heater <sup>d</sup>	338.68 <sup>a</sup>		144.3		243.8	95.0	28.96	5.5	1.68	20,600	117.0	320	14.45	4.40
Sulfuric Acid Plant No. 3 <sup>e</sup>	33.91 <sup>f</sup>		225.2		274.3	100	30.48	7.50	2.29	80,360	161.6	345	30.32	9.24
Sulfuric Acid Plant No. 4 <sup>e</sup>	32.46 <sup>f</sup>		225.1		292.9	100	30.48	7.50	2.29	60,123	123.8	324	22.68	6.91

Note: The Sulfuric Acid Plants Nos. 1 and 2 existed, but did not operate during the year (based on 1987 AOR).

<sup>a</sup> From the 1987 AOR submitted by Farmland Industries to the Dept. Environmental Regulation, February 29 and May 20, 1988.

<sup>b</sup> Operating parameters from 9/28/88 stack test data.

<sup>c</sup> Stack and operating parameters are from stack test data (10/4/90).

<sup>d</sup> Operating parameters based on design data.

<sup>e</sup> Stack and operating parameters from the 1975 AOR.

<sup>f</sup> Calculated from the annual H<sub>2</sub>SO<sub>4</sub> production rate and emission factor of 0.12 lb NO<sub>x</sub>/ton H<sub>2</sub>SO<sub>4</sub>. Annual production rate from the 1987 AOR (see reference <sup>a</sup>).

Table 6-10. Summary of SO<sub>2</sub> and SAM Emission Rates for the Proposed Project--Mosaic Green Bay

Source	EU ID	Average Actual Operating Hours <sup>c</sup> (hr/yr)	SO <sub>2</sub> Emissions				SAM Emissions			
			Hourly		Annual		Hourly		Annual	
			lb/hr	g/s	TPY	g/s	lb/hr	g/s	TPY	g/s
<b><u>Current Actual Emissions<sup>a</sup></u></b>										
South DAP Plant--Stack B (Dryer)	007	7,253	0.01	0.0006	0.02	0.0006	0.0	0.0 <sup>d</sup>	0.0	0.0 <sup>d</sup>
North MAP/DAP Plant-Main Stack	029	7,253	0.01	0.0009	0.02	0.0009	0.0	0.0 <sup>d</sup>	0.0	0.0 <sup>d</sup>
<b><u>Future Potential Emissions<sup>b</sup></u></b>										
South DAP Plant--Stack B (Dryer)	007	--	3.16	0.398	13.82	0.398	0.053	0.0067	0.234	0.0067
North MAP/DAP Plant-Main Stack	029	--	2.63	0.331	11.52	0.331	0.044	0.0056	0.195	0.0056

<sup>a</sup> Emissions from Table 2-3. Hourly emissions were calculated based on the actual annual numbers and the average actual operating hours.

<sup>b</sup> Emissions from Tables 2-2 and 2-4.

<sup>c</sup> From the 2003 and 2004 AORs.

<sup>d</sup> No fuel oil was consumed for 2003 and 2004, therefore there were no SAM emissions.

Table 6-11. Mosaic Green Bay Property Boundary Receptors Used in Modeling Analysis

Coordinates <sup>a</sup>				Coordinates <sup>a</sup>				Coordinates <sup>a</sup>			
X		Y		X		Y		X		Y	
ft	m	ft	m	ft	m	ft	m	ft	m	ft	m
-6001	-1829.2	-461	-140.52	-5612	-1710.6	6643	2024.88	6791	2069.78	2523	769.04
-6001	-1,829	901	274	-5326	-1623.4	6721	2048.68	6791	2069.78	2198	669.98
-7901	-2,408	901	274	-4927	-1501.9	7000	2133.48	6791	2069.78	1873	570.92
-9499	-2,895	1770	539	-4815	-1467.6	7200	2194.48	6791	2069.78	1548	471.86
-9801	-2,987	3000	914	-4377	-1334.1	7400	2255.48	6791	2069.78	1223	372.79
-9000	-2,743	3607	1,099	-4052	-1234.9	7400	2255.48	6791	2069.78	898	273.73
-7901	-2,408	6019	1,834	-3726	-1135.8	7400	2255.48	6791	2069.78	573	174.67
-5040	-1,536	6799	2,072	-3401	-1036.6	7400	2255.48	6791	2069.78	248	75.61
-4702	-1,433	7400	2,255	-3076	-937.47	7400	2255.48	6791	2069.78	-77	-23.46
1804	550	7400	2,255	-2750	-838.32	7400	2255.48	6643	2024.78	-635	-193.69
1640	500	4798	1,462	-2425	-739.17	7400	2255.48	6495	1979.78	-869	-264.85
6791	2,070	4798	1,462	-2100	-640.02	7400	2255.48	6348	1934.78	-1102	-336.02
6791	2,070	-402	-123	-1775	-540.87	7400	2255.48	6200	1889.78	-1336	-407.19
5905	1,800	-1803	-550	-1449	-441.72	7400	2255.48	6052	1844.78	-1569	-478.35
4701	1,433	-1803	-550	-1124	-342.57	7400	2255.48	5604	1708.03	-1803	-549.52
3894	1,187	-461	-141	-799	-243.42	7400	2255.48	5303	1616.28	-1803	-549.52
-6001	-1,829	-189	-58	-473	-144.27	7400	2255.48	5002	1524.53	-1803	-549.52
-6001	-1,829	84	25	-148	-45.12	7400	2255.48	4539	1383.58	-1535	-467.72
-6001	-1,829	356	108	177	54.03	7400	2255.48	4378	1334.38	-1266	-385.92
-6001	-1,829	628	191	503	153.18	7400	2255.48	4216	1285.18	-998	-304.12
-6318	-1,926	901	274	828	252.33	7400	2255.48	4055	1235.98	-729	-222.32
-6635	-2,022	901	274	1153	351.48	7400	2255.48	3574	1089.49	-461	-140.52
-6951	-2,119	901	274	1478	450.63	7400	2255.48	3255	992.2	-461	-140.52
-7268	-2,215	901	274	1783	543.53	7075	2156.36	2936	894.91	-461	-140.52
-7584	-2,312	901	274	1763	537.28	6749	2057.23	2617	797.62	-461	-140.52
-8167	-2,489	1045	319	1742	531.03	6424	1958.11	2298	700.33	-461	-140.52
-8434	-2,571	1190	363	1722	524.78	6099	1858.98	1978	603.04	-461	-140.52
-8700	-2,652	1335	407	1701	518.53	5774	1759.86	1659	505.75	-461	-140.52
-8966	-2,733	1480	451	1681	512.28	5449	1660.73	1340	408.46	-461	-140.52
-9232	-2,814	1625	495	1660	506.03	5123	1561.61	1021	311.17	-461	-140.52
-9574	-2918.2	2078	633.23	1962	597.9	4798	1462.48	702	213.88	-461	-140.52
-9650	-2941.2	2385	726.98	2284	696.03	4798	1462.48	383	116.59	-461	-140.52
-9725	-2964.2	2693	820.73	2605	794.15	4798	1462.48	63	19.3	-461	-140.52
-9600	-2926.2	3152	960.73	2927	892.28	4798	1462.48	-256	-77.99	-461	-140.52
-9400	-2865.2	3304	1006.98	3249	990.41	4798	1462.48	-575	-175.28	-461	-140.52
-9200	-2804.2	3455	1053.23	3571	1088.53	4798	1462.48	-894	-272.57	-461	-140.52
-8878	-2706	3875	1181.15	3893	1186.65	4798	1462.48	-1213	-369.87	-461	-140.52
-8756	-2668.8	4143	1262.81	4215	1284.78	4798	1462.48	-1533	-467.16	-461	-140.52
-8634	-2631.6	4411	1344.48	4537	1382.91	4798	1462.48	-1852	-564.45	-461	-140.52
-8512	-2594.3	4679	1426.15	4859	1481.03	4798	1462.48	-2171	-661.74	-461	-140.52
-8389	-2557.1	4947	1507.81	5181	1579.16	4798	1462.48	-2490	-759.03	-461	-140.52
-8267	-2519.9	5215	1589.48	5503	1677.28	4798	1462.48	-2809	-856.32	-461	-140.52
-8145	-2482.7	5483	1671.15	5825	1775.41	4798	1462.48	-3129	-953.61	-461	-140.52
-8023	-2445.4	5751	1752.81	6147	1873.53	4798	1462.48	-3448	-1050.9	-461	-140.52
-7615	-2321	6097	1858.28	6469	1971.66	4798	1462.48	-3767	-1148.2	-461	-140.52
-7329	-2233.8	6175	1882.08	6791	2069.78	4473	1363.42	-4086	-1245.5	-461	-140.52
-7043	-2146.6	6253	1905.88	6791	2069.78	4148	1264.36	-4405	-1342.8	-461	-140.52
-6757	-2059.4	6331	1929.68	6791	2069.78	3823	1165.29	-4725	-1440.1	-461	-140.52
-6471	-1972.2	6409	1953.48	6791	2069.78	3498	1066.23	-5044	-1537.4	-461	-140.52
-6184	-1885	6487	1977.28	6791	2069.78	3173	967.17	-5363	-1634.6	-461	-140.52
-5898	-1797.8	6565	2001.08	6791	2069.78	2848	868.11	-5682	-1731.9	-461	-140.52

<sup>a</sup> Relative to the SW corner of the DAP/MAP Storage Building.

Note: m = meter  
ft = foot

Table 6-12. Chassahowitzka NWA Receptors Used in the Modeling Analysis

Receptor No.	UTM Coordinates, Zone 17	
	East (km)	North (km)
1	337.5	3,166.0
2	338.3	3,166.0
3	339.1	3,166.0
4	339.9	3,166.0
5	336.7	3,167.0
6	339.9	3,166.9
7	335.9	3,167.9
8	339.9	3,167.8
9	335.9	3,168.8
10	339.9	3,168.8
11	336.7	3,169.7
12	340.0	3,169.7
13	336.7	3,170.6
14	340.0	3,170.6
15	336.7	3,171.6
16	340.0	3,171.5
17	336.7	3,172.5
18	337.6	3,172.5
19	338.4	3,172.5
20	339.2	3,172.5
21	340.0	3,172.4
22	340.8	3,173.4
23	340.8	3,174.3
24	341.6	3,174.3
25	335.1	3,175.3
26	336.0	3,175.3
27	336.8	3,175.3
28	337.6	3,175.2
29	338.4	3,175.2
30	340.8	3,175.2
31	341.7	3,175.2
32	342.5	3,175.2
33	334.3	3,176.2
34	338.4	3,176.2
35	342.5	3,176.1
36	333.5	3,177.2
37	338.4	3,177.1
38	331.9	3,178.1
39	332.7	3,178.1
40	333.6	3,178.1
41	338.4	3,178.0
42	333.6	3,179.0
43	338.5	3,178.9
44	334.4	3,179.9
45	338.5	3,179.9
46	339.28	3179.84
47	334.41	3180.83
48	338.48	3180.77
49	334.42	3181.75
50	338.49	3181.7
51	334.43	3182.68
52	338.5	3182.62
53	334.45	3183.6
54	335.26	3183.59
55	336.07	3183.58
56	336.89	3183.57
57	337.7	3183.56
58	338.52	3183.54

Table 6-13. Building Dimensions Used in the Modeling Analysis, Mosaic Green Bay

Structure	Height		Length		Width	
	ft	m	ft	m	ft	m
MAP/DAP Storage	68.0	20.7	360.0	109.7	153.0	46.6
Shipping Building - Lower Level	80.0	24.4	80.0	24.4	45.6	13.9
Shipping Building - Upper Level	112.0	34.1	80.0	24.4	36.4	11.1
MAP/DAP Plant - Upper Level	106.0	32.3	48.0	14.6	97.3	29.7
MAP/DAP Plant - Lower Level	90.0	27.4	107.3	32.7	97.3	29.7
Phosphoric Acid Plant No. 1	75.0	22.9	80.9	24.7	221.4	67.5
Phosphoric Acid Plant No. 2	74.0	22.6	74.1	22.6	71.5	21.8
Unground Rock Tank Column	81.0	24.7	34.8	10.6	175.0	53.3
Ground Rock Tank <sup>a</sup>	30.0	9.1	35.2	10.7	35.2	10.7
Phosphoric Acid No. 2 West Tank <sup>a</sup>	30.0	9.1	60.0	18.3	60.0	18.3
Phosphoric Acid No. 2 East Tank <sup>a</sup>	30.0	9.1	60.0	18.3	60.0	18.3
Phosphoric Acid Blend Tank No 9 <sup>a</sup>	30.0	9.1	60.0	18.3	60.0	18.3
Phosphoric Acid No. 1 East Tank <sup>a</sup>	30.0	9.1	39.8	12.1	39.8	12.1
Phosphoric Acid No. 1 West Tank <sup>a</sup>	30.0	9.1	41.2	12.6	41.2	12.6

<sup>a</sup> Tank is located nearby a stack vent.

Table 6-14. Maximum Predicted Increase in Pollutant Impacts Due to the Proposed Project Only, Mosaic Green Bay

Averaging Period	Concentration <sup>a</sup> ( $\mu\text{g}/\text{m}^3$ )	Receptor Location <sup>b</sup>		Time Period (YYMMDDHH)	EPA Significant Impact Level ( $\mu\text{g}/\text{m}^3$ )
		X (m)	Y (m)		
<b><u>PM<sub>10</sub></u></b>					
Annual	6.52	-175.3	-140.5	91123124	1
	5.93	-175.3	-140.5	92123124	
	5.70	-78	-140.5	93123124	
	6.06	-78	-140.5	94123124	
	5.66	-78	-140.5	95123124	
High 24-Hour	36.0	-175.3	-140.5	91102924	5
	35.0	-175.3	-140.5	92022124	
	39.0	-78	-140.5	93031924	
	34.0	-100	-200	94120124	
	32.7	408.5	-140.5	95022124	
<b><u>NO<sub>2</sub></u><sup>c</sup></b>					
Annual	1.51	-175.3	-140.5	91123124	1
	1.29	-78	-140.5	92123124	
	1.13	-100	-200	93123124	
	1.30	-100	-200	94123124	
	1.01	-200	-200	95123124	

<sup>a</sup> Based on 5 years (1991-1995) of surface and upper air meteorological data from the National Weather Service stations in Tampa and Ruskin, respectively.

<sup>b</sup> Relative to the southwest corner of the MAP/DAP storage building.

<sup>c</sup> Using EPA's national default NO<sub>2</sub>/NO<sub>x</sub> ratio of 0.75.

Note: YYMMDDHH = Year, Month, Day, Hour Ending



Table 6-15. Maximum Predicted AAQS Impacts for the Screening Analysis, Mosaic Green Bay

Averaging Period	Concentration <sup>a</sup> ( $\mu\text{g}/\text{m}^3$ )	Receptor Location <sup>b</sup>		Time Period (YYMMDDHH)
		X (m)	Y (m)	
<b>PM<sub>10</sub></b>				
Annual	11.8	-175.3	-140.5	91123124
	11.6	-175.3	-140.5	92123124
	11.8	-78.0	-140.5	93123124
	11.8	-78.0	-140.5	94123124
	11.8	-78.0	-140.5	95123124
H6H 24-Hour	39.5	-78.0	-140.5	94012024
<b>NO<sub>2</sub></b>				
Annual	8.34	-175.3	-140.5	91123124
	9.04	-200	-200	92123124
	8.63	-100	-200	93123124
	8.13	-100	-200	94123124
	8.29	-200	-200	95123124

<sup>a</sup> Based on 5 years (1991-1995) of surface and upper air meteorological data from the National Weather Service stations in Tampa and Ruskin, respectively.

<sup>b</sup> Relative to the southwest corner of the MAP/DAP storage building.

Note: YYMMDDHH = Year, Month, Day, Hour Ending

H6H = 6th-Highest Concentration in 5 Years

Table 6-16. Maximum Predicted AAQS Impacts for the Refined Analysis, Mosaic Green Bay

Averaging Period	Concentration <sup>a</sup> ( $\mu\text{g}/\text{m}^3$ )			Receptor Location <sup>b</sup>		Time Period (YYMMDDHH)	Florida AAQS ( $\mu\text{g}/\text{m}^3$ )
	Total	Modeled Sources	Background	X (m)	Y (m)		
<b><u>PM<sub>10</sub></u></b>							
Annual	32.8	11.8	21	-175.3	-140.5	91123124	50
H6H 24-Hour	89.5	39.5	50	-78.0	-140.5	94012024	150
<b><u>NO<sub>2</sub></u></b>							
Annual	29.0	9.04	20	-200.0	-200.0	92123124	100

<sup>a</sup> Based on 5 years (1991-1995) of surface and upper air meteorological data from the National Weather Service stations in Tampa and Ruskin, respectively.

<sup>b</sup> Relative to the southwest corner of the MAP/DAP storage building.

Note: YYMMDDHH = Year, Month, Day, Hour Ending  
H6H = 6th-Highest Concentration in 5 Years

Table 6-17. Maximum Predicted PSD Class II Increment Consumption for the Screening Analysis,  
Mosaic Green Bay

Averaging Period	Concentration <sup>a</sup> ( $\mu\text{g}/\text{m}^3$ )	Receptor Location <sup>b</sup>		Time Period (YYMMDDHH)
		Direction (degrees)	Distance (m)	
<u>PM<sub>10</sub></u> Annual	2.91	4000	500	91123124
	2.11	4000	500	91123124
	2.44	4500	750	91123124
	2.54	4500	750	91123124
	2.16	4750	750	91123124
H2H 24-Hour	17.2	4000	500	91093024
	15.2	4000	250	92122924
	19.3	4250	750	93061024
	18.2	4000	250	94120124
	15.6	4000	750	95110124
<u>NO<sub>x</sub></u> Annual	2.27	-800	-2000	91123124
	2.34	600	-2000	92123124
	2.32	900	-2000	93123124
	2.24	900	-2000	94123124
	2.11	500	-2000	95123124

<sup>a</sup> Based on 5 years (1991-1995) of surface and upper air meteorological data from the National Weather Service stations in Tampa and Ruskin, respectively.

<sup>b</sup> Relative to the southwest corner of the MAP/DAP storage building.

Note: YYMMDDHH = Year, Month, Day, Hour Ending

H2H = Highest, second-highest concentration in 5 years

Table 6-18. Maximum Predicted PSD Class II Increment Consumption for the Refined Analysis,  
Mosaic Green Bay

Averaging Period	Concentration <sup>a</sup> ( $\mu\text{g}/\text{m}^3$ )	Receptor Location <sup>b</sup>		Time Period (YYMMDDHH)	Class II PSD Increments ( $\mu\text{g}/\text{m}^3$ )
		Direction (degrees)	Distance (m)		
<b><u>PM<sub>10</sub></u></b>					
Annual	3.30	4100	500	91123124	17
	2.95	4600	600	92123124	
	3.17	4600	600	93123124	
	3.16	4100	400	94123124	
	2.86	4600	700	95123124	
H2H 24-Hour	18.7	4100	500	91020224	30
	18.8	4100	400	92123124	
	22.5	4100	400	93100624	
	18.7	4100	400	94021824	
	19.5	4300	300	95111224	
<b><u>NO<sub>x</sub></u></b>					
Annual	2.34	-800	-2000	91123124	25

<sup>a</sup> Based on 5 years (1991-1995) of surface and upper air meteorological data from the National Weather Service stations in Tampa and Ruskin, respectively.

<sup>b</sup> Relative to the southwest corner of the MAP/DAP storage building.

Note: YYMMDDHH = Year, Month, Day, Hour Ending

H2H = Highest, second-highest concentration in 5 years

Table 6-19. Maximum Predicted Impacts for the Proposed Project Only at the Chassahowitzka PSD Class I Area Using the CALPUFF Model, Mosaic Green Bay

Averaging Period	Year	Concentration <sup>a</sup> ( $\mu\text{g}/\text{m}^3$ )	Proposed EPA PSD Class I Significant Impact Level ( $\mu\text{g}/\text{m}^3$ )
<u>PM<sub>10</sub></u> Annual	1990	0.0015	0.2
	1992	0.0017	
	1996	0.0019	
24-Hour	1990	0.029	0.3
	1992	0.029	
	1996	0.027	
<u>NO<sub>2</sub></u> Annual	1990	0.0003	0.1
	1992	0.0004	
	1996	0.0004	

<sup>a</sup> Concentrations predicted with the CALPUFF model and CALMET-developed domains for central Florida for 1990, 1992, and 1996.

Table 6-20. Maximum Predicted Increase in Fluoride Impacts Due to the Proposed Project at the Site Vicinity, Mosaic Green Bay

Averaging Period	Concentration <sup>a</sup> ( $\mu\text{g}/\text{m}^3$ )	Receptor Location <sup>b</sup>		Time Period (YYMMDDHH)
		Direction (degree)	Distance (m)	
Annual	1.371	-175.3	-140.5	91123124
	1.261	-175.3	-140.5	92123124
	1.216	-78	-140.5	93123124
	1.291	-78	-140.5	94123124
	1.226	-175.3	-140.5	95123124
High 24-Hour	7.278	-200	-200	91010424
	6.966	-175.3	-140.5	92022124
	7.912	-100	-200	93111124
	7.665	-100	-200	94120124
	6.960	100	-200	95121024
High 8-Hour	10.316	-100	-200	91121708
	9.970	-78	-140.5	92052308
	10.203	-100	-200	93112624
	10.672	-100	-200	94120124
	11.083	505.8	-140.5	95091724
High 1-Hour	19.003	311.2	-140.5	91122419
	19.538	311.2	-140.5	92070522
	19.538	311.2	-140.5	93070421
	19.126	-100	-300	94061421
	19.462	311.2	-140.5	95070203

<sup>a</sup> Based on 5 years (1991-1995) of surface and upper air meteorological data from the National Weather Service stations in Tampa and Ruskin, respectively.

<sup>b</sup> Relative to southwest corner of MAP/DAP storage building.

Note: YYMMDDHH = Year, Month, Day, Hour Ending.

Table 6-21. Maximum Predicted Increase in Fluoride Impacts  
Due to the Proposed Project at the Chassahowitzka  
PSD Class I Area, Mosaic Green Bay

Averaging Period	Year	Concentration <sup>a</sup> ( $\mu\text{g}/\text{m}^3$ )
Annual	1990	0.0005
	1992	0.0006
	1996	0.0006
24-Hour	1990	0.009
	1992	0.01
	1996	0.008
8-Hour	1990	0.019
	1992	0.026
	1996	0.02
3-Hour	1990	0.031
	1992	0.034
	1996	0.039
1-Hour	1990	0.036
	1992	0.046
	1996	0.046

<sup>a</sup> Concentrations predicted with the CALPUFF model and CALMET-developed domains for central Florida for 1990, 1992, and 1996.

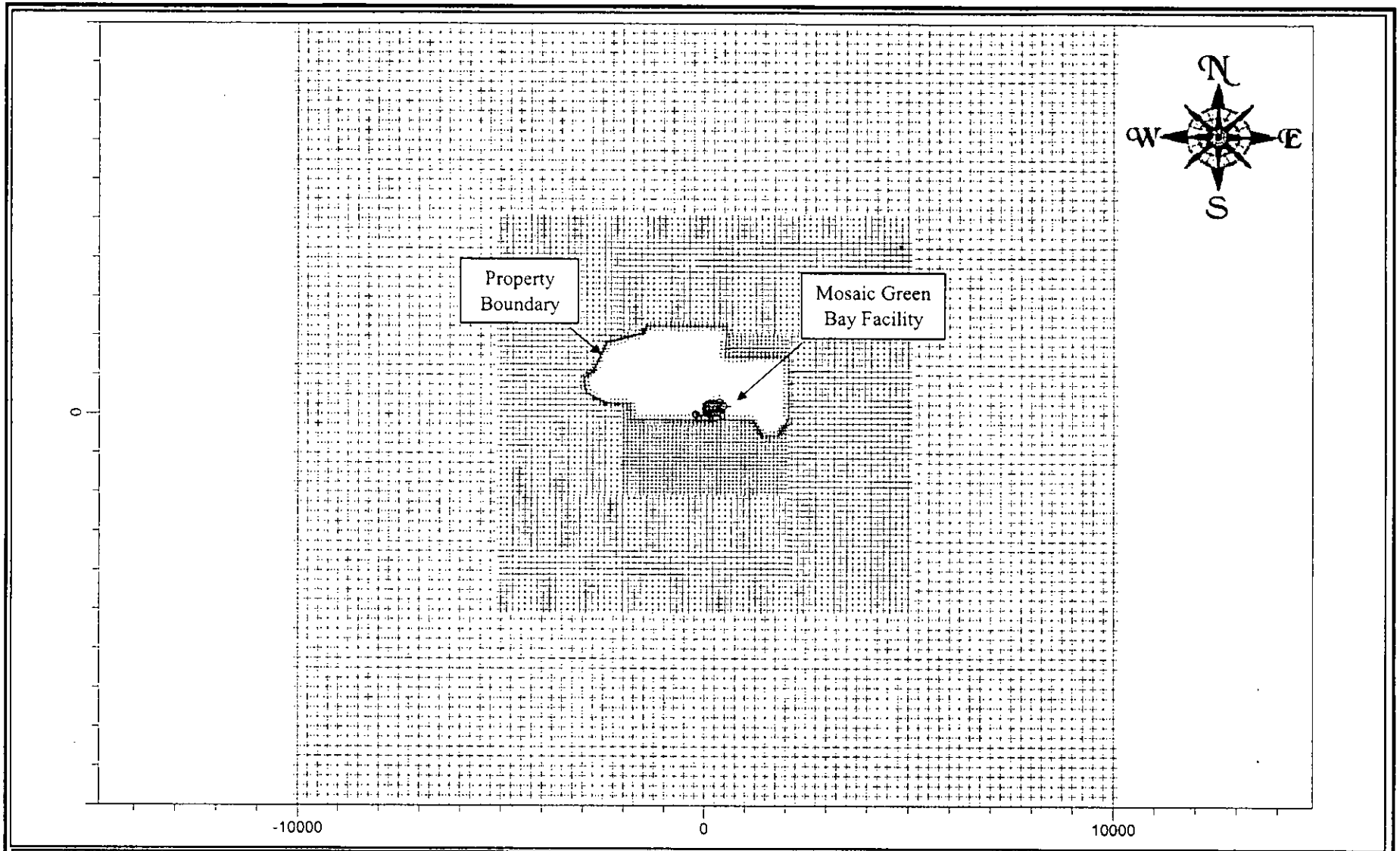

Figure 6-1  
Property Boundary and Receptor Grid Used for the Air Modeling Analyses  
Mosaic Green Bay, Bartow, Florida

Source: Golder, 2005.





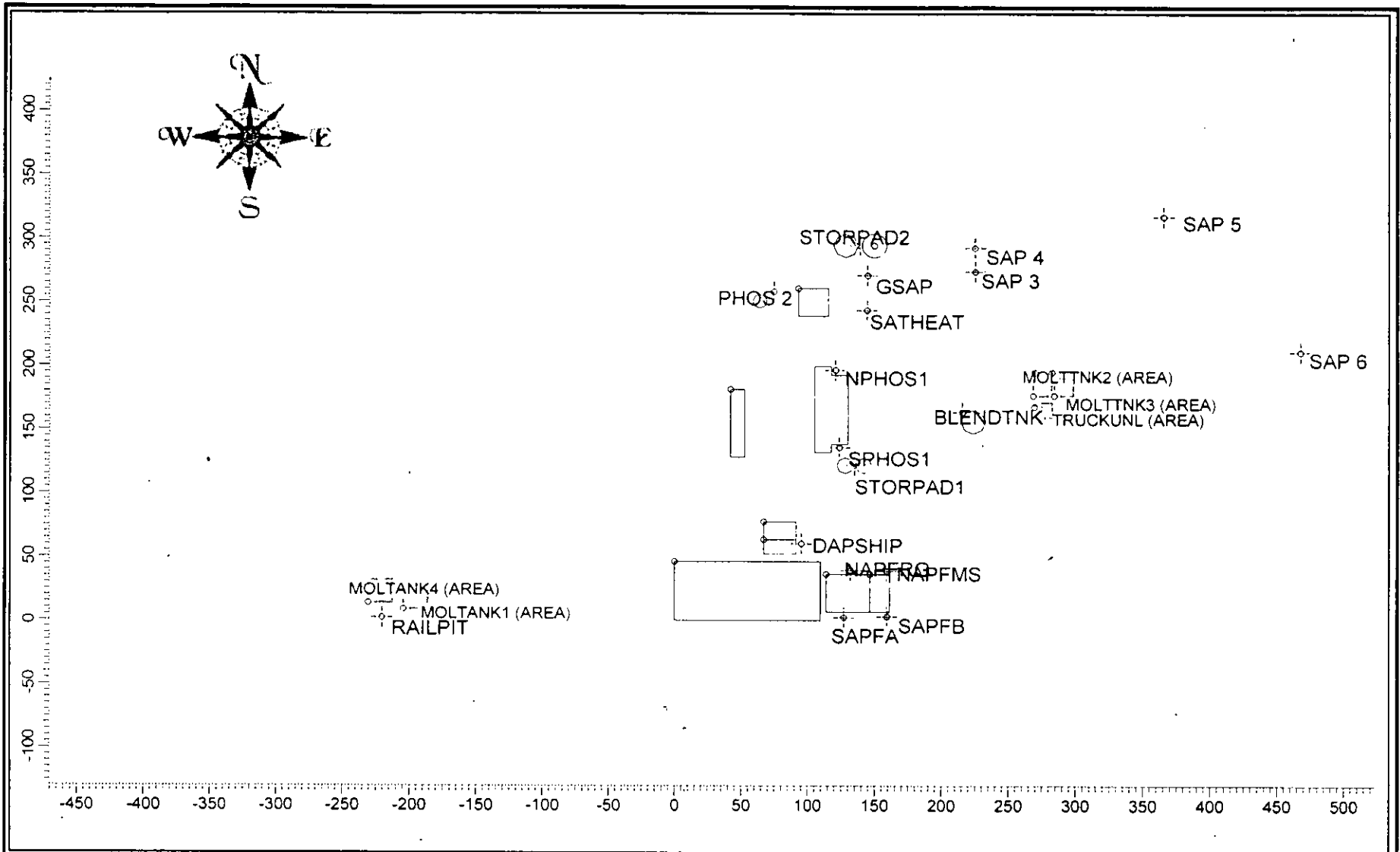

Figure 6-2  
Building and Stack Locations  
Mosaic Green Bay, Bartow, Florida

Source: Golder, 2005.



## 7.0 ADDITIONAL IMPACT ANALYSIS

### 7.1 INTRODUCTION

Mosaic is proposing to modify its existing facility in Green Bay, Florida. The facility is subject to the PSD new source review requirements for PM/PM<sub>10</sub>, NO<sub>x</sub>, and F. The additional impact analysis and the Class I area analysis addresses these pollutants.

The analysis addresses the potential impacts on vegetation, soils, and wildlife of the surrounding area, including direct growth, and the nearest Class I area due to Mosaic's proposed modification. The nearest Class I area is the Chassahowitzka NWA, located approximately 110 km northwest of the Green Bay plant. In addition, potential impacts resulting from the proposal modification upon visibility and nitrogen deposition in the Class I area are assessed.

The analysis will demonstrate that the increase in impacts due to the proposed increase in emissions is extremely low. Regardless of the existing conditions in the vicinity of the site or in the Class I areas, the proposed project will not cause any significant adverse effects due to the predicted low impacts upon these areas.

### 7.2 SOIL, VEGETATION, AND AQRV ANALYSIS METHODOLOGY

In the foregoing analysis, the maximum air quality impacts predicted to occur in the vicinity of Mosaic Green Bay and in the Class I area due to the increase in emissions are used. These impacts are summarized in Section 6.0 and Table 7-1, based on the modeling described in Section 6.0.

The analysis involved predicting worst-case maximum short- and long-term concentrations of pollutants in the vicinity of the plant and in the Class I areas and comparing the maximum predicted concentrations to lowest observed effect levels for AQRVs or analogous organisms. In conducting the assessment, several assumptions were made as to how pollutants interact with the different matrices, i.e., vegetation, soils, wildlife, and aquatic environment.

A screening approach was used to evaluate potential effects by comparison of the maximum predicted ambient concentrations of air pollutants of concern with effect threshold limits for both vegetation and wildlife as reported in the scientific literature. A literature search was conducted which specifically addressed the effects of air contaminants on plant species reported to occur in the vicinity of the plant and the Class I area. It was recognized that effects threshold information is not available

for all species found in the Chassahowitzka NWA, although studies have been performed on a few of the common species and on other similar species which can be used as models.

### **7.3 IMPACTS IN THE VICINITY OF THE MOSAIC GREEN BAY PLANT**

Land use in the vicinity of the Mosaic Green Bay site is primarily phosphate mine lands interspersed with areas of improved pasture and mixed forest. According to the USDA Soil Survey of Polk County, the Mosaic site is underlain by the Urban Land soil series, while dominant soil series in the vicinity of the site include Arents-Water Complex, clayey Hydraquents, and Gypsum Land. These are severely disturbed soils resulting from strip mining, clay settling areas, and phosphate processing by-product (gypsum stacks). With the exception of Gypsum Land, these soils are typically neutral to alkaline in nature due to the high limestone and clay content.

Since the majority of the underlying substrate is neutral to alkaline, any acidifying effects of NO<sub>x</sub> deposition on soils in the vicinity of the project would be buffered. The PM/PM<sub>10</sub> emissions are composed primarily of limestone, which is a naturally occurring substance in the area. The additional PM/PM<sub>10</sub>, NO<sub>x</sub>, or F concentrations resulting from the proposed modification will not affect soils in the vicinity of the Project site.

#### **7.3.1 IMPACTS TO SOILS AND VEGETATION**

According to the modeling results presented in Section 6.0, the maximum air quality impacts due to the Green Bay project are predicted to be below the AAQS for PM/PM<sub>10</sub> and NO<sub>2</sub>. Since the AAQS are designed to protect the public welfare, including the effects on soils and vegetation, no detrimental effects on soils or vegetation should occur in this area due to the proposed project.

#### **7.3.2 IMPACTS ON VISIBILITY**

No new emission sources will be created by the proposed project. The proposed projects at the North and South AP Plants will include an increase in production rate and reductions in maximum permitted emission rates for F and PM/PM<sub>10</sub>. All of these sources are in compliance with opacity regulations and should remain in compliance after the modification. As a result, no adverse impacts upon visibility are expected.

#### **7.3.3 IMPACTS DUE TO ASSOCIATED POPULATION GROWTH**

There will be a small, temporary increase in the number of workers during the construction period. There will be no significant increase in permanent employment at Mosaic as a result of the proposed

project. Therefore, there will be no anticipated permanent impacts on air quality caused by associated population growth.

The Mosaic Green Bay facility is in a remote part of Polk County, primarily phosphate mines and plants for miles in all directions. There has not been any significant commercial, residential, industrial, or other growth in the immediate vicinity of Mosaic Green Bay since 1977. Mosaic Green Bay will "affect" an area of approximately 1.5 km surrounding the facility, based on the significant impact analysis. At the outer edge of the affected area is the southern part of Bartow. This part of Bartow has not experienced any significant growth since 1977. Based on this discussion, it is concluded that no significant growth has occurred in the area of the Green Bay site that would affect air quality impacts. It is also noted that the conservative background concentrations used in the modeling analysis already account for any such changes.

#### **7.4 CLASS I AREA IMPACT ANALYSIS**

##### **7.4.1 IDENTIFICATION OF AQRVS AND METHODOLOGY**

An AQRV analysis was conducted to assess the potential risk to AQRVs of the Chassahowitzka NWA due to the proposed modification to the Mosaic Green Bay facility. The U.S. Department of the Interior in 1978 administratively defined AQRVs to be:

*All those values possessed by an area except those that are not affected by changes in air quality and include all those assets of an area whose vitality, significance, or integrity is dependent in some way upon the air environment. These values include visibility and those scenic, cultural, biological, and recreational resources of an area that are affected by air quality.*

*Important attributes of an area are those values or assets that make an area significant as a national monument, preserve, or primitive area. They are the assets that are to be preserved if the area is to achieve the purposes for which it was set aside (Federal Register 1978).*

Except for visibility, AQRVs were not specifically defined. However, odor, soil, flora, fauna, cultural resources, geological features, water, and climate generally have been identified by land managers as AQRVs. Since specific AQRVs have not been identified for the Chassahowitzka NWA, this AQRV analysis evaluates the effects of air quality on general vegetation types and wildlife found in the Chassahowitzka NWA.

Vegetation-type AQRVs and their representative species types have been defined as:

- ⊘ Marshlands - black needlerush, saw grass, salt grass, and salt marsh cordgrass;
- ⊘ Marsh Islands - cabbage palm and eastern red cedar;
- ⊘ Estuarine Habitat - black needlerush, salt marsh cordgrass, and wax myrtle;
- ⊘ Hardwood Swamp - red maple, red bay, sweet bay, and cabbage palm;
- ⊘ Upland Forests - live oak, scrub oak, longleaf pine, slash pine, wax myrtle, and saw palmetto; and
- ⊘ Mangrove Swamp - red, white, and black mangrove.

Wildlife AQRVs have been identified as endangered species, waterfowl, marsh and waterbirds, shorebirds, reptiles, and mammals.

A screening approach was used that compared the maximum predicted ambient concentration of air pollutants of concern in the Chassahowitzka NWA with effect threshold limits for both vegetation and wildlife as reported in the scientific literature. A literature search was conducted that specifically addressed the effects of air contaminants on plant species reported to occur in the NWA. While the literature search focused on such species as cabbage palm, eastern red cedar, lichens, and species of the hardwood swamplands and mangrove forest, no specific citations that addressed these species were found. It is recognized that effect threshold information is not available for all species found in the Chassahowitzka NWA, although studies have been performed on a few of the common species and on other similar species that can be used as indicators of effects.

The maximum predicted ambient impacts upon the Chassahowitzka Class I area were presented in Section 6.0 and are summarized in Table 7-1.

#### **7.4.2 VEGETATION**

In general, the effects of air pollutants on vegetation occur primarily from SO<sub>2</sub>, NO<sub>2</sub>, O<sub>3</sub>, and PM in the ambient air. Effects from minor air contaminants such as F, chlorine, hydrogen chloride, ethylene, ammonia, hydrogen sulfide, CO, and pesticides have also been reported in the literature. The effects of air pollutants are dependent both on the concentration of the contaminant and the duration of the exposure. The term "injury," as opposed to damage, is commonly used to describe all plant responses to air contaminants and will be used in the context of this analysis. Air contaminants

are thought to interact primarily with plant foliage, which is considered to be the major pathway of exposure.

Injury to vegetation from exposure to various levels of air contaminants can be termed acute, physiological, or chronic. Acute injury occurs as a result of a short-term exposure to a high contaminant concentration and is typically manifested by visible injury symptoms ranging from chlorosis (discoloration) to necrosis (dead areas). Physiological or latent injury occurs as the result of a long-term exposure to contaminant concentrations below that which results in acute injury symptoms. Chronic injury results from repeated exposure to low concentrations over extended periods of time, often without any visible symptoms, but with some effect on the overall growth and productivity of the plant. In this assessment, 100 percent of the particular air pollutant in the ambient air was assumed to interact with the vegetation. This is a conservative approach.

The response of vegetation and wildlife to atmospheric pollutants is influenced by the concentration of the pollutant, duration of exposure, and frequency of exposures. The pattern of pollutant exposure expected from the facility is that of a few episodes of relatively high ground-level concentrations that occur during certain meteorological conditions interspersed with long periods of extremely low ground-level concentrations. If there are any effects of stack emissions on plants and animals they will be from the short-term, higher doses. A dose is the product of the concentration of the pollutant and duration of the exposure.

#### **7.4.2.1 Particulate Matter**

Although information pertaining to the effects of particulate matter on plants is scarce, some threshold concentrations are available. Mandoli and Dubey (1998) exposed 10 species of native Indian plants to levels of PM ranging from 210 to 366  $\mu\text{g}/\text{m}^3$  for an 8-hour averaging period. Damage in the form of a higher leaf area/dry weight ratio was observed at varying degrees for most plants tested. Concentrations of particulate matter lower than 163  $\mu\text{g}/\text{m}^3$  did not appear to be injurious to the tested plants.

By comparison of these published toxicity values for particulate matter exposure (i.e., concentrations for an 8-hour averaging time), the possibility of plant damage in the Chassahowitzka NWA can be determined. The maximum predicted cumulative 8-hour  $\text{PM}_{10}$  concentration in the Class I area due to the project only is 0.084  $\mu\text{g}/\text{m}^3$  (Table 7-1). This concentration is only 0.04 percent of the lower

threshold value that reportedly affects plant foliage. Since the predicted 8-hour impact is very low, no measurable effects upon vegetation in the Class I area will occur due to the proposed project.

#### **7.4.2.2 Nitrogen Dioxide**

NO<sub>2</sub> can injure plant tissue with symptoms usually appearing as irregular white to brown collapsed lesions between the leaf veins and near the margins. Conversely, non-injurious levels of NO<sub>2</sub> can be absorbed by plants, enzymatically transformed into ammonia, and incorporated into plant constituents such as amino acids (Matsumaru *et al.*, 1979).

Plant damage can occur through either acute (short-term, high concentration) or chronic (long-term, relatively low concentration) exposure. For plants that have been determined to be more sensitive to NO<sub>2</sub> exposure than others, acute (1, 4, 8 hours) exposure caused 5 percent predicted foliar injury at concentrations ranging from 3,800 to 15,000 µg/m<sup>3</sup> (Heck and Tingey, 1979). Chronic exposure of selected plants (some considered NO<sub>2</sub>-sensitive) to NO<sub>2</sub> concentrations of 2,000 to 4,000 µg/m<sup>3</sup> for 213 to 1,900 hours caused reductions in yield of up to 37 percent and some chlorosis (Zahn, 1975).

Average and maximum 24-hour average background concentrations of NO<sub>2</sub> reported in the Chassahowitzka NWA are 0.006 and 0.104 µg/m<sup>3</sup>, respectively (NADP, 2000). The increase in maximum 8-hour average NO<sub>2</sub> concentrations due to the Green Bay project in the Class I area is predicted to be 0.047 µg/m<sup>3</sup> (Table 7-1). This concentration is less than 0.01 percent of the levels that cause foliar injury in acute exposure scenarios. By comparison of published toxicity values for NO<sub>2</sub> exposure to long-term (annual averaging time) modeled concentrations, the possibility of plant damage in the Class I areas can be examined for chronic exposure situations. For a chronic exposure, the maximum increase in annual average NO<sub>2</sub> concentrations due to the Green Bay project in the Class I area is 0.0004 µg/m<sup>3</sup>. When added to the maximum annual average concentration of NO<sub>2</sub> reported in the Chassahowitzka NWA, the resultant value (0.0064 µg/m<sup>3</sup>) is less than 0.001 percent of the levels that caused minimal yield loss and chlorosis in plant tissue.

#### **7.4.2.3 Fluoride**

Fluoride is an inhibitor of plant metabolism. As fluoride accumulates in plants, it causes an inhibition of plant metabolism and chlorosis (a yellowing of the leaf). With further increases in accumulation of fluoride, the cells die and necrosis is observed. Leaf tips and margins accumulate the highest concentrations of fluoride and are the sites of initial visible injury. Gaseous fluoride is taken up

primarily through the stomata of transpiring plants. There is negligible contribution to leaf F content by uptake through the roots (Applied Sciences Associates, Inc.; 1978).

Plant sensitivities can range from 16  $\mu\text{g}/\text{m}^3$  of fluoride in sensitive plants to 500  $\mu\text{g}/\text{m}^3$  of F in tolerant plants for 3-hour exposures. The lowest observed effect levels for sensitive plants are reported to be as follows (Applied Sciences Associates, Inc.; 1978):

<50  $\mu\text{g}/\text{m}^3$  for 1-hour exposures

<16  $\mu\text{g}/\text{m}^3$  for 3-hour exposures

<1.6  $\mu\text{g}/\text{m}^3$  for 24-hour exposures

Gladiolus is considered the plant species most sensitive to F. Visible symptoms are reported to occur when gladiolus have been exposed to concentrations  $>0.5 \mu\text{g}/\text{m}^3$  for 5 to 10 days. More tolerant fruit tree species and conifers displayed symptoms at around 1  $\mu\text{g}/\text{m}^3$  at 10-day exposures (Treshow and Anderson, 1989).

The predicted increase in maximum fluoride concentrations in the Chassahowitzka NWA due to the modified Mosaic Green Bay plant are 0.046  $\mu\text{g}/\text{m}^3$  for 1-hour averaging time, 0.010  $\mu\text{g}/\text{m}^3$  for 24-hour averaging time, and 0.0006  $\mu\text{g}/\text{m}^3$  for the annual averaging time (refer to Table 7-1). These concentrations are only 0.09 to 0.6 percent of the reported effect levels. As a result, no significant adverse effects are predicted to occur to the vegetative AQRVs of Chassahowitzka NWA.

#### 7.4.3 WILDLIFE

The major air quality risk to wildlife in the United States is from continuous exposure to pollutants above the National AAQS. This occurs in non-attainment areas, e.g., Los Angeles Basin. Risks to wildlife also may occur for wildlife living in the vicinity of an emission source that experiences frequent upsets or episodic conditions resulting from malfunctioning equipment, unique meteorological conditions, or startup operations (Newman and Schreiber, 1988). Under these conditions, chronic effects (e.g., particulate contamination) and acute effects (e.g., injury to health) have been observed (Newman, 1981).

A wide range of physiological and ecological effects to fauna has been reported for gaseous and particulate pollutants (Newman, 1981; Newman and Schreiber, 1988). The most severe of these effects have been observed at concentrations above the secondary ambient air quality standards. Physiological and behavioral effects have been observed in experimental animals at or below these



standards. The ingestion of excessive amounts of fluoride can lead to an animal disease called fluorosis. Fluorosis is a skeletal and dental disease resulting in softening of bone and dental tissue that can lead to injury and other health problems. In general, forage plants with over 30 ppm of fluoride which are regularly ingested by animals such as cattle and deer can result in mild fluorosis. A number of states (excluding Florida) have F standards. These range from 25 to 40 parts per million (ppm) of F in vegetation as a maximum annual average.

For impacts on wildlife, the lowest threshold values of NO<sub>2</sub> and PM<sub>10</sub> which are reported to cause physiological changes are shown in Table 7-2. These values are up to orders of magnitude larger than maximum concentrations predicted from the Mosaic Green Bay project in the Class I area. No effects on wildlife AQRVs from NO<sub>2</sub>, PM<sub>10</sub>, or F are expected. The proposed project's contribution to cumulative impacts are negligible.

Since the predicted annual F concentration due to the project is very low, no measurable accumulation of fluoride will occur in vegetation that would be the prime forage of wildlife. Therefore, no significant adverse effects to wildlife AQRVs will occur from vegetation.

#### 7.4.4 SOILS

For soils, the potential and hypothesized effects of atmospheric deposition include:

- Increased soil acidification,
- Alteration in cation exchange,
- Loss of base cations, and
- Mobilization of trace metals.

The potential sensitivity of specific soils to atmospheric inputs is related to two factors. First, the physical ability of a soil to conduct water vertically through the soil profile is important in influencing the interaction with deposition. Second, the ability of the soil to resist chemical changes, as measured in terms of pH and soil cation exchange capacity (CEC), is important in determining how a soil responds to atmospheric inputs.

According to the USDA Soil Surveys of Citrus and Hernando Counties, nine soil complexes are found in the Chassahowitzka NWA. These include Aripeka fine sand, Aripeka-Okeelanta-Lauderhill, Hallendale-Rock outcrop, Homosassa mucky fine sandy loam, Lacoche, Okeelanta mucks, Okeelanta-Lauderdale-Terra Ceia mucks, Rock outcrop-Homosassa-Lacochee, and Weekiwachee-

Durbin mucks (Porter, 1996). The majority of the soil complexes found in the NWA are inundated by tidal waters, contain a relatively high organic matter content, and have high buffering capacities based on their CEC, base saturation, and bulk density. The regular flooding of these soils by the Gulf of Mexico regulates the pH and any change in acidity in the soil would be buffered by this activity. Therefore, they would be relatively insensitive to atmospheric inputs. However, Terra Ceia, Okeelanta, and Lauderdale freshwater mucks are present along the eastern border of the NWA, and may be more sensitive to atmospheric sulfur deposition (Porter, 1996). Although not tidally influenced, these freshwater mucks are highly organic and therefore have a relatively high intrinsic buffering capacity.

The relatively low sensitivity of the soils to atmospheric inputs coupled with the extremely low ground-level concentrations of contaminants projected for the Chassahowitzka NWA from the proposed project's emissions precludes any significant impact on soils.

#### **7.4.4.1 Particulate Matter**

The majority of the soil in the Class I area is characterized by high levels of sulfur and organic matter. This soil is flooded daily with the advent of high tide and the pH ranges between 6.1 and 7.8. The upper level of this soil may contain as much as 4-percent sulfur (USDA, 1991).

Any particulate deposition from the proposed project would be neutral or alkaline in nature. Although ground deposition was not calculated, it is evident that the effect of any dust deposited would be inconsequential in light of the existing soil pH. The regular flooding of these soils by the Gulf of Mexico regulates the pH and any change in acidity in the soil would be buffered by this activity.

#### **7.4.4.2 Nitrogen Dioxide**

The greatest threat to soils from increased NO<sub>x</sub> deposition is a decrease in pH or an increase in nitrate to levels considered unnatural or potentially toxic. The results from the Florida Acid Deposition Study (FADS) network for two sampling stations (Site 8 and Site 5) located to the north of the Class I area indicate that the average sulfate deposition ranges from 14.5 to 17.7 kg/ha/yr (Pollman, 1994). The predicted amount of NO<sub>x</sub> deposition due to the proposed project is insignificant in light of the sulfate deposition measured in the area and the inherent sulfur content of the soils. In addition, the regular flooding of these soils by the Gulf of Mexico regulates the pH, and any rise in acidity would be buffered by this activity.

## 7.4.5 IMPACTS UPON VISIBILITY

### 7.4.5.1 Introduction

The CAA Amendments of 1977 provide for implementation of guidelines to prevent visibility impairment in mandatory Class I areas. The guidelines are intended to protect the aesthetic quality of these pristine areas from reduction in visual range and atmospheric discoloration due to various pollutants. Sources of air pollution can cause visible plumes if emissions of PM<sub>10</sub> and NO<sub>x</sub> are sufficiently large. A plume will be visible if its constituents scatter or absorb sufficient light so that the plume is brighter or darker than its viewing background (e.g., the sky or a terrain feature, such as a mountain). PSD Class I areas, such as national parks and wilderness areas, are afforded special visibility protection designed to prevent plume visual impacts to observers within a Class I area.

Visibility is an AQRV for the Chassahowitzka NWA. Visibility can take the form of plume blight for nearby areas or regional haze for long distances (e.g., distances beyond 50 km). Because the Chassahowitzka NWA is more than 50 km from the Mosaic Green Bay facility, the potential change in visibility is analyzed as regional haze.

Currently, there are several air quality modeling approaches recommended by the Interagency Workgroup on Air Quality Models (IWAQM) to perform these analyses. The IWAQM consists of EPA and FLM of Class I areas who are responsible for ensuring that AQRVs are not adversely impacted by new and existing sources. These recommendations have been summarized in two documents:

- *Interagency Workgroup on Air Quality Models (IWAQM), Phase 2 Summary Report and Recommendations for Modeling Long Range Transport Impacts* (EPA, 1998), referred to as the IWAQM Phase 2 report; and
- *Federal Land Managers' Air Quality Related Values Workgroup (FLAG), Phase I Report*, USFS, NPS, USFWS (December, 2000), referred to as the FLAG document.

The methods and assumptions recommended in these documents were used to assess visibility impairment due to the project.

### 7.4.5.2 Analysis Methodology

Based on the FLAG document, current regional haze guidelines characterize a change in visibility by the change in the light-extinction coefficient ( $b_{ext}$ ). The  $b_{ext}$  is the attenuation of light per unit distance

due to the scattering and absorption by gases and particles in the atmosphere. A change in the extinction coefficient produces a perceived visual change. An index that simply quantifies the percent change in visibility due to the operation of a source is calculated as:

$$\Delta\% = (b_{\text{exts}} / b_{\text{extb}}) \times 100$$

where:  $b_{\text{exts}}$  is the extinction coefficient calculated for the source, and  
 $b_{\text{extb}}$  is the background extinction coefficient.

The purpose of the visibility analysis is to calculate the extinction at each receptor for each day (24-hour period) of the year due to the proposed project. The criteria to determine if the project's impacts are potentially significant are based on a change in extinction of 5 percent or greater for any day of the year.

Processing of visibility impairment for this study was performed with the CALPUFF model (see Appendix C) and the CALPUFF post-processing programs POSTUTIL and CALPOST. The analysis was conducted in accordance with the most recent guidance from the FLAG report (December 2000). The CALPUFF postprocessor model CALPOST is used to calculate the combined visibility effects from the different pollutants that are emitted from the Project. Daily background extinction coefficients are calculated on an hour-by-hour basis using hourly relative humidity data from CALMET and hygroscopic and non-hygroscopic extinction components specified in the FLAG document. For the Class I area evaluated, the hygroscopic and non-hygroscopic components are 0.9 and 8.5 inverse mega meter ( $\text{Mm}^{-1}$ ). CALPOST then predicts the percent extinction change for each day of the year.

#### **7.4.5.3 Emission Inventory**

Based on recommendations of the FLAG Phase I Summary Report (12/00), the regional haze analysis considered only the maximum 24-hour increase in emissions due to the proposed Mosaic Green Bay modification. The emission rates and source parameters for the affected sources are presented in Chapter 6.0.

#### **7.4.5.4 Building Wake Effects**

The air modeling analysis included the same building structure dimensions to account for the effects of building-induced downwash as was used in the ISCST3 modeling analysis. Dimensions for all

significant building structures were processed with the Building Profile Input Program (BPIP), Version 04274, and were included in the CALPUFF model.

#### **7.4.5.5 Receptor Locations**

Receptors for the refined analysis included 58 discrete receptors located at the Chassahowitzka NWA Class I area. These receptors consist of the NPS boundary receptors for this area.

#### **7.4.5.6 Background Extinction Coefficients and Relative Humidity**

The regional haze analysis was performed using the latest regulatory guidance as provided in the Federal Land Manager's Air Quality Related Values Workgroup (FLAG) Phase I report. Using the hourly meteorological and relative humidity data used with the CALPUFF model, the daily change in background extinction is computed. The hygroscopic and dry non-hygroscopic components used for calculating the daily background extinction coefficients for the Chassahowitzka NWA were obtained from the FLAG report. For this analysis, the hygroscopic and dry non-hygroscopic values were 0.9 and 8.5 inverse millimeters ( $Mm^{-1}$ ), respectively.

#### **7.4.5.7 Meteorological Data**

Three years of CALMET wind field data was used for a domain that covers all of North and Central Florida. The years of data are 1990, 1992, and 1996. A detailed description of the data used to develop the wind domains is presented in Appendix C.

#### **7.4.5.8 Chemical Transformation**

The air modeling analysis included all chemical transformation processes that occur for the emitted species.

#### **7.4.5.9 Results**

The visibility modeling results are presented in Table 7-3. The maximum predicted 24-hour change in background extinction coefficient is 0.74 percent. As this percentage is below the criteria value of 5 percent, it is concluded that the proposed project will not adversely impact the background visibility levels at the Chassahowitzka NWA Class I area.

### **7.4.6 NITROGEN DEPOSITION**

As part of the AQRV analyses, total nitrogen (N) deposition rates were predicted at the Chassahowitzka NWA Class I area. The deposition analysis threshold is based on the annual

averaging period. The total nitrogen deposition is estimated in units of kilogram per hectare per year (kg/ha/yr). The CALPUFF model is used to predict wet and dry deposition fluxes of various oxides of these elements.

For N deposition, the species include:

- Particulate ammonium nitrate (from species  $\text{NO}_3$ ), wet and dry deposition;
- Nitric acid (species  $\text{HNO}_3$ ), wet and dry deposition;
- $\text{NO}_x$ , dry deposition; and
- Ammonium sulfate (species  $\text{SO}_4$ ), wet and dry deposition.

The CALPUFF model produces results in units of  $\mu\text{g}/\text{m}^2/\text{s}$ . The modeled deposition rates are then converted to N deposition in kg/ha respectively, by using a multiplier equal to the ratio of the molecular weights of the substances (IWAQM Phase II report Section 3.3).

The deposition analysis threshold (DAT) for nitrogen of 0.01 kg/ha/yr was provided by the U.S. Fish and Wildlife Service (January 2002). A DAT is the additional amount of N deposition within a Class I area, below which estimated impacts from a proposed new or modified source are considered insignificant. The maximum N deposition predicted for the proposed Green Bay project is, therefore, compared to these DAT or significant impact levels.

The maximum predicted N deposition predicted for the project in the PSD Class I area of the Chassahowitzka NWA is summarized in Table 7-4. The maximum N deposition rate for the Project is predicted to be 0.0003 kg/ha/yr, which is below the DAT of 0.01 kg/ha/yr. As a result, the project's emissions are not expected to have a significant adverse effect on N deposition at the Class I area.

## **7.5 IMPACTS DUE TO ASSOCIATED DIRECT GROWTH**

### **7.5.1 INTRODUCTION**

Rule 62-212.400(3)(h)(5), F.A.C., states that an application must include information relating to the air quality impacts of, and the nature and extent of all general, residential, commercial, industrial and other growth which has occurred since August 7, 1977, in the area the facility or modification would affect. This growth analysis considers air quality impacts due to emissions resulting from the industrial, commercial, and residential growth associated with the proposed construction and operation of the

In general, there has been minimal growth in the general area since 1977. The site is located in Polk County which is in central Florida and the fourth largest county in Florida, consisting of 1,823 square miles. The site lies in a region of the state dominated by phosphate mining operations including mines, settling ponds, sand tailings piles, gypsum stacks, and chemical and beneficiation plants.

As stated in Section 1.0, the purpose of the present PSD permit application is to increase the annual production limit for the South AP Plant. No physical changes to the South AP Plant will be required to implement this change. There will be minor physical changes at the North AP Plant (e.g., adding a pipe).

Because there will not be any major construction related to the proposed modification, there will be minimal impacts from construction activities on secondary growth due to the project.

The workforce needed to operate the project may increase slightly from that operating the existing operation. Therefore, there would be a slight increase in vehicular traffic in the area and the effect on air quality levels would effectively remain the same as the existing operations.

There are also expected to be no air quality impacts due to associated commercial and industrial growth given the location of the existing facility. The existing commercial and industrial infrastructure should be adequate to provide any support services that the project might require, and would not increase with the operation of the project. The modification to the existing facility will have little effect on the increase or growth in the area.

The following discussion presents general trends in residential, commercial, industrial, and other growth that has occurred since August 7, 1977, in Polk County. Information is presented from a variety of available sources (i.e., Florida Statistical Abstract, FDEP, etc.) that characterize Polk County as a whole.

## **7.5.2 RESIDENTIAL GROWTH**

### **7.5.2.1 Population and Household Trends**

As an indicator of residential growth, the trend in the population and number of single- and multi-family household units in Polk County since 1977 are shown in Figure 7-1.

Over 3 million people live within a 50-mile radius and 6 million within a 100-mile radius of Polk County. The county experienced a 73 percent increase in population for the years 1977 through 2000. During this period, there was an increase in population of about 204,000 with about 123,000 due to births and the rest from people moving into the county.

Similarly, the number of households in the county increased by about 68,000 or about 58 percent since 1977.

#### **7.5.2.2 Growth Associated with the Operation of the Project**

There are very few residences near the plant site. Because there will be a limited number of workers needed to operate the project, residential growth due to the project is expected to be minimal.

### **7.5.3 COMMERCIAL GROWTH**

#### **7.5.3.1 Retail Trade and Wholesale Trade**

As an indicator of commercial growth in Polk County, the trends in the number of commercial facilities and employees involved in retail and wholesale trade are presented in Figure 7-2. The retail trade sector comprises establishments engaged in retailing merchandise. The retailing process is the final step in the distribution of merchandise. Retailers are, therefore, organized to sell merchandise in small quantities to the general public. The wholesale trade sector comprises establishments engaged in wholesaling merchandise. This sector includes merchant wholesalers who buy and own the goods they sell; manufacturers' sales branches and offices who sell products manufactured domestically by their own company; and agents and brokers who collect a commission or fee for arranging the sale of merchandise owned by others.

Since 1977 retail trade has increased by 524 establishments and 21,000 employees or 38 and 108 percent, respectively. For the same period, wholesale trade has increased by 413 establishments and 4,600 employees or 107 and 98 percent, respectively.

#### **7.5.3.2 Labor Force**

The trend in the labor force in Polk County since 1977 is shown in Figure 7-3. The county is designated as a labor surplus area by the U.S Department of Labor. The unskilled labor supply consistently exceeds local demand. The estimated unemployment rate for 2000 was 4.7 percent.



Between 1977 and 1999, approximately 88,600 persons were added to the available work force for an increase of 85 percent.

#### **7.5.3.3 Tourism**

Another indicator of commercial growth in Polk County is the tourism industry. As an indicator of tourism growth in the county, the trend in the number of hotels and motels and the number of units at the hotels and motels are presented in Figure 7-4.

This industry comprises establishments primarily engaged in marketing and promoting communities and facilities to businesses and leisure travelers through a range of activities, such as assisting organizations in locating meeting and convention sites; providing travel information on area attractions, lodging accommodations, restaurants; providing maps; and organizing group tours of local historical, recreational, and cultural attractions.

Between 1978 and 2000, there was a decrease of about 25 percent in the number of hotels and motels in the county; however there was a slight increase of 7 percent in the number of units at those facilities.

#### **7.5.3.4 Transportation**

As an indicator of transportation growth, the trend in the number of vehicle miles traveled (VMT) by motor vehicles on major roadways in Polk County is presented in Figure 7-5. The county is the center of Florida's industrial belt and is within 500 miles of 40 major metropolitan areas.

The county straddles Interstate I-4, the main conduit for the central Florida growth corridor. Interstate I-4 connects with Interstate I-75 between Lakeland and Tampa (16 miles west of Lakeland to the interchange). Interstate I-4 extends from Orlando in the east, connecting with the Florida Turnpike, and continues to Daytona where it connects with Interstate I-95. Other major highways in the county include U.S Highways 27, 60, 92, and 98.

Between 1977 and 2001, there was an increase of about 5,100,000 VMT or 62 percent in the amount of travel by motor vehicles on major roadways in the county.

### **7.5.3.5 Growth Associated with the Operation of the Project**

The existing commercial and transportation infrastructure should be adequate to provide any support services that might be required during operation of the project (no major construction activities are required). The workforce needed to operate the proposed project represents a very minor fraction of the labor force present in the immediate and surrounding areas.

## **7.5.4 INDUSTRIAL GROWTH**

### **7.5.4.1 Mining, Manufacturing and Agricultural Industries**

As an indicator of industrial growth, the trend in the number of employees in the mining and manufacturing industries in Polk County since 1977 are shown in Figure 7-6. As shown, the mining industry has experienced a decrease of 36 percent in the number of employees since 1977. Meanwhile, the manufacturing industry has experienced a slight increase of 5 percent in the number of employees.

As another indicator of industrial growth, the trend in the number of boxes of citrus produced in Polk County since 1977 is also shown in Figure 7-6. The citrus industry has experienced increases in the 1980s and early 1990s but, since 1977, has decreased by 22 percent.

### **7.5.4.2 Utilities**

Existing power plants in Polk County include the following:

- Ridge Generating Station;
- TECO Polk Power Station;
- Lakeland Electric McIntosh Plant;
- Lakeland Electric Larsen Plant;
- Calpine Auburndale Plant;
- Orange Cogen Plant;
- Mulberry Cogen Plant;
- Progress Energy, Hines Energy Complex, Power Blocks 1 and 2;
- Progress Energy Tiger Bay Plant; and
- Calpine Auburndale Unit 2

Together, these power plants have an electrical generating capacity of over 2,300 megawatts (MW).

Proposed sources that have received air permits or sources under construction include the following:

- CPV Pierce;
- Calpine Osprey Plant;
- Lakeland Electric Winston Peaking Station;
- Decker Peace River Plant; and
- Progress Energy, Hines Energy Complex, Power Blocks 3 and 4.

Together, these power plants have a proposed electrical generating capacity of over 2,200 megawatts (MW).

As an indicator of electrical utility growth, the electrical generation capacity in Polk County since 1977 is shown in Figure 7-7.

#### **7.5.4.3 Growth Associated with the Operation of the Project**

Since the PSD baseline date of August 7, 1977, there have been only a few major facilities built within a 10-km radius of Mosaic's Green Bay facility. The nearest major source is the Polk Power Partners' Mulberry Plant. There are a number of facilities located throughout the 50-km radius area surrounding the facility. Based on the locations of nearby air emission sources, as shown in Tables 6-6 and 6-7, there has not been a concentration of industrial and commercial growth in the vicinity of Mosaic's Green Bay facility.

### **7.5.5 AIR QUALITY DISCUSSION**

#### **7.5.5.1 Air Emissions and Spatial Distribution of Major Facilities**

The locations of major air pollutant facilities in Polk County are shown in Tables 6-6 and 6-7. Based on actual emissions reported in 1999, total emissions of stationary sources from the county are as follows:

- SO<sub>2</sub>: 31,900 TPY;
- Particulate matter with diameter of 10 microns or less (PM<sub>10</sub>): 1,100 TPY;
- Nitrogen oxides (NO<sub>x</sub>): 10,200 TPY;
- Carbon monoxide (CO): 1,050 TPY; and
- Volatile organic compounds (VOC): 320 TPY.

### **7.5.5.2 Air Emissions from Mobile Sources**

The trends in the air emissions of CO, VOC, and NO<sub>x</sub> from mobile sources are presented in Figure 7-8. Between 1977 and 2002, there were significant decreases in these emissions. The decrease in CO, VOC, NO emissions were about 81, 7, and 4 tons per day, respectively, which represent decreases of 80, 80, and 56 percent, respectively, from 1977 emission estimates.

### **7.5.5.3 Air Monitoring Data**

Since 1977, Polk County has been classified as attainment for all criteria pollutants. There are currently four air quality monitors that are operated by the FDEP in Polk County. These monitors measure SO<sub>2</sub> concentrations (Mulberry and Nichols), PM<sub>10</sub> concentrations (Mulberry and Nichols), and ozone (two sites in Lakeland). The nearest monitoring stations to Mosaic's Green Bay Facility that measures NO<sub>2</sub> concentrations are located in Hillsborough County. Data collected from these stations are considered to be representative of air quality in Polk County. For this evaluation, the air quality monitoring data collected at the monitoring station nearest to the project were used to assess air quality trends since 1977.

Summaries of the maximum measured PM<sub>10</sub> and NO<sub>2</sub> concentrations considered to represent air quality around Mosaic's Green Bay facility from 2002 through 2004 are presented in Tables 4-1 and 4-2.

Since 1988, PM in the form of PM<sub>10</sub> has been collected at the air monitoring stations due to the promulgation of the PM<sub>10</sub> AAQS. Prior to 1989, the AAQS for PM was in the form of total suspended particulates (TSP) concentrations, and this form was measured at the stations.

These data indicate that the maximum air quality concentrations measured in the region comply with and are well below the applicable ambient air quality standards. These monitoring stations are generally located in areas where the highest concentrations of a measured pollutant is expected due to the combined effect of emissions from stationary and mobile sources as well as meteorology. Therefore, the ambient concentrations in areas not monitored should have pollutant concentrations less than those monitored concentrations.

#### **7.5.5.4 PM<sub>10</sub>/TSP Concentrations**

The trends in the annual and 24-hour average PM<sub>10</sub> and TSP concentrations measured at the nearest monitors to Mosaic's Green Bay facility since 1977 are presented in Figures 7-9 and 7-10, respectively. TSP concentrations are presented through 1988 since the AAQS was based on TSP concentrations through that year. In 1988, the TSP AAQS was revoked and the PM standard was revised to PM<sub>10</sub>.

As shown in these figures, measured TSP concentrations were generally below the TSP AAQS. Since 1988, when PM<sub>10</sub> concentrations have been measured, the PM<sub>10</sub> concentrations have been and continue to be below the AAQS.

#### **7.5.5.5 NO<sub>2</sub> Concentrations**

The trends in the annual average NO<sub>2</sub> concentrations measured at the nearest monitors to Mosaic's Green Bay facility are presented in Figure 7-11. As shown in this figure, measured NO<sub>2</sub> concentrations have been well below the AAQS.

#### **7.5.5.6 Air Quality Associated with the Operation of the Project**

The air quality data measured in the region of Mosaic's Green Bay facility indicate that the maximum air quality concentrations are well below and comply with the AAQS. Based on the trends presented of these maximum concentrations, the air quality has generally improved in the region since the baseline date of August 7, 1977. Because the maximum air quality impacts resulting from the project are predicted to be low and, for most pollutants below the significant impact levels, the air quality concentrations in the region are expected to remain below and comply with the AAQS when the project becomes operational.

Table 7-1. Summary of Maximum Predicted Impacts Due to the Proposed Project Only  
at the Chassahowitzka NWA Class I Area, Mosaic Green Bay

	Averaging Time	Concentration <sup>a</sup> (ug/m <sup>3</sup> ) for Year			EPA Class I Significant Impact Levels (ug/m <sup>3</sup> )
		1990	1992	1996	
NO <sub>2</sub>	Annual	0.0003	0.0004	0.0004	0.1
	24-Hour	0.016	0.016	0.012	NA
	8-Hour	0.035	0.047	0.029	NA
	3-Hour	0.053	0.056	0.051	NA
	1-Hour	0.067	0.071	0.077	NA
PM <sub>10</sub>	Annual	0.0015	0.0017	0.0019	0.2
	24-Hour	0.029	0.029	0.027	0.3
	8-Hour	0.064	0.084	0.056	NA
	3-Hour	0.1	0.102	0.105	NA
	1-Hour	0.115	0.137	0.140	NA
F	Annual	0.0005	0.0006	0.0006	NA
	24-Hour	0.009	0.010	0.008	NA
	8-Hour	0.019	0.026	0.020	NA
	3-Hour	0.031	0.034	0.039	NA
	1-Hour	0.036	0.046	0.046	NA

<sup>a</sup> Concentrations predicted with the CALPUFF model and CALMET-developed domains for central Florida for 1990, 1992, and 1996.

Note: NA = Not Applicable.

Table 7-2. Examples of Reported Effects of Air Pollutants at Concentrations Below the National Secondary Ambient Air Quality Standards

Pollutant	Reported Effect	Concentration ( $\mu\text{g}/\text{m}^3$ )	Exposure
Sulfur Dioxide <sup>1</sup>	Respiratory stress in guinea pigs	427 to 854	1 hour
	Respiratory stress in rats	267	7 hours/day; 5 day/week for 10 weeks
	Decreased abundance in deer mice	13 to 157	continually for 5 months
Nitrogen Dioxide <sup>2,3</sup>	Respiratory stress in mice	1,917	3 hours
	Respiratory stress in guinea pigs	96 to 958	8 hours/day for 122 days
Particulates <sup>1</sup>	Respiratory stress, reduced respiratory disease defenses	120 $\text{PbO}_3$	continually for 2 months
	Decreased respiratory disease defenses in rats, same with hamsters	100 $\text{NiCl}_2$	2 hours

Sources: <sup>1</sup> Newman and Schreiber, 1988.  
<sup>2</sup> Gardner and Graham, 1976.  
<sup>3</sup> Trzeciak et al., 1977.

Table 7-3. Maximum 24-hour Average Visibility Impairment Predicted for the Project Only at the PSD Class I Area of the Chassahowitzka NWA, Mosaic Green Bay

Ranking	Visibility Impairment (%) <sup>a</sup>			Visibility Impairment Criteria (%)
	1990	1992	1996	
Highest	0.32	0.74	0.36	5.0

<sup>a</sup> Concentrations are highest predicted using the CALPUFF model and CALMET windfields for central Florida.



Table 7-4. Maximum Nitrogen Annual Deposition Predicted for the Project Only  
at the PSD Class I Area of the Chassahowitzka NWA, Mosaic Green Bay

Species	Total Deposition (Wet & Dry)						Deposition Analysis Threshold <sup>b</sup>
	1990		1992		1996		
	(g/m <sup>2</sup> /s)	(kg/ha/yr) <sup>a</sup>	(g/m <sup>2</sup> /s)	(kg/ha/yr) <sup>a</sup>	(g/m <sup>2</sup> /s)	(kg/ha/yr) <sup>a</sup>	(kg/ha/yr)
Nitrogen (N)	6.35E-13	0.0002	9.54E-13	0.0003	5.95E-13	0.0002	0.01

<sup>a</sup> Conversion factor is used to convert g/m<sup>2</sup>/s to kg/hectare (ha)/yr with the following units:

$$\begin{aligned}
 & \text{g/m}^2/\text{s} \times 0.001 \text{ kg/g} \\
 & \quad \times 10,000 \text{ m}^2/\text{hectare} \\
 & \quad \times 3,600 \text{ sec/hr} \\
 & \quad \times 8,760 \text{ hr/yr} = \text{kg/ha/yr} \\
 & \text{or} \\
 & \text{g/m}^2/\text{s} \times 3.154\text{E}+08 = \text{kg/ha/yr}
 \end{aligned}$$

<sup>b</sup> Deposition analysis thresholds (DAT) for nitrogen and sulfur deposition provided by the U.S. Fish and Wildlife Service, January 2002. A DAT is the additional amount of N or S deposition within a Class I area, below which estimated impacts from a proposed new or modified source are considered insignificant.

Figure 7-1. Population and Household Unit Trends in Polk County

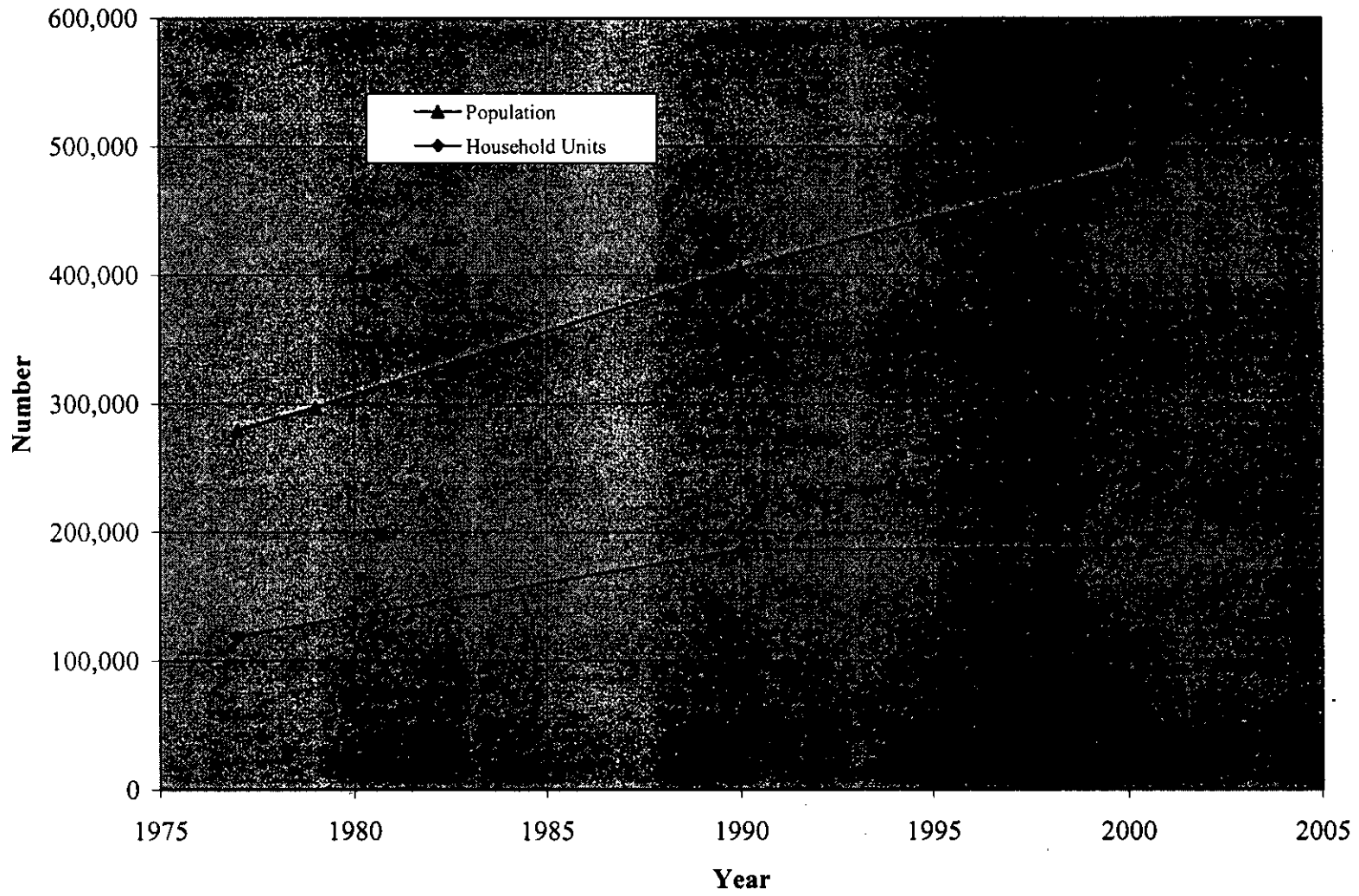

Figure 7-2. Retail and Wholesale Trade Trends in Polk County

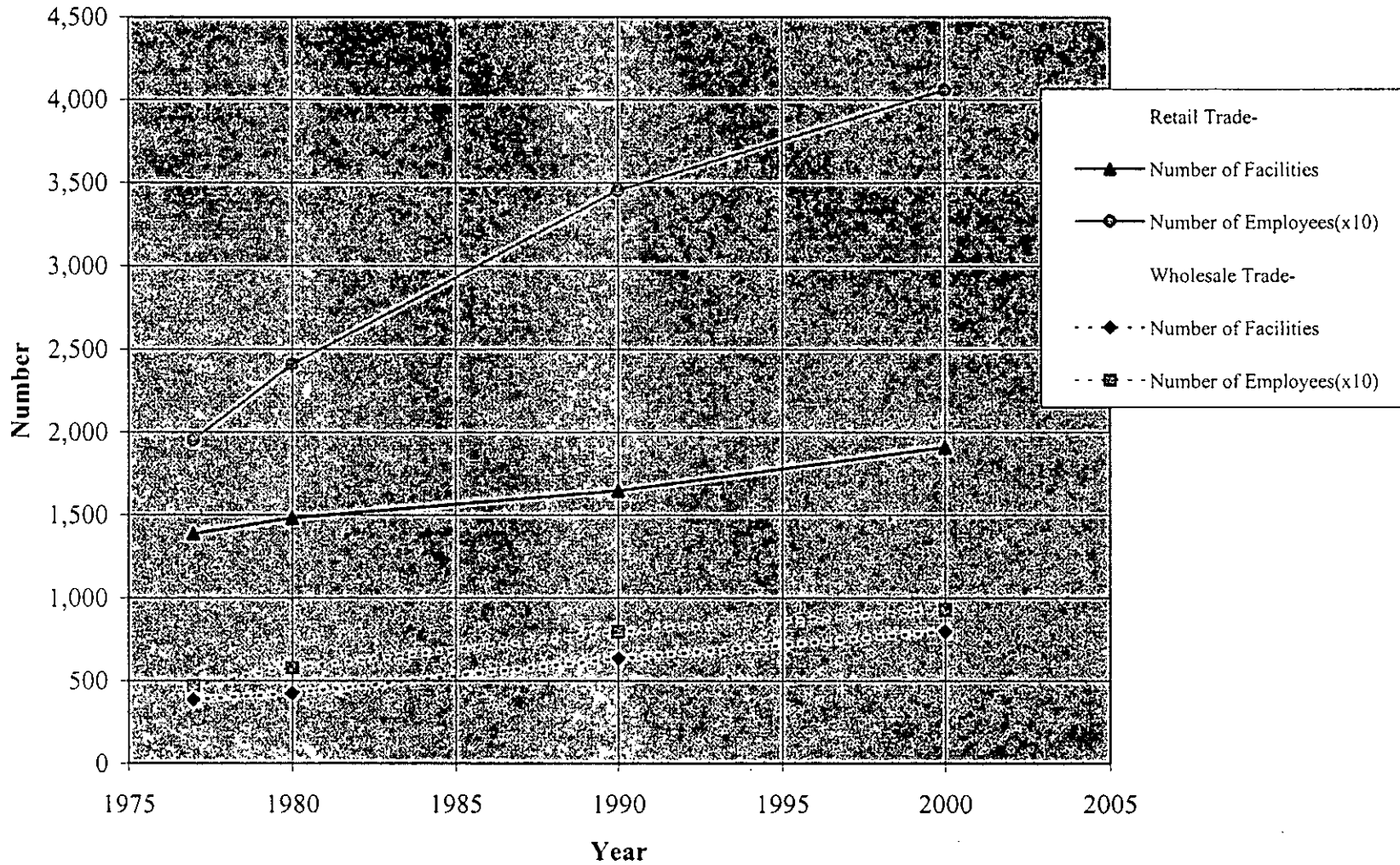

Figure 7-3. Labor Force Trend in Polk County

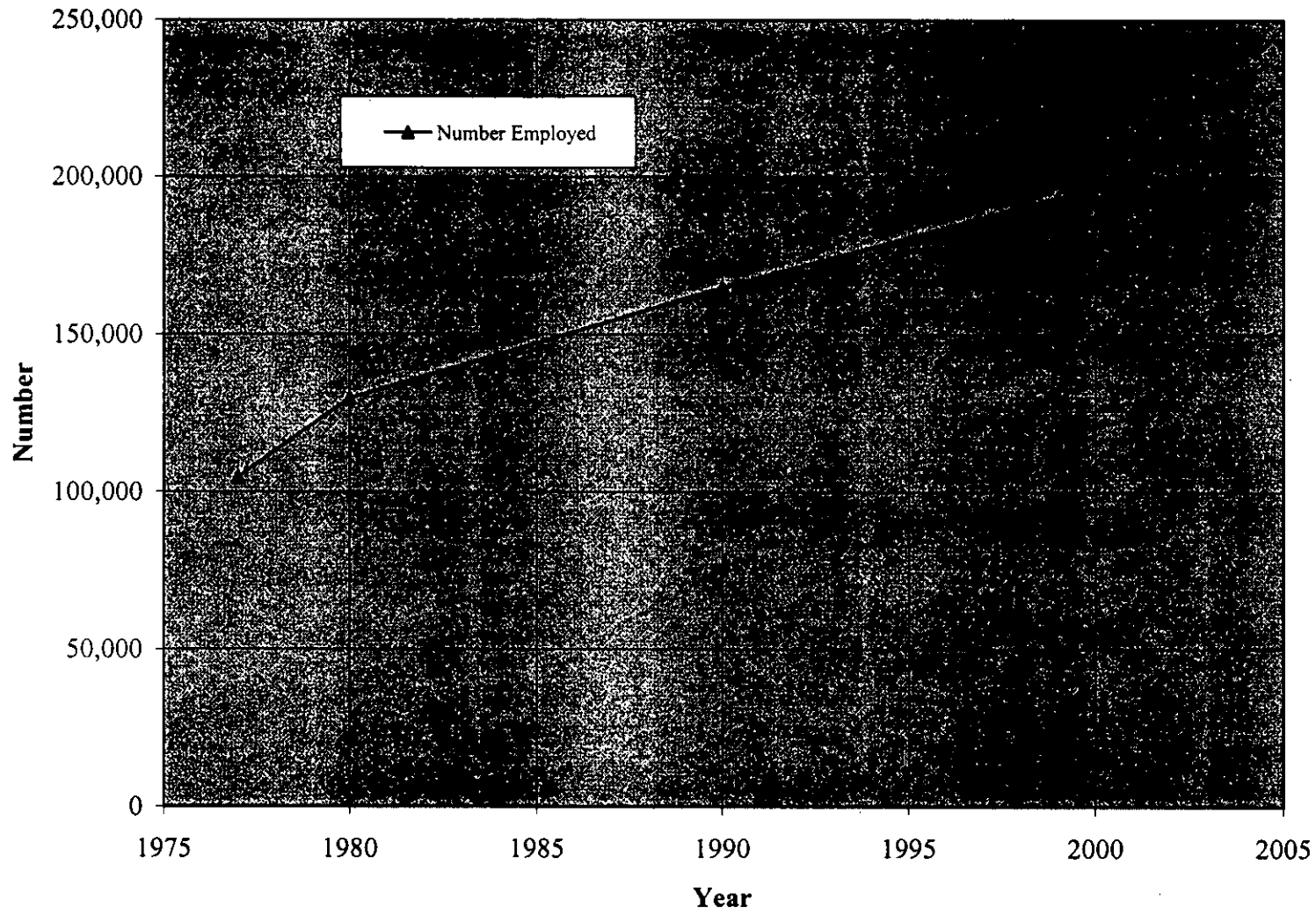

Figure 7-4. Hotel and Motel Trend in Polk County

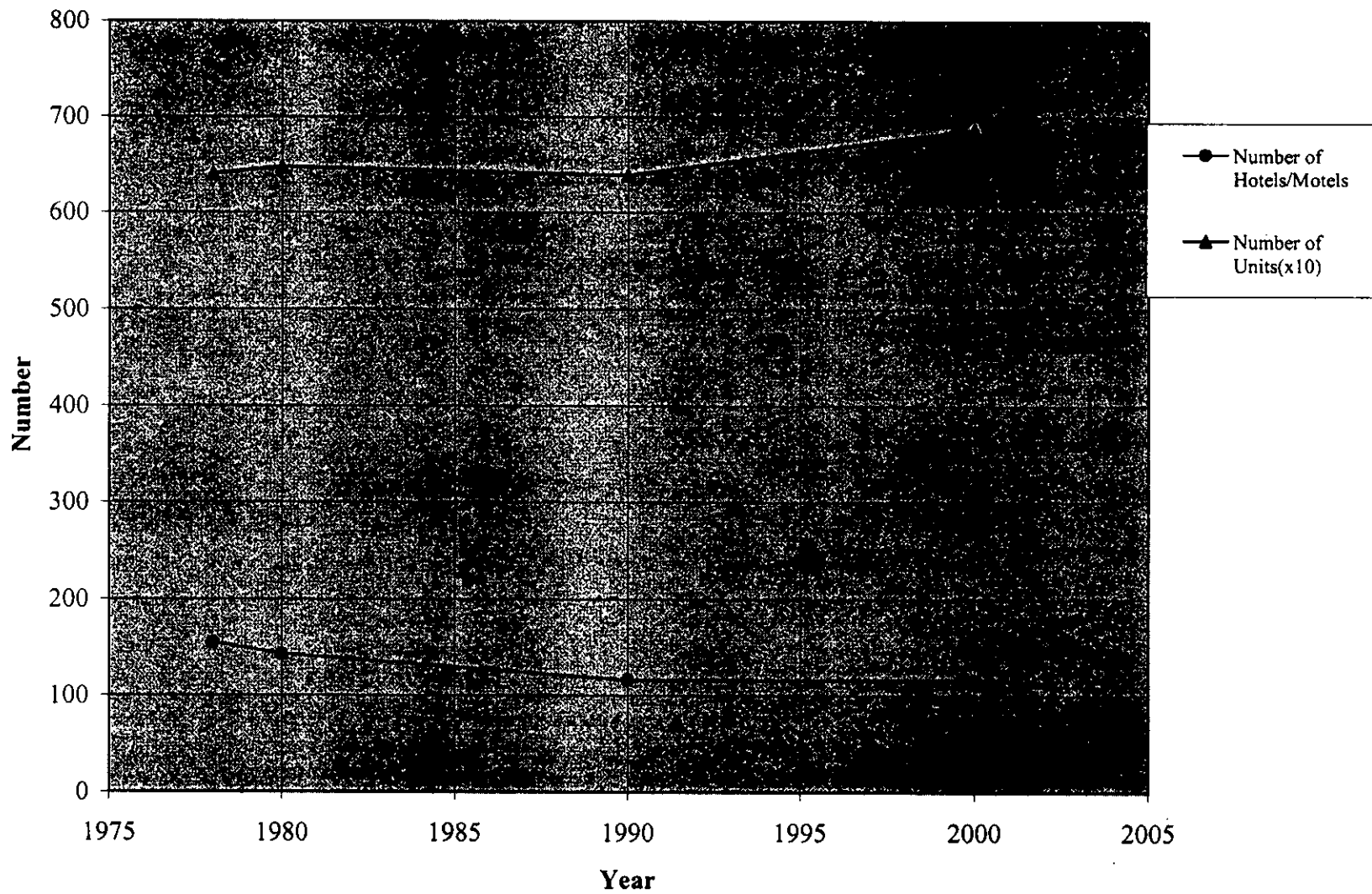

Figure 7-5. Vehicle Miles Traveled (VMT) Estimates for Motor Vehicles for Polk County

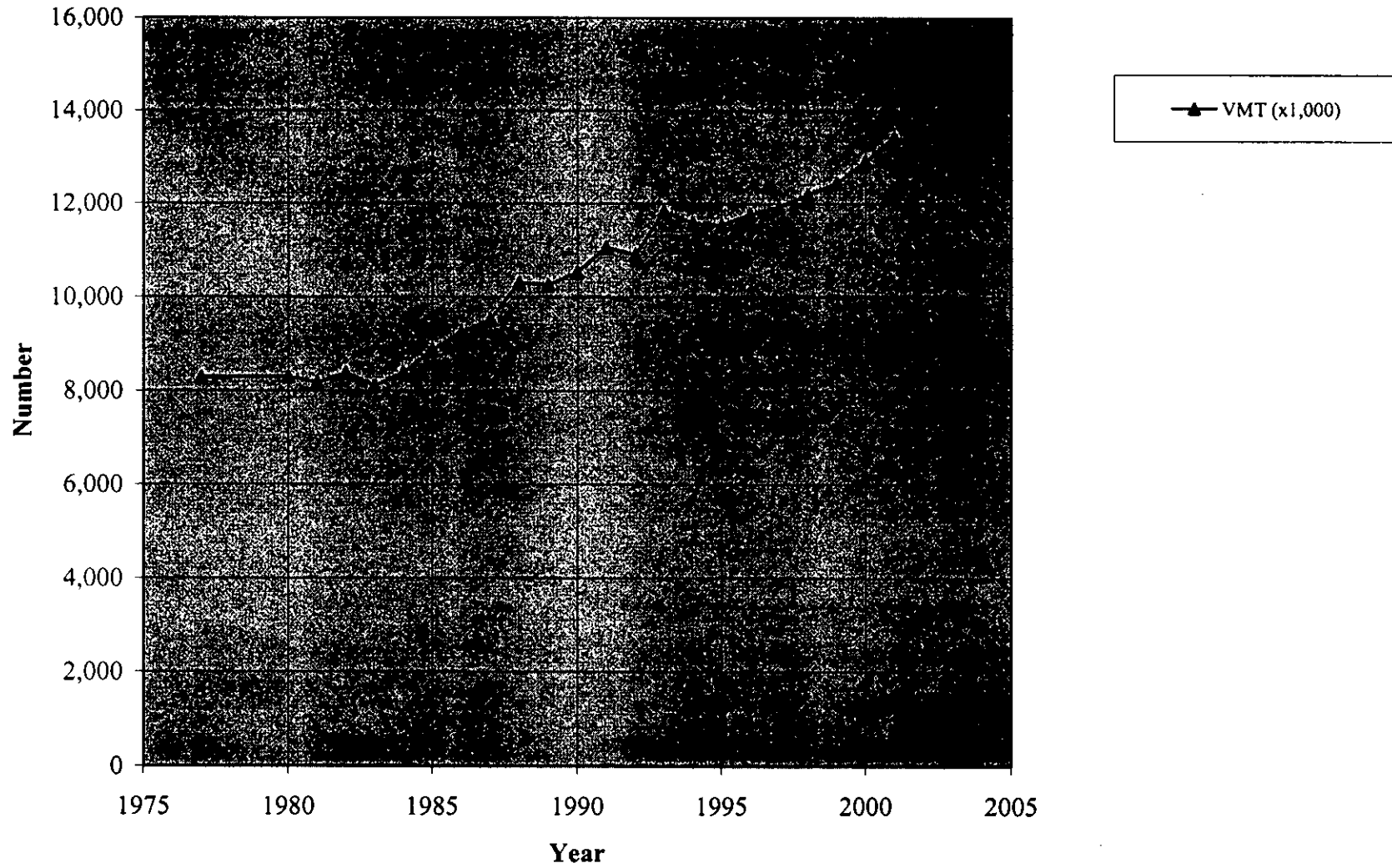

Figure 7-6. Mining, Manufacturing, and Citrus Industry Trends in Polk County

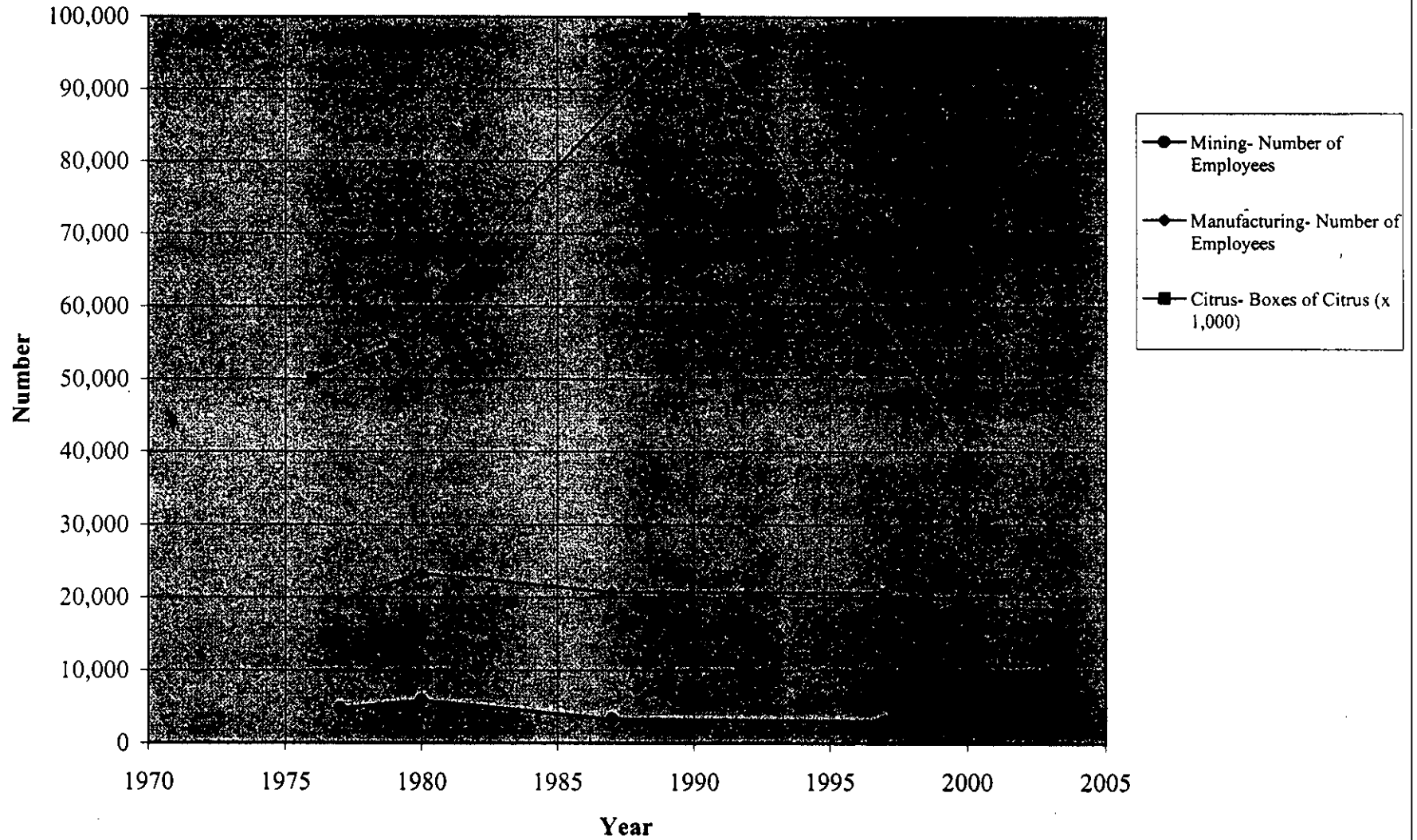

Figure 7-7. Electrical Power Generation Capacity in Polk County

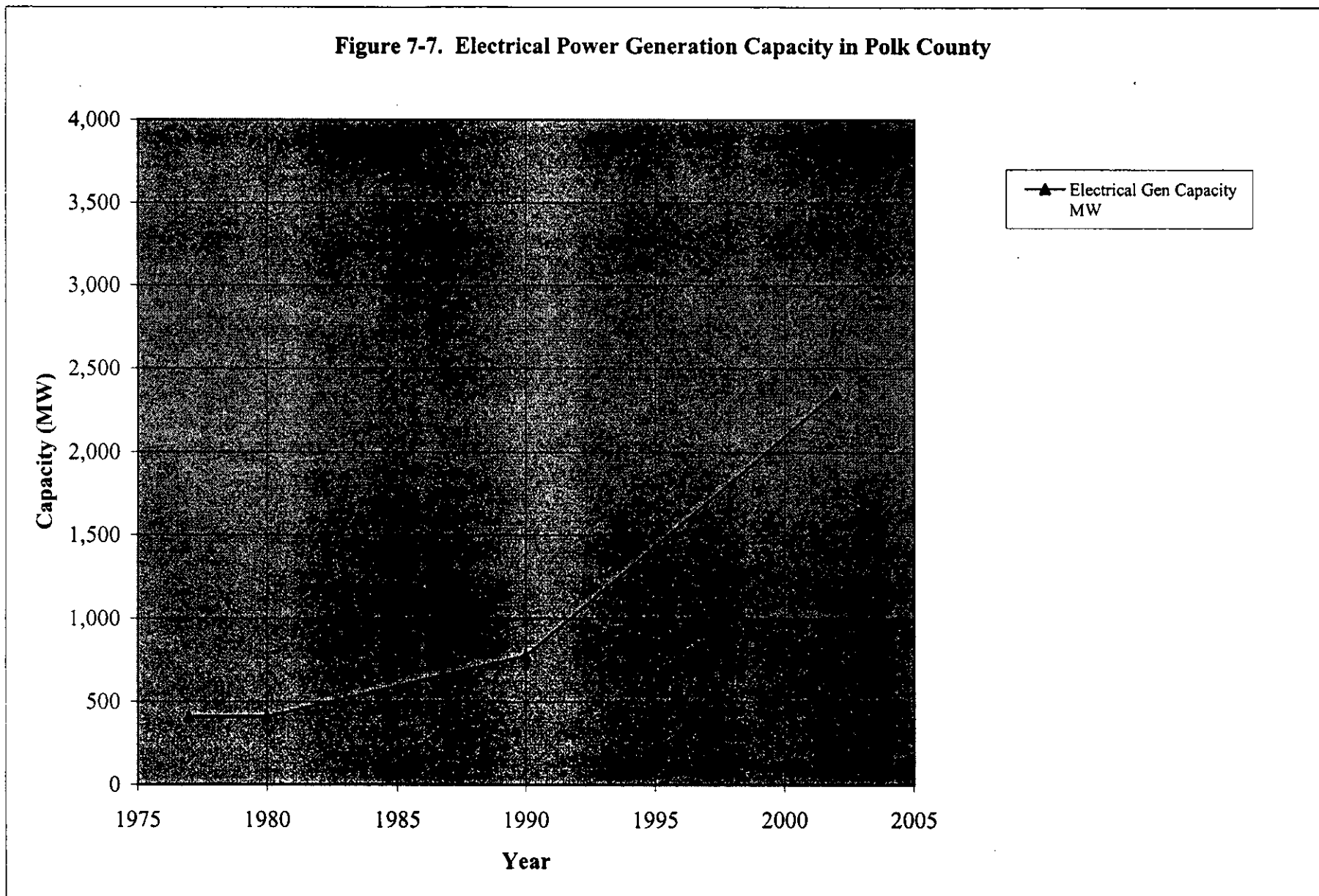
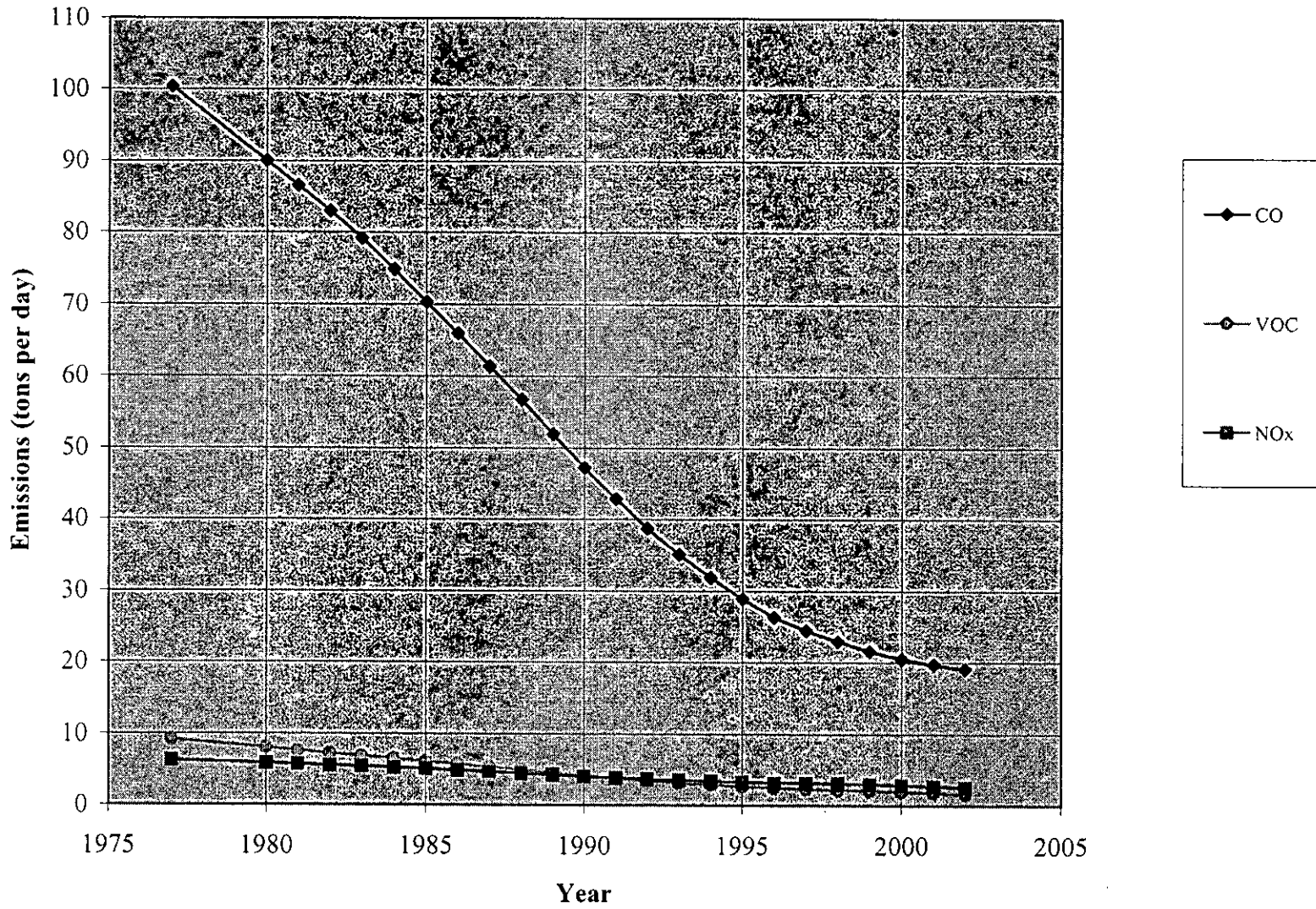
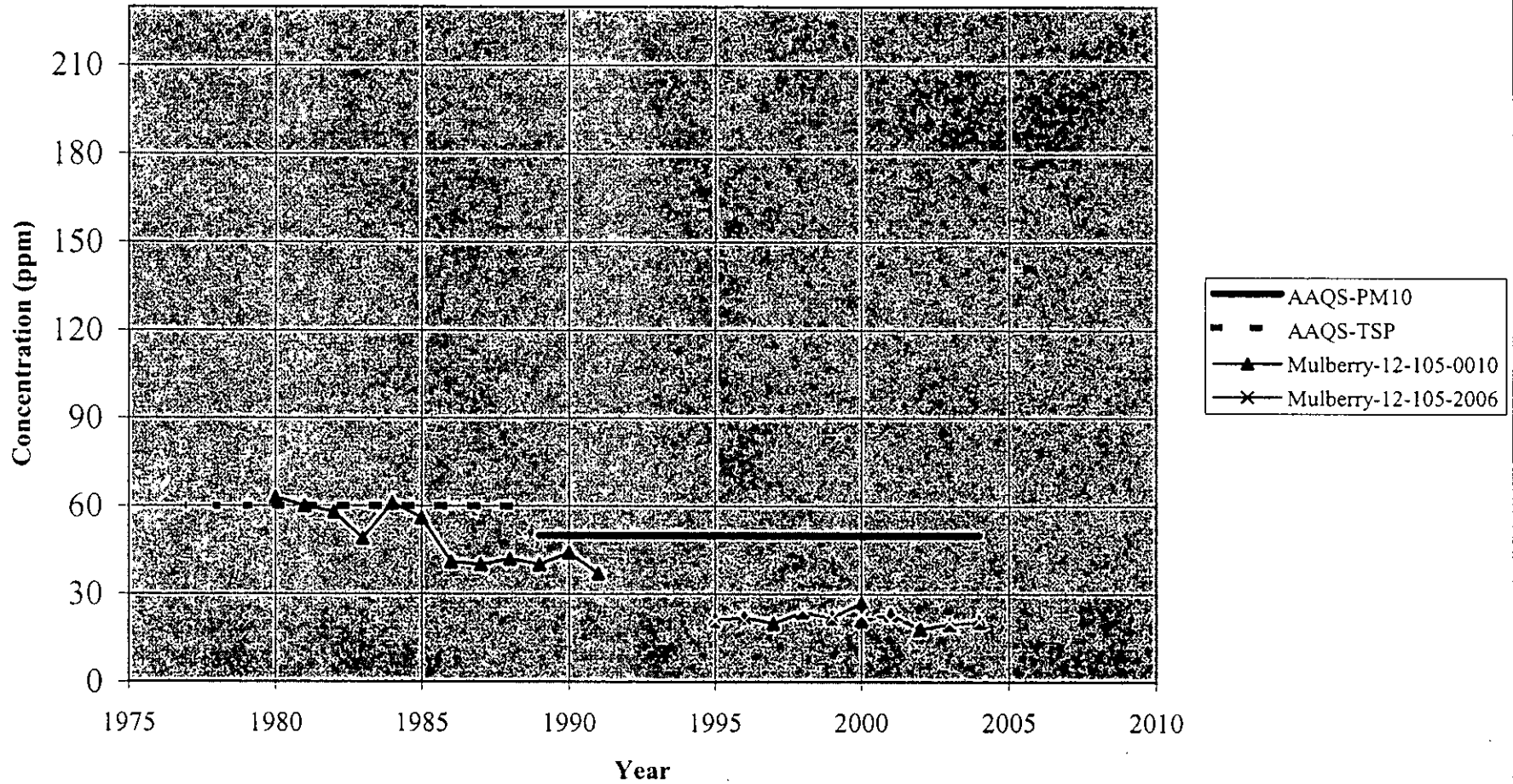



Figure 7-8. Mobile Source Emissions (Tons per Day) of CO, VOC, and NOx in Polk County



**Figure 7-9. Measured Annual Average PM10 Concentrations (1988 to 2004) and Total Suspended Particulate Concentrations (1977 to 1987) - Mulberry, Polk County**



**Figure 7-10. Measured 24-Hour Average PM10 Concentrations (1988 to 2004)  
and Total Suspended Particulate Concentrations (1977 to 1987)  
(2nd Highest Values) - Mulberry, Polk County**

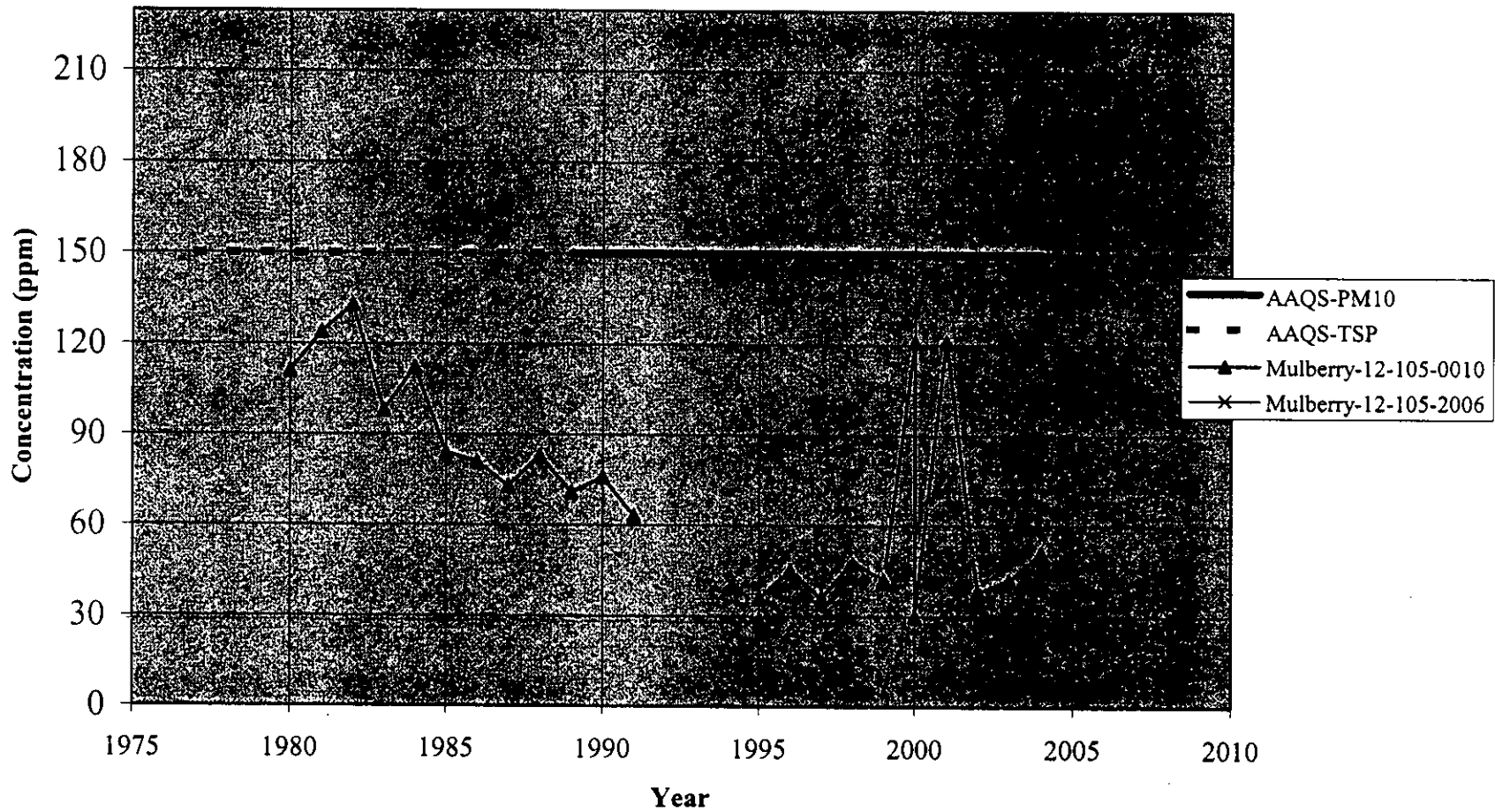

**Figure 7-11. Measured Annual Average Nitrogen Dioxide Concentrations from 1981 to 2004- Hillsborough County**

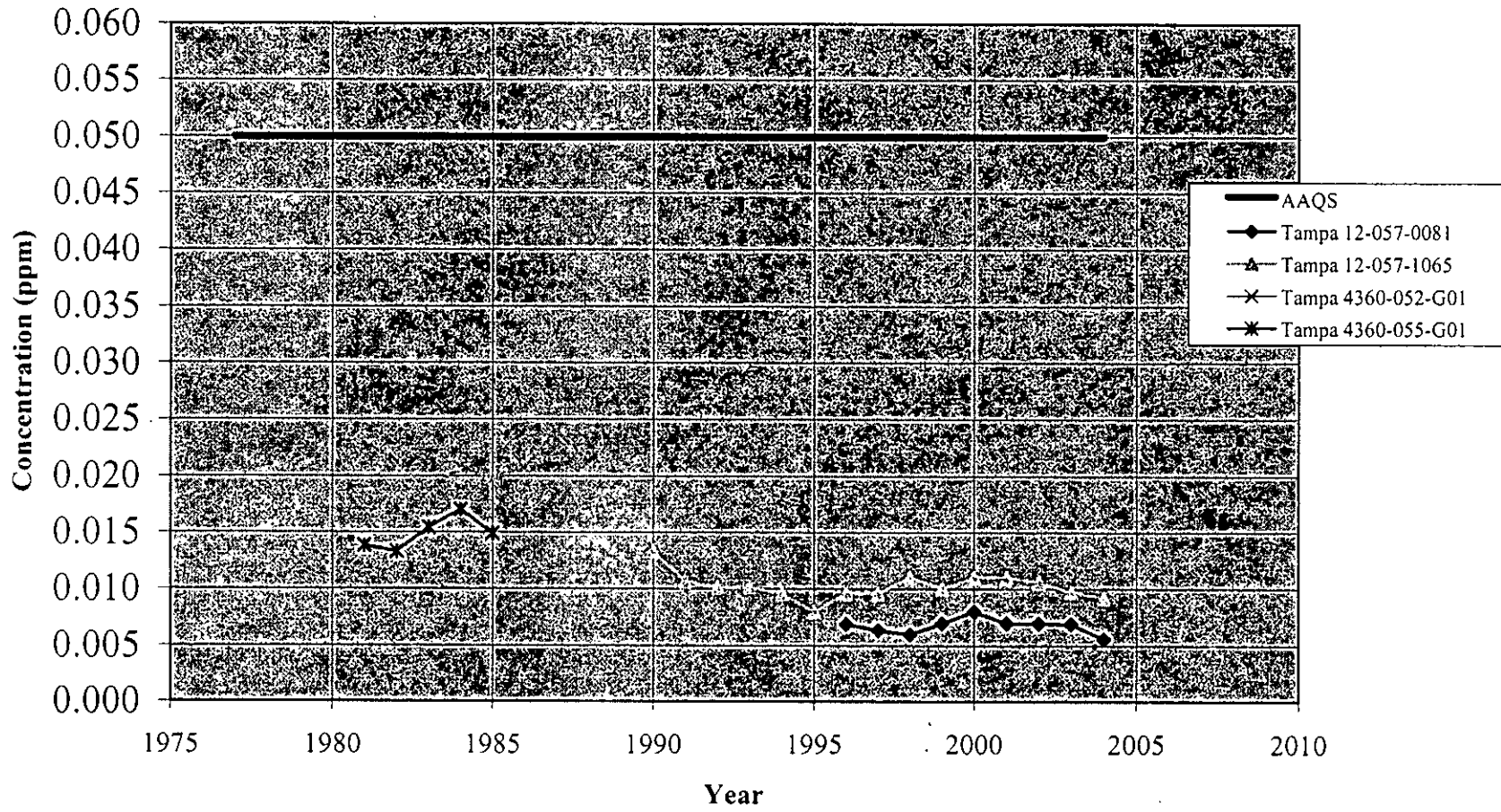

**8.0 REFERENCES**

**APPENDIX A**

**ACTUAL EMISSIONS FOR 2003 AND 2004, MOSAIC GREEN BAY**

Table A-1. Actual Emissions <sup>a</sup> for 2003--Mosaic Green Bay

Source Description	EU ID	Operating Hours	Pollutant Emission Rate (TPY)									
			SO <sub>2</sub>	NO <sub>x</sub>	CO	PM	PM <sub>10</sub>	VOC	TRS	SAM	Fluoride	
<b>A. Molten Sulfur Handling System</b>												
Molten Sulfur Storage Tank No. 1	030	8,760	1.23	--	--	1.40	1.40	2.54	1.71	--	--	
Molten Sulfur Storage Tank No. 2	031	8,760	3.64	--	--	1.43	1.43	2.58	1.75	--	--	
Molten Sulfur Storage Tank No. 3	032	8,760	3.64	--	--	1.43	1.43	2.58	1.75	--	--	
Molten Sulfur Storage Tank No. 4	039	8,760	2.10	--	--	0.77	0.77	1.61	1.05	--	--	
Molten Sulfur Truck Pit	033	8,760	0.13	--	--	0.05	0.05	0.10	0.07	--	--	
Molten Sulfur Rail/Back-up Truck Pit	034	8,760	1.23	--	--	1.40	1.40	2.54	1.71	--	--	
Molten Sulfur Supply Pit No. 4	036	8,760	0.13	--	--	0.05	0.05	0.10	0.07	--	--	
Molten Sulfur Supply Pit No. 5	035	8,760	0.13	--	--	0.05	0.05	0.10	0.07	--	--	
Molten Sulfur Supply Pit No. 6	041	8,760	0.13	--	--	0.05	0.05	0.10	0.07	--	--	
<b>Total</b>			<b>12.35</b>	<b>0.00</b>	<b>0.00</b>	<b>6.63</b>	<b>6.63</b>	<b>12.26</b>	<b>8.23</b>	<b>0.00</b>	<b>0.00</b>	
B. Sulfuric Acid Plant No. 4	004	8,572	726.02	24.04	--	--	--	--	--	18.51	--	
C. Sulfuric Acid Plant No. 5	005	8,333	1,299.33	35.12	--	--	--	--	--	17.91	--	
D. Sulfuric Acid Plant No. 6	038	8,638	835.86	30.39	--	--	--	--	--	44.45	--	
<b>E. Phosphoric Acid Production/Handling System</b>												
Phosphoric Acid Plant No. 1--North	016	7,403	--	--	--	--	--	--	--	--	0.21	
Phosphoric Acid Plant No. 1--South	017	7,230	--	--	--	--	--	--	--	--	0.16	
Phosphoric Acid Plant No. 2	013	7,787	--	--	--	--	--	--	--	--	0.11	
Green Superphosphoric Acid Plant	009	0	--	--	--	--	--	--	--	--	--	
Phosphoric Acid Tanks--54% (2)	014	8,760	--	--	--	--	--	--	--	--	0.01	
Phosphoric Acid Tanks (2)--Clarifying & Aging	015	8,760	--	--	--	--	--	--	--	--	0.05	
Phosphoric Acid Blend Tanks (4)	037	8,760	--	--	--	--	--	--	--	--	0.0004	
<b>Total</b>			<b>0.00</b>	<b>0.00</b>	<b>0.00</b>	<b>0.00</b>	<b>0.00</b>	<b>0.00</b>	<b>0.00</b>	<b>0.00</b>	<b>0.53</b>	
F. South DAP Fertilizer Plant	007	7,153	0.01	1.28	1.08	9.37	9.37	0.07	--	--	2.37	
G. North MAP/DAP Fertilizer Plant	029	7,310	0.03	5.01	4.21	18.86	18.86	0.28	--	--	3.73	
H. DAP, MAP, or TSP Storage & Shipping Buildings	020	8,760	--	--	--	17.60	17.60	--	--	--	0.44	
I. Therminol Heater	028	0	--	--	--	--	--	--	--	--	--	
J. Fugitive and Unregulated Facility-wide Emissions	042	8,760	--	--	--	--	--	--	--	--	--	
<b>Total Actual Emission Rates--2003</b>			<b>2,873.60</b>	<b>95.85</b>	<b>5.29</b>	<b>52.46</b>	<b>52.46</b>	<b>12.61</b>	<b>8.23</b>	<b>80.87</b>	<b>7.07</b>	

<sup>a</sup> Emissions from the 2003 AOR.

Table A-2. Actual Emissions <sup>a</sup> for 2004--Mosaic Green Bay

Source Description	EU ID	Operating Hours	Pollutant Emission Rate (TPY)								
			SO <sub>2</sub>	NO <sub>x</sub>	CO	PM	PM <sub>10</sub>	VOC	TRS	SAM	Fluoride
<b>A. Molten Sulfur Handling System</b>											
Molten Sulfur Storage Tank No. 1	030	8,760	1.23	--	--	1.40	1.40	2.54	1.71	--	--
Molten Sulfur Storage Tank No. 2	031	8,760	3.64	--	--	1.43	1.43	2.58	1.75	--	--
Molten Sulfur Storage Tank No. 3	032	8,760	3.64	--	--	1.43	1.43	2.58	1.75	--	--
Molten Sulfur Storage Tank No.4	039	8,760	2.10	--	--	0.77	0.77	1.61	1.05	--	--
Molten Sulfur Truck Pit	033	8,760	0.13	--	--	0.05	0.05	0.10	0.07	--	--
Molten Sulfur Rail/Back-up Truck Pit	034	8,760	1.23	--	--	1.40	1.40	2.54	1.71	--	--
Molten Sulfur Supply Pit No. 4	036	8,760	0.13	--	--	0.05	0.05	0.10	0.07	--	--
Molten Sulfur Supply Pit No. 5	035	8,760	0.13	--	--	0.05	0.05	0.10	0.07	--	--
Molten Sulfur Supply Pit No. 6	041	8,760	0.13	--	--	0.05	0.05	0.10	0.07	--	--
<b>Total</b>			<b>12.35</b>	<b>0.00</b>	<b>0.00</b>	<b>6.63</b>	<b>6.63</b>	<b>12.26</b>	<b>8.23</b>	<b>0.00</b>	<b>0.00</b>
B. Sulfuric Acid Plant No. 4	004	8,165	782.61	22.36	--	--	--	--	--	15.65	--
C. Sulfuric Acid Plant No. 5	005	8,573	1,270.77	24.04	--	--	--	--	--	30.91	--
D. Sulfuric Acid Plant No. 6	038	8,442	1,215.44	24.31	--	--	--	--	--	32.41	--
<b>E. Phosphoric Acid Production/Handling System</b>											
Phosphoric Acid Plant No. 1--North	016	7,157	--	--	--	--	--	--	--	--	1.15
Phosphoric Acid Plant No. 1--South	017	7,064	--	--	--	--	--	--	--	--	0.49
Phosphoric Acid Plant No. 2	013	7,305	--	--	--	--	--	--	--	--	0.30
Green Superphosphoric Acid Plant	009	0	--	--	--	--	--	--	--	--	--
Phosphoric Acid Tanks--54% (2)	014	8,760	--	--	--	--	--	--	--	--	0.11
Phosphoric Acid Tanks (2)--Clarifying & Aging	015	8,760	--	--	--	--	--	--	--	--	0.05
Phosphoric Acid Blend Tanks (4)	037	8,760	--	--	--	--	--	--	--	--	0.0004
<b>Total</b>			<b>0.00</b>	<b>0.00</b>	<b>0.00</b>	<b>0.00</b>	<b>0.00</b>	<b>0.00</b>	<b>0.00</b>	<b>0.00</b>	<b>2.09</b>
F. South DAP Fertilizer Plant	007	7,352	0.03	4.79	4.02	27.85	27.85	0.26	--	--	3.13
G. North MAP/DAP Fertilizer Plant	029	7,196	0.02	3.19	2.68	29.14	29.14	0.18	--	--	5.24
H. DAP, MAP, or TSP Storage & Shipping Buildings	020	6,222	--	--	--	4.98	4.98	--	--	--	0.03
I. Thermol Heater	028	0	--	--	--	--	--	--	--	--	--
J. Fugitive and Unregulated Facility-wide Emissions	042	8,760	--	--	--	--	--	--	--	--	--
<b>Total Actual Emission Rates--2004</b>			<b>3,281.23</b>	<b>78.69</b>	<b>6.70</b>	<b>68.60</b>	<b>68.60</b>	<b>12.70</b>	<b>8.23</b>	<b>78.97</b>	<b>10.49</b>

<sup>a</sup> Emissions from the 2004 AOR.



Table A-3. Average Actual Emissions\* for 2004 and 2003--Mosaic Greenbay

Source Description	EU ID	Operating Hours	Pollutant Emission Rate (TPY)									
			SO <sub>2</sub>	NO <sub>x</sub>	CO	PM	PM <sub>10</sub>	VOC	TRS	SAM	Fluoride	
<b>A. Molten Sulfur Handling System</b>												
Molten Sulfur Storage Tank No. 1	030	8,760	1.23	--	--	1.40	1.40	2.54	1.71	--	--	
Molten Sulfur Storage Tank No. 2	031	8,760	3.64	--	--	1.43	1.43	2.58	1.75	--	--	
Molten Sulfur Storage Tank No. 3	032	8,760	3.64	--	--	1.43	1.43	2.58	1.75	--	--	
Molten Sulfur Storage Tank No.4	039	8,760	2.10	--	--	0.77	0.77	1.61	1.05	--	--	
Molten Sulfur Truck Pit	033	8,760	0.13	--	--	0.05	0.05	0.10	0.07	--	--	
Molten Sulfur Rail/Back-up Truck Pit	034	8,760	1.23	--	--	1.40	1.40	2.54	1.71	--	--	
Molten Sulfur Supply Pit No. 4	036	8,760	0.13	--	--	0.05	0.05	0.10	0.07	--	--	
Molten Sulfur Supply Pit No. 5	035	8,760	0.13	--	--	0.05	0.05	0.10	0.07	--	--	
Molten Sulfur Supply Pit No. 6	041	8,760	0.13	--	--	0.05	0.05	0.10	0.07	--	--	
<b>Total</b>			<b>12.35</b>	<b>0.00</b>	<b>0.00</b>	<b>6.63</b>	<b>6.63</b>	<b>12.26</b>	<b>8.23</b>	<b>0.00</b>	<b>0.00</b>	
B. Sulfuric Acid Plant No. 4	004	8,369	754.32	23.20	--	--	--	--	--	17.08	--	
C. Sulfuric Acid Plant No. 5	005	8,453	1,285.05	29.58	--	--	--	--	--	24.41	--	
D. Sulfuric Acid Plant No. 6	038	8,540	1,025.65	27.35	--	--	--	--	--	38.43	--	
<b>E. Phosphoric Acid Production/Handling System</b>												
Phosphoric Acid Plant No. 1--North	016	7,280	--	--	--	--	--	--	--	--	--	0.68
Phosphoric Acid Plant No. 1--South	017	7,147	--	--	--	--	--	--	--	--	--	0.32
Phosphoric Acid Plant No. 2	013	7,546	--	--	--	--	--	--	--	--	--	0.20
Green Superphosphoric Acid Plant	009	0	--	--	--	--	--	--	--	--	--	--
Phosphoric Acid Tanks--54% (2)	014	8,760	--	--	--	--	--	--	--	--	--	0.06
Phosphoric Acid Tanks (2)--Clarifying & Aging	015	8,760	--	--	--	--	--	--	--	--	--	0.05
Phosphoric Acid Blend Tanks (4)	037	8,760	--	--	--	--	--	--	--	--	--	0.00
<b>Total</b>			<b>0.00</b>	<b>0.00</b>	<b>0.00</b>	<b>0.00</b>	<b>0.00</b>	<b>0.00</b>	<b>0.00</b>	<b>0.00</b>	<b>0.00</b>	<b>1.31</b>
F. South DAP Fertilizer Plant	007	7,253	0.02	3.03	2.55	18.61	18.61	0.17	--	--	--	2.75
G. North MAP/DAP Fertilizer Plant	029	7,253	0.02	4.10	3.45	24.00	24.00	0.23	--	--	--	4.49
H. DAP, MAP, or TSP Storage & Shipping Buildings	020	7,491	--	--	--	11.29	11.29	--	--	--	--	0.24
I. Therminol Heater	028	0	--	--	--	--	--	--	--	--	--	--
J. Fugitive and Unregulated Facility-wide Emissions	042	8,760	--	--	--	--	--	--	--	--	--	--
<b>Total Average Actual Emission Rates--2004 &amp; 2003</b>			<b>3,077.41</b>	<b>87.27</b>	<b>6.00</b>	<b>60.53</b>	<b>60.53</b>	<b>12.66</b>	<b>8.23</b>	<b>79.92</b>	<b>8.78</b>	

\* Emissions from the Annual Operating Report.

**APPENDIX B**

**PM<sub>10</sub> AND NO<sub>x</sub> EMISSION INVENTORIES FOR THE AAQS AND PSD CLASS II  
INCREMENT ANALYSES**

Table B-1. Summary of PM<sub>10</sub> Sources Included in the Air Modeling Analyses, Mosaic Green Bay

Facility ID	Facility Name Emission Unit Description	ISCST3 EU ID ID Name	Relative Location		Stack Parameters								PM <sub>10</sub> Emission		PSD			
			X (m)	Y (m)	Height		Diameter		Temperature		Velocity		Rate lb/hr	g/s	Consuming PSD Source? (EXP/CON)	AAQS	Modeled in Class II	
					ft	m	ft	m	°F	K	ft/s	m/s						
Bartow Phosphate Center (Formerly IMC Uranium Recovery)																		
		16IMCF	-1.100	2.100	85	25.9	0.7	0.2	75	297	38.1	11.6	-189.7	-23.90	EXP	No	Yes	
0570015	CF Industries, Inc. - Bartow																	
	No. 1 MAP/DAP/GTSP Shipping Unit	6	CFIBR2	-1.200	2.400	147	44.5	1.7	0.52	77	298	44.0	13.4	0.114	0.014	CON	Yes	Yes
	Boiler No. 1	21	CFIBR21	-1.200	2.400	36	11.0	2.5	0.76	600	559	44.0	13.4	0.5	0.063	NO	Yes	No
	No. 2 MAP/DAP Shipping Unit	9	CFIBR25	-1.200	2.400	171	52.1	1.1	0.34	77	298	84.0	25.6	0.114	0.014	CON	Yes	Yes
	Molten Sulfur System	32,33,34	CFIBRMS	-1.200	2.400	30	9.1	0.3	0.10	68	293	0.3	0.1	0.4	0.046	CON	Yes	Yes
1050046	Mosaic Fertilizer LLC- Bartow																	
	N. 3 Fertilizer Plant	1	CFBAR1	300	6,500	153	43.3	7.5	2.29	160	344	79.4	24.1	30.00	1.46	CON	Yes	Yes
	N. 4 Fertilizer Plant	21	CFBAR2	300	6,500	140	42.7	11.0	3.35	146	329	45.6	12.8	18.00	2.27	CON	Yes	Yes
	N.3 Fertilizer Shipping Plant	4	CFBAR3	300	6,500	80	24.4	2.3	0.70	77	297	38.2	11.4	12.00	1.51	CON	Yes	Yes
	N.4 Fertilizer Shipping Plant	2	CFBAR4	300	6,500	128	39.0	4.9	1.49	91	305	30.9	11.6	10.54	1.33	CON	Yes	Yes
	Phosphate Rock Grinding Mill "D" Vent		CFBAR5	300	6,500	83	25.3	1.7	0.51	115	319	26.6	8.1	-1.00	-0.13	EXP	No	Yes
	Phosphate Rock Storage Bin Stack R-4		CFBAR6	300	6,500	55	16.8	3.1	0.94	95	308	59.9	18.2	-5.10	-0.64	EXP	No	Yes
	Phosphate Rock Storage Bin Stack R-5		CFBAR7	300	6,500	55	16.8	3.0	0.92	75	297	74.7	22.8	-2.70	-0.34	EXP	No	Yes
	Phosphate Rock Storage Bin Stack R-6		CFBAR8	300	6,500	55	16.8	3.0	0.92	82	301	65.3	19.9	-9.00	-1.13	EXP	No	Yes
	Phosphate Rock Storage Bin Stack R-7		CFBAR9	300	6,500	50	15.2	1.1	0.33	113	318	25.5	7.8	-2.10	-0.26	EXP	No	Yes
	GTSP Fertilizer Plant N. 1, Stack N. 8		CFBAR10	300	6,500	100	30.5	6.7	2.03	135	330	47.9	14.6	-20.00	-2.52	EXP	No	Yes
	GTSP Shipping East, Stack N. 13		CFBAR11	300	6,500	92	28.0	1.8	0.55	75	297	34.7	10.6	-0.40	-0.05	EXP	No	Yes
	GTSP Shipping West, Stack N. 14		CFBAR12	300	6,500	95	29.0	2.2	0.67	75	297	14.0	4.3	-0.38	-0.05	EXP	No	Yes
	GTSP Storage Building E-1, Stack N. 31		CFBAR13	300	6,500	108	32.9	6.9	2.10	108	315	42.8	13.0	-0.71	-0.09	EXP	No	Yes
	GTSP Fertilizer Plant N. 1, Stack N. 7		CFBAR14	300	6,500	80	24.4	6.6	2.01	112	318	54.9	16.7	-10.20	-1.29	EXP	No	Yes
	GTSP Fertilizer Plant N. 2, Granulator Stack N. 12		CFBAR15	300	6,500	46	14.0	2.0	0.61	75	297	53.1	16.2	-0.10	-0.01	EXP	No	Yes
	Phosphate Rock Grinding Mill "A" Vent		CFBAR16	300	6,500	74	22.6	1.8	0.56	91	306	25.8	7.9	-1.13	-0.14	EXP	No	Yes
	Phosphate Rock Grinding Mill "B" Vent		CFBAR17	300	6,500	74	22.6	1.8	0.56	106	314	28.9	8.8	-0.90	-0.11	EXP	No	Yes
	Phosphate Rock Grinding Mill "C" Vent		CFBAR18	300	6,500	74	22.6	1.8	0.56	94	308	24.5	7.5	-0.93	-0.12	EXP	No	Yes
	Phosphate Rock Transfer Point R-10,R-11,R-12		CFBAR19	300	6,500	46	14.0	1.0	0.30	75	297	32.3	9.8	-0.10	-0.01	EXP	No	Yes
	Phosphate Rock Conveyor R-8		CFBAR20	300	6,500	53	16.2	0.7	0.22	75	297	21.2	6.4	-1.40	-0.18	EXP	No	Yes
	Phosphate Rock Conveyor, Stack N. 27		CFBAR21	300	6,500	40	12.2	1.8	0.56	99	310	37.9	11.6	-0.80	-0.10	EXP	No	Yes
	Phosphate Rock Conveyor, Stack N. 28		CFBAR22	300	6,500	58	17.7	1.8	0.56	91	306	38.0	11.6	-0.50	-0.06	EXP	No	Yes
	Phosphate Rock Conveyor, Stack N. 29		CFBAR23	300	6,500	71	21.6	1.8	0.56	91	306	38.0	11.6	-0.50	-0.06	EXP	No	Yes
	Phosphate Dryers R-1 and R-2		CFBAR24	300	6,500	50	15.2	6.7	2.05	140	333	56.6	17.2	-5.00	-0.63	EXP	No	Yes
7770051	U.S. Agri-Chemicals - Bartow																	
	150 TPH MAP/DAP Plant	1	USAGBR35	3,700	6,200	31	9.4	1.0	0.30	78	299	14.0	4.3	0.0	0.00	CON	Yes	Yes
	DAP/MAP Storage/Loading	1	USAGBR39	3,700	6,200	27	8.2	1.3	0.40	435	497	18.0	5.5	0.0	0.00	CON	Yes	Yes
1050234	Progress Energy Hines Energy Complex																	
	Power Block 1	22	HINES1	4,540	-6,190	35	10.7	170.0	51.8	300	422	0.0	0.0	44.8	5.64	CON	Yes	Yes
	Power Block 2	2	HINES2	4,540	-6,190	125	38.1	19.0	5.8	270	405	69.4	21.2	64.8	8.16	CON	Yes	Yes
	Power Block 3	5	HINES3	4,540	-6,190	125	38.1	18.0	5.5	270	405	69.4	21.2	64.8	8.16	CON	Yes	Yes
	HUMAN CREMATORY	3	HINESAX	4,540	-6,190	60	18.3	2.5	0.8	332	440	106.0	32.3	4.9	0.62	CON	Yes	Yes
	FOUR CEMENT STORAGE SILOS	4	HINESEG	4,540	-6,190	25	7.6	1.5	0.5	980	800	143.0	43.6	0.48	0.06	CON	Yes	Yes
1050055	Mosaic Phosphates (South Pierce)																	
	Auxiliary Boiler	1	IMCPIER1	-2,000	-8,700	35	10.7	4.8	1.46	430	494	51.0	15.5	1.76	0.22	CON	Yes	Yes
	GTSP Production Plant	23	IMCPIE23	-2,000	-8,700	140	42.7	9.0	2.74	110	316	36.0	11.0	35.0	4.41	CON	Yes	Yes
	GTSP East Storage Nrh	24	IMCPIE24	-2,000	-8,700	80	24.4	11.0	3.35	90	305	25.0	7.6	40.1	5.05	CON	Yes	Yes

Table B-1. Summary of PM<sub>10</sub> Sources Included in the Air Modeling Analyses. Mosaic Green Bay

Facility ID	Facility Name Emission Unit Description	EU ID	ISCST3 ID Name	Relative Location		Stack Parameters								PM <sub>10</sub> Emission		PSD Consuming		
				X (m)	Y (m)	Height		Diameter		Temperature		Velocity		Rate lb/hr	g/s	PSD Source? (EXP/CON)	Modeled in	
						ft	m	ft	m	°F	K	f/s	m/s				AAQS	Class II
	GTSP East Storage South	25	IMCPIE25	-2,000	-8,700	80	24.4	11.0	3.35	90	305	25.6	7.8	40.1	5.05	CON	Yes	Yes
1050145	Bartow Ethanol, Inc. BOILER	1	BRTETH1	9,250	-1,260	36	11.0	3.0	0.91	350	450	66.0	20.1	64.24	8.09	CON	Yes	Yes
1050056	CD Global Prairie Mine (Mosaic Agrico)																	
	Limestone Bucket Elevator	1	IMCPR1	-6,600	6,900	90	27.4	1.0	0.30	100	311	42.0	12.8	32.3	4.07	NO	Yes	No
	#1, Limerock Grinding	2	IMCPR2	-6,600	6,900	75	22.9	1.1	0.34	130	328	79.0	24.1	15.0	1.89	NO	Yes	No
	N. 3, Limerock Grinding	3	IMCPR3	-6,600	6,900	75	22.9	1.1	0.34	130	328	133.0	40.5	19.2	2.42	NO	Yes	No
	Limerock Dryer	4	IMCPR4	-6,600	6,900	70	21.3	4.4	1.34	184	358	51.0	15.5	32.4	4.08	NO	Yes	No
	#4 Raymond Mill	5	IMCPR5	-6,600	6,900	65	19.8	2.0	0.61	140	333	33.0	10.1	19.2	2.42	NO	Yes	No
	Limestone Bin & Truck Loadout	6	IMCPR6	-6,600	6,900	50	15.2	0.5	0.15	78	299	76.0	23.2	0.15	0.02	NO	Yes	No
	Feed Bin Area & Assoc. Equip.	7	IMCPR7	-6,600	6,900	75	22.9	1.1	0.34	130	328	175.0	53.3	2.4	0.30	NO	Yes	No
1050057	Mosaic Phosphates (Nichols)																	
	Phosphoric Acid Plant	1	IMCNIC1	-11,100	4,100	42	12.8	4.0	1.2	100	311	34.0	10.4	39.0	4.91	NO	Yes	No
	DAP Cooler Venturi Scrubber	2	IMCNIC2	-11,100	4,100	52	15.8	2.5	0.8	120	322	66.0	20.1	11.0	1.39	NO	Yes	No
	DAP Plant Dryer	3	IMCNIC3	-11,100	4,100	80	24.4	3.5	1.1	130	328	78.0	23.8	11.0	1.39	NO	Yes	No
	DAP Pkt Scrubber 4a	4	IMCNIC4	-11,100	4,100	72	21.9	3.2	1.0	190	361	101.0	30.8	11.0	1.39	NO	Yes	No
	North Ball Mill	9	IMCNIC9	-11,100	4,100	207	63.1	1.4	0.4	135	330	69.0	21.0	5.0	0.63	NO	Yes	No
	South Ball Mill	10	IMCNIC10	-11,100	4,100	207	63.1	1.4	0.4	135	330	69.0	21.0	5.0	0.63	NO	Yes	No
	Phosphate Rock Dryer W/ Wet Scrubber	12	IMCNIC12	-11,100	4,100	81	24.7	7.5	2.3	130	328	12.0	3.7	35.24	4.44	NO	Yes	No
	Package Boiler (North Standby Boiler)	15	IMCNIC15	-11,100	4,100	27	8.2	2.0	0.6	500	533	45.0	13.7	0.36	0.05	NO	Yes	No
	Package Boiler	16	IMCNIC16	-11,100	4,100	39	11.9	3.2	1.0	500	533	29.0	8.8	0.72	0.09	NO	Yes	No
	Dry Phosphate Rock Storage Bin	19	IMCNIC19	-11,100	4,100	207	63.1	0.9	0.3	140	333	168.0	51.2	11.0	1.39	NO	Yes	No
	Sulfur Storage & Handling Tank	21	IMCNIC21	-11,100	4,100	6	1.8	0.8	0.2	77	298	11.6	3.54	0.40	0.05	NO	Yes	No
1050047	Agrifos Mining, L.L.C. - Nichols																	
	Rock Dryer N. 1	1	AGRNIC1	-10,800	5,200	80	24.4	7.5	2.29	160	344	41.0	12.5	38.1	4.80	CON	Yes	Yes
	Rock Dryer N. 2	2	AGRNIC2	-10,800	5,200	80	24.4	7.5	2.29	160	344	41.0	12.5	38.1	4.80	CON	Yes	Yes
	Dry Rock Storage Building	10	AGRNIC10	-10,800	5,200	85	25.9	5.5	1.68	80	300	47.0	14.3	40.0	5.04	CON	Yes	Yes
	Dry Rock Loadout	11	AGRNIC11	-10,800	5,200	85	25.9	5.0	1.52	75	297	63.0	19.2	33.0	4.16	CON	Yes	Yes
1050034	Mosaic Phosphates (CFMO)																	
	Dryer No. 1 @ Noralyn Mine (011)	11	IMCFMO11	-11,300	-4,400	76	23.16	6.5	2.0	250	394	56.8	17.3	42.2	5.32	NO	Yes	No
	Dryer No. 2 East @ Noralyn Mine (012)	12	IMCFMO12	-11,300	-4,400	55	16.76	9.3	2.8	155	341	29.0	8.8	45.1	5.68	NO	Yes	No
	Silos 1, 2, 3, 12 @ Noralyn Mine (013)	13	IMCFMO13	-11,300	-4,400	150	45.72	3.5	1.1	100	311	52.0	15.8	35.0	4.41	NO	Yes	No
	Ball Mill Transfers @ Noralyn Mine (014)	14	IMCFMO14	-11,300	-4,400	24	7.32	2	0.6	110	316	26.5	8.1	15.0	1.89	NO	Yes	No
	Ball Mill Transfers @ Noralyn Mine (015)	15	IMCFMO15	-11,300	-4,400	24	7.32	2	0.6	110	316	26.5	8.1	10.0	1.26	NO	Yes	No
	Ball Mill No. 3 @ Noralyn Mine (016)	16	IMCFMO16	-11,300	-4,400	25	7.62	1.5	0.5	75	297	37.7	11.5	10.0	1.26	NO	Yes	No
	Ball Mill No. 4 @ Noralyn Mine (017)	17	IMCFMO17	-11,300	-4,400	27	8.23	2	0.6	75	297	15.9	4.8	10.0	1.26	NO	Yes	No
	No. 3 Ball Mill Loadouts @ Noralyn Mine (018)	18	IMCFMO18	-11,300	-4,400	25	7.62	1.5	0.5	77	298	37.7	11.5	10.0	1.26	NO	Yes	No
	No. 4 Ball Mill Loadouts @ Noralyn Mine (019)	19	IMCFMO19	-11,300	-4,400	29	8.84	1.8	0.5	77	298	19.7	6.0	10.0	1.26	NO	Yes	No
	A Track Railcar Loadout @ Noralyn Mine	20	IMCFMO20	-11,300	-4,400	27	8.23	2	0.6	85	303	53.1	16.2	15.0	1.89	NO	Yes	No
	B Track Railcar Loadout @ Noralyn Mine	21	IMCFMO21	-11,300	-4,400	27	8.23	1.9	0.6	81	300	71.8	21.9	15.0	1.89	NO	Yes	No
	Transfer Points To Conveyors C31 & C33 @ Noralyn	22	IMCFMO22	-11,300	-4,400	40	12.19	1.5	0.5	100	311	47.2	14.4	10.0	1.26	NO	Yes	No
	Material Transfer Sources @ Noralyn	23	IMCFMO23	-11,300	-4,400	43	13.11	2	0.6	86	303	26.5	8.1	15.0	1.89	NO	Yes	No
	Dry Phosphate Transfer @ Noralyn Mine (024)	24	IMCFMO24	-11,300	-4,400	135	41.15	2.8	0.9	60	289	55.0	16.8	15.0	1.89	NO	Yes	No
1050034	Mosaic Phosphates (CFMO)																	
	1 And 2 Grinders W/Scrubbers @ Kingsford Mine	2	IMCFMO2	-11,300	-4,400	60	18.3	2.5	0.8	110	316	64.0	19.5	33.5	4.22	NO	Yes	No
	No 3 Grinder W/Scrubber @ Kingsford Mine	3	IMCFMO3	-11,300	-4,400	58	17.7	1.9	0.6	100	311	49.0	14.9	30.0	3.78	NO	Yes	No

Table B-1. Summary of PM<sub>10</sub> Sources Included in the Air Modeling Analyses, Mosaic Green Bay

Facility ID	Facility Name Emission Unit Description	ISCS23 EU ID	ISCS23 ID Name	Relative Location		Stack Parameters						PM <sub>10</sub> Emission		PSD				
				X (m)	Y (m)	Height		Diameter		Temperature		Velocity		Rate lb/hr	g/s	Consuming PSD Source? (EXP/CON)	Modeled in	
						ft	m	ft	m	°F	K	ft/s	m/s				AAQS	Class II
	Phos Rk Dryer W/Scrubber @ Kingsford Mine	4	IMCFM04	-11,300	-4,400	70	21.3	7.0	2.1	165	347	47.0	14.3	44.2	5.57	NO	Yes	No
	Phosphate Transfer/Storage Silos W/Scrubber @ Kingsford	5	IMCFM05	-11,300	-4,400	106	32.3	2.5	0.8	95	308	67.0	20.4	20.0	2.52	NO	Yes	No
	Unground Phosphate Rr Car Load Out @ Kingsford Mine	6	IMCFM06	-11,300	-4,400	35	10.7	2.5	0.8	75	297	33.0	10.1	20.0	2.52	NO	Yes	No
	Boiler @ Four Corners Mine	8	IMCFM08	-11,300	-4,400	26	7.9	1.0	0.3	400	478	23.5	7.2	0.06	0.01	CON	Yes	Yes
	Magnetite Storage Bin @ Four Corners Mine (009)	9	IMCFM09	-11,300	-4,400	122	37.2	0.6	0.2	77	298	29.5	9.0	0.13	0.02	CON	Yes	Yes
	Ferrosilicon Storage Bin @ Four Corners Mine	10	IMCFM10	-11,300	-4,400	122	37.2	0.6	0.2	77	298	22.4	6.8	1.37	0.17	CON	Yes	Yes
	PSD Expanding source		12IMCF	-11,300	-4,400	125	38.1	8.0	2.4	151	339	49.7	15.1	-25.20	-3.18	EXP	No	Yes
	PSD Expanding source		13IMCF	-11,300	-4,400	125	38.1	8.0	2.4	151	339	55.1	16.8	-24.90	-3.14	EXP	No	Yes
	PSD Expanding source		14IMCF	-11,300	-4,400	150	45.7	2.7	0.8	110	316	27.7	8.4	-51.20	-6.45	EXP	No	Yes
1050059	Mosaic Phosphates (New Wales)																	
	PHOSPHATE ROCK RAILCAR UNLOADING (80 TPH MA	5	WALE55	-12,800	-700	40	12.2	3.00	0.9144	108	315	58.0	17.678	6.40	0.806	CON	Yes	Yes
	GROUND ROCK SILO W/PNEUMATIC 80 TPH LOAD RA1	6	WALE56	-12,800	-700	110	33.5	1.40	0.4267	110	316	45.0	13.716	1.30	0.164	CON	Yes	Yes
	DAP PLANT NO. 1 W/3 TELLER VENTURI SCRUBBERS,	9	WALE59	-12,800	-700	133	40.5	7.00	2.1336	105	314	49.0	14.935	28.60	3.604	NO	Yes	No
	GTSP PLANT (65 TPH) W/TELLER PACKED BED SCRUB	10	WALE510	-12,800	-700	133	40.5	6.00	1.8288	125	325	83.1	25.329	33.75	4.253	NO	Yes	No
	MAP PRILL TOWER W/VENTURI SCRUBBER AND CYCL	11	WALE511	-12,800	-700	120	36.6	4.00	1.2192	155	341	57.0	17.374	15.00	1.890	CON	Yes	Yes
	GTSP STORAGE (65 TPH) W/ FUME SCRUBBER	12	WALE512	-12,800	-700	133	40.5	6.00	1.8288	108	315	61.0	18.593	28.70	3.616	CON	Yes	Yes
	ANIMAL FEED SHIPPING/TRUCK LOADOUT (200 TPH),	15	WALE515	-12,800	-700	65	19.8	1.00	0.3048	105	314	169.0	51.511	1.08	0.136	CON	Yes	Yes
	GROUND PHOSPHATE ROCK BIN AT GTSP PLANT	21	WALE521	-12,800	-700	82	25.0	1.00	0.3048	105	314	53.0	16.154	4.80	0.605	CON	Yes	Yes
	ANIMAL FEED STORAGE SILOS (3) - "A" SIDE	23	WALE523	-12,800	-700	114	34.7	1.00	0.3048	105	314	33.0	10.058	4.75	0.599	CON	Yes	Yes
	ANIMAL FEED STORAGE/SHIPPING/RAILCAR LOADOU	24	WALE524	-12,800	-700	103	31.4	1.00	0.3048	105	314	140.0	42.672	3.60	0.454	CON	Yes	Yes
	ANIMAL FEED - (2) LIMESTONE SILOS	25	WALE525	-12,800	-700	119	36.3	1.00	0.3048	105	314	127.0	38.71	3.60	0.454	CON	Yes	Yes
	ANIMAL FEED - SILICA STORAGE BIN	26	WALE526	-12,800	-700	18	5.5	1.00	0.3048	105	314	31.0	9.4488	1.60	0.202	CON	Yes	Yes
	ANIMAL FEED INGREDIENT GRANULATION PLANT	27	WALE527	-12,800	-700	172	52.4	8.00	2.4384	130	328	66.3	20.208	36.80	4.637	CON	Yes	Yes
	ANIMAL FEED STORAGE SILOS (3) - "B" SIDE"	28	WALE528	-12,800	-700	114	34.7	1.00	0.3048	105	314	33.0	10.058	4.75	0.599	CON	Yes	Yes
	#1 FERTILIZER RAIL/TRUCK SHIPPING	29	WALE529	-12,800	-700	133	40.5	3.00	0.9144	90	305	42.4	12.924	4.70	0.592	CON	Yes	Yes
	MULTIFOS SODA ASH CONVEYING SYSTEM W/BAGHC	31	WALE531	-12,800	-700	108	32.9	0.80	0.2438	80	300	31.0	9.4488	3.60	0.454	CON	Yes	Yes
	MULTIFOS "A" KILN COOLER W/BAGHOUSE	32	WALE532	-12,800	-700	86	26.2	1.50	0.4572	220	378	258.0	78.638	7.70	0.970	CON	Yes	Yes
	MULTIFOS "B" KILN COOLER W/BAGHOUSE	33	WALE533	-12,800	-700	86	26.2	1.50	0.4572	274	408	225.0	68.58	7.70	0.970	CON	Yes	Yes
	MULTIFOS PLANT MILLING & SIZING SYSTEM WEST E	34	WALE534	-12,800	-700	71	21.6	1.70	0.5182	125	325	87.0	26.518	0.93	0.118	CON	Yes	Yes
	MULTIFOS MILLING & SIZING SYSTEM EAST BAGHOU	35	WALE535	-12,800	-700	71	21.6	1.00	0.3048	100	311	253.0	77.114	0.93	0.118	CON	Yes	Yes
	MULTIFOS PRODUCTION 1 DRYER 2 KILNS (A/B) FOR 1	36	WALE536	-12,800	-700	172	52.4	4.50	1.3716	105	314	52.0	15.85	29.83	3.759	CON	Yes	Yes
	MAP/DAP #2 TRUCK LOADOUT	37	WALE537	-12,800	-700	10	3.0	1.80	0.5486	100	311	68.0	20.726	3.60	0.454	CON	Yes	Yes
	MULTIFOS MILLING & SIZING SYST SURGE BIN BAGH	38	WALE538	-12,800	-700	65	19.8	1.10	0.3353	100	311	79.0	24.079	7.50	0.945	CON	Yes	Yes
	GTSP TRUCK LOADOUT FACILITY W/BAGHOUSE	41	WALE541	-12,800	-700	10	3.0	1.50	0.4572	100	311	179.0	54.559	5.00	0.630	CON	Yes	Yes
	MAP/DAP NO 2 RAIL LOADOUT	43	WALE543	-12,800	-700	10	3.0	1.60	0.4877	105	314	70.0	21.336	3.60	0.454	CON	Yes	Yes
	DAP PLANT II - EAST TRAIN	45	WALE545	-12,800	-700	171	52.1	6.00	1.8288	110	316	58.0	17.678	6.40	0.806	CON	Yes	Yes
	DAP PLANT II - WEST TRAIN	46	WALE546	-12,800	-700	171	52.1	6.00	1.8288	110	316	58.0	17.678	6.40	0.806	CON	Yes	Yes
	DAP II WEST PRODUCT COOLER	47	WALE547	-12,800	-700	147	44.8	4.30	1.3106	175	353	68.9	21.001	4.22	0.532	CON	Yes	Yes
	URANIUM RECOVERY ACID CLEANUP SCRUBBER	48	WALE548	-12,800	-700	60	18.3	3.50	1.0668	80	300	31.2	9.5098	1.00	0.126	CON	Yes	Yes
	URANIUM REFINERY W/BAGHOUSE	50	WALE550	-12,800	-700	100	30.5	1.80	0.5486	102	312	37.0	11.278	1.50	0.189	CON	Yes	Yes
	URANIUM RECOVERY - CLAY STORAGE BIN	51	WALE551	-12,800	-700	86	26.2	0.70	0.2134	80	300	54.0	16.459	1.50	0.189	CON	Yes	Yes
	ANIMAL FEED - LIMESTONE FEED BIN	52	WALE552	-12,800	-700	114	34.7	1.00	0.3048	105	314	33.0	10.058	4.75	0.599	CON	Yes	Yes
	DAP PLANT #1 PRODUCT COOLER	54	WALE554	-12,800	-700	107	32.6	3.50	1.0668	150	339	77.0	23.47	7.70	0.970	CON	Yes	Yes
	MAP PLANT COOLER	55	WALE555	-12,800	-700	25	7.6	4.30	1.3106	140	333	34.0	10.363	5.14	0.648	CON	Yes	Yes
	DAP II EAST PRODUCT COOLER	56	WALE556	-12,800	-700	170	51.8	5.00	1.524	110	316	64.5	19.66	6.06	0.764	CON	Yes	Yes
	GTSP RAILCAR LOADOUT FACILITY W/BAGHOUSE	59	WALE559	-12,800	-700	10	3.0	1.50	0.4572	100	311	68.9	21.001	5.00	0.630	CON	Yes	Yes
	LIMESTONE STORAGE SILO WITH BAGHOUSE	70	WALE570	-12,800	-700	110	33.5	0.75	0.2286	110	316	113.2	34.503	0.70	0.088	CON	Yes	Yes
	KILN C SCRUBBER STACK - MULTIFOS PLANT	74	WALE574	-12,800	-700	172	52.4	4.50	1.3716	105	314	70.2	21.397	14.30	1.802	CON	Yes	Yes
	MULTIFOS KILN C COOLER BAGHOUSE	75	WALE575	-12,800	-700	86	26.2	3.00	0.9144	250	394	106.1	32.339	1.90	0.239	CON	Yes	Yes
	MULTIFOS KILN C MILLING & SIZING BAGHOUSE	76	WALE576	-12,800	-700	90	27.4	1.50	0.4572	130	328	113.2	34.503	1.90	0.239	CON	Yes	Yes

Table B-1. Summary of PM<sub>10</sub> Sources Included in the Air Modeling Analyses, Mosaic Green Bay

Facility ID	Facility Name Emission Unit Description	ISCS T3 EU ID	ISCS T3 ID Name	Relative Location		Stack Parameters						PM <sub>10</sub> Emission Rate		PSD Consuming PSD Source?				
				X	Y	Height		Diameter		Temperature		Velocity		lb/hr	g/s	(EXP/CON)	AAQS	Modeled in Class II
				(m)	(m)	ft	m	ft	m	°F	K	ft/s	m/s					
1050003	Lakeland Electric, Larsen Power Plant																	
	Steam Generator # 6	3	LARPWR3	-600	22,400	165	50.3	10.0	3.05	340	444	21.0	6.4	31.0	3.91	NO	Yes	No
	Steam Generator # 7	4	LARPWR4	-600	22,400	165	50.3	10.0	3.05	340	444	22.0	6.7	60.0	7.56	NO	Yes	No
	Peaking Gas Turbine # 3	5	LARPWR5	-600	22,400	31	9.4	11.8	3.60	800	700	101.0	30.8	7.94	1.00	NO	Yes	No
	Peaking Gas Turbine # 2	6	LARPWR6	-600	22,400	31	9.4	11.8	3.60	800	700	101.0	30.8	7.94	1.00	NO	Yes	No
	Peaking Gas Turbine # 3	7	LARPWR7	-600	22,400	31	9.4	11.8	3.60	800	700	101.0	30.8	-7.94	-1.00	E	No	Yes
	Combined Cycle CT	8	LARPWR8	-600	22,400	155	47.2	16.0	4.88	481	523	85.7	26.1	26.0	3.28	CON	Yes	Yes
1050221	Auburndale Power Partners, LP																	
	Proposed Peaker Project CT(Phase I)		CALPEAK	11,300	23,200	50	15.2	22.0	6.7	1040	833	68.1	20.8	43.00	5.42	CON	Yes	Yes
	Existing CT (100% load/92° F Temp.)	1	CALEXT1	11,300	23,200	160	48.8	18.0	5.5	280	411	58.0	17.7	36.80	4.64	CON	Yes	Yes
1050004	Lakeland Electric, C.D. McIntosh, Jr. Power Plant																	
	McIntosh Unit 1	1	MCINT1	-500	26,100	150	45.7	9	2.7	277	409	81.2	24.7	520.0	65.52	NO	Yes	No
	Diesel Engine Peaking Unit 2	2	MCINT2	-500	26,100	20	6.1	2.6	0.8	715	653	77.0	23.5	1.75	0.22	NO	Yes	No
	Diesel Engine Peaking Unit 3	3	MCINT3	-500	26,100	20	6.1	2.6	0.8	715	653	77.0	23.5	1.75	0.22	NO	Yes	No
	Gas Turbine Peaking Unit 1	4	MCINT4	-500	26,100	35	10.7	13.5	4.1	900	755	79.5	24.2	20.24	2.55	NO	Yes	No
	McIntosh Unit 2	5	MCINT5	-500	26,100	157	47.9	10.5	3.2	277	409	73.2	22.3	518.8	65.37	NO	Yes	No
	McIntosh Unit 3	6	MCINT6	-500	26,100	250	76.2	18	5.5	167	348	82.6	25.2	1196.0	150.70	CON	Yes	Yes
	Combustion Turbine Unit 5	28	MCINT28	-500	26,100	85	25.9	28	8.5	1095	864	82.7	25.2	49.0	6.17	CON	Yes	Yes
1050023	Cutrale Citrus Juices USA, Inc																	
	Citrus Feed Mill Dryer	1	CCJUSA1	12,100	23,600	93	28.3	3.5	1.07	140	333	55.0	16.8	33	4.15	NO	Yes	No
	Peel Dryer	3	CCJUSA3	12,100	23,600	100	30.5	3.2	0.98	161	345	49.0	14.9	33	4.15	CON	Yes	Yes
	Cooling Reel Stack N. 1n	5	CCJUSA5	12,100	23,600	33	10.1	2.5	0.76	100	311	57.0	17.4	20	2.52	CON	Yes	Yes
	Cooling Reel Stack N. 2c	6	CCJUSA6	12,100	23,600	33	10.1	2.5	0.76	100	311	57.0	17.4	20	2.52	CON	Yes	Yes
	Cooling Reel Stack N. 3s	7	CCJUSA7	12,100	23,600	34	10.4	2.7	0.82	90	305	49.0	14.9	20	2.52	CON	Yes	Yes
0570025	Trademark Nitrogen Corp																	
	Nitric Acid Plant W/ 2 Absorption Towers	1	TRADE1	-42,200	12,500	50	15.2	1.7	0.5	350	450	17.9	5.5	334	42.08	NO	Yes	No
0570039	TECO - Big Bend Station																	
	Unit #1 Coal Fired Boiler w/ ESP	1	TECOBB1	-47,600	-5,100	490	149.35	24.0	7.3	300	422	116.0	35.4	404	50.904	NO	Yes	No
	Unit #2 Riley-Stoker Coal Boiler w/ Esp	2	TECOBB2	-47,600	-5,100	490	149.35	24.0	7.3	300	422	116.0	35.4	400	50.400	NO	Yes	No
	Unit #3 Riley-Stoker Coal Boiler w/ ESP	3	TECOBB3	-47,600	-5,100	499	152.10	24.0	7.3	292	418	51.2	15.6	412	51.912	NO	Yes	No
	Unit #4 Coal Boiler W/ Belco ESP Psd-FI-040	4	TECOBB4	-47,600	-5,100	499	152.10	24.0	7.3	156	342	59.0	18.0	130	16.380	CON	Yes	Yes
	Combustion Turbine #2 - No. 2 Fuel Oil	5	TECOBB5	-47,600	-5,100	75	22.86	14.0	4.3	928	771	61.0	18.6	33.0	4.158	NO	Yes	No
	Gas Turbine #3 - No. 2 Fuel Oil	6	TECOBB6	-47,600	-5,100	75	22.86	14.0	4.3	928	771	61.0	18.6	33.0	4.158	NO	Yes	No
	Gas Turbine #1 No. 2 Fuel Oil	7	TECOBB7	-47,600	-5,100	35	10.67	11.0	3.4	1010	816	91.9	28.0	33.0	4.158	NO	Yes	No
	Unit No. 1 & No. 2 Fly Ash Silo w/Baghouse	8	TECOBB8	-47,600	-5,100	102	31.09	2.5	0.8	250	394	52.0	15.8	5.16	0.650	NO	Yes	No
	Fly-Ash Silo For Unit #3	9	TECOBB9	-47,600	-5,100	113	34.44	0.9	0.3	250	394	406.0	123.7	3.00	0.378	NO	Yes	No
	Limestone Silo A W/ 2 Baghouses	12	TECOBB12	-47,600	-5,100	101	30.78	0.5	0.2	150	339	46.0	14.0	0.05	0.006	NO	Yes	No
	Limestone Silo B W/ 2 Baghouses	13	TECOBB13	-47,600	-5,100	101	30.78	0.5	0.2	150	339	46.0	14.0	0.05	0.006	NO	Yes	No
	Flyash Silo For Unit #4	14	TECOBB14	-47,600	-5,100	139	42.37	1.6	0.5	140	333	59.0	18.0	0.20	0.025	NO	Yes	No
	Unit 1 Coal Bunker W/Roto-Clone	15	TECOBB15	-47,600	-5,100	179	54.56	1.7	0.5	78	299	69.0	21.0	0.48	0.060	NO	Yes	No
	Unit 2 Coal Bunker W/Roto-Clone	16	TECOBB16	-47,600	-5,100	179	54.56	1.7	0.5	78	299	69.0	21.0	0.48	0.060	NO	Yes	No
	Unit 3 Coal Bunker W/Roto-Clone	17	TECOBB17	-47,600	-5,100	179	54.56	1.7	0.5	78	299	69.0	21.0	0.48	0.060	NO	Yes	No
0810010	Florida Power & Light - Manatee Combined Facility		FPLMAN1	-42,250	-25,950	475	144.8	26.2	8.0	307	426	77.5	23.6	1730	217.98	NO	Yes	No

Table B-1. Summary of PM<sub>10</sub> Sources Included in the Air Modeling Analyses, Mosaic Green Bay

Facility ID	Facility Name Emission Unit Description	EU ID	ISCST3 ID Name	Relative Location		Stack Parameters						PM <sub>10</sub> Emission		PSD					
				X	Y	Height		Diameter		Temperature		Velocity		Rate		Consuming PSD Source?	Modeled in		
				(m)	(m)	ft	m	ft	m	°F	K	ft/s	m/s	lb/hr	g/s		AAQS	Class II	
0570040	TECO Gannon																		
	Unit #1 Steam Generator	1	TECOGN1	-49,400	7,400	315	96.0	10.0	3.0	277	409	124.4	37.9	126	15.88	NO	Yes	No	
	Unit #2	2	TECOGN2	-49,400	7,400	315	96.0	10.0	3.0	299	421	126.3	38.5	126	15.88	NO	Yes	No	
	Unit #3 Coal Fired Boiler	3	TECOGN3	-49,400	7,400	315	96.0	10.6	3.2	271	406	113.5	34.6	160	20.16	NO	Yes	No	
	Unit#4 Coal Fired Boiler	4	TECOGN4	-49,400	7,400	315	96.0	10.0	3.0	289	416	97.1	29.6	188	23.69	NO	Yes	No	
	Unit #5 Coal Fired Boiler	5	TECOGN5	-49,400	7,400	315	96.0	14.6	4.5	293	418	166.5	50.7	228	28.73	NO	Yes	No	
	Unit #6 - Coal Fired Boiler With ESP	6	TECOGN6	-49,400	7,400	315	96.0	17.6	5.4	260	400	109.2	33.3	380	47.88	NO	Yes	No	
	Gas Fired Turbine	7	TECOGN7	-49,400	7,400	35	10.7	11.0	3.4	1,010	816	92.6	28.2	122	15.37	NO	Yes	No	
	Economizer Ash Silo	9	TECOGN8	-49,400	7,400	72	21.9	0.7	0.2	350	450	35.0	10.7	0.14	0.02	NO	Yes	No	
	Flyash Silo No. 1 For Units 5 & 6	10	TECOGN9	-49,400	7,400	107	32.6	1.0	0.3	350	450	99.0	30.2	1.20	0.15	NO	Yes	No	
	Fly Ash Silo No. 2 Units 1-4	11	TECOGN11	-49,400	7,400	104	31.7	2.0	0.6	350	450	59.0	18.0	2.90	0.37	NO	Yes	No	
	Unit 1 Coal Bunker W/Roto-Clone	13	TECOGN13	-49,400	7,400	175	53.3	1.7	0.5	78	299	70.0	21.3	0.19	0.02	NO	Yes	No	
	Unit 2 Coal Bunker W/Roto-Clone	14	TECOGN14	-49,400	7,400	175	53.3	1.7	0.5	78	299	70.0	21.3	0.19	0.02	NO	Yes	No	
	Unit 3 Coal Bunker W/Roto-Clone	15	TECOGN15	-49,400	7,400	177	53.9	2.0	0.6	78	299	50.0	15.2	0.19	0.02	NO	Yes	No	
	Unit 4 Coal Bunker W/Roto-Clone	16	TECOGN16	-49,400	7,400	175	53.3	1.7	0.5	78	299	70.0	21.3	0.19	0.02	NO	Yes	No	
	Unit 5 Coal Bunker W/Roto-Clone	17	TECOGN17	-49,400	7,400	174	53.0	1.2	0.4	78	299	79.0	24.1	0.19	0.02	NO	Yes	No	
	Unit 6 Coal Bunker W/Roto-Clone	18	TECOGN18	-49,400	7,400	175	53.3	1.7	0.5	78	299	70.0	21.3	0.19	0.02	NO	Yes	No	
0570038	TECO Hookers Point																		
	Boiler #1	1	TECOHK1	-51,500	10,900	280	85.3	11.3	3.4	356	453	82.0	25.0	37.3	4.70	NO	Yes	No	
	Boiler #2	2	TECOHK2	-51,500	10,900	280	85.3	11.3	3.4	356	453	82.0	25.0	37.3	4.70	NO	Yes	No	
	Boiler #3	3	TECOHK3	-51,500	10,900	280	85.3	12.0	3.7	341	445	62.7	19.1	51.4	6.48	NO	Yes	No	
	Boiler #4	4	TECOHK4	-51,500	10,900	280	85.3	12.0	3.7	341	445	62.7	19.1	51.4	6.48	NO	Yes	No	
	Boiler #5	5	TECOHK5	-51,500	10,900	280	85.3	11.3	3.4	356	453	82.0	25.0	76.3	9.61	NO	Yes	No	
	Boiler #6	6	TECOHK6	-51,500	10,900	280	85.3	9.4	2.9	329	438	75.2	22.9	97.3	12.26	NO	Yes	No	
0970014	Progress Energy- Intercession City Plant																		
	Combined CTs 1-6	1-6	INTCP16	36,800	45,900	48	14.6	14.6	4.46	760	678	174.9	53.3	250.68	31.62	NO	Yes	No	
	Combined CTs 7-10	7-10	INTCP710	36,800	45,900	50	15.2	13.8	4.19	1043	835	139.4	42.5	60.0	7.56	CON	Yes	Yes	
	CT # 11	11	INTCP11	36,800	45,900	75	22.9	19.0	5.79	1034	830	139.4	42.5	17.0	2.14	CON	Yes	Yes	
1030244	A-American Rent All Concrete Batching Plant	1	AAMER1	-85,400	-900	5.0	1.52	2.0	0.6	90	305	10.5	3.2	500	63,000	CON	Yes	Yes	
1010017	Progress Energy- Anclote Power Plant																		
	Steam Turbine Gen Anclote Unit No 1	1	FPCANCI	-85,100	38,600	499	152.10	24	7.3	320	433	62.0	18.9	621	78,183	NO	Yes	No	
	525 Mw #6 Oil Fired Steam Generator	2	FPCANC2	-85,100	38,600	499	152.10	24	7.3	320	433	62.0	18.9	606	76,388	NO	Yes	No	

<sup>b</sup> FPC Crystal River Units 3 and 4 are at GEP height

Note. EXP = PSD expanding source.  
 CON = PSD consuming source.  
 NO = Baseline Source, does not affect PSD increment.  
 ND = No data available.

Table B-2 Summary of NO<sub>x</sub> Sources Included in the Air Modeling Analyses, Mosiac Green Bay

FAC. ID	FAC. Name	Emission Unit Description	EU ID	ISCST3 ID Name	Relative Location		Stack Parameters						Emission Rate		PSD Consuming PSD Source? (EXP/CON)	Modeled in			
					East (m)	North (m)	Height		Diameter		Temperature		Velocity			TPY	g/s	AAQS	Class II
					ft	m	ft	m	°F	K	f/s	m/s							
1050217	POLK POWER PARTNERS, L.P.-MULBERRY	Combustion Turbine with HRSG(Phase II, Acid Rain Unit)	1	PPMCT1	4,100	500	125	38.10	15	4.57	220	378	64.1	19.54	230.70	6.637	CON	Yes	Yes
		Secondary Boiler (Phase II, Acid Rain Unit)	2	PPMBOIL	4,100	500	125	38.10	3	0.91	220	378	66.5	20.27	80.00	2.301	CON	Yes	Yes
1050048	MOSAIC PHOSPHATES (formerly MULBERRY PHOSPHATES, INC.)	MAP/DAP PLANT SCRUBBER	5	CMUL5	-2,700	5,000	102	31.09	8.8	2.68	110	316	26	7.92	18.40	0.529	CON	Yes	Yes
		NEBRASKA MODEL NS-E-65 STEAM BOILER	9	CMUL9	-2,700	5,000	45	13.72	3.7	1.13	80	300	8	2.44	104.81	3.015	CON	Yes	Yes
1050046	MOSAIC FERTILIZER LLC- BARTOW	NO.3 FERTILIZER PLANT	1	CFBAR1	300	6,500	99	30.18	7.5	2.29	135	330	53	16.15	23.60	0.679	CON	Yes	Yes
		No. 4 Sulfuric Acid Plant	12	CFBAR12	300	6,500	200	60.96	6.8	2.07	180	355	61	18.59	57.00	1.640	CON	Yes	Yes
		NO.4 FERTILIZER PLANT	21	CFBAR21	300	6,500	140	42.67	10.9	3.32	132	329	53	16.15	23.60	0.679	CON	Yes	Yes
		No. 6 Sulfuric Acid Plant	32	CFBAR32	300	6,500	200	60.96	6.8	2.07	180	355	61	18.59	57.00	1.640	CON	Yes	Yes
		No. 5 Sulfuric Acid Plant	33	CFBAR33	300	6,500	200	60.96	6.8	2.07	180	355	61	18.59	57.00	1.640	CON	Yes	Yes
51	CFBAR51	300	6,500	31	9.45	3.5	1.07	410	483	20	6.10	28.05	0.807	NO	Yes	No			
1050234	HINES ENERGY COMPLEX (PROGRESS ENERGY)	250 MW Combined Cycle Combustion Turbine 1 NG Primary Fuel	1	HINES1	4,840	-6,190	300	91.44	9	2.74	312	429	119.2	36.33	319.50	9.191	CON	Yes	Yes
		250 MW Combined Cycle Combustion Turbine 2 NG Primary Fuel	2	HINES2	4,840	-6,190	125	38.10	19	5.79	270	405	69.4	21.15	319.50	9.191	CON	Yes	Yes
		Auxiliary Boiler	3	HINES3	4,840	-6,190	60	18.29	2.5	0.76	332	440	106	32.31	86.70	2.494	CON	Yes	Yes
		EMERGENCY DIESEL GENERATOR	4	HINES4	4,840	-6,190	25	7.62	1.5	0.46	980	800	143	43.59	232.14	6.678	CON	Yes	Yes
		250 MW Combined Cycle Combustion Turbine 3 NG Primary Fuel	5	HINES5	4,840	-6,190	125	38.10	18	5.49	270	405	69.4	21.15	133.40	3.838	CON	Yes	Yes
1050055	MOSAIC PHOSPHATES CO. (S. PIERCE)	Auxiliary Boiler	1	IMCPIER1	-2,000	-8,700	35	10.67	4.8	1.46	430	494	51	15.54	77.26	2.223	CON	Yes	Yes
		Sulfuric Acid Plant No. 10	4	IMCPIER4	-2,000	-8,700	144	43.89	9	2.74	170	350	41.1	12.53	65.70	1.890	CON	Yes	Yes
		Sulfuric Acid Plant No. 11	5	IMCPIER5	-2,000	-8,700	144	43.89	9	2.74	170	350	41.1	12.53	65.70	1.890	CON	Yes	Yes
		GTSP Production Plant	23	IMCPIER23	-2,000	-8,700	140	42.67	9	2.74	110	316	36	10.97	135.90	3.909	CON	Yes	Yes
1050231	ORANGE COGENERATION LIMITED PARTNERSHIP	Combustion Turbine w/ HRSG, Unit 1 (Phase II Acid Rain Unit)	1	ORANG1	9,200	2,900	100	30.48	11	3.35	230	383	52.4	15.97	161.90	4.657	CON	Yes	Yes
		Combustion Turbine w/ HRSG, Unit 2 (Phase II Acid Rain Unit)	2	ORANG2	9,200	2,900	100	30.48	11	3.35	230	383	52.4	15.97	161.90	4.657	CON	Yes	Yes
		Auxiliary Boiler (Phase II Acid Rain Unit)	3	ORANG3	9,200	2,900	65	19.81	3.7	1.13	305	425	46	14.02	56.90	1.637	CON	Yes	Yes
1050047	AGRIFOS, L.L.C. (NICHOLS)	Phosphate Rock Dryer No. 1, Dry Cyclones, Venturi, Cycl. Sepa.	1	AGRNIC1	-10,800	5,200	80	24.38	7.5	2.29	160	344	41	12.50	156.80	4.511	CON	Yes	Yes
		Phosphate Rock Dryer No. 2, Dry Cyclones, Venturi, Cycl. Sepa.	2	AGRNIC2	-10,800	5,200	80	24.38	7.5	2.29	160	344	41	12.50	154.20	4.436	CON	Yes	Yes
1050223	PROGRESS ENERGY- TIGER BAY	Combustion Turbine and Heat Recovery System Generator	1	FPTIGR1	6,800	-10,800	180	54.86	19	5.79	205	369	63	19.20	709.10	20.399	CON	Yes	Yes
		Wastewater Treatment System Spray Dryer Unit w/Baghouse	2	FPTIGR2	6,800	-10,800	70	21.34	1.3	0.40	340	444	63	19.20	1.32	0.038	CON	Yes	Yes
		100 MMBtu/hr Package Steam Boiler	3	FPTIGR3	6,800	-10,800	40	12.19	4	1.22	320	433	38.7	11.80	30.00	0.863	CON	Yes	Yes
1050059	MOSAIC PHOSPHATES (NEW WALES)	Sulfuric Acid Plant No. 1	2	IMCWAL2	-12,800	-700	200	60.96	8.5	2.59	170	350	50	15.24	63.50	1.827	NO	Yes	No
		Sulfuric Acid Plant No. 2	3	IMCWAL3	-12,800	-700	200	60.96	8.5	2.59	170	350	50	15.24	63.50	1.827	NO	Yes	No
		Sulfuric Acid Plant No. 3	4	IMCWAL4	-12,800	-700	200	60.96	8.5	2.59	170	350	50	15.24	63.50	1.827	NO	Yes	No
		DAP Plant No. 1	9	IMCWAL9	-12,800	-700	133	40.54	7	2.13	105	314	49	14.94	43.90	1.263	NO	Yes	No
		Auxiliary Boiler	13	IMCWAL13	-12,800	-700	85	25.91	3	0.91	555	564	193.3	58.92	120.80	3.475	NO	Yes	No
		AFI Plant	27	IMCWAL27	-12,800	-700	172	52.43	8	2.44	130	328	66.3	20.21	182.84	5.260	CON	Yes	Yes
		Multifos "A" Kiln Cooler	32	IMCWAL32	-12,800	-700	86	26.21	1.5	0.46	220	378	258	78.64	88.75	2.553	CON	Yes	Yes
		Multifos "B" Kiln Cooler	33	IMCWAL33	-12,800	-700	86	26.21	1.5	0.46	274	408	225	68.58	88.75	2.553	CON	Yes	Yes
		Multifos A and B Kilns, Dryer and Blending Operation	36	IMCWAL36	-12,800	-700	172	52.43	4.5	1.37	105	314	52	15.85	19.81	0.570	CON	Yes	Yes
		Sulfuric Acid Plant No. 4	42	IMCWAL42	-12,800	-700	199	60.66	8.5	2.59	170	350	50	15.24	63.50	1.827	NO	Yes	No
		Sulfuric Acid Plant No. 5	44	IMCWAL44	-12,800	-700	199	60.66	8.5	2.59	170	350	50	15.24	63.50	1.827	NO	Yes	No
		DAP Plant No 2 - East Train	45	IMCWAL45	-12,800	-700	171	52.12	6	1.83	110	316	58	17.68	55.20	1.588	NO	Yes	No
		DAP Plant No 2 - West Train	46	IMCWAL46	-12,800	-700	171	52.12	6	1.83	110	316	58	17.68	55.20	1.588	NO	Yes	No



Table B-2 Summary of NO<sub>x</sub> Sources Included in the Air Modeling Analyses. Mosiac Green Bay

FAC. ID	FAC. Name	Emission Unit Description	EU ID	ISCST3 ID Name	Relative Location		Stack Parameters						Emission Rate		PSD Consuming PSD Source? (EXP/CON)	Modeled in			
					East (m)	North (m)	Height		Diameter		Temperature		ft/s	m/s		TPY	g/s	AAQS	Class II
					ft	m	ft	m	°F	K	ft/s	m/s	TPY	g/s		TPY	g/s	AAQS	Class II
		Multifos C Kiln	74	IMCWAL74	-12,800	-700	172	52.43	4.5	1.37	105	314	70.2	21.40	35.04	1,008	CON	Yes	Yes
		GRANULAR MAP PLANT	78	IMCWAL78	-12,800	-700	133	40.54	6	1.83	145	336	109.6	33.41	39.80	1,145	NO	Yes	No
1050051	U.S. AGRI-CHEMICALS - FT. MEADE	AUXILIARY BOILER	6	AFMEAD6	6,500	-11,100	70	21.34	3.7	1.13	400	478	49	14.94	131.40	3,780	CON	Yes	Yes
		SULFURIC ACID PLANT #1	16	AFMEAD16	6,500	-11,100	175	53.34	8.5	2.59	180	355	32	9.75	73.60	2,117	CON	Yes	Yes
		SULFURIC ACID PLANT #2	17	AFMEAD17	6,500	-11,100	175	53.34	8.5	2.59	180	355	32	9.75	73.60	2,117	CON	Yes	Yes
		Granular MAP/DAP Plant	35	AFMEAD38	6,500	-11,100	135	41.15	6.7	2.04	149	338	52	15.85	18.40	0,529	CON	Yes	Yes
1050233	TECO - POLK POWER STATION	260 MW Combined cycle CT (Phase II Acid Rain Unit)	1	TECOPK1	-7,050	-12,750	150	45.72	19	5.79	340	444	75.8	23.10	2,908.30	83,663	CON	Yes	Yes
		120 MMBtu/HR Auxiliary Boiler	3	TECOPK3	-7,050	-12,750	75	22.86	3.7	1.13	375	464	50.0	15.23	18.00	0,518	CON	Yes	Yes
		Sulfuric Acid Plant	4	TECOPK4	-7,050	-12,750	2.5	0.76	2.5	0.76	180	355	60	18.29	4.66	0,134	CON	Yes	Yes
		165MW Simple Cycle Combustion Turbine	9	TECOPK9	-7,050	-12,750	114	34.75	29	8.84	1117	876	60.2	18.35	129.21	3,717	CON	Yes	Yes
		165MW Simple Cycle Combustion Turbine	10	TECOPK10	-7,050	-12,750	114	34.75	29	8.84	1117	876	60.2	18.35	129.21	3,717	CON	Yes	Yes
1050100	SHELL EPOXY RESINS (RESOLUTION PRODUCTS)	Cyclothem boiler	1	EPOXY1	1,200	18,800	25	7.62	2	0.61	350	450	13.1	3.99	123.47	3,552	NO	Yes	No
		ECLIPSE LIQUID PHASE HEATER #2 5.3 MMBTU/HR GAS/OIL	2	EPOXY2	1,200	18,800	30	9.14	2	0.61	350	450	13.1	3.99	123.47	3,552	NO	Yes	No
		CJS ENERGY RESOURCES INCIN. SYSTEM	5	EPOXY5	1,200	18,800	35	10.67	1.1	0.33	900	755	25	7.62	0.94	0,027	NO	Yes	No
		ECLIPSE LIQUID PHASE HEATER #3	6	EPOXY6	1,200	18,800	35	10.67	1.5	0.46	350	450	13	3.96	123.47	3,552	NO	Yes	No
		Cleaver-brooks boiler 9.45 mmbtu/hr. gas/oil	7	EPOXY7	1,200	18,800	35	10.67	1.5	0.46	350	450	16	4.88	123.47	3,552	NO	Yes	No
		OIL HEATER NO. 4 NATURAL GAS OR OIL MAX 10.58 MMBTU/HR	8	EPOXY8	1,200	18,800	21	6.40	2	0.61	800	700	27	8.23	123.00	3,538	NO	Yes	No
1050003	LAKELAND ELECTRIC - LARSON	Fossil Fuel Fired Steam Generator # 6	3	LARS3	-600	22,400	165	50.29	10	3.05	340	444	21	6.40	674.00	19,389	NO	Yes	No
		Steam Generator # 7 (Phase II Acid Rain unit)	4	LARS4	-600	22,400	165	50.29	10	3.05	340	444	22	6.71	1,448.00	41,655	NO	Yes	No
		Peaking Gas Turbine # 3	5	LARS5	-600	22,400	31	9.45	11.8	3.60	800	700	101	30.78	639.00	18,382	NO	Yes	No
		Peaking Gas Turbine # 2	6	LARS6	-600	22,400	31	9.45	11.8	3.60	800	700	101	30.78	639.00	18,382	NO	Yes	No
		Peaking Gas Turbine # 1	7	LARS1	-600	22,400	31	9.449	11.8	3.597	800	699.8	101	30.785	-639.00	-18,382	EXP	No	Yes
		Combined Cycle Combustion Turbine (Phase II Acid Rain unit)	8	LARS8	-600	22,400	155	47.24	16	4.88	481	523	85.7	26.12	425.00	12,226	CON	Yes	Yes
0490015	HARDEE POWER PARTNERS,LTD	Combustion Turbine 1A with HRSG	1	HARD1	-4,700	-22,700	90	27.43	14.5	4.42	236	386	77.5	23.62	1,681.00	48,358	CON	Yes	Yes
		Combustion Turbine 1B with HRSG	2	HARD2	-4,700	-22,700	90	27.43	14.5	4.42	245	391	75.8	23.10	1,681.00	48,358	CON	Yes	Yes
		Simple cycle Combustion Turbine 2A	3	HARD3	-4,700	-22,700	75	22.86	17.9	5.46	986	803	94.3	28.74	1,681.00	48,358	CON	Yes	Yes
		Unit 2B - 75 MW gas turbine	5	HARD5	-4,700	-22,700	85	25.91	14.8	4.51	999	810	142.0	43.28	140.16	4,032	CON	Yes	Yes
1050221	AUBURNDALE POWER PARTNERS, LP	Combustion Turbine System(Phase II. Acid Rain Unit)	1	CALEXT1	11,300	23,200	160	48.77	16.0	5.49	203	368	55.0	16.76	573.80	16,507	CON	Yes	Yes
1050004	LAKELAND ELECTRIC - MCINTOSH	McIntosh Unit 1- FFFSG (Phase II Acid Rain Unit)	1	MCINT1	-500	26,100	150	45.72	9.0	2.74	277	409	61.2	24.75	862.00	24,797	NO	Yes	No
		Diesel Engine Peaking Unit 2	2	MCINT2	-500	26,100	20	6.10	2.6	0.79	715	653	77.0	23.47	17.52	0,504	NO	Yes	No
		Diesel Engine Peaking Unit 3	3	MCINT3	-500	26,100	20	6.10	2.6	0.79	715	653	77.0	23.47	17.52	0,504	NO	Yes	No
		Gas Turbine Peaking Unit 1	4	MCINT4	-500	26,100	35	10.67	13.5	4.11	900	755	79.5	24.23	396.78	11,414	NO	Yes	No
		McIntosh Unit 2 FFFSG (Phase II Acid Rain Unit)	5	MCINT5	-500	26,100	157	47.85	10.5	3.20	277	409	73.2	22.31	1,556.00	44,762	CON	Yes	Yes
		McIntosh Unit 3 FFFSG (Phase II Acid Rain Unit)	6	MCINT6	-500	26,100	250	76.20	18.0	5.49	167	348	82.6	25.18	11,160.00	321,041	CON	Yes	Yes
		250 MW Combustion Turbine UNIT 5	28	MCINT28	-500	26,100	85	25.91	28.0	8.53	1095	864	82.7	25.21	321.00	9,234	CON	Yes	Yes
1050002	CITRUS WORLD, INC.	CITRUS PEEL DRYER WITH WASTE-HEAT EVAPORATOR #2	1	CITRUS1	31,500	7,200	75	22.86	4.7	1.43	195	364	49.0	14.94	245.85	7,072	NO	Yes	No
		ERIE CITY KEYSTONE BOILER #3 USING NAT GAS AND #6 OIL	3	CITRUS3	31,500	7,200	40	12.19	3.7	1.11	450	505	59.9	18.26	71.13	2,046	NO	Yes	No
		ERIE CITY KEYSTONE BOILER #2 USING NAT GAS AND #6 OIL	4	CITRUS4	31,500	7,200	40	12.19	3.7	1.11	450	505	60.5	18.44	132.14	3,801	NO	Yes	No
		CITRUS PEEL DRYER WITH WASTE-HEAT EVAPORATOR #1	7	CITRUS7	31,500	7,200	75	22.86	3.2	0.97	150	339	49.7	15.15	126.14	3,629	NO	Yes	No
		WASTE HEAT BOILER 91.36 MMBTU/HR NATURAL GAS FIRED	11	CITRUS11	31,500	7,200	40	12.19	3.9	1.20	320	433	66.3	20.21	56.07	1,613	NO	Yes	No
		NATURAL GAS TURBINE @ 51.1 MMBTU/HR (APPROX. 66 DEG. F)	12	CITRUS12	31,500	7,200	40	12.19	4.0	1.21	320	433	64.7	19.72	96.40	2,773	NO	Yes	No
		CITRUS PEEL DRYER WITH WASTE-HEAT EVAPORATOR #3	13	CITRUS13	31,500	7,200	75	22.86	4.6	1.40	150	339	33.1	10.09	253.69	7,298	NO	Yes	No

Table B-2. Summary of NO<sub>x</sub> Sources Included in the Air Modeling Analyses. Mosiac Green Bay

FAC. ID	FAC. Name	Emission Unit Description	EU ID	ISCST3 ID Name	Relative Location		Stack Parameters						Emission Rate		PSD Consuming PSD Source? (EXP/CON)	Modeled in			
					East (m)	North (m)	Height		Diameter		Temperature		Velocity			TPY	g/s	AAQS	Class II
					ft	m	ft	m	°F	K	ft/s	m/s	TPY	g/s		Yes	No		
		ERIE CITY KEYSTONE BOILER #1 USING NAT GAS AND #6 OIL	17	CITRUS17	31,500	7,200	40	12.19	3.7	1.12	450	505	25.3	7.71	66.09	1,901	NO	Yes	No
		GAS TURBINE NO. 2 WWH BOILER	27	CITRUS27	31,500	7,200	50	15.24	4.5	1.37	319	433	70.7	21.55	39.40	1,133	NO	Yes	No
0490043	VANDOLAH POWER COMPANY, LLC																		
		A 170 MW Gas Simple Cycle Combustion Turbine	1	VANDP1	-750	-35,600	60	18.29	22.0	6.71	1113	874	116.0	35.36	252.00	7,249	CON	Yes	Yes
		A 170 MW Gas Simple Cycle Combustion Turbine	2	VANDP2	-750	-35,600	60	18.29	22.0	6.71	1113	874	116.0	35.36	252.00	7,249	CON	Yes	Yes
		A 170 MW Gas Simple Cycle Combustion Turbine	3	VANDP3	-750	-35,600	60	18.29	22.0	6.71	1113	874	116.0	35.36	252.00	7,249	CON	Yes	Yes
		A 170 MW Gas Simple Cycle Combustion Turbine	4	VANDP4	-750	-35,600	60	18.29	22.0	6.71	1113	874	116.0	35.36	252.00	7,249	CON	Yes	Yes
0570261	HILLSBOROUGH CO R.R.F.																		
		Municipal Waste Combustor & Auxiliary burners-Unit #1	1	HILLSRC1	-41,300	12,600	220	67.06	5.1	1.55	290	416	72.5	22.10	513.91	14,784	NO	Yes	No
		Municipal Waste Combustor & Auxiliary burners-Unit #2	2	HILLSRC2	-41,300	12,600	220	67.06	5.1	1.55	290	416	72.5	22.10	513.91	14,784	NO	Yes	No
		Municipal Waste Combustor & Auxiliary burners-Unit #3	3	HILLSRC3	-41,300	12,600	220	67.06	5.1	1.55	290	416	72.5	22.10	513.91	14,784	NO	Yes	No
0570039	TECO - BIG BEND																		
		Fossil Fuel Fired Steam Generator1 (Phase II Acid Rain Unit)	1	TECOBB1	-47,600	-5,100	490	149.35	24	7.32	294	419	115.9	35.33	27,029.0	777,547	NO	Yes	No
		Fossil Fuel Fired Steam Generator2 (Phase II Acid Rain Unit)	2	TECOBB2	-47,600	-5,100	490	149.35	24	7.32	125	325	87.6	26.70	27,118.0	780,107	NO	Yes	No
		Fossil Fuel Fired Steam Generator3 (Phase II Acid Rain Unit)	3	TECOBB3	-47,600	-5,100	499	152.10	24	7.32	279	410	47	14.33	12,619.0	363,012	NO	Yes	No
		UNIT #4 COAL-FIRED BOILER W/ BELCO ESP PSD-FL-040	4	TECOBB4	-47,600	-5,100	499	152.10	24	7.32	156	342	59	17.98	11,379.0	327,341	CON	Yes	Yes
		Gas Turbine No. 2: oil fired, 78 MW, w/evap. cooling	5	TECOBB5	-47,600	-5,100	75	22.86	14	4.27	928	771	61	18.59	1,958.0	56,326	NO	Yes	No
		Gas Turbine No. 3: oil fired, 78 MW, w/evap. cooling	6	TECOBB6	-47,600	-5,100	75	22.86	14	4.27	928	771	61	18.59	1,958.0	56,326	NO	Yes	No
		GAS TURBINE #1 FIRED BY #2 FUEL OIL	7	TECOBB7	-47,600	-5,100	35	10.67	11.04	3.36	1010	816	91.9	28.01	561.0	16,138	NO	Yes	No
0810010	FP & L - MANATEE PLANT																		
		Fossil Fuel Steam Generator, Unit 1-Phase II Acid Rain Unit	1	FPLMAN1	-42,250	-25,950	499	152.10	26.2	7.99	325	436	82.5	25.15	11,366.10	326,970	NO	Yes	No
		Fossil Fuel Steam Generator, Unit 2-Phase II Acid Rain Unit	2	FPLMAN2	-42,250	-25,950	499	152.10	26.2	7.99	325	436	82.5	25.15	11,366.10	326,970	NO	Yes	No
0570040	BAYSIDE POWER STATION (TECO - GANNON)																		
		UNIT #1 STEAM GENERATOR	1	TECOGN1	-49,400	7,400	315	96.01	10	3.05	289	416	94	28.65	8,055.00	231,719	NO	Yes	No
		125MW BABCOCK&WILCOX CORP WET BOTTOM CYCLONIC FIRING T	2	TECOGN2	-49,400	7,400	315	96.01	10	3.05	298	421	101	30.78	8,314.00	239,170	NO	Yes	No
		UNIT #3 - B&W WET BOTTOM COAL FIRED BOILER	3	TECOGN3	-49,400	7,400	315	96.01	10.6	3.23	296	420	126	38.40	10,518.00	302,573	NO	Yes	No
		UNIT#4- B&W WET BOT CYCLONIC FIR'G COAL FIR BOLR, EAST STACI	4	TECOGN4	-49,400	7,400	315	96.01	10	3.05	309	427	75	22.86	11,555.00	332,404	NO	Yes	No
		UNIT #5 COAL FIRED BOILER	5	TECOGN5	-49,400	7,400	315	96.01	14.6	4.45	303	424	76	23.16	15,128.00	435,189	NO	Yes	No
		UNIT #6 - COAL FIRED BOILER WITH ESP	6	TECOGN6	-49,400	7,400	315	96.01	17.6	5.36	320	433	81	24.69	24,957.00	717,941	NO	Yes	No
		14 MW GAS FIRED TURBINE	7	TECOGN7	-49,400	7,400	35	10.67	11	3.35	1010	816	92.6	28.22	561.00	16,138	NO	Yes	No
0570038	TECO - HOOKERS POINT																		
		Boiler #1 298 MMBtu/hr (Phase II Acid Rain Unit)	1	TECOHK1	-51,500	10,900	280	85.34	11.3	3.44	356	453	82	24.99	530.0	15,247	NO	Yes	No
		Boiler #2 298 MMBtu/hr (Phase II Acid Rain Unit)	2	TECOHK2	-51,500	10,900	280	85.34	11.3	3.44	356	453	82	24.99	530.0	15,247	NO	Yes	No
		Boiler #3 411 MMBtu/hr (Phase II Acid Rain Unit)	3	TECOHK3	-51,500	10,900	280	85.34	12	3.66	341	445	62.7	19.11	731.0	21,029	NO	Yes	No
		Boiler #4 411 MMBtu/hr (Phase II Acid Rain Unit)	4	TECOHK4	-51,500	10,900	280	85.34	12	3.66	341	445	62.7	19.11	731.0	21,029	NO	Yes	No
		Boiler #5 610 MMBtu/hr (Phase II Acid Rain Unit)	5	TECOHK5	-51,500	10,900	280	85.34	11.3	3.44	356	453	82	24.99	1,064.0	30,608	NO	Yes	No
		Boiler #6 778 MMBtu/hr (Phase II Acid Rain Unit)	6	TECOHK6	-51,500	10,900	280	85.34	9.4	2.87	329	438	75.2	22.92	972.0	27,962	NO	Yes	No
0970014	PROGRESS ENERGY- INTERCESSION CITY																		
		Combustion Turbine (CT) Peaking Unit 1	1	INTCP1	36,800	45,900	20	6.10	14.63	4.46	760	678	174.9	53.31	2,164.00	62,252	NO	Yes	No
		Combustion Turbine (CT) Peaking Unit 2	2	INTCP2	36,800	45,900	20	6.10	14.63	4.46	760	678	174.9	53.31	2,164.00	62,252	NO	Yes	No
		Combustion Turbine (CT) Peaking Unit 3	3	INTCP3	36,800	45,900	20	6.10	14.63	4.46	760	678	174.9	53.31	2,164.00	62,252	NO	Yes	No
		Combustion Turbine (CT) Peaking Unit 4	4	INTCP4	36,800	45,900	20	6.10	14.63	4.46	760	678	174.9	53.31	2,164.00	62,252	NO	Yes	No
		Combustion Turbine (CT) Peaking Unit 5	5	INTCP5	36,800	45,900	20	6.10	14.63	4.46	760	678	174.9	53.31	2,164.00	62,252	NO	Yes	No
		Combustion Turbine (CT) Peaking Unit 6	6	INTCP6	36,800	45,900	20	6.10	14.63	4.46	760	678	174.9	53.31	2,164.00	62,252	NO	Yes	No
		Combustion Turbine # 7	7	INTCT7	36,800	45,900	50	15.24	13.75	4.19	1043	835	174.1	53.07	308.49	8,874	CON	Yes	Yes
		Combustion Turbine # 8	8	INTCT8	36,800	45,900	50	15.24	13.75	4.19	1043	835	174.1	53.07	308.49	8,874	CON	Yes	Yes
		Combustion Turbine # 9	9	INTCT9	36,800	45,900	50	15.24	13.75	4.19	1043	835	174.1	53.07	308.49	8,874	CON	Yes	Yes

Table B-2 Summary of NO<sub>x</sub> Sources Included in the Air Modeling Analyses, Mosiac Green Bay

FAC. ID	FAC. Name	Emission Unit Description	EU ID	ISCST3 ID Name	Relative Location		Stack Parameters						Emission Rate		PSD Consuming PSD Source? (EXP/CON)				
					East (m)	North (m)	Height		Diameter		Temperature		Velocity		TPY	g/s	AAQS	Class II	
							ft	m	ft	m	°F	K	ft/s	m/s					
		Combustion Turbine # 10	10	INTCT10	36,800	45,900	50	15.24	13.75	4.19	1043	835	174.1	53.07	308.49	8.874	CON	Yes	Yes
		Combustion Turbine # 11	11	INTCT11	36,800	45,900	75	22.86	19	5.79	1034	830	139.4	42.49	566.13	16.286	CON	Yes	Yes
		P-12: Simple cycle combustion turbine 87 MW, GE Frame 7EA	18	INTSCI2	36,800	45,900	56	17.07	16.1	4.91	933	774	117.6	35.84	83.50	2.402	CON	Yes	Yes
		P-13: Simple cycle combustion turbine 87 MW, GE Frame 7EA	19	INTSCI3	36,800	45,900	56	17.07	16.1	4.91	993	807	117.6	35.84	83.50	2.402	CON	Yes	Yes
		P-14: Simple cycle combustion turbine 87 MW, GE Frame 7EA	20	INTSCI4	36,800	45,900	56	17.07	16.1	4.91	993	807	117.6	35.84	83.50	2.402	CON	Yes	Yes
1030011	PROGRESS ENERGY- BARTOW PLANT																		
		No.1 Unit, FFSG (Phase II Acid Rain Unit)	1	FPCBAR1	-67,100	2,500	300	91.44	9	2.74	312	429	119	36.27	2,305.00	66,308	NO	Yes	No
		No.2 Unit, FFSG (Phase II Acid Rain Unit)	2	FPCBAR2	-67,100	2,500	300	91.44	9	2.74	305	425	102	31.09	1,615.00	46,459	NO	Yes	No
		No.3 Unit, FFSG (Phase II Acid Rain Unit)	3	FPCBAR3	-67,100	2,500	300	91.44	11	3.35	275	408	113	34.44	2,712.00	78,016	NO	Yes	No
		Barow-Anclote Pipeline Heating Boiler	4	FPCBAR4	-67,100	2,500	30	9.14	3	0.91	515	541	17	5.18	9.64	0.277	NO	Yes	No
		Gas Turbine Peaking Unit #P-1	5	FPCBAR5	-67,100	2,500	45	13.72	17.9	5.46	930	772	69.1	21.06	2,183.00	62,799	NO	Yes	No
		Gas Turbine Peaking Unit #P-2	6	FPCBAR6	-67,100	2,500	45	13.72	17.9	5.46	930	772	69.1	21.06	2,183.00	62,799	NO	Yes	No
		Gas Turbine Peaking Unit #P-3	7	FPCBAR7	-67,100	2,500	45	13.72	17.9	5.46	930	772	69.1	21.06	2,183.00	62,799	NO	Yes	No
		Gas Turbine Peaking Unit #P-4	8	FPCBAR8	-67,100	2,500	45	13.72	17.9	5.46	930	772	69.1	21.06	2,183.00	62,799	NO	Yes	No
0270016	IPS AVON PARK CORPORATION (DESOTO COUNTY)																		
		170 MW Dual Fuel Combustion Turbine Electrical Generator	1	AVONP1	10,250	-68,600	75	22.86	22	6.71	1113	874	116.0	35.36	252.00	7,249	CON	Yes	Yes
		170 MW Dual Fuel Combustion Turbine Electrical Generator	2	AVONP2	10,250	-68,600	75	22.86	22	6.71	1113	874	116.0	35.36	252.00	7,249	CON	Yes	Yes
		GE Frame 7A Simple Cycle GT	3	AVONP3	10,250	-68,600	75	22.86	22	6.71	1113	874	116.0	35.36	252.00	7,249	CON	Yes	Yes
1030013	PROGRESS ENERGY- BAYBORO PLANT																		
		Combustion Turbine Peaking Unit # 1	1	FPCBAY1	-70,700	-8,800	40	12.19	22.9	6.98	900	755	21	6.40	965.65	28,360	NO	Yes	No
		Combustion Turbine Peaking Unit # 2	2	FPCBAY2	-70,700	-8,800	40	12.19	22.9	6.98	900	755	21	6.40	1,013.79	29,164	NO	Yes	No
		Combustion Turbine Peaking Unit # 3	3	FPCBAY3	-70,700	-8,800	40	12.19	22.9	6.98	900	755	21	6.40	935.39	26,909	NO	Yes	No
		Combustion Turbine Peaking Unit # 4	4	FPCBAY4	-70,700	-8,800	40	12.19	22.9	6.98	900	755	21	6.40	902.76	25,970	NO	Yes	No
0510007	TROPICANA PRODUCTS, INC -BRADENTON																		
		CITRUS PEEL DRYER #1 W/WHE	1	TROP1	-62,700	-39,200	95	28.96	3.2	0.98	100	311	35.2	10.73	36.07	1,038	NO	Yes	No
		CITRUS PEEL DRYER #2 W/WHE	2	TROP2	-62,700	-39,200	95	28.96	3	0.91	140	333	70	21.34	36.07	1,038	NO	Yes	No
		CITRUS PEEL DRYER #3 W/WHE	3	TROP3	-62,700	-39,200	95	28.96	3.2	0.98	140	333	62	18.90	36.07	1,038	NO	Yes	No
		GLASS PLANT #2 FIRED WITH NATURAL GAS OR BIO-GAS	12	TROP12	-62,700	-39,200	71	21.64	6.2	1.89	425	491	43.3	13.20	423.60	12,186	NO	Yes	No
		GLASS PLANT FURNACE #3, BURNS NATURAL GAS OR BIO-GAS.	14	TROP14	-62,700	-39,200	103	31.39	6.2	1.89	510	539	57.1	17.40	391.00	11,248	NO	Yes	No
		157.4 MMBTU/HR AUXILIARY BOILER FOR COGEN PLANT	15	TROP15	-62,700	-39,200	75	22.86	5	1.52	540	555	48.6	14.81	60.20	2,307	CON	Yes	Yes
		GAS TURBINE W/HEAT RECOVERY - FOR COGENERATION PLANT	16	TROP16	-62,700	-39,200	67	20.42	12	3.66	268	404	54	16.46	314.50	9,047	CON	Yes	Yes
		STEAM BOILER (10 MMBTU/HR) NAT GAS OR BIO GAS FIRED	21	TROP21	-62,700	-39,200	40	12.19	1.7	0.52	300	422	16	4.88	42.77	1,230	CON	Yes	Yes
		400 HP Boiler - 17.0 MMBTU/hr., NSPS Dc. Natural Gas	23	TROP23	-62,700	-39,200	30	9.14	2	0.61	300	422	20.2	6.16	11.00	0.316	CON	Yes	Yes
1030012	PROGRESS ENERGY- HIGGINS PLANT																		
		FFSG-SG 1 (Phase II, Acid Rain Unit)	1	FPCHIG1	-73,000	18,300	174	53.04	12.5	3.81	312	429	27.0	8.23	1,680.00	48,329	NO	Yes	No
		FFSG-SG 2 (Phase II, Acid Rain Unit)	2	FPCHIG2	-73,000	18,300	174	53.04	12.5	3.81	310	428	27.0	8.23	1,603.20	46,119	NO	Yes	No
		FFSG-SG 3 (Phase II, Acid Rain Unit)	3	FPCHIG3	-73,000	18,300	174	53.04	12.5	3.81	301	423	24.0	7.32	1,680.00	48,329	NO	Yes	No
		Combustion Turbine Peaking Unit-CTP 1	4	FPCHIG4	-73,000	18,300	55	16.76	15.1	4.60	850	728	93.1	28.38	1,197.36	34,445	NO	Yes	No
		Combustion Turbine Peaking Unit-CTP 2	5	FPCHIG5	-73,000	18,300	56	17.07	15.1	4.60	850	728	93.1	28.38	1,197.36	34,445	NO	Yes	No
		Combustion Turbine Peaking Unit-CTP 3	6	FPCHIG6	-73,000	18,300	55	16.76	15.1	4.60	850	728	93.1	28.38	1,334.56	38,391	NO	Yes	No
		Combustion Turbine Peaking Unit-CTP 4	7	FPCHIG7	-73,000	18,300	55	16.76	15.1	4.60	850	728	93.1	28.38	1,334.56	38,391	NO	Yes	No
1010056	PASCO COUNTY RESOURCE RECOVERY																		
		Municipal Waste Combustion Unit No. 1	1	PASCO1	-60,690	58,670	275	83.82	10.0	3.05	250	394	51.0	15.54	394.20	11,340	CON	Yes	Yes

Table B-2 Summary of NO<sub>x</sub> Sources Included in the Air Modeling Analyses, Mosiac Green Bay

FAC. ID	FAC. Name	Emission Unit Description	EUI ID	ISCST3 ID Name	Relative Location		Stack Parameters						Emission Rate		PSD Consuming PSD Source? (EXP/CON)	Modeled in			
					East (m)	North (m)	Height		Diameter		Temperature		Velocity			TPY	g/s	AAQS	Class II
							ft	m	ft	m	°F	K	ft/s	m/s					
		Municipal Waste Combustion Unit No. 2	2	PASCO2	-60,690	58,670	275	83.82	10.0	3.05	250	394	51.0	15.54	394.20	11,340	CON	Yes	Yes
		Municipal Waste Combustion Unit No. 3	3	PASCO3	-60,690	58,670	275	83.82	10.0	3.05	250	394	51.0	15.54	394.20	11,340	CON	Yes	Yes
		Leachate Treatment Facility	5	PASCO5	-60,690	58,670	50	15.24	1.3	0.40	330	439	37.0	11.28	1.32	0.038	CON	Yes	Yes
1010017	PROGRESS ENERGY- ANCLOTE POWER PLANT	Steam Turbine Generator Units 1 and 2--Common Stack	1,2	PFCANC12	-85,100	38,600	499	152.10	24.0	7.32	320	433	62.0	18.90	13,292.00	382.373	NO	Yes	No
0530021	FLORIDA CRUSHED STONE CO., INC.	POWER PLANT	18	FCRUSH18	-49,500	82,400	320	97.54	16.0	4.88	300	422	69.6	21.21	3,705.48	106.596	CON	Yes	Yes
		BCP: Kilo, Clinker Cooler, Raw Mill, & Dryer with Baghouse	20	FCRUSH20	-49,500	82,400	300	91.44	16.0	4.88	220	378	47.0	14.33	1,572.00	45.222	CON	Yes	Yes
		KILN #2 SYSTEM: preheater/precalciner, cooler, dryer, raw mill	26	FCRUSH26	-49,500	82,400	320	97.54	14.0	4.27	258	399	33.8	10.30	1,280.00	36.822	CON	Yes	Yes
0530032	CENTRAL POWER & LIME, INC.	CEMENT KILN, CLINKER COOLER, RAW MILL & DRYER	9	CENTPLP	-49,500	82,400	300	91.44	16.0	4.88	226	381	47.0	14.33	4,863.00	139.895	CON	Yes	Yes
		POWER PLANT	14	CENTPL14	-49,500	82,400	320	97.54	16.0	4.88	250	394	69.6	21.21	8,983.38	258.426	CON	Yes	Yes

Note: EXP = PSD expanding source.

CON = PSD consuming source.

NO = Baseline Source, does not affect PSD increment.

ND = No data available.

<sup>b</sup> Velocity of 1 ft/s assumed

<sup>c</sup> Information from Table 6-6, CCA - Frostproof PSD application, Golder Associates.

<sup>d</sup> PSD status from Tables D-1 & E-1, Cargill Riverview report, Golder Associates.

<sup>e</sup> Progress Energy Crystal River Units 3 and 4 are at GEP stack height.

**APPENDIX C**

**CALPUFF MODEL DESCRIPTION  
AND METHODOLOGY**

## CALPUFF MODEL DESCRIPTION AND METHODOLOGY

### C.1 INTRODUCTION

As part of the new source review requirements under Prevention of Significant Deterioration (PSD) regulations, new sources are required to address air quality impacts at PSD Class I areas. As part of the PSD analysis report submitted to the Florida Department of Environmental Protection (DEP), the air quality impacts due to the potential emissions of the proposed Mosaic Green Bay modification are required to be addressed at the PSD Class I area of the Chassahowitzka National Wildlife Area (NWA). The Chassahowitzka NWA is located approximately 110 km northwest of the facility site and is the only PSD Class I area located within 200 km of the project site.

The evaluation of air quality impacts are not only concerned with determining compliance with PSD Class I increments but also assessing a source's impact on Air Quality Related Values (AQRVs), such as regional haze. Further, compliance with PSD Class I increments can be evaluated by determining if the source's impacts are less than the proposed U.S. Environmental Protection Agency (EPA) Class I significant impact levels. The significant impact levels are threshold levels that are used to determine the type of air impact analyses needed for the facility. If the new source's impacts are predicted to be less than significant, then the source's impacts are assumed not to have a significant adverse affect on air quality and additional modeling with other sources is not required. However, if the source's impacts are predicted to be greater than the significant impact levels, additional modeling with other sources is required to demonstrate compliance with Class I increments.

Currently there are several air quality modeling approaches recommended by the Interagency Workgroup on Air Quality Models (IWAQM) to perform these analyses. The IWAQM consists of EPA and Federal Land Managers (FLM) of Class I areas who are responsible for ensuring that AQRVs are not adversely impacted by new and existing sources. These recommendations have been summarized in two documents:

- *Interagency Workgroup on Air Quality Models (IWAQM), Phase 2 Summary Report and Recommendations for Modeling Long Range Transport Impacts* (EPA, 1998), referred to as the IWAQM Phase 2 report.
- *Federal Land Managers' Air Quality Related Values Workgroup (FLAG), Phase I Report*, USFS, NPS, USFWS (12/00), referred to as the FLAG document.

For the proposed project, air quality analyses were performed that assess the facility's impacts in the PSD Class I area of the Chassahowitzka NWA using the refined modeling approach from the IWAQM Phase 2 report for:

- Significant impact analysis,
- Regional haze analysis, and
- Total nitrogen deposition.

The refined analysis approach was used instead of the screening analysis approach since the air quality impacts are based on generally more realistic assumptions, including more detailed meteorological data, and are estimated at locations at the Class I area.

## **C.2 GENERAL AIR MODELING APPROACH**

The general modeling approach was based on using the long-range transport model, California Puff model (CALPUFF; Version 5.711a). At distances beyond 50 km, the ISCST3 model is considered to overpredict air quality impacts, because it is a steady-state model. At those distances, the CALPUFF model is recommended for use. The FLM have requested that air quality impacts, such as for regional haze, for a source located more than 50 km from a Class I area be predicted using the CALPUFF model. The Florida DEP has also recommended that the CALPUFF model be used to assess if the source has a significant impact at a Class I area located beyond 50 km from the source. As a result, a significant impact and regional haze analyses were performed using the CALPUFF model to assess the facility's impacts at the Chassahowitzka NWA.

The methods and assumptions used in the CALPUFF model were based on the latest recommendations for a refined analysis as presented in the IWAQM Phase 2 Summary Report and the FLAG documents.

A regional haze analysis was performed to determine the affect that the facility's emissions will have on background regional haze levels at the Chassahowitzka NWA. In the regional haze analysis, the change in visual range, as calculated by a deciview change, was estimated for the facility in accordance with the IWAQM recommendations. Based on those recommendations, the CALPUFF model is used to predict the maximum 24-hour average sulfate ( $\text{SO}_4$ ), nitrate ( $\text{NO}_3$ ), and fine particulate ( $\text{PM}_{10}$ ) concentrations as well as ammonium sulfate  $[(\text{NH}_4)_2\text{SO}_4]$  and ammonium nitrate ( $\text{NH}_4\text{NO}_3$ ) concentrations. The change in visibility due to a source, estimated as a percentage, is then calculated based on the change from background data.

The following sections present the methods and assumptions used to assess the refined significant impact and regional haze analyses performed for the proposed project. The results of these analyses are presented in Sections 6.0 and 7.0 of the report.

### **C.3 MODEL SELECTION AND SETTINGS**

The CALPUFF air modeling system was used to assess the proposed project's impacts at the PSD Class I area for comparison to the PSD Class I significant impact levels and to the regional haze visibility criteria. CALPUFF is a non-steady state Lagrangian Gaussian puff long-range transport model that includes algorithms for building downwash effects as well as chemical transformations (important for visibility controlling pollutants), and wet/dry deposition. The CALPUFF meteorological and geophysical data preprocessor (CALMET, Version 5.53a), a preprocessor to CALPUFF, is a diagnostic meteorological model that produces a three-dimensional field of wind and temperature and a two-dimensional field of other meteorological parameters. CALMET was designed to process raw meteorological, terrain and land-use databases to be used in the air modeling analysis. The CALPUFF modeling system uses a number of FORTRAN preprocessor programs that extract data from large databases and converts the data into formats suitable for input to CALMET. The processed data produced from CALMET was input to CALPUFF to assess the pollutant specific impact. Both CALMET and CALPUFF were used in a manner that is recommended by the IWAQM Phase 2 and FLAG reports.

#### **C.3.1 CALPUFF MODEL APPROACHES AND SETTINGS**

The IWAQM has recommended approaches for performing a Phase 2 refined modeling analyses that are presented in Table C-1. These approaches involve use of meteorological data, selection of receptors and dispersion conditions, and processing of model output.

The specific settings used in the CALPUFF model are presented in Table C-2.

#### **C.3.2 EMISSION INVENTORY AND BUILDING WAKE EFFECTS**

The CALPUFF model included the facility's emissions, stack, and operating data as well as building dimensions to account for the effects of building-induced downwash on the emission sources. Dimensions for all significant building structures were processed with the Building Profile Input Program (BPIP), Version 04274, and were included in the CALPUFF model input. Section 6.0 of the PSD report presents a listing of the facility's emissions and structures included in the analysis.



#### **C.4 RECEPTOR LOCATIONS**

For the refined analyses, pollutant concentrations were predicted at 58 discrete receptors located at the boundary of the Chassahowitzka NWA area. These receptors are part of the receptor data developed by the FLM for this area.

#### **C.5 METEOROLOGICAL DATA**

##### **C.5.1 REFINED ANALYSIS**

CALMET was used to develop the gridded parameter fields required for the refined modeling analyses. The follow sections discuss the specific data used and processed in the CALMET model.

##### **C.5.2 CALMET SETTINGS**

The CALMET settings contained in Table C-3 were used for the refined modeling analysis. All input data files needed for CALMET were developed by Golder, with the exception of the upper air and sea surface meteorological data files, which were developed by the FDEP.

##### **C.5.3 MODELING DOMAIN**

A rectangular modeling domain extending 448 km in the east-west (x) direction and 684 km in the north-south (y) direction was used for the refined modeling analysis. The southwest corner of the domain is the origin and is located at 26.25 degrees north latitude and 85.0 degrees west longitude (east and north UTM coordinates of 77 and 2966.0 km, respectively, zone 17 equivalent). This location is in the Gulf of Mexico approximately 250 km west of Naples, Florida. For the processing of meteorological and geophysical data, the domain contains 112 grid cells in the x-direction and 171 grid cells in the y-direction. The domain grid resolution is 4 km. The air modeling analysis was developed in the UTM coordinate system, Zone 17.

##### **C.5.4 MESOSCALE MODEL – GENERATION 4 (MM4/5) DATA**

Pennsylvania State University in conjunction with the NCAR Assessment Laboratory developed the MM4 and MM5 data set, a prognostic wind field or “guess” field, for the United States. The hourly meteorological variables used to create this data set (wind, temperature, dew point depression, and geopotential height for eight standard levels and up to 15 significant levels) are extensive and are available for 1990, 1992, and 1996. The analysis used the MM4 and MM5 data to initialize the CALMET wind field. The MM4 and MM5 data available for 1990 and 1992, respectively, have a

horizontal spacing of 80 km and are used to simulate atmospheric variables within the modeling domain. The MM5 data are also available for 1996 and have a horizontal spacing of 36 km.

The 1990 MM4 subset domain and 1992 MM5 subset domain consist of a 11 x 14- cell rectangle, with 80 km grid resolution, extending from the MM4/5 grid points (46,8) to (56,21). These data were processed to create a MM4/5.DAT file, for input to the CALMET model. The 1996 MM5 subset domain consisted of a 21 x 25- cell rectangle, with 36 km grid resolution, extending from the MM5 grid points (117,23) to (137,47).

The MM4 and MM5 data used in the CALMET, although advanced, lacks the fine detail of specific temporal and spatial meteorological variables and geophysical data. These variables were processed into the appropriate format and introduced into the CALMET model through the additional data files obtained from the following sources.

#### **C.5.5 SURFACE DATA STATIONS AND PROCESSING**

A summary of the surface and sea-surface station information and locations are presented in Table A-4. The surface station data processed for the CALPUFF analyses consisted of data from up to sixteen NWS stations or Federal Aviation Administration (FAA) Flight Service stations for:

- Tampa, Jacksonville, Daytona Beach, Tallahassee, Vero Beach, Fort Myers, Orlando, Pensacola and Gainesville in Florida;
- Columbus, Macon, Savannah, Augusta, Athens, and Atlanta in Georgia; and
- Charleston in South Carolina.

The surface station parameters include wind speed, wind direction, cloud ceiling height, opaque cloud cover, dry bulb temperature, relative humidity, station pressure, and a precipitation code that is based on current weather conditions. The surface station data were processed into a SURF.DAT file format for CALMET input.

Because the modeling domain extends over water, up to 10 sea surface stations were incorporated in the analysis for each of the years evaluated. Data were obtained from available C-Man stations and NOAA buoys. These data were processed into an over-water surface station format (i.e., SEA\*.DAT) for input to CALMET. The over-water station data include wind direction, wind speed and air temperature.

### **C.5.6 UPPER AIR DATA STATIONS AND PROCESSING**

A summary of the upper air station information and locations are presented in Table C-4. Upper air data from the following NWS stations, based on the availability of the upper air data, were used in the modeling analysis:

- Waycross, Georgia (1990, 1992);
- Athens, Georgia (1990, 1992);
- Charleston, South Carolina (1990, 1992, 1996);
- Cape Canaveral (1996)
- Miami (1996)
- Apalachicola, Florida (1990);
- Ruskin, Florida (1990, 1992, 1996);
- Tallahassee, Florida (1992, 1996);
- West Palm Beach (1990, 1992)
- Jacksonville, Florida (1996); and
- Peachtree City, Georgia (1996).

### **C.5.7 PRECIPITATION DATA STATIONS AND PROCESSING**

Precipitation data were processed from a network of hourly precipitation data files collected from primary and secondary NWS precipitation-recording stations located within the latitude and longitudinal limits of the modeling domain. Data for up to 82 stations in Alabama, Georgia and Florida were obtained in NCDC TD-3240 variable format and converted into a fixed-length format. The utility programs PEXTRACT and PMERGE were then used to process the data into the format for the PRECIP.DAT file that is used by CALMET.

### **C.5.8 GEOPHYSICAL DATA PROCESSING**

Terrain elevations for each grid cell of the modeling domain were obtained from 1-degree Digital Elevation Model (DEM) files obtained from the U.S. Geographical Survey (USGS) Internet website. The DEM data was extracted for the modeling domain grid using the utility program TERREL. Land-use data were also extracted from 1-degree USGS files and processed using utility programs CTGCOMP and CTGPROC. Both the terrain and land use files were combined into a GEO.DAT file for input to CALMET with the MAKEGEO utility program.

Table C-1. Refined Modeling Analyses Recommendations<sup>a</sup>

<b>Model Input/Output</b>	<b>Description</b>
Meteorology	Use CALMET (minimum 6 to 10 layers in the vertical; top layer must extend above the maximum mixing depth expected); horizontal domain extends 50 to 80 km beyond outer receptors and sources being modeled; terrain elevation and land-use data is resolved for the situation.
Receptors	Within Class I area(s) of concern; obtain regulatory concurrence on coverage.
Dispersion	<ol style="list-style-type: none"> <li>1. CALPUFF with default dispersion settings.</li> <li>2. Use MESOPUFF II chemistry with wet and dry deposition.</li> <li>3. Define background values for ozone and ammonia for area.</li> </ol>
Processing	<ol style="list-style-type: none"> <li>1. For PSD increments: use highest, second-highest 3-hour and 24-hour average SO<sub>2</sub> concentrations; highest, second-highest 24-hour average PM<sub>10</sub> concentrations; and highest annual average SO<sub>2</sub>, PM<sub>10</sub>, or NO<sub>x</sub> concentrations.</li> <li>2. For haze: process, on a 24-hour basis, compute the source extinction from the maximum increase in emissions of SO<sub>2</sub>, NO<sub>x</sub>, and PM<sub>10</sub>; compute the daily relative humidity factor [f(RH)], provided from an external disk file; and compute the maximum percent change in extinction using the FLM supplied background extinction data in the FLAG document.</li> <li>3. For deposition: compute dry and wet fluxes of nitrogen and sulfur emissions on an annual average basis and adjust concentrations using the molecular weight ratios provided in the FLAG document. Compute total sulfur and nitrogen deposition.</li> <li>4. For significant impact analysis: use highest annual and highest short-term averaging time concentrations for SO<sub>2</sub>, NO<sub>x</sub>, or PM<sub>10</sub>.</li> </ol>

<sup>a</sup> IWAQM Phase II report (12/98) and FLAG document (12/00)

Table C-2. CALPUFF Model Settings

Parameter	Setting
Pollutant Species	SO <sub>2</sub> , SO <sub>4</sub> , NO <sub>x</sub> , HNO <sub>3</sub> , NO <sub>3</sub> , PM <sub>10</sub>
Chemical Transformation	MESOPUFF II scheme, hourly ozone data
Deposition	Include both dry and wet deposition, plume depletion
Meteorological/Land Use Input	CALMET
Plume Rise	Transitional, Stack-tip downwash, Partial plume penetration
Dispersion	Puff plume element, PG /MP coefficients, rural mode, ISC building downwash scheme
Terrain Effects	Partial plume path adjustment
Output	Create binary concentration file including output species for SO <sub>4</sub> , NO <sub>3</sub> , PM <sub>10</sub> , SO <sub>2</sub> , and NO <sub>x</sub> ; process for visibility change using Method 2 and FLAG background extinctions
Model Processing	For haze: highest predicted 24-hour extinction change (%) for the year For deposition: annual average deposition rate For significant impact analysis: highest predicted annual and highest short-term averaging time concentrations for SO <sub>2</sub> , NO <sub>x</sub> , and PM <sub>10</sub> .
Maximum Relative Humidity	95%
Background Values	Ozone: 50 ppb; Ammonia: 1 ppb

Table C-3. CALMET Settings

Parameter	Setting
Horizontal Grid Dimensions	448 by 684 km, 4 km grid resolution
Vertical Grid	10 layers
Weather Station Data Inputs	Surface, upper air, and precipitation stations
Wind model options	Diagnostic wind model, no kinematic effects
Prognostic wind field model	1990 MM4 and 1992 data, 80 km resolution; 1996 MM5 data, 36 km resolution; used for wind field initialization
Output	Binary hourly grid pattern for meteorological data file for CALPUFF input

Table C-4. Surface and Upper Air Stations Used in the North-Central Florida–South Georgia Domain

Station Name	Station Symbol	WBAN Number	UTM Coordinates			Anemometer Height (m)
			Easting (km)	Northing (km)	UTM Zone	
<u>Surface Stations</u>						
Tampa, FL	TPA	12842	349.195	3094.289	17	10
Jacksonville, FL	JAX	13889	432.809	3374.192	17	10
Daytona Beach, FL	DAB	12834	495.118	3228.056	17	10
Tallahassee, FL	TLH	93805	176.408 <sup>a</sup>	3365.835	16	10
Fort Myers, FL	FMY	12835	413.644	2940.405	17	10
Orlando, FL	MCO	12815	468.942	3146.889	17	10
Pensacola, FL	PNS	13899	-95.740 <sup>a</sup>	3386.714	16	10
Vero Beach, FL	VRB	12843	557.487	3058.363	17	10
Columbus, GA	CSG	93842	128.871 <sup>a</sup>	3604.422	16	10
Charleston, SC	CHS	13880	590.422	3640.405	17	10
Macon, GA	MCN	3813	251.562	3620.929	17	10
Savannah, GA	SAV	3822	481.120	3554.985	17	10
Gainesville, FL	GNV	12816	377.390	3284.126	17	10
Augusta, GA	AGS	3820	410.024	3692.184	17	10
Athens, GA	AHN	13873	285.867	3758.824	17	10
Atlanta, GA	ATL	13874	181.588 <sup>a</sup>	3728.434	16	10
<u>Sea Surface Stations</u>						
Venice, FL	VENF1	-	356.24	2995.05	17	-
Cape Canaveral, FL	41009	-	380.25	3152.87	17	-
Tampa West, FL	42036	-	156.41 <sup>a</sup>	3158.73	16	-
Cedar Key, FL	CDRF1	-	302.52	3225.20	17	-
Cape San Blas, FL	CSBF1	-	77.89 <sup>a</sup>	3290.18	16	-
Folly Island, SC	FBIS1	-	604.09	3616.38	17	-
Keaton Beach, FL	KTNF1	-	249.71	3301.66	17	-
Lake Worth, FL	LKWF1	-	596.57	2943.61	17	-
Savannah, GA	SVLS1	-	530.24	3534.94	17	-
St. Augustine, FL	SAUF1	-	474.89	3303.30	17	-
<u>Upper Air Stations</u>						
Ruskin, FL	TPA	12842	361.961	3064.616	17	NA
Waycross, GA	AYS	13861	366.674 <sup>a</sup>	3457.945	17	NA
Athens, GA	AHN	13873	285.866	3758.824	17	NA
Charleston, SC	CHS	13880	590.421	3640.405	17	NA
Cape Canaveral	XMR	12868	544.048	3150.459	17	NA
Miami –FIU	MFL	92803	562.181	2847.983	17	NA
Apalachicola, FL	AQQ	12832	109.807 <sup>a</sup>	3295.816	16	NA
Tallahassee, FL	TLH	93805	176.407 <sup>a</sup>	3365.835	16	NA
Jacksonville, FL	JAX	13889	432.808	3374.192	17	NA
Peachtree, GA	FFC	53819	155.637 <sup>a</sup>	3696.207	16	NA

<sup>a</sup> Equivalent coordinate for Zone 17.

**APPENDIX D**

**BPIP INPUT AND OUTPUT FILES WITH SOURCE, BUILDINGS AND RECEPTOR  
LOCATIONS**



**BUILDING DIMENSIONS  
(BPIP INPUT FILE)**

'D:\PROJECTS\CF-IND\bip\CF1.bpv'  
 'D:\PROJECTS\cargill\greenbay\GB1.isc'  
 'P'

'METERS' 1.00000000

'UTMN' 0.0000

14

'DAPSTORE'	1	0.000	'DAP/MAP STORAGE'
4	20.730		
	0.000	46.640	
	109.730	46.640	
	109.730	0.000	
	-0.000	0.000	
'SHIPLOW'	1	0.000	'SHIPPING BUILDING - LOWER LEVEL'
4	24.380		
	67.090	77.750	
	91.470	77.750	
	91.470	63.840	
	67.090	63.840	
'SHIPHIGH'	1	0.000	'SHIPPING BUILDING - HIGH TIER'
4	34.140		
	67.090	63.840	
	91.470	63.840	
	91.470	52.740	
	67.090	52.740	
'DAPMAPHI'	1	0.000	'DAP/MAP PLANT UPPER LEVEL'
4	32.310		
	146.650	36.630	
	161.290	36.630	
	161.290	6.980	
	146.650	6.980	
'DAPMAPLO'	1	0.000	'DAP/MAP PLANT LOWER LEVEL'
4	27.430		
	113.950	36.630	
	146.650	36.630	
	146.650	6.980	
	113.950	6.980	
'PHOSNO1'	1	0.000	'PHOSPHATE PLANT NO 1'
8	22.860		
	105.530	132.300	
	105.530	199.780	
	117.730	199.780	
	117.730	193.060	
	130.180	193.060	
	130.180	139.010	
	117.730	139.010	
	117.730	132.300	
'PHOSNO2'	1	0.000	'PHOSPHORIC ACID PLANT NO 2'
4	22.560		
	92.960	261.150	
	115.540	261.150	
	115.540	239.350	
	92.960	239.350	
'UNGNDTNK'	1	0.000	'UNGROUND TANK COLUMN'
4	24.690		
	42.200	181.840	
	52.820	181.840	
	52.820	128.510	
	42.200	128.510	
'GNDROCKT'	1	0.000	'GROUND ROCK TANK'
8	9.140		
	64.040	256.520	
	67.820	254.930	
	69.410	251.150	
	67.820	247.370	
	64.040	245.780	

		60.380	247.370
		58.790	251.150
		60.380	254.930
'PHSPAD2A'	1	0.000	'PHOS ACID PAD NO 2 LEFT TANK'
8		9.140	
		128.592	303.749
		134.985	300.983
		137.633	294.590
		134.985	288.198
		128.592	285.550
		122.210	288.198
		119.434	294.590
		122.210	300.983
'PHSPAD2B'	1	0.000	'PHOS ACID PAD NO 2 RIGHT TANK'
32		9.140	
		149.824	303.740
		148.039	303.564
		146.322	303.043
		144.740	302.198
		143.354	301.060
		142.216	299.673
		141.370	298.092
		140.850	296.375
		140.674	294.590
		140.850	292.805
		141.370	291.088
		142.216	289.507
		143.354	288.120
		144.740	286.982
		146.322	286.137
		148.039	285.616
		149.824	285.440
		151.609	285.616
		153.325	286.137
		154.907	286.982
		156.294	288.120
		157.432	289.507
		158.277	291.088
		158.798	292.805
		158.974	294.590
		158.798	296.375
		158.277	298.092
		157.432	299.673
		156.294	301.060
		154.907	302.198
		153.325	303.043
		151.609	303.564
'BLENDTK9'	1	0.000	'PHOS ACID BLEND TANK NO 9'
8		9.144	
		223.770	165.840
		230.113	163.163
		232.910	156.700
		230.113	150.237
		223.770	147.560
		217.307	150.237
		214.630	156.700
		217.307	163.163
'PHSPAD1B'	1	0.000	'PHOS ACID PAD 1 RIGHT TANK'
8		9.144	
		141.890	128.150
		146.160	126.320
		147.990	122.050
		146.160	117.900
		141.890	115.950
		137.740	117.900

	135.790	122.050		
	137.740	126.320		
'PHSPAD1A' 1	0.000		'PHOS ACID PAD 1 LEFT TANK'	
8	9.144			
	128.101	128.419		
	132.352	126.422		
	134.360	122.171		
	132.352	117.797		
	128.101	115.922		
	123.727	117.797		
	121.852	122.171		
	123.727	126.422		
18				
'DAPSHIP' AND SHIPPING'	0.000	40.100	95.400	60.670 'STORAGE
'NAPFRG' FERTILIZER R/G STACK'	0.000	35.510	132.010	39.800 'NORTH AP
'NAPFMS' FERTILIZER MAIN STACK'	0.000	39.010	159.220	38.950 'NORTH AP
'SAPFA' FERTILIZER STACK A'	0.000	39.620	127.130	2.460 'SOUTH AP
'SAPFB' FERTILIZER STACK B'	0.000	39.470	159.340	3.320 'SOUTH AP
'NPHOS1' ACID PLANT NO 1 NORTH STACK'	0.000	30.630	121.030	196.850 'PHOS
'SPHOS1' ACID PLANT NO 1 SOUTH STACK'	0.000	30.630	123.710	136.200 'PHOS
'PHOS2' NO 2 PLANT STACK'	0.000	33.530	74.660	258.590 'PHOS ACID
'GSAP' SUPER ACID PLANT'	0.000	20.120	144.820	271.280 'GREEN
'SATHEAT' ACID THERMINOL HEATER'	0.000	29.000	144.330	243.830 'SUPER
'SAP4' ACID PLANT NO 4'	0.000	30.630	225.110	292.880 'SULFURIC
'SAP3' ACID PLANT NO 3'	0.000	30.630	225.240	274.330 'SULFURIC
'SAP5' ACID PLANT NO 5'	0.000	45.720	365.440	317.160 'SULFURIC
'BLENDTNK' TANKS NO 9 AND 10 VENT'	0.000	6.860	215.600	164.020 'BLEND
'STORPAD1' ACID STORAGE TANKS PAD NO 1 (R-R)'	0.000	18.080	135.060	122.170 'PHOS
'STORPAD2' ACID STORAGE TANKS PAD NO 2 (N-N)'	0.000	19.130	139.330	294.710 'PHOS
'SAP6' ACID PLANT NO 6'	0.000	45.720	467.820	210.880 'SULFURIC
'RAILPIT' UNLOAD STACK'	0.000	3.350	-220.100	2.260 'RAILPIT

**BUILDING DIMENSIONS  
(BPIP OUTPUT FILE)**

DATE : 8/11/2005  
 TIME : 14: 3:11  
 D:\PROJECTS\cargill\greenbay\GB1.isc

=====  
 BPIP PROCESSING INFORMATION:  
 =====

The P flag has been set for preparing downwash related data for a model run utilizing the PRIME algorithm.

Inputs entered in METERS will be converted to meters using a conversion factor of 1.0000. Output will be in meters.

UTMP is set to UTMN. The input is assumed to be in a local X-Y coordinate system as opposed to a UTM coordinate system. True North is in the positive Y direction.

Plant north is set to 0.00 degrees with respect to True North.

D:\PROJECTS\cargill\greenbay\GB1.isc

PRELIMINARY\* GEP STACK HEIGHT RESULTS TABLE  
 (Output Units: meters)

Stack Name	Stack Height	Stack-Building Base Elevation Differences	GEP** EQN1	Preliminary* GEP Stack Height Value
DAPSHIP	40.10	0.00	80.78	80.78
NAPFRG	35.51	0.00	80.78	80.78
NAPFMS	39.01	0.00	80.78	80.78
SAPFA	39.62	0.00	80.78	80.78
SAPFB	39.47	0.00	80.78	80.78
NPHOS1	30.63	0.00	61.73	65.00
SPHOS1	30.63	0.00	74.32	74.32
PHOS2	33.53	0.00	61.73	65.00
GSAP	20.12	0.00	57.15	65.00
SATHEAT	29.00	0.00	61.73	65.00
SAP4	30.63	N/A	0.00	65.00
SAP3	30.63	0.00	56.40	65.00
SAP5	45.72	N/A	0.00	65.00
BLENDTNK	6.86	0.00	57.15	65.00
STORPAD1	18.08	0.00	73.95	73.95
STORPAD2	19.13	0.00	57.15	65.00
SAP6	45.72	N/A	0.00	65.00
RAILPIT	3.35	N/A	0.00	65.00

\* Results are based on Determinants 1 & 2 on pages 1 & 2 of the GEP Technical Support Document. Determinant 3 may be investigated for additional stack height credit. Final values result after Determinant 3 has been taken into consideration.

\*\* Results were derived from Equation 1 on page 6 of GEP Technical Support Document. Values have been adjusted for any stack-building base elevation differences.

Note: Criteria for determining stack heights for modeling emission limitations for a source can be found in Table 3.1 of the GEP Technical Support Document.

BPIP (Dated: 04274)

DATE : 8/11/2005

TIME : 14: 3:11

D:\PROJECTS\cargill\greenbay\GB1.isc

BPIP output is in meters

SO BUILDHGT DAPSHIP	34.14	34.14	34.14	34.14	34.14	34.14
SO BUILDHGT DAPSHIP	34.14	24.38	24.38	32.31	32.31	32.31
SO BUILDHGT DAPSHIP	32.31	32.31	34.14	34.14	34.14	34.14
SO BUILDHGT DAPSHIP	34.14	34.14	34.14	34.14	34.14	34.14
SO BUILDHGT DAPSHIP	34.14	24.38	24.38	32.31	32.31	32.31
SO BUILDHGT DAPSHIP	32.31	32.31	34.14	34.14	34.14	34.14
SO BUILDWID DAPSHIP	25.94	26.71	26.66	25.81	24.17	21.80
SO BUILDWID DAPSHIP	18.77	28.86	25.01	31.74	32.87	33.00
SO BUILDWID DAPSHIP	32.12	30.27	26.66	26.71	25.94	24.38
SO BUILDWID DAPSHIP	25.94	26.71	26.66	25.81	24.17	21.80
SO BUILDWID DAPSHIP	18.77	28.86	25.01	31.74	32.87	33.00
SO BUILDWID DAPSHIP	32.12	30.27	26.66	26.71	25.94	24.38
SO BUILDLEN DAPSHIP	15.16	18.77	21.80	24.17	25.81	26.66
SO BUILDLEN DAPSHIP	26.71	28.35	24.38	19.57	23.90	27.50
SO BUILDLEN DAPSHIP	30.27	32.12	21.80	18.77	15.16	11.10
SO BUILDLEN DAPSHIP	15.16	18.77	21.80	24.17	25.81	26.66
SO BUILDLEN DAPSHIP	26.71	28.35	24.38	19.57	23.90	27.50
SO BUILDLEN DAPSHIP	30.27	32.12	21.80	18.77	15.16	11.10
SO XBADJ DAPSHIP	-12.73	-17.13	-21.02	-24.27	-26.78	-28.48
SO XBADJ DAPSHIP	-29.31	-29.26	-28.31	54.65	56.38	56.40
SO XBADJ DAPSHIP	54.71	51.36	-16.90	-12.66	-8.04	-3.17
SO XBADJ DAPSHIP	-2.44	-1.63	-0.78	0.10	0.97	1.82
SO XBADJ DAPSHIP	2.61	0.90	3.93	-74.21	-80.28	-83.91
SO XBADJ DAPSHIP	-84.99	-83.48	-4.90	-6.11	-7.13	-7.93
SO YBADJ DAPSHIP	15.46	14.33	12.77	10.82	8.54	6.00
SO YBADJ DAPSHIP	3.28	7.30	4.57	-28.10	-16.49	-4.37
SO YBADJ DAPSHIP	7.88	19.89	-15.15	-15.96	-16.29	-16.12
SO YBADJ DAPSHIP	-15.46	-14.33	-12.77	-10.82	-8.54	-6.00
SO YBADJ DAPSHIP	-3.28	-7.30	-4.57	28.10	16.49	4.37
SO YBADJ DAPSHIP	-7.88	-19.89	15.15	15.96	16.29	16.12
SO BUILDHGT NAPFRG	27.43	27.43	27.43	32.31	32.31	32.31
SO BUILDHGT NAPFRG	32.31	32.31	32.31	32.31	32.31	32.31
SO BUILDHGT NAPFRG	32.31	32.31	32.31	27.43	27.43	27.43
SO BUILDHGT NAPFRG	27.43	27.43	27.43	32.31	32.31	32.31
SO BUILDHGT NAPFRG	32.31	32.31	32.31	32.31	32.31	32.31
SO BUILDHGT NAPFRG	32.31	32.31	32.31	27.43	27.43	27.43
SO BUILDWID NAPFRG	37.35	40.87	43.14	30.27	32.12	33.00
SO BUILDWID NAPFRG	32.87	31.74	29.65	31.74	32.87	33.00
SO BUILDWID NAPFRG	32.12	30.27	27.50	40.87	37.35	32.70
SO BUILDWID NAPFRG	37.35	40.87	43.14	30.27	32.12	33.00
SO BUILDWID NAPFRG	32.87	31.74	29.65	31.74	32.87	33.00
SO BUILDWID NAPFRG	32.12	30.27	27.50	40.87	37.35	32.70
SO BUILDLEN NAPFRG	34.88	39.05	42.03	32.12	30.27	27.50
SO BUILDLEN NAPFRG	23.90	19.57	14.64	19.57	23.90	27.50
SO BUILDLEN NAPFRG	30.27	32.12	33.00	39.05	34.88	29.65
SO BUILDLEN NAPFRG	34.88	39.05	42.03	32.12	30.27	27.50
SO BUILDLEN NAPFRG	23.90	19.57	14.64	19.57	23.90	27.50
SO BUILDLEN NAPFRG	30.27	32.12	33.00	39.05	34.88	29.65

SO XBADJ	NAPFRG	-35.46	-37.02	-37.45	-15.73	-9.88	-3.73
SO XBADJ	NAPFRG	2.53	8.72	14.64	14.97	14.84	14.26
SO XBADJ	NAPFRG	13.25	11.84	10.07	-3.20	-0.01	3.17
SO XBADJ	NAPFRG	0.58	-2.03	-4.57	-16.39	-20.39	-23.77
SO XBADJ	NAPFRG	-26.43	-28.28	-29.28	-34.53	-38.74	-41.77
SO XBADJ	NAPFRG	-43.53	-43.96	-43.06	-35.85	-34.86	-32.82
SO YBADJ	NAPFRG	-1.44	-4.55	-7.52	-28.39	-27.90	-26.56
SO YBADJ	NAPFRG	-24.42	-21.53	-17.99	-13.91	-9.40	-4.60
SO YBADJ	NAPFRG	0.33	5.26	10.02	-7.76	-4.81	-1.71
SO YBADJ	NAPFRG	1.44	4.55	7.52	28.39	27.90	26.56
SO YBADJ	NAPFRG	24.42	21.53	17.99	13.91	9.40	4.60
SO YBADJ	NAPFRG	-0.33	-5.26	-10.02	7.76	4.81	1.71

SO BUILDHGT	NAPFMS	27.43	27.43	32.31	32.31	32.31	32.31
SO BUILDHGT	NAPFMS	32.31	32.31	32.31	32.31	32.31	32.31
SO BUILDHGT	NAPFMS	32.31	32.31	32.31	27.43	27.43	27.43
SO BUILDHGT	NAPFMS	27.43	27.43	32.31	32.31	32.31	32.31
SO BUILDHGT	NAPFMS	32.31	32.31	32.31	32.31	32.31	32.31
SO BUILDHGT	NAPFMS	32.31	32.31	32.31	27.43	27.43	27.43
SO BUILDWID	NAPFMS	37.35	40.87	27.50	30.27	32.12	33.00
SO BUILDWID	NAPFMS	32.87	31.74	29.65	31.74	32.87	33.00
SO BUILDWID	NAPFMS	32.12	30.27	27.50	40.87	37.35	32.70
SO BUILDWID	NAPFMS	37.35	40.87	27.50	30.27	32.12	33.00
SO BUILDWID	NAPFMS	32.87	31.74	29.65	31.74	32.87	33.00
SO BUILDWID	NAPFMS	32.12	30.27	27.50	40.87	37.35	32.70
SO BUILDLN	NAPFMS	34.88	39.05	33.00	32.12	30.27	27.50
SO BUILDLN	NAPFMS	23.90	19.57	14.64	19.57	23.90	27.50
SO BUILDLN	NAPFMS	30.27	32.12	33.00	39.05	34.88	29.65
SO BUILDLN	NAPFMS	34.88	39.05	33.00	32.12	30.27	27.50
SO BUILDLN	NAPFMS	23.90	19.57	14.64	19.57	23.90	27.50
SO BUILDLN	NAPFMS	30.27	32.12	33.00	39.05	34.88	29.65
SO XBADJ	NAPFMS	-39.35	-45.53	-33.97	-32.57	-30.18	-26.87
SO XBADJ	NAPFMS	-22.75	-17.93	-12.57	-11.98	-11.02	-9.73
SO XBADJ	NAPFMS	-8.14	-6.30	-4.28	-13.30	-5.58	2.32
SO XBADJ	NAPFMS	4.47	6.48	0.97	0.45	-0.09	-0.63
SO XBADJ	NAPFMS	-1.15	-1.64	-2.07	-7.59	-12.88	-17.78
SO XBADJ	NAPFMS	-22.14	-25.82	-28.72	-25.74	-29.30	-31.97
SO YBADJ	NAPFMS	25.50	21.31	-4.03	-7.00	-9.76	-12.22
SO YBADJ	NAPFMS	-14.32	-15.97	-17.15	-17.80	-17.91	-17.47
SO YBADJ	NAPFMS	-16.51	-15.04	-13.12	-33.04	-31.46	-28.92
SO YBADJ	NAPFMS	-25.50	-21.31	4.03	7.00	9.76	12.22
SO YBADJ	NAPFMS	14.32	15.97	17.15	17.80	17.91	17.47
SO YBADJ	NAPFMS	16.51	15.04	13.12	33.04	31.46	28.92

SO BUILDHGT	SAPFA	27.43	27.43	32.31	32.31	32.31	32.31
SO BUILDHGT	SAPFA	32.31	32.31	32.31	32.31	32.31	32.31
SO BUILDHGT	SAPFA	32.31	34.14	34.14	34.14	27.43	27.43
SO BUILDHGT	SAPFA	27.43	27.43	32.31	32.31	32.31	32.31
SO BUILDHGT	SAPFA	32.31	32.31	32.31	32.31	32.31	32.31
SO BUILDHGT	SAPFA	32.31	27.43	27.43	27.43	27.43	27.43
SO BUILDWID	SAPFA	37.35	40.87	27.50	30.27	32.12	33.00
SO BUILDWID	SAPFA	32.87	31.74	29.65	31.74	32.87	33.00
SO BUILDWID	SAPFA	32.12	25.81	26.66	26.71	37.35	32.70
SO BUILDWID	SAPFA	37.35	40.87	27.50	30.27	32.12	33.00
SO BUILDWID	SAPFA	32.87	31.74	29.65	31.74	32.87	33.00
SO BUILDWID	SAPFA	32.12	44.11	43.14	40.87	37.35	32.70
SO BUILDLN	SAPFA	34.88	39.05	33.00	32.12	30.27	27.50
SO BUILDLN	SAPFA	23.90	19.57	14.64	19.57	23.90	27.50
SO BUILDLN	SAPFA	30.27	24.17	21.80	18.77	34.88	29.65
SO BUILDLN	SAPFA	34.88	39.05	33.00	32.12	30.27	27.50
SO BUILDLN	SAPFA	23.90	19.57	14.64	19.57	23.90	27.50
SO BUILDLN	SAPFA	30.27	43.73	42.03	39.05	34.88	29.65
SO XBADJ	SAPFA	2.16	-0.26	13.67	16.01	17.86	19.16



SO XBADJ	SAPFA	19.89	20.01	19.52	13.29	6.66	-0.18
SO XBADJ	SAPFA	-7.01	-85.61	-83.18	-78.21	-35.94	-34.17
SO XBADJ	SAPFA	-37.04	-38.79	-46.67	-48.13	-48.13	-46.67
SO XBADJ	SAPFA	-43.79	-39.57	-34.16	-32.86	-30.55	-27.32
SO XBADJ	SAPFA	-23.26	-9.08	-5.85	-2.43	1.06	4.52
SO YBADJ	SAPFA	0.24	3.64	-13.57	-8.13	-2.43	3.33
SO YBADJ	SAPFA	9.00	14.39	19.35	23.71	27.36	30.17
SO YBADJ	SAPFA	32.07	-0.77	-13.52	-25.87	6.48	3.17
SO YBADJ	SAPFA	-0.24	-3.64	13.57	8.13	2.43	-3.33
SO YBADJ	SAPFA	-9.00	-14.39	-19.35	-23.71	-27.36	-30.17
SO YBADJ	SAPFA	-32.07	-14.86	-12.42	-9.60	-6.48	-3.17

SO BUILDHGT	SAPFB	27.43	27.43	32.31	32.31	32.31	32.31
SO BUILDHGT	SAPFB	32.31	32.31	32.31	32.31	32.31	32.31
SO BUILDHGT	SAPFB	32.31	32.31	32.31	27.43	27.43	27.43
SO BUILDHGT	SAPFB	27.43	27.43	32.31	32.31	32.31	32.31
SO BUILDHGT	SAPFB	32.31	32.31	32.31	32.31	32.31	32.31
SO BUILDHGT	SAPFB	32.31	32.31	32.31	27.43	27.43	27.43
SO BUILDWID	SAPFB	37.35	40.87	27.50	30.27	32.12	33.00
SO BUILDWID	SAPFB	32.87	31.74	29.65	31.74	32.87	33.00
SO BUILDWID	SAPFB	32.12	30.27	27.50	40.87	37.35	32.70
SO BUILDWID	SAPFB	37.35	40.87	27.50	30.27	32.12	33.00
SO BUILDWID	SAPFB	32.87	31.74	29.65	31.74	32.87	33.00
SO BUILDWID	SAPFB	32.12	30.27	27.50	40.87	37.35	32.70
SO BUILDLEN	SAPFB	34.88	39.05	33.00	32.12	30.27	27.50
SO BUILDLEN	SAPFB	23.90	19.57	14.64	19.57	23.90	27.50
SO BUILDLEN	SAPFB	30.27	32.12	33.00	39.05	34.88	29.65
SO BUILDLEN	SAPFB	34.88	39.05	33.00	32.12	30.27	27.50
SO BUILDLEN	SAPFB	23.90	19.57	14.64	19.57	23.90	27.50
SO BUILDLEN	SAPFB	30.27	32.12	33.00	39.05	34.88	29.65
SO XBADJ	SAPFB	-4.28	-12.09	-3.18	-5.35	-7.37	-9.16
SO XBADJ	SAPFB	-10.67	-11.86	-12.69	-18.28	-23.32	-27.64
SO XBADJ	SAPFB	-31.13	-33.67	-35.19	-46.83	-40.69	-33.31
SO XBADJ	SAPFB	-30.60	-26.96	-29.82	-26.77	-22.91	-18.34
SO XBADJ	SAPFB	-13.23	-7.70	-1.95	-1.28	-0.58	0.14
SO XBADJ	SAPFB	0.86	1.55	2.19	7.78	5.81	3.66
SO YBADJ	SAPFB	31.81	33.61	13.89	16.00	17.61	18.69
SO YBADJ	SAPFB	19.21	19.14	18.49	17.27	15.53	13.32
SO YBADJ	SAPFB	10.71	7.77	4.59	-20.97	-25.39	-29.04
SO YBADJ	SAPFB	-31.81	-33.61	-13.89	-16.00	-17.61	-18.69
SO YBADJ	SAPFB	-19.21	-19.14	-18.48	-17.27	-15.53	-13.32
SO YBADJ	SAPFB	-10.71	-7.77	-4.59	20.97	25.39	29.04

SO BUILDHGT	NPHOS1	22.86	22.86	22.86	24.69	24.69	24.69
SO BUILDHGT	NPHOS1	24.69	24.69	22.86	22.86	22.86	22.86
SO BUILDHGT	NPHOS1	22.86	22.86	22.86	22.86	22.86	22.86
SO BUILDHGT	NPHOS1	22.86	22.86	22.86	22.86	22.86	22.86
SO BUILDHGT	NPHOS1	22.86	22.86	22.86	22.86	22.86	22.86
SO BUILDHGT	NPHOS1	22.86	22.86	22.86	22.86	22.86	22.86
SO BUILDWID	NPHOS1	34.83	43.95	51.73	42.42	47.68	51.50
SO BUILDWID	NPHOS1	53.75	54.36	67.48	68.57	67.58	64.94
SO BUILDWID	NPHOS1	62.39	57.94	51.73	43.94	34.83	24.65
SO BUILDWID	NPHOS1	34.83	43.95	51.73	57.95	62.40	64.95
SO BUILDWID	NPHOS1	67.58	68.57	67.48	68.57	67.58	64.94
SO BUILDWID	NPHOS1	62.39	57.94	51.73	43.94	34.83	24.65
SO BUILDLEN	NPHOS1	68.57	67.58	64.94	47.68	42.42	35.86
SO BUILDLEN	NPHOS1	28.22	19.72	24.65	34.83	43.95	51.73
SO BUILDLEN	NPHOS1	57.95	62.40	64.95	67.58	68.57	67.48
SO BUILDLEN	NPHOS1	68.57	67.58	64.94	62.39	57.94	51.73
SO BUILDLEN	NPHOS1	43.94	34.83	24.65	34.83	43.95	51.73
SO BUILDLEN	NPHOS1	57.95	62.40	64.95	67.58	68.57	67.48
SO XBADJ	NPHOS1	-66.26	-65.96	-63.65	-103.02	-104.32	-102.44
SO XBADJ	NPHOS1	-97.45	-89.50	-15.50	-15.77	-15.57	-14.89

SO XBADJ	NPHOS1	-13.76	-12.21	-10.29	-8.05	-5.58	-2.93
SO XBADJ	NPHOS1	-2.31	-1.62	-1.29	-2.98	-4.57	-6.03
SO XBADJ	NPHOS1	-7.30	-8.35	-9.15	-19.05	-28.38	-36.84
SO XBADJ	NPHOS1	-44.19	-50.19	-54.67	-59.53	-63.00	-64.55
SO YBADJ	NPHOS1	-1.64	-6.41	-10.98	29.53	15.33	0.67
SO YBADJ	NPHOS1	-14.02	-28.28	-30.81	-31.97	-32.17	-31.18
SO YBADJ	NPHOS1	-28.22	-24.40	-19.83	-14.67	-9.06	-3.17
SO YBADJ	NPHOS1	1.64	6.41	10.98	15.22	18.99	22.19
SO YBADJ	NPHOS1	25.74	28.71	30.81	31.97	32.17	31.18
SO YBADJ	NPHOS1	28.22	24.40	19.83	14.67	9.06	3.17
SO BUILDHGT	SPHOS1	27.43	34.14	34.14	34.14	24.38	22.86
SO BUILDHGT	SPHOS1	22.86	24.69	24.69	24.69	24.69	24.69
SO BUILDHGT	SPHOS1	24.69	22.86	22.86	22.86	22.86	22.86
SO BUILDHGT	SPHOS1	22.86	22.86	22.86	22.86	22.86	22.86
SO BUILDHGT	SPHOS1	22.86	22.86	22.86	22.86	22.86	22.86
SO BUILDHGT	SPHOS1	24.69	22.86	22.86	22.86	27.43	27.43
SO BUILDWID	SPHOS1	37.35	26.71	26.66	25.81	26.33	64.95
SO BUILDWID	SPHOS1	67.58	54.36	53.33	54.36	53.75	51.50
SO BUILDWID	SPHOS1	47.68	57.94	51.73	43.94	34.83	24.65
SO BUILDWID	SPHOS1	34.83	43.95	51.73	57.95	62.40	64.95
SO BUILDWID	SPHOS1	67.58	68.57	67.48	68.57	67.58	64.94
SO BUILDWID	SPHOS1	47.68	57.94	51.73	40.87	37.35	32.70
SO BUILDLEN	SPHOS1	34.88	18.77	21.80	24.17	27.62	51.73
SO BUILDLEN	SPHOS1	43.94	19.72	10.62	19.72	28.22	35.86
SO BUILDLEN	SPHOS1	42.42	62.40	64.95	67.58	68.57	67.48
SO BUILDLEN	SPHOS1	68.57	67.58	64.94	62.39	57.94	51.73
SO BUILDLEN	SPHOS1	43.94	34.83	24.65	34.83	43.95	51.73
SO BUILDLEN	SPHOS1	42.42	62.40	64.95	39.05	34.88	29.65
SO XBADJ	SPHOS1	-128.95	-97.79	-100.59	-100.33	-89.89	-17.69
SO XBADJ	SPHOS1	-18.42	-81.61	-81.51	-88.20	-92.20	-93.41
SO XBADJ	SPHOS1	-91.78	-60.39	-64.15	-65.96	-65.77	-63.58
SO XBADJ	SPHOS1	-61.58	-57.70	-52.48	-47.72	-41.51	-34.03
SO XBADJ	SPHOS1	-25.53	-16.25	-6.47	-5.88	-5.12	-4.20
SO XBADJ	SPHOS1	49.36	-2.01	-0.80	-129.27	-131.24	-129.22
SO YBADJ	SPHOS1	-26.35	15.10	-0.48	-16.04	-21.54	31.68
SO YBADJ	SPHOS1	32.17	31.92	18.97	5.45	-8.23	-21.67
SO YBADJ	SPHOS1	-34.44	12.54	8.17	3.55	-1.17	-5.86
SO YBADJ	SPHOS1	-11.53	-16.86	-21.67	-25.82	-29.19	-31.68
SO YBADJ	SPHOS1	-32.17	-31.48	-29.84	-27.29	-23.91	-20.00
SO YBADJ	SPHOS1	34.44	-12.54	-8.17	32.93	13.37	-6.59
SO BUILDHGT	PHOS2	24.69	24.69	24.69	9.14	22.56	22.56
SO BUILDHGT	PHOS2	22.56	22.56	22.56	22.56	22.56	22.56
SO BUILDHGT	PHOS2	22.56	22.56	22.56	22.56	0.00	0.00
SO BUILDHGT	PHOS2	9.14	9.14	9.14	9.14	22.56	22.56
SO BUILDHGT	PHOS2	22.56	22.56	22.56	22.56	22.56	22.56
SO BUILDHGT	PHOS2	22.56	22.86	22.86	22.86	22.86	0.00
SO BUILDWID	PHOS2	19.72	28.22	35.86	10.56	31.21	30.17
SO BUILDWID	PHOS2	28.21	25.39	21.80	25.39	28.21	30.17
SO BUILDWID	PHOS2	31.21	31.31	30.45	28.67	0.00	0.00
SO BUILDWID	PHOS2	10.46	9.98	10.22	10.56	31.21	30.17
SO BUILDWID	PHOS2	28.21	25.39	21.80	25.39	28.21	30.17
SO BUILDWID	PHOS2	31.21	57.94	51.73	43.94	34.83	0.00
SO BUILDLEN	PHOS2	54.36	53.75	51.50	10.57	31.31	30.45
SO BUILDLEN	PHOS2	28.67	26.02	22.58	26.02	28.67	30.45
SO BUILDLEN	PHOS2	31.31	31.21	30.17	28.21	0.00	0.00
SO BUILDLEN	PHOS2	10.58	10.09	10.27	10.57	31.31	30.45
SO BUILDLEN	PHOS2	28.67	26.02	22.58	26.02	28.67	30.45
SO BUILDLEN	PHOS2	31.31	62.40	64.95	67.58	68.57	0.00
SO XBADJ	PHOS2	-133.74	-133.34	-128.88	-17.77	1.65	6.23
SO XBADJ	PHOS2	10.62	14.68	18.30	17.58	16.32	14.57
SO XBADJ	PHOS2	12.37	9.80	6.93	3.85	0.00	0.00

SO XBADJ	PHOS2	3.88	5.58	6.59	7.20	-32.96	-36.68
SO XBADJ	PHOS2	-39.29	-40.70	-40.88	-43.60	-45.00	-45.02
SO XBADJ	PHOS2	-43.68	-127.29	-131.32	-133.40	-131.85	0.00
SO YBADJ	PHOS2	8.78	-9.86	-28.19	3.31	-25.41	-22.02
SO YBADJ	PHOS2	-17.96	-13.35	-8.34	-3.08	2.28	7.57
SO YBADJ	PHOS2	12.63	17.31	21.46	24.95	0.00	0.00
SO YBADJ	PHOS2	-9.11	-7.38	-5.43	-3.31	25.41	22.02
SO YBADJ	PHOS2	17.96	13.35	8.34	3.08	-2.28	-7.57
SO YBADJ	PHOS2	-12.63	28.56	10.55	-7.79	-25.88	0.00
SO BUILDHGT	GSAP	22.86	22.86	22.86	22.56	22.56	22.56
SO BUILDHGT	GSAP	22.56	22.56	22.56	0.00	0.00	9.14
SO BUILDHGT	GSAP	9.14	9.14	9.14	9.14	9.14	9.14
SO BUILDHGT	GSAP	9.14	9.14	22.56	22.56	22.56	22.56
SO BUILDHGT	GSAP	22.56	22.56	22.56	0.00	0.00	9.14
SO BUILDHGT	GSAP	9.14	9.14	9.14	9.14	9.14	9.14
SO BUILDWID	GSAP	34.83	43.95	51.73	31.31	31.21	30.17
SO BUILDWID	GSAP	28.21	25.39	21.80	0.00	0.00	17.46
SO BUILDWID	GSAP	18.01	18.00	17.46	17.10	17.92	18.30
SO BUILDWID	GSAP	18.30	18.28	30.45	31.31	31.21	30.17
SO BUILDWID	GSAP	28.21	25.39	21.80	0.00	0.00	17.46
SO BUILDWID	GSAP	31.76	34.38	36.24	18.28	17.92	18.30
SO BUILDLEN	GSAP	68.57	67.58	64.94	31.21	31.31	30.45
SO BUILDLEN	GSAP	28.67	26.02	22.58	0.00	0.00	17.46
SO BUILDLEN	GSAP	18.00	18.01	17.46	17.10	17.92	18.30
SO BUILDLEN	GSAP	18.30	18.28	30.17	31.21	31.31	30.45
SO BUILDLEN	GSAP	28.67	26.02	22.58	0.00	0.00	17.46
SO BUILDLEN	GSAP	34.38	31.76	28.47	18.28	17.92	18.30
SO XBADJ	GSAP	-143.69	-144.04	-140.01	-57.79	-60.25	-60.88
SO XBADJ	GSAP	-59.65	-56.62	-51.86	0.00	0.00	-34.43
SO XBADJ	GSAP	-36.41	-37.29	-37.03	-36.06	-34.79	-32.46
SO XBADJ	GSAP	-32.97	-32.76	23.41	26.58	28.94	30.42
SO XBADJ	GSAP	30.98	30.59	29.28	0.00	0.00	16.98
SO XBADJ	GSAP	2.03	5.52	8.55	11.05	16.87	14.16
SO YBADJ	GSAP	8.86	-9.51	-27.59	17.56	9.97	2.07
SO YBADJ	GSAP	-5.89	-13.67	-21.03	0.00	0.00	12.08
SO YBADJ	GSAP	7.43	2.56	-2.39	-7.33	-11.99	5.00
SO YBADJ	GSAP	0.88	-3.27	-24.62	-17.56	-9.97	-2.07
SO YBADJ	GSAP	5.89	13.67	21.03	0.00	0.00	-12.08
SO YBADJ	GSAP	-14.31	-10.74	-7.00	-12.67	11.99	-5.00
SO BUILDHGT	SATHEAT	22.86	22.86	22.86	24.69	24.69	24.69
SO BUILDHGT	SATHEAT	22.56	22.56	22.56	22.56	22.56	22.56
SO BUILDHGT	SATHEAT	22.56	22.56	9.14	9.14	9.14	9.14
SO BUILDHGT	SATHEAT	9.14	9.14	0.00	0.00	22.86	22.56
SO BUILDHGT	SATHEAT	22.56	22.56	22.56	22.56	22.56	22.56
SO BUILDHGT	SATHEAT	22.56	22.56	0.00	0.00	0.00	0.00
SO BUILDWID	SATHEAT	34.83	43.95	51.73	42.42	47.68	51.50
SO BUILDWID	SATHEAT	28.21	25.39	21.80	25.39	28.21	30.17
SO BUILDWID	SATHEAT	31.21	31.31	17.46	17.10	17.92	18.30
SO BUILDWID	SATHEAT	18.30	18.28	0.00	0.00	62.40	30.17
SO BUILDWID	SATHEAT	28.21	25.39	21.80	25.39	28.21	30.17
SO BUILDWID	SATHEAT	31.21	31.31	0.00	0.00	0.00	0.00
SO BUILDLEN	SATHEAT	68.57	67.58	64.94	47.68	42.42	35.86
SO BUILDLEN	SATHEAT	28.67	26.02	22.58	26.02	28.67	30.45
SO BUILDLEN	SATHEAT	31.31	31.21	17.46	17.10	17.92	18.30
SO BUILDLEN	SATHEAT	18.30	18.28	0.00	0.00	57.94	30.45
SO BUILDLEN	SATHEAT	28.67	26.02	22.58	26.02	28.67	30.45
SO BUILDLEN	SATHEAT	31.31	31.21	0.00	0.00	0.00	0.00
SO XBADJ	SATHEAT	-116.57	-118.07	-115.99	-153.99	-152.36	-146.11
SO XBADJ	SATHEAT	-49.80	-51.37	-51.37	-53.60	-54.20	-53.15
SO XBADJ	SATHEAT	-50.48	-46.29	-60.56	-61.69	-61.74	-59.91
SO XBADJ	SATHEAT	-60.09	-58.72	0.00	0.00	43.47	16.27

SO XBADJ	SATHEAT	21.13	25.35	28.79	27.57	25.52	22.69
SO XBADJ	SATHEAT	19.17	15.07	0.00	0.00	0.00	0.00
SO YBADJ	SATHEAT	13.15	-0.58	-14.29	17.18	-5.68	-28.37
SO YBADJ	SATHEAT	19.74	13.28	6.42	-0.64	-7.68	-14.48
SO YBADJ	SATHEAT	-20.84	-26.58	11.76	2.52	-6.74	5.49
SO YBADJ	SATHEAT	-3.40	-12.20	0.00	0.00	40.00	-25.60
SO YBADJ	SATHEAT	-19.74	-13.28	-6.42	0.64	7.68	14.48
SO YBADJ	SATHEAT	20.84	26.58	0.00	0.00	0.00	0.00

SO BUILDHGT	SAP4	0.00	0.00	0.00	0.00	0.00	0.00
SO BUILDHGT	SAP4	0.00	0.00	0.00	0.00	0.00	0.00
SO BUILDHGT	SAP4	0.00	0.00	0.00	0.00	0.00	0.00
SO BUILDHGT	SAP4	0.00	0.00	0.00	0.00	0.00	0.00
SO BUILDHGT	SAP4	0.00	0.00	0.00	0.00	0.00	0.00
SO BUILDHGT	SAP4	0.00	0.00	0.00	0.00	0.00	0.00
SO BUILDWID	SAP4	0.00	0.00	0.00	0.00	0.00	0.00
SO BUILDWID	SAP4	0.00	0.00	0.00	0.00	0.00	0.00
SO BUILDWID	SAP4	0.00	0.00	0.00	0.00	0.00	0.00
SO BUILDWID	SAP4	0.00	0.00	0.00	0.00	0.00	0.00
SO BUILDWID	SAP4	0.00	0.00	0.00	0.00	0.00	0.00
SO BUILDWID	SAP4	0.00	0.00	0.00	0.00	0.00	0.00
SO BUILDLEN	SAP4	0.00	0.00	0.00	0.00	0.00	0.00
SO BUILDLEN	SAP4	0.00	0.00	0.00	0.00	0.00	0.00
SO BUILDLEN	SAP4	0.00	0.00	0.00	0.00	0.00	0.00
SO BUILDLEN	SAP4	0.00	0.00	0.00	0.00	0.00	0.00
SO BUILDLEN	SAP4	0.00	0.00	0.00	0.00	0.00	0.00
SO XBADJ	SAP4	0.00	0.00	0.00	0.00	0.00	0.00
SO XBADJ	SAP4	0.00	0.00	0.00	0.00	0.00	0.00
SO XBADJ	SAP4	0.00	0.00	0.00	0.00	0.00	0.00
SO XBADJ	SAP4	0.00	0.00	0.00	0.00	0.00	0.00
SO XBADJ	SAP4	0.00	0.00	0.00	0.00	0.00	0.00
SO XBADJ	SAP4	0.00	0.00	0.00	0.00	0.00	0.00
SO YBADJ	SAP4	0.00	0.00	0.00	0.00	0.00	0.00
SO YBADJ	SAP4	0.00	0.00	0.00	0.00	0.00	0.00
SO YBADJ	SAP4	0.00	0.00	0.00	0.00	0.00	0.00
SO YBADJ	SAP4	0.00	0.00	0.00	0.00	0.00	0.00
SO YBADJ	SAP4	0.00	0.00	0.00	0.00	0.00	0.00
SO YBADJ	SAP4	0.00	0.00	0.00	0.00	0.00	0.00
SO YBADJ	SAP4	0.00	0.00	0.00	0.00	0.00	0.00

SO BUILDHGT	SAP3	0.00	0.00	0.00	0.00	0.00	0.00
SO BUILDHGT	SAP3	22.56	22.56	0.00	0.00	0.00	0.00
SO BUILDHGT	SAP3	0.00	0.00	0.00	0.00	0.00	0.00
SO BUILDHGT	SAP3	0.00	0.00	0.00	0.00	0.00	0.00
SO BUILDHGT	SAP3	0.00	0.00	0.00	0.00	0.00	0.00
SO BUILDHGT	SAP3	0.00	0.00	0.00	0.00	0.00	0.00
SO BUILDWID	SAP3	0.00	0.00	0.00	0.00	0.00	0.00
SO BUILDWID	SAP3	28.21	25.39	0.00	0.00	0.00	0.00
SO BUILDWID	SAP3	0.00	0.00	0.00	0.00	0.00	0.00
SO BUILDWID	SAP3	0.00	0.00	0.00	0.00	0.00	0.00
SO BUILDWID	SAP3	0.00	0.00	0.00	0.00	0.00	0.00
SO BUILDWID	SAP3	0.00	0.00	0.00	0.00	0.00	0.00
SO BUILDLEN	SAP3	0.00	0.00	0.00	0.00	0.00	0.00
SO BUILDLEN	SAP3	28.67	26.02	0.00	0.00	0.00	0.00
SO BUILDLEN	SAP3	0.00	0.00	0.00	0.00	0.00	0.00
SO BUILDLEN	SAP3	0.00	0.00	0.00	0.00	0.00	0.00
SO BUILDLEN	SAP3	0.00	0.00	0.00	0.00	0.00	0.00
SO BUILDLEN	SAP3	0.00	0.00	0.00	0.00	0.00	0.00
SO XBADJ	SAP3	0.00	0.00	0.00	0.00	0.00	0.00
SO XBADJ	SAP3	-136.27	-136.34	0.00	0.00	0.00	0.00
SO XBADJ	SAP3	0.00	0.00	0.00	0.00	0.00	0.00
SO XBADJ	SAP3	0.00	0.00	0.00	0.00	0.00	0.00
SO XBADJ	SAP3	0.00	0.00	0.00	0.00	0.00	0.00

SO XBADJ	SAP3	0.00	0.00	0.00	0.00	0.00	0.00
SO YBADJ	SAP3	0.00	0.00	0.00	0.00	0.00	0.00
SO YBADJ	SAP3	18.75	-2.70	0.00	0.00	0.00	0.00
SO YBADJ	SAP3	0.00	0.00	0.00	0.00	0.00	0.00
SO YBADJ	SAP3	0.00	0.00	0.00	0.00	0.00	0.00
SO YBADJ	SAP3	0.00	0.00	0.00	0.00	0.00	0.00
SO YBADJ	SAP3	0.00	0.00	0.00	0.00	0.00	0.00

SO BUILDHGT	SAP5	0.00	0.00	0.00	0.00	0.00	0.00
SO BUILDHGT	SAP5	0.00	0.00	0.00	0.00	0.00	0.00
SO BUILDHGT	SAP5	0.00	0.00	0.00	0.00	0.00	0.00
SO BUILDHGT	SAP5	0.00	0.00	0.00	0.00	0.00	0.00
SO BUILDHGT	SAP5	0.00	0.00	0.00	0.00	0.00	0.00
SO BUILDHGT	SAP5	0.00	0.00	0.00	0.00	0.00	0.00
SO BUILDWID	SAP5	0.00	0.00	0.00	0.00	0.00	0.00
SO BUILDWID	SAP5	0.00	0.00	0.00	0.00	0.00	0.00
SO BUILDWID	SAP5	0.00	0.00	0.00	0.00	0.00	0.00
SO BUILDWID	SAP5	0.00	0.00	0.00	0.00	0.00	0.00
SO BUILDWID	SAP5	0.00	0.00	0.00	0.00	0.00	0.00
SO BUILDWID	SAP5	0.00	0.00	0.00	0.00	0.00	0.00
SO BUILDWID	SAP5	0.00	0.00	0.00	0.00	0.00	0.00
SO BUILDLEN	SAP5	0.00	0.00	0.00	0.00	0.00	0.00
SO BUILDLEN	SAP5	0.00	0.00	0.00	0.00	0.00	0.00
SO BUILDLEN	SAP5	0.00	0.00	0.00	0.00	0.00	0.00
SO BUILDLEN	SAP5	0.00	0.00	0.00	0.00	0.00	0.00
SO BUILDLEN	SAP5	0.00	0.00	0.00	0.00	0.00	0.00
SO XBADJ	SAP5	0.00	0.00	0.00	0.00	0.00	0.00
SO XBADJ	SAP5	0.00	0.00	0.00	0.00	0.00	0.00
SO XBADJ	SAP5	0.00	0.00	0.00	0.00	0.00	0.00
SO XBADJ	SAP5	0.00	0.00	0.00	0.00	0.00	0.00
SO XBADJ	SAP5	0.00	0.00	0.00	0.00	0.00	0.00
SO XBADJ	SAP5	0.00	0.00	0.00	0.00	0.00	0.00
SO YBADJ	SAP5	0.00	0.00	0.00	0.00	0.00	0.00
SO YBADJ	SAP5	0.00	0.00	0.00	0.00	0.00	0.00
SO YBADJ	SAP5	0.00	0.00	0.00	0.00	0.00	0.00
SO YBADJ	SAP5	0.00	0.00	0.00	0.00	0.00	0.00
SO YBADJ	SAP5	0.00	0.00	0.00	0.00	0.00	0.00
SO YBADJ	SAP5	0.00	0.00	0.00	0.00	0.00	0.00

SO BUILDHGT	BLENDTNK	9.14	9.14	9.14	9.14	9.14	9.14
SO BUILDHGT	BLENDTNK	22.86	22.86	22.86	22.86	22.86	9.14
SO BUILDHGT	BLENDTNK	9.14	9.14	9.14	9.14	9.14	9.14
SO BUILDHGT	BLENDTNK	9.14	9.14	9.14	9.14	9.14	9.14
SO BUILDHGT	BLENDTNK	9.14	9.14	9.14	9.14	9.14	9.14
SO BUILDHGT	BLENDTNK	9.14	9.14	9.14	9.14	9.14	9.14
SO BUILDWID	BLENDTNK	18.00	17.18	17.55	18.12	18.13	17.60
SO BUILDWID	BLENDTNK	67.58	68.57	67.48	68.57	67.58	17.60
SO BUILDWID	BLENDTNK	18.13	18.12	17.55	17.18	18.00	18.28
SO BUILDWID	BLENDTNK	18.00	17.18	17.55	18.12	18.13	17.60
SO BUILDWID	BLENDTNK	17.18	18.00	18.28	18.00	17.18	17.60
SO BUILDWID	BLENDTNK	18.13	18.12	17.55	17.18	18.00	18.28
SO BUILDLEN	BLENDTNK	18.00	17.18	17.60	18.13	18.12	17.55
SO BUILDLEN	BLENDTNK	43.94	34.83	24.65	34.83	43.95	17.55
SO BUILDLEN	BLENDTNK	18.12	18.13	17.60	17.18	18.00	18.28
SO BUILDLEN	BLENDTNK	18.00	17.18	17.60	18.13	18.12	17.55
SO BUILDLEN	BLENDTNK	17.18	18.00	18.28	18.00	17.18	17.55
SO BUILDLEN	BLENDTNK	18.12	18.13	17.60	17.18	18.00	18.28
SO XBADJ	BLENDTNK	-14.79	-12.67	-11.08	-9.46	-7.55	-5.41
SO XBADJ	BLENDTNK	-114.28	-113.91	-110.07	-114.61	-115.66	1.91
SO XBADJ	BLENDTNK	1.86	1.75	1.60	1.08	-0.37	-1.82
SO XBADJ	BLENDTNK	-3.21	-4.50	-6.51	-8.67	-10.57	-12.14
SO XBADJ	BLENDTNK	-13.76	-15.78	-17.31	-18.32	-18.77	-19.46
SO XBADJ	BLENDTNK	-19.98	-19.89	-19.19	-18.26	-17.63	-16.46

SO YBADJ	BLENDTNK	-9.32	-10.18	-10.68	-10.92	-10.82	-10.39
SO YBADJ	BLENDTNK	37.46	20.04	2.02	-16.06	-33.66	-2.28
SO YBADJ	BLENDTNK	-0.39	1.51	3.36	5.17	6.77	8.17
SO YBADJ	BLENDTNK	9.32	10.18	10.68	10.92	10.82	10.39
SO YBADJ	BLENDTNK	9.67	8.63	7.32	5.79	4.08	2.28
SO YBADJ	BLENDTNK	0.39	-1.51	-3.36	-5.17	-6.77	-8.17

SO BUILDHGT	STORPAD1	27.43	27.43	34.14	34.14	34.14	24.38
SO BUILDHGT	STORPAD1	9.14	9.14	24.69	24.69	24.69	24.69
SO BUILDHGT	STORPAD1	24.69	22.86	22.86	22.86	22.86	22.86
SO BUILDHGT	STORPAD1	22.86	22.86	9.14	9.14	20.73	20.73
SO BUILDHGT	STORPAD1	9.14	9.14	22.86	22.86	22.86	22.86
SO BUILDHGT	STORPAD1	22.86	22.86	22.86	27.43	27.43	27.43
SO BUILDWID	STORPAD1	37.35	40.87	26.54	25.81	24.17	33.85
SO BUILDWID	STORPAD1	11.46	12.01	53.33	54.36	53.75	51.50
SO BUILDWID	STORPAD1	47.68	57.94	51.73	43.94	34.83	24.65
SO BUILDWID	STORPAD1	34.83	43.95	11.50	11.86	134.06	107.67
SO BUILDWID	STORPAD1	11.46	12.01	67.48	68.57	67.58	64.94
SO BUILDWID	STORPAD1	62.39	57.94	51.73	54.63	37.35	32.70
SO BUILDLEN	STORPAD1	34.88	39.05	21.80	24.17	25.81	33.62
SO BUILDLEN	STORPAD1	11.46	12.01	10.62	19.72	28.22	35.86
SO BUILDLEN	STORPAD1	42.42	62.40	64.95	67.58	68.57	67.48
SO BUILDLEN	STORPAD1	68.57	67.58	11.50	11.86	147.10	145.32
SO BUILDLEN	STORPAD1	11.46	12.01	24.65	34.83	43.95	51.73
SO BUILDLEN	STORPAD1	57.95	62.40	64.95	44.05	34.88	29.65
SO XBADJ	STORPAD1	-117.11	-115.46	-94.11	-96.88	-96.70	-93.58
SO XBADJ	STORPAD1	0.64	0.70	-92.86	-101.81	-107.67	-110.25
SO XBADJ	STORPAD1	-109.49	-78.43	-81.98	-83.03	-81.56	-77.61
SO XBADJ	STORPAD1	-73.42	-67.00	-9.14	-10.31	34.89	32.73
SO XBADJ	STORPAD1	-12.11	-12.71	4.88	7.73	10.35	12.65
SO XBADJ	STORPAD1	14.56	16.04	17.02	-117.21	-115.45	-115.19
SO YBADJ	STORPAD1	-12.74	-29.85	16.37	1.67	-13.08	-21.41
SO YBADJ	STORPAD1	-2.45	-1.30	33.00	17.30	1.07	-15.19
SO YBADJ	STORPAD1	-30.99	12.86	5.36	-2.31	-9.91	-17.21
SO YBADJ	STORPAD1	-25.14	-32.32	6.00	5.32	38.07	51.72
SO YBADJ	STORPAD1	2.45	1.30	-43.87	-39.13	-33.21	-26.48
SO YBADJ	STORPAD1	-19.97	-12.86	-5.35	31.92	22.12	4.76

SO BUILDHGT	STORPAD2	22.86	22.86	22.56	22.56	22.56	22.56
SO BUILDHGT	STORPAD2	9.14	9.14	9.14	9.14	9.14	9.14
SO BUILDHGT	STORPAD2	9.14	9.14	9.14	9.14	9.14	9.14
SO BUILDHGT	STORPAD2	9.14	22.56	22.56	22.56	22.56	22.56
SO BUILDHGT	STORPAD2	9.14	9.14	9.14	9.14	9.14	9.14
SO BUILDHGT	STORPAD2	9.14	9.14	9.14	9.14	9.14	22.86
SO BUILDWID	STORPAD2	34.83	43.95	30.45	31.31	31.21	30.17
SO BUILDWID	STORPAD2	17.10	17.92	18.20	17.92	17.10	17.46
SO BUILDWID	STORPAD2	18.01	18.00	17.46	17.10	17.92	18.20
SO BUILDWID	STORPAD2	17.92	28.67	30.45	31.31	31.21	30.17
SO BUILDWID	STORPAD2	17.10	17.92	18.20	17.92	17.10	17.46
SO BUILDWID	STORPAD2	18.01	18.00	17.46	17.10	17.92	24.65
SO BUILDLEN	STORPAD2	68.57	67.58	30.17	31.21	31.31	30.45
SO BUILDLEN	STORPAD2	17.10	17.92	18.20	17.92	17.10	17.46
SO BUILDLEN	STORPAD2	18.00	18.01	17.46	17.10	17.92	18.20
SO BUILDLEN	STORPAD2	17.92	28.21	30.17	31.21	31.31	30.45
SO BUILDLEN	STORPAD2	17.10	17.92	18.20	17.92	17.10	17.46
SO BUILDLEN	STORPAD2	18.00	18.01	17.46	17.10	17.92	67.48
SO XBADJ	STORPAD2	-165.81	-164.18	-71.13	-72.21	-71.11	-67.84
SO XBADJ	STORPAD2	-18.74	-19.61	-19.90	-19.57	-18.66	-17.96
SO XBADJ	STORPAD2	-17.15	-15.81	-13.99	-12.17	-10.77	-9.04
SO XBADJ	STORPAD2	-7.04	39.67	40.96	41.00	39.80	37.38
SO XBADJ	STORPAD2	1.64	1.69	1.70	1.65	1.55	0.51
SO XBADJ	STORPAD2	-0.86	-2.20	-3.47	-4.93	-7.16	-162.41
SO YBADJ	STORPAD2	-0.61	-22.68	8.15	-1.71	-11.51	-20.96

SO YBADJ	STORPAD2	3.62	1.81	-0.06	-1.92	-3.73	-5.47
SO YBADJ	STORPAD2	-6.99	-8.30	-9.35	-10.19	-10.65	-10.80
SO YBADJ	STORPAD2	-10.61	-17.76	-8.15	1.71	11.51	20.96
SO YBADJ	STORPAD2	-3.62	-1.81	0.06	1.92	3.73	5.47
SO YBADJ	STORPAD2	6.99	8.30	9.35	10.19	10.65	21.47

SO BUILDHGT	SAP6	0.00	0.00	0.00	0.00	0.00	0.00
SO BUILDHGT	SAP6	0.00	0.00	0.00	0.00	0.00	0.00
SO BUILDHGT	SAP6	0.00	0.00	0.00	0.00	0.00	0.00
SO BUILDHGT	SAP6	0.00	0.00	0.00	0.00	0.00	0.00
SO BUILDHGT	SAP6	0.00	0.00	0.00	0.00	0.00	0.00
SO BUILDWID	SAP6	0.00	0.00	0.00	0.00	0.00	0.00
SO BUILDWID	SAP6	0.00	0.00	0.00	0.00	0.00	0.00
SO BUILDWID	SAP6	0.00	0.00	0.00	0.00	0.00	0.00
SO BUILDWID	SAP6	0.00	0.00	0.00	0.00	0.00	0.00
SO BUILDWID	SAP6	0.00	0.00	0.00	0.00	0.00	0.00
SO BUILDLLEN	SAP6	0.00	0.00	0.00	0.00	0.00	0.00
SO BUILDLLEN	SAP6	0.00	0.00	0.00	0.00	0.00	0.00
SO BUILDLLEN	SAP6	0.00	0.00	0.00	0.00	0.00	0.00
SO BUILDLLEN	SAP6	0.00	0.00	0.00	0.00	0.00	0.00
SO BUILDLLEN	SAP6	0.00	0.00	0.00	0.00	0.00	0.00
SO XBADJ	SAP6	0.00	0.00	0.00	0.00	0.00	0.00
SO XBADJ	SAP6	0.00	0.00	0.00	0.00	0.00	0.00
SO XBADJ	SAP6	0.00	0.00	0.00	0.00	0.00	0.00
SO XBADJ	SAP6	0.00	0.00	0.00	0.00	0.00	0.00
SO XBADJ	SAP6	0.00	0.00	0.00	0.00	0.00	0.00
SO YBADJ	SAP6	0.00	0.00	0.00	0.00	0.00	0.00
SO YBADJ	SAP6	0.00	0.00	0.00	0.00	0.00	0.00
SO YBADJ	SAP6	0.00	0.00	0.00	0.00	0.00	0.00
SO YBADJ	SAP6	0.00	0.00	0.00	0.00	0.00	0.00
SO YBADJ	SAP6	0.00	0.00	0.00	0.00	0.00	0.00
SO YBADJ	SAP6	0.00	0.00	0.00	0.00	0.00	0.00

SO BUILDHGT	RAILPIT	0.00	0.00	0.00	0.00	0.00	0.00
SO BUILDHGT	RAILPIT	0.00	0.00	0.00	0.00	0.00	0.00
SO BUILDHGT	RAILPIT	0.00	0.00	0.00	0.00	0.00	0.00
SO BUILDHGT	RAILPIT	0.00	0.00	0.00	0.00	0.00	0.00
SO BUILDHGT	RAILPIT	0.00	0.00	0.00	0.00	0.00	0.00
SO BUILDWID	RAILPIT	0.00	0.00	0.00	0.00	0.00	0.00
SO BUILDWID	RAILPIT	0.00	0.00	0.00	0.00	0.00	0.00
SO BUILDWID	RAILPIT	0.00	0.00	0.00	0.00	0.00	0.00
SO BUILDWID	RAILPIT	0.00	0.00	0.00	0.00	0.00	0.00
SO BUILDWID	RAILPIT	0.00	0.00	0.00	0.00	0.00	0.00
SO BUILDLLEN	RAILPIT	0.00	0.00	0.00	0.00	0.00	0.00
SO BUILDLLEN	RAILPIT	0.00	0.00	0.00	0.00	0.00	0.00
SO BUILDLLEN	RAILPIT	0.00	0.00	0.00	0.00	0.00	0.00
SO BUILDLLEN	RAILPIT	0.00	0.00	0.00	0.00	0.00	0.00
SO BUILDLLEN	RAILPIT	0.00	0.00	0.00	0.00	0.00	0.00
SO XBADJ	RAILPIT	0.00	0.00	0.00	0.00	0.00	0.00
SO XBADJ	RAILPIT	0.00	0.00	0.00	0.00	0.00	0.00
SO XBADJ	RAILPIT	0.00	0.00	0.00	0.00	0.00	0.00
SO XBADJ	RAILPIT	0.00	0.00	0.00	0.00	0.00	0.00
SO XBADJ	RAILPIT	0.00	0.00	0.00	0.00	0.00	0.00
SO YBADJ	RAILPIT	0.00	0.00	0.00	0.00	0.00	0.00
SO YBADJ	RAILPIT	0.00	0.00	0.00	0.00	0.00	0.00

SO YBADJ	RAILPIT	0.00	0.00	0.00	0.00	0.00	0.00
SO YBADJ	RAILPIT	0.00	0.00	0.00	0.00	0.00	0.00
SO YBADJ	RAILPIT	0.00	0.00	0.00	0.00	0.00	0.00
SO YBADJ	RAILPIT	0.00	0.00	0.00	0.00	0.00	0.00



**APPENDIX E**

**ISCST3 MODEL SUMMARY AND EXAMPLE INPUT FILES**

**EXAMPLE ISCST3 INPUT FILE  
SIGNIFICANT IMPACT ANALYSIS  
ANNUAL AND 24-HOUR AVERAGE PM<sub>10</sub> IMPACTS**

```

CO STARTING
CO STARTING
  TITLEONE MOSAIC GREEN BAY PM10 CLASS II SIG ANALYSIS, ISCST3, 8/15/05
  TITLETWO TAMPA/RUSKIN METDATA, 1991-1995
  MODELOPT DEFAULT CONC RURAL
  AVERTIME PERIOD 24
  POLLUTID PM
  TERRHGTS FLAT
  RUNORNOT RUN
CO FINISHED
**
*****
** ISCST3 Source Pathway
*****
**
**
SO STARTING
** Source Location **
** Source ID - Type - X Coord. - Y Coord. **
** SAPFAF - FUTURE SOUTH AP STACK A
** SAPFBF - FUTURE SOUTH AP STACK B
** NAPFRGF - FUTURE NORTH AP R/G STACK
** NAPFMSF - FUTURE NORTH AP MAIN STACK
** SAPFAC - CURRENT SOUTH AP STACK A
** SAPFBC - CURRENT SOUTH AP STACK B
** NAPFRGC - CURRENT NORTH AP R/G STACK
** NAPFMSC - CURRENT NORTH AP MAIN STACK

** MODELING ORIGIN IS THE SW CORNER OF THE DAP/MAP STORAGE BUILDING
** FUTURE SOURCES
LOCATION SAPFAF POINT 127.13 2.46
LOCATION SAPFBF POINT 159.34 3.32
LOCATION NAPFMSF POINT 159.22 38.95
LOCATION NAPFRGF POINT 132.01 39.80
LOCATION SSVOL1 VOLUME 28.50 28.50
LOCATION SSVOL2 VOLUME 83.36 26.37
LOCATION SSVOL3 VOLUME 79.55 65.23

** CURRENT SOURCES
LOCATION SAPFAC POINT 127.13 2.46
LOCATION SAPFBC POINT 159.34 3.32
LOCATION NAPFMSC POINT 159.22 38.95
LOCATION NAPFRGC POINT 132.01 39.80
LOCATION DAPSHIP POINT 95.40 60.67

** Source Parameters **
** Proposed future stack parameters and emissions
SRCPARAM SAPFAF 0.725 39.6 339. 6.31 1.52
SRCPARAM SAPFBF 0.725 39.5 315. 16.04 2.29
SRCPARAM NAPFMSF 1.940 39.5 313. 20.79 2.29
SRCPARAM NAPFRGF 1.940 35.7 368. 12.00 1.68
SRCPARAM SSVOL1 0.067 10.36 13.26 9.64
SRCPARAM SSVOL2 0.067 10.36 12.26 9.64
SRCPARAM SSVOL3 0.067 17.07 5.81 15.88

** Current stack parameters and emissions
SRCPARAM SAPFAC -0.485 39.6 339. 5.15 1.52
SRCPARAM SAPFBC -0.485 39.5 315. 15.05 2.29
SRCPARAM NAPFMSC -0.510 39.5 313. 19.36 2.29
SRCPARAM NAPFRGC -0.510 35.7 368. 11.03 1.68
SRCPARAM DAPSHIP -0.380 40.1 306. 13.86 2.44

** Building Parameters
SO BUILDHGT NAPFRGC-NAPFRGF 27.43 27.43 27.43 32.31 32.31 32.31

```

SO BUILDHGT	NAPFRGC-NAPFRGF	32.31	32.31	32.31	32.31	32.31	32.31
SO BUILDHGT	NAPFRGC-NAPFRGF	32.31	32.31	32.31	27.43	27.43	27.43
SO BUILDHGT	NAPFRGC-NAPFRGF	27.43	27.43	27.43	32.31	32.31	32.31
SO BUILDHGT	NAPFRGC-NAPFRGF	32.31	32.31	32.31	32.31	32.31	32.31
SO BUILDHGT	NAPFRGC-NAPFRGF	32.31	32.31	32.31	27.43	27.43	27.43
SO BUILDWID	NAPFRGC-NAPFRGF	37.35	40.87	43.14	30.27	32.12	33.00
SO BUILDWID	NAPFRGC-NAPFRGF	32.87	31.74	29.65	31.74	32.87	33.00
SO BUILDWID	NAPFRGC-NAPFRGF	32.12	30.27	27.50	40.87	37.35	32.70
SO BUILDWID	NAPFRGC-NAPFRGF	37.35	40.87	43.14	30.27	32.12	33.00
SO BUILDWID	NAPFRGC-NAPFRGF	32.87	31.74	29.65	31.74	32.87	33.00
SO BUILDWID	NAPFRGC-NAPFRGF	32.12	30.27	27.50	40.87	37.35	32.70
SO BUILDHGT	NAPFMSC-NAPFMSF	27.43	27.43	32.31	32.31	32.31	32.31
SO BUILDHGT	NAPFMSC-NAPFMSF	32.31	32.31	32.31	32.31	32.31	32.31
SO BUILDHGT	NAPFMSC-NAPFMSF	32.31	32.31	32.31	27.43	27.43	27.43
SO BUILDHGT	NAPFMSC-NAPFMSF	27.43	27.43	32.31	32.31	32.31	32.31
SO BUILDHGT	NAPFMSC-NAPFMSF	32.31	32.31	32.31	32.31	32.31	32.31
SO BUILDHGT	NAPFMSC-NAPFMSF	32.31	32.31	32.31	27.43	27.43	27.43
SO BUILDWID	NAPFMSC-NAPFMSF	37.35	40.87	27.50	30.27	32.12	33.00
SO BUILDWID	NAPFMSC-NAPFMSF	32.87	31.74	29.65	31.74	32.87	33.00
SO BUILDWID	NAPFMSC-NAPFMSF	32.12	30.27	27.50	40.87	37.35	32.70
SO BUILDWID	NAPFMSC-NAPFMSF	37.35	40.87	27.50	30.27	32.12	33.00
SO BUILDWID	NAPFMSC-NAPFMSF	32.87	31.74	29.65	31.74	32.87	33.00
SO BUILDWID	NAPFMSC-NAPFMSF	32.12	30.27	27.50	40.87	37.35	32.70
SO BUILDHGT	SAPFAC-SAPFAF	27.43	27.43	32.31	32.31	32.31	32.31
SO BUILDHGT	SAPFAC-SAPFAF	32.31	32.31	32.31	32.31	32.31	32.31
SO BUILDHGT	SAPFAC-SAPFAF	32.31	34.14	34.14	34.14	27.43	27.43
SO BUILDHGT	SAPFAC-SAPFAF	27.43	27.43	32.31	32.31	32.31	32.31
SO BUILDHGT	SAPFAC-SAPFAF	32.31	32.31	32.31	32.31	32.31	32.31
SO BUILDHGT	SAPFAC-SAPFAF	32.31	27.43	27.43	27.43	27.43	27.43
SO BUILDWID	SAPFAC-SAPFAF	37.35	40.87	27.50	30.27	32.12	33.00
SO BUILDWID	SAPFAC-SAPFAF	32.87	31.74	29.65	31.74	32.87	33.00
SO BUILDWID	SAPFAC-SAPFAF	32.12	25.81	26.66	26.71	37.35	32.70
SO BUILDWID	SAPFAC-SAPFAF	37.35	40.87	27.50	30.27	32.12	33.00
SO BUILDWID	SAPFAC-SAPFAF	32.87	31.74	29.65	31.74	32.87	33.00
SO BUILDWID	SAPFAC-SAPFAF	32.12	44.11	43.14	40.87	37.35	32.70
SO BUILDHGT	SAPFBC-SAPFBF	27.43	27.43	32.31	32.31	32.31	32.31
SO BUILDHGT	SAPFBC-SAPFBF	32.31	32.31	32.31	32.31	32.31	32.31
SO BUILDHGT	SAPFBC-SAPFBF	32.31	32.31	32.31	27.43	27.43	27.43
SO BUILDHGT	SAPFBC-SAPFBF	27.43	27.43	32.31	32.31	32.31	32.31
SO BUILDHGT	SAPFBC-SAPFBF	32.31	32.31	32.31	32.31	32.31	32.31
SO BUILDHGT	SAPFBC-SAPFBF	32.31	32.31	32.31	27.43	27.43	27.43
SO BUILDWID	SAPFBC-SAPFBF	37.35	40.87	27.50	30.27	32.12	33.00
SO BUILDWID	SAPFBC-SAPFBF	32.87	31.74	29.65	31.74	32.87	33.00
SO BUILDWID	SAPFBC-SAPFBF	32.12	30.27	27.50	40.87	37.35	32.70
SO BUILDWID	SAPFBC-SAPFBF	37.35	40.87	27.50	30.27	32.12	33.00
SO BUILDWID	SAPFBC-SAPFBF	32.87	31.74	29.65	31.74	32.87	33.00
SO BUILDWID	SAPFBC-SAPFBF	32.12	30.27	27.50	40.87	37.35	32.70
SO BUILDHGT	DAPSHIP	34.14	34.14	34.14	34.14	34.14	34.14
SO BUILDHGT	DAPSHIP	34.14	24.38	24.38	32.31	32.31	32.31
SO BUILDHGT	DAPSHIP	32.31	32.31	34.14	34.14	34.14	34.14
SO BUILDHGT	DAPSHIP	34.14	34.14	34.14	34.14	34.14	34.14
SO BUILDHGT	DAPSHIP	34.14	24.38	24.38	32.31	32.31	32.31
SO BUILDHGT	DAPSHIP	32.31	32.31	34.14	34.14	34.14	34.14
SO BUILDWID	DAPSHIP	25.94	26.71	26.66	25.81	24.17	21.80
SO BUILDWID	DAPSHIP	18.77	28.86	25.01	31.74	32.87	33.00
SO BUILDWID	DAPSHIP	32.12	30.27	26.66	26.71	25.94	24.38
SO BUILDWID	DAPSHIP	25.94	26.71	26.66	25.81	24.17	21.80
SO BUILDWID	DAPSHIP	18.77	28.86	25.01	31.74	32.87	33.00

SO BUILDWID DAPSHIP 32.12 30.27 26.66 26.71 25.94 24.38

SRCGROUP SHIPPING SSVOL1 SSVOL2 SSVOL3  
SRCGROUP ALL

SO FINISHED

\*\*

\*\*\*\*\*

\*\* ISCST3 Receptor Pathway

\*\*\*\*\*

\*\*

\*\*

RE STARTING

\*\* FENCELINE RECEPTORS AT 100 M SPACING

DISCCART -1829.22 -140.52  
DISCCART -1829.22 274.48  
DISCCART -2408.22 274.48  
DISCCART -2895.22 539.48  
DISCCART -2987.22 914.48  
DISCCART -2743.22 1099.48  
DISCCART -2408.22 1834.48  
DISCCART -1536.22 2072.48  
DISCCART -1433.22 2255.48  
DISCCART 549.78 2255.48  
DISCCART 499.78 1462.48  
DISCCART 2069.78 1462.48  
DISCCART 2069.78 -122.52  
DISCCART 1799.78 -549.52  
DISCCART 1432.78 -549.52  
DISCCART 1186.78 -140.52  
DISCCART -1829.22 -57.52  
DISCCART -1829.22 25.48  
DISCCART -1829.22 108.48  
DISCCART -1829.22 191.48  
DISCCART -1925.72 274.48  
DISCCART -2022.22 274.48  
DISCCART -2118.72 274.48  
DISCCART -2215.22 274.48  
DISCCART -2311.72 274.48  
DISCCART -2489.39 318.65  
DISCCART -2570.55 362.81  
DISCCART -2651.72 406.98  
DISCCART -2732.89 451.15  
DISCCART -2814.05 495.31  
DISCCART -2918.22 633.23  
DISCCART -2941.22 726.98  
DISCCART -2964.22 820.73  
DISCCART -2926.22 960.73  
DISCCART -2865.22 1006.98  
DISCCART -2804.22 1053.23  
DISCCART -2706.00 1181.15  
DISCCART -2668.78 1262.81  
DISCCART -2631.55 1344.48  
DISCCART -2594.33 1426.15  
DISCCART -2557.11 1507.81  
DISCCART -2519.89 1589.48  
DISCCART -2482.66 1671.15  
DISCCART -2445.44 1752.81  
DISCCART -2321.02 1858.28  
DISCCART -2233.82 1882.08  
DISCCART -2146.62 1905.88  
DISCCART -2059.42 1929.68  
DISCCART -1972.22 1953.48  
DISCCART -1885.02 1977.28  
DISCCART -1797.82 2001.08  
DISCCART -1710.62 2024.88

DISCCART -1623.42 2048.68  
DISCCART -1501.89 2133.48  
DISCCART -1467.55 2194.48  
DISCCART -1334.07 2255.48  
DISCCART -1234.92 2255.48  
DISCCART -1135.77 2255.48  
DISCCART -1036.62 2255.48  
DISCCART -937.47 2255.48  
DISCCART -838.32 2255.48  
DISCCART -739.17 2255.48  
DISCCART -640.02 2255.48  
DISCCART -540.87 2255.48  
DISCCART -441.72 2255.48  
DISCCART -342.57 2255.48  
DISCCART -243.42 2255.48  
DISCCART -144.27 2255.48  
DISCCART -45.12 2255.48  
DISCCART 54.03 2255.48  
DISCCART 153.18 2255.48  
DISCCART 252.33 2255.48  
DISCCART 351.48 2255.48  
DISCCART 450.63 2255.48  
DISCCART 543.53 2156.36  
DISCCART 537.28 2057.23  
DISCCART 531.03 1958.11  
DISCCART 524.78 1858.98  
DISCCART 518.53 1759.86  
DISCCART 512.28 1660.73  
DISCCART 506.03 1561.61  
DISCCART 597.90 1462.48  
DISCCART 696.03 1462.48  
DISCCART 794.15 1462.48  
DISCCART 892.28 1462.48  
DISCCART 990.41 1462.48  
DISCCART 1088.53 1462.48  
DISCCART 1186.65 1462.48  
DISCCART 1284.78 1462.48  
DISCCART 1382.91 1462.48  
DISCCART 1481.03 1462.48  
DISCCART 1579.16 1462.48  
DISCCART 1677.28 1462.48  
DISCCART 1775.41 1462.48  
DISCCART 1873.53 1462.48  
DISCCART 1971.66 1462.48  
DISCCART 2069.78 1363.42  
DISCCART 2069.78 1264.36  
DISCCART 2069.78 1165.29  
DISCCART 2069.78 1066.23  
DISCCART 2069.78 967.17  
DISCCART 2069.78 868.11  
DISCCART 2069.78 769.04  
DISCCART 2069.78 669.98  
DISCCART 2069.78 570.92  
DISCCART 2069.78 471.86  
DISCCART 2069.78 372.79  
DISCCART 2069.78 273.73  
DISCCART 2069.78 174.67  
DISCCART 2069.78 75.61  
DISCCART 2069.78 -23.46  
DISCCART 2024.78 -193.69  
DISCCART 1979.78 -264.85  
DISCCART 1934.78 -336.02  
DISCCART 1889.78 -407.19  
DISCCART 1844.78 -478.35  
DISCCART 1708.03 -549.52

DISCCART 1616.28 -549.52  
DISCCART 1524.53 -549.52  
DISCCART 1383.58 -467.72  
DISCCART 1334.38 -385.92  
DISCCART 1285.18 -304.12  
DISCCART 1235.98 -222.32  
DISCCART 1089.49 -140.52  
DISCCART 992.20 -140.52  
DISCCART 894.91 -140.52  
DISCCART 797.62 -140.52  
DISCCART 700.33 -140.52  
DISCCART 603.04 -140.52  
DISCCART 505.75 -140.52  
DISCCART 408.46 -140.52  
DISCCART 311.17 -140.52  
DISCCART 213.88 -140.52  
DISCCART 116.59 -140.52  
DISCCART 19.30 -140.52  
DISCCART -77.99 -140.52  
DISCCART -175.28 -140.52  
DISCCART -272.57 -140.52  
DISCCART -369.87 -140.52  
DISCCART -467.16 -140.52  
DISCCART -564.45 -140.52  
DISCCART -661.74 -140.52  
DISCCART -759.03 -140.52  
DISCCART -856.32 -140.52  
DISCCART -953.61 -140.52  
DISCCART -1050.90 -140.52  
DISCCART -1148.19 -140.52  
DISCCART -1245.48 -140.52  
DISCCART -1342.77 -140.52  
DISCCART -1440.06 -140.52  
DISCCART -1537.35 -140.52  
DISCCART -1634.64 -140.52  
DISCCART -1731.93 -140.52  
\*\* RECEPTOR GRID FROM FENCELINE TO 2 KM AT 100 M SPACING  
DISCCART -2000.00 -2000.00  
DISCCART -2000.00 -1900.00  
DISCCART -2000.00 -1800.00  
DISCCART -2000.00 -1700.00  
DISCCART -2000.00 -1600.00  
DISCCART -2000.00 -1500.00  
DISCCART -2000.00 -1400.00  
DISCCART -2000.00 -1300.00  
DISCCART -2000.00 -1200.00  
.  
.  
.  
DISCCART 2000.00 -300.00  
DISCCART 2000.00 1500.00  
DISCCART 2000.00 1600.00  
DISCCART 2000.00 1700.00  
DISCCART 2000.00 1800.00  
DISCCART 2000.00 1900.00  
DISCCART 2000.00 2000.00  
\*\* RECEPTOR GRID FROM 2 TO 5 KM AT 250 M SPACING  
DISCCART -2000.00 2250.00  
DISCCART -2000.00 2500.00  
DISCCART -2000.00 2750.00  
DISCCART -2000.00 3000.00  
DISCCART -2000.00 3250.00  
DISCCART -2000.00 3500.00  
DISCCART -2000.00 3750.00

```

DISCCART -2000.00 4000.00
DISCCART -2000.00 4250.00
DISCCART -2000.00 4500.00
DISCCART -2000.00 4750.00
DISCCART -2000.00 5000.00
DISCCART -1750.00 2250.00
.
.
.
DISCCART -5000.00 2750.00
DISCCART -5000.00 3000.00
DISCCART -5000.00 3250.00
DISCCART -5000.00 3500.00
DISCCART -5000.00 3750.00
DISCCART -5000.00 4000.00
DISCCART -5000.00 4250.00
DISCCART -5000.00 4500.00
DISCCART -5000.00 4750.00
DISCCART -5000.00 5000.00
** RECEPTOR GRID FROM 5 TO 10 KM AT 500 M SPACING
DISCCART -5000.00 5500.00
DISCCART -5000.00 6000.00
DISCCART -5000.00 6500.00
DISCCART -5000.00 7000.00
DISCCART -5000.00 7500.00
DISCCART -5000.00 8000.00
.
.
.
DISCCART -10000.00 6000.00
DISCCART -10000.00 6500.00
DISCCART -10000.00 7000.00
DISCCART -10000.00 7500.00
DISCCART -10000.00 8000.00
DISCCART -10000.00 8500.00
DISCCART -10000.00 9000.00
DISCCART -10000.00 9500.00
DISCCART -10000.00 10000.00
RE FINISHED
**
*****
** ISCST3 Meteorology Pathway
*****
**
**
ME STARTING
  INPUTFIL C:\MET\tpatpa91.met
  ANEMHGT 22 FEET
  SURFDATA 12842 1991 TAMPA/INT'L_ARPT
  UAIRDATA 12842 1991 TAMPA/RUSKIN
ME FINISHED
**
*****
** ISCST3 Output Pathway
*****
**
**
OU STARTING
  RECTABLE ALLAVE FIRST
  PLOTFILE 24 ALL FIRST 91PM24.PLT
  PLOTFILE PERIOD ALL 91PMAN.PLT
OU FINISHED

```



**EXAMPLE ISCST3 INPUT FILE  
SIGNIFICANT IMPACT ANALYSIS  
ANNUAL AVERAGE NO<sub>x</sub> IMPACTS**

CO STARTING  
 TITLEONE MOSAIC GREEN BAY NOX CLASS II SIG ANALYSIS, ISCST3, 8/16/05  
 TITLETWO TAMPA/RUSKIN METDATA, 1991-1995  
 MODELOPT DFAULT CONC RURAL  
 AVERTIME PERIOD  
 POLLUTID NOX  
 TERRHGT FLAT  
 RUNORNOT RUN

CO FINISHED

\*\*  
 \*\*\*\*\*

\*\* ISCST3 Source Pathway  
 \*\*\*\*\*

\*\*  
 \*\*

SO STARTING

\*\* Source Location \*\*  
 \*\* Source ID - Type - X Coord. - Y Coord. \*\*  
 \*\* SAPFBF - FUTURE SOUTH AP STACK B  
 \*\* NAPFMSF - FUTURE NORTH AP MAIN STACK  
 \*\* SAPFBC - CURRENT SOUTH AP STACK B  
 \*\* NAPFMSC - CURRENT NORTH AP MAIN STACK

\*\* MODELING ORIGIN IS THE SW CORNER OF THE DAP/MAP STORAGE BUILDING

\*\* FUTURE SOURCES  
 LOCATION SAPFBF POINT 159.34 3.32  
 LOCATION NAPFMSF POINT 159.22 38.95

\*\* CURRENT SOURCES  
 LOCATION SAPFBC POINT 159.34 3.32  
 LOCATION NAPFMSC POINT 159.22 38.95

\*\* Source Parameters \*\*  
 \*\* Proposed future stack parameters and emissions  
 SRCPARAM SAPFBF 1.587 39.5 315. 16.04 2.29  
 SRCPARAM NAPFMSF 0.933 39.5 313. 20.79 2.29

\*\* Current stack parameters and emissions  
 SRCPARAM SAPFBC -0.105 39.5 315. 15.05 2.29  
 SRCPARAM NAPFMSC -0.143 39.5 313. 19.36 2.29

\*\* Building Parameters

SO BUILDHGT NAPFRGC-NAPFRGF	27.43	27.43	27.43	32.31	32.31	32.31
SO BUILDHGT NAPFRGC-NAPFRGF	32.31	32.31	32.31	32.31	32.31	32.31
SO BUILDHGT NAPFRGC-NAPFRGF	32.31	32.31	32.31	27.43	27.43	27.43
SO BUILDHGT NAPFRGC-NAPFRGF	27.43	27.43	27.43	32.31	32.31	32.31
SO BUILDHGT NAPFRGC-NAPFRGF	32.31	32.31	32.31	32.31	32.31	32.31
SO BUILDHGT NAPFRGC-NAPFRGF	32.31	32.31	32.31	27.43	27.43	27.43
SO BUILDWID NAPFRGC-NAPFRGF	37.35	40.87	43.14	30.27	32.12	33.00
SO BUILDWID NAPFRGC-NAPFRGF	32.87	31.74	29.65	31.74	32.87	33.00
SO BUILDWID NAPFRGC-NAPFRGF	32.12	30.27	27.50	40.87	37.35	32.70
SO BUILDWID NAPFRGC-NAPFRGF	37.35	40.87	43.14	30.27	32.12	33.00
SO BUILDWID NAPFRGC-NAPFRGF	32.87	31.74	29.65	31.74	32.87	33.00
SO BUILDWID NAPFRGC-NAPFRGF	32.12	30.27	27.50	40.87	37.35	32.70

SO BUILDHGT NAPFMSC-NAPFMSF	27.43	27.43	32.31	32.31	32.31	32.31
SO BUILDHGT NAPFMSC-NAPFMSF	32.31	32.31	32.31	32.31	32.31	32.31
SO BUILDHGT NAPFMSC-NAPFMSF	32.31	32.31	32.31	27.43	27.43	27.43
SO BUILDHGT NAPFMSC-NAPFMSF	27.43	27.43	32.31	32.31	32.31	32.31
SO BUILDHGT NAPFMSC-NAPFMSF	32.31	32.31	32.31	32.31	32.31	32.31
SO BUILDHGT NAPFMSC-NAPFMSF	32.31	32.31	32.31	27.43	27.43	27.43
SO BUILDWID NAPFMSC-NAPFMSF	37.35	40.87	27.50	30.27	32.12	33.00
SO BUILDWID NAPFMSC-NAPFMSF	32.87	31.74	29.65	31.74	32.87	33.00

SO BUILDWID	NAPFMSC-NAPFMSE	32.12	30.27	27.50	40.87	37.35	32.70
SO BUILDWID	NAPFMSC-NAPFMSE	37.35	40.87	27.50	30.27	32.12	33.00
SO BUILDWID	NAPFMSC-NAPFMSE	32.87	31.74	29.65	31.74	32.87	33.00
SO BUILDWID	NAPFMSC-NAPFMSE	32.12	30.27	27.50	40.87	37.35	32.70

SO BUILDHGT	SAPFAC-SAPFAF	27.43	27.43	32.31	32.31	32.31	32.31
SO BUILDHGT	SAPFAC-SAPFAF	32.31	32.31	32.31	32.31	32.31	32.31
SO BUILDHGT	SAPFAC-SAPFAF	32.31	34.14	34.14	34.14	27.43	27.43
SO BUILDHGT	SAPFAC-SAPFAF	27.43	27.43	32.31	32.31	32.31	32.31
SO BUILDHGT	SAPFAC-SAPFAF	32.31	32.31	32.31	32.31	32.31	32.31
SO BUILDHGT	SAPFAC-SAPFAF	32.31	27.43	27.43	27.43	27.43	27.43
SO BUILDWID	SAPFAC-SAPFAF	37.35	40.87	27.50	30.27	32.12	33.00
SO BUILDWID	SAPFAC-SAPFAF	32.87	31.74	29.65	31.74	32.87	33.00
SO BUILDWID	SAPFAC-SAPFAF	32.12	25.81	26.66	26.71	37.35	32.70
SO BUILDWID	SAPFAC-SAPFAF	37.35	40.87	27.50	30.27	32.12	33.00
SO BUILDWID	SAPFAC-SAPFAF	32.87	31.74	29.65	31.74	32.87	33.00
SO BUILDWID	SAPFAC-SAPFAF	32.12	44.11	43.14	40.87	37.35	32.70

SO BUILDHGT	SAPFBC-SAPFBF	27.43	27.43	32.31	32.31	32.31	32.31
SO BUILDHGT	SAPFBC-SAPFBF	32.31	32.31	32.31	32.31	32.31	32.31
SO BUILDHGT	SAPFBC-SAPFBF	32.31	32.31	32.31	27.43	27.43	27.43
SO BUILDHGT	SAPFBC-SAPFBF	27.43	27.43	32.31	32.31	32.31	32.31
SO BUILDHGT	SAPFBC-SAPFBF	32.31	32.31	32.31	32.31	32.31	32.31
SO BUILDHGT	SAPFBC-SAPFBF	32.31	32.31	32.31	27.43	27.43	27.43
SO BUILDWID	SAPFBC-SAPFBF	37.35	40.87	27.50	30.27	32.12	33.00
SO BUILDWID	SAPFBC-SAPFBF	32.87	31.74	29.65	31.74	32.87	33.00
SO BUILDWID	SAPFBC-SAPFBF	32.12	30.27	27.50	40.87	37.35	32.70
SO BUILDWID	SAPFBC-SAPFBF	37.35	40.87	27.50	30.27	32.12	33.00
SO BUILDWID	SAPFBC-SAPFBF	32.87	31.74	29.65	31.74	32.87	33.00
SO BUILDWID	SAPFBC-SAPFBF	32.12	30.27	27.50	40.87	37.35	32.70

SRCGROUP ALL

SO FINISHED

\*\*  
\*\*\*\*\*

\*\* ISCST3 Receptor Pathway

\*\*\*\*\*

\*\*

\*\*

RE STARTING

\*\* FENCELINE RECEPTORS AT 100 M SPACING

DISCCART -1829.22 -140.52  
DISCCART -1829.22 274.48  
DISCCART -2408.22 274.48  
DISCCART -2895.22 539.48  
DISCCART -2987.22 914.48  
DISCCART -2743.22 1099.48  
DISCCART -2408.22 1834.48  
DISCCART -1536.22 2072.48  
DISCCART -1433.22 2255.48  
DISCCART 549.78 2255.48  
DISCCART 499.78 1462.48  
DISCCART 2069.78 1462.48  
DISCCART 2069.78 -122.52  
DISCCART 1799.78 -549.52  
DISCCART 1432.78 -549.52  
DISCCART 1186.78 -140.52  
DISCCART -1829.22 -57.52  
DISCCART -1829.22 25.48  
DISCCART -1829.22 108.48  
DISCCART -1829.22 191.48  
DISCCART -1925.72 274.48  
DISCCART -2022.22 274.48

DISCCART -2118.72 274.48  
DISCCART -2215.22 274.48  
DISCCART -2311.72 274.48  
DISCCART -2489.39 318.65  
DISCCART -2570.55 362.81  
DISCCART -2651.72 406.98  
DISCCART -2732.89 451.15  
DISCCART -2814.05 495.31  
DISCCART -2918.22 633.23  
DISCCART -2941.22 726.98  
DISCCART -2964.22 820.73  
DISCCART -2926.22 960.73  
DISCCART -2865.22 1006.98  
DISCCART -2804.22 1053.23  
DISCCART -2706.00 1181.15  
DISCCART -2668.78 1262.81  
DISCCART -2631.55 1344.48  
DISCCART -2594.33 1426.15  
DISCCART -2557.11 1507.81  
DISCCART -2519.89 1589.48  
DISCCART -2482.66 1671.15  
DISCCART -2445.44 1752.81  
DISCCART -2321.02 1858.28  
DISCCART -2233.82 1882.08  
DISCCART -2146.62 1905.88  
DISCCART -2059.42 1929.68  
DISCCART -1972.22 1953.48  
DISCCART -1885.02 1977.28  
DISCCART -1797.82 2001.08  
DISCCART -1710.62 2024.88  
DISCCART -1623.42 2048.68  
DISCCART -1501.89 2133.48  
DISCCART -1467.55 2194.48  
DISCCART -1334.07 2255.48  
DISCCART -1234.92 2255.48  
DISCCART -1135.77 2255.48  
DISCCART -1036.62 2255.48  
DISCCART -937.47 2255.48  
DISCCART -838.32 2255.48  
DISCCART -739.17 2255.48  
DISCCART -640.02 2255.48  
DISCCART -540.87 2255.48  
DISCCART -441.72 2255.48  
DISCCART -342.57 2255.48  
DISCCART -243.42 2255.48  
DISCCART -144.27 2255.48  
DISCCART -45.12 2255.48  
DISCCART 54.03 2255.48  
DISCCART 153.18 2255.48  
DISCCART 252.33 2255.48  
DISCCART 351.48 2255.48  
DISCCART 450.63 2255.48  
DISCCART 543.53 2156.36  
DISCCART 537.28 2057.23  
DISCCART 531.03 1958.11  
DISCCART 524.78 1858.98  
DISCCART 518.53 1759.86  
DISCCART 512.28 1660.73  
DISCCART 506.03 1561.61  
DISCCART 597.90 1462.48  
DISCCART 696.03 1462.48  
DISCCART 794.15 1462.48  
DISCCART 892.28 1462.48  
DISCCART 990.41 1462.48  
DISCCART 1088.53 1462.48

DISCCART 1186.65 1462.48  
DISCCART 1284.78 1462.48  
DISCCART 1382.91 1462.48  
DISCCART 1481.03 1462.48  
DISCCART 1579.16 1462.48  
DISCCART 1677.28 1462.48  
DISCCART 1775.41 1462.48  
DISCCART 1873.53 1462.48  
DISCCART 1971.66 1462.48  
DISCCART 2069.78 1363.42  
DISCCART 2069.78 1264.36  
DISCCART 2069.78 1165.29  
DISCCART 2069.78 1066.23  
DISCCART 2069.78 967.17  
DISCCART 2069.78 868.11  
DISCCART 2069.78 769.04  
DISCCART 2069.78 669.98  
DISCCART 2069.78 570.92  
DISCCART 2069.78 471.86  
DISCCART 2069.78 372.79  
DISCCART 2069.78 273.73  
DISCCART 2069.78 174.67  
DISCCART 2069.78 75.61  
DISCCART 2069.78 -23.46  
DISCCART 2024.78 -193.69  
DISCCART 1979.78 -264.85  
DISCCART 1934.78 -336.02  
DISCCART 1889.78 -407.19  
DISCCART 1844.78 -478.35  
DISCCART 1708.03 -549.52  
DISCCART 1616.28 -549.52  
DISCCART 1524.53 -549.52  
DISCCART 1383.58 -467.72  
DISCCART 1334.38 -385.92  
DISCCART 1285.18 -304.12  
DISCCART 1235.98 -222.32  
DISCCART 1089.49 -140.52  
DISCCART 992.20 -140.52  
DISCCART 894.91 -140.52  
DISCCART 797.62 -140.52  
DISCCART 700.33 -140.52  
DISCCART 603.04 -140.52  
DISCCART 505.75 -140.52  
DISCCART 408.46 -140.52  
DISCCART 311.17 -140.52  
DISCCART 213.88 -140.52  
DISCCART 116.59 -140.52  
DISCCART 19.30 -140.52  
DISCCART -77.99 -140.52  
DISCCART -175.28 -140.52  
DISCCART -272.57 -140.52  
DISCCART -369.87 -140.52  
DISCCART -467.16 -140.52  
DISCCART -564.45 -140.52  
DISCCART -661.74 -140.52  
DISCCART -759.03 -140.52  
DISCCART -856.32 -140.52  
DISCCART -953.61 -140.52  
DISCCART -1050.90 -140.52  
DISCCART -1148.19 -140.52  
DISCCART -1245.48 -140.52  
DISCCART -1342.77 -140.52  
DISCCART -1440.06 -140.52  
DISCCART -1537.35 -140.52  
DISCCART -1634.64 -140.52

DISCCART -1731.93 -140.52

\*\* RECEPTOR GRID FROM FENCELINE TO 2 KM AT 100 M SPACING

DISCCART -2000.00 -2000.00

DISCCART -2000.00 -1900.00

DISCCART -2000.00 -1800.00

DISCCART -2000.00 -1700.00

DISCCART -2000.00 -1600.00

DISCCART -2000.00 -1500.00

DISCCART -2000.00 -1400.00

DISCCART -2000.00 -1300.00

DISCCART -2000.00 -1200.00

.

.

.

DISCCART 2000.00 -300.00

DISCCART 2000.00 1500.00

DISCCART 2000.00 1600.00

DISCCART 2000.00 1700.00

DISCCART 2000.00 1800.00

DISCCART 2000.00 1900.00

DISCCART 2000.00 2000.00

\*\* RECEPTOR GRID FROM 2 TO 5 KM AT 250 M SPACING

DISCCART -2000.00 2250.00

DISCCART -2000.00 2500.00

DISCCART -2000.00 2750.00

DISCCART -2000.00 3000.00

DISCCART -2000.00 3250.00

DISCCART -2000.00 3500.00

DISCCART -2000.00 3750.00

DISCCART -2000.00 4000.00

DISCCART -2000.00 4250.00

.

.

.

DISCCART -5000.00 2750.00

DISCCART -5000.00 3000.00

DISCCART -5000.00 3250.00

DISCCART -5000.00 3500.00

DISCCART -5000.00 3750.00

DISCCART -5000.00 4000.00

DISCCART -5000.00 4250.00

DISCCART -5000.00 4500.00

DISCCART -5000.00 4750.00

DISCCART -5000.00 5000.00

\*\* RECEPTOR GRID FROM 5 TO 10 KM AT 500 M SPACING

DISCCART -5000.00 5500.00

DISCCART -5000.00 6000.00

DISCCART -5000.00 6500.00

DISCCART -5000.00 7000.00

DISCCART -5000.00 7500.00

DISCCART -5000.00 8000.00

.

.

.

DISCCART -10000.00 6500.00

DISCCART -10000.00 7000.00

DISCCART -10000.00 7500.00

DISCCART -10000.00 8000.00

DISCCART -10000.00 8500.00

DISCCART -10000.00 9000.00

DISCCART -10000.00 9500.00

DISCCART -10000.00 10000.00

```
RE FINISHED
**
*****
** ISCST3 Meteorology Pathway
*****
**
**
ME STARTING
  INPUTFIL C:\MET\tpatpa91.met
  ANEMHGHT 22 FEET
  SURFDATA 12842 1991 TAMPA/INT'L_ARPT
  UAIRDATA 12842 1991 TAMPA/RUSKIN
ME FINISHED
**
*****
** ISCST3 Output Pathway
*****
**
**
OU STARTING
  RECTABLE ALLAVE FIRST
  PLOTFILE PERIOD ALL 91NOX.PLT
OU FINISHED
```

**EXAMPLE ISCST3 INPUT FILE  
AAQS ANALYSIS  
24-HOUR AVERAGE PM<sub>10</sub> IMPACTS**



CO STARTING  
 TITLEONE MOSAIC GREEN BAY PM10 AAQS ANALYSIS, ISCST3, 8/18/05  
 TITLETWO TAMPA/RUSKIN METDATA, 1991-1995  
 MODELOPT DEFAULT CONC .RURAL  
 AVERTIME 24  
 POLLUTID PM10  
 TERRHGTS FLAT  
 MULTYEAR H6H YEAR1.SAV  
 RUNORNOT RUN

CO FINISHED

\*\*  
 \*\*\*\*\*

\*\* ISCST3 Source Pathway

\*\*\*\*\*

\*\*

\*\*

SO STARTING

\*\*

\*\* MODELING ORIGIN IS THE SW CORNER OF THE DAP/MAP STORAGE BUILDING

\*\*

\*\*\*\*\*Project Sources\*\*\*\*\*

\*\* SAPFAF - FUTURE SOUTH AP STACK A

\*\* SAPFBF - FUTURE SOUTH AP STACK B

\*\* NAPFRGF - FUTURE NORTH AP R/G STACK

\*\* NAPFMSF - FUTURE NORTH AP MAIN STACK

\*\* SAPFAC - CURRENT SOUTH AP STACK A

\*\* SAPFBC - CURRENT SOUTH AP STACK B

\*\* NAPFRGC - CURRENT NORTH AP R/G STACK

\*\* NAPFMSC - CURRENT NORTH AP MAIN STACK

\*\* FUTURE SOURCES

LOCATION SAPFAF POINT 127.13 2.46

LOCATION SAPFBF POINT 159.34 3.32

LOCATION NAPFMSF POINT 159.22 38.95

LOCATION NAPFRGF POINT 132.01 39.80

LOCATION SSVOL1 VOLUME 28.50 28.50

LOCATION SSVOL2 VOLUME 83.36 26.37

LOCATION SSVOL3 VOLUME 79.55 65.23

\*\* CURRENT SOURCES

LOCATION SAPFAC POINT 127.13 2.46

LOCATION SAPFBC POINT 159.34 3.32

LOCATION NAPFMSC POINT 159.22 38.95

LOCATION NAPFRGC POINT 132.01 39.80

LOCATION DAPSHIP POINT 95.40 60.67

\*\* Proposed future stack parameters and emissions

SRCPARAM SAPFAF 0.725 39.6 339. 6.31 1.52

SRCPARAM SAPFBF 0.725 39.5 315. 16.04 2.29

SRCPARAM NAPFMSF 1.940 39.5 313. 20.79 2.29

SRCPARAM NAPFRGF 1.940 35.7 368. 12.00 1.68

SRCPARAM SSVOL1 0.067 10.36 13.26 9.64

SRCPARAM SSVOL2 0.067 10.36 12.26 9.64

SRCPARAM SSVOL3 0.067 17.07 5.81 15.88

\*\* Current stack parameters and emissions

SRCPARAM SAPFAC -0.485 39.6 339. 5.15 1.52

SRCPARAM SAPFBC -0.485 39.5 315. 15.05 2.29

SRCPARAM NAPFMSC -0.510 39.5 313. 19.36 2.29

SRCPARAM NAPFRGC -0.510 35.7 368. 11.03 1.68

SRCPARAM DAPSHIP -0.380 40.1 306. 13.86 2.44

\*\*\*\*\*Other PM Sources at Green Bay\*\*\*\*\*

\*\* RAILPIT - RAIL UNLOAD PIT STACK

\*\* TRUCKUNL - MOLTEN SULFUR TRUCK UNLOADING

\*\* MOLTTNK1 - MOLTEN SULFUR TANK 1  
 \*\* MOLTTNK2 - MOLTEN SULFUR TANK 2  
 \*\* MOLTTNK3 - MOLTEN SULFUR TANK 3  
 \*\* MOLTTNK4 - MOLTEN SULFUR TANK 4  
 \*\* SULFPIT4 - MOLTEN SULFUR PIT 4  
 \*\* SULFPIT5 - MOLTEN SULFUR PIT 5  
 \*\* SULFPIT6 - MOLTEN SULFUR PIT 6

LOCATION RAILPIT POINT -220.10 2.26  
 LOCATION TRUCKUNL AREA 275.06 160.11  
 LOCATION MOLTTNK1 AREA -204.26 8.90  
 LOCATION MOLTTNK2 AREA 268.58 177.00  
 LOCATION MOLTTNK3 AREA 284.54 177.00  
 LOCATION MOLTTNK4 AREA -230.49 13.79  
 LOCATION SULFPIT4 AREA 282.53 195.07  
 LOCATION SULFPIT5 AREA 269.44 168.42  
 LOCATION SULFPIT6 AREA 269.78 195.07

SRCPARAM RAILPIT 0.040 3.4 293. 149.0 0.25  
 \*\* Area Sources  
 \*\* Area = 86.369 sq m  
 SRCPARAM TRUCKUNL 1.621e-5 3.45 7.53 11.47 0.0  
 \*\* Area = 334.524 sq m  
 SRCPARAM MOLTTNK1 1.196e-4 10.06 18.29 18.29 0.0  
 \*\* Area = 188.24 sq m  
 SRCPARAM MOLTTNK2 2.178e-4 10.06 13.72 13.72 0.0  
 \*\* Area = 188.24 sq m  
 SRCPARAM MOLTTNK3 2.178e-4 10.06 13.72 13.72 0.0  
 \*\* Area = 324 sq m  
 SRCPARAM MOLTTNK4 6.79e-5 11.28 18.00 18.00 0.0  
 \*\* Area = 9.30 sq m  
 SRCPARAM SULFPIT4 1.5e-4 2.90 3.05 3.05 0.0  
 \*\* Area = 7.62 sq m  
 SRCPARAM SULFPIT5 1.84e-4 3.45 2.76 2.76 0.0  
 \*\* Area = 9.30 sq m  
 SRCPARAM SULFPIT6 1.5e-4 2.44 3.05 3.05 0.0

\*\*\*\*\* BACKGROUND PM10 AAQS

SOURCES\*\*\*\*\*

**ID	Emission Unit Description	EU ID	ID Name
--			
**			
**	Bartow Phosphate Center (Formerly IMC Uranium Recovery)		
**1050052	CF Industries, Inc. - Bartow		
**	No. 1 MAP/DAP/GTSP Shipping Unit	2	CFIBR2
**	Boiler No. 1	21	CFIBR21
**	No. 2 MAP/DAP Shipping Unit	25	CFIBR25
**	West Phosphate Rock Unloading System	26	CFIBR26
**1050046	Cargill Fertilizer - Bartow		
**	N. 3 Fertilizer Plant	1	CFBAR1
**	N 4 Fertilizer Plant	21	CFBAR2
**	N.3 Fertilizer Shipping Plant	4	CFBAR3
**	N.4 Fertilizer Shipping Plant	2	CFBAR4
**1050050	U S Agri-Chemicals - Bartow		
**	150 TPH MAP/DAP Plant	38	USAGBR38
**	DAP/MAP Storage/Loading	39	USAGBR39
**1050234	Hines Energy Complex (Progress Energy)		
**	Power Block 1	1	HINES1
**	Power Block 2	2	HINES2
**	Power Block 3	5	HINES3
**	Auxiliary Boiler	3	HINESAX
**	EMERGENCY DIESEL GENERATOR	4	HINESEG
**1050055	IMC - Agrico Co. (South Pierce)		
**	Auxiliary Boiler	1	IMCPIER1

**	GTSP Production Plant	23	IMCPIE23
**	GTSP East Storage Nrth	24	IMCPIE24
**	GTSP East Storage South	25	IMCPIE25
**1050145	Bartow Ethanol, Inc.		
**	BOILER	1	BRTETH1
**1050056	IMC-Agrico Co. (Prairie)		
**	Limestone Bucket Elevator	1	IMCPR1
**	#1, Limerock Grinding	2	IMCPR2
**	N. 3, Limerock Grinding	3	IMCPR3
**	Limerock Dryer	4	IMCPR4
**	#4 Raymond Mill	5	IMCPR5
**	Limestone Bin & Truck Loadout	6	IMCPR6
**	Feed Bin Area & Assoc. Equip.	7	IMCPR7
**1050057	IMC Phosphates (Nichols)		
**	Phosphoric Acid Plant	1	IMCNIC1
**	DAP Cooler Venturi Scrubber	2	IMCNIC2
**	DAP Plant Dryer	3	IMCNIC3
**	DAP Plt Scrubber 4a	4	IMCNIC4
**	North Ball Mill	9	IMCNIC9
**	South Ball Mill	10	IMCNIC10
**	Phosphate Rock Dryer W/ Wet Scrubber	12	IMCNIC12
**	Package Boiler (North Standby Boiler)	15	IMCNIC15
**	Package Boiler	16	IMCNIC16
**	Dry Phosphate Rock Storage Bin	19	IMCNIC19
**	Sulfur Storage & Handling Tank	21	IMCNIC21
**1050047	Agrifos Mining, L.L.C. - Nichols		
**	Rock Dryer N. 1	1	AGRNIC1
**	Rock Dryer N. 2	2	AGRNIC2
**	Dry Rock Storage Building	10	AGRNIC10
**	Dry Rock Loadout	11	AGRNIC11
**1050034	IMC-Agrico Co. (CFMO) Noralyn		
**	Dryer No. 1 @ Noralyn Mine (011)	11	IMCFMO11
**	Dryer No. 2 East @ Noralyn Mine (012)	12	IMCFMO12
**	Silos 1, 2, 3, 12 @ Noralyn Mine (013)	13	IMCFMO13
**	Ball Mill Transfers @ Noralyn Mine (014)	14	IMCFMO14
**	Ball Mill Transfers @ Noralyn Mine (015)	15	IMCFMO15
**	Ball Mill No. 3 @ Noralyn Mine (016)	16	IMCFMO16
**	Ball Mill No. 4 @ Noralyn Mine (017)	17	IMCFMO17
**	No. 3 Ball Mill Loadouts @ Noralyn Mine (018)	18	IMCFMO18
**	No. 4 Ball Mill Loadouts @ Noralyn Mine (019)	19	IMCFMO19
**	A Track Railcar Loadout @ Noralyn Mine	20	IMCFMO20
**	B Track Railcar Loadout @ Noralyn Mine	21	IMCFMO21
**	Transfer Points To Conveyors C31 & C33 @ Noralyn	22	IMCFMO22
**	Material Transfer Sources @ Noralyn	23	IMCFMO23
**	Dry Phosphate Transfer @ Noralyn Mine (024)	24	IMCFMO24
**1050034	IMC Phosphates (CFMO)		
**	1 And 2 Grinders W/Scrubbers @ Kingsford Mine	2	IMCFMO2
**	No 3 Grinder W/Scrubber @ Kingsford Mine	3	IMCFMO3
**	Phos Rk Dryer W/Scrubber @ Kingsford Mine	4	IMCFMO4
**	Phosphate Transfer/Storage Silos W/Scrubber @ Kingsf	5	IMCFMO5
**	Unground Phosphate Rr Car Load Out @ Kingsford Mine	6	IMCFMO6
**	Boiler @ Four Corners Mine	8	IMCFMO8
**	Magnetite Storage Bin @ Four Corners Mine (009)	9	IMCFMO9
**	Ferrosilicon Storage Bin @ Four Corners Mine	10	IMCFMO10
**1050059	IMC-AGRICO CO. (NEW WALES)		
**	PHOSPHATE ROCK RAILCAR UNLOADING (80 TPH MAXIMUM RA	5	WALES5
**	GROUND ROCK SILO W/PNEUMATIC 80 TPH LOAD RATE	6	WALES6
**	DAP PLANT NO. 1 W/3 TELLER VENTURI SCRUBBERS,	9	WALES9
**	GTSP PLANT (65 TPH) W/TELLER PACKED BED SCRUBBER	10	WALES10
**	MAP PRILL TOWER W/VENTURI SCRUBBER AND CYCLONIC DEMI	11	WALES11
**	GTSP STORAGE (65 TPH) W/ FUME SCRUBBER	12	WALES12
**	ANIMAL FEED SHIPPING/TRUCK LOADOUT (200 TPH), WITH B	15	WALES15
**	GROUND PHOSPHATE ROCK BIN AT GTSP PLANT	21	WALES21
**	ANIMAL FEED STORAGE SILOS (3) -"A"SIDE	23	WALES23
**	ANIMAL FEED STORAGE/SHIPPING/RAILCAR LOADOUT	24	WALES24

**	ANIMAL FEED - (2) LIMESTONE SILOS	25	WALES25
**	ANIMAL FEED - SILICA STORAGE BIN	26	WALES26
**	ANIMAL FEED INGREDIENT GRANULATION PLANT	27	WALES27
**	ANIMAL FEED STORAGE SILOS (3) - "B SIDE"	28	WALES28
**	#1 FERTILIZER RAIL/TRUCK SHIPPING	29	WALES29
**	MULTIFOS SODA ASH CONVEYING SYSTEM W/BAGHOUSE	31	WALES31
**	MULTIFOS "A" KILN COOLER W/BAGHOUSE	32	WALES32
**	MULTIFOS "B" KILN COOLER W/BAGHOUSE	33	WALES33
**	MULTIFOS PLANT MILLING & SIZING SYSTEM WEST BAGHOUSE	34	WALES34
**	MULTIFOS MILLING & SIZING SYSTEM EAST BAGHOUSE	35	WALES35
**	MULTIFOS PRODUCTION 1 DRYER 2 KILNS (A/B) FOR MULTIF	36	WALES36
**	MAP/DAP #2 TRUCK LOADOUT	37	WALES37
**	MULTIFOS MILLING & SIZING SYST SURGE BIN BAGHOUSE	38	WALES38
**	GTSP TRUCK LOADOUT FACILITY W/BAGHOUSE	41	WALES41
**	MAP/DAP NO. 2 RAIL LOADOUT	43	WALES43
**	DAP PLANT II - EAST TRAIN	45	WALES45
**	DAP PLANT II - WEST TRAIN	46	WALES46
**	DAP II WEST PRODUCT COOLER	47	WALES47
**	URANIUM RECOVERY ACID CLEANUP SCRUBBER	48	WALES48
**	URANIUM REFINERY W/BAGHOUSE	50	WALES50
**	URANIUM RECOVERY - CLAY STORAGE BIN	51	WALES51
**	ANIMAL FEED - LIMESTONE FEED BIN	52	WALES52
**	DAP PLANT #1 PRODUCT COOLER	54	WALES54
**	MAP PLANT COOLER	55	WALES55
**	DAP II EAST PRODUCT COOLER	56	WALES56
**	GTSP RAILCAR LOADOUT FACILITY W/ BAGHOUSE	59	WALES59
**	LIMESTONE STORAGE SILO WITH BAGHOUSE.	70	WALES70
**	KILN C SCRUBBER STACK - MULTIFOS PLANT	74	WALES74
**	MULTIFOS KILN C COOLER BAGHOUSE	75	WALES75
**	MULTIFOS KILN C MILLING & SIZING BAGHOUSE	76	WALES76
**1050003	Lakeland Electric, Larsen Power Plant		
**	Steam Generator # 6	3	LARPWR3
**	Steam Generator # 7	4	LARPWR4
**	Peaking Gas Turbine # 3	5	LARPWR5
**	Peaking Gas Turbine # 2	6	LARPWR6
**	Combined Cycle CT	8	LARPWR8
**1050221	Auburndale Power Partners, LP		
**	Proposed Peaker Project CT(Phase I)		CALPEAK
**	Existing CT (100% load/92o F Temp.)	1	CALEXT1
**1050004	Lakeland Electric, C.D. McIntosh, Jr. Power Plant		
**	McIntosh Unit 1	1	MCINT1
**	Diesel Engine Peaking Unit 2	2	MCINT2
**	Diesel Engine Peaking Unit 3	3	MCINT3
**	Gas Turbine Peaking Unit 1	4	MCINT4
**	McIntosh Unit 2	5	MCINT5
**	McIntosh Unit 3	6	MCINT6
**	Combustion Turbine Unit 5	28	MCINT28
**1050023	Cutrale Citrus Juices USA, Inc		
**	Citrus Feed Mill Dryer	1	CCJUSA1
**	Peel Dryer	3	CCJUSA3
**	Cooling Reel Stack N.1n	5	CCJUSA5
**	Cooling Reel Stack N. 2c	6	CCJUSA6
**	Cooling Reel Stack N. 3s	7	CCJUSA7
**0570025	Trademark Nitrogen Corp		
**	Nitric Acid Plant W/ 2 Absorption Towers	1	TRADE1
**0570039	TECO - Big Bend Station		
**	Unit #1 Coal Fired Boiler w/ ESP	1	TECOBB1
**	Unit #2 Riley-Stoker Coal Boiler w/ Esp	2	TECOBB2
**	Unit #3 Riley-Stoker Coal Boiler w/ ESP	3	TECOBB3
**	Unit #4 Coal Boiler W/ Belco ESP Psd-Fl-040	4	TECOBB4
**	Combustion Turbine #2 - No. 2 Fuel Oil	5	TECOBB5
**	Gas Turbine #3 - No. 2 Fuel Oil	6	TECOBB6
**	Gas Turbine #1 No. 2 Fuel Oil	7	TECOBB7
**	Unit No. 1 & No. 2 Fly Ash Silo w/Baghouse	8	TECOBB8
**	Fly-Ash Silo For Unit #3	9	TECOBB9

**	Limestone Silo A W/ 2 Baghouses	12	TECOBB12
**	Limestone Silo B W/ 2 Baghouses	13	TECOBB13
**	Flyash Silo For Unit #4	14	TECOBB14
**	Unit 1 Coal Bunker W/Roto-Clone	15	TECOBB15
**	Unit 2 Coal Bunker W/Roto-Clone	16	TECOBB16
**	Unit 3 Coal Bunker W/Roto-Clone	17	TECOBB17
**0810010	Florida Power & Light - Manatee		
**	Combined Facility		FPLMAN1
**0570040	TECO Gannon		
**	Unit #1 Steam Generator	1	TECOGN1
**	Unit #2	2	TECOGN2
**	Unit #3 Coal Fired Boiler	3	TECOGN3
**	Unit#4 Coal Fired Boiler	4	TECOGN4
**	Unit #5 Coal Fired Boiler	5	TECOGN5
**	Unit #6 - Coal Fired Boiler With ESP	6	TECOGN6
**	Gas Fired Turbine	7	TECOGN7
**	Economizer Ash Silo	9	TECOGN8
**	Flyash Silo No. 1 For Units 5 & 6	10	TECOGN9
**	Fly Ash Silo No. 2 Units 1-4	11	TECOGN11
**	Unit 1 Coal Bunker W/Roto-Clone	13	TECOGN13
**	Unit 2 Coal Bunker W/Roto-Clone	14	TECOGN14
**	Unit 3 Coal Bunker W/Roto-Clone	15	TECOGN15
**	Unit 4 Coal Bunker W/Roto-Clone	16	TECOGN16
**	Unit 5 Coal Bunker W/Roto-Clone	17	TECOGN17
**	Unit 6 Coal Bunker W/Roto-Clone	18	TECOGN18
**0570038	TECO, Hookers Point		
**	Boiler #1	1	TECOHK1
**	Boiler #2	2	TECOHK2
**	Boiler #3	3	TECOHK3
**	Boiler #4	4	TECOHK4
**	Boiler #5	5	TECOHK5
**	Boiler #6	6	TECOHK6
**0970014	FPC - Intercession City Plant		
**	Combined CTs 1-6	1-6	INTCP16
**	Combined CTs 7-10	7-10	INTCP710
**	CT # 11	11	INTCP11
**1030244	A-American Rent All		
**	Concrete Batching Plant	1	AAMER1
**1010017	FLORIDA POWER CORP., ANCLOTE POWER PLANT		
**	Steam Turbine Gen. Anclothe Unit No.1	1	FPCANC1
**	525 Mw #6 Oil Fired Steam Generator	2	FPCANC2
**			

\*\*\*\*\*

**	CF Industries, Inc. - Bartow		
SO LOCATION	CFIBR2	POINT	-1200 2400
SO LOCATION	CFIBR21	POINT	-1200 2400
SO LOCATION	CFIBR25	POINT	-1200 2400
SO LOCATION	CFIBRMS	POINT	-1200 2400

**	Polk Power Partners, L.P. Mulberry - Mulberry Cogen Facility		
SO LOCATION	MCF1	POINT	4100 500
SO LOCATION	MCF2	POINT	4100 500

**	Parallel Products Of Florida		
SO LOCATION	PPF1	POINT	4350 600
SO LOCATION	PPF2	POINT	4350 600
SO LOCATION	PPF3	POINT	4350 600

**	Cargill Fertilizer - Bartow		
SO LOCATION	CFBAR1	POINT	300 6500
SO LOCATION	CFBAR2	POINT	300 6500
SO LOCATION	CFBAR3	POINT	300 6500
SO LOCATION	CFBAR4	POINT	300 6500

\*\* U S Agri-Chemicals - Bartow

SO LOCATION	USAGBR38	POINT	3700	6200
SO LOCATION	USAGBR39	POINT	3700	6200

\*\* Hines Energy Complex (Progress Energy)

SO LOCATION	HINES1	POINT	4840	-6190
SO LOCATION	HINES2	POINT	4840	-6190
SO LOCATION	HINES3	POINT	4840	-6190
SO LOCATION	HINESAX	POINT	4840	-6190
SO LOCATION	HINESEG	POINT	4840	-6190

\*\* IMC - Agrico Co. (South Pierce)

SO LOCATION	IMCPIER1	POINT	-2000	-8700
SO LOCATION	IMCPIE23	POINT	-2000	-8700
SO LOCATION	IMCPIE24	POINT	-2000	-8700
SO LOCATION	IMCPIE25	POINT	-2000	-8700

\*\* Bartow Ethanol, Inc.

SO LOCATION	BRTEETH1	POINT	9250	-1260
-------------	----------	-------	------	-------

\*\* IMC-Agrico Co. (Prairie)

SO LOCATION	IMCPR1	POINT	-6600	6900
SO LOCATION	IMCPR2	POINT	-6600	6900
SO LOCATION	IMCPR3	POINT	-6600	6900
SO LOCATION	IMCPR4	POINT	-6600	6900
SO LOCATION	IMCPR5	POINT	-6600	6900
SO LOCATION	IMCPR6	POINT	-6600	6900
SO LOCATION	IMCPR7	POINT	-6600	6900

\*\* IMC Phosphates (Nichols)

SO LOCATION	IMCNIC1	POINT	-11100	4100
SO LOCATION	IMCNIC2	POINT	-11100	4100
SO LOCATION	IMCNIC3	POINT	-11100	4100
SO LOCATION	IMCNIC4	POINT	-11100	4100
SO LOCATION	IMCNIC9	POINT	-11100	4100
SO LOCATION	IMCNIC10	POINT	-11100	4100
SO LOCATION	IMCNIC12	POINT	-11100	4100
SO LOCATION	IMCNIC15	POINT	-11100	4100
SO LOCATION	IMCNIC16	POINT	-11100	4100
SO LOCATION	IMCNIC19	POINT	-11100	4100
SO LOCATION	IMCNIC21	POINT	-11100	4100

\*\* Agrifos Mining, L.L.C. - Nichols

SO LOCATION	AGRNIC1	POINT	-10800	5200
SO LOCATION	AGRNIC2	POINT	-10800	5200
SO LOCATION	AGRNIC10	POINT	-10800	5200
SO LOCATION	AGRNIC11	POINT	-10800	5200

\*\* IMC-Agrico Co. (CFMO) Noralyn

SO LOCATION	IMCFMO11	POINT	-11300	-4400
SO LOCATION	IMCFMO12	POINT	-11300	-4400
SO LOCATION	IMCFMO13	POINT	-11300	-4400
SO LOCATION	IMCFMO14	POINT	-11300	-4400
SO LOCATION	IMCFMO15	POINT	-11300	-4400
SO LOCATION	IMCFMO16	POINT	-11300	-4400
SO LOCATION	IMCFMO17	POINT	-11300	-4400
SO LOCATION	IMCFMO18	POINT	-11300	-4400
SO LOCATION	IMCFMO19	POINT	-11300	-4400
SO LOCATION	IMCFMO20	POINT	-11300	-4400
SO LOCATION	IMCFMO21	POINT	-11300	-4400
SO LOCATION	IMCFMO22	POINT	-11300	-4400
SO LOCATION	IMCFMO23	POINT	-11300	-4400
SO LOCATION	IMCFMO24	POINT	-11300	-4400

\*\* IMC Phosphates (CFMO)

SO LOCATION	IMCFMO2	POINT	-11300	-4400
SO LOCATION	IMCFMO3	POINT	-11300	-4400
SO LOCATION	IMCFMO4	POINT	-11300	-4400
SO LOCATION	IMCFMO5	POINT	-11300	-4400
SO LOCATION	IMCFMO6	POINT	-11300	-4400
SO LOCATION	IMCFMO8	POINT	-11300	-4400
SO LOCATION	IMCFMO9	POINT	-11300	-4400
SO LOCATION	IMCFMO10	POINT	-11300	-4400

\*\* IMC-AGRICO CO. (NEW WALES)

SO LOCATION	WALES5	POINT	-12800	-700
SO LOCATION	WALES6	POINT	-12800	-700
SO LOCATION	WALES9	POINT	-12800	-700
SO LOCATION	WALES10	POINT	-12800	-700
SO LOCATION	WALES11	POINT	-12800	-700
SO LOCATION	WALES12	POINT	-12800	-700
SO LOCATION	WALES15	POINT	-12800	-700
SO LOCATION	WALES21	POINT	-12800	-700
SO LOCATION	WALES23	POINT	-12800	-700
SO LOCATION	WALES24	POINT	-12800	-700
SO LOCATION	WALES25	POINT	-12800	-700
SO LOCATION	WALES26	POINT	-12800	-700
SO LOCATION	WALES27	POINT	-12800	-700
SO LOCATION	WALES28	POINT	-12800	-700
SO LOCATION	WALES29	POINT	-12800	-700
SO LOCATION	WALES31	POINT	-12800	-700
SO LOCATION	WALES32	POINT	-12800	-700
SO LOCATION	WALES33	POINT	-12800	-700
SO LOCATION	WALES34	POINT	-12800	-700
SO LOCATION	WALES35	POINT	-12800	-700
SO LOCATION	WALES36	POINT	-12800	-700
SO LOCATION	WALES37	POINT	-12800	-700
SO LOCATION	WALES38	POINT	-12800	-700
SO LOCATION	WALES41	POINT	-12800	-700
SO LOCATION	WALES43	POINT	-12800	-700
SO LOCATION	WALES45	POINT	-12800	-700
SO LOCATION	WALES46	POINT	-12800	-700
SO LOCATION	WALES47	POINT	-12800	-700
SO LOCATION	WALES48	POINT	-12800	-700
SO LOCATION	WALES50	POINT	-12800	-700
SO LOCATION	WALES51	POINT	-12800	-700
SO LOCATION	WALES52	POINT	-12800	-700
SO LOCATION	WALES54	POINT	-12800	-700
SO LOCATION	WALES55	POINT	-12800	-700
SO LOCATION	WALES56	POINT	-12800	-700
SO LOCATION	WALES59	POINT	-12800	-700
SO LOCATION	WALES70	POINT	-12800	-700
SO LOCATION	WALES74	POINT	-12800	-700
SO LOCATION	WALES75	POINT	-12800	-700
SO LOCATION	WALES76	POINT	-12800	-700

\*\* Lakeland Electric, Larsen Power Plant

SO LOCATION	LARPWR3	POINT	-600	22400
SO LOCATION	LARPWR4	POINT	-600	22400
SO LOCATION	LARPWR5	POINT	-600	22400
SO LOCATION	LARPWR6	POINT	-600	22400
SO LOCATION	LARPWR8	POINT	-600	22400

\*\* Auburndale Power Partners, LP

SO LOCATION	CALPEAK	POINT	11300	23200
SO LOCATION	CALEXT1	POINT	11300	23200

\*\* Lakeland Electric, C.D. McIntosh, Jr. Power Plant

SO LOCATION	MCINT1	POINT	-500	26100
SO LOCATION	MCINT2	POINT	-500	26100

SO LOCATION	MCINT3	POINT	-500	26100
SO LOCATION	MCINT4	POINT	-500	26100
SO LOCATION	MCINT5	POINT	-500	26100
SO LOCATION	MCINT6	POINT	-500	26100
SO LOCATION	MCINT28	POINT	-500	26100

\*\* Cutrale Citrus Juices USA, Inc

SO LOCATION	CCJUSA1	POINT	12100	23600
SO LOCATION	CCJUSA3	POINT	12100	23600
SO LOCATION	CCJUSA5	POINT	12100	23600
SO LOCATION	CCJUSA6	POINT	12100	23600
SO LOCATION	CCJUSA7	POINT	12100	23600

\*\* Trademark Nitrogen Corp

SO LOCATION	TRADE1	POINT	-42200	12500
-------------	--------	-------	--------	-------

\*\* TECO - Big Bend Station

SO LOCATION	TECOBB1	POINT	-47600	-5100
SO LOCATION	TECOBB2	POINT	-47600	-5100
SO LOCATION	TECOBB3	POINT	-47600	-5100
SO LOCATION	TECOBB4	POINT	-47600	-5100
SO LOCATION	TECOBB5	POINT	-47600	-5100
SO LOCATION	TECOBB6	POINT	-47600	-5100
SO LOCATION	TECOBB7	POINT	-47600	-5100
SO LOCATION	TECOBB8	POINT	-47600	-5100
SO LOCATION	TECOBB9	POINT	-47600	-5100
SO LOCATION	TECOBB12	POINT	-47600	-5100
SO LOCATION	TECOBB13	POINT	-47600	-5100
SO LOCATION	TECOBB14	POINT	-47600	-5100
SO LOCATION	TECOBB15	POINT	-47600	-5100
SO LOCATION	TECOBB16	POINT	-47600	-5100
SO LOCATION	TECOBB17	POINT	-47600	-5100

\*\* Florida Power & Light - Manatee

SO LOCATION	FPLMAN1	POINT	-42250	-25950
-------------	---------	-------	--------	--------

\*\* TECO Gannon

SO LOCATION	TECOGN1	POINT	-49400	7400
SO LOCATION	TECOGN2	POINT	-49400	7400
SO LOCATION	TECOGN3	POINT	-49400	7400
SO LOCATION	TECOGN4	POINT	-49400	7400
SO LOCATION	TECOGN5	POINT	-49400	7400
SO LOCATION	TECOGN6	POINT	-49400	7400
SO LOCATION	TECOGN7	POINT	-49400	7400
SO LOCATION	TECOGN8	POINT	-49400	7400
SO LOCATION	TECOGN9	POINT	-49400	7400
SO LOCATION	TECOGN11	POINT	-49400	7400
SO LOCATION	TECOGN13	POINT	-49400	7400
SO LOCATION	TECOGN14	POINT	-49400	7400
SO LOCATION	TECOGN15	POINT	-49400	7400
SO LOCATION	TECOGN16	POINT	-49400	7400
SO LOCATION	TECOGN17	POINT	-49400	7400
SO LOCATION	TECOGN18	POINT	-49400	7400

\*\* TECO, Hookers Point

SO LOCATION	TECOHK1	POINT	-51500	10900
SO LOCATION	TECOHK2	POINT	-51500	10900
SO LOCATION	TECOHK3	POINT	-51500	10900
SO LOCATION	TECOHK4	POINT	-51500	10900
SO LOCATION	TECOHK5	POINT	-51500	10900
SO LOCATION	TECOHK6	POINT	-51500	10900

\*\* FPC - Intercession City Plant

SO LOCATION	INTCP16	POINT	36800	45900
SO LOCATION	INTCP710	POINT	36800	45900



SO LOCATION INTCP11 POINT 36800 45900

\*\* A-American Rent All

SO LOCATION AAMER1 POINT -85400 -900

\*\* FLORIDA POWER CORP., ANCLOTE POWER PLANT

SO LOCATION FPCANC1 POINT -85100 38600

SO LOCATION FPCANC2 POINT -85100 38600

\*\*\*\*\*SOURCE PARAMETERS\*\*\*\*\*

\*\* CF Industries, Inc. - Bartow

SO SRCPARAM CFIBR2 0.014 42.67 298 21.6 0.76

SO SRCPARAM CFIBR21 0.063 10.97 589 13.4 0.76

SO SRCPARAM CFIBR25 0.014 41.15 298 7.6 1.52

SO SRCPARAM CFIBRMS 0.046 9.14 293 0.1 0.1

\*\* Polk Power Partners, L.P. Mulberry - Mulberry Cogen Facility

SO SRCPARAM MCF1 0.970 38.10 378 19.5 4.57

SO SRCPARAM MCF2 0.100 38.10 378 20.3 0.91

\*\* Parallel Products Of Florida

SO SRCPARAM PPF1 0.013 9.14 300 11.4 0.61

SO SRCPARAM PPF2 0.021 12.19 300 15.2 0.34

SO SRCPARAM PPF3 0.882 12.19 364 21.6 0.46

\*\* Cargill Fertilizer - Bartow

SO SRCPARAM CFBAR1 1.462 43.3 344 24.1 2.29

SO SRCPARAM CFBAR2 2.268 42.7 329 12.8 3.35

SO SRCPARAM CFBAR3 1.512 24.4 297 11.4 0.70

SO SRCPARAM CFBAR4 1.328 39.0 305 11.6 1.49

\*\* U S Agri-Chemicals - Bartow

SO SRCPARAM USAGBR38 4.862 39.93 316 17.2 2.13

SO SRCPARAM USAGBR39 2.860 22.25 298 24.7 0.85

\*\* Hines Energy Complex (Progress Energy)

SO SRCPARAM HINES1 5.645 91.44 429 36.3 2.74

SO SRCPARAM HINES2 8.165 38.10 405 21.2 5.79

SO SRCPARAM HINES3 8.165 38.10 405 21.2 5.49

SO SRCPARAM HINESAX 0.617 18.29 440 32.3 0.76

SO SRCPARAM HINESEG 0.060 7.62 800 43.6 0.46

\*\* IMC - Agrico Co. (South Pierce)

SO SRCPARAM IMCPIER1 0.222 10.67 494 15.5 1.46

SO SRCPARAM IMCPIE23 4.410 42.67 316 11.0 2.74

SO SRCPARAM IMCPIE24 5.053 24.38 305 7.6 3.35

SO SRCPARAM IMCPIE25 5.053 24.38 305 7.8 3.35

\*\* Bartow Ethanol, Inc.

SO SRCPARAM BRTEH1 8.094 10.97 450 20.1 0.91

\*\* IMC-Agrico Co. (Prairie)

SO SRCPARAM IMCPR1 4.070 27.43 311 12.8 0.30

SO SRCPARAM IMCPR2 1.890 22.86 328 24.1 0.34

SO SRCPARAM IMCPR3 2.419 22.86 328 40.5 0.34

SO SRCPARAM IMCPR4 4.082 21.34 358 15.5 1.34

SO SRCPARAM IMCPR5 2.419 19.81 333 10.1 0.61

SO SRCPARAM IMCPR6 0.019 15.24 299 23.2 0.15

SO SRCPARAM IMCPR7 0.302 22.86 328 53.3 0.34

\*\* IMC Phosphates (Nichols)

SO SRCPARAM IMCNIC1 4.914 12.80 311 10.36 1.22

SO SRCPARAM IMCNIC2 1.386 15.85 322 20.12 0.76

SO SRCPARAM IMCNIC3 1.386 24.38 328 23.77 1.07

SO SRCPARAM IMCNIC4 1.386 21.95 361 30.78 0.98

SO SRCPARAM	IMCNIC9	0.630	63.09	330	21.03	0.43
SO SRCPARAM	IMCNIC10	0.630	63.09	330	21.03	0.43
SO SRCPARAM	IMCNIC12	4.440	24.69	328	3.66	2.29
SO SRCPARAM	IMCNIC15	0.045	8.23	533	13.72	0.61
SO SRCPARAM	IMCNIC16	0.091	11.89	533	8.84	0.98
SO SRCPARAM	IMCNIC19	1.386	63.09	333	51.21	0.27
SO SRCPARAM	IMCNIC21	0.050	1.83	298	3.54	0.23

\*\* Agrifos Mining, L.L.C. - Nichols

SO SRCPARAM	AGRNIC1	4.801	24.38	344	12.5	2.29
SO SRCPARAM	AGRNIC2	4.801	24.38	344	12.5	2.29
SO SRCPARAM	AGRNIC10	5.040	25.91	300	14.3	1.68
SO SRCPARAM	AGRNIC11	4.158	25.91	297	19.2	1.52

\*\* IMC-Agrico Co. (CFMO) Noralyn

SO SRCPARAM	IMCFMO11	5.317	23.16	394	17.31	1.98
SO SRCPARAM	IMCFMO12	5.683	16.76	341	8.84	2.83
SO SRCPARAM	IMCFMO13	4.410	45.72	311	15.85	1.07
SO SRCPARAM	IMCFMO14	1.890	7.32	316	8.08	0.61
SO SRCPARAM	IMCFMO15	1.260	7.32	316	8.08	0.61
SO SRCPARAM	IMCFMO16	1.260	7.62	297	11.49	0.46
SO SRCPARAM	IMCFMO17	1.260	8.23	297	4.85	0.61
SO SRCPARAM	IMCFMO18	1.260	7.62	298	11.49	0.46
SO SRCPARAM	IMCFMO19	1.260	8.84	298	6.00	0.55
SO SRCPARAM	IMCFMO20	1.890	8.23	303	16.18	0.61
SO SRCPARAM	IMCFMO21	1.890	8.23	300	21.88	0.58
SO SRCPARAM	IMCFMO22	1.260	12.19	311	14.39	0.46
SO SRCPARAM	IMCFMO23	1.890	13.11	303	8.08	0.61
SO SRCPARAM	IMCFMO24	1.890	41.15	289	16.76	0.85

\*\* IMC Phosphates (CFMO)

SO SRCPARAM	IMCFMO2	4.221	18.29	316	19.51	0.76
SO SRCPARAM	IMCFMO3	3.780	17.68	311	14.94	0.58
SO SRCPARAM	IMCFMO4	5.569	21.34	347	14.33	2.13
SO SRCPARAM	IMCFMO5	2.520	32.31	308	20.42	0.76
SO SRCPARAM	IMCFMO6	2.520	10.67	297	10.06	0.76
SO SRCPARAM	IMCFMO8	0.007	7.92	478	7.16	0.29
SO SRCPARAM	IMCFMO9	0.016	37.19	298	8.99	0.18
SO SRCPARAM	IMCFMO10	0.173	37.19	298	6.83	0.18

\*\* IMC-AGRICO CO. (NEW WALES)

SO SRCPARAM	WALES5	0.806	12.2	315	17.678	0.914
SO SRCPARAM	WALES6	0.164	33.5	316	13.716	0.427
SO SRCPARAM	WALES9	3.604	40.5	314	14.935	2.134
SO SRCPARAM	WALES10	4.253	40.5	325	25.329	1.829
SO SRCPARAM	WALES11	1.890	36.6	341	17.374	1.219
SO SRCPARAM	WALES12	3.616	40.5	315	18.593	1.829
SO SRCPARAM	WALES15	0.136	19.8	314	51.511	0.305
SO SRCPARAM	WALES21	0.605	25.0	314	16.154	0.305
SO SRCPARAM	WALES23	0.599	34.7	314	10.058	0.305
SO SRCPARAM	WALES24	0.454	31.4	314	42.672	0.305
SO SRCPARAM	WALES25	0.454	36.3	314	38.710	0.305
SO SRCPARAM	WALES26	0.202	5.5	314	9.449	0.305
SO SRCPARAM	WALES27	4.637	52.4	328	20.208	2.438
SO SRCPARAM	WALES28	0.599	34.7	314	10.058	0.305
SO SRCPARAM	WALES29	0.592	40.5	305	12.924	0.914
SO SRCPARAM	WALES31	0.454	32.9	300	9.449	0.244
SO SRCPARAM	WALES32	0.970	26.2	378	78.638	0.457
SO SRCPARAM	WALES33	0.970	26.2	408	68.580	0.457
SO SRCPARAM	WALES34	0.118	21.6	325	26.518	0.518
SO SRCPARAM	WALES35	0.118	21.6	311	77.114	0.305
SO SRCPARAM	WALES36	3.759	52.4	314	15.850	1.372
SO SRCPARAM	WALES37	0.454	3.0	311	20.726	0.549
SO SRCPARAM	WALES38	0.945	19.8	311	24.079	0.335
SO SRCPARAM	WALES41	0.630	3.0	311	54.559	0.457

SO SRCPARAM	WALES43	0.454	3.0	314	21.336	0.488
SO SRCPARAM	WALES45	0.806	52.1	316	17.678	1.829
SO SRCPARAM	WALES46	0.806	52.1	316	17.678	1.829
SO SRCPARAM	WALES47	0.532	44.8	353	21.001	1.311
SO SRCPARAM	WALES48	0.126	18.3	300	9.510	1.067
SO SRCPARAM	WALES50	0.189	30.5	312	11.278	0.549
SO SRCPARAM	WALES51	0.189	26.2	300	16.459	0.213
SO SRCPARAM	WALES52	0.599	34.7	314	10.058	0.305
SO SRCPARAM	WALES54	0.970	32.6	339	23.470	1.067
SO SRCPARAM	WALES55	0.648	7.6	333	10.363	1.311
SO SRCPARAM	WALES56	0.764	51.8	316	19.660	1.524
SO SRCPARAM	WALES59	0.630	3.0	311	21.001	0.457
SO SRCPARAM	WALES70	0.088	33.5	316	34.503	0.229
SO SRCPARAM	WALES74	1.802	52.4	314	21.397	1.372
SO SRCPARAM	WALES75	0.239	26.2	394	32.339	0.914
SO SRCPARAM	WALES76	0.239	27.4	328	34.503	0.457

\*\* Lakeland Electric, Larsen Power Plant

SO SRCPARAM	LARPWR3	3.906	50.29	444	6.4	3.05
SO SRCPARAM	LARPWR4	7.560	50.29	444	6.7	3.05
SO SRCPARAM	LARPWR5	1.000	9.45	700	30.8	3.60
SO SRCPARAM	LARPWR6	1.000	9.45	700	30.8	3.60
SO SRCPARAM	LARPWR8	3.276	47.24	523	26.1	4.88

\*\* Auburndale Power Partners, LP

SO SRCPARAM	CALPEAK	5.418	15.24	833	20.76	6.71
SO SRCPARAM	CALEXT1	4.637	48.77	411	17.68	5.49

\*\* Lakeland Electric, C.D. McIntosh, Jr. Power Plant

SO SRCPARAM	MCINT1	65.520	45.72	409	24.75	2.74
SO SRCPARAM	MCINT2	0.221	6.10	653	23.47	0.79
SO SRCPARAM	MCINT3	0.221	6.10	653	23.47	0.79
SO SRCPARAM	MCINT4	2.550	10.67	755	24.23	4.11
SO SRCPARAM	MCINT5	65.369	47.85	409	22.31	3.20
SO SRCPARAM	MCINT6	150.696	76.20	348	25.18	5.49
SO SRCPARAM	MCINT28	6.174	25.91	864	25.21	8.53

\*\* Cutrale Citrus Juices USA, Inc

SO SRCPARAM	CCJUSA1	4.145	28.35	333	16.8	1.07
SO SRCPARAM	CCJUSA3	4.145	30.48	345	14.9	0.98
SO SRCPARAM	CCJUSA5	2.520	10.06	311	17.4	0.76
SO SRCPARAM	CCJUSA6	2.520	10.06	311	17.4	0.76
SO SRCPARAM	CCJUSA7	2.520	10.36	305	14.9	0.82

\*\* Trademark Nitrogen Corp

SO SRCPARAM	TRADE1	42.084	15.24	450	5.45	0.52
-------------	--------	--------	-------	-----	------	------

\*\* TECO - Big Bend Station

SO SRCPARAM	TECOBB1	50.904	149.35	422	35.36	7.32
SO SRCPARAM	TECOBB2	50.400	149.35	422	35.36	7.32
SO SRCPARAM	TECOBB3	51.912	152.10	418	15.61	7.32
SO SRCPARAM	TECOBB4	16.380	152.10	342	17.98	7.32
SO SRCPARAM	TECOBB5	4.158	22.86	771	18.59	4.27
SO SRCPARAM	TECOBB6	4.158	22.86	771	18.59	4.27
SO SRCPARAM	TECOBB7	4.158	10.67	816	28.01	3.36
SO SRCPARAM	TECOBB8	0.650	31.09	394	15.85	0.76
SO SRCPARAM	TECOBB9	0.378	34.44	394	123.75	0.27
SO SRCPARAM	TECOBB12	0.006	30.78	339	14.02	0.15
SO SRCPARAM	TECOBB13	0.006	30.78	339	14.02	0.15
SO SRCPARAM	TECOBB14	0.025	42.37	333	17.98	0.49
SO SRCPARAM	TECOBB15	0.060	54.56	299	21.03	0.52
SO SRCPARAM	TECOBB16	0.060	54.56	299	21.03	0.52
SO SRCPARAM	TECOBB17	0.060	54.56	299	21.03	0.52

\*\* Florida Power & Light - Manatee

SO SRCPARAM FPLMAN1 217.980 144.78 426 23.62 7.99

\*\* TECO Gannon

SO SRCPARAM TECOGN1 15.876 96.01 409 37.93 3.05  
SO SRCPARAM TECOGN2 15.876 96.01 421 38.50 3.05  
SO SRCPARAM TECOGN3 20.160 96.01 406 34.60 3.23  
SO SRCPARAM TECOGN4 23.688 96.01 416 29.60 3.05  
SO SRCPARAM TECOGN5 28.728 96.01 418 50.74 4.45  
SO SRCPARAM TECOGN6 47.880 96.01 400 33.28 5.36  
SO SRCPARAM TECOGN7 15.372 10.67 816 28.22 3.35  
SO SRCPARAM TECOGN8 0.018 21.95 450 10.67 0.21  
SO SRCPARAM TECOGN9 0.151 32.61 450 30.18 0.30  
SO SRCPARAM TECOGN11 0.365 31.70 450 17.98 0.61  
SO SRCPARAM TECOGN13 0.024 53.34 299 21.34 0.52  
SO SRCPARAM TECOGN14 0.024 53.34 299 21.34 0.52  
SO SRCPARAM TECOGN15 0.024 53.95 299 15.24 0.61  
SO SRCPARAM TECOGN16 0.024 53.34 299 21.34 0.52  
SO SRCPARAM TECOGN17 0.024 53.04 299 24.08 0.37  
SO SRCPARAM TECOGN18 0.024 53.34 299 21.34 0.52

\*\* TECO, Hookers Point

SO SRCPARAM TECOHK1 4.700 85.34 453 24.99 3.44  
SO SRCPARAM TECOHK2 4.700 85.34 453 24.99 3.44  
SO SRCPARAM TECOHK3 6.476 85.34 445 19.11 3.66  
SO SRCPARAM TECOHK4 6.476 85.34 445 19.11 3.66  
SO SRCPARAM TECOHK5 9.614 85.34 453 24.99 3.44  
SO SRCPARAM TECOHK6 12.260 85.34 438 22.92 2.87

\*\* FPC - Intercession City Plant

SO SRCPARAM INTCP16 31.622 14.63 678 53.3 4.46  
SO SRCPARAM INTCP710 7.560 15.24 835 42.5 4.19  
SO SRCPARAM INTCP11 2.142 22.86 830 42.5 5.79

\*\* A-American Rent All

SO SRCPARAM AAMER1 63.000 1.52 305 3.19 0.61

\*\* FLORIDA POWER CORP., ANCLOTE POWER PLANT

SO SRCPARAM FPCANC1 78.183 152.10 433 18.90 7.32  
SO SRCPARAM FPCANC2 76.388 152.10 433 18.90 7.32

\*\* Building Parameters

SO BUILDHGT NAPFRGC-NAPFRGF 27.43 27.43 27.43 32.31 32.31 32.31  
SO BUILDHGT NAPFRGC-NAPFRGF 32.31 32.31 32.31 32.31 32.31 32.31  
SO BUILDHGT NAPFRGC-NAPFRGF 32.31 32.31 32.31 27.43 27.43 27.43  
SO BUILDHGT NAPFRGC-NAPFRGF 27.43 27.43 27.43 32.31 32.31 32.31  
SO BUILDHGT NAPFRGC-NAPFRGF 32.31 32.31 32.31 32.31 32.31 32.31  
SO BUILDHGT NAPFRGC-NAPFRGF 32.31 32.31 32.31 27.43 27.43 27.43  
SO BUILDWID NAPFRGC-NAPFRGF 37.35 40.87 43.14 30.27 32.12 33.00  
SO BUILDWID NAPFRGC-NAPFRGF 32.87 31.74 29.65 31.74 32.87 33.00  
SO BUILDWID NAPFRGC-NAPFRGF 32.12 30.27 27.50 40.87 37.35 32.70  
SO BUILDWID NAPFRGC-NAPFRGF 37.35 40.87 43.14 30.27 32.12 33.00  
SO BUILDWID NAPFRGC-NAPFRGF 32.87 31.74 29.65 31.74 32.87 33.00  
SO BUILDWID NAPFRGC-NAPFRGF 32.12 30.27 27.50 40.87 37.35 32.70

SO BUILDHGT NAPFMSC-NAPFMSF 27.43 27.43 32.31 32.31 32.31 32.31  
SO BUILDHGT NAPFMSC-NAPFMSF 32.31 32.31 32.31 32.31 32.31 32.31  
SO BUILDHGT NAPFMSC-NAPFMSF 32.31 32.31 32.31 27.43 27.43 27.43  
SO BUILDHGT NAPFMSC-NAPFMSF 27.43 27.43 32.31 32.31 32.31 32.31  
SO BUILDHGT NAPFMSC-NAPFMSF 32.31 32.31 32.31 32.31 32.31 32.31  
SO BUILDHGT NAPFMSC-NAPFMSF 32.31 32.31 32.31 27.43 27.43 27.43  
SO BUILDWID NAPFMSC-NAPFMSF 37.35 40.87 27.50 30.27 32.12 33.00  
SO BUILDWID NAPFMSC-NAPFMSF 32.87 31.74 29.65 31.74 32.87 33.00  
SO BUILDWID NAPFMSC-NAPFMSF 32.12 30.27 27.50 40.87 37.35 32.70  
SO BUILDWID NAPFMSC-NAPFMSF 37.35 40.87 27.50 30.27 32.12 33.00

SO BUILDWID	NAPFMSC-NAPFMSF	32.87	31.74	29.65	31.74	32.87	33.00
SO BUILDWID	NAPFMSC-NAPFMSF	32.12	30.27	27.50	40.87	37.35	32.70

SO BUILDHGT	SAPFAC-SAPFAF	27.43	27.43	32.31	32.31	32.31	32.31
SO BUILDHGT	SAPFAC-SAPFAF	32.31	32.31	32.31	32.31	32.31	32.31
SO BUILDHGT	SAPFAC-SAPFAF	32.31	34.14	34.14	34.14	27.43	27.43
SO BUILDHGT	SAPFAC-SAPFAF	27.43	27.43	32.31	32.31	32.31	32.31
SO BUILDHGT	SAPFAC-SAPFAF	32.31	32.31	32.31	32.31	32.31	32.31
SO BUILDHGT	SAPFAC-SAPFAF	32.31	27.43	27.43	27.43	27.43	27.43
SO BUILDWID	SAPFAC-SAPFAF	37.35	40.87	27.50	30.27	32.12	33.00
SO BUILDWID	SAPFAC-SAPFAF	32.87	31.74	29.65	31.74	32.87	33.00
SO BUILDWID	SAPFAC-SAPFAF	32.12	25.81	26.66	26.71	37.35	32.70
SO BUILDWID	SAPFAC-SAPFAF	37.35	40.87	27.50	30.27	32.12	33.00
SO BUILDWID	SAPFAC-SAPFAF	32.87	31.74	29.65	31.74	32.87	33.00
SO BUILDWID	SAPFAC-SAPFAF	32.12	44.11	43.14	40.87	37.35	32.70

SO BUILDHGT	SAPFBC-SAPFBF	27.43	27.43	32.31	32.31	32.31	32.31
SO BUILDHGT	SAPFBC-SAPFBF	32.31	32.31	32.31	32.31	32.31	32.31
SO BUILDHGT	SAPFBC-SAPFBF	32.31	32.31	32.31	27.43	27.43	27.43
SO BUILDHGT	SAPFBC-SAPFBF	27.43	27.43	32.31	32.31	32.31	32.31
SO BUILDHGT	SAPFBC-SAPFBF	32.31	32.31	32.31	32.31	32.31	32.31
SO BUILDHGT	SAPFBC-SAPFBF	32.31	32.31	32.31	27.43	27.43	27.43
SO BUILDWID	SAPFBC-SAPFBF	37.35	40.87	27.50	30.27	32.12	33.00
SO BUILDWID	SAPFBC-SAPFBF	32.87	31.74	29.65	31.74	32.87	33.00
SO BUILDWID	SAPFBC-SAPFBF	32.12	30.27	27.50	40.87	37.35	32.70
SO BUILDWID	SAPFBC-SAPFBF	37.35	40.87	27.50	30.27	32.12	33.00
SO BUILDWID	SAPFBC-SAPFBF	32.87	31.74	29.65	31.74	32.87	33.00
SO BUILDWID	SAPFBC-SAPFBF	32.12	30.27	27.50	40.87	37.35	32.70

SO BUILDHGT	DAPSHIP	34.14	34.14	34.14	34.14	34.14	34.14
SO BUILDHGT	DAPSHIP	34.14	24.38	24.38	32.31	32.31	32.31
SO BUILDHGT	DAPSHIP	32.31	32.31	34.14	34.14	34.14	34.14
SO BUILDHGT	DAPSHIP	34.14	34.14	34.14	34.14	34.14	34.14
SO BUILDHGT	DAPSHIP	34.14	24.38	24.38	32.31	32.31	32.31
SO BUILDHGT	DAPSHIP	32.31	32.31	34.14	34.14	34.14	34.14
SO BUILDWID	DAPSHIP	25.94	26.71	26.66	25.81	24.17	21.80
SO BUILDWID	DAPSHIP	18.77	28.86	25.01	31.74	32.87	33.00
SO BUILDWID	DAPSHIP	32.12	30.27	26.66	26.71	25.94	24.38
SO BUILDWID	DAPSHIP	25.94	26.71	26.66	25.81	24.17	21.80
SO BUILDWID	DAPSHIP	18.77	28.86	25.01	31.74	32.87	33.00
SO BUILDWID	DAPSHIP	32.12	30.27	26.66	26.71	25.94	24.38

SRCGROUP ALL

SO FINISHED

\*\*  
\*\*\*\*\*

\*\* ISCST3 Receptor Pathway

\*\*\*\*\*

\*\*

\*\*

RE STARTING

\*\* FENCELINE RECEPTORS AT 100 M SPACING

DISCCART -1829.22 -140.52  
DISCCART -1829.22 274.48  
DISCCART -2408.22 274.48  
DISCCART -2895.22 539.48  
DISCCART -2987.22 914.48  
DISCCART -2743.22 1099.48  
DISCCART -2408.22 1834.48  
DISCCART -1536.22 2072.48  
DISCCART -1433.22 2255.48  
DISCCART 549.78 2255.48  
DISCCART 499.78 1462.48

DISCCART 2069.78 1462.48  
DISCCART 2069.78 -122.52  
DISCCART 1799.78 -549.52  
DISCCART 1432.78 -549.52  
DISCCART 1186.78 -140.52  
DISCCART -1829.22 -57.52  
DISCCART -1829.22 25.48  
DISCCART -1829.22 108.48  
DISCCART -1829.22 191.48  
DISCCART -1925.72 274.48  
DISCCART -2022.22 274.48  
DISCCART -2118.72 274.48  
DISCCART -2215.22 274.48  
DISCCART -2311.72 274.48  
DISCCART -2489.39 318.65  
DISCCART -2570.55 362.81  
DISCCART -2651.72 406.98  
DISCCART -2732.89 451.15  
DISCCART -2814.05 495.31  
DISCCART -2918.22 633.23  
DISCCART -2941.22 726.98  
DISCCART -2964.22 820.73  
DISCCART -2926.22 960.73  
DISCCART -2865.22 1006.98  
DISCCART -2804.22 1053.23  
DISCCART -2706.00 1181.15  
DISCCART -2668.78 1262.81  
DISCCART -2631.55 1344.48  
DISCCART -2594.33 1426.15  
DISCCART -2557.11 1507.81  
DISCCART -2519.89 1589.48  
DISCCART -2482.66 1671.15  
DISCCART -2445.44 1752.81  
DISCCART -2321.02 1858.28  
DISCCART -2233.82 1882.08  
DISCCART -2146.62 1905.88  
DISCCART -2059.42 1929.68  
DISCCART -1972.22 1953.48  
DISCCART -1885.02 1977.28  
DISCCART -1797.82 2001.08  
DISCCART -1710.62 2024.88  
DISCCART -1623.42 2048.68  
DISCCART -1501.89 2133.48  
DISCCART -1467.55 2194.48  
DISCCART -1334.07 2255.48  
DISCCART -1234.92 2255.48  
DISCCART -1135.77 2255.48  
DISCCART -1036.62 2255.48  
DISCCART -937.47 2255.48  
DISCCART -838.32 2255.48  
DISCCART -739.17 2255.48  
DISCCART -640.02 2255.48  
DISCCART -540.87 2255.48  
DISCCART -441.72 2255.48  
DISCCART -342.57 2255.48  
DISCCART -243.42 2255.48  
DISCCART -144.27 2255.48  
DISCCART -45.12 2255.48  
DISCCART 54.03 2255.48  
DISCCART 153.18 2255.48  
DISCCART 252.33 2255.48  
DISCCART 351.48 2255.48  
DISCCART 450.63 2255.48  
DISCCART 543.53 2156.36  
DISCCART 537.28 2057.23

DISCCART 531.03 1958.11  
DISCCART 524.78 1858.98  
DISCCART 518.53 1759.86  
DISCCART 512.28 1660.73  
DISCCART 506.03 1561.61  
DISCCART 597.90 1462.48  
DISCCART 696.03 1462.48  
DISCCART 794.15 1462.48  
DISCCART 892.28 1462.48  
DISCCART 990.41 1462.48  
DISCCART 1088.53 1462.48  
DISCCART 1186.65 1462.48  
DISCCART 1284.78 1462.48  
DISCCART 1382.91 1462.48  
DISCCART 1481.03 1462.48  
DISCCART 1579.16 1462.48  
DISCCART 1677.28 1462.48  
DISCCART 1775.41 1462.48  
DISCCART 1873.53 1462.48  
DISCCART 1971.66 1462.48  
DISCCART 2069.78 1363.42  
DISCCART 2069.78 1264.36  
DISCCART 2069.78 1165.29  
DISCCART 2069.78 1066.23  
DISCCART 2069.78 967.17  
DISCCART 2069.78 868.11  
DISCCART 2069.78 769.04  
DISCCART 2069.78 669.98  
DISCCART 2069.78 570.92  
DISCCART 2069.78 471.86  
DISCCART 2069.78 372.79  
DISCCART 2069.78 273.73  
DISCCART 2069.78 174.67  
DISCCART 2069.78 75.61  
DISCCART 2069.78 -23.46  
DISCCART 2024.78 -193.69  
DISCCART 1979.78 -264.85  
DISCCART 1934.78 -336.02  
DISCCART 1889.78 -407.19  
DISCCART 1844.78 -478.35  
DISCCART 1708.03 -549.52  
DISCCART 1616.28 -549.52  
DISCCART 1524.53 -549.52  
DISCCART 1383.58 -467.72  
DISCCART 1334.38 -385.92  
DISCCART 1285.18 -304.12  
DISCCART 1235.98 -222.32  
DISCCART 1089.49 -140.52  
DISCCART 992.20 -140.52  
DISCCART 894.91 -140.52  
DISCCART 797.62 -140.52  
DISCCART 700.33 -140.52  
DISCCART 603.04 -140.52  
DISCCART 505.75 -140.52  
DISCCART 408.46 -140.52  
DISCCART 311.17 -140.52  
DISCCART 213.88 -140.52  
DISCCART 116.59 -140.52  
DISCCART 19.30 -140.52  
DISCCART -77.99 -140.52  
DISCCART -175.28 -140.52  
DISCCART -272.57 -140.52  
DISCCART -369.87 -140.52  
DISCCART -467.16 -140.52  
DISCCART -564.45 -140.52

DISCCART -661.74 -140.52  
DISCCART -759.03 -140.52  
DISCCART -856.32 -140.52  
DISCCART -953.61 -140.52  
DISCCART -1050.90 -140.52  
DISCCART -1148.19 -140.52  
DISCCART -1245.48 -140.52  
DISCCART -1342.77 -140.52  
DISCCART -1440.06 -140.52  
DISCCART -1537.35 -140.52  
DISCCART -1634.64 -140.52  
DISCCART -1731.93 -140.52  
\*\* RECEPTOR GRID FROM FENCELINE TO 2 KM AT 100 M SPACING  
DISCCART -2000.00 -2000.00  
DISCCART -2000.00 -1900.00  
DISCCART -2000.00 -1800.00  
DISCCART -2000.00 -1700.00  
DISCCART -2000.00 -1600.00  
DISCCART -2000.00 -1500.00

.  
.  
.  
DISCCART 2000.00 -400.00  
DISCCART 2000.00 -300.00  
DISCCART 2000.00 1500.00  
DISCCART 2000.00 1600.00  
DISCCART 2000.00 1700.00  
DISCCART 2000.00 1800.00  
DISCCART 2000.00 1900.00  
DISCCART 2000.00 2000.00  
\*\* RECEPTOR GRID FROM 2 TO 5 KM AT 250 M SPACING  
DISCCART -2000.00 2250.00  
DISCCART -2000.00 2500.00  
DISCCART -2000.00 2750.00  
DISCCART -2000.00 3000.00  
DISCCART -2000.00 3250.00  
DISCCART -2000.00 3500.00  
DISCCART -2000.00 3750.00

.  
.  
.  
DISCCART -5000.00 3250.00  
DISCCART -5000.00 3500.00  
DISCCART -5000.00 3750.00  
DISCCART -5000.00 4000.00  
DISCCART -5000.00 4250.00  
DISCCART -5000.00 4500.00  
DISCCART -5000.00 4750.00  
DISCCART -5000.00 5000.00

RE FINISHED

\*\*

\*\*\*\*\*

\*\* ISCST3 Meteorology Pathway

\*\*\*\*\*

\*\*

\*\*

ME STARTING

INPUTFIL C:\MET\tpatpa91.met

ANEMHGHT 22 FEET

SURFDATA 12842 1991 TAMPA/INT'L\_ARPT

UAIRDATA 12842 1991 TAMPA/RUSKIN

ME FINISHED

\*\*



\*\*\*\*\*  
\*\* ISCST3 Output Pathway  
\*\*\*\*\*  
\*\*  
\*\*  
OU STARTING  
RECTABLE ALLAVE SIXTH  
OU FINISHED

**EXAMPLE ISCST3 INPUT FILE  
PSD CLASS II INCREMENT ANALYSIS  
ANNUAL AVERAGE NO<sub>x</sub> IMPACTS**

CO STARTING  
 TITLEONE MOSAIC GREEN BAY NOX PSD CLASS II INCREMENT ANALYSIS, ISCST3, 8/23/05  
 TITLETWO TAMPA/RUSKIN METDATA, 1991-1995  
 MODELOPT DFAULT CONC RURAL  
 AVERTIME PERIOD  
 POLLUTID NOX  
 TERRHGTS FLAT  
 RUNORNOT RUN

CO FINISHED

\*\*

\*\*\*\*\*

\*\* ISCST3 Source Pathway

\*\*\*\*\*

\*\*

\*\*

SO STARTING

\*\*

\*\* MODELING ORIGIN IS THE SW CORNER OF THE DAP/MAP STORAGE BUILDING

\*\*

\*\*\*\*\*Project Sources\*\*\*\*\*

\*\* FUTURE SOURCES

LOCATION SAPFBF POINT 159.34 3.32  
 LOCATION NAPFMSF POINT 159.22 38.95

\*\* CURRENT SOURCES

LOCATION SAPFBC POINT 159.34 3.32  
 LOCATION NAPFMSC POINT 159.22 38.95

\*\* Source Parameters \*\*

\*\* Proposed future stack parameters and emissions

SRCPARAM SAPFBF 1.587 39.5 315. 16.04 2.29  
 SRCPARAM NAPFMSF 0.933 39.5 313. 20.79 2.29

\*\* Current stack parameters and emissions

SRCPARAM SAPFBC -0.105 39.5 315. 15.05 2.29  
 SRCPARAM NAPFMSC -0.143 39.5 313. 19.36 2.29

\*\*\*\*\*Other NOX Sources at Green Bay\*\*\*\*\*

\*\* SAP4 - SULFURIC ACID PLANT NO 4

\*\* SAP5 - SULFURIC ACID PLANT NO 5

\*\* SAP6 - SULFURIC ACID PLANT NO 6

LOCATION SAP4 POINT 225.11 292.88  
 LOCATION SAP5 POINT 365.44 317.16  
 LOCATION SAP6 POINT 467.82 210.88

SRCPARAM SAP4 1.323 30.6 355. 17.37 2.29  
 SRCPARAM SAP5 1.764 45.7 350. 14.96 2.44  
 SRCPARAM SAP6 1.726 45.7 352. 11.54 2.74

\*\*\*\*\*CARGILL GREEN BAY 1988 NOX BASELINE SOURCES\*\*\*\*\*

\*\* DESCRSRC - 1988 GRANULAR SOUTH MAIN DRYER STACK

\*\* DESCRSRC - 1988 NORTH DAP MAIN DRYER STACK

\*\* DESCRSRC SUPER ACID THERMINOL HEATER

\*\* DESCRSRC SULFURIC ACID PLANT NO 3

\*\* DESCRSRC SULFURIC ACID PLANT NO 4

LOCATION SDAPMAIB POINT 159.34 3.32  
 LOCATION NDAPMAIB POINT 159.22 38.95  
 LOCATION SATHEAT POINT 144.33 243.83  
 LOCATION SAP3 POINT 225.24 274.33  
 LOCATION SAP4B POINT 225.11 292.88

SRCPARAM NDAPMAIB -1.185 39.3 361. 10.50 2.29  
 SRCPARAM SDAPMAIB -0.429 39.3 333. 6.86 2.29

SRCPARAM	SATHEAT	-9.743	29.0	320.	4.40	1.68
SRCPARAM	SAP3	-0.976	30.5	345.	9.24	2.29
SRCPARAM	SAP4B	-0.934	30.5	324.	6.91	2.29

\*\*\*\*\* NOX INCREMENT CONSUMING SOURCES\*\*\*\*\*

\*\* POLK POWER PARTNERS, L.P.-MULBERRY

SO LOCATION	PPMCT1	POINT	4100.0	500.0
SO LOCATION	PPMBOIL	POINT	4100.0	500.0

\*\* CARGILL MULBERRY (formerly MULBERRY PHOSPHATES, INC.)

SO LOCATION	CMUL5	POINT	-2700.0	5000.0
SO LOCATION	CMUL9	POINT	-2700.0	5000.0

\*\* CARGILL FERTILIZER, INC.--BARTOW

SO LOCATION	CFBAR1	POINT	300.0	6500.0
SO LOCATION	CFBAR12	POINT	300.0	6500.0
SO LOCATION	CFBAR21	POINT	300.0	6500.0
SO LOCATION	CFBAR32	POINT	300.0	6500.0
SO LOCATION	CFBAR33	POINT	300.0	6500.0

\*\* FPC, HINES ENERGY COMPLEX (PROGRESS ENERGY)

SO LOCATION	HINES1	POINT	4840.0	-6190.0
SO LOCATION	HINES2	POINT	4840.0	-6190.0
SO LOCATION	HINES3	POINT	4840.0	-6190.0
SO LOCATION	HINES4	POINT	4840.0	-6190.0
SO LOCATION	HINES5	POINT	4840.0	-6190.0

\*\* IMC PHOSPHATES CO. (S. PIERCE)

SO LOCATION	IMCPIER1	POINT	-2000.0	-8700.0
SO LOCATION	IMCPIER4	POINT	-2000.0	-8700.0
SO LOCATION	IMCPIER5	POINT	-2000.0	-8700.0
SO LOCATION	IMCPIER23	POINT	-2000.0	-8700.0

\*\* ORANGE COGENERATION LIMITED PARTNERSHIP

SO LOCATION	ORANG1	POINT	9200.0	2900.0
SO LOCATION	ORANG2	POINT	9200.0	2900.0
SO LOCATION	ORANG3	POINT	9200.0	2900.0

\*\* AGRIFOS, L.L.C. (NICHOLS)

SO LOCATION	AGRNIC1	POINT	-10800.0	5200.0
SO LOCATION	AGRNIC2	POINT	-10800.0	5200.0

\*\* FLORIDA POWER CORPORATION--TIGER BAY

SO LOCATION	FPTIGR1	POINT	6800.0	-10800.0
SO LOCATION	FPTIGR2	POINT	6800.0	-10800.0
SO LOCATION	FPTIGR3	POINT	6800.0	-10800.0

\*\* IMC PHOSPHATES (NEW WALES)

SO LOCATION	IMCWAL27	POINT	-12800.0	-700.0
SO LOCATION	IMCWAL32	POINT	-12800.0	-700.0
SO LOCATION	IMCWAL33	POINT	-12800.0	-700.0
SO LOCATION	IMCWAL36	POINT	-12800.0	-700.0
SO LOCATION	IMCWAL74	POINT	-12800.0	-700.0

\*\* U.S. AGRI-CHEMICALS - FT. MEADE

SO LOCATION	AFMEAD6	POINT	6500.0	-11100.0
SO LOCATION	AFMEAD16	POINT	6500.0	-11100.0
SO LOCATION	AFMEAD17	POINT	6500.0	-11100.0
SO LOCATION	AFMEAD38	POINT	6500.0	-11100.0

\*\* TECO - POLK POWER STATION

SO LOCATION	TECOPK1	POINT	-7050.0	-12750.0
SO LOCATION	TECOPK3	POINT	-7050.0	-12750.0
SO LOCATION	TECOPK4	POINT	-7050.0	-12750.0

SO LOCATION	TECOPK9	POINT	-7050.0	-12750.0
SO LOCATION	TECOPK10	POINT	-7050.0	-12750.0
** LAKELAND ELECTRIC - LARSON				
SO LOCATION	LARS1	POINT	-600.0	22400.0
SO LOCATION	LARS8	POINT	-600.0	22400.0
** HARDEE POWER PARTNERS, LTD				
SO LOCATION	HARD1	POINT	-4700.0	-22700.0
SO LOCATION	HARD2	POINT	-4700.0	-22700.0
SO LOCATION	HARD3	POINT	-4700.0	-22700.0
SO LOCATION	HARD5	POINT	-4700.0	-22700.0
** AUBURNDALE POWER PARTNERS, LP				
SO LOCATION	CALEXT1	POINT	11300.0	23200.0
** LAKELAND ELECTRIC - MCINTOSH				
SO LOCATION	MCINT5	POINT	-500.0	26100.0
SO LOCATION	MCINT6	POINT	-500.0	26100.0
SO LOCATION	MCINT28	POINT	-500.0	26100.0
** VANDOLAH POWER COMPANY, LLC				
SO LOCATION	VANDP1	POINT	-750.0	-35600.0
SO LOCATION	VANDP2	POINT	-750.0	-35600.0
SO LOCATION	VANDP3	POINT	-750.0	-35600.0
SO LOCATION	VANDP4	POINT	-750.0	-35600.0
** TECO - BIG BEND				
SO LOCATION	TECOBB4	POINT	-47600.0	-5100.0
** FPC-INTERCESSION CITY				
SO LOCATION	INTCT7	POINT	36800.0	45900.0
SO LOCATION	INTCT8	POINT	36800.0	45900.0
SO LOCATION	INTCT9	POINT	36800.0	45900.0
SO LOCATION	INTCT10	POINT	36800.0	45900.0
SO LOCATION	INTCT11	POINT	36800.0	45900.0
SO LOCATION	INTSC12	POINT	36800.0	45900.0
SO LOCATION	INTSC13	POINT	36800.0	45900.0
SO LOCATION	INTSC14	POINT	36800.0	45900.0
** IPS AVON PARK CORPORATION (DESOTO COUNTY)				
SO LOCATION	AVONP1	POINT	10250.0	-68600.0
SO LOCATION	AVONP2	POINT	10250.0	-68600.0
SO LOCATION	AVONP3	POINT	10250.0	-68600.0
** TROPICANA PRODUCTS, INC.-BRADENTON				
SO LOCATION	TROP15	POINT	-62700.0	-39200.0
SO LOCATION	TROP16	POINT	-62700.0	-39200.0
SO LOCATION	TROP21	POINT	-62700.0	-39200.0
SO LOCATION	TROP23	POINT	-62700.0	-39200.0
** PASCO COUNTY RESOURCE RECOVERY				
SO LOCATION	PASCO1	POINT	-60690.0	58670.0
SO LOCATION	PASCO2	POINT	-60690.0	58670.0
SO LOCATION	PASCO3	POINT	-60690.0	58670.0
SO LOCATION	PASCO5	POINT	-60690.0	58670.0
** FLORIDA CRUSHED STONE CO., INC.				
SO LOCATION	FCRUSH18	POINT	-49500.0	82400.0
SO LOCATION	FCRUSH20	POINT	-49500.0	82400.0
SO LOCATION	FCRUSH26	POINT	-49500.0	82400.0
** CENTRAL POWER & LIME, INC.				
SO LOCATION	CENTPLP	POINT	-49500.0	82400.0
SO LOCATION	CENTPL14	POINT	-49500.0	82400.0

\*\*\*\*\*SOURCE PARAMETERS\*\*\*\*\*

\*\* POLK POWER PARTNERS, L.P.-MULBERRY

SO SRCPARAM	PPMCT1	6.637	38.10	377.6	19.54	4.57
SO SRCPARAM	PPMBOIL	2.301	38.10	377.6	20.27	0.91

\*\* CARGILL MULBERRY (formerly MULBERRY PHOSPHATES, INC.)

SO SRCPARAM	CMUL5	0.529	31.09	316.5	7.92	2.68
SO SRCPARAM	CMUL9	3.015	13.72	299.8	2.44	1.13

\*\* CARGILL FERTILIZER, INC.--BARTOW

SO SRCPARAM	CFBAR1	0.679	30.18	330.4	16.15	2.29
SO SRCPARAM	CFBAR12	1.640	60.96	355.4	18.59	2.07
SO SRCPARAM	CFBAR21	0.679	42.67	328.7	16.15	3.32
SO SRCPARAM	CFBAR32	1.640	60.96	355.4	18.59	2.07
SO SRCPARAM	CFBAR33	1.640	60.96	355.4	18.59	2.07

\*\* FPC, HINES ENERGY COMPLEX (PROGRESS ENERGY)

SO SRCPARAM	HINES1	9.191	91.44	428.7	36.33	2.74
SO SRCPARAM	HINES2	9.191	38.10	405.4	21.15	5.79
SO SRCPARAM	HINES3	2.494	18.29	439.8	32.31	0.76
SO SRCPARAM	HINES4	6.678	7.62	799.8	43.59	0.46
SO SRCPARAM	HINES5	3.838	38.10	405.4	21.15	5.49

\*\* IMC PHOSPHATES CO. (S. PIERCE)

SO SRCPARAM	IMCPIER1	2.223	10.67	494.3	15.54	1.46
SO SRCPARAM	IMCPIER4	1.890	43.89	349.8	12.53	2.74
SO SRCPARAM	IMCPIER5	1.890	43.89	349.8	12.53	2.74
SO SRCPARAM	IMCPIER23	3.909	42.67	316.5	10.97	2.74

\*\* ORANGE COGENERATION LIMITED PARTNERSHIP

SO SRCPARAM	ORANG1	4.657	30.48	383.2	15.97	3.35
SO SRCPARAM	ORANG2	4.657	30.48	383.2	15.97	3.35
SO SRCPARAM	ORANG3	1.637	19.81	424.8	14.02	1.13

\*\* AGRIFOS, L.L.C. (NICHOLS)

SO SRCPARAM	AGRNIC1	4.511	24.38	344.3	12.50	2.29
SO SRCPARAM	AGRNIC2	4.436	24.38	344.3	12.50	2.29

\*\* FLORIDA POWER CORPORATION--TIGER BAY

SO SRCPARAM	FPTIGR1	20.399	54.86	369.3	19.20	5.79
SO SRCPARAM	FPTIGR2	0.038	21.34	444.3	19.20	0.40
SO SRCPARAM	FPTIGR3	0.863	12.19	433.2	11.80	1.22

\*\* IMC PHOSPHATES (NEW WALES)

SO SRCPARAM	IMCWAL27	5.260	52.43	327.6	20.21	2.44
SO SRCPARAM	IMCWAL32	2.553	26.21	377.6	78.64	0.46
SO SRCPARAM	IMCWAL33	2.553	26.21	407.6	68.58	0.46
SO SRCPARAM	IMCWAL36	0.570	52.43	313.7	15.85	1.37
SO SRCPARAM	IMCWAL74	1.008	52.43	313.7	21.40	1.37

\*\* U.S. AGRI-CHEMICALS - FT. MEADE

SO SRCPARAM	AFMEAD6	3.780	21.34	477.6	14.94	1.13
SO SRCPARAM	AFMEAD16	2.117	53.34	355.4	9.75	2.59
SO SRCPARAM	AFMEAD17	2.117	53.34	355.4	9.75	2.59
SO SRCPARAM	AFMEAD38	0.529	41.15	338.2	15.85	2.04

\*\* TECO - POLK POWER STATION

SO SRCPARAM	TECOPK1	83.663	45.72	444.3	23.10	5.79
SO SRCPARAM	TECOPK3	0.518	22.86	463.7	15.23	1.13
SO SRCPARAM	TECOPK4	0.134	0.76	355.4	18.29	0.76
SO SRCPARAM	TECOPK9	3.717	34.75	875.9	18.35	8.84
SO SRCPARAM	TECOPK10	3.717	34.75	875.9	18.35	8.84

\*\* LAKELAND ELECTRIC - LARSON

SO SRCPARAM	LARS1	-18.382	9.45	699.8	30.78	3.60
SO SRCPARAM	LARS8	12.226	47.24	522.6	26.12	4.88
** HARDEE POWER PARTNERS, LTD						
SO SRCPARAM	HARD1	48.358	27.43	386.5	23.62	4.42
SO SRCPARAM	HARD2	48.358	27.43	391.5	23.10	4.42
SO SRCPARAM	HARD3	48.358	22.86	803.2	28.74	5.46
SO SRCPARAM	HARD5	4.032	25.91	810.4	43.28	4.51
** AUBURNDALE POWER PARTNERS, LP						
SO SRCPARAM	CAEXT1	16.507	48.77	368.2	16.76	5.49
** LAKELAND ELECTRIC - MCINTOSH						
SO SRCPARAM	MCINT5	44.762	47.85	409.3	22.31	3.20
SO SRCPARAM	MCINT6	321.041	76.20	348.2	25.18	5.49
SO SRCPARAM	MCINT28	9.234	25.91	863.7	25.21	8.53
** VANDOLAH POWER COMPANY, LLC						
SO SRCPARAM	VANDP1	7.249	18.29	873.7	35.36	6.71
SO SRCPARAM	VANDP2	7.249	18.29	873.7	35.36	6.71
SO SRCPARAM	VANDP3	7.249	18.29	873.7	35.36	6.71
SO SRCPARAM	VANDP4	7.249	18.29	873.7	35.36	6.71
** TECO - BIG BEND						
SO SRCPARAM	TECOBB4	327.341	152.10	342.0	17.98	7.32
** FPC-INTERCESSION CITY						
SO SRCPARAM	INTCT7	8.874	15.24	834.8	53.07	4.19
SO SRCPARAM	INTCT8	8.874	15.24	834.8	53.07	4.19
SO SRCPARAM	INTCT9	8.874	15.24	834.8	53.07	4.19
SO SRCPARAM	INTCT10	8.874	15.24	834.8	53.07	4.19
SO SRCPARAM	INTCT11	16.286	22.86	829.8	42.49	5.79
SO SRCPARAM	INTSC12	2.402	17.07	773.7	35.84	4.91
SO SRCPARAM	INTSC13	2.402	17.07	807.0	35.84	4.91
SO SRCPARAM	INTSC14	2.402	17.07	807.0	35.84	4.91
** IPS AVON PARK CORPORATION (DESOTO COUNTY)						
SO SRCPARAM	AVONP1	7.249	22.86	873.7	35.36	6.71
SO SRCPARAM	AVONP2	7.249	22.86	873.7	35.36	6.71
SO SRCPARAM	AVONP3	7.249	22.86	873.7	35.36	6.71
** TROPICANA PRODUCTS, INC.-BRADENTON						
SO SRCPARAM	TROP15	2.307	22.86	555.4	14.81	1.52
SO SRCPARAM	TROP16	9.047	20.42	404.3	16.46	3.66
SO SRCPARAM	TROP21	1.230	12.19	422.0	4.88	0.52
SO SRCPARAM	TROP23	0.316	9.14	422.0	6.16	0.61
** PASCO COUNTY RESOURCE RECOVERY						
SO SRCPARAM	PASCO1	11.340	83.82	394.3	15.54	3.05
SO SRCPARAM	PASCO2	11.340	83.82	394.3	15.54	3.05
SO SRCPARAM	PASCO3	11.340	83.82	394.3	15.54	3.05
SO SRCPARAM	PASCO5	0.038	15.24	438.7	11.28	0.40
** FLORIDA CRUSHED STONE CO., INC.						
SO SRCPARAM	FCRUSH18	106.596	97.54	422.0	21.21	4.88
SO SRCPARAM	FCRUSH20	45.222	91.44	377.6	14.33	4.88
SO SRCPARAM	FCRUSH26	36.822	97.54	398.7	10.30	4.27
** CENTRAL POWER & LIME, INC.						
SO SRCPARAM	CENTPLP	139.895	91.44	380.9	14.33	4.88
SO SRCPARAM	CENTPL14	258.426	97.54	394.3	21.21	4.88
** Building Parameters						
SO BUILDHGT	NAPFRGC-NAPFRGF		27.43	27.43	27.43	32.31
SO BUILDHGT	NAPFRGC-NAPFRGF		32.31	32.31	32.31	32.31

SO BUILDHGT	NAPFRGC-NAPFRGF	32.31	32.31	32.31	27.43	27.43	27.43
SO BUILDHGT	NAPFRGC-NAPFRGF	27.43	27.43	27.43	32.31	32.31	32.31
SO BUILDHGT	NAPFRGC-NAPFRGF	32.31	32.31	32.31	32.31	32.31	32.31
SO BUILDHGT	NAPFRGC-NAPFRGF	32.31	32.31	32.31	27.43	27.43	27.43
SO BUILDWID	NAPFRGC-NAPFRGF	37.35	40.87	43.14	30.27	32.12	33.00
SO BUILDWID	NAPFRGC-NAPFRGF	32.87	31.74	29.65	31.74	32.87	33.00
SO BUILDWID	NAPFRGC-NAPFRGF	32.12	30.27	27.50	40.87	37.35	32.70
SO BUILDWID	NAPFRGC-NAPFRGF	37.35	40.87	43.14	30.27	32.12	33.00
SO BUILDWID	NAPFRGC-NAPFRGF	32.87	31.74	29.65	31.74	32.87	33.00
SO BUILDWID	NAPFRGC-NAPFRGF	32.12	30.27	27.50	40.87	37.35	32.70

SO BUILDHGT	NAPFMSC-NAPFMSF	27.43	27.43	32.31	32.31	32.31	32.31
SO BUILDHGT	NAPFMSC-NAPFMSF	32.31	32.31	32.31	32.31	32.31	32.31
SO BUILDHGT	NAPFMSC-NAPFMSF	32.31	32.31	32.31	27.43	27.43	27.43
SO BUILDHGT	NAPFMSC-NAPFMSF	27.43	27.43	32.31	32.31	32.31	32.31
SO BUILDHGT	NAPFMSC-NAPFMSF	32.31	32.31	32.31	32.31	32.31	32.31
SO BUILDHGT	NAPFMSC-NAPFMSF	32.31	32.31	32.31	27.43	27.43	27.43
SO BUILDWID	NAPFMSC-NAPFMSF	37.35	40.87	27.50	30.27	32.12	33.00
SO BUILDWID	NAPFMSC-NAPFMSF	32.87	31.74	29.65	31.74	32.87	33.00
SO BUILDWID	NAPFMSC-NAPFMSF	32.12	30.27	27.50	40.87	37.35	32.70
SO BUILDWID	NAPFMSC-NAPFMSF	37.35	40.87	27.50	30.27	32.12	33.00
SO BUILDWID	NAPFMSC-NAPFMSF	32.87	31.74	29.65	31.74	32.87	33.00
SO BUILDWID	NAPFMSC-NAPFMSF	32.12	30.27	27.50	40.87	37.35	32.70

SO BUILDHGT	SAPFAC-SAPFAF	27.43	27.43	32.31	32.31	32.31	32.31
SO BUILDHGT	SAPFAC-SAPFAF	32.31	32.31	32.31	32.31	32.31	32.31
SO BUILDHGT	SAPFAC-SAPFAF	32.31	34.14	34.14	34.14	27.43	27.43
SO BUILDHGT	SAPFAC-SAPFAF	27.43	27.43	32.31	32.31	32.31	32.31
SO BUILDHGT	SAPFAC-SAPFAF	32.31	32.31	32.31	32.31	32.31	32.31
SO BUILDHGT	SAPFAC-SAPFAF	32.31	27.43	27.43	27.43	27.43	27.43
SO BUILDWID	SAPFAC-SAPFAF	37.35	40.87	27.50	30.27	32.12	33.00
SO BUILDWID	SAPFAC-SAPFAF	32.87	31.74	29.65	31.74	32.87	33.00
SO BUILDWID	SAPFAC-SAPFAF	32.12	25.81	26.66	26.71	37.35	32.70
SO BUILDWID	SAPFAC-SAPFAF	37.35	40.87	27.50	30.27	32.12	33.00
SO BUILDWID	SAPFAC-SAPFAF	32.87	31.74	29.65	31.74	32.87	33.00
SO BUILDWID	SAPFAC-SAPFAF	32.12	44.11	43.14	40.87	37.35	32.70

SO BUILDHGT	SAPFBC-SAPFBE	27.43	27.43	32.31	32.31	32.31	32.31
SO BUILDHGT	SAPFBC-SAPFBE	32.31	32.31	32.31	32.31	32.31	32.31
SO BUILDHGT	SAPFBC-SAPFBE	32.31	32.31	32.31	27.43	27.43	27.43
SO BUILDHGT	SAPFBC-SAPFBE	27.43	27.43	32.31	32.31	32.31	32.31
SO BUILDHGT	SAPFBC-SAPFBE	32.31	32.31	32.31	32.31	32.31	32.31
SO BUILDHGT	SAPFBC-SAPFBE	32.31	32.31	32.31	27.43	27.43	27.43
SO BUILDWID	SAPFBC-SAPFBE	37.35	40.87	27.50	30.27	32.12	33.00
SO BUILDWID	SAPFBC-SAPFBE	32.87	31.74	29.65	31.74	32.87	33.00
SO BUILDWID	SAPFBC-SAPFBE	32.12	30.27	27.50	40.87	37.35	32.70
SO BUILDWID	SAPFBC-SAPFBE	37.35	40.87	27.50	30.27	32.12	33.00
SO BUILDWID	SAPFBC-SAPFBE	32.87	31.74	29.65	31.74	32.87	33.00
SO BUILDWID	SAPFBC-SAPFBE	32.12	30.27	27.50	40.87	37.35	32.70

\*\* BUILDING PARAMETERS FOR 1988 BASELINE SOURCES

BUILDHGT	NDAPMAIB	27.43	27.43	32.31	32.31	32.31	32.31
BUILDHGT	NDAPMAIB	32.31	32.31	32.31	32.31	32.31	32.31
BUILDHGT	NDAPMAIB	32.31	32.31	32.31	27.43	27.43	27.43
BUILDHGT	NDAPMAIB	27.43	27.43	32.31	32.31	32.31	32.31
BUILDHGT	NDAPMAIB	32.31	32.31	32.31	32.31	32.31	32.31
BUILDHGT	NDAPMAIB	32.31	32.31	32.31	27.43	27.43	27.43

BUILDHGT	SDAPMAIB	27.43	27.43	32.31	32.31	32.31	32.31
BUILDHGT	SDAPMAIB	32.31	32.31	32.31	32.31	32.31	32.31
BUILDHGT	SDAPMAIB	32.31	32.31	32.31	27.43	27.43	27.43
BUILDHGT	SDAPMAIB	27.43	27.43	32.31	32.31	32.31	32.31



BUILDHGT SDAPMAIB 32.31 32.31 32.31 32.31 32.31 32.31  
BUILDHGT SDAPMAIB 32.31 32.31 32.31 27.43 27.43 27.43

BUILDHGT SATHEAT 22.86 22.86 22.86 24.69 24.69 24.69  
BUILDHGT SATHEAT 22.56 22.56 22.56 22.56 22.56 22.56  
BUILDHGT SATHEAT 22.56 22.56 0.00 0.00 0.00 0.00  
BUILDHGT SATHEAT 0.00 0.00 0.00 0.00 0.00 22.86 22.56  
BUILDHGT SATHEAT 22.56 22.56 22.56 22.56 22.56 22.56  
BUILDHGT SATHEAT 22.56 22.56 0.00 0.00 0.00 0.00

BUILDHGT SAP3 0.00 0.00 0.00 0.00 0.00 0.00  
BUILDHGT SAP3 22.56 22.56 0.00 0.00 0.00 0.00  
BUILDHGT SAP3 0.00 0.00 0.00 0.00 0.00 0.00  
BUILDHGT SAP3 0.00 0.00 0.00 0.00 0.00 0.00  
BUILDHGT SAP3 0.00 0.00 0.00 0.00 0.00 0.00  
BUILDHGT SAP3 0.00 0.00 0.00 0.00 0.00 0.00

BUILDWID NDAPMAIB 37.35 40.87 27.50 30.27 32.12 33.00  
BUILDWID NDAPMAIB 32.87 31.74 29.65 31.74 32.87 33.00  
BUILDWID NDAPMAIB 32.12 30.27 27.50 40.87 37.35 32.70  
BUILDWID NDAPMAIB 37.35 40.87 27.50 30.27 32.12 33.00  
BUILDWID NDAPMAIB 32.87 31.74 29.65 31.74 32.87 33.00  
BUILDWID NDAPMAIB 32.12 30.27 27.50 40.87 37.35 32.70

BUILDWID SDAPMAIB 37.35 40.87 27.50 30.27 32.12 33.00  
BUILDWID SDAPMAIB 32.87 31.74 29.65 31.74 32.87 33.00  
BUILDWID SDAPMAIB 32.12 30.27 27.50 40.87 37.35 32.70  
BUILDWID SDAPMAIB 37.35 40.87 27.50 30.27 32.12 33.00  
BUILDWID SDAPMAIB 32.87 31.74 29.65 31.74 32.87 33.00  
BUILDWID SDAPMAIB 32.12 30.27 27.50 40.87 37.35 32.70

BUILDWID SATHEAT 34.83 43.95 51.73 42.42 47.68 51.50  
BUILDWID SATHEAT 28.21 25.39 21.80 25.39 28.21 30.17  
BUILDWID SATHEAT 31.21 31.31 0.00 0.00 0.00 0.00  
BUILDWID SATHEAT 0.00 0.00 0.00 0.00 62.40 30.17  
BUILDWID SATHEAT 28.21 25.39 21.80 25.39 28.21 30.17  
BUILDWID SATHEAT 31.21 31.31 0.00 0.00 0.00 0.00

BUILDWID SAP3 0.00 0.00 0.00 0.00 0.00 0.00  
BUILDWID SAP3 28.21 25.39 0.00 0.00 0.00 0.00  
BUILDWID SAP3 0.00 0.00 0.00 0.00 0.00 0.00  
BUILDWID SAP3 0.00 0.00 0.00 0.00 0.00 0.00  
BUILDWID SAP3 0.00 0.00 0.00 0.00 0.00 0.00  
BUILDWID SAP3 0.00 0.00 0.00 0.00 0.00 0.00

SRCGROUP ALL  
SO FINISHED

\*\*  
\*\*\*\*\*

\*\* ISCST3 Receptor Pathway  
\*\*\*\*\*

\*\*  
\*\*

RE STARTING

\*\* FENCELINE RECEPTORS AT 100 M SPACING  
DISCCART -1829.22 -140.52  
DISCCART -1829.22 274.48  
DISCCART -2408.22 274.48  
DISCCART -2895.22 539.48  
DISCCART -2987.22 914.48  
DISCCART -2743.22 1099.48  
DISCCART -2408.22 1834.48  
DISCCART -1536.22 2072.48  
DISCCART -1433.22 2255.48  
DISCCART 549.78 2255.48

DISCCART 499.78 1462.48  
DISCCART 2069.78 1462.48  
DISCCART 2069.78 -122.52  
DISCCART 1799.78 -549.52  
DISCCART 1432.78 -549.52  
DISCCART 1186.78 -140.52  
DISCCART -1829.22 -57.52  
DISCCART -1829.22 25.48  
DISCCART -1829.22 108.48  
DISCCART -1829.22 191.48  
DISCCART -1925.72 274.48  
DISCCART -2022.22 274.48  
DISCCART -2118.72 274.48  
DISCCART -2215.22 274.48  
DISCCART -2311.72 274.48  
DISCCART -2489.39 318.65  
DISCCART -2570.55 362.81  
DISCCART -2651.72 406.98  
DISCCART -2732.89 451.15  
DISCCART -2814.05 495.31  
DISCCART -2918.22 633.23  
DISCCART -2941.22 726.98  
DISCCART -2964.22 820.73  
DISCCART -2926.22 960.73  
DISCCART -2865.22 1006.98  
DISCCART -2804.22 1053.23  
DISCCART -2706.00 1181.15  
DISCCART -2668.78 1262.81  
DISCCART -2631.55 1344.48  
DISCCART -2594.33 1426.15  
DISCCART -2557.11 1507.81  
DISCCART -2519.89 1589.48  
DISCCART -2482.66 1671.15  
DISCCART -2445.44 1752.81  
DISCCART -2321.02 1858.28  
DISCCART -2233.82 1882.08  
DISCCART -2146.62 1905.88  
DISCCART -2059.42 1929.68  
DISCCART -1972.22 1953.48  
DISCCART -1885.02 1977.28  
DISCCART -1797.82 2001.08  
DISCCART -1710.62 2024.88  
DISCCART -1623.42 2048.68  
DISCCART -1501.89 2133.48  
DISCCART -1467.55 2194.48  
DISCCART -1334.07 2255.48  
DISCCART -1234.92 2255.48  
DISCCART -1135.77 2255.48  
DISCCART -1036.62 2255.48  
DISCCART -937.47 2255.48  
DISCCART -838.32 2255.48  
DISCCART -739.17 2255.48  
DISCCART -640.02 2255.48  
DISCCART -540.87 2255.48  
DISCCART -441.72 2255.48  
DISCCART -342.57 2255.48  
DISCCART -243.42 2255.48  
DISCCART -144.27 2255.48  
DISCCART -45.12 2255.48  
DISCCART 54.03 2255.48  
DISCCART 153.18 2255.48  
DISCCART 252.33 2255.48  
DISCCART 351.48 2255.48  
DISCCART 450.63 2255.48  
DISCCART 543.53 2156.36

DISCCART 537.28 2057.23  
DISCCART 531.03 1958.11  
DISCCART 524.78 1858.98  
DISCCART 518.53 1759.86  
DISCCART 512.28 1660.73  
DISCCART 506.03 1561.61  
DISCCART 597.90 1462.48  
DISCCART 696.03 1462.48  
DISCCART 794.15 1462.48  
DISCCART 892.28 1462.48  
DISCCART 990.41 1462.48  
DISCCART 1088.53 1462.48  
DISCCART 1186.65 1462.48  
DISCCART 1284.78 1462.48  
DISCCART 1382.91 1462.48  
DISCCART 1481.03 1462.48  
DISCCART 1579.16 1462.48  
DISCCART 1677.28 1462.48  
DISCCART 1775.41 1462.48  
DISCCART 1873.53 1462.48  
DISCCART 1971.66 1462.48  
DISCCART 2069.78 1363.42  
DISCCART 2069.78 1264.36  
DISCCART 2069.78 1165.29  
DISCCART 2069.78 1066.23  
DISCCART 2069.78 967.17  
DISCCART 2069.78 868.11  
DISCCART 2069.78 769.04  
DISCCART 2069.78 669.98  
DISCCART 2069.78 570.92  
DISCCART 2069.78 471.86  
DISCCART 2069.78 372.79  
DISCCART 2069.78 273.73  
DISCCART 2069.78 174.67  
DISCCART 2069.78 75.61  
DISCCART 2069.78 -23.46  
DISCCART 2024.78 -193.69  
DISCCART 1979.78 -264.85  
DISCCART 1934.78 -336.02  
DISCCART 1889.78 -407.19  
DISCCART 1844.78 -478.35  
DISCCART 1708.03 -549.52  
DISCCART 1616.28 -549.52  
DISCCART 1524.53 -549.52  
DISCCART 1383.58 -467.72  
DISCCART 1334.38 -385.92  
DISCCART 1285.18 -304.12  
DISCCART 1235.98 -222.32  
DISCCART 1089.49 -140.52  
DISCCART 992.20 -140.52  
DISCCART 894.91 -140.52  
DISCCART 797.62 -140.52  
DISCCART 700.33 -140.52  
DISCCART 603.04 -140.52  
DISCCART 505.75 -140.52  
DISCCART 408.46 -140.52  
DISCCART 311.17 -140.52  
DISCCART 213.88 -140.52  
DISCCART 116.59 -140.52  
DISCCART 19.30 -140.52  
DISCCART -77.99 -140.52  
DISCCART -175.28 -140.52  
DISCCART -272.57 -140.52  
DISCCART -369.87 -140.52  
DISCCART -467.16 -140.52

```

DISCCART -564.45 -140.52
DISCCART -661.74 -140.52
DISCCART -759.03 -140.52
DISCCART -856.32 -140.52
DISCCART -953.61 -140.52
DISCCART -1050.90 -140.52
DISCCART -1148.19 -140.52
DISCCART -1245.48 -140.52
DISCCART -1342.77 -140.52
DISCCART -1440.06 -140.52
DISCCART -1537.35 -140.52
DISCCART -1634.64 -140.52
DISCCART -1731.93 -140.52
** RECEPTOR GRID FROM FENCELINE TO 2 KM AT 100 M SPACING
DISCCART -2000.00 -2000.00
DISCCART -2000.00 -1900.00
DISCCART -2000.00 -1800.00
DISCCART -2000.00 -1700.00
DISCCART -2000.00 -1600.00
DISCCART -2000.00 -1500.00
DISCCART -2000.00 -1400.00
.
.
DISCCART 2000.00 -400.00
DISCCART 2000.00 -300.00
DISCCART 2000.00 1500.00
DISCCART 2000.00 1600.00
DISCCART 2000.00 1700.00
DISCCART 2000.00 1800.00
DISCCART 2000.00 1900.00
DISCCART 2000.00 2000.00
RE FINISHED
**
*****
** ISCST3 Meteorology Pathway
*****
**
ME STARTING
  INPUTFIL C:\MET\tpatpa91.met
  ANEMHGHT 22 FEET
  SURFDATA 12842 1991 TAMPA/INT'L_ARPT
  UAIRDATA 12842 1991 TAMPA/RUSKIN
ME FINISHED
**
*****
** ISCST3 Output Pathway
*****
**
OU STARTING
  RECTABLE ALLAVE FIRST SECOND
OU FINISHED

```

**ISCST3 OUTPUT SUMMARY  
SIG ANALYSIS  
24-HOUR AND ANNUAL AVERAGE PM<sub>10</sub> IMPACTS**

ISCST3 OUTPUT FILE NUMBER 1 :GBPMSIG.O91  
 ISCST3 OUTPUT FILE NUMBER 2 :GBPMSIG.O92  
 ISCST3 OUTPUT FILE NUMBER 3 :GBPMSIG.O93  
 ISCST3 OUTPUT FILE NUMBER 4 :GBPMSIG.O94  
 ISCST3 OUTPUT FILE NUMBER 5 :GBPMSIG.O95  
 First title for last output file is: MOSAIC GREEN BAY PM10 CLASS II SIG  
 ANALYSIS, ISCST3, 8/15/05  
 Second title for last output file is: TAMPA/RUSKIN METDATA, 1991-1995

AVERAGING TIME	YEAR	CONC (ug/m3)	X (m)	Y (m)	PERIOD ENDING (YYMMDDHH)
-----					
SOURCE GROUP ID:	SHIPPI				
Annual					
	1991	2.325	-175.3	-140.5	91123124
	1992	2.228	-175.3	-140.5	92123124
	1993	2.351	-175.3	-140.5	93123124
	1994	2.572	-175.3	-140.5	94123124
	1995	2.498	-78.0	-140.5	95123124
HIGH 24-Hour					
	1991	13.033	-175.3	-140.5	91010124
	1992	14.107	-175.3	-140.5	92121324
	1993	17.377	116.6	-140.5	93112824
	1994	17.738	-78.0	-140.5	94112524
	1995	15.433	-78.0	-140.5	95112024
SOURCE GROUP ID:	ALL				
Annual					
	1991	6.523	-175.3	-140.5	91123124
	1992	5.931	-175.3	-140.5	92123124
	1993	5.698	-78.0	-140.5	93123124
	1994	6.059	-78.0	-140.5	94123124
	1995	5.655	-78.0	-140.5	95123124
HIGH 24-Hour					
	1991	35.950	-175.3	-140.5	91102924
	1992	35.020	-175.3	-140.5	92022124
	1993	38.978	-78.0	-140.5	93031924
	1994	33.959	-100.0	-200.0	94120124
	1995	32.706	408.5	-140.5	95022124
All receptor computations reported with respect to a user-specified origin					
GRID	0.00	0.00			
DISCRETE	0.00	0.00			

**ISCST3 OUTPUT SUMMARY  
SIG ANALYSIS  
ANNUAL AVERAGE NO<sub>x</sub> IMPACTS**

ISCST3 OUTPUT FILE NUMBER 1 :GBNOSIG.O91  
 ISCST3 OUTPUT FILE NUMBER 2 :GBNOSIG.O92  
 ISCST3 OUTPUT FILE NUMBER 3 :GBNOSIG.O93  
 ISCST3 OUTPUT FILE NUMBER 4 :GBNOSIG.O94  
 ISCST3 OUTPUT FILE NUMBER 5 :GBNOSIG.O95  
 First title for last output file is: MOSAIC GREEN BAY NOX CLASS II SIG ANALYSIS,  
 ISCST3, 8/16/05  
 Second title for last output file is: TAMPA/RUSKIN METDATA, 1991-1995

AVERAGING TIME	YEAR	CONC (ug/m3)	X (m)	Y (m)	PERIOD ENDING (YYMMDDHH)
-----					
SOURCE GROUP ID:	ALL				
Annual					
	1991	2.019	-175.3	-140.5	91123124
	1992	1.715	-78.0	-140.5	92123124
	1993	1.509	-100.0	-200.0	93123124
	1994	1.733	-100.0	-200.0	94123124
	1995	1.346	-200.0	-200.0	95123124
All receptor computations reported with respect to a user-specified origin					
GRID	0.00	0.00			
DISCRETE	0.00	0.00			



**ISCST3 OUTPUT SUMMARY  
SIG ANALYSIS  
FLUORIDE IMPACTS**

ISCST3 OUTPUT FILE NUMBER 1 :GBFLSIG.091  
 ISCST3 OUTPUT FILE NUMBER 2 :GBFLSIG.092  
 ISCST3 OUTPUT FILE NUMBER 3 :GBFLSIG.093  
 ISCST3 OUTPUT FILE NUMBER 4 :GBFLSIG.094  
 ISCST3 OUTPUT FILE NUMBER 5 :GBFLSIG.095

First title for last output file is: MOSAIC GREEN BAY FLUORIDE CLASS II SIG ANALYSIS, ISCST3, 8/16/05

Second title for last output file is: TAMPA/RUSKIN METDATA, 1991-1995

AVERAGING TIME	YEAR	CONC (ug/m3)	X (m)	Y (m)	PERIOD ENDING (YYMMDDHH)
SOURCE GROUP ID: ALL					
Annual					
	1991	1.371	-175.3	-140.5	91123124
	1992	1.261	-175.3	-140.5	92123124
	1993	1.216	-78.0	-140.5	93123124
	1994	1.291	-78.0	-140.5	94123124
	1995	1.226	-175.3	-140.5	95123124
HIGH 24-Hour					
	1991	7.278	-200.0	-200.0	91010424
	1992	6.966	-175.3	-140.5	92022124
	1993	7.912	-100.0	-200.0	93111124
	1994	7.665	-100.0	-200.0	94120124
	1995	6.960	100.0	-200.0	95121024
HIGH 8-Hour					
	1991	10.316	-100.0	-200.0	91121708
	1992	9.970	-78.0	-140.5	92052308
	1993	10.203	-100.0	-200.0	93112624
	1994	10.672	-100.0	-200.0	94120124
	1995	11.083	505.8	-140.5	95091724
HIGH 1-Hour					
	1991	19.003	311.2	-140.5	91122419
	1992	19.538	311.2	-140.5	92070522
	1993	19.538	311.2	-140.5	93070421
	1994	19.126	-100.0	-300.0	94061421
	1995	19.462	311.2	-140.5	95070203
All receptor computations reported with respect to a user-specified origin					
GRID	0.00	0.00			
DISCRETE	0.00	0.00			

**ISCST3 OUTPUT SUMMARY  
AAQS ANALYSIS  
ANNUAL AVERAGE PM<sub>10</sub> IMPACTS**

ISCST3 OUTPUT FILE NUMBER 1 :GBPMANAQ.091  
 ISCST3 OUTPUT FILE NUMBER 2 :GBPMANAQ.092  
 ISCST3 OUTPUT FILE NUMBER 3 :GBPMANAQ.093  
 ISCST3 OUTPUT FILE NUMBER 4 :GBPMANAQ.094  
 ISCST3 OUTPUT FILE NUMBER 5 :GBPMANAQ.095

First title for last output file is: MOSAIC GREEN BAY PM10 AAQS ANALYSIS,  
 ISCST3, 8/18/05

Second title for last output file is: TAMPA/RUSKIN METDATA, 1991-1995

AVERAGING TIME	YEAR	CONC (ug/m3)	X (m)	Y (m)	PERIOD ENDING (YYMMDDHH)
-----					
SOURCE GROUP ID:	ALL				
Annual					
	1991	11.836	-175.3	-140.5	91123124
	1992	11.612	-175.3	-140.5	92123124
	1993	11.773	-78.0	-140.5	93123124
	1994	11.755	-78.0	-140.5	94123124
	1995	11.758	-78.0	-140.5	95123124
All receptor computations reported with respect to a user-specified origin					
GRID	0.00	0.00			
DISCRETE	0.00	0.00			

**ISCST3 OUTPUT SUMMARY  
PSD CLASS II INCREMENT ANALYSIS  
ANNUAL AND 24-HOUR AVERAGE PM<sub>10</sub> IMPACTS**

ISCST3 OUTPUT FILE NUMBER 1 :GBPMPD.O91  
 ISCST3 OUTPUT FILE NUMBER 2 :GBPMPD.O92  
 ISCST3 OUTPUT FILE NUMBER 3 :GBPMPD.O93  
 ISCST3 OUTPUT FILE NUMBER 4 :GBPMPD.O94  
 ISCST3 OUTPUT FILE NUMBER 5 :GBPMPD.O95

First title for last output file is: MOSAIC GREEN BAY PM10 PSD CLASS II  
 INCREMENT ANALYSIS, ISCST3, 8/18/05

Second title for last output file is: TAMPA/RUSKIN METDATA, 1991-1995

AVERAGING TIME	YEAR	CONC (ug/m3)	X (m)	Y (m)	PERIOD ENDING (YYMMDDHH)
-----					
SOURCE GROUP ID: ALL					
Annual					
	1991	2.911	4000.0	500.0	91123124
	1992	2.106	4000.0	500.0	92123124
	1993	2.441	4500.0	750.0	93123124
	1994	2.539	4500.0	750.0	94123124
	1995	2.162	4750.0	750.0	95123124
HIGH 24-Hour					
	1991	19.120	3750.0	500.0	91020324
	1992	24.158	-5000.0	-750.0	92072824
	1993	22.728	4000.0	750.0	93090824
	1994	20.282	4250.0	250.0	94020124
	1995	19.467	4000.0	750.0	95011324
HSH 24-Hour					
	1991	17.183	4000.0	500.0	91093024
	1992	15.243	4000.0	250.0	92122924
	1993	19.300	4250.0	750.0	93061024
	1994	18.169	4000.0	250.0	94120124
	1995	15.587	4000.0	750.0	95110124
All receptor computations reported with respect to a user-specified origin					
GRID	0.00	0.00			
DISCRETE	0.00	0.00			

**ISCST3 OUTPUT SUMMARY  
REFINED PSD CLASS II INCREMENT ANALYSIS  
ANNUAL AND 24-HOUR AVERAGE PM<sub>10</sub> IMPACTS**

ISCST3 OUTPUT FILE NUMBER 1 :REPMPD.O91  
 ISCST3 OUTPUT FILE NUMBER 2 :REPMPD.O92  
 ISCST3 OUTPUT FILE NUMBER 3 :REPMPD.O93  
 ISCST3 OUTPUT FILE NUMBER 4 :REPMPD.O94  
 ISCST3 OUTPUT FILE NUMBER 5 :REPMPD.O95

First title for last output file is: MOSAIC GREEN BAY PM10 PSD CLASS II REFINED  
 INCREMENT ANALYSIS, ISCST3, 8/19/05

Second title for last output file is: TAMPA/RUSKIN METDATA, 1991-1995

AVERAGING TIME	YEAR	CONC (ug/m3)	X (m)	Y (m)	PERIOD ENDING (YYMMDDHH)
-----					
SOURCE GROUP ID:	ALL				
Annual					
	1991	3.295	4100.0	500.0	91123124
	1992	2.946	4600.0	600.0	92123124
	1993	3.171	4600.0	600.0	93123124
	1994	3.160	4100.0	400.0	94123124
	1995	2.861	4600.0	700.0	95123124
HIGH 24-Hour					
	1991	25.044	4000.0	600.0	91052124
	1992	24.171	4000.0	400.0	92022124
	1993	27.485	4100.0	400.0	93031924
	1994	22.946	4100.0	400.0	94021724
	1995	22.109	4300.0	200.0	95121024
HSH 24-Hour					
	1991	18.700	4100.0	500.0	91020224
	1992	18.783	4100.0	400.0	92123124
	1993	22.479	4100.0	400.0	93100624
	1994	18.651	4100.0	400.0	94021824
	1995	19.491	4300.0	300.0	95111224
All receptor computations reported with respect to a user-specified origin					
GRID	0.00	0.00			
DISCRETE	0.00	0.00			



**ISCST3 OUTPUT SUMMARY  
PSD CLASS II INCREMENT ANALYSIS  
ANNUAL AVERAGE NO<sub>x</sub> IMPACTS**

ISCST3 OUTPUT FILE NUMBER 1 :GBNOPSD.091  
 ISCST3 OUTPUT FILE NUMBER 2 :GBNOPSD.092  
 ISCST3 OUTPUT FILE NUMBER 3 :GBNOPSD.093  
 ISCST3 OUTPUT FILE NUMBER 4 :GBNOPSD.094  
 ISCST3 OUTPUT FILE NUMBER 5 :GBNOPSD.095

First title for last output file is: MOSAIC GREEN BAY NOX PSD CLASS II INCREMENT  
 ANALYSIS, ISCST3, 8/23/05

Second title for last output file is: TAMPA/RUSKIN METDATA, 1991-1995

AVERAGING TIME	YEAR	CONC (ug/m3)	X (m)	Y (m)	PERIOD ENDING (YYMMDDHH)
-----					
SOURCE GROUP ID: ALL					
Annual					
	1991	2.266	-800.0	-2000.0	91123124
	1992	2.339	600.0	-2000.0	92123124
	1993	2.319	900.0	-2000.0	93123124
	1994	2.238	900.0	-2000.0	94123124
	1995	2.114	500.0	-2000.0	95123124
All receptor computations reported with respect to a user-specified origin					
GRID	0.00	0.00			
DISCRETE	0.00	0.00			