

STATE OF FLORIDA  
DEPARTMENT OF ENVIRONMENTAL PROTECTION  
NOTICE OF FINAL PERMIT

In the Matter of an  
Application for Permit by:

Mr. Mark Smidebush, Plant Manager  
Ocean Spray Cranberries, Inc.  
925 74<sup>th</sup> Avenue, Southwest  
Vero Beach, Florida 32968-9702

DEP File No. 0610021-009-AC  
Increase Operating Hours  
Indian River County

Enclosed is Final Permit Number 0610021-009-AC. This permit authorizes Ocean Spray Cranberries, Inc. to increase the plant's allowable operating hours of the peel dryers and pellet cooler which is accomplished through a cap in total fruit processing of 6.4 million boxes in a 12-month period at its Vero Beach Facility located at 925 74<sup>th</sup> Avenue, Southwest, Vero Beach, Indian River County. This permit is issued pursuant to Chapter 403, Florida Statutes.

Any party to this order has the right to seek judicial review of it under Section 120.68 of the Florida Statutes, by filing a notice of appeal under Rule 9.110 of the Florida Rules of Appellate Procedure with the clerk of the Department of Environmental Protection in the Office of General Counsel, Mail Station #35, 3900 Commonwealth Boulevard, Tallahassee, Florida, 32399-3000, and by filing a copy of the notice of appeal accompanied by the applicable filing fees with the appropriate District Court of Appeal. The notice must be filed within thirty days after this order is filed with the clerk of the Department.

Executed in Tallahassee, Florida.



C. H. Fancy, P.E., Chief  
Bureau of Air Regulation

CERTIFICATE OF SERVICE

The undersigned duly designated deputy agency clerk hereby certifies that this Notice of Final Permit (including the Final permit) was sent by certified mail (\*) and copies were mailed by U.S. Mail before the close of business on 4/26/02 to the person(s) listed:

Mark Smidebush, Plant Manager, Ocean Spray Cranberries, Inc.\*  
Larry Stuart, P.E., Bottorf Associates, Inc.  
Leonard Kozlov, P.E., CD

Clerk Stamp

**FILING AND ACKNOWLEDGMENT FILED**, on this date, pursuant to §120.52, Florida Statutes, with the designated Department Clerk, receipt of which is hereby acknowledged.

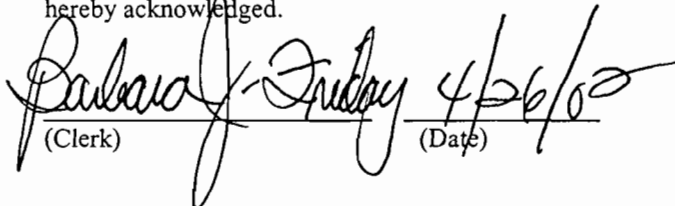
  
(Clerk) 4/26/02 (Date)

**U.S. Postal Service**  
**CERTIFIED MAIL RECEIPT**  
*(Domestic Mail Only; No Insurance Coverage Provided)*

7099 3400 0000 1449 5533

Article Sent To:  
**Mr. Mark Smidebush**

Postage	\$	Postmark Here
Certified Fee		
Return Receipt Fee (Endorsement Required)		
Restricted Delivery Fee (Endorsement Required)		
<b>Total Postage &amp; Fees</b>	<b>\$</b>	

Name (Please Print Clearly) (to be completed by mailer)  
**Mr. Mark Smidebush**  
 Street, Apt. No., or PO Box No.  
**925 74th Avenue, Southwest**  
 City, State, ZIP+4  
**Vero Beach, Florida 32968-9702**

# TECHNICAL EVALUATION AND FINAL DETERMINATION

## 1 APPLICANT NAME AND ADDRESS

Ocean Spray Cranberries, Inc.  
925 74<sup>th</sup> Avenue, Southwest  
Vero Beach, Florida 32968-9702

Authorized Representative: Mark Smidebush, Plant Manager

## 2 FACILITY DESCRIPTION, PROJECT DETAILS AND RULE APPLICABILITY

The facility is an existing citrus juice processing facility. The project is a request for additional operation hours for the peel dryers and pellet cooler. The applicant did not seek any relaxation in currently enforceable conditions for its other existing emissions units.

The emissions units addressed by this permit are Citrus Peel Dryer No. 1, I.D. 004, Citrus Peel Dryer No. 2, I.D. 006, and, Pellet Cooler, I.D. 005.

The emissions increases associated with this project were estimated as follows in tons per year. No offsetting emissions were assumed in this estimate.

Pollutant	Net Increase <sup>1</sup>	PSD Significance	Subject to PSD?
PM/ PM <sub>10</sub>	3.38/3.38	25/15	No
SO <sub>2</sub>	3.76	40	No
NO <sub>x</sub>	1.06	40	No
CO	5.02	100	No
VOC	39.14	40	No

<sup>1</sup> Potential emissions (shown as net increase) were estimated by the Department from allowable natural gas, no. 2 fuel oil usage and AP-42 emission factors (tables 1.3-1 and 1.3-3 for fuel oil, tables 1.4-1 and 1.4-2 for natural gas), assuming a heat content of 1000 Btu/scf of natural gas and 138 million Btu/1000 gallons of distillate fuel oil, given a design heat input capacity of 70 mmBtu/hour, and the fuel use limits of the permit.

The proposed project is subject to preconstruction review requirements under the provisions of Chapter 403, F.S., and Chapters 62-4, 62-204, 62-210, 62-212 and 62-297, F.A.C. The existing facility is located in an area designated, in accordance with Rule 62-204.340, F.A.C., as attainment or unclassifiable for the criteria pollutants ozone, PM<sub>10</sub>, carbon monoxide, SO<sub>2</sub>, nitrogen dioxide and lead. This facility is classified as a Major or Title V Source of air pollution because emissions of at least one regulated air pollutant exceeds 100 tons per year (TPY). The Department has previously found that citrus juice processing facilities such as this facility have potential emissions of VOC exceeding 250 TPY.

This facility is not within an industry included in the list of the 28 Major Facility Categories per Table 212.400-1 of Chapter 62-212, F.A.C. Because emissions are greater than 250 TPY for at least one criteria pollutant (VOC), the facility is also an existing Major Facility with respect to Rule 62-212.400, F.A.C., Prevention of Significant Deterioration (PSD). The net increase in emissions of PM/PM<sub>10</sub>, NO<sub>x</sub>, SO<sub>2</sub>, CO and VOC do not exceed the PSD significance levels of Table 212.400-2 of Chapter 62-212, F.A.C. Therefore the project is not subject to PSD requirements of Rule 62-212.400, F.A.C., for these pollutants.

The applicant stated that this facility is not a major source of hazardous air pollutants (HAPs). This project is not subject to a case-by-case MACT determination, per Rule 62-204.800(10)(d)2, F.A.C., because it does not result in the construction or reconstruction of a major source of HAP emissions. This project is not subject to any requirements under the National Emissions Standards for Hazardous Air Pollutants, 40 CFR 61 or 63.

**3 SOURCE IMPACT ANALYSIS**

An impact analysis was not required for this project because it is not subject to the requirements of PSD.

**4 EXCESS EMISSIONS**

Excess emissions for this emissions unit are specified in Section II of the permit. This permitting action does not change any authorization for excess emissions provided by other Department permits for other emissions units

**5 LIMITS AND COMPLIANCE REQUIREMENTS**

The permit limits the total fruit processed by the plant in a 12-month period as the method of limiting emissions. Additional specific emission limits were not imposed because the potential emissions are well below the PSD significance criteria. The operating limits and the compliance requirements are detailed in Section III of the permit.

**6 PRELIMINARY DETERMINATION**

Based on the foregoing technical evaluation of the application and additional information submitted by the applicant and other available information, the Department has made a preliminary determination that the proposed project will comply with all applicable state and federal air pollution regulations. The Department's preliminary determination is to issue the draft permit to allow sufficient operating hours for the two peel dryers and pellet cooler to process 6.4 million boxes of citrus fruit in any consecutive 12 month period which can be accomplished in an estimated 3,737 hours, subject to the terms and conditions of the draft permit.

**7 FINAL DETERMINATION**

An "INTENT TO ISSUE A COMBINED AIR CONSTRUCTION PERMIT/TITLE V OPERATION PERMIT REVISION" to Ocean Spray Cranberries, Inc. for an increase in the plant's allowable operating hours of the peel dryers and pellet cooler which is accomplished through a cap in total fruit processing of 6.4 million boxes in a 12-month period at its Vero Beach Facility located at 925 74<sup>th</sup> Avenue, Southwest, Vero Beach, Indian River County was clerked on February 28, 2002. The "PUBLIC NOTICE OF INTENT TO ISSUE A COMBINED AIR CONSTRUCTION PERMIT/TITLE V OPERATION PERMIT REVISION" was published in the Vero Beach Press Journal on March 15, 2002. The Draft Air Construction Permit and DRAFT Title V Operation Permit Revision were available for public inspection at the Central District office in Orlando and the permitting authority's office in Tallahassee. Proof of publication of the "PUBLIC NOTICE OF INTENT TO ISSUE A COMBINED AIR CONSTRUCTION PERMIT/TITLE V OPERATION PERMIT REVISION" was received on April 1, 2002.

No comments were received during the thirty (30) day public comment period. As a result, the Final Air Construction permit will be issued, as noticed.

**DETAILS OF THIS ANALYSIS MAY BE OBTAINED BY CONTACTING:**

Edward J. Svec, Engineer IV  
Department of Environmental Protection  
Bureau of Air Regulation  
Mail Station #5505  
2600 Blair Stone Road  
Tallahassee, Florida 32399-2400  
Telephone: 850/488-0114



# Department of Environmental Protection

Jeb Bush  
Governor

Twin Towers Office Building  
2600 Blair Stone Road  
Tallahassee, Florida 32399-2400

David B. Struhs  
Secretary

## PERMITTEE

Ocean Spray Cranberries, Inc.  
925 74th Avenue, Southwest  
Vero Beach, Florida 32968-9702

<b>Permit No.</b>	0610021-009-AC
<b>Project</b>	Additional Operating Hours
<b>SIC No.</b>	2037
<b>Expires:</b>	December 31, 2002

## Authorized Representative:

Mark Smidebush, Plant Manager

## PROJECT AND LOCATION

This permit authorizes Ocean Spray Cranberries, Inc., to increase hours of operation necessary to process 6.4 million boxes of fruit in a 12-month period through the existing Peel Dryers and Pellet Mill.

This facility is located at 925 74th Avenue, Southwest, Vero Beach, Indian River County. The UTM coordinates are: Zone 17; 550.7 km E and 3051.3 km N.

## STATEMENT OF BASIS

This construction permit is issued under the provisions of Chapter 403 of the Florida Statutes (F.S.), and the Florida Administrative Code (F.A.C.) Chapters 62-4, 62-204, 62-210, 62-212, 62-296, and 62-297. The above named permittee is authorized to construct the emissions units in accordance with the conditions of this permit and as described in the application, approved drawings, plans, and other documents on file with the Department of Environmental Protection (Department).

## APPENDICES

The attached appendix is a part of this permit:

Appendix GC General Permit Conditions

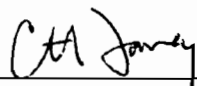
*for*   
Howard L. Rhodes, Director  
Division of Air Resources  
Management

**AIR CONSTRUCTION PERMIT**  
**SECTION I. FACILITY INFORMATION**

---

**FACILITY AND PROJECT DESCRIPTION**

This facility consists of two citrus peel dryers (nos. 1 and 2) equipped with a waste heat evaporator and an integral scrubber to control particulate emissions; one pellet cooler equipped with a cyclone to control particulate emissions; and three steam boilers (nos. 1, 2, and 3).

The applicant is requesting sufficient operating hours to process a maximum 6.4 million boxes of fruit per year. The applicant did not seek any relaxation in currently enforceable conditions in its other existing emissions units.

The emissions increases associated with this project were estimated as follows in tons per year. No offsetting emissions were assumed in this estimate.

<b>Pollutant</b>	<b>Net Increase <sup>1</sup></b>	<b>PSD Significance</b>	<b>Subject to PSD?</b>
PM/ PM <sub>10</sub>	3.38/3.38	25/15	No
SO <sub>2</sub>	3.76	40	No
NO <sub>x</sub>	1.06	40	No
CO	5.02	100	No
VOC	39.14	40	No

<sup>1</sup> Potential emissions (shown as net increase) were estimated by the Department from allowable natural gas, no. 2 fuel oil usage and AP-42 emission factors (tables 1.3-1 and 1.3-3 for fuel oil, tables 1.4-1 and 1.4-2 for natural gas), assuming a heat content of 1000 Btu/scf of natural gas and 138 million Btu/1000 gallons of distillate fuel oil, given a design heat input capacity of 70 million Btu/hour, and the fuel use limits of the permit.

The facility information, project scope, emissions and rule applicability are described in detail in the Department's Technical Evaluation and Determination.

**REVIEWING AND PROCESS SCHEDULE**

November 26, 2001	Received permit application (no application fee required)
December 11, 2001	Application complete
February 28, 2002	Distributed Notice of Intent to Issue and supporting documents
March 15, 2002	Notice of Intent published in the Vero Beach Press Journal

**RELEVANT DOCUMENTS**

The documents listed below are the basis of the permit. They are specifically related to this permitting action. These documents are on file with the Department.

- Permit application
- Department's Technical Evaluation and Determination
- Department's Intent to Issue

## AIR CONSTRUCTION PERMIT

### SECTION II. FACILITY-WIDE SPECIFIC CONDITIONS

---

The following specific conditions apply to all emissions units at this facility addressed by this permit.

#### ADMINISTRATIVE

1. Regulating Agencies: All documents related to applications for permits to construct, operate or modify an emissions unit should be submitted to the Bureau of Air Regulation (BAR), Florida Department of Environmental Protection at Mail Station #5505, 2600 Blair Stone Road, Tallahassee, Florida 32399-2400, phone number 850/488-0114. All documents related to reports, tests, minor modifications and notifications shall be submitted to the Department's Central District office at 3319 Maguire Blvd., Suite 232, Orlando, Florida 32803, and phone number 407/894-7555.
2. General Conditions: The owner and operator is subject to and shall operate under the attached General Permit Conditions G.1 through G.15 listed in Appendix GC of this permit. General Permit Conditions are binding and enforceable pursuant to Chapter 403, F.S. [Rule 62-4.160, F.A.C.]
3. Terminology: The terms used in this permit have specific meanings as defined in the corresponding chapters of the Florida Administrative Code.
4. Applicable Regulations, Forms and Application Procedures: Unless otherwise indicated in this permit, the construction and operation of the subject emissions unit shall be in accordance with the capacities and specifications stated in the application. The facility is subject to all applicable provisions of Chapter 403, F.S.; Chapters 62-4, 62-110, 62-204, 62-212, 62-213, 62-296, 62-297, F.A.C.; and, the Code of Federal Regulations Title 40, Part 60, adopted by reference in the F.A.C. regulations. The permittee shall use the applicable forms listed in Rule 62-210.900, F.A.C. and follow the application procedures in Chapter 62-4, F.A.C. Issuance of this permit does not relieve the facility owner or operator from compliance with any applicable federal, state, or local permitting or regulations. [Rules 62-204.800, 62-210.300 and 62-210.900, F.A.C.]
5. New or Additional Conditions: Pursuant to Rule 62-4.080, F.A.C., for good cause shown and after notice and an administrative hearing, if requested, the Department may require the permittee to conform to new or additional conditions. The Department shall allow the permittee a reasonable time to conform to the new or additional conditions, and on application of the permittee, the Department may grant additional time. [Rule 62-4.080, F.A.C.]
6. Expiration: This air construction permit shall expire on December 31, 2002. The permittee, for good cause, may request that this construction permit be extended. Such a request shall be submitted to the Department's Bureau of Air Regulation prior to 60 days before the expiration of the permit. [Rules 62-210.300(1), 62-4.070(4), 62-4.080, and 62-4.210, F.A.C.]
7. Modifications: No emissions unit or facility subject to this permit shall be constructed or modified without obtaining an air construction permit from the Department. Such permit must be obtained prior to the beginning of construction or modification. [Rules 62-210.300(1) and 62-212.300(1)(a), F.A.C.]
8. Title V Operation Permit Required: This permit authorizes construction and/or installation of the permitted emissions unit and initial operation to determine compliance with Department rules. A revision to the Title V operation permit is required for regular operation of the permitted emissions unit. The owner or operator shall apply for a Title V operation permit at least ninety days prior to expiration of this permit, but no later than 180 days after commencing operation. To apply for a



## AIR CONSTRUCTION PERMIT

### SECTION II. FACILITY-WIDE SPECIFIC CONDITIONS

---

Title V operation permit, the applicant shall submit the appropriate application form, compliance test results, and such additional information as the Department may by law require. The application shall be submitted to the Department's Central District office. [Rules 62-4.030, 62-4.050, 62-4.220, and Chapter 62-213, F.A.C.]

#### OPERATIONAL REQUIREMENTS

9. Plant Operation - Problems: If temporarily unable to comply with any of the conditions of the permit due to breakdown of equipment or destruction by hazard of fire, wind or by other cause, the permittee shall immediately notify the Department's Central District office. The notification shall include pertinent information as to the cause of the problem, and what steps are being taken to correct the problem and to prevent its recurrence, and where applicable, the owner's intent toward reconstruction of destroyed facilities. Such notification does not release the permittee from any liability for failure to comply with Department rules. [Rule 62-4.130, F.A.C.]
10. Circumvention: No person shall circumvent any air pollution control device or allow the emission of air pollutants without the applicable air pollution control device operating properly. [Rule 62-210.650, F.A.C.]
11. Excess Emissions: This permit does not change any authorization for excess emissions provided by other Department permits for other emissions units. The following excess emissions provisions of state rule apply to these emissions units (emissions unit I.D. 004, 005, and 006) as specified below.
  - (a) Excess emissions resulting from start-up and shutdown are permitted providing (1) best operational practices to minimize emissions are adhered to and (2) the duration of excess emissions shall be minimized, but in no case exceed two hours in any 24 hour period.
  - (b) Excess emissions resulting from malfunction of this emissions unit shall be permitted providing (1) best operational practices to minimize emissions are adhered to and (2) the duration of excess emissions shall be minimized, but in no case exceed two hours in any 24 hour period unless specifically authorized by the Department for longer duration.
  - (c) Excess emissions which are caused entirely or in part by poor maintenance, poor operation, or any other equipment or process failure which may reasonably be prevented during start-up, shutdown, or malfunction shall be prohibited.

[Rules 62-210.700(1), (4) and (5), F.A.C.]

#### COMPLIANCE MONITORING AND TESTING REQUIREMENTS

12. Determination of Process Variables: [Rule 62-297.310(5), F.A.C.]
  - (a) Required Equipment. The owner or operator of an emissions unit for which compliance tests are required shall install, operate, and maintain equipment or instruments necessary to determine process variables, such as process weight input or heat input, when such data are needed in conjunction with emissions data to determine the compliance of the emissions unit with applicable emission limiting standards.
  - (b) Accuracy of Equipment. Equipment or instruments used to directly or indirectly determine process variables, including devices such as belt scales, weight hoppers, flow meters, and tank scales, shall be calibrated and adjusted to indicate the true value of the parameter being measured

**AIR CONSTRUCTION PERMIT**  
**SECTION II. FACILITY-WIDE SPECIFIC CONDITIONS**

---

with sufficient accuracy to allow the applicable process variable to be determined within 10% of its true value.

**REPORTING AND RECORD KEEPING REQUIREMENTS**

13. Duration of Record Keeping: Upon request, the permittee shall furnish all records and plans required under Department rules. During enforcement actions, the retention period for all records will be extended automatically unless otherwise stipulated by the Department. The permittee shall hold at the facility or other location designated by this permit records of all monitoring information (including all calibration and maintenance records and all original strip chart recordings for continuous monitoring instrumentation) required by the permit, copies of all reports required by this permit, and records of all data used to complete the application for this permit. These materials shall be retained at least five years from the date of the sample, measurement, report, or application unless otherwise specified by Department rule. [Rules 62-4.160(14)(a)&(b) and 62-213.440(1)(b)2.b., F.A.C.]
14. Excess Emissions Report: In case of excess emissions resulting from malfunction, the owner or operator shall notify the Department's Central District office within one working day of: the nature, extent, and duration of the excess emissions; the cause of the excess emissions; and the actions taken to correct the problem. In addition, the Department may request a written summary report of the incident. A full written report on the malfunctions shall be submitted in a quarterly report if requested by the Department. [Rules 62-4.130 and 62-210.700(6), F.A.C.]
15. Annual Operating Report for Air Pollutant Emitting Facility: The Annual Operating Report for Air Pollutant Emitting Facility shall be completed each year and shall be submitted to the Department's Central District office and, if applicable, the appropriate local program by March 1 of the following year. [Rule 62-210.370(3), F.A.C.]

**AIR CONSTRUCTION PERMIT**

**SECTION III. EMISSIONS UNITS SPECIFIC CONDITIONS**

---

The following specific conditions apply to the following emissions units after construction.

**E.U. ID**

<b><u>No.</u></b>	<b><u>Brief Description</u></b>
-004	Citrus Peel Dryer No. 1
-006	Citrus Peel Dryer No. 2
-005	Pellet Cooler

Citrus peel dryers (nos. 1 and 2) are equipped with a waste heat evaporator and an integral scrubber to control particulate emissions. The pellet cooler is equipped with a cyclone to control particulate emissions.

These emissions units are regulated under Rule 62-296.320, F.A.C., General Pollutant Emission Limiting Standards.

**The following specific conditions apply to the emissions unit(s) listed above:**

**Essential Potential to Emit (PTE) Parameters**

**1. Capacity.**

- a. The maximum process input rate (wet peel) to peel dryer no. 1 shall not exceed 95,256 tons per twelve consecutive months.
- b. The maximum process input rate (wet peel) to peel dryer no. 2 shall not exceed 127,008 tons per twelve consecutive months.
- c. The maximum process rate, which includes moisture, for the pellet cooler shall not exceed 48,686 tons per twelve consecutive months.
- d. The maximum process input rate (wet peel) to both dryers shall not exceed 127,008 tons per twelve consecutive months.

[Rules 62-4.160(2), F.A.C. and 62-210.200, (PTE), F.A.C. and construction permit 0610021-005-AC]

**2. Fruit Throughput Limited:** The owner or operator shall not process more than 6.4 million boxes of citrus fruit in any consecutive 12 month period. For purposes of this permit, a box of citrus fruit shall be defined to contain 90 pounds of oranges or 85 pounds of grapefruit. The owner or operator shall make and maintain monthly and rolling 12 month records of fruit processing rates to demonstrate compliance with this limitation. Such records shall be made from daily processing records and shall be completed no later than the 10<sup>th</sup> day of each following month. [Rule 62-4.070(3), F.A.C. and 0610021-009-AC]

**3. Methods of Operation - (i.e., Fuels).**

The fuel used by the peel dryers shall be limited to natural gas, propane, or new no. 2 fuel oil with a sulfur content not to exceed 0.5% S by weight. The maximum fuel usage rate for the two citrus peel dryers shall not exceed 1,265,494 gallons (combined total) per twelve consecutive months.

[Rules 62-210.200, (PTE), F.A.C. and 62-4.160(2), F.A.C., and construction permit 0610021-005-AC]

**4. Hours of Operation.** For emission calculations, the hours of operation for these emissions units are estimated not to exceed 3,737 hours per year.

**AIR CONSTRUCTION PERMIT**  
**SECTION III. EMISSIONS UNITS SPECIFIC CONDITIONS**

---

\*Dryers No. 1 and 2 shall not operate simultaneously.  
[Rules 62-4.160(2) and 62-210.200(PTE), F.A.C. and construction permit 0610021-009-AC]

**EMISSION LIMITATIONS AND STANDARDS**

5. Peel dryers no. 1 and 2 are subject to Rule 62-296.320(4)(a) Process Weight Table 296.320-1, F.A.C. The maximum process weight is 27.0 tons/hour (dryer no. 1) and 36.0 tons/hour (dryer no. 2) and, as requested by the applicant, the emission rate is capped at 17.3 pounds per hour from each dryer and annual emissions are capped at a total of 32.32 tons per any consecutive twelve month period from both dryers since both dryers can not be operated simultaneously.

[Construction permit 0610021-009-AC and Rule 62-296.320(4)(a), F.A.C.]

6. The pellet cooler is subject to Rule 62-296.320(4)(a) Process Weight Table 296.320-1, F.A.C. The maximum process weight is 13.8 tons/hour and, as requested by the applicant, the emission rate is capped at 15.0 pounds per hour and annual emissions are capped at 28.03 tons per any consecutive twelve month period. For lower process rates, i.e. those below 10.0 tons per hour, the process weight rule equation limitation will be the more stringent limitation.

[Construction permit 0610021-009-AC and Rule 62-296.320(4)(a), F.A.C.]

7. Visible emissions from each emission unit shall not be equal to or greater than 20% opacity.

[Rule 62-296.320(4)(b)(1), F.A.C.]

8. Emissions of sulfur dioxide (SO<sub>2</sub>) from peel dryers no. 1 and 2 shall not exceed 44.93 tons per twelve consecutive months (combined total), as requested by the applicant.

[Construction permit 0610021-005-AC]

**Test Methods and Procedures**

9. Each peel dryer shall be tested for visible emissions for a 30 minute period annually on, or during the 60 day period prior to January 30. Each peel dryer shall be tested for particulate matter emissions prior to permit renewal. (Note that peel dryer no. 2 shall be tested within 30 days after being placed in operation.) Testing of emissions must be conducted when the emission unit being tested is in operation and the test observation period shall include the period during which the highest opacity emissions can reasonably be expected to occur. A statement of each units process input rate and the fuel type and heat input rate shall be included with all test reports.

[Rules 62-297.310(7)(a), F.A.C. and 62-4.070(3), F.A.C.]

10. The pellet cooler shall be tested for visible emissions for a 30 minute period annually on or during the 60 day period prior to January 30. The pellet cooler shall be tested for particulate matter emissions prior to permit renewal. (Note that the pellet cooler shall be tested within 30 days after being placed in operation at its higher permitted capacity.) Testing of emissions must be conducted when the emission

**AIR CONSTRUCTION PERMIT**

**SECTION III. EMISSIONS UNITS SPECIFIC CONDITIONS**

---

unit being tested is in operation and the test observation period shall include the period during which the highest opacity emissions can reasonably be expected to occur. A statement of the units process rate shall be included with all test reports.

[Rules 62-297.310(7)(a), F.A.C. and 62-4.070(3), F.A.C.]

**11.** Compliance with the emission limitations shall be determined using EPA Methods 1, 2, 3, 4, 5, 9, 10, and 25A or Method 25A in conjunction with Method 18 contained in 40 CFR 60, Appendix A and adopted by reference in Rule 62-297, F.A.C. The minimum requirements for stationary point source emission test procedures and reporting shall be in accordance with Rule 62-297, F.A.C. and 40 CFR 60 Appendix A.

[Rule 62-297, F.A.C. and Alternate Sampling Procedure Order No. 97-G-01]

**12.** The permittee shall demonstrate compliance with the liquid fuel sulfur limit by the vendor providing a fuel analysis upon each fuel delivery or on analysis of as-received samples taken at the facility.

[Rules 62-213.440 and 62-296.406(3), F.A.C.]

**13.** The fuel sulfur content, percent by weight, for liquid fuels shall be evaluated using one of ASTM D2622-94, ASTM D4294-90(95), ASTM 1552-95, ASTM D1266-91, or both ASTM D4057-88 and ASTM D129-95 or latest editions.

[Rules 62-213.440, 62-296.406(3), 62-070(3), and 62-297.440, F.A.C.]

**14.** The maximum permitted process rates during compliance testing are as follows:

- a) peel dryer no. 1 - 27.0 tons/hr. wet peel input
- b) peel dryer no. 2 - 36.0 tons/hr. wet peel input
- c) pellet cooler - 13.8 tons/hr.

[Construction permit 0610021-005-AC]

**15. Compliance Schedule.** The applicant shall provide a construction permit application to reduce the potential to emit which are currently based upon construction permit 0610021-005-AC. **The revised construction permit shall be received within thirty days after issuance of the Final permit and will make federally enforceable the lowering of the potential to emit of VOC emissions.** In accordance with the following compliance schedule the emission units shall be in compliance with the following requirements within the specified time after issuance of this permit. The applicant shall notify the Department in writing, within 15 days after the date specified for each milestone, to include the achievement of compliance, of progress achieved, requirements met, requirements not met, corrective measures adopted and an explanation of any measures not met by the completion date for the milestone or for compliance. All reports shall be accompanied by a certification, signed by a responsible official in accordance with Rule 62-213.420(4), F.A.C.

<u>Referenced Standard</u>	<u>Task Description</u>	<u>Following Permit Issuance</u>
62-213.420(1)(b)2., F.A.C.	Submit updated CO & VOC potential to emit estimates and provide a PSD applicability	90 days

**AIR CONSTRUCTION PERMIT**  
**SECTION III. EMISSIONS UNITS SPECIFIC CONDITIONS**

---

determination.

62-213.420(1)(b)2., F.A.C.      Submit a proposed compliance procedure to determine VOC emissions, including parametric monitoring to provide a regular compliance demonstration between emission tests, such as measured oil recovery rates, etc.      90 days

62-297.310(6)(d)1. & 2, F.A.C.      Increase stack test platform width to 3 feet.      180 days

[Rule 62-213.440(2), F.A.C. and Title V application received June 12, 1996]

**Monitoring of Operations**

**16. Determination of Process Variables.**

(a) Required Equipment. The owner or operator of an emissions unit for which compliance tests are required shall install, operate, and maintain equipment or instruments necessary to determine process variables, such as process weight input or heat input, when such data are needed in conjunction with emissions data to determine the compliance of the emissions unit with applicable emission limiting standards.

(b) Accuracy of Equipment. Equipment or instruments used to directly or indirectly determine process variables, including devices such as belt scales, weight hoppers, flow meters, and tank scales, shall be calibrated and adjusted to indicate the true value of the parameter being measured with sufficient accuracy to allow the applicable process variable to be determined within 10% of its true value.

[Rule 62-297.310(5), F.A.C.]

**Recordkeeping and Reporting Requirements**

17. In order to demonstrate compliance with conditions no. A1, A2, A3, A4, A5, A7, and A8, the permittee shall maintain a log at the facility for a period of at least 5 years from the date the data is recorded. The log at a minimum shall contain the following:

Monthly

- a) month
  - fuel type and no. 2 fuel oil sulfur content
- b) consecutive 12 month total of:
  - process rates
  - hours of operation

**AIR CONSTRUCTION PERMIT**  
**SECTION III. EMISSIONS UNITS SPECIFIC CONDITIONS**

---

- particulate emissions
- SO2 emissions
- gallons no. 2 fuel oil fired

[Rules 62-4.070(3) and 62-213.440(1)(b)2., F.A.C.]

**18.** Compliance with the SO2 emission limitation shall be demonstrated by calculations based on keeping of records of the fuel oil sulfur content and fuel oil consumption for each combustion emission unit. Calculation of emissions shall be done each month and on a rolling twelve month total basis and shall be completed no later than 10 days following the end of each month. These records shall be recorded in a permanent form suitable for inspection by the Department upon request.

[Rule 62-4.070(3), F.A.C.]

**EMISSION LIMITING STANDARDS**

**19. General Visible Emissions Standard:** Except for emissions units that are subject to a particulate matter or opacity limit set forth or established by rule and reflected by conditions in this permit, no person shall cause, let, permit, suffer, or allow to be discharged into the atmosphere the emissions of air pollutants from any activity, the density of which is equal to or greater than that designated as Number 1 on the Ringelmann Chart (20% opacity). The test method for visible emissions shall be EPA Method 9, incorporated and adopted by reference in Chapter 62-297, F.A.C. Test procedures shall meet all applicable requirements of Chapter 62-297, F.A.C. [Rule 62-296.320(4)(b)1, F.A.C.]

**REPORTING AND RECORD KEEPING REQUIREMENTS**

**20. Records of Operating Hours Required:** The owner or operator shall make and maintain records of hours of operation of this emissions unit in units of hours per month and hours per consecutive 12 month period, to demonstrate compliance with the limit of condition 1 of this section. Records shall be made from daily operation records and shall be completed no later than the 10<sup>th</sup> day of each following month. [Rule 62-4.070(3), F.A.C., required to monitor compliance with the limitation on potential to emit]

**21. Records of Input Rate Required:** The owner or operator shall make and maintain records of the average rate of pressed peel input to the dryer, to demonstrate compliance with the requirements of condition 2 of this section. Records shall be made each day by dividing that day's total input rate of peel by that day's hours of operation of the dryer. [Rule 62-4.070(3), F.A.C., required to monitor compliance with the limitation on potential to emit]

**22. Records of Operation of Dryer Bypass Stack Required:** The owner or operator shall make records of the number of hours each day that the dryer is operated with emissions directed in total or in part through the bypass stack. The number of hours of bypass stack operation recorded each calendar quarter shall be reported to the Department's Central District office no later than the 10<sup>th</sup> day following each calendar quarter. [Rule 62-4.070(3), F.A.C.]

[Note: Excess emissions are limited by Rule 62-210.700, F.A.C., and previous Department permits. Those limitations are not changed by this permit.]

**APPENDIX GC**  
GENERAL PERMIT CONDITIONS [RULE 62-4.160, F.A.C.]

---

- G.1 The terms, conditions, requirements, limitations, and restrictions set forth in this permit are "Permit Conditions" and are binding and enforceable pursuant to Sections 403.161, 403.727, or 403.859 through 403.861, Florida Statutes. The permittee is placed on notice that the Department will review this permit periodically and may initiate enforcement action for any violation of these conditions.
- G.2 This permit is valid only for the specific processes and operations applied for and indicated in the approved drawings or exhibits. Any unauthorized deviation from the approved drawings or exhibits, specifications, or conditions of this permit may constitute grounds for revocation and enforcement action by the Department.
- G.3 As provided in Subsections 403.087(6) and 403.722(5), Florida Statutes, the issuance of this permit does not convey and vested rights or any exclusive privileges. Neither does it authorize any injury to public or private property or any invasion of personal rights, nor any infringement of federal, state or local laws or regulations. This permit is not a waiver or approval of any other Department permit that may be required for other aspects of the total project which are not addressed in the permit.
- G.4 This permit conveys no title to land or water, does not constitute State recognition or acknowledgment of title, and does not constitute authority for the use of submerged lands unless herein provided and the necessary title or leasehold interests have been obtained from the State. Only the Trustees of the Internal Improvement Trust Fund may express State opinion as to title.
- G.5 This permit does not relieve the permittee from liability for harm or injury to human health or welfare, animal, or plant life, or property caused by the construction or operation of this permitted source, or from penalties therefore; nor does it allow the permittee to cause pollution in contravention of Florida Statutes and Department rules, unless specifically authorized by an order from the Department.
- G.6 The permittee shall properly operate and maintain the facility and systems of treatment and control (and related appurtenances) that are installed or used by the permittee to achieve compliance with the conditions of this permit, as required by Department rules. This provision includes the operation of backup or auxiliary facilities or similar systems when necessary to achieve compliance with the conditions of the permit and when required by Department rules.
- G.7 The permittee, by accepting this permit, specifically agrees to allow authorized Department personnel, upon presentation of credentials or other documents as may be required by law and at a reasonable time, access to the premises, where the permitted activity is located or conducted to:
- (a) Have access to and copy and records that must be kept under the conditions of the permit;
  - (b) Inspect the facility, equipment, practices, or operations regulated or required under this permit, and,
  - (c) Sample or monitor any substances or parameters at any location reasonably necessary to assure compliance with this permit or Department rules.
- Reasonable time may depend on the nature of the concern being investigated.
- G.8 If, for any reason, the permittee does not comply with or will be unable to comply with any condition or limitation specified in this permit, the permittee shall immediately provide the Department with the following information:
- (a) A description of and cause of non-compliance; and
  - (b) The period of noncompliance, including dates and times; or, if not corrected, the anticipated time the non-compliance is expected to continue, and steps being taken to reduce, eliminate, and prevent recurrence of the non-compliance.



**APPENDIX GC**  
GENERAL PERMIT CONDITIONS [RULE 62-4.160, F.A.C.]

---

The permittee shall be responsible for any and all damages which may result and may be subject to enforcement action by the Department for penalties or for revocation of this permit.

- G.9 In accepting this permit, the permittee understands and agrees that all records, notes, monitoring data and other information relating to the construction or operation of this permitted source which are submitted to the Department may be used by the Department as evidence in any enforcement case involving the permitted source arising under the Florida Statutes or Department rules, except where such use is prescribed by Sections 403.73 and 403.111, Florida Statutes. Such evidence shall only be used to the extent it is consistent with the Florida Rules of Civil Procedure and appropriate evidentiary rules.
- G.10 The permittee agrees to comply with changes in Department rules and Florida Statutes after a reasonable time for compliance, provided, however, the permittee does not waive any other rights granted by Florida Statutes or Department rules.
- G.11 This permit is transferable only upon Department approval in accordance with Florida Administrative Code Rules 62-4.120 and 62-730.300, F.A.C., as applicable. The permittee shall be liable for any non-compliance of the permitted activity until the transfer is approved by the Department.
- G.12 This permit or a copy thereof shall be kept at the work site of the permitted activity.
- G.13 This permit also constitutes:
- (a) Determination of Best Available Control Technology ( );
  - (b) Determination of Prevention of Significant Deterioration ( ); and
  - (c) Compliance with New Source Performance Standards ( ).
- G.14 The permittee shall comply with the following:
- (a) Upon request, the permittee shall furnish all records and plans required under Department rules. During enforcement actions, the retention period for all records will be extended automatically unless otherwise stipulated by the Department.
  - (b) The permittee shall hold at the facility or other location designated by this permit records of all monitoring information (including all calibration and maintenance records and all original strip chart recordings for continuous monitoring instrumentation) required by the permit, copies of all reports required by this permit, and records of all data used to complete the application or this permit. These materials shall be retained at least three years from the date of the sample, measurement, report, or application unless otherwise specified by Department rule.
  - (c) Records of monitoring information shall include:
    - 1. The date, exact place, and time of sampling or measurements;
    - 2. The person responsible for performing the sampling or measurements;
    - 3. The dates analyses were performed;
    - 4. The person responsible for performing the analyses;
    - 5. The analytical techniques or methods used; and
    - 6. The results of such analyses.
- G.15 When requested by the Department, the permittee shall within a reasonable time furnish any information required by law which is needed to determine compliance with the permit. If the permittee becomes aware that relevant facts were not submitted or were incorrect in the permit application or in any report to the Department, such facts or information shall be corrected promptly.

# Florida Department of Environmental Protection

## Memorandum

TO: Howard L. Rhodes

THRU: Clair H. Fancy  
Scott Sheplak *sms*

FROM: Edward Svec

DATE: April 16, 2002

SUBJECT: Ocean Spray Cranberries, Inc. Vero Beach Facility  
Additional Operating Hours  
DEP File No: 0610021-009-AC

Attached for approval and signature is a final air construction permit for the increase in the plant's allowable operating hours of the peel dryers and pellet cooler which is accomplished through a cap in total fruit processing of 6.4 million boxes in a 12-month period. The applicant did not seek any relaxation in currently enforceable conditions in its other existing emissions units. There will be an emission increase of:

Pollutant	Net Increase	PSD Significance	Subject to PSD?
PM/ PM <sub>10</sub>	3.38/3.38	25/15	No
SO <sub>2</sub>	3.76	40	No
NO <sub>x</sub>	1.06	40	No
CO	5.02	100	No
VOC	39.14	40	No

The applicant did not seek any relaxation in currently enforceable conditions in its other existing emissions units.

No comments were received during the public comment period.

I recommend your approval and signature.

April 26, 2002 is day 90.

SMS/es  
Attachments

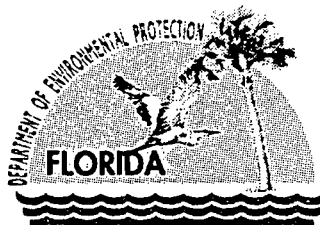

Jeb Bush  
Governor

# Department of Environmental Protection

Twin Towers Office Building  
2600 Blair Stone Road  
Tallahassee, Florida 32399-2400

David B. Struhs  
Secretary

February 27, 2002

Mr. Mark Smidebush  
Plant Manager  
Ocean Spray Cranberries, Inc.  
925 74<sup>th</sup> Avenue, Southwest  
Vero Beach, Florida 32968-9702

Re: DRAFT Title V Operation Permit Revision No.: 0610021-010-AV  
Draft Air Construction Permit No.: 0610021-009-AC  
Vero Beach Facility

Dear Mr. Smidebush:

Enclosed is one copy of the Technical Evaluation and Preliminary Determination and associated combined Air Construction Permit/Title V DRAFT Operation Permit Revision, for the Vero Beach Facility located at 925 74<sup>th</sup> Avenue, Southwest, Vero Beach, Indian River County. The Department's "INTENT TO ISSUE A COMBINED AIR CONSTRUCTION PERMIT/TITLE V OPERATION PERMIT REVISION" and the "PUBLIC NOTICE OF INTENT TO ISSUE A COMBINED AIR CONSTRUCTION PERMIT/TITLE V OPERATION PERMIT REVISION" are also included.

The "PUBLIC NOTICE OF INTENT TO ISSUE A COMBINED AIR CONSTRUCTION PERMIT/TITLE V OPERATION PERMIT REVISION" must be published one time only, as soon as possible, the legal advertising section of a newspaper of general circulation in the area affected, pursuant to the requirements of Chapter 50, Florida Statutes. Proof of publication, i.e., newspaper affidavit, must be provided to the Department's Bureau of Air Regulation office within 7 (seven) days of publication. Failure to publish the notice and provide proof of publication within the allotted time may result in the denial of the permit modification.

Please submit any written comments you wish to have considered concerning the Department's proposed action to Scott Sheplak, P.E., Administrator, Title V Section at the above letterhead address. If you have any questions, please call Mr. Edward J. Svec at 850/921-8985.

Sincerely,

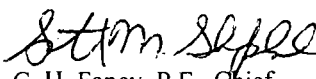
  
C. H. Fancy, P.E., Chief,  
Bureau of Air Regulation

CHF/es

Enclosures

U.S. EPA, Region 4 (INTERNET E-mail Memorandum)

"More Protection, Less Process"

Printed on recycled paper.

In the Matter of an  
Application for Permit by:

Mr. Mark Smidebush  
Plant Manager  
Ocean Spray Cranberries, Inc.  
925 74th Avenue, Southwest  
Vero Beach, Florida 32968-9702

Air Construction Permit No. 0610021-009-AC  
Title V Operation Permit Revision 0610021-010-AV  
Additional Operating Hours  
Vero Beach Facility  
Indian River County

**INTENT TO ISSUE A COMBINED AIR CONSTRUCTION PERMIT/TITLE V OPERATION PERMIT REVISION**

The Department of Environmental Protection (Department) gives notice of its intent to issue a combined Air Construction Permit/ Title V Operation Permit Revision (copy of the combined Draft Air Construction Permit/ Title V DRAFT Operation Permit Revision is attached) for the proposed project, detailed in the application specified above and the attached Technical Evaluation and Preliminary Determination, for the reasons stated below.

The applicant, Ocean Spray Cranberries, Inc., applied on November 26, 2001, to the Department to increase the plant's allowable operating hours of the peel dryers and pellet cooler which is accomplished through a cap in total fruit processing of 6.4 million boxes in a 12-month period at the Vero Beach Facility in Indian River County.

The Department has permitting jurisdiction under the provisions of Chapter 403, Florida Statutes (F.S.), Florida Administrative Code (F.A.C.) Chapters 62-4, 62-210, 62-212, 62-213, and 62-214. The Department has determined that a combined Air Construction Permit/ Title V Operation Permit Revision is required in order to: increase the allowable operating hours through a cap in total fruit processed in a 12-month period by the current Title V operating permit.

The Department intends to issue this combined Air Construction Permit/ Title V Operation Permit Revision based on the belief that reasonable assurances have been provided to indicate that operation of the Title V source will not adversely impact air quality, and the Title V source will comply with all appropriate provisions of Chapters 62-4, 62-204, 62-210, 62-212, 62-213, 62-214, 62-256, 62-257, 62-281, 62-296, and 62-297, F.A.C.

Pursuant to Section 403.815, F.S., and Rule 62-110.106(7)(a)1., F.A.C., you (the applicant) are required to publish at your own expense the enclosed "PUBLIC NOTICE OF INTENT TO ISSUE A COMBINED AIR CONSTRUCTION PERMIT/TITLE V OPERATION PERMIT REVISION." The notice shall be published one time only in the legal advertisement section of a newspaper of general circulation in the area affected. For the purpose of these rules, "publication in a newspaper of general circulation in the area affected" means publication in a newspaper meeting the requirements of Sections 50.011 and 50.031, F.S., in the county where the activity is to take place. Where there is more than one newspaper of general circulation in the county, the newspaper used must be one with significant circulation in the area that may be affected by the permit. If you are uncertain that a newspaper meets these requirements, please contact the Department at the address or telephone number listed below. The applicant shall provide proof of publication to the Department's Bureau of Air Regulation, at 2600 Blair Stone Road, Mail Station #5505, Tallahassee, Florida 32399-2400 (Telephone: 850/488-0114; Fax 850/ 922-6979). The Department suggests that you publish the notice within thirty days of receipt of this letter. You must provide proof of publication within seven days of publication, pursuant to Rule 62-110.106(5), F.A.C. No permitting action for which published notice is required shall be granted until proof of publication of notice is made by furnishing a uniform affidavit in substantially the form prescribed in section 50.051, F.S. to the office of the Department issuing the permit or other authorization. Failure to publish the notice and provide proof of publication may result in the denial of the permit pursuant to Rules 62-110.106(9) & (11), F.A.C.

The Department will issue combined Draft Air Construction Permit/ Title V PROPOSED Operation Permit Revision, and subsequent combined Final Air Construction Permit/ Title V FINAL Operation Permit Revision, in accordance with the conditions of the attached Draft Air Construction Permit/ Title V DRAFT Operation Permit Revision unless a response received in accordance with the following procedures results in a different decision or significant change of terms or conditions.

The Department will accept written comments concerning the proposed permit issuance action for a period of thirty (30) days from the date of publication of the "PUBLIC NOTICE OF INTENT TO ISSUE A COMBINED AIR CONSTRUCTION PERMIT/TITLE V OPERATION PERMIT REVISION." Written comments should be provided to the Department's Bureau of Air Regulation at 2600 Blair Stone Road, Mail Station #5505, Tallahassee, FL 32399-2400. Any written comments filed shall be made available for public inspection. If written comments received result in a significant change to this combine Draft Air Construction Permit/ Title V DRAFT Operation Permit Revision, the Department shall issue a combined Revised Draft Air Construction Permit/ Title V DRAFT Operation Permit Revision and require, if applicable, another Public Notice.

The Department will issue the Air Construction Permit with the attached conditions unless a timely petition for an administrative hearing is filed pursuant to sections 120.569 and 120.57 F.S., before the deadline for filing a petition. The procedures for petitioning for a hearing are set forth below.

A person whose substantial interests are affected by the proposed permitting decision may petition for an administrative proceeding (hearing) under sections 120.569 and 120.57 of the Florida Statutes. The petition must contain the information set forth below and must be filed (received) in the Office of General Counsel of the Department at 3900 Commonwealth Boulevard, Mail Station # 35, Tallahassee, Florida, 32399-3000. Petitions filed by the permit applicant or any of the parties listed below must be filed within fourteen days of receipt of this notice of intent. Petitions filed by any persons other than those entitled to written notice under section 120.60(3) of the Florida Statutes must be filed within fourteen days of publication of the public notice or within fourteen days of receipt of this notice of intent, whichever occurs first. Under section 120.60(3), however, any person who asked the Department for notice of agency action may file a petition within fourteen days of receipt of that notice, regardless of the date of publication. A petitioner shall mail a copy of the petition to the applicant at the address indicated above at the time of filing. The failure of any person to file a petition within the appropriate time period shall constitute a waiver of that person's right to request an administrative determination (hearing) under sections 120.569 and 120.57 F.S., or to intervene in this proceeding and participate as a party to it. Any subsequent intervention will be only at the approval of the presiding officer upon the filing of a motion in compliance with Rule 28-106.205 of the Florida Administrative Code.

A petition that disputes the material facts on which the Department's action is based must contain the following information: (a) The name and address of each agency affected and each agency's file or identification number, if known; (b) The name, address, and telephone number of the petitioner, the name, address, and telephone number of the petitioner's representative, if any, which shall be the address for service purposes during the course of the proceeding; and an explanation of how the petitioner's substantial interests will be affected by the agency determination; (c) A statement of how and when petitioner received notice of the agency action or proposed action; (d) A statement of all disputed issues of material fact. If there are none, the petition must so indicate; (e) A concise statement of the ultimate facts alleged, as well as the rules and statutes which entitle the petitioner to relief; and (f) A demand for relief.

A petition that does not dispute the material facts upon which the Department's action is based shall state that no such facts are in dispute and otherwise shall contain the same information as set forth above, as required by rule 28-106.301

Because the administrative hearing process is designed to formulate final agency action, the filing of a petition means that the Department's final action may be different from the position taken by it in this notice. Persons whose substantial interests will be affected by any such final decision of the Department on the application have the right to petition to become a party to the proceeding, in accordance with the requirements set forth above. Mediation is not available in this proceeding.

In addition to the above, a person subject to regulation has a right to apply for a variance from or waiver of the requirements of particular rules, on certain conditions, under Section 120.542 F.S. The relief provided by this state statute applies only to state rules, not statutes, and not to any federal regulatory requirements. Applying for a variance or waiver does not substitute or extend the time for filing a petition for an administrative hearing or exercising any other right that a person may have in relation to the action proposed in this notice of intent.

The application for a variance or waiver is made by filing a petition with the Office of General Counsel of the Department, 3900 Commonwealth Boulevard, Mail Station #35, Tallahassee, Florida 32399-3000. The petition must specify the following information: (a) The name, address, and telephone number of the petitioner; (b) The name, address, and telephone number of the attorney or qualified representative of the petitioner, if any; (c) Each rule or portion of a rule from which a variance or waiver is requested; (d) The citation to the statute underlying (implemented by) the rule identified in (c) above; (e) The type of action requested; (f) The specific facts that would justify a variance or waiver for the petitioner; (g) The reason why the variance or waiver would serve the purposes of the underlying statute (implemented by the rule); and (h) A statement whether the variance or waiver is permanent or temporary and, if temporary, a statement of the dates showing the duration of the variance or waiver requested.

The Department will grant a variance or waiver when the petition demonstrates both that the application of the rule would create a substantial hardship or violate principles of fairness, as each of those terms is defined in Section 120.542(2) F.S., and that the purpose of the underlying statute will be or has been achieved by other means by the petitioner.

Persons subject to regulation pursuant to any federally delegated or approved air program should be aware that Florida is specifically not authorized to issue variances or waivers from any requirements of any such federally delegated or approved program. The requirements of the program remain fully enforceable by the Administrator of the EPA and by any person under the Clean Air Act unless and until the Administrator separately approves any variance or waiver in accordance with the procedures of the federal program.

Finally, pursuant to 42 United States Code (U.S.C.) Section 7661d(b)(2), any person may petition the Administrator of the EPA within 60 (sixty) days of the expiration of the Administrator's 45 (forty-five) day review period as established at 42 U.S.C. Section 7661d(b)(1), to object to issuance of any permit. Any petition shall be based only on objections to the permit that were raised with reasonable specificity during the 30 (thirty) day public comment period provided in this notice, unless the petitioner demonstrates to the Administrator of the EPA that it was impracticable to raise such objections within the comment period or unless the grounds for such objection arose after the comment period. Filing of a petition with the Administrator of the EPA does not stay the effective date of any permit properly issued pursuant to the provisions of Chapter 62-213, F.A.C. Petitions filed with the Administrator of EPA must meet the requirements of 42 U.S.C. Section 7661d(b)(2) and must be filed with the Administrator of the EPA at: U.S. EPA, 401 M Street, S.W., Washington, D.C. 20460.

Executed in Tallahassee, Florida.

  
C. H. Fancy, P.E., Chief  
Bureau of Air Regulation

### CERTIFICATE OF SERVICE

The undersigned duly designated deputy agency clerk hereby certifies that this INTENT TO ISSUE A COMBINED AIR CONSTRUCTION/TITLE V OPERATION PERMIT REVISION (including the combined Draft Air Construction Permit/Title V DRAFT Operation Permit Revision) and all copies were sent by certified mail before the close of business on 2/28/02 to the person(s) listed:

Mark Smidebush, Plant Manager, Ocean Spray Cranberries, Inc.

In addition, the undersigned duly designated deputy agency clerk hereby certifies that copies of this INTENT TO ISSUE A COMBINED AIR CONSTRUCTION/TITLE V OPERATION PERMIT REVISION (including the combined Draft Air Construction Permit/Title V DRAFT Operation Permit Revision) were sent by U.S. mail on the same date to the person(s) listed:

Larry Stuart, P.E., Bottorf Associates, Inc.  
Leonard Kozlov, P.E., CD

Clerk Stamp

**FILING AND ACKNOWLEDGMENT FILED**, on this date, pursuant to §120.52, Florida Statutes, with the designated Department Clerk, receipt of which is hereby acknowledged.

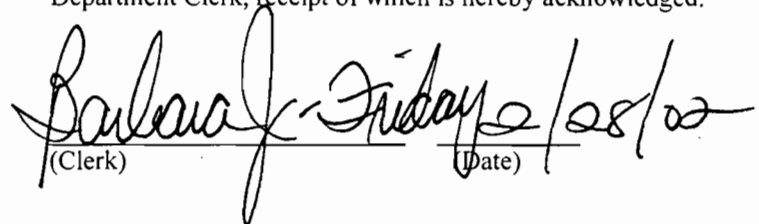
  
(Clerk) Friday 2/28/02 (Date)

**PUBLIC NOTICE OF INTENT TO ISSUE A COMBINED AIR CONSTRUCTION PERMIT/TITLE V  
OPERATION PERMIT REVISION**

STATE OF FLORIDA  
DEPARTMENT OF ENVIRONMENTAL PROTECTION

Air Construction Permit No. 0610021-009-AC  
Title V Operation Permit Revision No.: 0610021-010-AV

Ocean Spray Cranberries, Inc.  
Vero Beach Facility  
Indian River County

The Department of Environmental Protection (Department) gives notice of its intent to issue a combined Air Construction Permit/Title V Operation Permit Revision to Ocean Spray Cranberries, Inc. for the Vero Beach Facility located at 925 74th Avenue, Southwest, Vero Beach, Indian River County. The applicant's name and address are Ocean Spray Cranberries, Inc., 925 74th Avenue, Southwest, Vero Beach, Florida 32968-9702.

The Department will issue the combined Draft Air Construction Permit/Title V PROPOSED Operation Permit Revision, and subsequent combined Final Air Construction Permit/ Title V FINAL Operation Permit Revision, in accordance with the conditions of the attached Draft Air Construction Permit/ Title V DRAFT Operation Permit Revision unless a response received in accordance with the following procedures results in a different decision or significant change of terms or conditions. The Department has determined that a combined Air Construction Permit/ Title V Operation Permit Revision is required in order to: increase the plant's allowable operating hours which is accomplished through a cap in total fruit processing of 6.4 million boxes in a 12-month period.

The Department will accept written comments concerning the proposed combined Draft Air Construction Permit/Title V DRAFT Operation Permit Revision for a period of thirty (30) days from the date of publication of this notice. Written comments should be provided to the Department's Bureau of Air Regulation at 2600 Blair Stone Road, Mail Station #5505, Tallahassee, FL 32399-2400. Any written comments filed shall be made available for public inspection. If written comments received result in a significant change in this combined Draft Air Construction Permit/Title V DRAFT Operation Permit Revision, the Department shall issue a combined Revised Draft Air Construction Permit/Title V DRAFT Operation Permit Revision and require, if applicable, another Public Notice.

A person whose substantial interests are affected by the proposed permitting decision may petition for an administrative proceeding (hearing) under Sections 120.569 and 120.57 of the Florida Statutes. The petition must contain the information set forth below and must be filed (received) in the Office of General Counsel of the Department at 3900 Commonwealth Boulevard, Mail Station # 35, Tallahassee, Florida, 32399-3000. Petitions filed by the permit applicant or any of the parties listed below must be filed within fourteen (14) days of receipt of this notice of intent. Petitions filed by any persons other than those entitled to written notice under Section 120.60(3) of the Florida Statutes must be filed within fourteen days of publication of the public notice or within fourteen days of receipt of this notice of intent, whichever occurs first. Under Section 120.60(3), however, any person who asked the Department for notice of agency action may file a petition within fourteen (14) days of receipt of that notice, regardless of the date of publication. A petitioner shall mail a copy of the petition to the applicant at the address indicated above at the time of filing. The failure of any person to file a petition within the appropriate time period shall constitute a waiver of that person's right to request an administrative determination (hearing) under Sections 120.569 and 120.57 F.S., or to intervene in this proceeding and participate as a party to it. Any subsequent intervention will be only at the approval of the presiding officer upon the filing of a motion in compliance with Rule 28-106.205 of the Florida Administrative Code.

A petition that disputes the material facts on which the Department's action is based must contain the following information: (a) The name and address of each agency affected and each agency's file or identification number, if known; (b) The name, address, and telephone number of the petitioner, the name, address, and telephone number of the petitioner's representative, if any, which shall be the address for service purposes during the course of the proceeding; and an explanation of how the petitioner's substantial interests will be affected by the agency determination; (c) A statement of how and when petitioner received notice of the agency action or proposed action; (d) A statement of all disputed issues of material fact. If there are none, the petition must so indicate; (e) A concise statement of the ultimate facts alleged, as well as the rules and statutes which entitle the petitioner to relief; and (f) A demand for relief.

A petition that does not dispute the material facts upon which the Department's action is based shall state that no such facts are in dispute and otherwise shall contain the same information as set forth above, as required by Rule 28-106.301, F.A.C.

Because the administrative hearing process is designed to formulate final agency action, the filing of a petition means that the Department's final action may be different from the position taken by it in this notice. Persons whose substantial interests will be affected by any such final decision of the Department on the application have the right to petition to become a party to the proceeding, in accordance with the requirements set forth above.

Mediation is not available for this proceeding.

In addition to the above, pursuant to 42 United States Code (U.S.C.) Section 7661d(b)(2), any person may petition the Administrator of the EPA within 60 (sixty) days of the expiration of the Administrator's 45 (forty-five) day review period as established at 42 U.S.C. Section 7661d(b)(1), to object to issuance of any permit. Any petition shall be based only on objections to the permit that were raised with reasonable specificity during the 30 (thirty) day public comment period provided in this notice, unless the petitioner demonstrates to the Administrator of the EPA that it was impracticable to raise such objections within the comment period or unless the grounds for such objection arose after the comment period. Filing of a petition with the Administrator of the EPA does not stay the effective date of any permit properly issued pursuant to the provisions of Chapter 62-213, F.A.C. Petitions filed with the Administrator of EPA must meet the requirements of 42 U.S.C. Section 7661d(b)(2) and must be filed with the Administrator of the EPA at: U.S. EPA, 401 M Street, S.W., Washington, D.C. 20460.

A complete project file is available for public inspection during normal business hours, 8:00 a.m. to 5:00 p.m., Monday through Friday, except legal holidays, at:

Department of Environmental Protection  
Bureau of Air Regulation  
111 S. Magnolia Drive, Suite 4  
Tallahassee, Florida, 32301  
Telephone: 850/488-1344  
Fax: 850/922-6979

Department of Environmental Protection  
Central District Office  
3319 Maguire Blvd., Suite 232  
Orlando, Florida 32803  
Telephone: 407/894-7555  
Fax: 407/897-5963

The complete project file includes the application, the Technical Evaluation and Preliminary Determination, combined Draft Air Construction Permit/Title V DRAFT Operation Permit Revision, and the information submitted by the responsible official, exclusive of confidential records under Section 403.111, F.S. Interested persons may contact the Administrator, Title V Section at 111 South Magnolia Drive, Suite 4, Tallahassee, Florida 32301, or call 850/488-0114, for additional information.



**TECHNICAL EVALUATION AND DETERMINATION**

---

**1 APPLICANT NAME AND ADDRESS**

Ocean Spray Cranberries, Inc.  
925 74<sup>th</sup> Avenue, Southwest  
Vero Beach, Florida 32968-9702

Authorized Representative: Mark Smidebush, Plant Manager

**2 FACILITY DESCRIPTION, PROJECT DETAILS AND RULE APPLICABILITY**

The facility is an existing citrus juice processing facility. The project is a request for additional operation hours for the peel dryers and pellet cooler. The applicant did not seek any relaxation in currently enforceable conditions for its other existing emissions units.

The emissions units addressed by this permit are Citrus Peel Dryer No. 1, I.D. 004, Citrus Peel Dryer No. 2, I.D. 006, and, Pellet Cooler, I.D. 005.

The emissions increases associated with this project were estimated as follows in tons per year. No offsetting emissions were assumed in this estimate.

Pollutant	Net Increase <sup>1</sup>	PSD Significance	Subject to PSD?
PM/ PM <sub>10</sub>	3.38/3.38	25/15	No
SO <sub>2</sub>	3.76	40	No
NOx	1.06	40	No
CO	5.02	100	No
VOC	39.14	40	No

<sup>1</sup> Potential emissions (shown as net increase) were estimated by the Department from allowable natural gas, no. 2 fuel oil usage and AP-42 emission factors (tables 1.3-1 and 1.3-3 for fuel oil, tables 1.4-1 and 1.4-2 for natural gas), assuming a heat content of 1000 Btu/scf of natural gas and 138 million Btu/1000 gallons of distillate fuel oil, given a design heat input capacity of 70 mmBtu/hour, and the fuel use limits of the permit.

The proposed project is subject to preconstruction review requirements under the provisions of Chapter 403, F.S., and Chapters 62-4, 62-204, 62-210, 62-212 and 62-297, F.A.C. The existing facility is located in an area designated, in accordance with Rule 62-204.340, F.A.C., as attainment or unclassifiable for the criteria pollutants ozone, PM<sub>10</sub>, carbon monoxide, SO<sub>2</sub>, nitrogen dioxide and lead. This facility is classified as a Major or Title V Source of air pollution because emissions of at least one regulated air pollutant exceeds 100 tons per year (TPY). The Department has previously found that citrus juice processing facilities such as this facility have potential emissions of VOC exceeding 250 TPY.

This facility is not within an industry included in the list of the 28 Major Facility Categories per Table 212.400-1 of Chapter 62-212, F.A.C. Because emissions are greater than 250 TPY for at least one criteria pollutant (VOC), the facility is also an existing Major Facility with respect to Rule 62-212.400, F.A.C., Prevention of Significant Deterioration (PSD). The net increase in emissions of PM/PM<sub>10</sub>, NOx, SO<sub>2</sub>, CO and VOC do not exceed the PSD significance levels of Table 212.400-2 of Chapter 62-212, F.A.C. Therefore the project is not subject to PSD requirements of Rule 62-212.400, F.A.C., for these pollutants.

The applicant stated that this facility is not a major source of hazardous air pollutants (HAPs). This project is not subject to a case-by-case MACT determination, per Rule 62-204.800(10)(d)2, F.A.C., because it does not result in the construction or reconstruction of a major source of HAP emissions. This project is not subject to any requirements under the National Emissions Standards for Hazardous Air Pollutants, 40 CFR 61 or 63.

**3 SOURCE IMPACT ANALYSIS**

An impact analysis was not required for this project because it is not subject to the requirements of PSD.

**4 EXCESS EMISSIONS**

Excess emissions for this emissions unit are specified in Section II of the permit. This permitting action does not change any authorization for excess emissions provided by other Department permits for other emissions units

**5 LIMITS AND COMPLIANCE REQUIREMENTS**

The permit limits the total fruit processed by the plant in a 12-month period as the method of limiting emissions. Additional specific emission limits were not imposed because the potential emissions are well below the PSD significance criteria. The operating limits and the compliance requirements are detailed in Section III of the permit.

**6 PRELIMINARY DETERMINATION**

Based on the foregoing technical evaluation of the application and additional information submitted by the applicant and other available information, the Department has made a preliminary determination that the proposed project will comply with all applicable state and federal air pollution regulations. The Department's preliminary determination is to issue the draft permit to allow sufficient operating hours for the two peel dryers and pellet cooler to process 6.4 million boxes of citrus fruit in any consecutive 12 month period which can be accomplished in an estimated 3,737 hours, subject to the terms and conditions of the draft permit.

**7 FINAL DETERMINATION**

^DRAFT (This section will be revised when a final permit is issued for this project.)

**DETAILS OF THIS ANALYSIS MAY BE OBTAINED BY CONTACTING:**

Edward J. Svec, Engineer IV  
Department of Environmental Protection  
Bureau of Air Regulation  
Mail Station #5505  
2600 Blair Stone Road  
Tallahassee, Florida 32399-2400  
Telephone: 850/488-0114



# Department of Environmental Protection

Jeb Bush  
Governor

Twin Towers Office Building  
2600 Blair Stone Road  
Tallahassee, Florida 32399-2400

David B. Struhs  
Secretary

## PERMITTEE

Ocean Spray Cranberries, Inc.  
925 74th Avenue, Southwest  
Vero Beach, Florida 32968-9702

<b>Permit No.</b>	0610021-009-AC
<b>Project</b>	Additional Operating Hours
<b>SIC No.</b>	2037
<b>Expires:</b>	^DRAFT

## Authorized Representative:

Mark Smidebush, Plant Manager

## PROJECT AND LOCATION

This permit authorizes Ocean Spray Cranberries, Inc., to increase hours of operation necessary to process 6.4 million boxes of fruit in a 12-month period through the existing Peel Dryers and Pellet Mill.

This facility is located at 925 74th Avenue, Southwest, Vero Beach, Indian River County. The UTM coordinates are: Zone 17; 550.7 km E and 3051.3 km N.

## STATEMENT OF BASIS

This construction permit is issued under the provisions of Chapter 403 of the Florida Statutes (F.S.), and the Florida Administrative Code (F.A.C.) Chapters 62-4, 62-204, 62-210, 62-212, 62-296, and 62-297. The above named permittee is authorized to construct the emissions units in accordance with the conditions of this permit and as described in the application, approved drawings, plans, and other documents on file with the Department of Environmental Protection (Department).

## APPENDICES

The attached appendix is a part of this permit:

Appendix GC    General Permit Conditions

## DRAFT

---

Howard L. Rhodes, Director  
Division of Air Resources  
Management

**AIR CONSTRUCTION PERMIT**  
**SECTION I. FACILITY INFORMATION**

---

**FACILITY AND PROJECT DESCRIPTION**

This facility consists of two citrus peel dryers (nos. 1 and 2) equipped with a waste heat evaporator and an integral scrubber to control particulate emissions; one pellet cooler equipped with a cyclone to control particulate emissions; and three steam boilers (nos. 1, 2, and 3).

The applicant is requesting sufficient operating hours to process a maximum 6.4 million boxes of fruit per year. The applicant did not seek any relaxation in currently enforceable conditions in its other existing emissions units.

The emissions increases associated with this project were estimated as follows in tons per year. No offsetting emissions were assumed in this estimate.

<b>Pollutant</b>	<b>Net Increase<sup>1</sup></b>	<b>PSD Significance</b>	<b>Subject to PSD?</b>
PM/ PM <sub>10</sub>	3.38/3.38	25/15	No
SO <sub>2</sub>	3.76	40	No
NOx	1.06	40	No
CO	5.02	100	No
VOC	39.14	40	No

<sup>1</sup> Potential emissions (shown as net increase) were estimated by the Department from allowable natural gas, no. 2 fuel oil usage and AP-42 emission factors (tables 1.3-1 and 1.3-3 for fuel oil, tables 1.4-1 and 1.4-2 for natural gas), assuming a heat content of 1000 Btu/scf of natural gas and 138 million Btu/1000 gallons of distillate fuel oil, given a design heat input capacity of 70 mmBtu/hour, and the fuel use limits of the permit.

The facility information, project scope, emissions and rule applicability are described in detail in the Department's Technical Evaluation and Determination.

**REVIEWING AND PROCESS SCHEDULE**

November 26, 2001	Received permit application (no application fee required)
December 11, 2001	Application complete
^DRAFT	Distributed Notice of Intent to Issue and supporting documents
^DRAFT	Notice of Intent published in ^DRAFT

**RELEVANT DOCUMENTS**

The documents listed below are the basis of the permit. They are specifically related to this permitting action. These documents are on file with the Department.

- Permit application
- Department's Technical Evaluation and Determination
- Department's Intent to Issue

## AIR CONSTRUCTION PERMIT

### SECTION II. FACILITY-WIDE SPECIFIC CONDITIONS

---

The following specific conditions apply to all emissions units at this facility addressed by this permit.

#### ADMINISTRATIVE

1. Regulating Agencies: All documents related to applications for permits to construct, operate or modify an emissions unit should be submitted to the Bureau of Air Regulation (BAR), Florida Department of Environmental Protection at Mail Station #5505, 2600 Blair Stone Road, Tallahassee, Florida 32399-2400, phone number 850/488-0114. All documents related to reports, tests, minor modifications and notifications shall be submitted to the Department's Central District office at 3319 Maguire Blvd., Suite 232, Orlando, Florida 32803, and phone number 407/894-7555.
2. General Conditions: The owner and operator is subject to and shall operate under the attached General Permit Conditions G.1 through G.15 listed in Appendix GC of this permit. General Permit Conditions are binding and enforceable pursuant to Chapter 403, F.S. [Rule 62-4.160, F.A.C.]
3. Terminology: The terms used in this permit have specific meanings as defined in the corresponding chapters of the Florida Administrative Code.
4. Applicable Regulations, Forms and Application Procedures: Unless otherwise indicated in this permit, the construction and operation of the subject emissions unit shall be in accordance with the capacities and specifications stated in the application. The facility is subject to all applicable provisions of Chapter 403, F.S.; Chapters 62-4, 62-110, 62-204, 62-212, 62-213, 62-296, 62-297, F.A.C.; and, the Code of Federal Regulations Title 40, Part 60, adopted by reference in the F.A.C. regulations. The permittee shall use the applicable forms listed in Rule 62-210.900, F.A.C. and follow the application procedures in Chapter 62-4, F.A.C. Issuance of this permit does not relieve the facility owner or operator from compliance with any applicable federal, state, or local permitting or regulations. [Rules 62-204.800, 62-210.300 and 62-210.900, F.A.C.]
5. New or Additional Conditions: Pursuant to Rule 62-4.080, F.A.C., for good cause shown and after notice and an administrative hearing, if requested, the Department may require the permittee to conform to new or additional conditions. The Department shall allow the permittee a reasonable time to conform to the new or additional conditions, and on application of the permittee, the Department may grant additional time. [Rule 62-4.080, F.A.C.]
6. Expiration: This air construction permit shall expire on ^DRAFT. The permittee, for good cause, may request that this construction permit be extended. Such a request shall be submitted to the Department's Bureau of Air Regulation prior to 60 days before the expiration of the permit. [Rules 62-210.300(1), 62-4.070(4), 62-4.080, and 62-4.210, F.A.C.]
7. Modifications: No emissions unit or facility subject to this permit shall be constructed or modified without obtaining an air construction permit from the Department. Such permit must be obtained prior to the beginning of construction or modification. [Rules 62-210.300(1) and 62-212.300(1)(a), F.A.C.]
8. Title V Operation Permit Required: This permit authorizes construction and/or installation of the permitted emissions unit and initial operation to determine compliance with Department rules. A revision to the Title V operation permit is required for regular operation of the permitted emissions unit. The owner or operator shall apply for a Title V operation permit at least ninety days prior to expiration of this permit, but no later than 180 days after commencing operation. To apply for a

## AIR CONSTRUCTION PERMIT

### SECTION II. FACILITY-WIDE SPECIFIC CONDITIONS

---

Title V operation permit, the applicant shall submit the appropriate application form, compliance test results, and such additional information as the Department may by law require. The application shall be submitted to the Department's Central District office. [Rules 62-4.030, 62-4.050, 62-4.220, and Chapter 62-213, F.A.C.]

#### OPERATIONAL REQUIREMENTS

9. Plant Operation - Problems: If temporarily unable to comply with any of the conditions of the permit due to breakdown of equipment or destruction by hazard of fire, wind or by other cause, the permittee shall immediately notify the Department's Central District office. The notification shall include pertinent information as to the cause of the problem, and what steps are being taken to correct the problem and to prevent its recurrence, and where applicable, the owner's intent toward reconstruction of destroyed facilities. Such notification does not release the permittee from any liability for failure to comply with Department rules. [Rule 62-4.130, F.A.C.]
10. Circumvention: No person shall circumvent any air pollution control device or allow the emission of air pollutants without the applicable air pollution control device operating properly. [Rule 62-210.650, F.A.C.]
11. Excess Emissions: This permit does not change any authorization for excess emissions provided by other Department permits for other emissions units. The following excess emissions provisions of state rule apply to these emissions units (emissions unit I.D. 004, 005, and 006) as specified below.
  - (a) Excess emissions resulting from start-up and shutdown are permitted providing (1) best operational practices to minimize emissions are adhered to and (2) the duration of excess emissions shall be minimized, but in no case exceed two hours in any 24 hour period.
  - (b) Excess emissions resulting from malfunction of this emissions unit shall be permitted providing (1) best operational practices to minimize emissions are adhered to and (2) the duration of excess emissions shall be minimized, but in no case exceed two hours in any 24 hour period unless specifically authorized by the Department for longer duration.
  - (c) Excess emissions which are caused entirely or in part by poor maintenance, poor operation, or any other equipment or process failure which may reasonably be prevented during start-up, shutdown, or malfunction shall be prohibited.

[Rules 62-210.700(1), (4) and (5), F.A.C.]

#### COMPLIANCE MONITORING AND TESTING REQUIREMENTS

12. Determination of Process Variables: [Rule 62-297.310(5), F.A.C.]
  - (a) Required Equipment. The owner or operator of an emissions unit for which compliance tests are required shall install, operate, and maintain equipment or instruments necessary to determine process variables, such as process weight input or heat input, when such data are needed in conjunction with emissions data to determine the compliance of the emissions unit with applicable emission limiting standards.
  - (b) Accuracy of Equipment. Equipment or instruments used to directly or indirectly determine process variables, including devices such as belt scales, weight hoppers, flow meters, and tank scales, shall be calibrated and adjusted to indicate the true value of the parameter being measured

**AIR CONSTRUCTION PERMIT**  
**SECTION II. FACILITY-WIDE SPECIFIC CONDITIONS**

---

with sufficient accuracy to allow the applicable process variable to be determined within 10% of its true value.

**REPORTING AND RECORD KEEPING REQUIREMENTS**

13. Duration of Record Keeping: Upon request, the permittee shall furnish all records and plans required under Department rules. During enforcement actions, the retention period for all records will be extended automatically unless otherwise stipulated by the Department. The permittee shall hold at the facility or other location designated by this permit records of all monitoring information (including all calibration and maintenance records and all original strip chart recordings for continuous monitoring instrumentation) required by the permit, copies of all reports required by this permit, and records of all data used to complete the application for this permit. These materials shall be retained at least five years from the date of the sample, measurement, report, or application unless otherwise specified by Department rule. [Rules 62-4.160(14)(a)&(b) and 62-213.440(1)(b)2.b., F.A.C.]
14. Excess Emissions Report: In case of excess emissions resulting from malfunction, the owner or operator shall notify the Department's Central District office within one working day of: the nature, extent, and duration of the excess emissions; the cause of the excess emissions; and the actions taken to correct the problem. In addition, the Department may request a written summary report of the incident. A full written report on the malfunctions shall be submitted in a quarterly report if requested by the Department. [Rules 62-4.130 and 62-210.700(6), F.A.C.]
15. Annual Operating Report for Air Pollutant Emitting Facility: The Annual Operating Report for Air Pollutant Emitting Facility shall be completed each year and shall be submitted to the Department's Central District office and, if applicable, the appropriate local program by March 1 of the following year. [Rule 62-210.370(3), F.A.C.]

**AIR CONSTRUCTION PERMIT**  
**SECTION III. EMISSIONS UNITS SPECIFIC CONDITIONS**

---

The following specific conditions apply to the following emissions units after construction.

**E.U. ID**

<b><u>No.</u></b>	<b><u>Brief Description</u></b>
-004	Citrus Peel Dryer No. 1
-006	Citrus Peel Dryer No. 2
-005	Pellet Cooler

Citrus peel dryers (nos. 1 and 2) are equipped with a waste heat evaporator and an integral scrubber to control particulate emissions. The pellet cooler is equipped with a cyclone to control particulate emissions.

These emissions units are regulated under Rule 62-296.320, F.A.C., General Pollutant Emission Limiting Standards.

**The following specific conditions apply to the emissions unit(s) listed above:**

**Essential Potential to Emit (PTE) Parameters**

**1. Capacity.**

- a. The maximum process input rate (wet peel) to peel dryer no. 1 shall not exceed 95,256 tons per twelve consecutive months.
- b. The maximum process input rate (wet peel) to peel dryer no. 2 shall not exceed 127,008 tons per twelve consecutive months.
- c. The maximum process rate, which includes moisture, for the pellet cooler shall not exceed 48,686 tons per twelve consecutive months.
- d. The maximum process input rate (wet peel) to both dryers shall not exceed 127,008 tons per twelve consecutive months.

[Rules 62-4.160(2), F.A.C. and 62-210.200, (PTE), F.A.C. and construction permit 0610021-005-AC]

**2. Fruit Throughput Limited:** The owner or operator shall not process more than 6.4 million boxes of citrus fruit in any consecutive 12 month period. For purposes of this permit, a box of citrus fruit shall be defined to contain 90 pounds of oranges or 85 pounds of grapefruit. The owner or operator shall make and maintain monthly and rolling 12 month records of fruit processing rates to demonstrate compliance with this limitation. Such records shall be made from daily processing records and shall be completed no later than the 10<sup>th</sup> day of each following month. [Rule 62-4.070(3), F.A.C. and 0610021-009-AC]

**3. Methods of Operation - (i.e., Fuels).**

The fuel used by the peel dryers shall be limited to natural gas, propane, or new no. 2 fuel oil with a sulfur content not to exceed 0.5% S by weight. The maximum fuel usage rate for the two citrus peel dryers shall not exceed 1,265,494 gallons (combined total) per twelve consecutive months.

[Rules 62-210.200, (PTE), F.A.C. and 62-4.160(2), F.A.C., and construction permit 0610021-005-AC]

**4. Hours of Operation.** For emission calculations, the hours of operation for these emissions units are estimated not to exceed 3,737 hours per year.



**AIR CONSTRUCTION PERMIT**  
**SECTION III. EMISSIONS UNITS SPECIFIC CONDITIONS**

---

\*Dryers No. 1 and 2 shall not operate simultaneously.  
[Rules 62-4.160(2) and 62-210.200(PTE), F.A.C. and construction permit 0610021-009-AC]

**EMISSION LIMITATIONS AND STANDARDS**

5. Peel dryers no. 1 and 2 are subject to Rule 62-296.320(4)(a) Process Weight Table 296.320-1, F.A.C. The maximum process weight is 27.0 tons/hour (dryer no. 1) and 36.0 tons/hour (dryer no. 2) and, as requested by the applicant, the emission rate is capped at 17.3 pounds per hour from each dryer and annual emissions are capped at a total of 32.32 tons per any consecutive twelve month period from both dryers since both dryers can not be operated simultaneously.

[Construction permit 0610021-009-AC and Rule 62-296.320(4)(a), F.A.C.]

6. The pellet cooler is subject to Rule 62-296.320(4)(a) Process Weight Table 296.320-1, F.A.C. The maximum process weight is 13.8 tons/hour and, as requested by the applicant, the emission rate is capped at 15.0 pounds per hour and annual emissions are capped at 28.03 tons per any consecutive twelve month period. For lower process rates, i.e. those below 10.0 tons per hour, the process weight rule equation limitation will be the more stringent limitation.

[Construction permit 0610021-009-AC and Rule 62-296.320(4)(a), F.A.C.]

7. Visible emissions from each emission unit shall not be equal to or greater than 20% opacity.

[Rule 62-296.320(4)(b)(1), F.A.C.]

8. Emissions of sulfur dioxide (SO<sub>2</sub>) from peel dryers no. 1 and 2 shall not exceed 44.93 tons per twelve consecutive months (combined total), as requested by the applicant.

[Construction permit 0610021-005-AC]

**Test Methods and Procedures**

9. Each peel dryer shall be tested for visible emissions for a 30 minute period annually on, or during the 60 day period prior to January 30. Each peel dryer shall be tested for particulate matter emissions prior to permit renewal. (Note that peel dryer no. 2 shall be tested within 30 days after being placed in operation.) Testing of emissions must be conducted when the emission unit being tested is in operation and the test observation period shall include the period during which the highest opacity emissions can reasonably be expected to occur. A statement of each units process input rate and the fuel type and heat input rate shall be included with all test reports.

[Rules 62-297.310(7)(a), F.A.C. and 62-4.070(3), F.A.C.]

10. The pellet cooler shall be tested for visible emissions for a 30 minute period annually on or during the 60 day period prior to January 30. The pellet cooler shall be tested for particulate matter emissions prior to permit renewal. (Note that the pellet cooler shall be tested within 30 days after being placed in operation at its higher permitted capacity.) Testing of emissions must be conducted when the emission

**AIR CONSTRUCTION PERMIT**

**SECTION III. EMISSIONS UNITS SPECIFIC CONDITIONS**

---

unit being tested is in operation and the test observation period shall include the period during which the highest opacity emissions can reasonably be expected to occur. A statement of the units process rate shall be included with all test reports.

[Rules 62-297.310(7)(a), F.A.C. and 62-4.070(3), F.A.C.]

**11.** Compliance with the emission limitations shall be determined using EPA Methods 1, 2, 3, 4, 5, 9, 10, and 25A or Method 25A in conjunction with Method 18 contained in 40 CFR 60, Appendix A and adopted by reference in Rule 62-297, F.A.C. The minimum requirements for stationary point source emission test procedures and reporting shall be in accordance with Rule 62-297, F.A.C. and 40 CFR 60 Appendix A.

[Rule 62-297, F.A.C. and Alternate Sampling Procedure Order No. 97-G-01]

**12.** The permittee shall demonstrate compliance with the liquid fuel sulfur limit by the vendor providing a fuel analysis upon each fuel delivery or on analysis of as-received samples taken at the facility.

[Rules 62-213.440 and 62-296.406(3), F.A.C.]

**13.** The fuel sulfur content, percent by weight, for liquid fuels shall be evaluated using one of ASTM D2622-94, ASTM D4294-90(95), ASTM 1552-95, ASTM D1266-91, or both ASTM D4057-88 and ASTM D129-95 or latest editions.

[Rules 62-213.440, 62-296.406(3), 62-070(3), and 62-297.440, F.A.C.]

**14.** The maximum permitted process rates during compliance testing are as follows:

- a) peel dryer no. 1 - 27.0 tons/hr. wet peel input
- b) peel dryer no. 2 - 36.0 tons/hr. wet peel input
- c) pellet cooler - 13.8 tons/hr.

[Construction permit 0610021-005-AC]

**15. Compliance Schedule.** The applicant shall provide a construction permit application to reduce the potential to emit which are currently based upon construction permit 0610021-005-AC. **The revised construction permit shall be received within thirty days after issuance of the Final permit and will make federally enforceable the lowering of the potential to emit of VOC emissions.** In accordance with the following compliance schedule the emission units shall be in compliance with the following requirements within the specified time after issuance of this permit. The applicant shall notify the Department in writing, within 15 days after the date specified for each milestone, to include the achievement of compliance, of progress achieved, requirements met, requirements not met, corrective measures adopted and an explanation of any measures not met by the completion date for the milestone or for compliance. All reports shall be accompanied by a certification, signed by a responsible official in accordance with Rule 62-213.420(4), F.A.C.

<u>Referenced Standard</u>	<u>Task Description</u>	<u>Following Permit Issuance</u>
62-213.420(1)(b)2., F.A.C.	Submit updated CO & VOC potential to emit estimates and provide a PSD applicability	90 days

**AIR CONSTRUCTION PERMIT**  
**SECTION III. EMISSIONS UNITS SPECIFIC CONDITIONS**

---

determination.

62-213.420(1)(b)2., F.A.C.	Submit a proposed compliance procedure to determine VOC emissions, including parametric monitoring to provide a regular compliance demonstration between emission tests, such as measured oil recovery rates, etc.	90 days
62-297.310(6)(d)1. & 2, F.A.C.	Increase stack test platform width to 3 feet.	180 days

[Rule 62-213.440(2), F.A.C. and Title V application received June 12, 1996]

**Monitoring of Operations**

**16. Determination of Process Variables.**

(a) **Required Equipment.** The owner or operator of an emissions unit for which compliance tests are required shall install, operate, and maintain equipment or instruments necessary to determine process variables, such as process weight input or heat input, when such data are needed in conjunction with emissions data to determine the compliance of the emissions unit with applicable emission limiting standards.

(b) **Accuracy of Equipment.** Equipment or instruments used to directly or indirectly determine process variables, including devices such as belt scales, weight hoppers, flow meters, and tank scales, shall be calibrated and adjusted to indicate the true value of the parameter being measured with sufficient accuracy to allow the applicable process variable to be determined within 10% of its true value.

[Rule 62-297.310(5), F.A.C.]

**Recordkeeping and Reporting Requirements**

**17.** In order to demonstrate compliance with conditions no. A1, A2, A3, A4, A5, A7, and A8, the permittee shall maintain a log at the facility for a period of at least 5 years from the date the data is recorded. The log at a minimum shall contain the following:

Monthly

- a) month
  - fuel type and no. 2 fuel oil sulfur content
- b) consecutive 12 month total of:
  - process rates
  - hours of operation

## AIR CONSTRUCTION PERMIT

### SECTION III. EMISSIONS UNITS SPECIFIC CONDITIONS

---

- particulate emissions
- SO2 emissions
- gallons no. 2 fuel oil fired

[Rules 62-4.070(3) and 62-213.440(1)(b)2., F.A.C.]

18. Compliance with the SO2 emission limitation shall be demonstrated by calculations based on keeping of records of the fuel oil sulfur content and fuel oil consumption for each combustion emission unit. Calculation of emissions shall be done each month and on a rolling twelve month total basis and shall be completed no later than 10 days following the end of each month. These records shall be recorded in a permanent form suitable for inspection by the Department upon request.

[Rule 62-4.070(3), F.A.C.]

#### EMISSION LIMITING STANDARDS

19. General Visible Emissions Standard: Except for emissions units that are subject to a particulate matter or opacity limit set forth or established by rule and reflected by conditions in this permit, no person shall cause, let, permit, suffer, or allow to be discharged into the atmosphere the emissions of air pollutants from any activity, the density of which is equal to or greater than that designated as Number 1 on the Ringelmann Chart (20% opacity). The test method for visible emissions shall be EPA Method 9, incorporated and adopted by reference in Chapter 62-297, F.A.C. Test procedures shall meet all applicable requirements of Chapter 62-297, F.A.C. [Rule 62-296.320(4)(b)1, F.A.C.]

#### REPORTING AND RECORD KEEPING REQUIREMENTS

20. Records of Operating Hours Required: The owner or operator shall make and maintain records of hours of operation of this emissions unit in units of hours per month and hours per consecutive 12 month period, to demonstrate compliance with the limit of condition 1 of this section. Records shall be made from daily operation records and shall be completed no later than the 10<sup>th</sup> day of each following month. [Rule 62-4.070(3), F.A.C., required to monitor compliance with the limitation on potential to emit]

21. Records of Input Rate Required: The owner or operator shall make and maintain records of the average rate of pressed peel input to the dryer, to demonstrate compliance with the requirements of condition 2 of this section. Records shall be made each day by dividing that day's total input rate of peel by that day's hours of operation of the dryer. [Rule 62-4.070(3), F.A.C., required to monitor compliance with the limitation on potential to emit]

22. Records of Operation of Dryer Bypass Stack Required: The owner or operator shall make records of the number of hours each day that the dryer is operated with emissions directed in total or in part through the bypass stack. The number of hours of bypass stack operation recorded each calendar quarter shall be reported to the Department's Central District office no later than the 10<sup>th</sup> day following each calendar quarter. [Rule 62-4.070(3), F.A.C.]

[Note: Excess emissions are limited by Rule 62-210.700, F.A.C., and previous Department permits. Those limitations are not changed by this permit.]

**APPENDIX GC**  
GENERAL PERMIT CONDITIONS [RULE 62-4.160, F.A.C.]

---

- G.1 The terms, conditions, requirements, limitations, and restrictions set forth in this permit are "Permit Conditions" and are binding and enforceable pursuant to Sections 403.161, 403.727, or 403.859 through 403.861, Florida Statutes. The permittee is placed on notice that the Department will review this permit periodically and may initiate enforcement action for any violation of these conditions.
- G.2 This permit is valid only for the specific processes and operations applied for and indicated in the approved drawings or exhibits. Any unauthorized deviation from the approved drawings or exhibits, specifications, or conditions of this permit may constitute grounds for revocation and enforcement action by the Department.
- G.3 As provided in Subsections 403.087(6) and 403.722(5), Florida Statutes, the issuance of this permit does not convey and vested rights or any exclusive privileges. Neither does it authorize any injury to public or private property or any invasion of personal rights, nor any infringement of federal, state or local laws or regulations. This permit is not a waiver or approval of any other Department permit that may be required for other aspects of the total project which are not addressed in the permit.
- G.4 This permit conveys no title to land or water, does not constitute State recognition or acknowledgment of title, and does not constitute authority for the use of submerged lands unless herein provided and the necessary title or leasehold interests have been obtained from the State. Only the Trustees of the Internal Improvement Trust Fund may express State opinion as to title.
- G.5 This permit does not relieve the permittee from liability for harm or injury to human health or welfare, animal, or plant life, or property caused by the construction or operation of this permitted source, or from penalties therefore; nor does it allow the permittee to cause pollution in contravention of Florida Statutes and Department rules, unless specifically authorized by an order from the Department.
- G.6 The permittee shall properly operate and maintain the facility and systems of treatment and control (and related appurtenances) that are installed or used by the permittee to achieve compliance with the conditions of this permit, as required by Department rules. This provision includes the operation of backup or auxiliary facilities or similar systems when necessary to achieve compliance with the conditions of the permit and when required by Department rules.
- G.7 The permittee, by accepting this permit, specifically agrees to allow authorized Department personnel, upon presentation of credentials or other documents as may be required by law and at a reasonable time, access to the premises, where the permitted activity is located or conducted to:
- (a) Have access to and copy and records that must be kept under the conditions of the permit;
  - (b) Inspect the facility, equipment, practices, or operations regulated or required under this permit, and,
  - (c) Sample or monitor any substances or parameters at any location reasonably necessary to assure compliance with this permit or Department rules.
- Reasonable time may depend on the nature of the concern being investigated.
- G.8 If, for any reason, the permittee does not comply with or will be unable to comply with any condition or limitation specified in this permit, the permittee shall immediately provide the Department with the following information:
- (a) A description of and cause of non-compliance; and
  - (b) The period of noncompliance, including dates and times; or, if not corrected, the anticipated time the non-compliance is expected to continue, and steps being taken to reduce, eliminate, and prevent recurrence of the non-compliance.

**APPENDIX GC**  
GENERAL PERMIT CONDITIONS [RULE 62-4.160, F.A.C.]

---

The permittee shall be responsible for any and all damages which may result and may be subject to enforcement action by the Department for penalties or for revocation of this permit.

- G.9 In accepting this permit, the permittee understands and agrees that all records, notes, monitoring data and other information relating to the construction or operation of this permitted source which are submitted to the Department may be used by the Department as evidence in any enforcement case involving the permitted source arising under the Florida Statutes or Department rules, except where such use is prescribed by Sections 403.73 and 403.111, Florida Statutes. Such evidence shall only be used to the extent it is consistent with the Florida Rules of Civil Procedure and appropriate evidentiary rules.
- G.10 The permittee agrees to comply with changes in Department rules and Florida Statutes after a reasonable time for compliance, provided, however, the permittee does not waive any other rights granted by Florida Statutes or Department rules.
- G.11 This permit is transferable only upon Department approval in accordance with Florida Administrative Code Rules 62-4.120 and 62-730.300, F.A.C., as applicable. The permittee shall be liable for any non-compliance of the permitted activity until the transfer is approved by the Department.
- G.12 This permit or a copy thereof shall be kept at the work site of the permitted activity.
- G.13 This permit also constitutes:
- (a) Determination of Best Available Control Technology ( );
  - (b) Determination of Prevention of Significant Deterioration ( ); and
  - (c) Compliance with New Source Performance Standards ( ).
- G.14 The permittee shall comply with the following:
- (a) Upon request, the permittee shall furnish all records and plans required under Department rules. During enforcement actions, the retention period for all records will be extended automatically unless otherwise stipulated by the Department.
  - (b) The permittee shall hold at the facility or other location designated by this permit records of all monitoring information (including all calibration and maintenance records and all original strip chart recordings for continuous monitoring instrumentation) required by the permit, copies of all reports required by this permit, and records of all data used to complete the application or this permit. These materials shall be retained at least three years from the date of the sample, measurement, report, or application unless otherwise specified by Department rule.
  - (c) Records of monitoring information shall include:
    - 1. The date, exact place, and time of sampling or measurements;
    - 2. The person responsible for performing the sampling or measurements;
    - 3. The dates analyses were performed;
    - 4. The person responsible for performing the analyses;
    - 5. The analytical techniques or methods used; and
    - 6. The results of such analyses.
- G.15 When requested by the Department, the permittee shall within a reasonable time furnish any information required by law which is needed to determine compliance with the permit. If the permittee becomes aware that relevant facts were not submitted or were incorrect in the permit application or in any report to the Department, such facts or information shall be corrected promptly.



Jeb Bush  
Governor

# Department of Environmental Protection

Twin Towers Office Building  
2600 Blair Stone Road  
Tallahassee, Florida 32399-2400

David B. Struhs  
Secretary

*Patty Adams*

## P.E. Certification Statement

**Permittee:**  
Ocean Spray Cranberries, Inc.

**DRAFT Permit No.:** 0610021-009-AC  
**DRAFT Permit No.:** 0610021-010-AV

**Project type:** Air Construction (Modification)/Title V Revision

*I HEREBY CERTIFY that the engineering features described in the above referenced application and subject to the proposed permit conditions provide reasonable assurance of compliance with applicable provisions of Chapter 403, Florida Statutes, and Florida Administrative Code Chapters 62-4 and 62-204 through 62-297. However, I have not evaluated and I do not certify aspects of the proposal outside of my area of expertise (including but not limited to the electrical, mechanical, structural, hydrological, and geological features).*

*Scott M. Sheplak*      02/27/02  
Scott M. Sheplak, P.E.      date  
Registration Number: 48866

Permitting Authority:  
Department of Environmental Protection  
Bureau of Air Regulation  
111 South Magnolia Drive, Suite 4  
Tallahassee, Florida 32301  
Telephone: 850/921-9532  
Fax: 850/922-6979

### FAX COVER PAGE

<b>To</b>	Ed Svec
<b>Company</b>	FDEP
<b>Dept.</b>	
<b>Fax #</b>	850-922-6979

<b>From</b>	Brian Bogart
<b>Company</b>	Ocean Spray Cranberries
<b>Phone #</b>	(561) 562-0800
<b>Fax #</b>	(561) 562-1215
<b>Date</b>	December 11, 2001
Page 1 of 2	

**RECEIVED**

DEC 11 2001

BUREAU OF AIR REGULATION

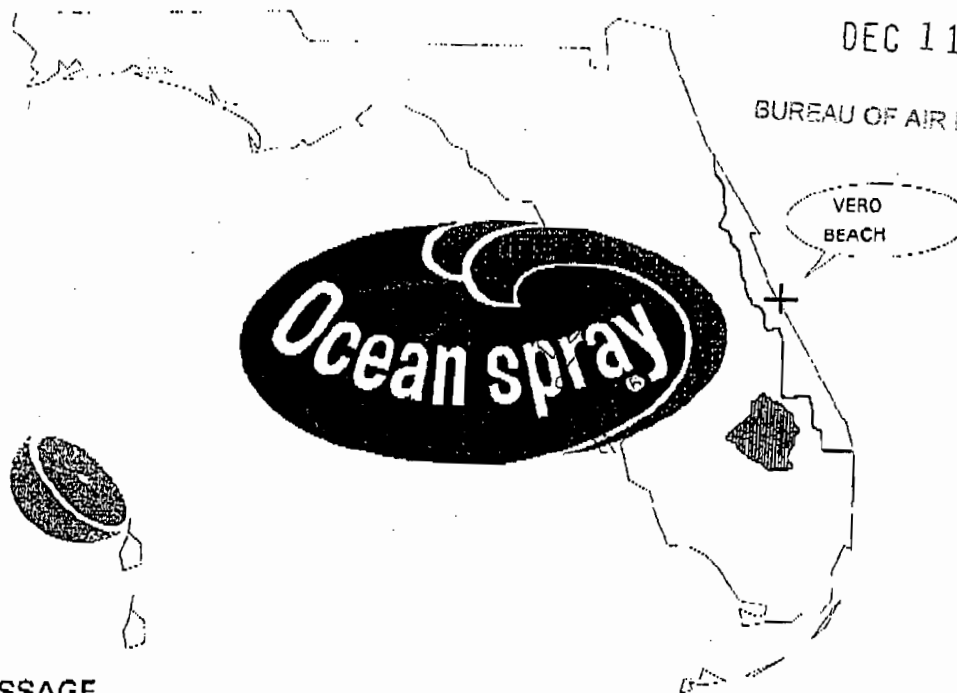

MESSAGE

Ed: Here is the information that you requested from me. When you get back into the office give me a call.

Thanks, Brian



**Ocean Spray Cranberries, Inc.**

925 74th Avenue, S.W., Vero Beach, FL 32968  
(561) 562-0800, FAX (561) 562-1215

December 10, 2001

Florida Department of Environmental Protection  
Division of Air Resources Management  
2600 Blair Stone Road  
MS 5505  
Tallahassee, Florida 32399

Attention: Ed Svec

This letter is in response to our phone conversation last week pertaining to our Application For Air Permit Revision that you are currently processing. As I mentioned in our conversation, Ocean Spray Cranberries, Inc. would like to pursue a permit based on total number of boxes processed through the dryer and pellet cooler rather than the number of hours these pieces of equipment run.

Per your request, I took the liberty of developing some numbers for you to review. If you go to page 20 of the application and look in Box #8 you will find the emissions calculation. This calculation uses the current plant throughput rate of 1700 boxes/hour to determine the emission rate (LBS/HR). It is my belief that we can use the same box throughput rate to develop a box throughput amount for the permit. If we multiply the 1700 boxes/hour rate by the newly proposed hour rate of 3737 hours, we obtain a maximum box throughput amount of 6,352,900 boxes that can be processed through the two dryers and the pellet cooler in any twelve-month period.

Since we are moving away from regulating hours of operation on the feed mill dryer and pellet cooler, I also would like to remove the clause that restricts us to use only one of the dryers at a time. The potential for the use of both dryers at the same time would give us some needed flexibility in the feed mill.

Sincerely,

A handwritten signature in black ink that reads "Brian Bogart". The signature is written in a cursive style with a large, sweeping flourish at the end.

Brian Bogart



0610021-009-AC  
0610021-010-AV

**Ocean Spray Cranberries, Inc.**  
925 74th Avenue, S.W., Vero Beach, FL 32968  
(561) 562-0800, FAX (561) 562-1215

November 20, 2001

**RECEIVED**

NOV 26 2001

**BUREAU OF AIR REGULATION**

Florida Department of Environmental Protection  
2600 Blair Stone Road  
Tallahassee, Florida 32399-2400

Attention: Clair H. Fancy, P.E.

Enclosed please find four copies of our application for an increase in the permitted operating hours of our feed mill dryer and pellet cooler to 3,737 hours/year.

If you have any questions about this application, please give me a call at 561-562-0800.

Sincerely yours,

A handwritten signature in cursive script that reads "Brian Bogart".

Brian Bogart  
EHS Manager

**LETTER OF TRANSMITTAL**

To: Brian Bogart Ocean Spray Cranberries, Inc, 925 74th Avenue, S.W. Vero Beach, FL 32968-9702	Date: November 15, 2001  Project No.: 0104
--	--

We are forwarding to you: Permit Applications

Copies	Dated	Description
5	1/29/01	<p>Construction Permit Application <b>Citrus Peel Dryer No. 2 &amp; Pellet Cooler</b></p> <p>This application is for an increase in the permitted operating hours to 3737 hours/year.</p> <p>Please have Mark Smidebush sign and date all 5 copies. Send 4 copies to:</p> <p>Clair H. Fancy, P.E. Chief, Bureau of Air Regulation Division of Air Resources Management FL. Dept. Of Environmental Protection 2600 Blair Stone Road Tallahassee, Florida 32399-2400</p> <p>Keep 1 copy for your records.</p> <p>Bottorf Associates, Inc. appreciates your business and looks forward to working with you in the near future.</p>

These are transmitted: As requested.

Copies To:

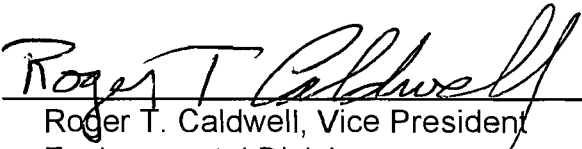
By:   
Roger T. Caldwell, Vice President  
Environmental Division



# Department of Environmental Protection

## Division of Air Resources Management

### APPLICATION FOR AIR PERMIT - TITLE V SOURCE

See Instructions for Form No. 62-210.900(1)

#### I. APPLICATION INFORMATION

**Identification of Facility**

1. Facility Owner/Company Name: <b>OCEAN SPRAY CRANBERRIES, INC.</b>	
2. Site Name: <b>VERO BEACH FACILITY</b>	
3. Facility Identification Number: <b>0610021</b> [ ] Unknown	
4. Facility Location: Street Address or Other Locator: <b>925 74<sup>th</sup> AVENUE, SOUTHWEST</b> City: <b>VERO BEACH</b> County: <b>INDIAN RIVER</b> Zip Code: <b>32968-9702</b>	
5. Relocatable Facility? [ ] Yes [X] No	6. Existing Permitted Facility? [X] Yes [ ] No

**Application Contact**

1. Name and Title of Application Contact: <b>ROGER T. CALDWELL, V.P.</b> <b>ENVIRONMENTAL DIVISION</b>	
2. Application Contact Mailing Address: Organization/Firm: <b>BOTTORF ASSOCIATES, INC.</b> Street Address: <b>6729 EDGEWATER COMMERCE PKWY.</b> City: <b>ORLANDO</b> State: <b>FL.</b> Zip Code: <b>32810-4278:</b>	
3. Application Contact Telephone Numbers: Telephone: <b>(407)298-0846</b> Fax: <b>(407)299-7053</b>	

**Application Processing Information (DEP Use)**

1. Date of Receipt of Application:	<b>12-26-01</b>
2. Permit Number:	<b>0610021-009-AC 0610021-010-AC</b>
3. PSD Number (if applicable):	
4. Siting Number (if applicable):	

**Purpose of Application**

**Air Operation Permit Application**

This Application for Air Permit is submitted to obtain: (Check one)

Initial Title V air operation permit for an existing facility which is classified as a Title V source.

Initial Title V air operation permit for a facility which, upon start up of one or more newly constructed or modified emissions units addressed in this application, would become classified as a Title V source.

Current construction permit number: \_\_\_\_\_

Title V air operation permit revision to address one or more newly constructed or modified emissions units addressed in this application.

Current construction permit number: \_\_\_\_\_

Operation permit number to be revised: \_\_\_\_\_

Title V air operation permit revision or administrative correction to address one or more proposed new or modified emissions units and to be processed concurrently with the air construction permit application. (Also check Air Construction Permit Application below.)

Operation permit number to be revised/corrected: 0610021-007-AV

Title V air operation permit revision for reasons other than construction or modification of an emissions unit. Give reason for the revision; e.g., to comply with a new applicable requirement or to request approval of an "Early Reductions" proposal.

Operation permit number to be revised: \_\_\_\_\_

Reason for revision: \_\_\_\_\_

**Air Construction Permit Application**

This Application for Air Permit is submitted to obtain: (Check one)

Air construction permit to construct or modify one or more emissions units.

Air construction permit to make federally enforceable an assumed restriction on the potential emissions of one or more existing, permitted emissions units.

Air construction permit for one or more existing, but unpermitted, emissions units.

**Owner/Authorized Representative or Responsible Official**

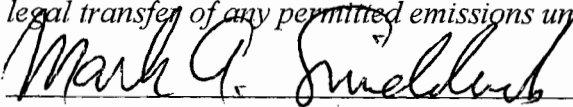
1. Name and Title of Owner/Authorized Representative or Responsible Official: <b>MARK SMIDEBUSH, PLANT MANAGER</b>
2. Owner/Authorized Representative or Responsible Official Mailing Address: Organization/Firm: <b>OCEAN SPRAY CRANBERRIES, INC.</b> Street Address: <b>925 74<sup>th</sup> AVENUE, SOUTHWEST</b> City: <b>VERO BEACH</b> State: <b>FL</b> Zip Code: <b>32968-9702</b>
3. Owner/Authorized Representative or Responsible Official Telephone Numbers: Telephone: <b>(561)562-0800</b> Fax: <b>(561)562-1215</b>
4. Owner/Authorized Representative or Responsible Official Statement: <i>I, the undersigned, am the owner or authorized representative*(check here [ ], if so) or the responsible official (check here [ X ], if so) of the Title V source addressed in this application, whichever is applicable. I hereby certify, based on information and belief formed after reasonable inquiry, that the statements made in this application are true, accurate and complete and that, to the best of my knowledge, any estimates of emissions reported in this application are based upon reasonable techniques for calculating emissions. The air pollutant emissions units and air pollution control equipment described in this application will be operated and maintained so as to comply with all applicable standards for control of air pollutant emissions found in the statutes of the State of Florida and rules of the Department of Environmental Protection and revisions thereof. I understand that a permit, if granted by the Department, cannot be transferred without authorization from the Department, and I will promptly notify the Department upon sale or legal transfer of any permitted emissions unit.</i>  <div style="display: flex; justify-content: space-between;"> <div style="width: 60%;"> Signature</div> <div style="width: 30%; text-align: right;"><u>11/20/01</u> Date</div> </div>

\* Attach letter of authorization if not currently on file.

**Professional Engineer Certification**

1. Professional Engineer Name: <b>LARRY G. STUART, P.E.</b> Registration Number: <b>50660</b>
2. Professional Engineer Mailing Address: Organization/Firm: <b>BOTTORF ASSOCIATES, INC.</b> Street Address: <b>6729 EDGEWATER COMMERCE PKWY.</b> City: <b>ORLANDO</b> State: <b>FL.</b> Zip Code: <b>32810-4278</b>
3. Professional Engineer Telephone Numbers: Telephone: <b>(407)298-0846</b> Fax: <b>(407)299-7053</b>

4. Professional Engineer Statement:

I, the undersigned, hereby certify, except as particularly noted herein\*, that:

(1) To the best of my knowledge, there is reasonable assurance that the air pollutant emissions unit(s) and the air pollution control equipment described in this Application for Air Permit, when properly operated and maintained, will comply with all applicable standards for control of air pollutant emissions found in the Florida Statutes and rules of the Department of Environmental Protection; and

(2) To the best of my knowledge, any emission estimates reported or relied on in this application are true, accurate, and complete and are either based upon reasonable techniques available for calculating emissions or, for emission estimates of hazardous air pollutants not regulated for an emissions unit addressed in this application, based solely upon the materials, information and calculations submitted with this application.

If the purpose of this application is to obtain a Title V source air operation permit (check here [ ], if so), I further certify that each emissions unit described in this Application for Air Permit, when properly operated and maintained, will comply with the applicable requirements identified in this application to which the unit is subject, except those emissions units for which a compliance schedule is submitted with this application.

If the purpose of this application is to obtain an air construction permit for one or more proposed new or modified emissions units (check here [ X ], if so), I further certify that the engineering features of each such emissions unit described in this application have been designed or examined by me or individuals under my direct supervision and found to be in conformity with sound engineering principles applicable to the control of emissions of the air pollutants characterized in this application.

If the purpose of this application is to obtain an initial air operation permit or operation permit revision for one or more newly constructed or modified emissions units (check here [ X ], if so), I further certify that, with the exception of any changes detailed as part of this application, each such emissions unit has been constructed or modified in substantial accordance with the information given in the corresponding application for air construction permit and with all provisions contained in such permit.

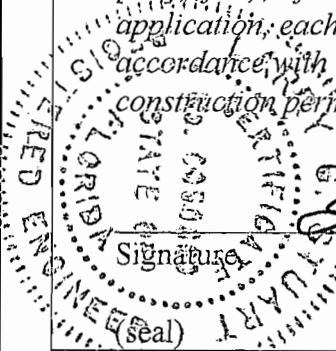

*Gregory S. Stewart*  
Signature

11/16/01  
Date

\* Attach any exception to certification statement.

**Scope of Application**

<b>Emissions Unit ID</b>	<b>Description of Emissions Unit</b>	<b>Permit Type</b>	<b>Processing Fee</b>
006	CITRUS PEEL DRYER NO. 2	AC1D	0
005	PELLET COOLER	AC1D	0

**Application Processing Fee**

Check one: [  ] Attached - Amount: \$ \_\_\_\_\_ [X] Not Applicable



**Construction/Modification Information**

1. Description of Proposed Project or Alterations:

**THIS PROJECT IS FOR A CONSTRUCTION PERMIT TO INCREASE THE PERMITTED HOURS OF OPERATION FOR THE CITRUS PEEL DRYER NO. 2 AND THE PELLET COOLER FROM 3528 HOURS PER YEAR TO 3737 HOURS PER YEAR. THIS INCREASE IN OPERATING HOURS WILL INCREASE THE POTENTIAL VOC EMISSIONS BY 39 TONS PER YEAR. THIS INCREASE IN THE HOURS OF OPERATION WILL NOT TRIGGER A PSD REVIEW.**

2. Projected or Actual Date of Commencement of Construction:

3. Projected Date of Completion of Construction:

**Application Comment**

**THIS APPLICATION IS ALSO FOR AN AMENDMENT TO THE TITLE V PERMIT, TO INCLUDE THESE CHANGES.**



**Facility Regulatory Classifications**

**Check all that apply:**

1. <input type="checkbox"/> Small Business Stationary Source?	<input type="checkbox"/> Unknown
2. <input checked="" type="checkbox"/> Major Source of Pollutants Other than Hazardous Air Pollutants (HAPs)?	
3. <input type="checkbox"/> Synthetic Minor Source of Pollutants Other than HAPs?	
4. <input type="checkbox"/> Major Source of Hazardous Air Pollutants (HAPs)?	
5. <input type="checkbox"/> Synthetic Minor Source of HAPs?	
6. <input type="checkbox"/> One or More Emissions Units Subject to NSPS?	
7. <input type="checkbox"/> One or More Emission Units Subject to NESHAP?	
8. <input checked="" type="checkbox"/> Title V Source by EPA Designation?	
Facility Regulatory Classifications Comment (limit to 200 characters):	

**List of Applicable Regulations**

STATE (TITLE V CORE LIST)	
62-4	
62-204	
62-210	
62-213	
62-256	
62-257	
62-281	
62-296	
62-297	

### B. FACILITY POLLUTANTS

**List of Pollutants Emitted**

1. Pollutant Emitted	2. Pollutant Classif.	3. Requested Emissions Cap		4. Basis for Emissions Cap	5. Pollutant Comment
		lb/hour	tons/year		
VOC	A				
CO	SM				
SO2	SM				
PM	SM				
NOX	SM				

**C. FACILITY SUPPLEMENTAL INFORMATION**

**Supplemental Requirements**

1. Area Map Showing Facility Location: <input checked="" type="checkbox"/> Attached, Document ID: _____ [   ] Not Applicable [   ] Waiver Requested
2. Facility Plot Plan: <input checked="" type="checkbox"/> Attached, Document ID: _____ [   ] Not Applicable [   ] Waiver Requested
3. Process Flow Diagram(s): <input type="checkbox"/> Attached, Document ID: _____ [ <b>X</b> ] Not Applicable [   ] Waiver Requested
4. Precautions to Prevent Emissions of Unconfined Particulate Matter: <input type="checkbox"/> Attached, Document ID: _____ [ <b>X</b> ] Not Applicable [   ] Waiver Requested
5. Fugitive Emissions Identification: <input type="checkbox"/> Attached, Document ID: _____ [ <b>X</b> ] Not Applicable [   ] Waiver Requested
6. Supplemental Information for Construction Permit Application: <input type="checkbox"/> Attached, Document ID: _____ [ <b>X</b> ] Not Applicable
7. Supplemental Requirements Comment:

**Additional Supplemental Requirements for Title V Air Operation Permit Applications**

<p>8. List of Proposed Insignificant Activities:  <input type="checkbox"/> Attached, Document ID: _____ <input checked="" type="checkbox"/> Not Applicable</p>
<p>9. List of Equipment/Activities Regulated under Title VI:  <input type="checkbox"/> Attached, Document ID: _____  <input type="checkbox"/> Equipment/Activities On site but Not Required to be Individually Listed  <input checked="" type="checkbox"/> Not Applicable</p>
<p>10. Alternative Methods of Operation:  <input type="checkbox"/> Attached, Document ID: _____ <input checked="" type="checkbox"/> Not Applicable</p>
<p>11. Alternative Modes of Operation (Emissions Trading):  <input type="checkbox"/> Attached, Document ID: _____ <input checked="" type="checkbox"/> Not Applicable</p>
<p>12. Identification of Additional Applicable Requirements:  <input type="checkbox"/> Attached, Document ID: _____ <input checked="" type="checkbox"/> Not Applicable</p>
<p>13. Risk Management Plan Verification:  <input type="checkbox"/> Plan previously submitted to Chemical Emergency Preparedness and Prevention Office (CEPPO). Verification of submittal attached (Document ID: _____) or previously submitted to DEP (Date and DEP Office: _____)  <input type="checkbox"/> Plan to be submitted to CEPPO (Date required: _____)  <input checked="" type="checkbox"/> Not Applicable</p>
<p>14. Compliance Report and Plan:  <input type="checkbox"/> Attached, Document ID: _____ <input checked="" type="checkbox"/> Not Applicable</p>
<p>15. Compliance Certification (Hard-copy Required):  <input type="checkbox"/> Attached, Document ID: _____ <input checked="" type="checkbox"/> Not Applicable</p>

**III. EMISSIONS UNIT INFORMATION**

A separate Emissions Unit Information Section (including subsections A through J as required) must be completed for each emissions unit addressed in this Application for Air Permit. If submitting the application form in hard copy, indicate, in the space provided at the top of each page, the number of this Emissions Unit Information Section and the total number of Emissions Unit Information Sections submitted as part of this application.

**A. GENERAL EMISSIONS UNIT INFORMATION  
(All Emissions Units)**

**Emissions Unit Description and Status**

<p>1. Type of Emissions Unit Addressed in This Section: (Check one)</p> <p><input checked="" type="checkbox"/> This Emissions Unit Information Section addresses, as a single emissions unit, a single process or production unit, or activity, which produces one or more air pollutants and which has at least one definable emission point (stack or vent).</p> <p><input type="checkbox"/> This Emissions Unit Information Section addresses, as a single emissions unit, a group of process or production units and activities which has at least one definable emission point (stack or vent) but may also produce fugitive emissions.</p> <p><input type="checkbox"/> This Emissions Unit Information Section addresses, as a single emissions unit, one or more process or production units and activities which produce fugitive emissions only.</p>			
<p>2. Regulated or Unregulated Emissions Unit? (Check one)</p> <p><input checked="" type="checkbox"/> The emissions unit addressed in this Emissions Unit Information Section is a regulated emissions unit.</p> <p><input type="checkbox"/> The emissions unit addressed in this Emissions Unit Information Section is an unregulated emissions unit.</p>			
<p>Description of Emissions Unit Addressed in This Section (limit to 60 characters):</p> <p><b>CITRUS PEEL DRYER NO. 2</b></p>			
<p>4. Emissions Unit Identification Number:</p> <p>ID: <b>006</b></p>		<p><input type="checkbox"/> No ID</p> <p><input type="checkbox"/> IDUnknown</p>	
<p>5. Emissions Unit Status Code: <b>A</b></p>	<p>6. Initial Startup Date:</p>	<p>7. Emissions Unit Major Group SIC Code: <b>20</b></p>	<p>8. Acid Rain Unit?</p> <p><input type="checkbox"/></p>
<p>9. Emissions Unit Comment: (Limit to 500 Characters)</p>			

**Emissions Unit Control Equipment**

1. Control Equipment/Method Description (Limit to 200 characters per device or method):  
**WASTE HEAT EVAPORATOR WITH SCRUBBER TYPE WATER SPRAY NOZZLES.**

2. Control Device or Method Code(s): **002**

**Emissions Unit Details**

1. Package Unit:

Manufacturer: **GUMACO**

Model Number: **9040**

2. Generator Nameplate Rating:

**MW**

3. Incinerator Information:

Dwell Temperature:

°F

Dwell Time:

seconds

Incinerator Afterburner Temperature:

°F



**B. EMISSIONS UNIT CAPACITY INFORMATION  
(Regulated Emissions Units Only)**

**Emissions Unit Operating Capacity and Schedule**

1. Maximum Heat Input Rate:	<b>70</b>	mmBtu/hr
2. Maximum Incineration Rate:	lb/hr	tons/day
3. Maximum Process or Throughput Rate: <b>36 TONS/HOUR INPUT</b>		
4. Maximum Production Rate:		
5. Requested Maximum Operating Schedule:		
	<b>24 hours/day</b>	<b>7 days/week</b>
	<b>39 weeks/year</b>	<b>3737 hours/year</b>
6. Operating Capacity/Schedule Comment (limit to 200 characters):		

**C. EMISSIONS UNIT REGULATIONS  
(Regulated Emissions Units Only)**

List of Applicable Regulations

STATE (TITLE V CORE LIST)	
62-4	
62-204	
62-210	
62-213	
62-256	
62-257	
62-281	
62-296	
62-297	

**D. EMISSION POINT (STACK/VENT) INFORMATION  
(Regulated Emissions Units Only)**

**Emission Point Description and Type**

1. Identification of Point on Plot Plan or Flow Diagram? <b>WHE STACK</b>		2. Emission Point Type Code: <b>1</b>	
3. Descriptions of Emission Points Comprising this Emissions Unit for VE Tracking (limit to 100 characters per point):			
4. ID Numbers or Descriptions of Emission Units with this Emission Point in Common: <b>THIS EMISSION UNIT SHARES THE WASTE HEAT EVAPORATOR AND STACK OF THE DRYER NO. 1, HOWEVER THEY CAN NOT OPERATE SIMULTANEOUSLY. THE DRYER NO. 1 IS USED AS A BACK-UP TO THIS DRYER NO. 2.</b>			
5. Discharge Type Code: <b>W</b>	6. Stack Height: <b>60</b> feet	7. Exit Diameter: <b>2.8</b> feet	
8. Exit Temperature: <b>155 °F</b>	9. Actual Volumetric Flow Rate: <b>27,271</b> acfm	10. Water Vapor: <b>30.00 %</b>	
11. Maximum Dry Standard Flow Rate: <b>16,761</b> dscfm		12. Nonstack Emission Point Height: feet	
13. Emission Point UTM Coordinates: Zone: <b>17</b> East (km): <b>550.000</b> North (km): <b>3051.000</b>			
14. Emission Point Comment (limit to 200 characters):			

**E. SEGMENT (PROCESS/FUEL) INFORMATION  
(All Emissions Units)**

**Segment Description and Rate:** Segment 1 of 3

1. Segment Description (Process/Fuel Type) (limit to 500 characters): <b>PRESSED WET CITRUS PEEL INPUT TO THE DRYER</b>		
2. Source Classification Code (SCC): <b>3-02-999-98</b>		3. SCC Units: <b>TONS PROCESSED</b>
4. Maximum Hourly Rate: <b>36.00</b>	5. Maximum Annual Rate: <b>127,008.00</b>	6. Estimated Annual Activity Factor:
7. Maximum % Sulfur:	8. Maximum % Ash:	9. Million Btu per SCC Unit:
10. Segment Comment (limit to 200 characters):		

**Segment Description and Rate:** Segment 2 of 3

1. Segment Description (Process/Fuel Type) (limit to 500 characters): <b>NATURAL GAS - IN PROCESS FUEL</b>		
2. Source Classification Code (SCC): <b>3-02-900-03</b>		3. SCC Units: <b>MILLION CUBIC FEET BURNED</b>
3. Maximum Hourly Rate: <b>0.07</b>	4. Maximum Annual Rate: <b>261.6</b>	6. Estimated Annual Activity Factor:
7. Maximum % Sulfur:	8. Maximum % Ash:	9. Million Btu per SCC Unit: <b>1025</b>
10. Segment Comment (limit to 200 characters):		

Emissions Unit Information Section 1 of 2

**Segment Description and Rate:** Segment 3 of 3

1. Segment Description (Process/Fuel Type ) (limit to 500 characters): <b>NO. 2 DISTILLATE FUEL OIL - IN PROCESS FUEL</b>		
5. Source Classification Code (SCC): <b>3-02-900-01</b>		3. SCC Units: <b>THOUSAND GALLONS BURNED</b>
6. Maximum Hourly Rate: <b>0.50725</b>	7. Maximum Annual Rate: <b>1,265.49</b>	6. Estimated Annual Activity Factor:
7. Maximum % Sulfur: <b>0.50</b>	8. Maximum % Ash:	10. Million Btu per SCC Unit: <b>138</b>
10. Segment Comment (limit to 200 characters):		



Emissions Unit Information Section 1 of 2

Pollutant Detail Information Page 1 of 5

**G. EMISSIONS UNIT POLLUTANT DETAIL INFORMATION  
(Regulated Emissions Units -  
Emissions-Limited and Preconstruction Review Pollutants Only)**

**Potential/Fugitive Emissions**

1. Pollutant Emitted: <b>VOC</b>		2. Total Percent Efficiency of Control:	
3. Potential Emissions: <b>374.63</b> lb/hour <b>700.00</b> tons/year		4. Synthetically Limited? [ Y ]	
5. Range of Estimated Fugitive Emissions: [ ] 1      [ ] 2      [ ] 3                      to                      tons/year			
6. Emission Factor:  Reference: <b>MATERIAL BALANCE</b>		7. Emissions Method Code:  <b>2</b>	
8. Calculation of Emissions (limit to 600 characters): <b>VOC = (1700 BOX'S/HR X 85 LBS/BOX / 2000LBS/TON) X (6.1 LBS OIL/TON FRUIT X 0.85 FACTOR OF TOTAL OIL-15% OIL IN PRODUCT) = 374.63 LBS/HR.</b>  <b>374.63 LBS/HR X 3737 HOURS/YEAR / 2000 LBS/TON = 700.00 TONS/YEAR</b>			
9. Pollutant Potential/Fugitive Emissions Comment (limit to 200 characters):			

**Allowable Emissions** Allowable Emissions 1 of 1

1. Basis for Allowable Emissions Code:		2. Future Effective Date of Allowable Emissions:	
3. Requested Allowable Emissions and Units:		4. Equivalent Allowable Emissions: lb/hour                      tons/year	
5. Method of Compliance (limit to 60 characters):			
6. Allowable Emissions Comment (Desc. of Operating Method) (limit to 200 characters): <b>AT THIS TIME WE DO NOT REQUEST A LIMIT FOR VOC EMISSIONS. THE PHYSICAL LIMIT FROM THE BOTTLENECK AND THE PERMIT LIMIT OF 3737 HOURS PER YEAR WILL LIMIT VOC EMISSIONS TO THE POTENTIAL SHOWN ABOVE.</b>			

Emissions Unit Information Section 1 of 2

Pollutant Detail Information Page 2 of 5

**G. EMISSIONS UNIT POLLUTANT DETAIL INFORMATION**  
**(Regulated Emissions Units - Emissions-Limited and Preconstruction Review Pollutants Only)**

**Potential/Fugitive Emissions**

1. Pollutant Emitted: <b>CO</b>		2. Total Percent Efficiency of Control:	
3. Potential Emissions: <b>48.08 lb/hour</b> <b>89.85 tons/year</b>		4. Synthetically Limited? [ <b>Y</b> ]	
5. Range of Estimated Fugitive Emissions: [ ] 1      [ ] 2      [ ] 3                      to                      tons/year			
6. Emission Factor: <b>1.33567 LBS/TON OF PRESSED WET PEEL</b> Reference: <b>1/31/97 STACK TEST</b>		7. Emissions Method Code: <b>1</b>	
8. Calculation of Emissions (limit to 600 characters): <b>CO = 1.33567 LBS/TON WET PEEL X 36 TONS/HR = 48.08 LBS/HOUR</b> <b>48.08 LBS/HR X 3737 HRS/YR X 1/2000 = 89.85 TONS/YR</b>			
9. Pollutant Potential/Fugitive Emissions Comment (limit to 200 characters):			

**Allowable Emissions** Allowable Emissions \_\_\_\_\_ of \_\_\_\_\_

1. Basis for Allowable Emissions Code:		2. Future Effective Date of Allowable Emissions:	
3. Requested Allowable Emissions and Units:		4. Equivalent Allowable Emissions: lb/hour      tons/year	
5. Method of Compliance (limit to 60 characters):			
6. Allowable Emissions Comment (Desc. of Operating Method) (limit to 200 characters): <b>NO LIMIT REQUESTED</b>			



Emissions Unit Information Section 1 of 2

Pollutant Detail Information Page 3 of 5

**G. EMISSIONS UNIT POLLUTANT DETAIL INFORMATION  
(Regulated Emissions Units -  
Emissions-Limited and Preconstruction Review Pollutants Only)**

**Potential/Fugitive Emissions**

1. Pollutant Emitted: <b>PM</b>		2. Total Percent Efficiency of Control: <b>90.00</b>	
3. Potential Emissions: <b>17.3</b> lb/hour <b>32.32</b> tons/year		4. Synthetically Limited? [ <b>Y</b> ]	
5. Range of Estimated Fugitive Emissions: [ ] 1            [ ] 2            [ ] 3            _____ to _____ tons/year			
6. Emission Factor:  Reference:		7. Emissions Method Code:  <b>0</b>	
8. Calculation of Emissions (limit to 600 characters): <b>PM = ALLOWABLE LIMIT IN CURRENT PERMIT = 17.30 LBS/HR</b> <b>17.30 LBS/HR X 3737 HRS/YR X 1/2000 = 32.32 TONS/YR</b>			
9. Pollutant Potential/Fugitive Emissions Comment (limit to 200 characters):			

**Allowable Emissions** Allowable Emissions 1 of 2

1. Basis for Allowable Emissions Code: <b>OTHER</b>		2. Future Effective Date of Allowable Emissions:	
3. Requested Allowable Emissions and Units: <b>17.30 LBS/HOUR</b>		4. Equivalent Allowable Emissions: <b>17.30</b> lb/hour <b>32.32</b> tons/year	
5. Method of Compliance (limit to 60 characters): <b>EPA METHOD 5 TEST</b>			
6. Allowable Emissions Comment (Desc. of Operating Method) (limit to 200 characters): <b>REQUESTED BY THE APPLICANT TO REDUCE THE ANNUAL TITLE V LICENSE FEES.</b>			

Emissions Unit Information Section 1 of 2

Pollutant Detail Information Page 4 of 5

**G. EMISSIONS UNIT POLLUTANT DETAIL INFORMATION  
(Regulated Emissions Units -  
Emissions-Limited and Preconstruction Review Pollutants Only)**

**Potential/Fugitive Emissions**

1. Pollutant Emitted: <b>SO2</b>	2. Total Percent Efficiency of Control:
3. Potential Emissions: <b>36.01 lb/hour                      44.93 tons/year</b>	4. Synthetically Limited? [ <b>Y</b> ]
5. Range of Estimated Fugitive Emissions: [ ] 1      [ ] 2      [ ] 3      _____ to _____ tons/year	
6. Emission Factor: <b>71 LBS/1000 GALLONS</b> Reference: <b>AP42</b>	7. Emissions Method Code: <b>4</b>
8. Calculation of Emissions (limit to 600 characters): <b>SO2 = 0.50725 KGAL/HR X 71 LBS/KGAL = 36.01 LBS/HR</b> <b>SO2 = 1265.494 KGAL/YR X 71 LBS/KGAL X 1/2000 = 44.93 TONS/YR</b>	
9. Pollutant Potential/Fugitive Emissions Comment (limit to 200 characters):	

**Allowable Emissions** Allowable Emissions 2 of 2

1. Basis for Allowable Emissions Code: <b>OTHER</b>	2. Future Effective Date of Allowable Emissions:
4. Requested Allowable Emissions and Units: <b>0.5 % SULFUR IN OIL</b>	4. Equivalent Allowable Emissions: <b>36.01 lb/hour    44.92 tons/year</b>
5. Method of Compliance (limit to 60 characters): <b>FUEL OIL ANALYSIS PROVIDED BY THE SUPPLIER</b>	
6. Allowable Emissions Comment (Desc. of Operating Method) (limit to 200 characters): <b>REQUESTED BY THE APPLICANT TO REDUCE THE ANNUAL TITLE V LICENSE FEES.</b>	

Emissions Unit Information Section 1 of 2

Pollutant Detail Information Page 5 of 5

**G. EMISSIONS UNIT POLLUTANT DETAIL INFORMATION**  
**(Regulated Emissions Units -**  
**Emissions-Limited and Preconstruction Review Pollutants Only)**

**Potential/Fugitive Emissions**

1. Pollutant Emitted: <b>NOX</b>		2. Total Percent Efficiency of Control:	
3. Potential Emissions: <b>10.15</b> lb/hour <b>12.66</b> tons/year		4. Synthetically Limited? [ <b>Y</b> ]	
5. Range of Estimated Fugitive Emissions: [ ] 1            [ ] 2            [ ] 3            _____ to _____ tons/year			
6. Emission Factor: <b>20</b> Reference: <b>AP42</b>		7. Emissions Method Code: <b>4</b>	
8. Calculation of Emissions (limit to 600 characters): <b>NOX = 0.50725 KGAL/HR X 20 LBS/KGAL = 10.15 LBS/HR</b> <b>NOX = 1265.494 KGAL/YR X 20 LBS/KGAL X 1/2000 = 12.66 TONS/YR</b>			
9. Pollutant Potential/Fugitive Emissions Comment (limit to 200 characters):			

**Allowable Emissions** Allowable Emissions \_\_\_\_\_ of \_\_\_\_\_

1. Basis for Allowable Emissions Code:		2. Future Effective Date of Allowable Emissions:	
3. Requested Allowable Emissions and Units:		4. Equivalent Allowable Emissions: lb/hour      tons/year	
5. Method of Compliance (limit to 60 characters):			
6. Allowable Emissions Comment (Desc. of Operating Method) (limit to 200 characters): <b>NO LIMIT REQUESTED</b>			



**J. EMISSIONS UNIT SUPPLEMENTAL INFORMATION  
(Regulated Emissions Units Only)**

**Supplemental Requirements**

1. Process Flow Diagram <input type="checkbox"/> Attached, Document ID: _____ <input type="checkbox"/> Not Applicable <input checked="" type="checkbox"/> Waiver Requested
2. Fuel Analysis or Specification <input type="checkbox"/> Attached, Document ID: _____ <input type="checkbox"/> Not Applicable <input checked="" type="checkbox"/> Waiver Requested
3. Detailed Description of Control Equipment <input type="checkbox"/> Attached, Document ID: _____ <input type="checkbox"/> Not Applicable <input checked="" type="checkbox"/> Waiver Requested
4. Description of Stack Sampling Facilities <input type="checkbox"/> Attached, Document ID: _____ <input type="checkbox"/> Not Applicable <input checked="" type="checkbox"/> Waiver Requested
5. Compliance Test Report <input type="checkbox"/> Attached, Document ID: _____ <input type="checkbox"/> Previously submitted, Date: _____ <input checked="" type="checkbox"/> Not Applicable
6. Procedures for Startup and Shutdown <input type="checkbox"/> Attached, Document ID: _____ <input checked="" type="checkbox"/> Not Applicable <input type="checkbox"/> Waiver Requested
7. Operation and Maintenance Plan <input type="checkbox"/> Attached, Document ID: _____ <input checked="" type="checkbox"/> Not Applicable <input type="checkbox"/> Waiver Requested
8. Supplemental Information for Construction Permit Application <input type="checkbox"/> Attached, Document ID: _____ <input checked="" type="checkbox"/> Not Applicable
9. Other Information Required by Rule or Statute <input type="checkbox"/> Attached, Document ID: _____ <input checked="" type="checkbox"/> Not Applicable
10. Supplemental Requirements Comment:          

**Additional Supplemental Requirements for Title V Air Operation Permit Applications**

<p>11. Alternative Methods of Operation  <input type="checkbox"/> Attached, Document ID: _____ <input checked="" type="checkbox"/> Not Applicable</p>
<p>12. Alternative Modes of Operation (Emissions Trading)  <input type="checkbox"/> Attached, Document ID: _____ <input checked="" type="checkbox"/> Not Applicable</p>
<p>13. Identification of Additional Applicable Requirements  <input type="checkbox"/> Attached, Document ID: _____ <input checked="" type="checkbox"/> Not Applicable</p>
<p>14. Compliance Assurance Monitoring Plan  <input type="checkbox"/> Attached, Document ID: _____ <input checked="" type="checkbox"/> Not Applicable</p>
<p>15. Acid Rain Part Application (Hard-copy Required)</p> <p><input type="checkbox"/> Acid Rain Part - Phase II (Form No. 62-210.900(1)(a))  Attached, Document ID: _____</p> <p><input type="checkbox"/> Repowering Extension Plan (Form No. 62-210.900(1)(a)1.)  Attached, Document ID: _____</p> <p><input type="checkbox"/> New Unit Exemption (Form No. 62-210.900(1)(a)2.)  Attached, Document ID: _____</p> <p><input type="checkbox"/> Retired Unit Exemption (Form No. 62-210.900(1)(a)3.)  Attached, Document ID: _____</p> <p><input type="checkbox"/> Phase II NOx Compliance Plan (Form No. 62-210.900(1)(a)4.)  Attached, Document ID: _____</p> <p><input type="checkbox"/> Phase NOx Averaging Plan (Form No. 62-210.900(1)(a)5.)  Attached, Document ID: _____</p> <p><input checked="" type="checkbox"/> Not Applicable</p>

**III. EMISSIONS UNIT INFORMATION**

A separate Emissions Unit Information Section (including subsections A through J as required) must be completed for each emissions unit addressed in this Application for Air Permit. If submitting the application form in hard copy, indicate, in the space provided at the top of each page, the number of this Emissions Unit Information Section and the total number of Emissions Unit Information Sections submitted as part of this application.

**A. GENERAL EMISSIONS UNIT INFORMATION  
(All Emissions Units)**

**Emissions Unit Description and Status**

<p>1. Type of Emissions Unit Addressed in This Section: (Check one)</p> <p><input checked="" type="checkbox"/> This Emissions Unit Information Section addresses, as a single emissions unit, a single process or production unit, or activity, which produces one or more air pollutants and which has at least one definable emission point (stack or vent).</p> <p><input type="checkbox"/> This Emissions Unit Information Section addresses, as a single emissions unit, a group of process or production units and activities which has at least one definable emission point (stack or vent) but may also produce fugitive emissions.</p> <p><input type="checkbox"/> This Emissions Unit Information Section addresses, as a single emissions unit, one or more process or production units and activities which produce fugitive emissions only.</p>			
<p>2. Regulated or Unregulated Emissions Unit? (Check one)</p> <p><input checked="" type="checkbox"/> The emissions unit addressed in this Emissions Unit Information Section is a regulated emissions unit.</p> <p><input type="checkbox"/> The emissions unit addressed in this Emissions Unit Information Section is an unregulated emissions unit.</p>			
<p>Description of Emissions Unit Addressed in This Section (limit to 60 characters):</p> <p><b>PELLET COOLER</b></p>			
<p>4. Emissions Unit Identification Number:</p> <p>ID: <b>005</b></p>		<p><input type="checkbox"/> No ID</p> <p><input type="checkbox"/> IDUnknown</p>	
<p>5. Emissions Unit Status Code: <b>A</b></p>	<p>6. Initial Startup Date:</p>	<p>7. Emissions Unit Major Group SIC Code: <b>20</b></p>	<p>8. Acid Rain Unit?</p> <p><input type="checkbox"/></p>
<p>9. Emissions Unit Comment: (Limit to 500 Characters)</p>			

**B. EMISSIONS UNIT CAPACITY INFORMATION**  
**(Regulated Emissions Units Only)**

**Emissions Unit Operating Capacity and Schedule**

1. Maximum Heat Input Rate:		mmBtu/hr
2. Maximum Incineration Rate:	lb/hr	tons/day
3. Maximum Process or Throughput Rate:	<b>13.8 TONS/HOUR</b>	
4. Maximum Production Rate:	<b>13.8 TONS/HOUR</b>	
5. Requested Maximum Operating Schedule:		
	<b>24 hours/day</b>	<b>7 days/week</b>
	<b>39 weeks/year</b>	<b>3737 hours/year</b>
6. Operating Capacity/Schedule Comment (limit to 200 characters):		



**C. EMISSIONS UNIT REGULATIONS  
(Regulated Emissions Units Only)**

**List of Applicable Regulations**

STATE (TITLE V CORE LIST)	
62-4	
62-204	
62-210	
62-213	
62-256	
62-257	
62-281	
62-296	
62-297	

**D. EMISSION POINT (STACK/VENT) INFORMATION  
(Regulated Emissions Units Only)**

**Emission Point Description and Type**

1. Identification of Point on Plot Plan or Flow Diagram? <b>CYCLONE</b>		2. Emission Point Type Code: <b>1</b>	
3. Descriptions of Emission Points Comprising this Emissions Unit for VE Tracking (limit to 100 characters per point):			
4. ID Numbers or Descriptions of Emission Units with this Emission Point in Common:			
5. Discharge Type Code: <b>W</b>	6. Stack Height: <b>36</b> feet	7. Exit Diameter: <b>3.2</b> feet	
8. Exit Temperature: <b>132</b> °F	9. Actual Volumetric Flow Rate: <b>11500</b> acfm	10. Water Vapor: <b>2.84</b> %	
11. Maximum Dry Standard Flow Rate: <b>10350</b> dscfm		12. Nonstack Emission Point Height: feet	
13. Emission Point UTM Coordinates: Zone: <b>17</b> East (km): <b>550.00</b> North (km): <b>3051.00</b>			
14. Emission Point Comment (limit to 200 characters):			

**E. SEGMENT (PROCESS/FUEL) INFORMATION  
(All Emissions Units)**

**Segment Description and Rate:** Segment 1 of 1

1. Segment Description (Process/Fuel Type) (limit to 500 characters): <b>PELLETS COOLED</b>		
5. Source Classification Code (SCC): <b>3-02-008-06</b>		3. SCC Units: <b>TON PROCESSED</b>
4. Maximum Hourly Rate: <b>13.8</b>	5. Maximum Annual Rate: <b>48,686</b>	6. Estimated Annual Activity Factor:
7. Maximum % Sulfur:	8. Maximum % Ash:	9. Million Btu per SCC Unit:
10. Segment Comment (limit to 200 characters):		

**Segment Description and Rate:** Segment \_\_\_\_\_ of \_\_\_\_\_

1. Segment Description (Process/Fuel Type) (limit to 500 characters):		
2. Source Classification Code (SCC):		3. SCC Units:
4. Maximum Hourly Rate:	5. Maximum Annual Rate:	6. Estimated Annual Activity Factor:
7. Maximum % Sulfur:	8. Maximum % Ash:	9. Million Btu per SCC Unit:
10. Segment Comment (limit to 200 characters):		



Emissions Unit Information Section 2 of 2

Pollutant Detail Information Page 1 of 2

**G. EMISSIONS UNIT POLLUTANT DETAIL INFORMATION  
(Regulated Emissions Units -  
Emissions-Limited and Preconstruction Review Pollutants Only)**

**Potential/Fugitive Emissions**

1. Pollutant Emitted: <b>PM</b>	2. Total Percent Efficiency of Control: <b>80</b>
3. Potential Emissions: <b>15.00</b> lb/hour <b>28.03</b> tons/year	4. Synthetically Limited? [ <b>Y</b> ]
5. Range of Estimated Fugitive Emissions: [ ] 1      [ ] 2      [ ] 3      _____ to _____ tons/year	
6. Emission Factor:  Reference: <b>SET TO ALLOWABLE</b>	7. Emissions Method Code: <b>0</b>
8. Calculation of Emissions (limit to 600 characters): <b>PM = ALLOWABLE LIMIT IN CURRENT PERMIT = 15.00 LBS/HR</b> <b>15.00 LBS/HR X 3737 HRS/YR X 1/2000 = 28.03 TONS/YR</b>	
9. Pollutant Potential/Fugitive Emissions Comment (limit to 200 characters):	

**Allowable Emissions** Allowable Emissions 1 of 1

1. Basis for Allowable Emissions Code: <b>OTHER</b>	2. Future Effective Date of Allowable Emissions:
3. Requested Allowable Emissions and Units: <b>15.00 LBS/HR</b>	4. Equivalent Allowable Emissions: <b>15.00</b> lb/hour <b>28.03</b> tons/year
5. Method of Compliance (limit to 60 characters): <b>EPA METHOD 5</b>	
6. Allowable Emissions Comment (Desc. of Operating Method) (limit to 200 characters): <b>REQUESTED BY APPLICANT TO REDUCE TITLE V ANNUAL LICENSE FEES.</b>	

Emissions Unit Information Section 2 of 2

Pollutant Detail Information Page 2 of 2

**G. EMISSIONS UNIT POLLUTANT DETAIL INFORMATION**  
**(Regulated Emissions Units - Emissions-Limited and Preconstruction Review Pollutants Only)**

**Potential/Fugitive Emissions**

1. Pollutant Emitted: <b>VOC</b>	2. Total Percent Efficiency of Control:
3. Potential Emissions: <b>21.75 lb/hour                      40.64 tons/year</b>	4. Synthetically Limited? [ <b>Y</b> ]
5. Range of Estimated Fugitive Emissions: [ ] 1      [ ] 2      [ ] 3      _____ to _____ tons/year	
6. Emission Factor: <b>1.5759 LBS/TON</b> Reference: <b>4/21/99 STACK TEST</b>	7. Emissions Method Code: <b>1</b>
8. Calculation of Emissions (limit to 600 characters): <b>VOC = 13.8 TONS/HR X 1.5759 LBS/TON = 21.75 LBS/HR</b> <b>21.75 LBS/HR X 3737 HRS/YR X 1/2000 = 40.64 TONS/YR</b>	
9. Pollutant Potential/Fugitive Emissions Comment (limit to 200 characters): <b>THE 700 TON/YEAR POTENTIAL VOC EMISSION CALCULATION FOR CITRUS PEEL DRYER NO. 2 INCLUDES THIS 40.64 TONS. THE 700 TONS/YEAR POTENTIAL VOC EMISSION INCLUDES ALL VOC EMISSIONS FROM THE PROCESSING OF ALL THE GRAPEFRUIT AT THIS FACILITY.</b>	

**Allowable Emissions** Allowable Emissions \_\_\_\_\_ of \_\_\_\_\_

1. Basis for Allowable Emissions Code:	2. Future Effective Date of Allowable Emissions:
3. Requested Allowable Emissions and Units:	4. Equivalent Allowable Emissions: lb/hour      tons/year
5. Method of Compliance (limit to 60 characters):	
6. Allowable Emissions Comment (Desc. of Operating Method) (limit to 200 characters): <b>NO LIMIT REQUESTED</b>	

## H. VISIBLE EMISSIONS INFORMATION (Only Regulated Emissions Units Subject to a VE Limitation)

**Visible Emissions Limitation:** Visible Emissions Limitation   1   of   1  

1. Visible Emissions Subtype: <b>VE20</b>	2. Basis for Allowable Opacity: [ <input checked="" type="checkbox"/> ] Rule [ <input type="checkbox"/> ] Other
3. Requested Allowable Opacity: Normal Conditions: <b>20 %</b> Exceptional Conditions:    % Maximum Period of Excess Opacity Allowed:    min/hour	
4. Method of Compliance: <b>EPA METHOD 9 TEST</b>	
5. Visible Emissions Comment (limit to 200 characters):	

## I. CONTINUOUS MONITOR INFORMATION (Only Regulated Emissions Units Subject to Continuous Monitoring)

**Continuous Monitoring System:** Continuous Monitor \_\_\_\_\_ of \_\_\_\_\_

1. Parameter Code:	2. Pollutant(s):
3. CMS Requirement:	[ <input type="checkbox"/> ] Rule [ <input type="checkbox"/> ] Other
4. Monitor Information: Manufacturer: _____ Model Number: _____ Serial Number: _____	
5. Installation Date:	6. Performance Specification Test Date:
7. Continuous Monitor Comment (limit to 200 characters):	

**J. EMISSIONS UNIT SUPPLEMENTAL INFORMATION  
(Regulated Emissions Units Only)**

**Supplemental Requirements**

1. Process Flow Diagram <input type="checkbox"/> Attached, Document ID: _____ <input type="checkbox"/> Not Applicable <input checked="" type="checkbox"/> Waiver Requested
2. Fuel Analysis or Specification <input type="checkbox"/> Attached, Document ID: _____ <input checked="" type="checkbox"/> Not Applicable <input type="checkbox"/> Waiver Requested
3. Detailed Description of Control Equipment <input type="checkbox"/> Attached, Document ID: _____ <input type="checkbox"/> Not Applicable <input checked="" type="checkbox"/> Waiver Requested
4. Description of Stack Sampling Facilities <input type="checkbox"/> Attached, Document ID: _____ <input type="checkbox"/> Not Applicable <input checked="" type="checkbox"/> Waiver Requested
5. Compliance Test Report <input type="checkbox"/> Attached, Document ID: _____ <input type="checkbox"/> Previously submitted, Date: _____ <input checked="" type="checkbox"/> Not Applicable
6. Procedures for Startup and Shutdown <input type="checkbox"/> Attached, Document ID: _____ <input checked="" type="checkbox"/> Not Applicable <input type="checkbox"/> Waiver Requested
7. Operation and Maintenance Plan <input type="checkbox"/> Attached, Document ID: _____ <input checked="" type="checkbox"/> Not Applicable <input type="checkbox"/> Waiver Requested
8. Supplemental Information for Construction Permit Application <input type="checkbox"/> Attached, Document ID: _____ <input checked="" type="checkbox"/> Not Applicable
9. Other Information Required by Rule or Statute <input type="checkbox"/> Attached, Document ID: _____ <input checked="" type="checkbox"/> Not Applicable
10. Supplemental Requirements Comment:          



**Additional Supplemental Requirements for Title V Air Operation Permit Applications**

<p>11. Alternative Methods of Operation  <input type="checkbox"/> Attached, Document ID: _____ <input checked="" type="checkbox"/> Not Applicable</p>
<p>12. Alternative Modes of Operation (Emissions Trading)  <input type="checkbox"/> Attached, Document ID: _____ <input checked="" type="checkbox"/> Not Applicable</p>
<p>13. Identification of Additional Applicable Requirements  <input type="checkbox"/> Attached, Document ID: _____ <input checked="" type="checkbox"/> Not Applicable</p>
<p>14. Compliance Assurance Monitoring Plan  <input type="checkbox"/> Attached, Document ID: _____ <input checked="" type="checkbox"/> Not Applicable</p>
<p>15. Acid Rain Part Application (Hard-copy Required)</p> <p><input type="checkbox"/> Acid Rain Part - Phase II (Form No. 62-210.900(1)(a))  Attached, Document ID: _____</p> <p><input type="checkbox"/> Repowering Extension Plan (Form No. 62-210.900(1)(a)1.)  Attached, Document ID: _____</p> <p><input type="checkbox"/> New Unit Exemption (Form No. 62-210.900(1)(a)2.)  Attached, Document ID: _____</p> <p><input type="checkbox"/> Retired Unit Exemption (Form No. 62-210.900(1)(a)3.)  Attached, Document ID: _____</p> <p><input type="checkbox"/> Phase II NOx Compliance Plan (Form No. 62-210.900(1)(a)4.)  Attached, Document ID: _____</p> <p><input type="checkbox"/> Phase NOx Averaging Plan (Form No. 62-210.900(1)(a)5.)  Attached, Document ID: _____</p> <p><input checked="" type="checkbox"/> Not Applicable</p>

**OCEAN SPRAY CRANBERRIES, INC.**

**CITRUS PEEL DRYER NO. 2**

**POTENTIAL EMISSIONS ON NO. 2 DISTILLATE FUEL OIL**

BASED ON AP-42 5TH EDITION EMISSION FACTORS FOR DISTILLATE FUEL OIL COMBUSTION, EXCEPT PM, CO, AND VOC

FUEL TYPE	NEW NO. 2 FUEL OIL
MAXIMUM INPUT PROCESS RATE TO THE DRYER OF PRESSED WET PEEL (TONS/HR) (BASED ON THE MANUFACTURER, NOT OTHER FACILITY BOTTLENECKS)	36
MAXIMUM OPERATING TIME (HRS/YR)	3737
MAXIMUM FUEL SULFUR CONTENT (%)	0.5
MAXIMUM HEAT INPUT (MMBTU/HR)	70
MAXIMUM NO. 2 FUEL OIL RATE (GAL/HR)	507.25
MAXIMUM NO. 2 FUEL OIL USAGE (GAL/YEAR)	1265494

POLLUTANT	EMISSION FACTOR	SOURCE OF EMISSION FACTOR	EMISSION FACTOR UNITS	EMISSION RATE (LBS/HR)	EMISSION RATE (TONS/YEAR)
ALLOWABLE PARTICULATE (PM)	N/A	N/A	N/A	17.30	32.325
SULFUR DIOXIDE (SO <sub>2</sub> )	71	AP42 TABLE 1.3-2	LBS/1000 GAL	36.014	44.925
NITROGEN OXIDES (NOX)	20	AP42 TABLE 1.3-2	LBS/1000 GAL	10.145	12.655
CARBON MONOXIDE (CO)	1.33567	STACK TEST ON THIS UNIT ON 1-31-97	LBS/WET TON INPUT	48.084	89.845
VOC (As calculated per Clair Fancy 10/15/99 memo) (1700 Box's/hr.max X 3737 hours/yr. X (85 lbs/box/2000) X (0.00305 tons oil/ton fruit X 0.85) (Note: 0.85 is for the 15% of the oil left in the pellets)	N/A	N/A	N/A	374.630	700.000
VOC (NONMETHANE) (AS PROPANE)	3.2181	STACK TEST ON THIS UNIT ON 1-31-97	LBS/WET TON INPUT	115.852	216.469
PARTICULATE <10 UM (PM10)	1.08	AP42 TABLE 1.3-8	LBS/1000 GAL	0.548	1.024

The 700 ton/year potential VOC emission does not account for any oil recovery.

This facilities bottleneck is the evaporation capacity. This bottleneck limits production to 1700 Box's per hour.

This facilities processes only grapefruit. Grapefruit has 0.00305 tons oil per ton fruit. Grapefruit weighs 85 lbs/box.

Potential VOC emissions prior to this increase in operating hours are 661 tons/year. This is a 39 ton/yr. Increase.

# TABLE I

## VOC PTE TABLE

OSC & Hercules  
Historical Analysis

FISCAL YEAR	Note	BOXES PROCESSED	Capacity (Boxes/Hour)	Bottleneck	Total Oil Recovered (tons/yr) (Note 6)	Calc PTE based on 3528 hours per year (Note 5)	Calc Actual Emissions based on recovered oil. (tons/yr) (Note #7)	PTE Emission Increase (TONS/yr)	PTE Minus Actual Average for Last 2 years (TONS/yr)
						(TONS/yr.)			
80	1	2,724,536	1,160	Evaporation	68.58	451	242		
81		2,218,241	1,160	Evaporation	55.84	451	197	-	
82		2,458,891	1,160	Evaporation	59.11	451	221	-	
83		2,008,907	1,160	Evaporation	52.63	451	177	-	
84		2,540,348	1,160	Evaporation	86.38	451	206	-	
85		2,630,082	1,160	Evaporation	98.32	451	206	-	
86	2	3,342,173	1,460	Evaporation	98.33	568	285	117	361
87	3	3,682,918	1,576	Evaporation	162.56	613	268	45	367
88		2,681,300	1,576	Evaporation	146.22	613	171	-	
89		3,133,736	1,275	Evaporation	197.88	496	177	(117)	
90		2,713,049	1,275	Evaporation	159.59	496	163	-	
91		2,660,993	1,275	Evaporation	125.99	496	186	-	
92		2,538,621	1,275	Evaporation	115.55	496	181	-	
93	4	4,023,450	1,275	Evaporation	187.91	496	284	-	
94		3,821,879	1,700	Evaporation	170.17	661	276	165	428
95		4,399,223	1,700	Evaporation	209.08	661	307	-	
96		4,305,171	1,700	Evaporation	217.24	661	290	-	
97		4,461,990	1,700	Evaporation	207.61	661	315	-	
98		4,388,224	1,700	Evaporation	130.04	661	373	-	
99		4,472,333	1,700	Evaporation	260.07	661	272	-	
TOTALS		65,206,065							

**Note**      *Comment*

- 1      *This plant's capacity has always been defined by its evaporation capacity, and from 1980 - 1985, total evaporation consisted of a 15,000 lb/hr and 30,000 lb/hr TASTE evaporator.*
- 2      *From 1986 - 1988, a Grenco freeze evaporator was also run at this facility in addition to the two TASTE evaporators. This unit ran sporadically, but had a capacity of 300 boxes per hour. This unit was removed following the 1988 season.*
- 3      *In 1987, modifications were made to the two TASTE evaporators to add approximately 10% additional evaporation capacity.*
- 4      *After fiscal year 1993, the Hercules TASTE evaporator that had been used in their operation to concentrate sugar water that had been removed from the peel, was converted to an Ocean Spray - operated 15,000 lb/hr juice evaporator. This effectively increased Ocean Spray's production capacity by a third to 1700 boxes/hr.*
- 5      *Per Clair Fancy, Chief, Bureau of Air Regulation DEP (10/15/99 memo), OSC has not taken credit for peel oil and d'limonene product streams in the PTE calculations despite the fact that their collection is an integral part of OSC's grapefruit processing operation. If credit were taken, it would substantially reduce the tons VOC in the PTE calculation as per Clair Fancy's 10/15/99 memo.*
- 6      *Total oil recovered is the sum of the peel oil, d-limonene, and essence oil data summarized on Table II.*
- 7      *Actual Emissions = Total Available Oil less total oil recovered, allowing for 15% oil remaining in pellets.*

# Ocean Spray Cranberries

## Major Modifications that Resulted in Significant Net Emissions Increases

1. In 1985, a Gresco Freeze Concentrator was installed at this facility. This concentrator had the capacity to run approximately 300 boxes per hour through it. This concentrator was run sporadically for the 1986 – 1988 processing seasons. During this time, the net hourly box per hour capacity of the entire facility was increased by these 300 boxes.
2. In 1987, the two existing TASTE juice evaporators at this facility were pressurized and upgraded. It is believed that these modifications may have increased the evaporation capacity of this facility by approximately 10%, or 116 boxes per hour.
3. In 1993, a third TASTE evaporator, owned by Hercules, was converted by Ocean Spray to a juice evaporator. Hercules had previously used this evaporator in their pectin operation to evaporate sugar water. This modification increased the juice evaporation capacity of the Ocean Spray facility by about one third, or 425 boxes per hour to the 1700 box per hour capacity that exists today.

Ocean Spray believes that the modifications listed above are the only major modifications that increased the capacity of this facility and thus resulted in increases in the potential to emit VOCs. The numerical data that supports this is presented in the **VOC PTE Table**.

It is important to note that the bottleneck for this facility is and always has been juice evaporation capacity. The facility is designed so that all equipment upstream of the evaporators, such as fruit receiving, extraction, etc. has sufficient capacity to fully supply the evaporators. In addition, all downstream equipment is designed to handle greater capacities than that of the evaporators.

**Note:** The information supplied above was derived from interviews with long time employees of Ocean Spray and Hercules. A search of available records was undertaken and an equipment supplier was solicited for historical records. Some of the dates listed are approximated and the actual dates may differ slightly. Complete records were not available dating back to 1980. In addition, plant capacities are also estimated. Capacity is defined by hourly units (boxes/hour) in order to eliminate the effects of clean-up and maintenance downtime.

# Ocean Spray Cranberries

## Other Major Modifications with no Effect on VOC Potential to Emit

1. In 1985, a second extraction line was installed to support the Gresco Freeze Concentrator that was installed at this time. The additional extractors were added to ensure sufficient fruit flow to the new concentrator. Evaporation continued to define the plant throughput capacity. The total number of extractors went from 15 in the 84/85 processing season to 24 for the 85/86 season. It was then determined that this was more extraction capacity than necessary to support Gresco, and the total number of extractors was decreased to 21 for the 86/87 season, then to 19 for the 87/88 season, and finally down to 14 for 88/89 when Gresco was finally removed. The total number of extractors at Ocean Spray has remained at 14 ever since then.
2. In 1993, the pellet cooler in the feedmill was replaced. This did not affect the VOC potential to emit.
3. In 1995, the waste heat evaporator was upgraded. This did not affect the VOC potential to emit.
4. In 1996, the three boilers and one citrus peel dryer were converted from using No. 6 fuel (1% sulfur max) to natural gas as the main fuel and No. 2 fuel (0.5% sulfur max) as the back-up. Potential VOC emissions from these units remained unchanged.
5. In 1996, a 40,000 pound/hour citrus peel dryer was installed. The 40K dryer was a replacement to the 30K dryer that remained on site as a back-up to the new dryer. This did not affect the VOC potential to emit because the 30 K dryer was not a bottleneck. The box throughput capacity of the plant, as determined by evaporator capacity, was less than the design capacity and permitted capacity of the 30K dryer.

There have literally been hundreds of projects and modifications that have taken place at the Ocean Spray and Hercules facilities over the last 20 years. It is unrealistic and impractical to list them all here. I have listed a couple of the larger ones that are more closely related to emissions or facility capacity. For PSD applicability purposes, we only considered those modifications that increased plant capacity, and thus potential to emit. This plant has been a grapefruit processing facility for this entire time; therefore the total available oil factor has not changed due to fruit variety.

**Note:** The information supplied above was derived from interviews with long time employees of Ocean Spray and Hercules. A search of available records was undertaken and an equipment supplier was solicited for historical records. Some of the dates listed are approximated and the actual dates may differ slightly. Complete records were not available dating back to 1980. In addition, plant capacities are also estimated. Capacity is defined by hourly units (boxes/hour) in order to eliminate the effects of clean-up and maintenance downtime.

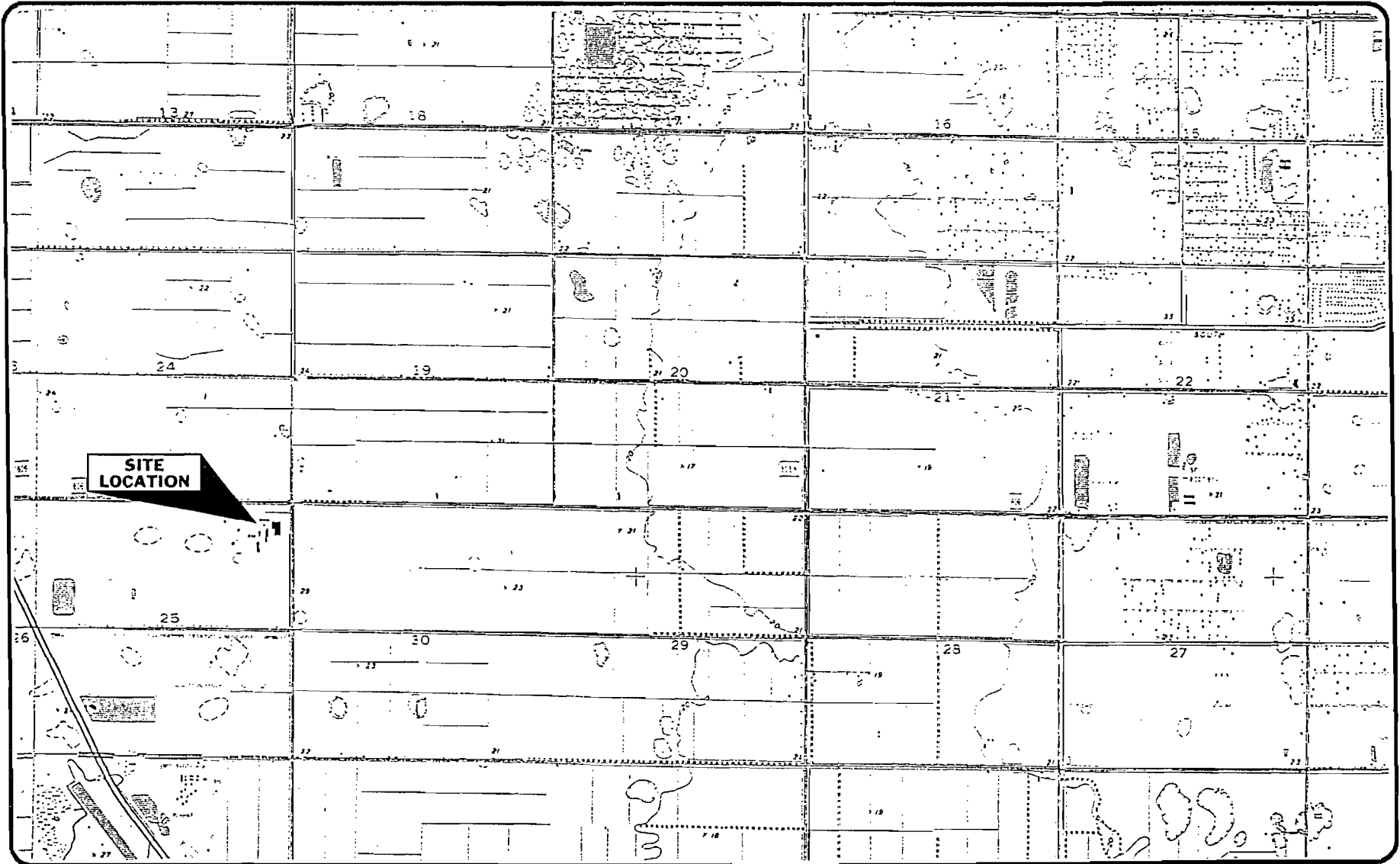

LOCATION MAP

**ROTORF**  
Associates Inc.  
CONSULTING ENGINEERS-ANALYTICAL LABORATORY  
4729 COWHATER COMMERCE PARKWAY ORLANDO, FLORIDA 32818-4278  
PHONE (407) 298-2846

OCEAN SPRAY CRANBERRIES, INC.  
VERO BEACH, INDIAN RIVER COUNTY, FLORIDA

USGS MAP: OSLO, FLA.	104 PROJECT NO
DATE: 5/9/96	
SCALE: 1 IN = 2000 FT	

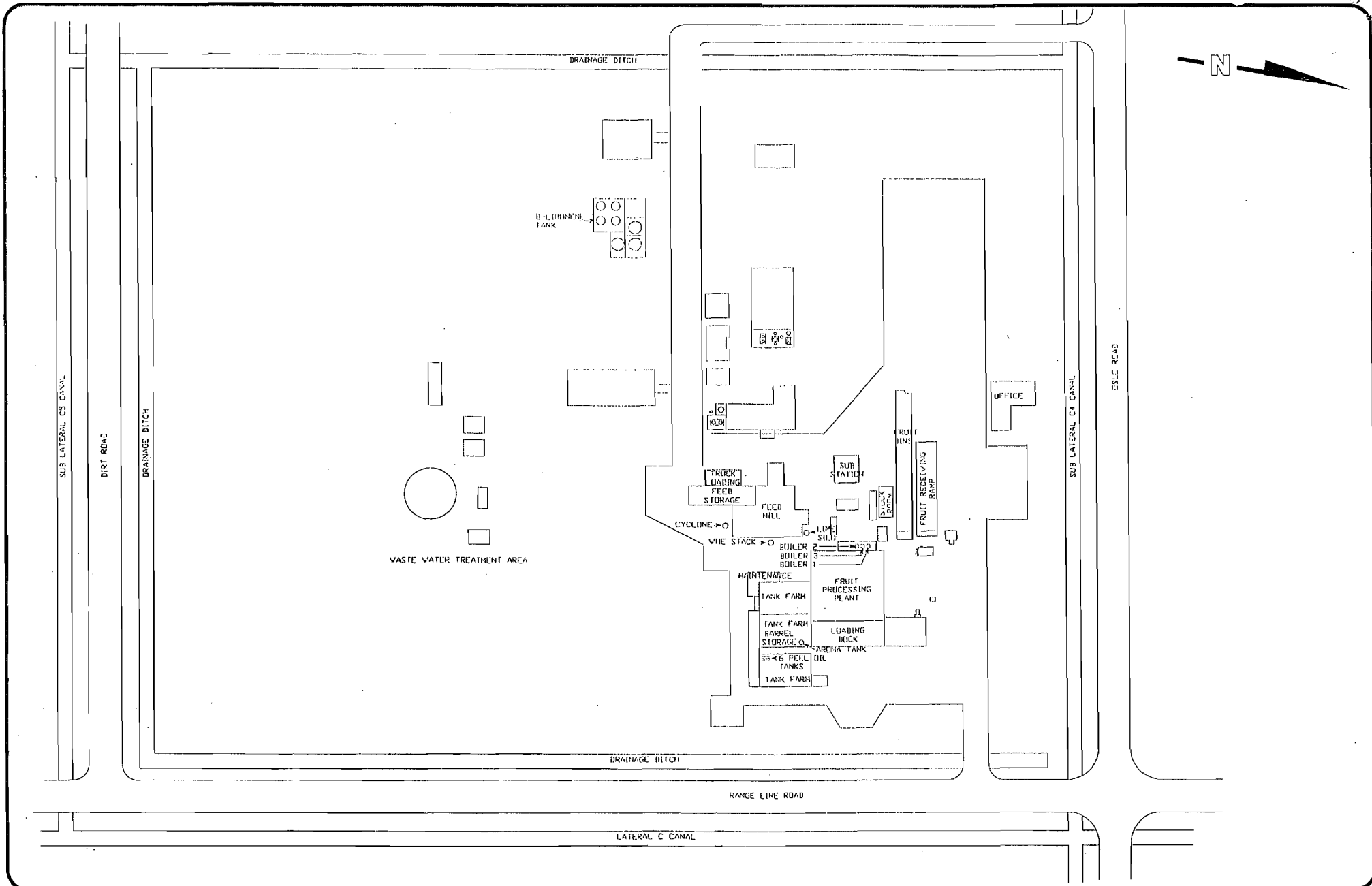

**ROTTOFF**  
**Associates Inc.**  
 CONSULTING ENGINEERS-ANALYTICAL LABORATORY  
 6729 EDGEWATER CONCERCE PARKWAY ORLANDO FLORIDA 32810-1278  
 PHONE: (407) 278-0846

**Ocean Spray Cranberries, Inc.**  
**Vero Beach, Indian River County, Florida**

DATE:	REVISION:

DRAWN BY: KDD	DATE: 5/13/98
REVIEWED BY: RTC	VERSION: 10/386
SCALE: NS	FILENAME: SITE0104

104-1  
 PROJECT NO

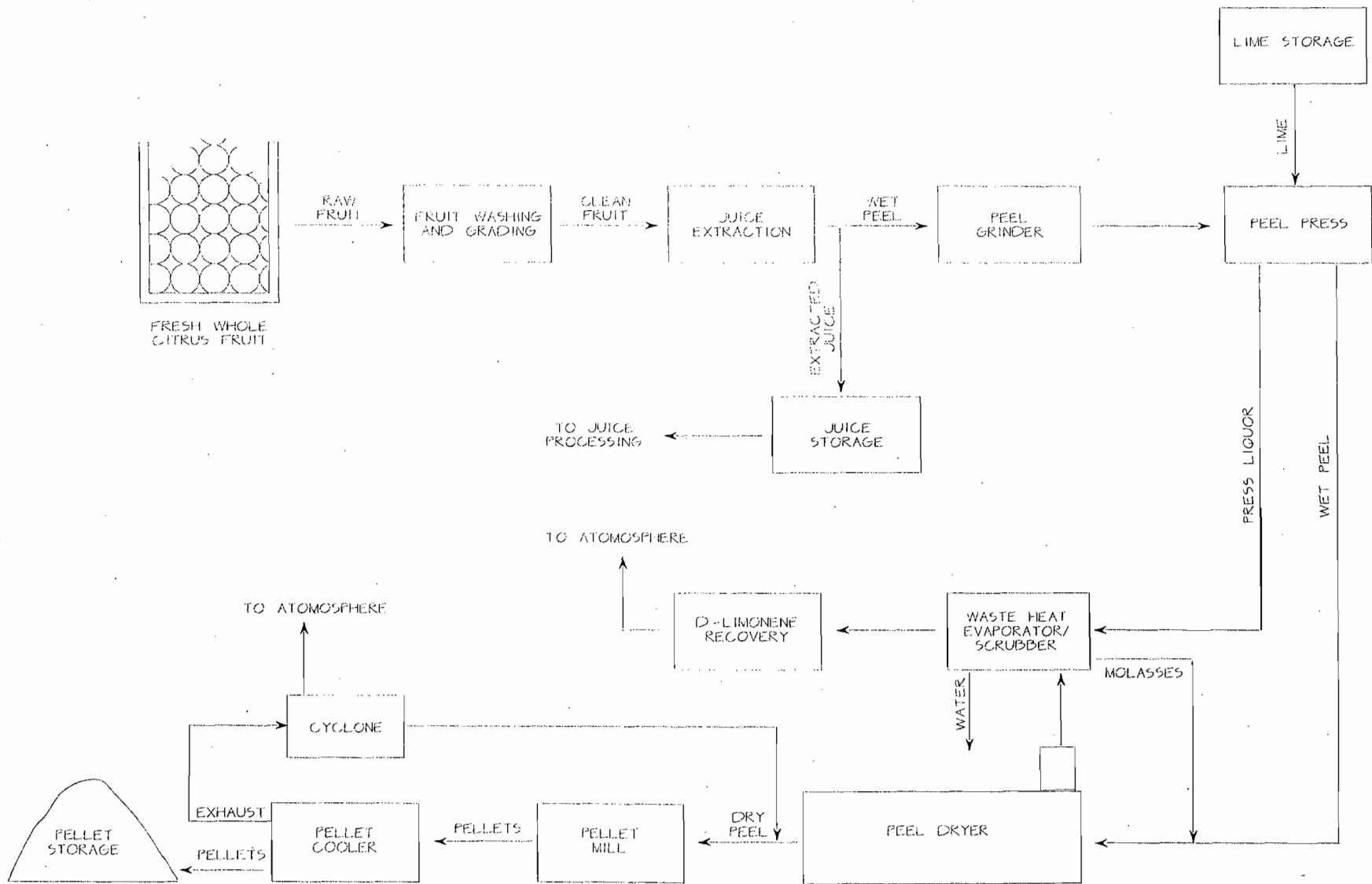

PROCESS FLOW DIAGRAM



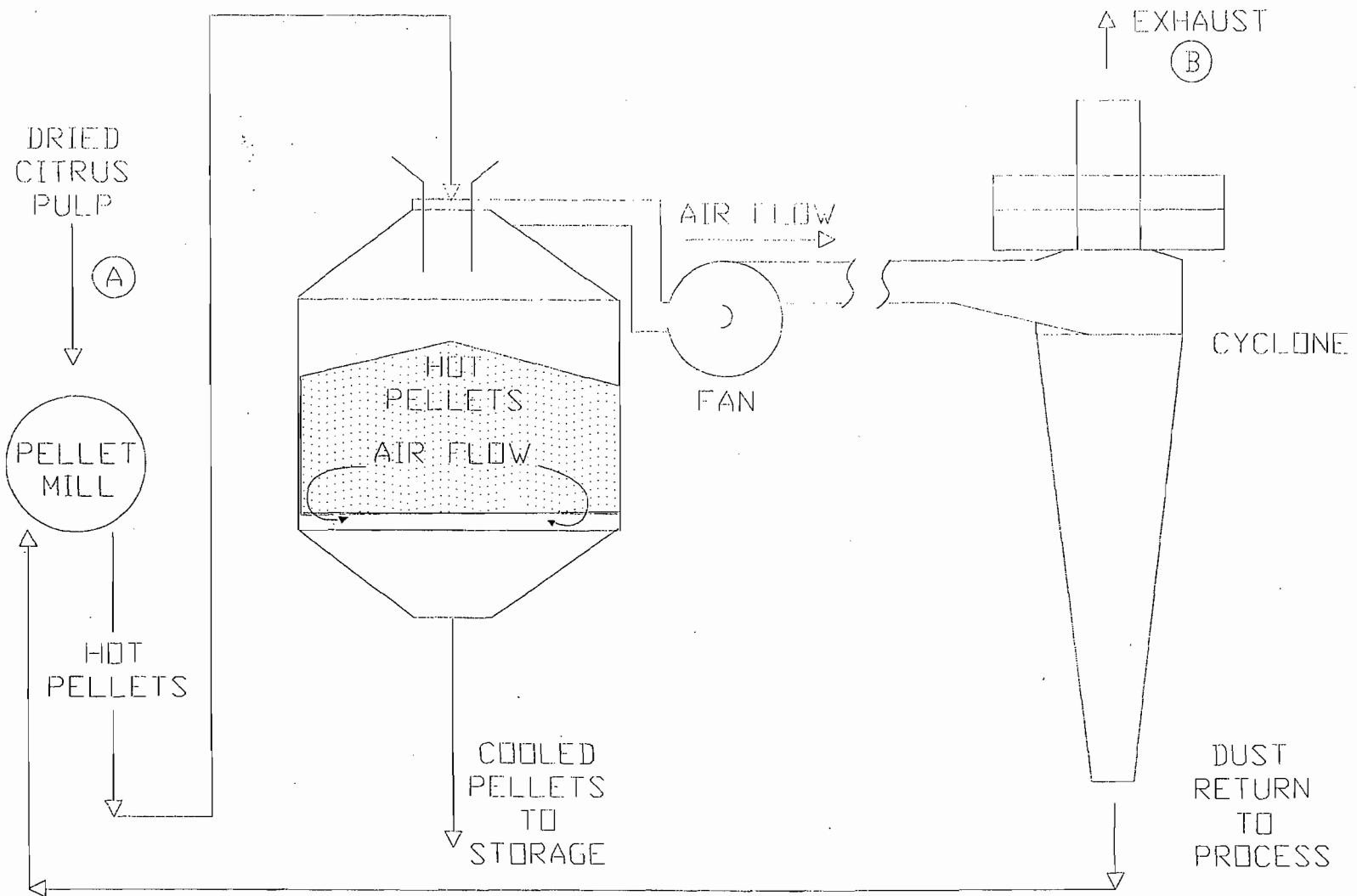

FLOW DIAGRAM

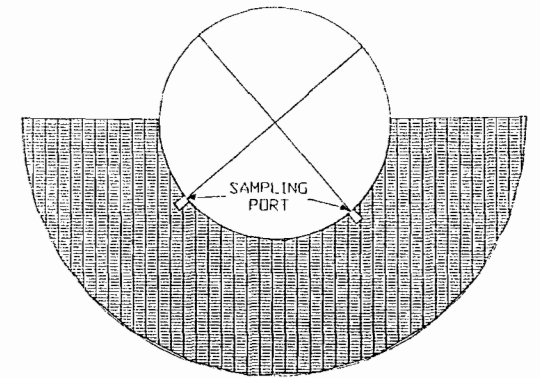
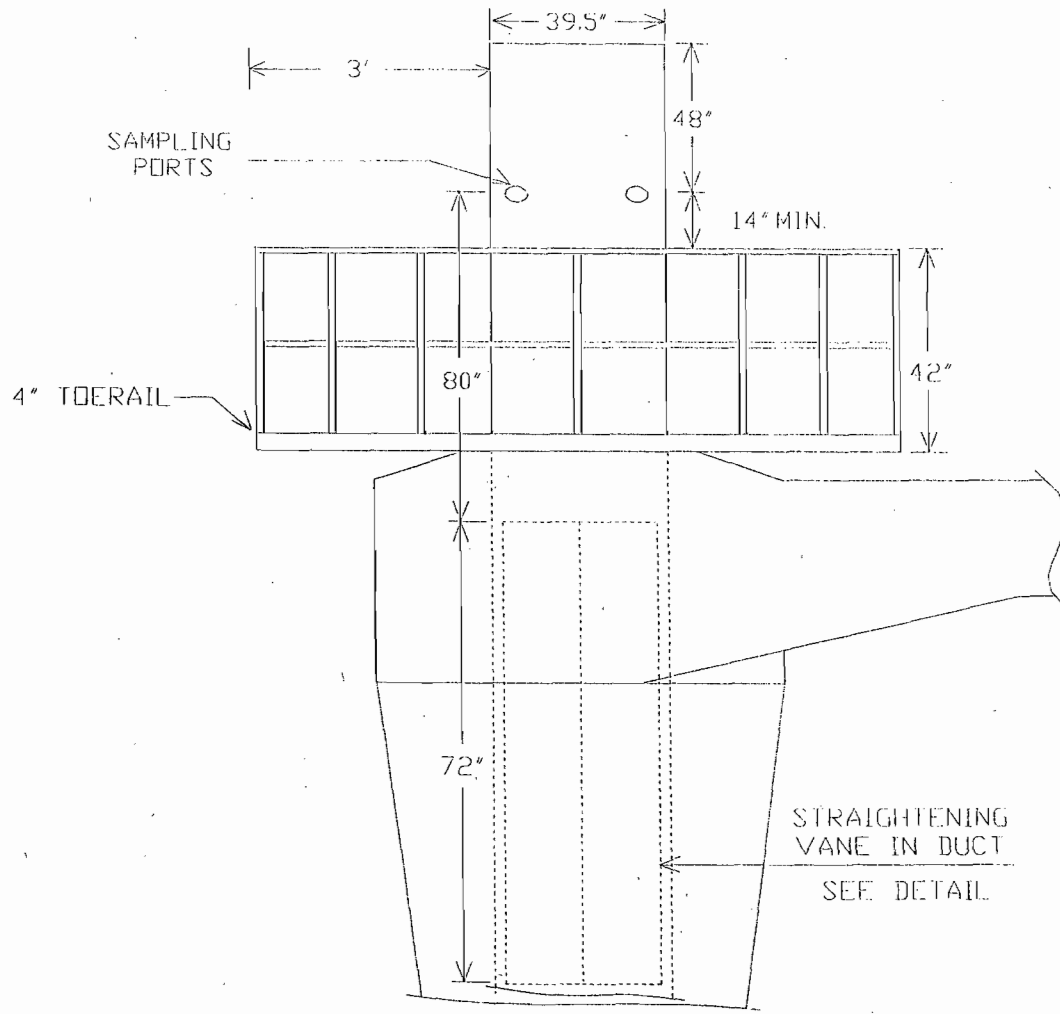

STACK CROSS SECTION  
TOP VIEW

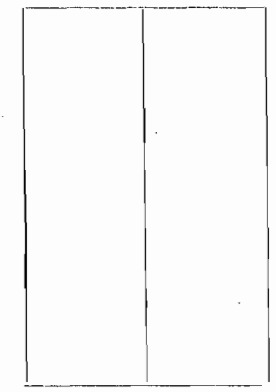

STRAIGHTENING VANE  
SIDE VIEW

DESCRIPTION OF STACK SAMPLING FACILITY

**ROTORF ASSOCIATES INC.**  
CONSULTING ENGINEERS-ANALYTICAL LABORATORY  
6729 EDGEWATER COMMERCE PARKWAY ORLANDO, FLORIDA 32810-4279  
PHONE: (407) 275-0846

**OCEAN SPRAY CRANBERRIES, INC.**  
**PELLET COOLER CYCLONE**

DATE:	REVISION:
2/18/91	REVISED TITLE BLOCK

DRAWN BY: KDU	DATE: 5/14/96
REVIEWED BY: RTC	VERSION: 10/386
SCALE: No Scale	FILENAME: STK104PC

104-4  
PROJECT NO

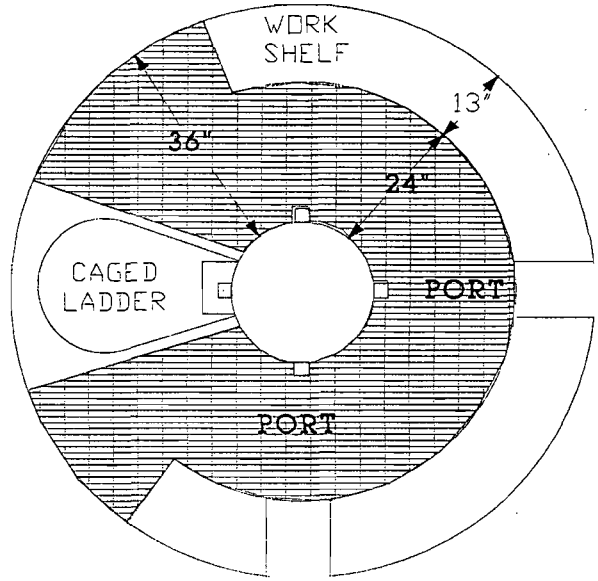
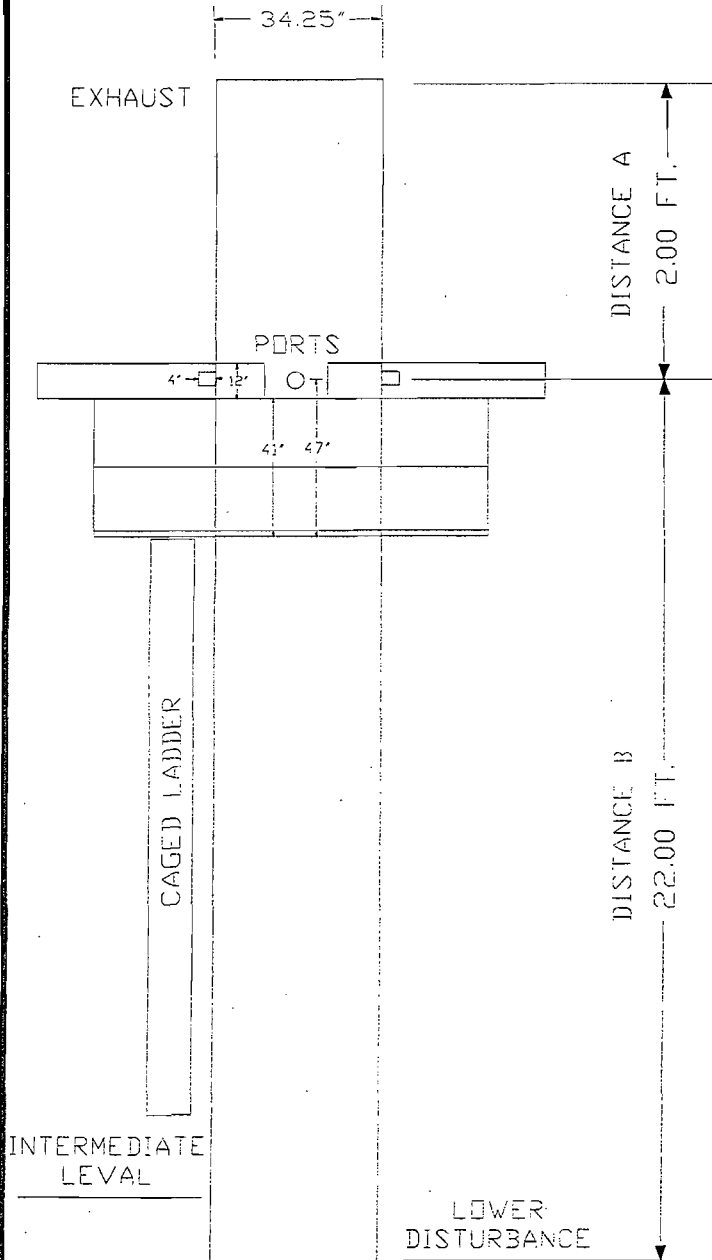

**DESCRIPTION OF  
STACK SAMPLING  
FACILITIES**

**ROTTORF  
Associates Inc.**

CONSULTING ENGINEERS-ANALYTICAL LABORATORY  
6789 EDGEWATER COMMERCE PARKWAY DANIEL FLORIDA 32815-4279  
PHONE: (407) 926-0246

**OCEAN SPRAY CRANBERRIES, INC.  
DRYER/WASTE HEAT  
EVAPORATOR**

DRAWN BY: KDB	DATE: 5/14/96
REVIEWED BY: RTC	VERSION: 10/386
SCALE: No Scale	FILENAME: STK215D

104-4  
PROJECT NO.

**U.S. Postal Service**  
**CERTIFIED MAIL RECEIPT**  
*(Domestic Mail Only; No Insurance Coverage Provided)*

7099 3400 0000 1449 5533

Article Sent To:  
 Mr. Mark Smidebush

Postage	\$	Postmark Here
Certified Fee		
Return Receipt Fee (Endorsement Required)		
Restricted Delivery Fee (Endorsement Required)		
<b>Total Postage &amp; Fees</b>	\$	

Name *(Please Print Clearly) (to be completed by mailer)*  
 Mr. Mark Smidebush  
 Street, Apt. No., or PO Box No.  
 925 74th Avenue, Southwest  
 City, State, ZIP+4  
 Vero Beach, Florida 32968-9702