

# **ATTACHMENT J**

**Application to Operate/Construct Air Pollution Sources**

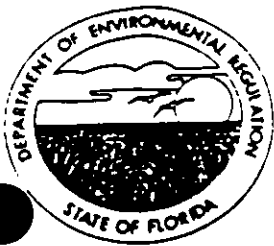

# Florida Department of Environmental Regulation

Twin Towers Office Bldg. • 2600 Blair Stone Road • Tallahassee, Florida 32399-2400

Lawton Chiles, Governor

AC 26-238006  
PSD-FL-208

Carol M. Browner, Secretary

#7500 pd  
9-17-93

Recpt # 180874

## APPLICATION TO OPERATE/CONSTRUCT AIR POLLUTION SOURCES

SOURCE TYPE: Bagasse/Oil-Fired Boiler  New<sup>1</sup>  Existing<sup>1</sup>

APPLICATION TYPE:  Construction  Operation  Modification

COMPANY NAME: U. S. Sugar Corporation, Clewiston Mill COUNTY: Hendry

Identify the specific emission point source(s) addressed in this application (i.e. Lime Kiln No. 4 with Venturi Scrubber; Peaking Unit No. 2, Gas Fired) Boiler No. 7

SOURCE LOCATION: Street W. C. Owens Avenue and Clewiston Street City Clewiston

UTM: East 506.1 North 2956.9

Latitude 26 ° 44 ' 05 "N Longitude 80 ° 56 ' 20 "W

APPLICANT NAME AND TITLE: Murray T. Brinson, Vice President, Sugar Processing

APPLICANT ADDRESS: P.O. Drawer 1207, Clewiston, Florida 33440

### SECTION I: STATEMENTS BY APPLICANT AND ENGINEER

#### A. APPLICANT

I am the undersigned owner or authorized representative\* of U.S. Sugar Corporation

I certify that the statements made in this application for a Construction permit are true, correct and complete to the best of my knowledge and belief. Further, I agree to maintain and operate the pollution control source and pollution control facilities in such a manner as to comply with the provision of Chapter 403, Florida Statutes, and all the rules and regulations of the department and revisions thereof. I also understand that a permit, if granted by the department, will be non-transferable and I will promptly notify the department upon sale or legal transfer of the permit establishment.

\*Attach letter of authorization

Signed: Murray T. Brinson

Murray T. Brinson, Vice President, Sugar Processing  
Name and Title (Please Type)

Date: 9-16-93 Telephone No. 813/983-8121

#### B. PROFESSIONAL ENGINEER REGISTERED IN FLORIDA (where required by Chapter 471, F.S.)

This is to certify that the engineering features of this pollution control project have been designed/examined by me and found to be in conformity with modern engineering principles applicable to the treatment and disposal of pollutants characterized in the permit application. There is reasonable assurance, in my professional judgment, that

<sup>1</sup> See Florida Administrative Code Rule 17-2.100(57) and (104)

the pollution control facilities, when properly maintained and operated, will discharge an effluent that complies with all applicable statutes of the State of Florida and the rules and regulations of the department. It is also agreed that the undersigned will furnish, if authorized by the owner, the applicant a set of instructions for the proper maintenance and operation of the pollution control facilities and, if applicable, pollution sources.

Signed Peter J. Kroll

Peter Kroll

Name (Please Type)

ICF Kaiser Engineers, Inc.

Company Name (Please Type)

4 Gateway Center; Pittsburgh, PA 15222-1207

Mailing Address (Please Type)

Florida Registration No. PE0046447 Date: Feb. 26, 1993 Telephone No. 412/497-2024

SECTION II: GENERAL PROJECT INFORMATION

412/497-2349

- A. Describe the nature and extent of the project. Refer to pollution control equipment, and expected improvements in source performance as a result of installation. State whether the project will result in full compliance. Attach additional sheet if necessary.

See PSD Report

- B. Schedule of project covered in this application (Construction Permit Application Only)

Start of Construction February 1994\* Completion of Construction January 1995\*

- C. Costs of pollution control system(s): (Note: Show breakdown of estimated costs only for individual components/units of the project serving pollution control purposes. Information on actual costs shall be furnished with the application for operation permit.)

Spray Impingement Scrubber: \$570,000

- D. Indicate any previous DER permits, orders and notices associated with the emission point, including permit issuance and expiration dates.

See PSD Report for permits for existing boilers

\* Assumes permit to construct issued in January 1994

E. Requested permitted equipment operating time: hrs/day 24 ; days/wk 7 ; wks/yr 52 ;  
if power plant, hrs/yr \_\_\_\_\_ ; if seasonal, describe: \_\_\_\_\_  
\_\_\_\_\_  
\_\_\_\_\_

F. If this is a new source or major modification, answer the following questions.  
(Yes or No)

1. Is this source in a non-attainment area for a particular pollutant? No  
a. If yes, has "offset" been applied? \_\_\_\_\_  
b. If yes, has "Lowest Achievable Emission Rate" been applied? \_\_\_\_\_  
c. If yes, list non-attainment pollutants. \_\_\_\_\_

2. Does best available control technology (BACT) apply to this source?  
If yes, see Section VI. Yes

3. Does the State "Prevention of Significant Deterioration" (PSD)  
requirement apply to this source? If yes, see Sections VI and VII. Yes

4. Do "Standards of Performance for New Stationary Sources" (NSPS)  
apply to this source? Yes

5. Do "National Emission Standards for Hazardous Air Pollutants"  
(NESHAP) apply to this source? No

H. Do "Reasonably Available Control Technology" (RACT) requirements apply  
to this source? No

a. If yes, for what pollutants? \_\_\_\_\_

b. If yes, in addition to the information required in this form,  
any information requested in Rule 17-2.650 must be submitted.

Attach all supportive information related to any answer of "Yes". Attach any justifi-  
cation for any answer of "No" that might be considered questionable.

See PSD Report for Source Applicability

D. Control Devices: (See Section V, Item 4)

Name and Type (Model & Serial No.)	Contaminant	Efficiency	Range of Particles Size Collected (in microns) (Iff applicable.)	Basis for Efficiency (Section V Item 5)
Spray Impingement Scrubber Joy Turbulaire	Particulate	90+ %	See PSD Report	See PSD Report
Type D. Size 260 or equivalent, two in parallel	SO <sub>2</sub> from bagasse	75%	N/A	"

E. Fuels

Type (Be Specific)	Consumption*		Maximum Heat Input (MMBTU/hr)
	avg/hr	max./hr	
Bagasse		92.3 ton/hr (wet)	738
No. 6 Fuel Oil		1,700 gal/hr	255

\* Units: Natural Gas--MMCF/hr; Fuel Oils--gallons/hr; Coal, wood, refuse, other--lbs/hr.

Fuel Analysis: See PSD Report

Percent Sulfur: \_\_\_\_\_

Percent Ash: \_\_\_\_\_

Density: \_\_\_\_\_ lbs/gal

Typical Percent Nitrogen: \_\_\_\_\_

Heat Capacity: \_\_\_\_\_ BTU/lb

\_\_\_\_\_ BTU/gal

Other Fuel Contaminants (which may cause air pollution): \_\_\_\_\_

F. If applicable, indicate the percent of fuel used for space heating.

Annual Average Not Applicable

Maximum Not Applicable

G. Indicate liquid or solid wastes generated and method of disposal.

Water from Scrubbers used to sluice cane juice mud. Scrubber water discharges to holding ponds.

H. Emission Stack Geometry and Flow Characteristics (Provide data for each stack):

Stack Height: 225 ft. Stack Diameter: 8.63 ft.  
 Flow Rate: See PSD Report ACFM DSCFM Gas Exit Temperature: 153 °F.  
 Water Vapor Content: 15-30 (vol %) % Velocity: See PSD Report FPS

SECTION IV: INCINERATOR INFORMATION

Not Applicable

Type of Waste	Type 0 (Plastics)	Type I (Rubbish)	Type II (Refuse)	Type III (Garbage)	Type IV (Pathological)	Type V (Liq. & Gas By-prod.)	Type VI (Solid By-prod.)
Actual lb/hr Incinerated							
Uncontrolled (lbs/hr)							

Description of Waste \_\_\_\_\_

Total Weight Incinerated (lbs/hr) \_\_\_\_\_ Design Capacity (lbs/hr) \_\_\_\_\_

Approximate Number of Hours of Operation per day \_\_\_\_\_ day/wk \_\_\_\_\_ wks/yr. \_\_\_\_\_

Manufacturer: \_\_\_\_\_

Date Constructed \_\_\_\_\_ Model No. \_\_\_\_\_

	Volume (ft) <sup>3</sup>	Heat Release (BTU/hr)	Fuel		Temperature (°F)
			Type	BTU/hr	
Primary Chamber					
Secondary Chamber					

Stack Height: \_\_\_\_\_ ft. Stack Diameter: \_\_\_\_\_ Stack Temp. \_\_\_\_\_

Gas Flow Rate: \_\_\_\_\_ ACFM \_\_\_\_\_ DSCFM\* Velocity: \_\_\_\_\_ FPS

\*IF 30 or more tons per day design capacity, submit the emissions rate in grains per standard cubic foot dry gas corrected to 50% excess air.

Type of pollution control device:  Cyclone  Wet Scrubber  Afterburner  
 Other (specify) \_\_\_\_\_

Brief description of operating characteristics of control devices: \_\_\_\_\_

Ultimate disposal of any effluent other than that emitted from the stack (scrubber water, ash, etc.):

NOTE: Items 2, 3, 4, 6, 7, 8, and 10 in Section V must be included where applicable.

### SECTION V: SUPPLEMENTAL REQUIREMENTS See PSD Report

Please provide the following supplements where required for this application.

1. Total process input rate and product weight -- show derivation [Rule 17-2.100(127)]
2. To a construction application, attach basis of emission estimate (e.g., design calculations, design drawings, pertinent manufacturer's test data, etc.) and attach proposed methods (e.g., FR Part 60 Methods 1, 2, 3, 4, 5) to show proof of compliance with applicable standards. To an operation application, attach test results or methods used to show proof of compliance. Information provided when applying for an operation permit from a construction permit shall be indicative of the time at which the test was made.
3. Attach basis of potential discharge (e.g., emission factor, that is, AP42 test).
4. With construction permit application, include design details for all air pollution control systems (e.g., for baghouse include cloth to air ratio; for scrubber include cross-section sketch, design pressure drop, etc.)
5. With construction permit application, attach derivation of control device(s) efficiency. Include test or design data. Items 2, 3 and 5 should be consistent: actual emissions = potential (1-efficiency).
6. An 8 1/2" x 11" flow diagram which will, without revealing trade secrets, identify the individual operations and/or processes. Indicate where raw materials enter, where solid and liquid waste exit, where gaseous emissions and/or airborne particles are evolved and where finished products are obtained.
7. An 8 1/2" x 11" plot plan showing the location of the establishment, and points of airborne emissions, in relation to the surrounding area, residences and other permanent structures and roadways (Example: Copy of relevant portion of USGS topographic map).
8. An 8 1/2" x 11" plot plan of facility showing the location of manufacturing processes and outlets for airborne emissions. Relate all flows to the flow diagram.

- 9. The appropriate application fee in accordance with Rule 17-4.05. The check should be made payable to the Department of Environmental Regulation.
- 10. With an application for operation permit, attach a Certificate of Completion of Construction indicating that the source was constructed as shown in the construction permit.

**SECTION VI: BEST AVAILABLE CONTROL TECHNOLOGY**

A. Are standards of performance for new stationary sources pursuant to 40 C.F.R. Part 60 applicable to the source?

Yes     No    **For oil firing**

Contaminant	Rate of Concentration
Particulate	0.1 lb/MM Btu
SO <sub>2</sub>	0.5 lb/MM Btu or low-sulfur oil
NO <sub>x</sub>	0.3 - 0.4 lb/MM Btu or low-nitrogen oil

B. Has EPA declared the best available control technology for this class of sources (If yes, attach copy.)

Yes     No    **For oil firing**

Contaminant	Rate of Concentration
Particulate	0.1 lb/MM Btu
SO <sub>2</sub>	0.5% sulfur oil (very low sulfur oil)
NO <sub>x</sub>	Low-NO <sub>x</sub> burners

C. What emission levels do you propose as best available control technology?

Contaminant	Rate of Concentration
Particulate - bagasse / oil	0.15 lb/MM Btu / 0.1 lb/MM Btu
Sulfur dioxide - bagasse / oil	0.1667 lb/MM Btu / 0.5% S oil
NO <sub>x</sub> -bagasse/oil	0.26 lb/MM Btu / 0.3% N oil
Other pollutants	Maximum emission rate shown in Section III.C

D. Describe the existing control and treatment technology (if any). See PSD Report

- |                           |                   |
|---------------------------|-------------------|
| 1. Control Device/System: | 2. Operating      |
| 3. Efficiency:*           | 4. Capital Costs: |

\* Explain method of determining.



5. Useful Life:

6. Operating Costs:

7. Energy:

8. Maintenance Cost:

9. Emissions:

Contaminant

Rate or Concentration

Contaminant	Rate or Concentration

10. Stack Parameters

- a. Height: ft.
- b. Diameter: ft.
- c. Flow Rate: ACFM
- d. Temperature: °F.
- e. Velocity: FPS

E. Describe the control and treatment technology available (As many types as applicable, use additional pages if necessary). See PSD Report

1.

- a. Control Device:
- b. Operating Principles:
- c. Efficiency:<sup>1</sup>
- d. Capital Cost:
- e. Useful Life:
- f. Operating Cost:
- g. Energy:<sup>2</sup>
- h. Maintenance Cost:
- i. Availability of construction materials and process chemicals:
- j. Applicability to manufacturing processes:
- k. Ability to construct with control device, install in available space, and operate within proposed levels:

2.

- a. Control Device:
- b. Operating Principles:
- c. Efficiency:<sup>1</sup>
- d. Capital Cost:
- e. Useful Life:
- f. Operating Cost:
- g. Energy:<sup>2</sup>
- h. Maintenance Cost:
- i. Availability of construction materials and process chemicals:

<sup>1</sup>Explain method of determining efficiency.

<sup>2</sup>Energy to be reported in units of electrical power - KWH design rate.

j. Applicability to manufacturing processes:

k. Ability to construct with control device, install in available space, and operate within proposed levels:

3.

a. Control Device:

b. Operating Principles:

c. Efficiency:<sup>1</sup>

d. Capital Cost:

e. Useful Life:

f. Operating Cost:

g. Energy:<sup>2</sup>

h. Maintenance Cost:

i. Availability of construction materials and process chemicals:

j. Applicability to manufacturing processes:

k. Ability to construct with control device, install in available space, and operate within proposed levels:

4.

a. Control Device:

b. Operating Principles:

c. Efficiency:<sup>1</sup>

d. Capital Costs:

e. Useful Life:

f. Operating Cost:

g. Energy:<sup>2</sup>

h. Maintenance Cost:

i. Availability of construction materials and process chemicals:

j. Applicability to manufacturing processes:

k. Ability to construct with control device, install in available space, and operate within proposed levels:

F. Describe the control technology selected:

See PSD Report

1. Control Device:

2. Efficiency:<sup>1</sup>

3. Capital Cost:

4. Useful Life:

5. Operating Cost:

6. Energy:<sup>2</sup>

7. Maintenance Cost:

8. Manufacturer:

9. Other locations where employed on similar processes:

a. (1) Company:

(2) Mailing Address:

(3) City:

(4) State:

<sup>1</sup>Explain method of determining efficiency.

<sup>2</sup>Energy to be reported in units of electrical power - KWH design rate.

(5) Environmental Manager:

(6) Telephone No.:

(7) Emissions:<sup>1</sup>

Contaminant	Rate or Concentration

(8) Process Rate:<sup>1</sup>

b. (1) Company:

(2) Mailing Address:

(3) City:

(4) State:

(5) Environmental Manager:

(6) Telephone No.:

(7) Emissions:<sup>1</sup>

Contaminant	Rate or Concentration

(8) Process Rate:<sup>1</sup>

10. Reason for selection and description of systems:

<sup>1</sup>Applicant must provide this information when available. Should this information not be available, applicant must state the reason(s) why.

### SECTION VII - PREVENTION OF SIGNIFICANT DETERIORATION

#### A. Company Monitored Data

1. PSCL no. sites 11 . TSP 1 ( ) SO<sub>2</sub>\* \_\_\_\_\_ Wind spd/dir

Period of Monitoring 1 / 1 / 89 to 12 / 30 / 91  
month day year month day year

Other data recorded \_\_\_\_\_

Attach all data or statistical summaries to this application.

\*Specify bubbler (B) or continuous (C).

2. Instrumentation, Field and Laboratory

- a. Was instrumentation EPA referenced or its equivalent?  Yes  No
- b. Was instrumentation calibrated in accordance with Department procedures?  
 Yes  No  Unknown

B. Meteorological Data Used for Air Quality Modeling

1. 5 Year(s) of data from 1 / 1 / 85 to 12 / 31 / 89  
month day year month day year
2. Surface data obtained from (location) \_\_\_\_\_
3. Upper air (mixing height) data obtained from (location) \_\_\_\_\_
4. Stability wind rose (STAR) data obtained from (location) \_\_\_\_\_

C. Computer Models Used

1. Industrial Source Complex 2 Modified? If yes, attach description.
2. \_\_\_\_\_ Modified? If yes, attach description.
3. \_\_\_\_\_ Modified? If yes, attach description.
4. \_\_\_\_\_ Modified? If yes, attach description.

Attach copies of all final model runs showing input data, receptor locations, and principle output tables.

D. Applicants Maximum Allowable Emission Data

Pollutant	Emission Rate
JSP	<u>See PSD Report</u> grams/sec
SO <sub>2</sub>	<u>See PSD Report</u> grams/sec

E. Emission Data Used in Modeling See PSD Report

Attach list of emission sources. Emission data required is source name, description of point source (on NEDS point number), UTM coordinates, stack data, allowable emissions, and normal operating time.

F. Attach all other information supportive to the PSD review. See PSD Report

G. Discuss the social and economic impact of the selected technology versus other applicable technologies (i.e., jobs, payroll, production, taxes, energy, etc.). Include assessment of the environmental impact of the sources. See PSD Report

H. Attach scientific, engineering, and technical material, reports, publications, journals, and other competent relevant information describing the theory and application of the requested best available control technology. See attached supportive information.

# **ATTACHMENT K**

**List of Dispersion Modeling Input Files**

# U.S. SUGAR DISPERSION MODELING INPUT DISK DIRECTORY

## **1.0 Meteorological Data**

Meteorological data used in the ISCST2 model to determine air quality impacts consisted of a concurrent 5-year period (from 1985 through 1989) of hourly surface-weather observations and twice-daily upper-air soundings from the National Weather Service (NWS) station at West Palm Beach. The surface observations included wind direction, wind speed, temperature, cloud cover, and cloud ceiling.

Sequential hourly data bases were computed for each year by using EPA's randomized meteorological (RAMMET) preprocessor program. RAMMET estimates atmospheric stability from wind speed, cloud cover, and cloud ceiling values, and estimates mixing heights using the Holzworth approach. RAMMET also randomizes the observed wind directions, which are rounded to the nearest tenth degree by the NWS, in an effort to account for expected variability in the actual wind field.

### Mixing height data files

- 12844-85.DAT
- 12844-86.DAT
- 12844-87.DAT
- 12844-88.DAT
- 12844-89.DAT

### Surface weather data files

- S85.DAT
- S86.DAT
- S87.DAT
- S88.DAT
- S89.DAT

## **2.0 Significant Impact Analysis**

As discussed in Section 6.9.1, modeling was conducted to define the significant impact area for CO, NO<sub>2</sub>, PM<sub>10</sub> and SO<sub>2</sub> for the years 1985-1989, and the input data files are as follows:

### CO 1-hour/8-hour

- SIG2CO.D85
- SIG2CO.D86
- SIG2CO.D87
- SIG2CO.D88
- SIG2CO.D89

### NO<sub>2</sub> Annual

- SIG2NOAN.D85
- SIG2NOAN.D86
- SIG2NOAN.D87
- SIG2NOAN.D88
- SIG2NOAN.D89

PM10 24-hour

- SIG2PM24.D85
- SIG2PM24.D86
- SIG2PM24.D87
- SIG2PM24.D88
- SIG2PM24.D89

PM10 Annual

- SIG2PMAN.D85
- SIG2PMAN.D86
- SIG2PMAN.D87
- SIG2PMAN.D88
- SIG2PMAN.D89

SO<sub>2</sub> 3-hour

- SIG2SO03.D85
- SIG2SO03.D86
- SIG2SO03.D87
- SIG2SO03.D88
- SIG2SO03.D89

SO<sub>2</sub> 24-hour

- SIG2SO24.D85
- SIG2SO24.D86
- SIG2SO24.D87
- SIG2SO24.D88
- SIG2SO24.D89

SO<sub>2</sub> Annual

- SIG2SOAN.D85
- SIG2SOAN.D86
- SIG2SOAN.D87
- SIG2SOAN.D88
- SIG2SOAN.D89

**3.0 PSD Class I Analysis**

As discussed in Section 6.9.4, modeling was conducted to define the impact on Class I areas for NO<sub>2</sub>, PM10 and SO<sub>2</sub> for the years 1985-1989, and the input data files are as follows:

**3.1 Crop Season**

NO<sub>2</sub> Annual

- CPS2NO.D85
- CPS2NO.D86
- CPS2NO.D87

- CPS2NO.D88
- CPS2NO.D89

PM10 24-hour

- CPS2PM24.D85
- CPS2PM24.D86
- CPS2PM24.D87
- CPS2PM24.D88
- CPS2PM24.D89

PM10 Annual

- CPS2PMAN.D85
- CPS2PMAN.D86
- CPS2PMAN.D87
- CPS2PMAN.D88
- CPS2PMAN.D89

SO<sub>2</sub> 3-hour

- CPS2SO03.D85
- CPS2SO03.D86
- CPS2SO03.D87
- CPS2SO03.D88
- CPS2SO03.D89

SO<sub>2</sub> 24-hour

- CPS2SO24.D85
- CPS2SO24.D86
- CPS2SO24.D87
- CPS2SO24.D88
- CPS2SO24.D89

SO<sub>2</sub> Annual

- CPS2SOAN.D85
- CPS2SOAN.D86
- CPS2SOAN.D87
- CPS2SOAN.D88
- CPS2SOAN.D89

**3.2 Off-season**

Note that the annual impact modeling was done under "crop season" above, so the off-season modeling runs were only for short-term impacts.

PM10 24-hour

- OPS2PM24.D85
- OPS2PM24.D86
- OPS2PM24.D87



- OPS2PM24.D88
- OPS2PM24.D89

SO<sub>2</sub> 3-hour

- OPS2SO03.D85
- OPS2SO03.D86
- OPS2SO03.D87
- OPS2SO03.D88
- OPS2SO03.D89

SO<sub>2</sub> 24-hour

- OPS2SO24.D85
- OPS2SO24.D86
- OPS2SO24.D87
- OPS2SO24.D88
- OPS2SO24.D89

**4.0 Preconstruction Monitoring Runs**

As discussed in Section 4, modeling was conducted to demonstrate that CO and NO<sub>2</sub> does not exceed the established *de minimus* ambient impacts, and the input data files for the years 1985-1989 are as follows:

CO: Crop Season

- CPC2CO.D85
- CPC2CO.D86
- CPC2CO.D87
- CPC2CO.D88
- CPC2CO.D89

CO: Off-season

- OPC2CO.D85
- OPC2CO.D86
- OPC2CO.D87
- OPC2CO.D88
- OPC2CO.D89

NO

- CPC2NO.D85
- CPC2NO.D86
- CPC2NO.D87
- CPC2NO.D88
- CPC2NO.D89

### 5.0 AAQS and PSD Class II Impact Analysis Runs

As discussed in Section 6.9.2, modeling was conducted to define the impact on AAQS for CO, NO<sub>2</sub>, PM10, SO<sub>2</sub>, and air toxics for the years 1985-1989. The same input data files were also used for PSD Class II impact analysis for NO<sub>2</sub>, PM10/PM(TSP) and SO<sub>2</sub>, as discussed in Section 6.9.3. The input files are as follows:

#### 5.1 Crop Season

##### CO 1-hour/8-hour

- CRF2CO.D85
- CRF2CO.D86
- CRF2CO.D87
- CRF2CO.D88
- CRF2CO.D89

##### NO<sub>2</sub> Annual

- CRF2NO.D85
- CRF2NO.D86
- CRF2NO.D87
- CRF2NO.D88
- CRF2NO.D89

##### PM10 24-hour

- CRF2PM24.D85
- CRF2PM24.D86
- CRF2PM24.D87
- CRF2PM24.D88
- CRF2PM24.D89

##### PM10 Annual

- CRF2PMAN.D85
- CRF2PMAN.D86
- CRF2PMAN.D87
- CRF2PMAN.D88
- CRF2PMAN.D89

##### SO<sub>2</sub> 3-hour

- CRF2SO03.D85
- CRF2SO03.D86
- CRF2SO03.D87
- CRF2SO03.D88
- CRF2SO03.D89

##### SO<sub>2</sub> 24-hour

- CRF2SO24.D85
- CRF2SO24.D86

- CRF2SO24.D87
- CRF2SO24.D88
- CRF2SO24.D89

SO<sub>2</sub> Annual

- CRF2SOAN.D85
- CRF2SOAN.D86
- CRF2SOAN.D87
- CRF2SOAN.D88
- CRF2SOAN.D89

Toxics 8-hour

- CRF2TX08.D85
- CRF2TX08.D86
- CRF2TX08.D87
- CRF2TX08.D88
- CRF2TX08.D89

Toxics 24-hour

- CRF2TX24.D85
- CRF2TX24.D86
- CRF2TX24.D87
- CRF2TX24.D88
- CRF2TX24.D89

Toxics Annual

- CRF2TXAN.D85
- CRF2TXAN.D86
- CRF2TXAN.D87
- CRF2TXAN.D88
- CRF2TXAN.D89

**5.2 Off-season**

CO 1-hour/8-hour

- ORF2CO.D85
- ORF2CO.D86
- ORF2CO.D87
- ORF2CO.D88
- ORF2CO.D89

PM10 24-hour

- ORF2PM24.D85
- ORF2PM24.D86
- ORF2PM24.D87
- ORF2PM24.D88
- ORF2PM24.D89

SO<sub>2</sub> 3-hour

- ORF2SO03.D85
- ORF2SO03.D86
- ORF2SO03.D87
- ORF2SO03.D88
- ORF2SO03.D89

SO<sub>2</sub> 24-hour

- ORF2SO24.D85
- ORF2SO24.D86
- ORF2SO24.D87
- ORF2SO24.D88
- ORF2SO24.D89

Toxics 8-hour

- ORF2TX08.D85
- ORF2TX08.D86
- ORF2TX08.D87
- ORF2TX08.D88
- ORF2TX08.D89

Toxics 24-hour

- ORF2TX24.D85
- ORF2TX24.D86
- ORF2TX24.D87
- ORF2TX24.D88
- ORF2TX24.D89

## 6.0 VOC/Ozone Impact Analysis Runs

As discussed in Section 6.9.6, modeling was conducted to define the impact of VOC emissions during the off-season (the high ozone season) for the years 1985-1989, and the input data files are as follows:

- ORF2VOC.D85
- ORF2VOC.D86
- ORF2VOC.D87
- ORF2VOC.D88
- ORF2VOC.D89

# **ATTACHMENT L**

**List of Dispersion Modeling Output Files**

# U.S. SUGAR DISPERSION MODELING OUTPUT DISK DIRECTORY

---

## 1.0 Significant Impact Analysis

As discussed in Section 6.9.1, modeling was conducted to define the significant impact area for CO, NO<sub>2</sub>, PM10 and SO<sub>2</sub> for the years 1985-1989, and the output files are as follows:

### CO 1-hour/8-hour

- SIG2CO.L85
- SIG2CO.L86
- SIG2CO.L87
- SIG2CO.L88
- SIG2CO.L89

### NO<sub>2</sub> Annual

- SIG2NOAN.L85
- SIG2NOAN.L86
- SIG2NOAN.L87
- SIG2NOAN.L88
- SIG2NOAN.L89

### PM10 24-hour

- SIG2PM24.L85
- SIG2PM24.L86
- SIG2PM24.L87
- SIG2PM24.L88
- SIG2PM24.L89

### PM10 Annual

- SIG2PMAN.L85
- SIG2PMAN.L86
- SIG2PMAN.L87
- SIG2PMAN.L88
- SIG2PMAN.L89

### SO<sub>2</sub> 3-hour

- SIG2SO03.L85
- SIG2SO03.L86
- SIG2SO03.L87
- SIG2SO03.L88
- SIG2SO03.L89

### SO<sub>2</sub> 24-hour

- SIG2SO24.L85
- SIG2SO24.L86
- SIG2SO24.L87
- SIG2SO24.L88
- SIG2SO24.L89

SO<sub>2</sub> Annual

- SIG2SOAN.L85
- SIG2SOAN.L86
- SIG2SOAN.L87
- SIG2SOAN.L88
- SIG2SOAN.L89

**2.0 PSD Class I Analysis**

As discussed in Section 6.9.4, modeling was conducted to define the impact on Class I areas for NO<sub>2</sub>, PM10 and SO<sub>2</sub> for the years 1985-1989, and the output files are as follows:

**2.1 Crop Season**

NO<sub>2</sub> Annual

- CPS2NO.L85
- CPS2NO.L86
- CPS2NO.L87
- CPS2NO.L88
- CPS2NO.L89

PM10 24-hour

- CPS2PM24.L85
- CPS2PM24.L86
- CPS2PM24.L87
- CPS2PM24.L88
- CPS2PM24.L89

PM10 Annual

- CPS2PMAN.L85
- CPS2PMAN.L86
- CPS2PMAN.L87
- CPS2PMAN.L88
- CPS2PMAN.L89

SO<sub>2</sub> 3-hour

- CPS2SO03.L85
- CPS2SO03.L86
- CPS2SO03.L87
- CPS2SO03.L88
- CPS2SO03.L89

SO<sub>2</sub> 24-hour

- CPS2SO24.L85
- CPS2SO24.L86
- CPS2SO24.L87

- CPS2SO24.L88
- CPS2SO24.L89

SO<sub>2</sub> Annual

- CPS2SOAN.L85
- CPS2SOAN.L86
- CPS2SOAN.L87
- CPS2SOAN.L88
- CPS2SOAN.L89

**2.2 Off-season**

Note that the annual impact modeling was done under "crop season" above, so the off-season modeling runs were only for short-term impacts.

PM10 24-hour

- OPS2PM24.L85
- OPS2PM24.L86
- OPS2PM24.L87
- OPS2PM24.L88
- OPS2PM24.L89

SO<sub>2</sub> 3-hour

- OPS2SO03.L85
- OPS2SO03.L86
- OPS2SO03.L87
- OPS2SO03.L88
- OPS2SO03.L89

SO<sub>2</sub> 24-hour

- OPS2SO24.L85
- OPS2SO24.L86
- OPS2SO24.L87
- OPS2SO24.L88
- OPS2SO24.L89

**3.0 Preconstruction Monitoring Runs**

As discussed in Section 4, modeling was conducted to demonstrate that CO and NO<sub>2</sub> does not exceed the established *de minimus* ambient impacts, and the output files for the years 1985-1989 are as follows:

CO: Crop Season

- CPC2CO.L85
- CPC2CO.L86
- CPC2CO.L87
- CPC2CO.L88



- CPC2CO.L89

CO: Off-season

- OPC2CO.L85
- OPC2CO.L86
- OPC2CO.L87
- OPC2CO.L88
- OPC2CO.L89

NO

- CPC2NO.L85
- CPC2NO.L86
- CPC2NO.L87
- CPC2NO.L88
- CPC2NO.L89

**4.0 AAQS and PSD Class II Impact Analysis Runs**

As discussed in Section 6.9.2, modeling was conducted to define the impact on AAQS for CO, NO<sub>2</sub>, PM<sub>10</sub>, SO<sub>2</sub>, and air toxics for the years 1985-1989. The same input data files were also used for PSD Class II impact analysis for NO<sub>2</sub>, PM<sub>10</sub>/PM(TSP) and SO<sub>2</sub>, as discussed in Section 6.9.3. The output files are as follows:

**4.1 Crop Season**

CO 1-hour/8-hour

- CRF2CO.L85
- CRF2CO.L86
- CRF2CO.L87
- CRF2CO.L88
- CRF2CO.L89

NO<sub>2</sub> Annual

- CRF2NO.L85
- CRF2NO.L86
- CRF2NO.L87
- CRF2NO.L88
- CRF2NO.L89

PM<sub>10</sub> 24-hour

- CRF2PM24.L85
- CRF2PM24.L86
- CRF2PM24.L87
- CRF2PM24.L88
- CRF2PM24.L89

PM10 Annual

- CRF2PMAN.L85
- CRF2PMAN.L86
- CRF2PMAN.L87
- CRF2PMAN.L88
- CRF2PMAN.L89

SO<sub>2</sub> 3-hour

- CRF2SO03.L85
- CRF2SO03.L86
- CRF2SO03.L87
- CRF2SO03.L88
- CRF2SO03.L89

SO<sub>2</sub> 24-hour

- CRF2SO24.L85
- CRF2SO24.L86
- CRF2SO24.L87
- CRF2SO24.L88
- CRF2SO24.L89

SO<sub>2</sub> Annual

- CRF2SOAN.L85
- CRF2SOAN.L86
- CRF2SOAN.L87
- CRF2SOAN.L88
- CRF2SOAN.L89

Toxics 8-hour

- CRF2TX08.L85
- CRF2TX08.L86
- CRF2TX08.L87
- CRF2TX08.L88
- CRF2TX08.L89

Toxics 24-hour

- CRF2TX24.L85
- CRF2TX24.L86
- CRF2TX24.L87
- CRF2TX24.L88
- CRF2TX24.L89

Toxics Annual

- CRF2TXAN.L85
- CRF2TXAN.L86
- CRF2TXAN.L87
- CRF2TXAN.L88

- CRF2TXAN.L89

4.2 Off-season

CO 1-hour/8-hour

- ORF2CO.L85
- ORF2CO.L86
- ORF2CO.L87
- ORF2CO.L88
- ORF2CO.L89

PM10 24-hour

- ORF2PM24.L85
- ORF2PM24.L86
- ORF2PM24.L87
- ORF2PM24.L88
- ORF2PM24.L89

SO<sub>2</sub> 3-hour

- ORF2SO03.L85
- ORF2SO03.L86
- ORF2SO03.L87
- ORF2SO03.L88
- ORF2SO03.L89

SO<sub>2</sub> 24-hour

- ORF2SO24.L85
- ORF2SO24.L86
- ORF2SO24.L87
- ORF2SO24.L88
- ORF2SO24.L89

Toxics 8-hour

- ORF2TX08.L85
- ORF2TX08.L86
- ORF2TX08.L87
- ORF2TX08.L88
- ORF2TX08.L89

Toxics 24-hour

- ORF2TX24.L85
- ORF2TX24.L86
- ORF2TX24.L87
- ORF2TX24.L88
- ORF2TX24.L89

### 5.0 VOC/Ozone Impact Analysis Runs

As discussed in Section 6.9.6, modeling was conducted to define the impact of VOC emissions during the off-season (the high ozone season) for the years 1985-1989, and the output files are as follows:

- ORF2VOC.L85
- ORF2VOC.L86
- ORF2VOC.L87
- ORF2VOC.L88
- ORF2VOC.L89

# **ATTACHMENT M**

**GEP Stack Height Calculation Output**

## GEP Table ICF Kaiser Engineers

### Input Data

Date: 6-8-1993  
 Model: ISCST2  
 Wake Area Section Option: Maximum of all directions within sector.  
 Wake Area Shape Option: Building edge moved 2L upwind & 5L downwind.  
 Combine Structures: Combine buildings and tanks within one "L" crosswind and 5.00 "L" upwind-downwind of each other.  
 Number of Buildings: 27  
 Number of Tanks: 6  
 Number of Stacks: 16  
 Plant Rotation Angle: .000°

<b>Building No. 1</b> <b>Name: cblr</b> <b>Height: 75.00 (FT)</b>		
Corner	East (FT)	North (FT)
1	45.00	-13.00
2	111.00	-13.00
3	111.00	-91.00
4	45.00	-91.00
5	45.00	-13.00

<b>Building No. 2</b> <b>Name: ablr</b> <b>Height: 66.00 (FT)</b>		
Corner	East (FT)	North (FT)
1	177.00	15.00
2	292.00	15.00
3	292.00	-88.00
4	177.00	-88.00
5	177.00	15.00

<b>Building No. 3</b> <b>Name: bblr</b> <b>Height: 56.00 (FT)</b>		
Corner	East (FT)	North (FT)
1	45.00	-13.00
2	111.00	-13.00
3	111.00	23.00
4	177.00	23.00
5	177.00	15.00
6	292.00	15.00
7	292.00	-88.00
8	177.00	-88.00
9	177.00	-95.00
10	111.00	-95.00
11	111.00	-91.00
12	45.00	-91.00
13	45.00	13.00

<b>Building No. 4</b> <b>Name: dblr</b> <b>Height: 51.00 (FT)</b>		
Corner	East (FT)	North (FT)
1	-23.00	-13.00
2	111.00	-13.00
3	111.00	23.00
4	177.00	23.00
5	177.00	15.00
6	292.00	15.00
7	292.00	-88.00
8	177.00	-88.00
9	177.00	-95.00

Building No. 4 Name: dblr Height: 51.00 (FT)		
Corner	East (FT)	North (FT)
10	111.00	-95.00
11	111.00	-91.00
12	-23.00	-91.00
13	-23.00	-13.00

Building No. 5 Name: hse Height: 34.00 (FT)		
Corner	East (FT)	North (FT)
1	-23.00	-13.00
2	111.00	-13.00
3	111.00	23.00
4	177.00	23.00
5	177.00	15.00
6	292.00	15.00
7	292.00	-23.00
8	411.00	-23.00
9	411.00	-79.00
10	372.00	-79.00
11	372.00	-88.00
12	333.00	-88.00
13	333.00	-69.00
14	292.00	-69.00
15	292.00	-88.00
16	177.00	-88.00
17	177.00	-95.00
18	111.00	-95.00



Building No. 5 Name: hse Height: 34.00 (FT)		
Corner	East (FT)	North (FT)
19	111.00	-91.00
20	-23.00	-91.00
21	-23.00	-13.00

Building No. 6 Name: aplt Height: 51.00 (FT)		
Corner	East (FT)	North (FT)
1	-8.00	153.00
2	45.00	153.00
3	45.00	98.00
4	-8.00	98.00
5	-8.00	153.00

Building No. 7 Name: bplt Height: 34.83 (FT)		
Corner	East (FT)	North (FT)
1	-8.00	153.00
2	45.00	153.00
3	45.00	40.00
4	-8.00	40.00
5	-8.00	153.00

Building No. 8 Name: cplt Height: 22:00 (FT)		
Corner	East (FT)	North (FT)
1	-8.00	153.00
2	45.00	153.00
3	45.00	-91.00
4	-23.00	91.00
5	-23.00	40.00
6	-8.00	40.00
7	-8.00	153.00

Building No. 9 Name: carpenter Height: 24:00 (FT)		
Corner	East (FT)	North (FT)
1	74.00	159.00
2	138.00	159.00
3	138.00	103.00
4	74.00	103.00
5	74.00	159.00

Building No. 10 Name: office Height: 15:00 (FT)		
Corner	East (FT)	North (FT)
1	427.00	23.00
2	486.00	23.00
3	486.00	-57.00
4	427.00	-57.00
5	427.00	23.00

<b>Building No. 11</b> <b>Name: whse</b> <b>Height: 46.00 (FT)</b>		
Corner	East (FT)	North (FT)
1	-605.00	212.00
2	-78.00	212.00
3	-78.00	107.00
4	-605.00	107.00
5	-605.00	212.00

<b>Buildin No. 12</b> <b>Name: ship</b> <b>Height: 24.00 (FT)</b>		
Corner	East (FT)	North (FT)
1	-605.00	212.00
2	-78.00	212.00
3	-78.00	107.00
4	-180.00	107.00
5	-180.00	74.00
6	-342.00	74.00
7	-342.00	107.00
8	-605.00	107.00
9	-605.00	212.00

<b>Building No. 13</b> <b>Name: unkn</b> <b>Height: 21.00 (FT)</b>		
Corner	East (FT)	North (FT)
1	-176.00	-4.00
2	-126.00	-4.00
3	-126.00	-45.00
4	-176.00	-45.00
5	-176.00	-4.00

<b>Building No. 14</b> <b>Name: locomotive</b> <b>Height: 20.00 (FT)</b>		
Corner	East (FT)	North (FT)
1	-61.00	-351.00
2	49.00	-351.00
3	49.00	-394.00
4	-61.00	-394.00
5	-61.00	-351.00

<b>Building No. 15</b> <b>Name: shop</b> <b>Height: 39.00 (FT)</b>		
Corner	East (FT)	North (FT)
1	-164.00	-276.00
2	20.00	-276.00
3	20.00	-235.00
4	145.00	-235.00
5	145.00	-341.00
6	-164.00	-341.00
7	-164.00	-276.00

<b>Building No. 16</b> <b>Name: m-17</b> <b>Height: 37.00 (FT)</b>		
Corner	East (FT)	North (FT)
1	-20.00	-119.00
2	133.00	-119.00
3	133.00	-176.00
4	83.00	-176.00
5	83.00	-190.00
6	-20.00	-190.00
7	-20.00	-119.00

<b>Building No. 17</b> <b>Name: emill</b> <b>Height: 90.00 (FT)</b>		
Corner	East (FT)	North (FT)
1	303.00	-176.00
2	458.00	-176.00
3	458.00	-357.00
4	393.00	-357.00
5	393.00	-335.00
6	389.00	-335.00
7	389.00	-313.00
8	303.00	-313.00
9	303.00	-176.00

Building No. 18 Name: fmill Height: 85.00 (FT)		
Corner	East (FT)	North (FT)
1	315.00	-198.00
2	458.00	-198.00
3	458.00	-219.00
4	315.00	-219.00
5	315.00	-198.00

Building No. 19 Name: amill Height: 66.75 (FT)		
Corner	East (FT)	North (FT)
1	155.00	-194.00
2	236.00	-194.00
3	236.00	-372.00
4	155.00	-372.00
5	155.00	-194.00

Building No. 20 Name: imill Height: 66.67 (FT)		
Corner	East (FT)	North (FT)
1	303.00	-176.00
2	458.00	-176.00
3	458.00	-170.00
4	514.00	-170.00
5	514.00	-223.00
6	458.00	-223.00
7	458.00	-357.00

<b>Building No. 20</b> <b>Name: imill</b> <b>Height: 66.67 (FT)</b>		
Corner	East (FT)	North (FT)
8	393.00	-357.00
9	393.00	-335.00
10	389.00	-355.00
11	389.00	-313.00
12	303.00	-313.00
13	303.00	-176.00

<b>Building No. 21</b> <b>Name: bmill</b> <b>Height: 51.00 (FT)</b>		
Corner	East (FT)	North (FT)
1	155.00	-194.00
2	236.00	-194.00
3	236.00	-129.00
4	303.00	-129.00
5	303.00	-176.00
6	458.00	-176.00
7	458.00	-170.00
8	514.00	-170.00
9	514.00	-223.00
10	458.00	-223.00
11	548.00	-357.00
12	393.00	-357.00
13	393.00	-335.00
14	389.00	-335.00
15	389.00	-313.00
16	303.00	-313.00

<b>Building No. 21</b> <b>Name: bmill</b> <b>Height: 51.00 (FT)</b>		
Corner	East (FT)	North (FT)
17	303.00	-372.00
18	155.00	-372.00
19	155.00	-194.00

<b>Building No. 22</b> <b>Name: gmill</b> <b>Height: 43.00 (FT)</b>		
Corner	East (FT)	North (FT)
1	155.00	-194.00
2	236.00	-194.00
3	236.00	-129.00
4	303.00	-129.00
5	303.00	-176.00
6	458.00	-176.00
7	458.00	-170.00
8	514.00	-170.00
9	514.00	-223.00
10	458.00	-223.00
11	458.00	-357.00
12	393.00	-357.00
13	393.00	-366.00
14	303.00	-366.00
15	303.00	-372.00
16	155.00	-372.00
17	155.00	-194.00



<b>Building No. 23</b> <b>Name: hmill</b> <b>Height: 35.00 (FT)</b>		
<b>Corner</b>	<b>East (FT)</b>	<b>North (FT)</b>
1	155.00	-194.00
2	236.00	-194.00
3	236.00	-129.00
4	303.00	-129.00
5	303.00	-176.00
6	405.00	-176.00
7	405.00	-129.00
8	458.00	-129.00
9	458.00	-170.00
10	514.00	170.00
11	514.00	223.00
12	458.00	223.00
13	458.00	376.00
14	399.00	376.00
15	399.00	357.00
16	393.00	357.00
17	393.00	366.00
18	303.00	366.00
19	303.00	372.00
20	155.00	372.00
21	155.00	194.00

<b>Building No. 24</b> <b>Name: dmill</b> <b>Height: 34.00 (FT)</b>		
Corner	East (FT)	North (FT)
1	155.00	194.00
2	236.00	194.00
3	236.00	129.00
4	303.00	129.00
5	303.00	176.00
6	458.00	176.00
7	458.00	170.00
8	514.00	170.00
9	514.00	223.00
10	458.00	223.00
11	458.00	376.00
12	399.00	376.00
13	399.00	357.00
14	393.00	357.00
15	393.00	366.00
16	303.00	366.00
17	303.00	372.00
18	155.00	372.00
19	155.00	194.00

<b>Building No. 25</b> <b>Name: emill</b> <b>Height: 24.00 (FT)</b>		
Corner	East (FT)	North (FT)
1	155.00	-194.00
2	236.00	-194.00
3	236.00	-129.00

<b>Building No. 25</b> <b>Name: emill</b> <b>Height: 24.00 (FT)</b>		
Corner	East (FT)	North (FT)
4	458.00	-129.00
5	458.00	-170.00
6	514.00	-170.00
7	514.00	-223.00
8	458.00	-223.00
9	458.00	-376.00
10	399.00	-376.00
11	399.00	-357.00
12	393.00	-357.00
13	393.00	-366.00
14	303.00	-366.00
15	303.00	-372.00
16	155.00	-372.00
17	155.00	-194.00

<b>Building No. 26</b> <b>Name: pwr-mill</b> <b>Height: 56.00 (FT)</b>		
Corner	East (FT)	North (FT)
1	333.00	-88.00
2	405.00	-88.00
3	405.00	-129.00
4	333.00	-129.00
5	333.00	-88.00

Building No. 27 Name: cane dump Height: 24.00 (FT)		
Corner	East (FT)	North (FT)
1	274.00	432.00
2	378.00	432.00
3	378.00	479.00
4	274.00	479.00
5	274.00	432.00

Tank Parameters					
Tank No.	Tank Name	Height (FT)	Diameter (FT)	Center Location	
				East (FT)	North (FT)
1	w condens	30.00	53.00	221.00	128.00
2	e condens	30.00	53.00	358.00	128.00
3	fuel oil	30.00	52.00	-139.00	-163.00
4	w molasses	30.00	106.00	-444.00	-199.00
5	c molasses	32.00	91.00	-348.00	-260.00
6	e molasses	30.00	106.00	-236.00	-282.00

Stack Parameters			
Stack No.	Height (FT)	Location	
		East (FT)	North (FT)
1	75.00	273.00	.00
2	75.80	233.00	.00
3	90.00	183.00	25.00
4	150.00	77.00	.00
5	68.50	155.00	25.00
6	68.50	117.00	25.00

Stack Parameters			
Stack No.	Height (FT)	Location	
		East (FT)	North (FT)
7	150.00	.00	.00
8	150.00	136.00	25.00
9	110.00	273.00	.00
10	150.00	273.00	.00
11	110.00	233.00	.00
12	150.00	233.00	.00
13	130.00	183.00	25.00
14	150.00	183.00	25.00
15	213.25	.00	.00
16	213.25	136.00	25.00

GEP Table ICF Kaiser International						
STACK ID: 1						
Sector No.	Critical Flow Vector (deg)	GEP Stack Height (FT)	Controlling Structures			
			Name-1	Name-2	Height (FT)	Projected Width (FT)
1	15.00	166.875	emill	amill	66.750	334.863
2	25.00	166.875	emill	amill	66.750	343.498
3	28.00	166.875	emill	amill	66.750	344.057
4	35.00	166.875	emill	amill	66.750	341.696
5	50.00	187.500	cblr		75.000	102.175
6	55.00	187.500	cblr		75.000	101.750
7	65.00	187.500	cblr		75.000	98.585
8	75.00	187.500	cblr		75.000	92.424
9	89.00	187.500	cblr	emill	75.000	351.156

GEP Table ICF Kaiser International						
STACK ID 1						
Sector No.	Critical Flow Vector (deg)	GEP Stack Height (FT)	Controlling Structures			
			Name-1	Name-2	Height (FT)	Projected Width (FT)
10	95.00	187.500	cblr	emill	75.000	318.113
11	105.00	165.000	ablr	emill	66.000	333.184
12	118.00	165.000	ablr	amill	66.000	406.018
13	125.00	165.000	ablr	amill	66.000	395.592
14	135.00	165.000	ablr	amill	66.000	370.524
15	145.00	165.000	ablr	amill	66.000	334.198
16	165.00	165.000	ablr	imill	66.000	304.293
17	168.00	225.000	emill		90.000	180.097
18	184.00	225.000	emill		90.000	167.248
19	195.00	165.000	ablr	imill	66.000	387.115
20	205.00	165.000	ablr	imill	66.000	411.886
21	215.00	165.000	ablr	imill	66.000	443.552
22	225.00	165.000	ablr	emill	66.000	461.741
23	233.00	165.000	ablr	emill	66.000	466.202
24	235.00	165.000	ablr	emill	66.000	465.900
25	245.00	165.000	ablr	emill	66.000	455.902
26	255.00	165.000	ablr	emill	66.000	432.053
27	265.00	165.000	ablr	emill	66.000	395.076
28	275.00	165.000	ablr	emill	66.000	361.782
29	285.00	165.000	ablr	emill	66.000	333.184
30	305.00	225.000	emill		90.000	201.128
31	315.00	225.000	emill		90.000	206.475
32	319.000	225.000	emill		90.000	206.860
33	325.000	225.000	emill		90.000	205.549

GEP Table ICF Kaiser International						
STACK ID 1						
Sector No.	Critical Flow Vector (deg)	GEP Stack Height (FT)	Controlling Structures			
			Name-1	Name-2	Height (FT)	Projected Width (FT)
34	335.000	225.000	emill		90.000	198.377
35	345.000	225.000	emill		90.000	185.177
36	364.00	225.000	emill		90.000	167.248

GEP Table ICF Kaiser International						
STACK ID 2						
Sector No.	Critical Flow Vector (deg)	GEP Stack Height (FT)	Controlling Structures			
			Name-1	Name-2	Height (FT)	Projected Width (FT)
1	15.00	166.875	emill	amill	66.750	334.863
2	25.00	166.875	emill	amill	66.750	343.498
3	28.00	166.875	emill	amill	66.750	344.057
4	45.00	187.500	cblr		75.000	101.823
5	50.00	187.500	cblr		75.000	102.175
6	55.00	187.500	cblr		75.000	101.750
7	65.00	187.500	cblr		75.000	98.585
8	75.00	187.500	cblr		75.000	92.424
9	89.00	187.500	cblr	emill	75.000	351.156
10	95.00	187.500	cblr	emill	75.000	318.113
11	105.00	165.000	ablr	emill	66.000	333.184
12	118.00	165.000	ablr	amill	66.000	406.018
13	125.00	165.000	ablr	amill	66.000	395.592

<p style="text-align: center;"><b>GEP Table</b> <b>ICF Kaiser International</b> <b>STACK ID 2</b></p>						
Sector No.	Critical Flow Vector (deg)	GEP Stack Height (FT)	Controlling Structures			
			Name-1	Name-2	Height (FT)	Projected Width (FT)
14	135.00	165.000	ablr	amill	66.000	370.524
15	145.00	165.000	ablr	amill	66.000	334.198
16	165.00	165.000	ablr	imill	66.000	304.293
17	175.00	165.000	ablr	imill	66.000	328.571
18	185.00	165.000	ablr	imill	66.000	356.460
19	195.00	165.000	ablr	imill	66.000	387.115
20	205.00	165.000	ablr	imill	66.000	411.886
21	215.00	165.000	ablr	imill	66.000	443.552
22	223.00	187.500	cblr		75.000	101.465
23	235.00	187.500	cblr		75.000	101.750
24	235.00	187.500	cblr		75.000	101.750
25	245.00	187.500	cblr		75.000	98.585
26	255.00	187.500	cblr		75.000	92.424
27	270.00	187.500	cblr	emill	75.000	344.001
28	275.00	187.500	cblr	emill	75.000	318.114
29	285.00	165.000	ablr	emill	66.000	333.184
30	305.00	225.000	emill		90.000	201.128
31	315.00	225.000	emill		90.000	206.475
32	319.000	225.000	emill		90.000	206.860
33	325.000	225.000	emill		90.000	205.549
34	335.000	225.000	emill		90.000	198.377
35	345.000	225.000	emill		90.000	185.177
36	355.00	225.000	emill		90.000	166.351



GEP Table ICF Kaiser International						
STACK ID 3						
Sector No.	Critical Flow Vector (deg)	GEP Stack Height (FT)	Controlling Structures			
			Name-1	Name-2	Height (FT)	Projected Width (FT)
1	15.00	166.875	emill	amill	66.750	334.863
2	25.00	187.500	cblr		75.000	92.781
3	35.00	187.500	cblr		75.000	98.803
4	45.00	187.500	cblr		75.000	101.823
5	50.00	187.500	cblr		75.000	102.175
6	55.00	187.500	cblr		75.000	101.750
7	65.00	187.500	cblr		75.000	98.585
8	75.00	187.500	cblr		75.000	92.424
9	89.00	187.500	cblr	emill	75.000	351.156
10	95.00	165.000	ablr	emill	66.000	361.782
11	105.00	165.000	ablr	emill	66.000	333.184
12	118.00	165.000	ablr	amill	66.000	406.018
13	125.00	165.000	ablr	amill	66.000	395.592
14	135.00	165.000	ablr	amill	66.000	370.524
15	145.00	165.000	ablr	amill	66.000	334.198
16	165.00	165.000	ablr	imill	66.000	304.293
17	175.00	165.000	ablr	imill	66.000	328.571
18	185.00	165.000	ablr	imill	66.000	356.460
19	195.00	165.000	ablr	imill	66.000	387.115
20	205.00	187.000	cblr		75.000	92.780
21	215.00	187.500	cblr		75.000	98.803
22	225.00	187.500	cblr		75.000	101.823
23	230.00	187.500	cblr		75.000	102.175
24	235.00	187.500	cblr		75.000	101.750

GEP Table ICF Kaiser International						
STACK ID 3						
Sector No.	Critical Flow Vector (deg)	GEP Stack Height (FT)	Controlling Structures			
			Name-1	Name-2	Height (FT)	Projected Width (FT)
25	245.00	187.500	cblr		75.000	98.585
26	255.00	187.500	cblr		75.000	92.424
27	269.00	187.500	cblr	emill	75.000	351.157
28	275.00	165.000	ablr	emill	66.000	361.782
29	285.00	165.000	ablr	emill	66.000	333.184
30	305.00	225.000	emill		90.000	201.128
31	315.00	225.000	emill		90.000	206.475
32	319.000	225.000	emill		90.000	206.860
33	325.000	225.000	emill		90.000	205.549
34	335.000	225.000	emill		90.000	198.377
35	345.000	225.000	emill		90.000	185.177
36	355.00	166.875	emill	amill	66.750	318.930

GEP Table ICF Kaiser International						
STACK ID 4						
Sector No.	Critical Flow Vector (deg)	GEP Stack Height (FT)	Controlling Structures			
			Name-1	Name-2	Height (FT)	Projected Width (FT)
1	15.00	187.500	cblr		75.000	83.939
2	25.00	187.500	cblr		75.000	92.781
3	35.00	187.500	cblr		75.000	98.803
4	45.00	187.500	cblr		75.000	101.823

GEP Table ICF Kaiser International STACK ID 4						
Sector No.	Critical Flow Vector (deg)	GEP Stack Height (FT)	Controlling Structures			
			Name-1	Name-2	Height (FT)	Projected Width (FT)
5	50.00	187.500	cblr		75.000	102.175
6	55.00	187.500	cblr		75.000	101.750
7	65.00	187.500	cblr		75.000	98.585
8	75.00	187.500	cblr		75.000	92.424
9	89.00	187.500	cblr	emill	75.000	351.156
10	95.00	187.500	cblr	emill	75.000	318.113
11	105.00	187.500	cblr	emill	75.000	259.292
12	125.00	187.500	cblr	emill	75.000	201.128
13	135.00	187.500	cblr	emill	75.000	231.930
14	145.00	187.500	cblr	emill	75.000	289.555
15	155.00	187.500	cblr	emill	75.000	338.382
16	162.00	187.500	cblr	emill	75.000	366.519
17	165.00	187.500	cblr		75.000	83.939
18	175.00	183.821	cblr		75.000	72.547
19	195.00	187.500	cblr		75.000	83.939
20	205.00	187.000	cblr		75.000	92.780
21	215.00	187.500	cblr		75.000	98.803
22	225.00	187.500	cblr		75.000	101.823
23	230.00	187.500	cblr		75.000	102.175
24	235.00	187.500	cblr		75.000	101.750
25	245.00	187.500	cblr		75.000	98.585
26	255.00	187.500	cblr		75.000	92.424
27	269.00	187.500	cblr	emill	75.000	351.157
28	275.00	187.500	cblr	emill	75.000	318.114

GEP Table ICF Kaiser International						
STACK ID 4						
Sector No.	Critical Flow Vector (deg)	GEP Stack Height (FT)	Controlling Structures			
			Name-1	Name-2	Height (FT)	Projected Width (FT)
29	285.00	225.000	emill		90.000	192.316
30	305.00	225.000	emill		90.000	201.128
31	315.00	225.000	emill		90.000	206.475
32	319.000	225.000	emill		90.000	206.860
33	325.000	225.000	emill		90.000	205.549
34	335.000	187.500	cblr	amill	75.000	366.519
35	345.000	187.500	cblr		75.000	83.939
36	355.00	183.821	cblr		75.000	72.547

GEP Table ICF Kaiser International						
STACK ID 5						
Sector No.	Critical Flow Vector (deg)	GEP Stack Height (FT)	Controlling Structures			
			Name-1	Name-2	Height (FT)	Projected Width (FT)
1	15.00	187.500	cblr		75.000	83.939
2	25.00	187.500	cblr		75.000	92.781
3	35.00	187.500	cblr		75.000	98.803
4	45.00	187.500	cblr		75.000	101.823
5	50.00	187.500	cblr		75.000	102.175
6	55.00	187.500	cblr		75.000	101.750
7	65.00	187.500	cblr		75.000	98.585
8	75.00	187.500	cblr		75.000	92.424

GEP Table ICF Kaiser International						
STACK ID 5						
Sector No.	Critical Flow Vector (deg)	GEP Stack Height (FT)	Controlling Structures			
			Name-1	Name-2	Height (FT)	Projected Width (FT)
9	89.00	187.500	cblr	emill	75.000	351.156
10	95.00	165.000	ablr	emill	66.000	361.782
11	105.00	165.000	ablr	emill	66.000	333.184
12	118.00	165.000	ablr	amill	66.000	406.018
13	125.00	165.000	ablr	amill	66.000	395.592
14	135.00	165.000	ablr	amill	66.000	370.524
15	145.00	165.000	ablr	amill	66.000	334.198
16	165.00	165.000	ablr	imill	66.000	304.293
17	175.00	165.000	ablr	imill	66.000	328.571
18	185.00	183.820	cblr		75.000	72.547
19	195.00	187.500	cblr		75.000	83.939
20	205.00	187.000	cblr		75.000	92.780
21	215.00	187.500	cblr		75.000	98.803
22	225.00	187.500	cblr		75.000	101.823
23	230.00	187.500	cblr		75.000	102.175
24	235.00	187.500	cblr		75.000	101.750
25	245.00	187.500	cblr		75.000	98.585
26	255.00	187.500	cblr		75.000	92.424
27	269.00	187.500	cblr	emill	75.000	351.157
28	275.00	165.000	ablr	emill	66.000	361.782
29	285.00	165.000	ablr	emill	66.000	333.184
30	305.00	225.000	emill		90.000	201.128
31	315.00	225.000	emill		90.000	206.475
32	319.000	225.000	emill		90.000	206.860

GEP Table ICF Kaiser International						
STACK ID 5						
Sector No.	Critical Flow Vector (deg)	GEP Stack Height (FT)	Controlling Structures			
			Name-1	Name-2	Height (FT)	Projected Width (FT)
33	325.000	225.000	emill		90.000	205.549
34	335.000	225.000	emill		90.000	198.377
35	345.000	166.875	emill	amill	66.750	343.405
36	365.00	183.820	cblr		75.000	72.547

GEP Table ICF Kaiser International						
STACK ID 6						
Sector No.	Critical Flow Vector (deg)	GEP Stack Height (FT)	Controlling Structures			
			Name-1	Name-2	Height (FT)	Projected Width (FT)
1	15.00	187.500	cblr		75.000	83.939
2	25.00	187.500	cblr		75.000	92.781
3	35.00	187.500	cblr		75.000	98.803
4	45.00	187.500	cblr		75.000	101.823
5	50.00	187.500	cblr		75.000	102.175
6	55.00	187.500	cblr		75.000	101.750
7	65.00	187.500	cblr		75.000	98.585
8	75.00	187.500	cblr		75.000	92.424
9	89.00	187.500	cblr	emill	75.000	351.156
10	95.00	165.000	ablr	emill	66.000	361.782
11	112.00	187.500	cblr	emill	75.000	213.313
12	115.00	187.500	cblr	emill	75.000	192.592

GEP Table ICF Kaiser International STACK ID 6						
Sector No.	Critical Flow Vector (deg)	GEP Stack Height (FT)	Controlling Structures			
			Name-1	Name-2	Height (FT)	Projected Width (FT)
13	130.00	187.500	cblr		75.000	102.175
14	135.00	187.500	cblr		75.000	101.823
15	145.00	187.500	cblr		75.000	98.803
16	155.00	187.500	cblr		75.000	92.781
17	165.00	187.500	cblr		75.000	83.939
18	175.00	183.820	cblr		75.000	72.547
19	195.00	187.500	cblr		75.000	83.939
20	205.00	187.000	cblr		75.000	92.780
21	215.00	187.500	cblr		75.000	98.803
22	225.00	187.500	cblr		75.000	101.823
23	230.00	187.500	cblr		75.000	102.175
24	235.00	187.500	cblr		75.000	101.750
25	245.00	187.500	cblr		75.000	98.585
26	255.00	187.500	cblr		75.000	92.424
27	269.00	187.500	cblr	emill	75.000	351.157
28	275.00	165.000	ablr	emill	66.000	361.782
29	294.00	225.000	emill		90.000	191.790
30	305.00	225.000	emill		90.000	201.128
31	315.00	225.000	emill		90.000	206.475
32	319.000	225.000	emill		90.000	206.860
33	325.000	225.000	emill		90.000	205.549
34	335.000	225.000	emill		90.000	198.377
35	345.000	187.500	cblr		75.000	83.939

GEP Table ICF Kaiser International STACK ID 6						
Sector No.	Critical Flow Vector (deg)	GEP Stack Height (FT)	Controlling Structures			
			Name-1	Name-2	Height (FT)	Projected Width (FT)
36	355.00	183.821	cblr		75.000	72.547

GEP Table ICF Kaiser International STACK ID 7						
Sector No.	Critical Flow Vector (deg)	GEP Stack Height (FT)	Controlling Structures			
			Name-1	Name-2	Height (FT)	Projected Width (FT)
1	15.00	127.500	dbl	imill	51.000	573.054
2	25.00	127.500	dbl	bmill	51.000	581.315
3	35.00	127.500	dbl	emill	51.000	591.322
4	36.00	127.500	dbl	bmill	51.000	591.335
5	53.00	187.500	cblr		75.000	102.013
6	55.00	187.500	cblr		75.000	101.750
7	65.00	187.500	cblr		75.000	98.585
8	75.00	187.500	cblr		75.000	92.424
9	89.00	187.500	cblr	emill	75.000	351.156
10	95.00	187.500	cblr	emill	75.000	318.113
11	105.00	187.500	cblr	emill	75.000	259.292
12	125.00	187.500	cblr	emill	75.000	201.128
13	135.00	187.500	cblr	emill	75.000	231.930
14	145.00	187.500	cblr	emill	75.000	289.555
15	155.00	187.500	cblr	emill	75.000	338.382



<b>GEP Table</b>						
<b>ICF Kaiser International</b>						
<b>STACK ID 7</b>						
Sector No.	Critical Flow Vector (deg)	GEP Stack Height (FT)	Controlling Structures			
			Name-1	Name-2	Height (FT)	Projected Width (FT)
16	162.00	187.500	cblr	emill	75.000	366.519
17	165.00	187.500	cblr		75.000	83.939
18	185.00	127.500	dbl	imill	51.000	533.259
19	195.00	127.500	dbl	imill	51.000	573.054
20	205.00	127.500	dbl	bmill	51.000	581.314
21	215.00	127.500	dbl	emill	51.000	591.322
22	216.00	127.500	dbl	bmill	51.000	591.335
23	233.00	127.500	cblr		75.000	102.013
24	235.00	127.500	cblr		75.000	101.750
25	245.00	127.500	cblr		75.000	98.585
26	255.00	127.500	cblr		75.000	92.424
27	269.00	127.500	cblr	emill	75.000	351.157
28	275.00	127.500	cblr	emill	75.000	318.114
29	294.00	225.000	emill		90.000	191.790
30	305.00	225.000	emill		90.000	201.128
31	315.00	225.000	emill		90.000	206.475
32	319.00	225.000	emill		90.000	206.860
33	335.00	187.500	cblr	emill	75.000	338.381
34	342.00	187.500	cblr	emill	75.000	366.519
35	345.00	187.500	cblr		75.000	83.939
36	365.00	127.500	dbl	bmill	51.000	553.258

GEP Table ICF Kaiser International						
STACK ID 8						
Sector No.	Critical Flow Vector (deg)	GEP Stack Height (FT)	Controlling Structures			
			Name-1	Name-2	Height (FT)	Projected Width (FT)
1	15.00	187.500	cblr		75.000	83.939
2	25.00	187.500	cblr		75.000	92.781
3	35.00	187.500	cblr		75.000	98.803
4	45.00	187.500	cblr		75.000	101.823
5	50.00	187.500	cblr		75.000	102.175
6	55.00	187.500	cblr		75.000	101.750
7	65.00	187.500	cblr		75.000	98.585
8	75.00	187.500	cblr		75.000	92.424
9	89.00	187.500	cblr	emill	75.000	351.156
10	95.00	187.500	ablr	emill	66.000	361.782
11	105.00	165.000	ablr	emill	66.000	333.184
12	118.00	165.000	ablr	amill	66.000	406.018
13	125.00	165.000	ablr	amill	66.000	395.592
14	135.00	165.000	ablr	amill	66.000	370.524
15	145.00	165.000	cblr	amill	66.000	334.198
16	158.00	187.500	cblr		75.000	90.414
17	165.00	187.500	cblr		75.000	83.939
18	175.00	183.821	cblr		75.000	72.547
19	195.00	187.500	cblr		75.000	83.939
20	205.00	187.500	cblr		75.000	92.780
21	215.00	187.500	cblr		75.000	98.803
22	225.00	187.500	cblr		75.000	101.823
23	230.00	187.500	cblr		75.000	102.175
24	235.00	187.500	cblr		75.000	101.750

GEP Table ICF Kaiser International STACK ID-8						
Sector No.	Critical Flow Vector (deg)	GEP Stack Height (FT)	Controlling Structures			
			Name-1	Name-2	Height (FT)	Projected Width (FT)
25	245.00	187.500	cblr		75.000	98.585
26	255.00	187.500	cblr		75.000	92.424
27	269.00	187.500	cblr	emill	75.000	351.157
28	275.00	165.000	ablr	emill	66.000	361.782
29	285.00	165.000	ablr	emill	66.000	333.184
30	305.00	225.000	emill		90.000	201.128
31	315.00	225.000	emill		90.000	206.475
32	319.00	225.000	emill		90.000	206.860
33	325.00	225.000	emill		90.000	205.549
34	335.00	225.000	emill		90.000	198.377
35	345.00	187.500	cblr		75.000	83.939
36	355.00	183.821	cblr		75.000	72.547

GEP Table ICF Kaiser International STACK ID-9						
Sector No.	Critical Flow Vector (deg)	GEP Stack Height (FT)	Controlling Structures			
			Name-1	Name-2	Height (FT)	Projected Width (FT)
1	15.00	166.875	emill	amill	66.750	334.863
2	25.00	166.875	emill	amill	66.750	343.498
3	28.00	166.875	emill	amill	66.750	344.057
4	35.00	166.875	emill	amill	66.750	341.696

GEP Table ICF Kaiser International						
STACK ID 9						
Sector No.	Critical Flow Vector (deg)	GEP Stack Height (FT)	Controlling Structures			
			Name-1	Name-2	Height (FT)	Projected Width (FT)
5	50.00	187.500	cblr		75.000	102.175
6	55.00	187.500	cblr		75.000	101.750
7	65.00	187.500	cblr		75.000	98.585
8	75.00	187.500	cblr		75.000	92.424
9	89.00	187.500	cblr	emill	75.000	351.156
10	95.00	187.500	cblr	emill	75.000	318.113
11	105.00	165.000	ablr	emill	66.000	333.184
12	118.00	165.000	ablr	amill	66.000	406.018
13	125.00	165.000	ablr	amill	66.000	395.592
14	135.00	165.000	ablr	amill	66.000	370.524
15	145.00	165.000	ablr	amill	66.000	334.198
16	165.00	165.000	ablr	imill	66.000	304.293
17	168.00	225.000	emill		90.000	180.097
18	184.00	225.000	emill		90.000	167.248
19	1945.00	165.000	ablr	imill	66.000	387.115
20	205.00	165.000	ablr	imill	66.000	411.886
21	215.00	165.000	ablr	imill	66.000	443.552
22	225.00	165.000	ablr	emill	66.000	461.741
23	233.00	165.000	ablr	emill	66.000	466.202
24	235.00	165.000	ablr	emill	66.000	465.900
25	245.00	165.000	ablr	emill	66.000	455.902
26	255.00	165.000	ablr	emill	66.000	432.053
27	265.00	165.000	ablr	emill	66.000	305.076
28	275.00	165.000	ablr	emill	66.000	361.782

GEP Table ICF Kaiser International						
STACK ID 9						
Sector No.	Critical Flow Vector (deg)	GEP Stack Height (FT)	Controlling Structures			
			Name-1	Name-2	Height (FT)	Projected Width (FT)
29	285.00	165.000	ablr	emill	66.000	333.184
30	305.00	225.000	emill		90.000	201.128
31	315.00	225.000	emill		90.000	206.475
32	319.00	225.000	emill		90.000	206.860
33	325.00	225.000	emill		90.000	205.549
34	335.00	225.000	emill		90.000	198.377
35	345.00	225.000	emill		90.000	185.177
36	364.00	225.000	emill		90.000	167.248

GEP Table ICF Kaiser International						
STACK ID 10						
Sector No.	Critical Flow Vector (deg)	GEP Stack Height (FT)	Controlling Structures			
			Name-1	Name-2	Height (FT)	Projected Width (FT)
1	15.00	166.875	emill	amill	66.750	334.863
2	25.00	166.875	emill	amill	66.750	343.498
3	28.00	166.875	emill	amill	66.750	344.057
4	35.00	166.875	emill	amill	66.750	341.696
5	50.00	187.500	cbllr		75.000	102.175
6	55.00	187.500	cbllr		75.000	101.750
7	65.00	187.500	cbllr		75.000	98.585
8	75.00	187.500	cbllr		75.000	92.424

GEP Table ICF Kaiser International						
STACK ID 10						
Sector No.	Critical Flow Vector (deg)	GEP Stack Height (FT)	Controlling Structures			
			Name-1	Name-2	Height (FT)	Projected Width (FT)
9	89.00	187.500	cblr	emill	75.000	351.156
10	95.00	187.500	cblr	emill	75.000	318.113
11	105.00	165.000	ablr	emill	66.000	333.184
12	118.00	165.000	ablr	amill	66.000	406.018
13	125.00	165.000	ablr	amill	66.000	395.592
14	135.00	165.000	ablr	amill	66.000	370.524
15	145.00	165.000	ablr	amill	66.000	334.198
16	165.00	165.000	ablr	imill	66.000	304.293
17	168.00	225.000	emill		90.000	180.097
18	184.00	225.000	emill		90.000	167.248
19	195.00	165.000	ablr	imill	66.000	387.115
20	205.00	165.000	ablr	imill	66.000	411.886
21	215.00	165.000	ablr	imill	66.000	443.552
22	225.00	165.000	ablr	emill	66.000	461.741
23	233.00	165.000	ablr	emill	66.000	466.202
24	235.00	165.000	ablr	emill	66.000	465.900
25	245.00	165.000	ablr	emill	66.000	455.902
26	255.00	165.000	ablr	emill	66.000	432.053
27	265.00	165.000	ablr	emill	66.000	395.076
28	275.00	165.000	ablr	emill	66.000	361.782
29	285.00	165.000	ablr	emill	66.000	333.184
30	305.00	225.000	emill		90.000	201.128
31	345.00	225.000	emill		90.000	206.475
32	319.00	225.000	emill		90.000	206.860

GEP Table ICF Kaiser International						
STACK ID 10						
Sector No.	Critical Flow Vector (deg)	GEP Stack Height (FT)	Controlling Structures			
			Name-1	Name-2	Height (FT)	Projected Width (FT)
33	325.00	225.000	emill		90.000	205.549
34	335.00	225.000	emill		90.000	198.377
35	345.00	225.000	emill		90.000	185.177
36	365.00	225.000	emill		90.000	167.248

GEP Table ICF Kaiser International						
STACK ID 11						
Sector No.	Critical Flow Vector (deg)	GEP Stack Height (FT)	Controlling Structures			
			Name-1	Name-2	Height (FT)	Projected Width (FT)
1	15.00	166.875	emill	amill	66.750	334.863
2	25.00	166.875	emill	amill	66.750	343.498
3	28.00	187.500	emill	amill	66.750	344.057
4	45.00	187.500	cblr		75.000	101.823
5	50.00	187.500	cblr		75.000	102.175
6	55.00	187.500	cblr		75.000	101.750
7	65.00	187.500	cblr		75.000	98.585
8	75.00	187.500	cblr	emill	75.000	92.424
9	89.00	187.500	cblr	emill	75.000	351.156
10	95.00	187.500	ablr	emill	75.000	318.113
11	105.00	165.000	ablr	emill	66.000	333.184
12	118.00	165.000	ablr	amill	66.000	406.018

GEP Table ICF Kaiser International						
STACK ID: 11						
Sector No.	Critical Flow Vector (deg)	GEP Stack Height (FT)	Controlling Structures			
			Name-1	Name-2	Height (FT)	Projected Width (FT)
13	125.00	165.000	ablr	amill	66.000	395.592
14	135.00	165.000	ablr	amill	66.000	370.524
15	145.00	165.000	ablr	amill	66.000	334.198
16	165.00	165.000	ablr	imill	66.000	304.293
17	175.00	165.000	ablr	imill	66.000	328.571
18	185.00	165.000	ablr	imill	66.000	356.460
19	195.00	165.000	ablr	imill	66.000	387.115
20	205.00	165.000	ablr	imill	66.000	411.886
21	215.00	165.000	ablr	imill	66.000	443.552
22	223.00	187.500	cblr		75.000	101.465
23	235.00	187.500	cblr		75.000	101.750
24	235.00	187.500	cblr		75.000	101.750
25	245.00	187.500	cblr		75.000	98.585
26	255.000	187.500	cblr		75.000	92.424
27	270.00	187.500	cblr	emill	75.000	344.001
28	275.00	187.500	cblr	emill	75.000	318.114
29	285.00	165.000	ablr	emill	66.000	333.184
30	305.00	225.000	emill		90.000	201.128
31	315.00	225.000	emill		90.000	206.475
32	319.00	225.000	emill		90.000	206.860
33	325.00	225.000	emill		90.000	205.549



GEP Table ICF Kaiser International						
STACK ID 11						
Sector No.	Critical Flow Vector (deg)	GEP Stack Height (FT)	Controlling Structures			
			Name-1	Name-2	Height (FT)	Projected Width (FT)
34	335.00	225.000	emill		90.000	198.377
35	345.00	225.000	emill		90.000	185.177
36	355.00	225.000	emill		90.000	166.351

GEP Table ICF Kaiser International						
STACK ID 12						
Sector No.	Critical Flow Vector (deg)	GEP Stack Height (FT)	Controlling Structures			
			Name-1	Name-2	Height (FT)	Projected Width (FT)
1	15.00	166.875	emill	amill	66.750	334.863
2	25.00	166.875	emill	amill	66.750	343.498
3	28.00	166.875	emill	amill	66.750	344.057
4	45.00	187.500	cblr		75.000	101.823
5	50.00	187.500	cblr		75.000	102.175
6	55.00	187.500	cblr		75.000	101.750
7	65.00	187.500	cblr		75.000	98.585
8	75.00	187.500	cblr		75.000	92.424
9	89.00	187.500	cblr	emill	75.000	351.156
10	95.00	187.500	cblr	emill	75.000	318.113
11	105.00	165.000	ablr	emill	66.000	333.184
12	118.00	165.000	ablr	amill	66.000	406.018
13	125.00	165.000	ablr	amill	66.000	395.592

GEP Table ICF Kaiser International						
STACK ID 12						
Sector No.	Critical Flow Vector (deg)	GEP Stack Height (FT)	Controlling Structures			
			Name-1	Name-2	Height (FT)	Projected Width (FT)
14	135.00	165.000	ablr	amill	66.000	370.524
15	145.00	165.000	ablr	amill	66.000	334.198
16	165.00	165.000	ablr	imill	66.000	304.293
17	175.00	165.000	ablr	imill	66.000	328.571
18	185.00	165.000	ablr	imill	66.000	356.460
19	195.00	165.000	ablr	imill	66.000	387.115
20	205.00	165.000	ablr	imill	66.000	411.886
21	215.00	165.000	ablr	imill	66.000	443.552
22	223.00	187.500	cblr		75.000	101.465
23	235.00	187.500	cblr		75.000	101.750
24	235.00	187.500	cblr		75.000	101.750
25	245.00	187.500	cblr		75.000	98.585
26	255.00	187.500	cblr		75.000	92.424
27	270.00	187.500	cblr	emill	75.000	344.001
28	275.00	187.500	cblr	emill	75.000	318.114
29	285.00	165.000	ablr	emill	66.000	333.184
30	305.00	225.000	emill		90.000	201.128
31	315.00	225.000	emill		90.000	206.475
32	319.00	225.000	emill		90.000	206.860
33	325.00	225.000	emill		90.000	205.549
34	335.00	225.000	emill		90.000	198.377
35	345.00	225.000	emill		90.000	185.177
36	355.00	225.000	emill		90.000	166.351

<p style="text-align: center;"><b>GEP Table</b> <b>ICF Kaiser International</b></p> <p style="text-align: center;"><b>STACK ID 13</b></p>						
Sector No.	Critical Flow Vector (deg)	GEP Stack Height (FT)	Controlling Structures			
			Name-1	Name-2	Height (FT)	Projected Width (FT)
1	15.00	166.875	emill	amill	66.750	334.863
2	25.00	187.500	cblr		75.000	92.781
3	35.00	187.500	cblr		75.000	98.803
4	45.00	187.500	cblr		75.000	101.823
5	50.00	187.500	cblr		75.000	102.175
6	55.00	187.500	cblr		75.000	101.750
7	65.00	187.500	cblr		75.000	98.585
8	75.00	187.500	cblr		75.000	92.424
9	89.00	187.500	cblr		75.000	351.156
10	95.00	165.000	cblr	emill	66.000	361.782
11	105.00	165.000	ablr	emill	66.000	333.184
12	118.00	165.000	ablr	emill	66.000	406.018
13	125.00	165.000	ablr	amill	66.000	395.592
14	135.00	165.000	ablr	amill	66.000	370.524
15	145.00	165.000	ablr	amill	66.000	334.198
16	165.00	165.000	ablr	imill	66.000	304.293
17	175.00	165.000	ablr	imill	66.000	328.571
18	185.00	165.000	ablr	imill	66.000	356.460
19	195.00	165.000	ablr	imill	66.000	387.115
20	205.00	187.500	cblr		75.000	92.780
21	215.00	187.500	cblr		75.000	98.803
22	225.00	187.500	cblr		75.000	101.823
23	230.00	187.500	cblr		75.000	102.175
24	235.00	187.500	cblr		75.000	101.750

GEP Table ICF Kaiser International STACK ID 13						
Sector No.	Critical Flow Vector (deg)	GEP Stack Height (FT)	Controlling Structures			
			Name-1	Name-2	Height (FT)	Projected Width (FT)
25	245.00	187.500	cblr		75.000	98.585
26	255.00	187.500	cblr		75.000	92.424
27	269.00	187.500	cblr	emill	75.000	351.157
28	275.00	165.000	ablr	emill	66.000	361.782
29	285.00	165.000	ablr	emill	66.000	33.184
30	305.00	225.000	emill		90.000	201.128
31	315.00	225.000	emill		90.000	206.475
32	319.00	225.000	emill		90.000	206.860
33	325.00	225.000	emill		90.000	205.549
34	335.00	225.000	emill		90.000	198.377
35	345.00	225.000	emill		90.000	185.177
36	355.00	166.875	emill	amill	66.750	318.930

GEP Table ICF Kaiser International STACK ID 14						
Sector No.	Critical Flow Vector (deg)	GEP Stack Height (FT)	Controlling Structures			
			Name-1	Name-2	Height (FT)	Projected Width (FT)
1	15.00	166.875	emill	amill	66.750	334.863
2	25.00	187.500	cblr		75.000	92.781
3	35.00	187.500	cblr		75.000	98.803
4	45.00	187.500	cblr		75.000	101.823

GEP Table ICF Kaiser International STACK ID 14						
Sector No.	Critical Flow Vector (deg)	GEP Stack Height (FT)	Controlling Structures			
			Name-1	Name-2	Height (FT)	Projected Width (FT)
5	50.00	187.500	cblr		75.000	102.175
6	55.00	187.500	cblr		75.000	101.750
7	65.00	187.500	cblr		75.000	98.585
8	75.00	187.500	cblr		75.000	92.424
9	89.00	187.500	cblr	emill	75.000	351.156
10	95.00	165.000	ablr	emill	66.000	361.782
11	105.00	165.000	ablr	emill	66.000	333.184
12	118.00	165.000	ablr	amill	66.000	406.018
13	125.00	165.000	ablr	amill	66.000	395.592
14	135.00	165.000	ablr	amill	66.000	370.524
15	145.00	165.000	ablr	amill	66.000	334.198
16	165.00	165.000	ablr	imill	66.000	304.293
17	175.00	165.000	ablr	imill	66.000	328.571
18	185.00	165.000	ablr	imill	66.000	356.460
19	195.00	165.000	ablr	imill	66.000	387.115
20	205.00	187.500	cblr		75.000	92.780
21	215.00	187.500	cblr		75.000	98.803
22	225.00	187.500	cblr		75.000	101.823
23	230.00	187.500	cblr		75.000	102.175
24	235.00	187.500	cblr		75.000	01.750
25	245.00	187.500	cblr		75.000	98.585
26	255.00	187.500	cblr		75.000	92.424
27	269.00	187.500	cblr	emill	75.000	351.157
28	275.00	165.000	ablr	emill	66.000	361.782

GEP Table ICF Kaiser International						
STACK ID 14						
Sector No.	Critical Flow Vector (deg)	GEP Stack Height (FT)	Controlling Structures			
			Name-1	Name-2	Height (FT)	Projected Width (FT)
29	285.00	165.000	ablr	emill	66.000	333.184
30	305.00	225.000	emill		90.000	201.128
31	315.00	225.000	emill		90.000	206.475
32	319.00	225.000	emill		90.000	206.860
33	325.00	225.000	emill		90.000	205.549
34	335.00	225.000	emill		90.000	198.377
35	345.00	225.000	emill		90.000	185.177
36	355.00	166.875	emill	amill	66.750	318.930

GEP Table ICF Kaiser International						
STACK ID 15						
Sector No.	Critical Flow Vector (deg)	GEP Stack Height (FT)	Controlling Structures			
			Name-1	Name-2	Height (FT)	Projected Width (FT)
1	15.00	127.500	dblr	imill	51.000	573.054
2	25.00	127.500	dblr	bmill	51.000	581.315
3	35.00	127.500	dblr	emill	51.000	591.322
4	36.00	127.500	dblr	bmill	51.000	591.335
5	53.00	187.500	cblr		75.000	102.013
6	55.00	187.500	cblr		75.000	101.750
7	65.00	187.500	cblr		75.000	98.585
8	75.00	187.500	cblr		75.000	92.424

GEP Table ICF Kaiser International						
STACK ID 15						
Sector No.	Critical Flow Vector (deg)	GEP Stack Height (FT)	Controlling Structures			
			Name-1	Name-2	Height (FT)	Projected Width (FT)
9	89.00	187.500	cblr	emill	75.000	351.156
10	95.00	187.500	cblr	emill	75.000	318.113
11	105.00	187.500	cblr	emill	75.000	259.292
12	125.00	187.500	cblr	emill	75.000	201.128
13	135.00	187.500	cblr	emill	75.000	231.930
14	145.00	187.500	cblr	emill	75.000	289.555
15	155.00	187.500	cblr	emill	75.000	338.382
16	162.00	187.500	cblr	emill	75.000	366.519
17	165.00	187.500	cblr		75.000	83.939
18	185.00	127.500	dbl	imill	51.000	553.259
19	195.00	127.500	dbl	imill	51.000	573.054
20	205.00	127.500	dbl	bmill	51.000	581.314
21	215.00	127.500	dbl	emill	51.000	591.322
22	216.00	127.500	dbl	bmill	51.000	591.335
23	233.00	187.500	cblr		75.000	102.013
24	235.00	187.500	cblr		75.000	101.750
25	245.00	187.500	cblr		75.000	98.585
26	255.00	187.500	cblr		75.000	92.424
27	269.00	187.500	cblr	emill	75.000	351.157
28	275.00	187.500	emill	emill	75.000	318.114
29	294.00	225.000	emill		90.000	191.790
30	305.00	225.000	emill		90.000	201.128
31	315.00	225.000	emill		90.000	206.475
32	319.00	225.000	emill		90.000	206.860

GEP Table ICF Kaiser International						
STACK ID 15						
Sector No.	Critical Flow Vector (deg)	GEP Stack Height (FT)	Controlling Structures			
			Name-1	Name-2	Height (FT)	Projected Width (FT)
33	335.00	187.500	cblr	emill	75.000	338.381
34	342.00	187.500	cblr	emill	75.000	366.519
35	345.00	187.500	cblr		75.000	83.939
36	365.00	127.500	dblr	bmill	51.000	553.258

GEP Table ICF Kaiser International						
STACK ID 16						
Sector No.	Critical Flow Vector (deg)	GEP Stack Height (FT)	Controlling Structures			
			Name-1	Name-2	Height (FT)	Projected Width (FT)
1	15.00	187.500	cblr		75.000	83.939
2	25.00	187.500	cblr		75.000	92.781
3	35.00	187.500	cblr		75.000	98.803
4	45.00	187.500	cblr		75.000	101.823
5	50.00	187.500	cblr		75.000	102.175
6	55.00	187.500	cblr		75.000	101.750
7	65.00	187.500	cblr		75.000	98.585
8	75.00	187.500	cblr		75.000	92.424
9	89.00	187.500	cblr	emill	75.000	351.156
10	95.00	165.00	ablr	emill	66.000	361.782
11	105.00	165.00	ablr	emill	66.000	333.184
12	118.00	165.00	ablr	amill	66.000	406.018



GEP Table ICF Kaiser International						
STACK ID 16						
Sector No.	Critical Flow Vector (deg)	GEP Stack Height (FT)	Controlling Structures			
			Name-1	Name-2	Height (FT)	Projected Width (FT)
13	125.00	165.00	ablr	amill	66.000	395.592
14	135.00	165.00	ablr	amill	66.000	370.524
15	145.00	165.00	ablr	amill	66.000	334.198
16	158.00	187.500	cblr		75.000	90.414
17	165.00	187.500	cblr		75.000	83.939
18	175.00	187.500	cblr		75.000	72.547
19	195.00	187.500	cblr		75.000	83.939
20	205.00	187.500	cblr		75.000	92.780
21	215.00	187.500	cblr		75.000	98.803
22	225.00	187.500	cblr		75.000	101.823
23	230.00	187.500	cblr		75.000	102.175
24	235.00	187.500	cblr		75.000	101.750
25	245.00	187.500	cblr		75.000	98.585
26	255.00	187.500	cblr		75.000	92.424
27	269.00	187.500	cblr	emill	75.000	351.157
28	275.00	165.000	ablr	emill	66.000	361.782
29	285.00	165.000	ablr	emill	66.000	333.184
30	305.00	225.000	emill		90.000	201.128
31	315.00	225.000	emill		90.000	206.475
32	319.00	225.000	emill		90.000	206.860
33	325.00	225.000	emill		90.000	205.549
34	335.00	225.000	emill		90.000	198.377
35	345.00	187.500	cblr		75.000	83.939

<p style="text-align: center;"><b>GEP Table</b>  <b>ICF Kaiser International</b></p> <p style="text-align: center;"><b>STACK ID 16</b></p>						
Sector No.	Critical Flow Vector (deg)	GEP Stack Height (FT)	Controlling Structures			
			Name-1	Name-2	Height (FT)	Projected Width (FT)
36	355.00	183.821	cblr		75.000	72.547

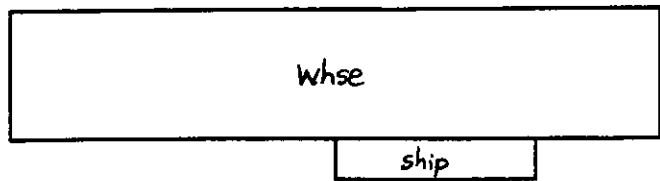

condensate tanks

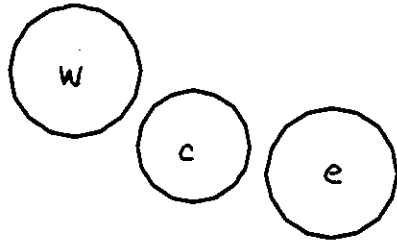
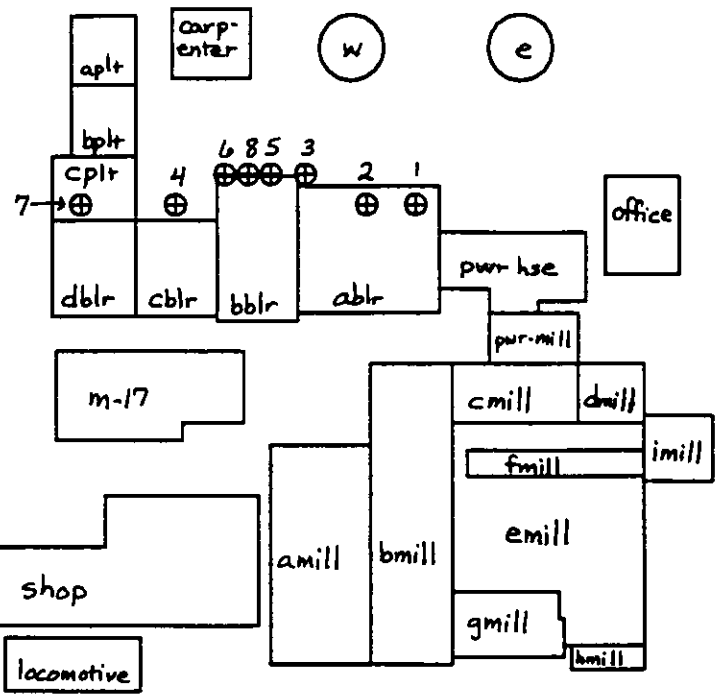
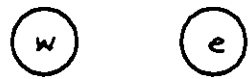

molasses tanks

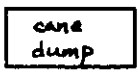

0 200.0 FT  
Scale

# **ATTACHMENT N**

**Wind Roses**

Jan - Dec ; 1984 - 1989  
January 1  
December 31  
Midnight-11 PM

NOTE: Frequencies  
indicate direction  
from which the  
wind is blowing.

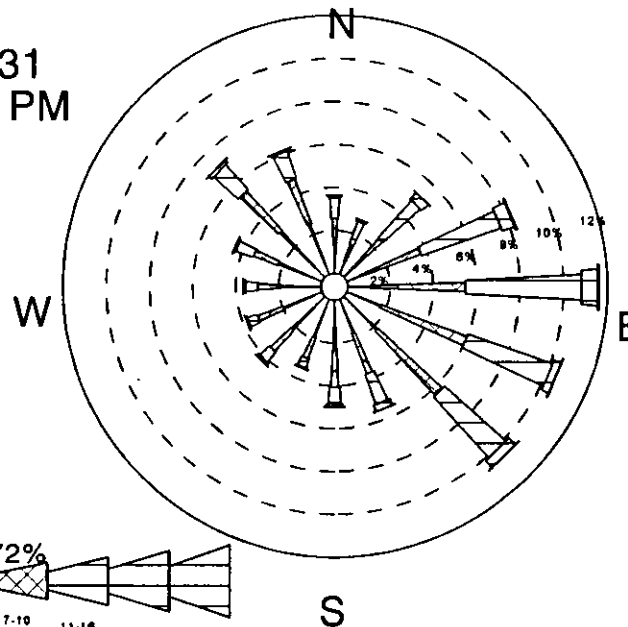
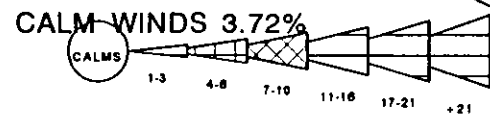

Jan. - Dec., 1984  
January 1  
December 31  
Midnight-11 PM

NOTE: Frequencies  
indicate direction  
from which the  
wind is blowing.

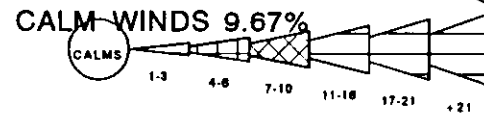
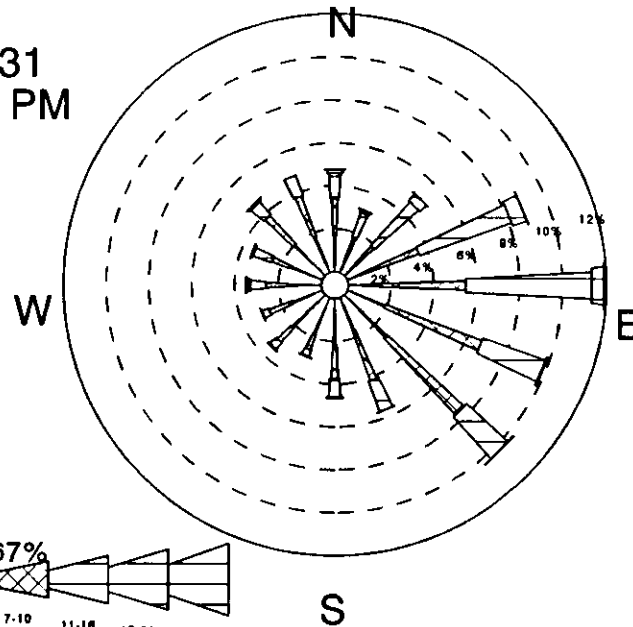

Jan - Dec ; 1985  
January 1  
December 31  
Midnight-11 PM

NOTE: Frequencies  
indicate direction  
from which the  
wind is blowing.

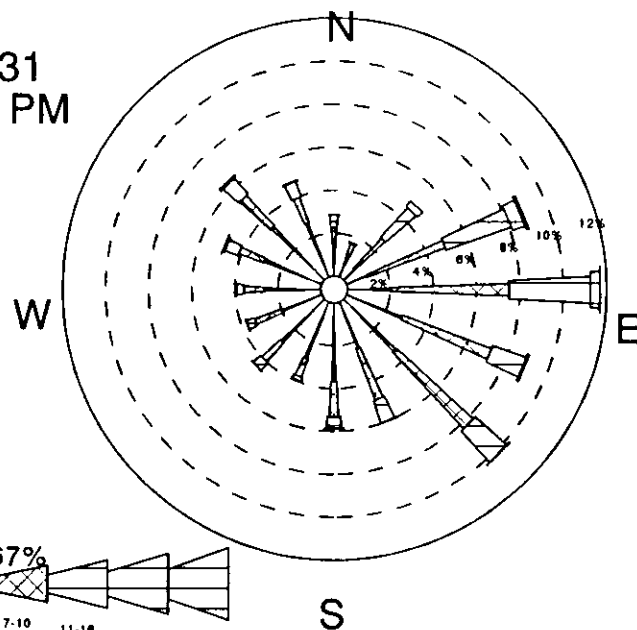
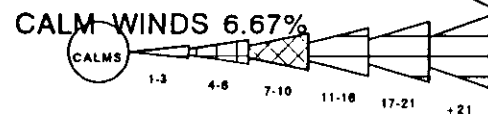

Jan - Dec ; 1986  
January 1  
December 31  
Midnight-11 PM

NOTE: Frequencies  
indicate direction  
from which the  
wind is blowing.

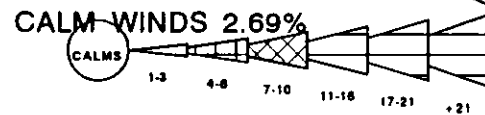
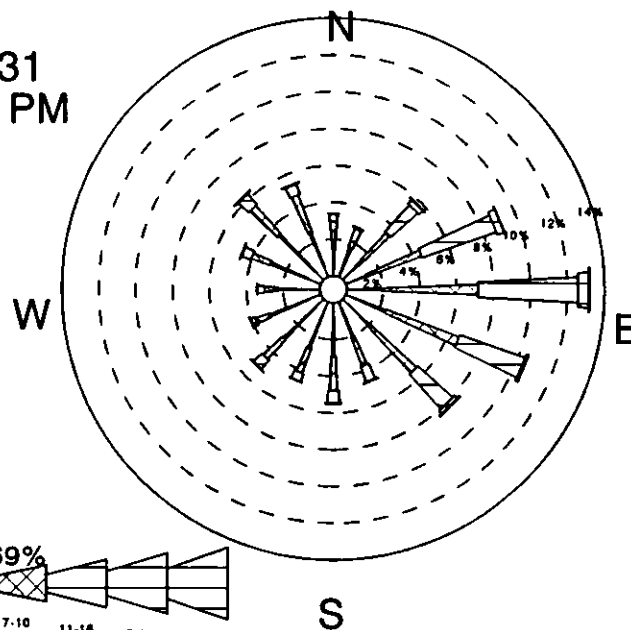



Jan - Dec ; 1987  
January 1  
December 31  
Midnight-11 PM

NOTE: Frequencies  
indicate direction  
from which the  
wind is blowing.

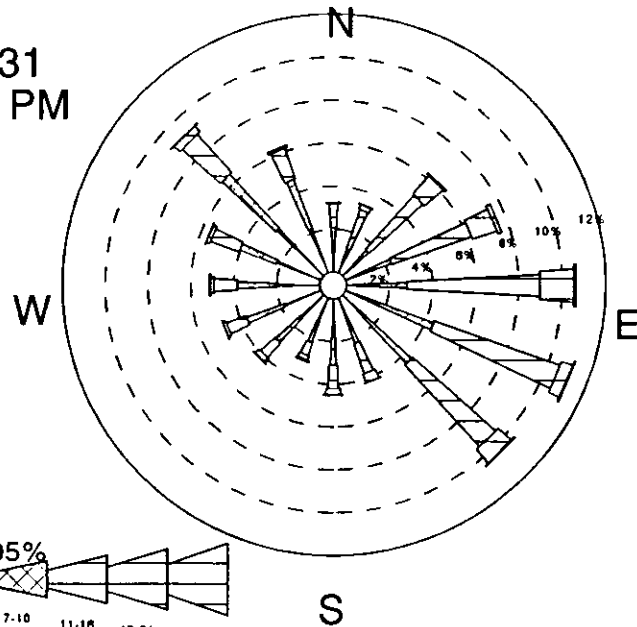
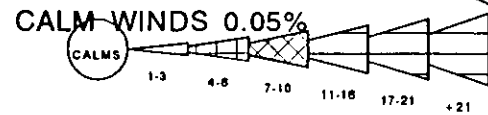

Jan - Dec ; 1988  
January 1  
December 31  
Midnight-11 PM

NOTE: Frequencies  
indicate direction  
from which the  
wind is blowing.

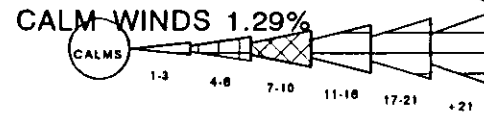
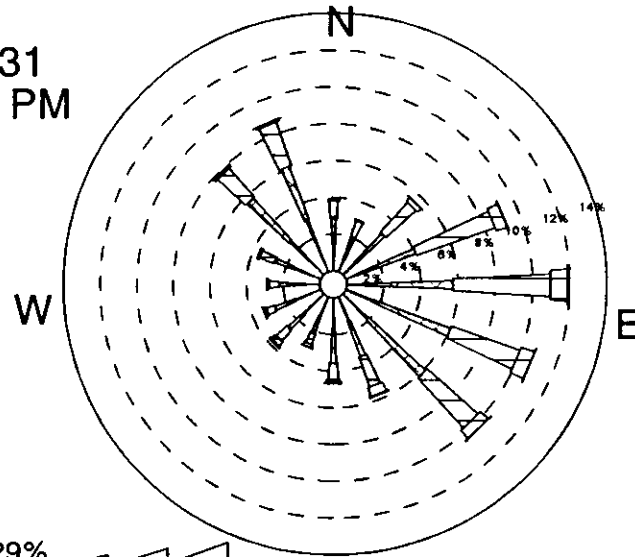

Jan - Dec ; 1989  
 January 1  
 December 31  
 Midnight-11 PM

NOTE: Frequencies  
 indicate direction  
 from which the  
 wind is blowing.

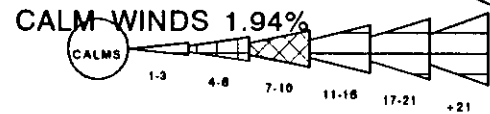
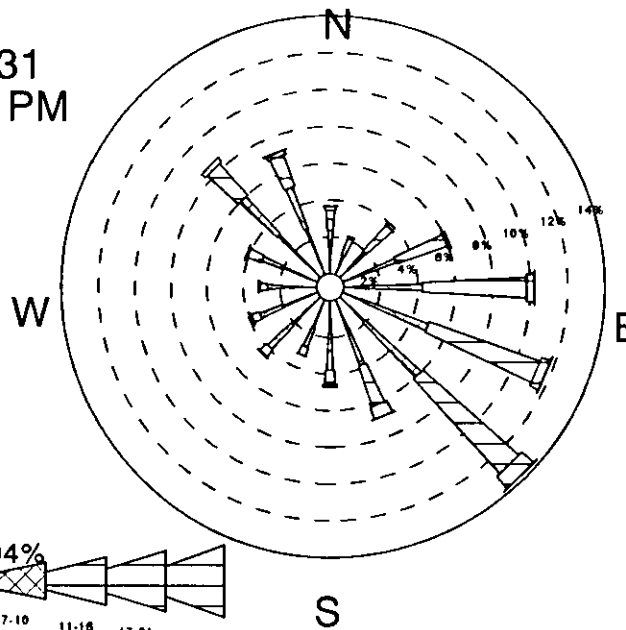

January, 1984 - 1989  
January 1  
January 31  
Midnight-11 PM

NOTE: Frequencies  
indicate direction  
from which the  
wind is blowing.

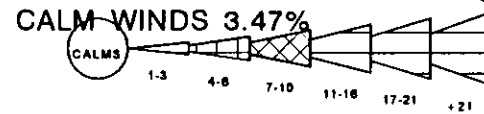
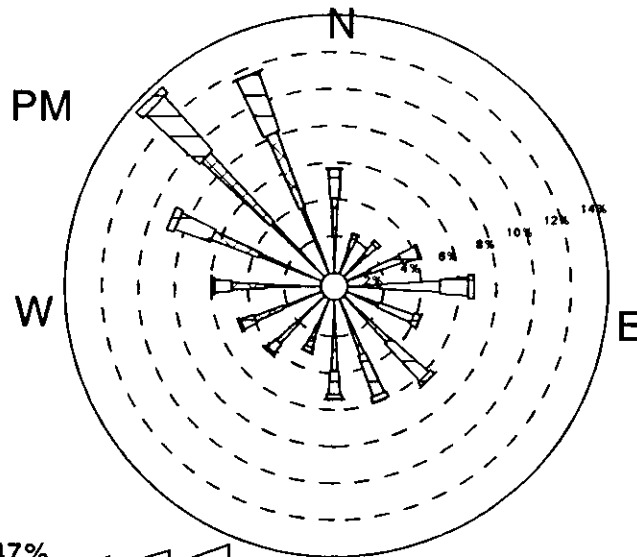

February, 1984 - 1989  
 February 1  
 February 28  
 Midnight-11 PM

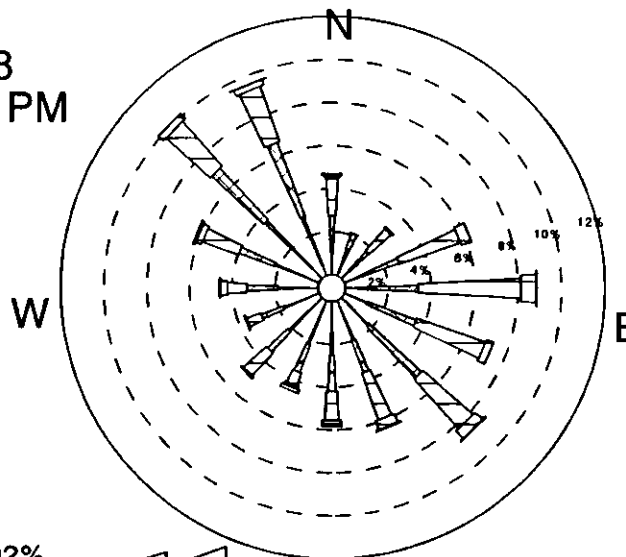

NOTE: Frequencies  
 indicate direction  
 from which the  
 wind is blowing.

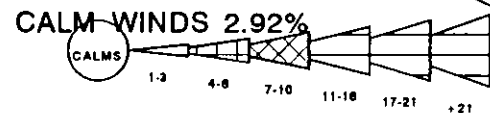

March, 1984 - 1989  
March 1  
March 31  
Midnight-11 PM

NOTE: Frequencies  
indicate direction  
from which the  
wind is blowing.

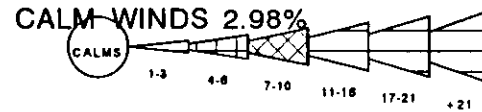
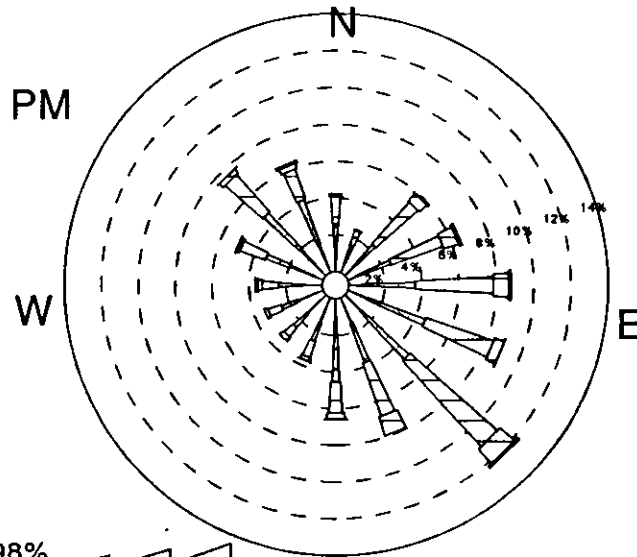

April, 1984 - 1989  
April 1  
April 30  
Midnight-11 PM

NOTE: Frequencies  
Indicate direction  
from which the  
wind is blowing.

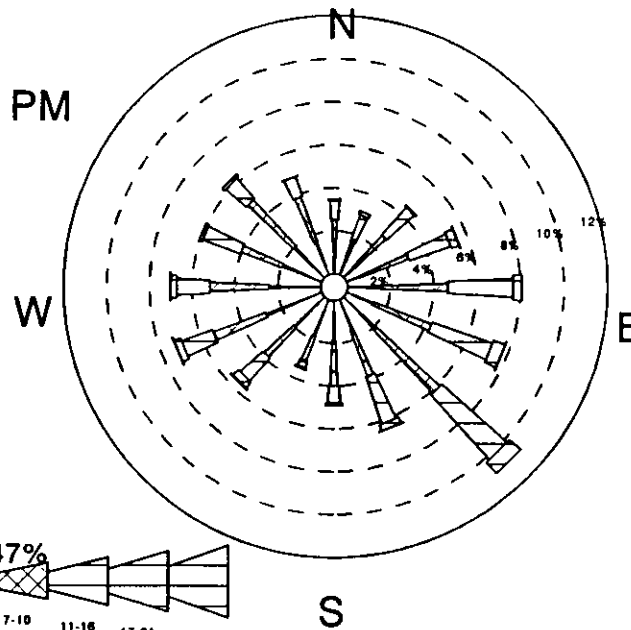
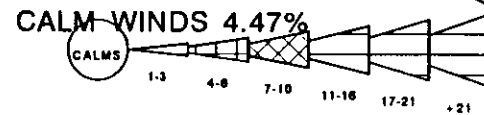

May, 1984 - 1989  
May 1  
May 31  
Midnight-11 PM

NOTE: Frequencies  
indicate direction  
from which the  
wind is blowing.

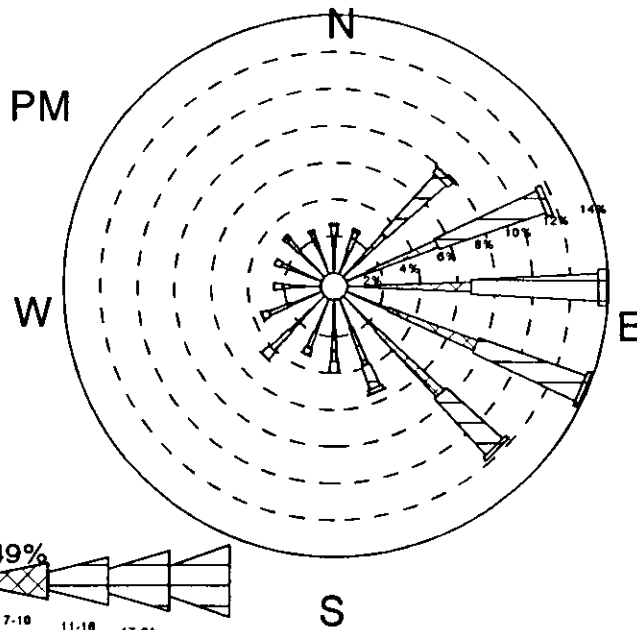
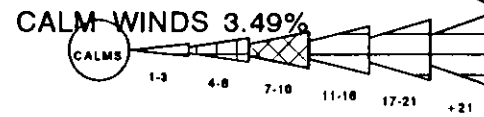



June, 1984 - 1989  
 June 1  
 June 30  
 Midnight-11 PM

NOTE: Frequencies  
 indicate direction  
 from which the  
 wind is blowing.

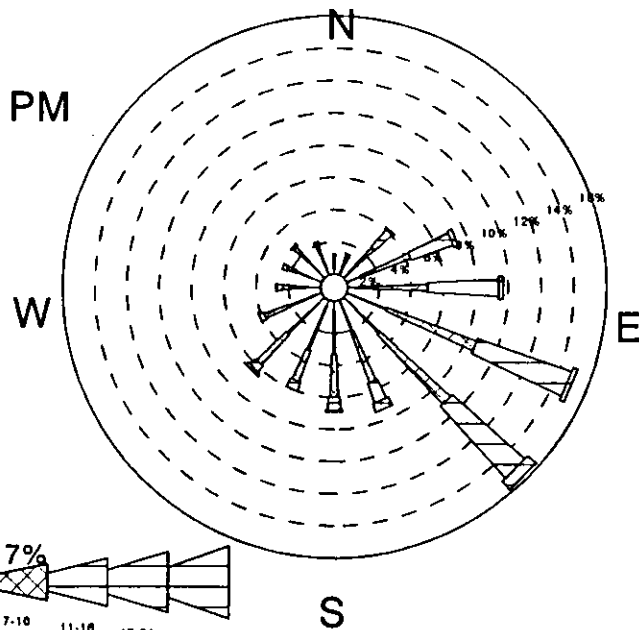
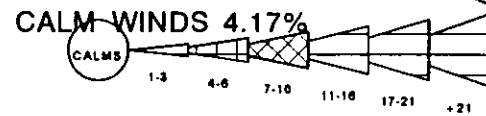

July, 1984 - 1989  
July 1  
July 31  
Midnight-11 PM

NOTE: Frequencies  
indicate direction  
from which the  
wind is blowing.

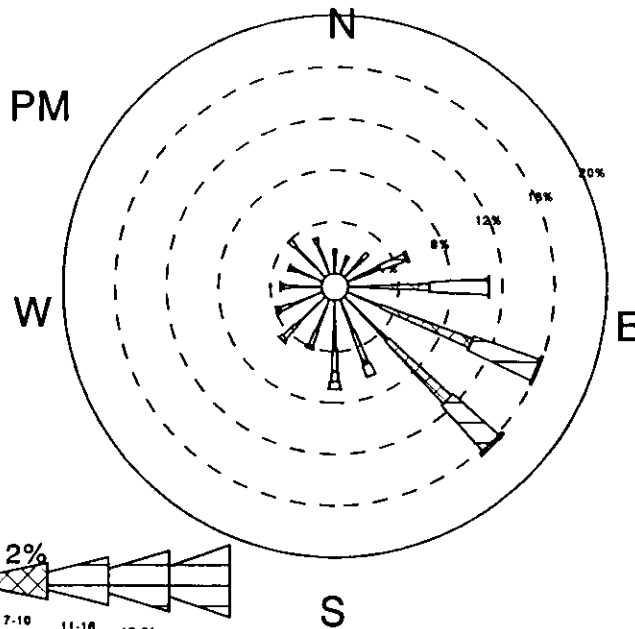
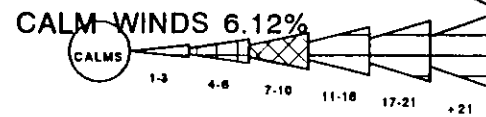

August, 1984 - 1989  
 August 1  
 August 31  
 Midnight-11 PM

NOTE: Frequencies  
 indicate direction  
 from which the  
 wind is blowing.

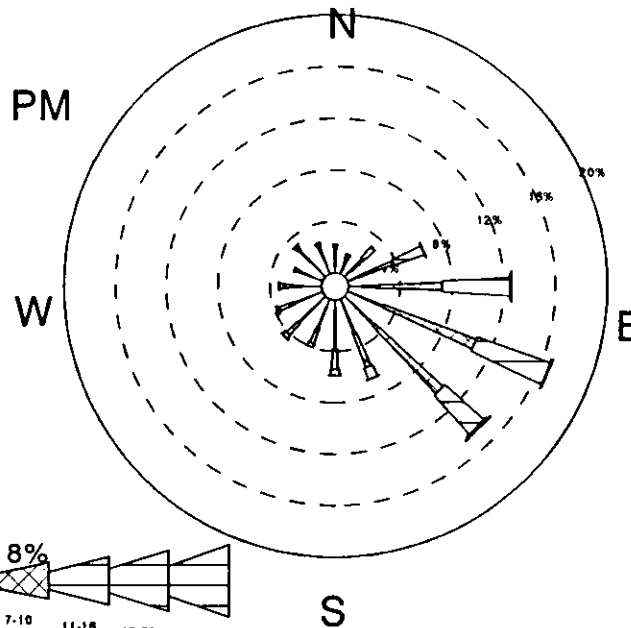
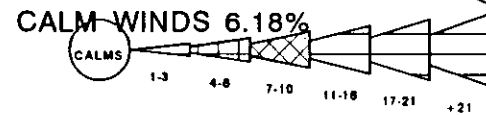

September, 1984 - 1989  
September 1  
September 30  
Midnight-11 PM

NOTE: Frequencies  
indicate direction  
from which the  
wind is blowing.

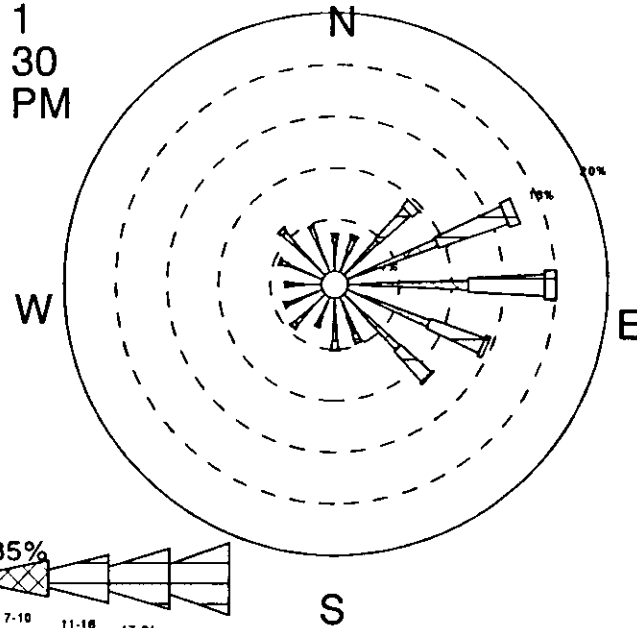
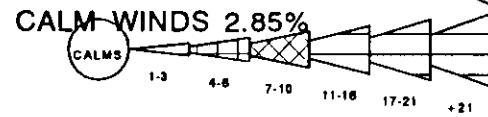

October, 1984 - 1989  
October 1  
October 31  
Midnight-11 PM

NOTE: Frequencies  
indicate direction  
from which the  
wind is blowing.

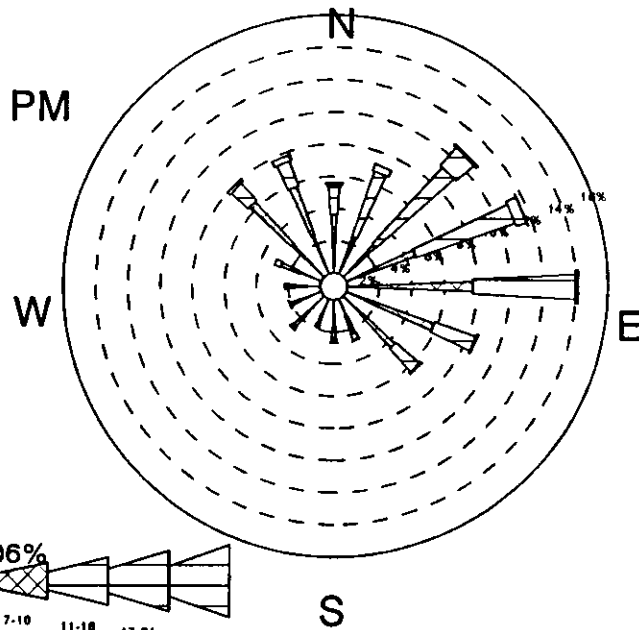
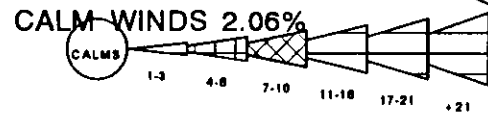

November, 1984 - 1989  
November 1  
November 30  
Midnight-11 PM

NOTE: Frequencies  
indicate direction  
from which the  
wind is blowing.

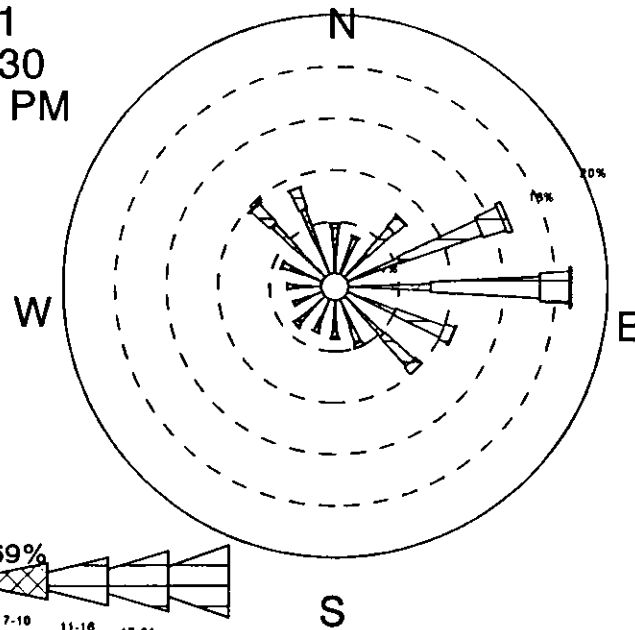
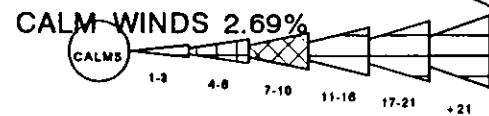

December, 1984 - 198  
December 1  
December 31  
Midnight-11 PM

NOTE: Frequencies  
indicate direction  
from which the  
wind is blowing.

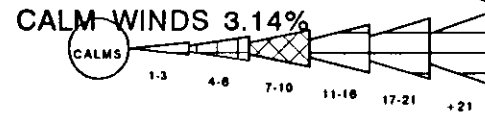
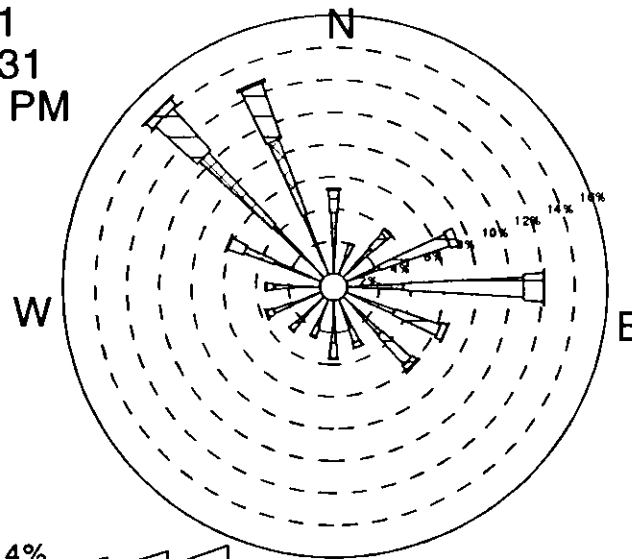

# **ATTACHMENT O**

**Diskettes of Dispersion Modeling Input Files**



## Directions for Input/Output Diskettes<sup>1</sup>

1. Create a directory on the hard drive for both Input and Output

```
C:\MKDIR "INPUT" (press enter)
C:\MKDIR "OUTPUT" (press enter)
```

2. Load diskette files you wish to use into either the Input or Output directory. At the directory prompt type the file name and press enter.

```
C:\INPUT\>"File Name" (press enter)
```

3. These files are self extracting, once you press enter the files will begin to decompress. Make sure you have enough room on your hard drive. If at any point you wish to terminate the process press Ctrl + C.

<sup>1</sup> These diskettes are formatted for MS-DOS computers.