

Check Sheet

Company Name: Monsanto ^{Chem} Company
Permit Number: AC-17-~~142980~~ 142980
PSD Number: _____
Permit Engineer: _____

Application:

- | | |
|---|--------------------------|
| <input checked="" type="checkbox"/> Initial Application | Cross References: |
| <input type="checkbox"/> Incompleteness Letters | <input type="checkbox"/> |
| <input type="checkbox"/> Responses | <input type="checkbox"/> |
| <input type="checkbox"/> Waiver of Department Action | <input type="checkbox"/> |
| <input type="checkbox"/> Department Response | |
| <input type="checkbox"/> Other | |

Intent:

- Intent to Issue
 - Notice of Intent to Issue
 - Technical Evaluation
 - BACT or LAER Determination
 - Unsigned Permit
- Correspondence with:
- EPA
 - Park Services
 - Other
- Proof of Publication
 - Petitions - (Related to extensions, hearings, etc.)
 - Waiver of Department Action
 - Other

Final

Determination:

- Final Determination
- Signed Permit
- BACT or LAER Determination
- Other

Post Permit Correspondence:

- Extensions/Amendments/Modifications
- Other

● **SENDER:** Complete items 1 and 2 when additional services are desired, and complete items 3 and 4.

Put your address in the "RETURN TO" space on the reverse side. Failure to do this will prevent this card from being returned to you. The return receipt fee will provide you the name of the person delivered to and the date of delivery. For additional fees the following services are available. Consult postmaster for fees and check box(es) for additional service(s) requested.

1. Show to whom delivered, date, and addressee's address. 2. Restricted Delivery.

3. Article Addressed to: Mr. W. J. Board Monsanto Company P.O. Box 12830 Pensacola, FL 32575		4. Article Number P 274 010 435
		Type of Service: <input type="checkbox"/> Registered <input type="checkbox"/> Insured <input checked="" type="checkbox"/> Certified <input type="checkbox"/> COD <input type="checkbox"/> Express Mail
5. Signature — Addressee X		Always obtain signature of addressee or agent and <u>DATE DELIVERED</u> .
6. Signature — Agent X <i>Deliver Favorite</i>		8. Addressee's Address (ONLY if requested and fee paid)
7. Date of Delivery MAR 16 1988		

PS Form 3811, Feb. 1986

DOMESTIC RETURN RECEIPT

P 274 010 435

RECEIPT FOR CERTIFIED MAIL

NO INSURANCE COVERAGE PROVIDED
NOT FOR INTERNATIONAL MAIL
(See Reverse)

PS Form 3800, June 1985 * U.S.G.P.O. 1985-480-794

Se Mr. W.J. Board	
Monsanto Company	
Street and No. P.O. Box 12830	
P.O., State and ZIP Code Pensacola, FL 32575	
Postage	\$
Certified Fee	
Special Delivery Fee	
Restricted Delivery Fee	
Return Receipt showing to whom and Date Delivered	
Return Receipt showing to whom, Date, and Address of Delivery	
TOTAL Postage and Fees	\$
Postmark or Date Mailed: 03/15/88 Permit: AC 17-142980	

STATE OF FLORIDA
DEPARTMENT OF ENVIRONMENTAL REGULATION

TWIN TOWERS OFFICE BUILDING
2600 BLAIR STONE ROAD
TALLAHASSEE, FLORIDA 32399-2400



BOB MARTINEZ
GOVERNOR
DALE TWACHTMANN
SECRETARY

STATE OF FLORIDA
DEPARTMENT OF ENVIRONMENTAL REGULATION
NOTICE OF PERMIT

Mr. W.J. Board
Monsanto Company
Post Office Box 12830
Pensacola, Florida 32575

March 15, 1988

Enclosed is permit No. AC 17-142980, for Monsanto Company to construct a Controlled Pyrolysis Cleaning Furnance with afterburner at the applicant's existing facility near the intersection of State Roads 292 and 297 in Pensacola, Escambia County, Florida. This permit is issued pursuant to Section 403, Florida Statutes.

Any Party to this permit has the right to seek judicial review of the permit pursuant to Section 120.68, Florida Statutes, by the filing of a Notice of Appeal pursuant to Rule 9.110, Florida Rules of Appellate Procedure, with the Clerk of the Department in the Office of General Counsel, 2600 Blair Stone Road, Tallahassee, Florida 32399-2400; and by filing a copy of the Notice of Appeal accompanied by the applicable filing fees with the appropriate District Court of Appeal. The Notice of Appeal must be filed within 30 days from the date this permit is filed with the Clerk of the Department.

Executed in Tallahassee, Florida.

STATE OF FLORIDA DEPARTMENT
OF ENVIRONMENTAL REGULATION

C. H. Fancy, P.E.
Deputy Chief
Bureau of Air Quality Management

Copy furnished to:

B. McLeod, P.E.
J. Preece, NW Dist.

Final Determination

Monsanto Company
Pensacola, Florida
Escambia County

Controlled Pyrolysis Cleaning Furnace
Permit No. AC 17-142980

Florida Department of Environmental Regulation
Bureau of Air Quality Management
Central Air Permitting

March 9, 1988

Final Determination

The Technical Evaluation and Preliminary Determination for the proposed Controlled Pyrolysis Cleaning Furnace (File No. AC 17-242980) at Monsanto Chemical Company's plant which is located in Escambia County, north of Pensacola, Florida, was distributed on December 30, 1987. Copies of the evaluation were available for public inspection at the Department's offices in Pensacola and Tallahassee. The Notice of Proposed Agency Action for this permit application was published in the Pensacola News Journal on January 13, 1988.

No comments on the Department's proposed action were submitted. The final action of the Department will be to issue the permit as proposed in the Technical Evaluation and Preliminary Determination.

STATE OF FLORIDA
DEPARTMENT OF ENVIRONMENTAL REGULATION

TWIN TOWERS OFFICE BUILDING
2600 BLAIR STONE ROAD
TALLAHASSEE, FLORIDA 32399-2400



BOB MARTINEZ
GOVERNOR

DALE TWACHTMANN
SECRETARY

PERMITTEE:
Monsanto Company
P. O. Box 12830
Pensacola, Florida 32575

Permit Number: AC 17-142980
Expiration Date: January 1, 1989
County: Escambia
Latitude/Longitude: 30° 35' 59" N
87° 14' 50" W
Project: 529B Nylon Pyrolysis
Oven

This permit is issued under the provisions of Chapter 403, Florida Statutes, and Florida Administrative Code Rule(s) 17-2 and 17-4. The above named permittee is hereby authorized to perform the work or operate the facility shown on the application and approved drawing(s), plans, and other documents attached hereto or on file with the Department and made a part hereof and specifically described as follows:

For the construction of a Model IG88 Controlled Pyrolysis Cleaning Furnace (529B Nylon Pyrolysis Oven) at the existing facility located near State Road 749, Gonzalez, Escambia County, Florida. The UTM coordinates of this site are: Zone 16, 479.96 km E and 3384.3 km N.

Construction shall be in accordance with the permit application and plan, documents, amendments, and drawings submitted, except as noted in the Preliminary Determination or the Specific Conditions.

Attachments are as follows:

1. Application to construct air pollution sources, DER Form 17-1.202(1), which was received on December 7, 1987, by FDER Bureau of Air Quality Management.

PERMITTEE:
Monsanto Company

Permit Number: AC 17-142980
Expiration Date: January 1, 1989

GENERAL CONDITIONS:

1. The terms, conditions, requirements, limitations, and restrictions set forth herein are "Permit Conditions" and as such are binding upon the permittee and enforceable pursuant to the authority of Sections 403.161, 403.727, or 403.859 through 403.861, Florida Statutes. The permittee is hereby placed on notice that the Department will review this permit periodically and may initiate enforcement action for any violation of the "Permit Conditions" by the permittee, its agents, employees, servants or representatives.

2. This permit is valid only for the specific processes and operations applied for and indicated in the approved drawings or exhibits. Any unauthorized deviation from the approved drawings, exhibits, specifications, or conditions of this permit may constitute grounds for revocation and enforcement action by the Department.

3. As provided in Subsections 403.087(6) and 403.722(5), Florida Statutes, the issuance of this permit does not convey any vested rights or any exclusive privileges. Nor does it authorize any injury to public or private property or any invasion of personal rights, nor any infringement of federal, state or local laws or regulations. This permit does not constitute a waiver of or approval of any other Department permit that may be required for other aspects of the total project which are not addressed in the permit.

4. This permit conveys no title to land or water, does not constitute state recognition or acknowledgement of title, and does not constitute authority for the use of submerged lands unless herein provided and the necessary title or leasehold interests have been obtained from the state. Only the Trustees of the Internal Improvement Trust Fund may express state opinion as to title.

5. This permit does not relieve the permittee from liability for harm or injury to human health or welfare, animal, plant or aquatic life or property and penalties therefore caused by the construction or operation of this permitted source, nor does it allow the permittee to cause pollution in contravention of Florida Statutes and Department rules, unless specifically authorized by an order from the Department.

PERMITTEE:
Monsanto Company

Permit Number: AC 17-142980
Expiration Date: January 1, 1989

GENERAL CONDITIONS:

6. The permittee shall at all times properly operate and maintain the facility and systems of treatment and control (and related appurtenances) that are installed or used by the permittee to achieve compliance with the conditions of this permit, as required by department rules. This provision includes the operation of backup or auxiliary facilities or similar systems when necessary to achieve compliance with the conditions of the permit and when required by Department rules.

7. The permittee, by accepting this permit, specifically agrees to allow authorized department personnel, upon presentation of credentials or other documents as may be required by law, access to the premises, at reasonable times, where the permitted activity is located or conducted for the purpose of:

- a. Having access to and copying any records that must be kept under the conditions of the permit;
- b. Inspecting the facility, equipment, practices, or operations regulated or required under this permit; and
- c. Sampling or monitoring any substances or parameters at any location reasonably necessary to assure compliance with this permit or Department rules.

Reasonable time may depend on the nature of the concern being investigated.

8. If, for any reason, the permittee does not comply with or will be unable to comply with any condition or limitation specified in this permit, the permittee shall immediately notify and provide the department with the following information:

- a. a description of and cause of non-compliance; and
- b. the period of noncompliance, including exact dates and times; or, if not corrected, the anticipated time the noncompliance is expected to continue, and steps being taken to reduce, eliminate, and prevent recurrence of the noncompliance.

PERMITTEE:
Monsanto Company

Permit Number: AC 17-142980
Expiration Date: January 1, 1989

GENERAL CONDITIONS:

The permittee shall be responsible for any and all damages which may result and may be subject to enforcement action by the Department for penalties or revocation of this permit.

9. In accepting this permit, the permittee understands and agrees that all records, notes, monitoring data and other information relating to the construction or operation of this permitted source, which are submitted to the Department, may be used by the department as evidence in any enforcement case arising under the Florida Statutes or Department rules, except where such use is proscribed by Sections 403.73 and 403.111, Florida Statutes.

10. The permittee agrees to comply with changes in Department rules and Florida Statutes after a reasonable time for compliance, provided however, the permittee does not waive any other rights granted by Florida Statutes or Department rules.

11. This permit is transferable only upon Department approval in accordance with Florida Administrative Code Rules 17-4.12 and 17-30.30, as applicable. The permittee shall be liable for any non-compliance of the permitted activity until the transfer is approved by the Department.

12. This permit is required to be kept at the work site of the permitted activity during the entire period of construction or operation.

13. This permit also constitutes:

- () Determination of Best Available Control Technology (BACT)
- () Determination of Prevention of Significant Deterioration (PSD)
- () Compliance with New Source Performance Standards

14. The permittee shall comply with the following monitoring and record keeping requirements:

- a. Upon request, the permittee shall furnish all records and plans required under department rules. The retention period for all records will be extended automatically, unless otherwise stipulated by the Department, during the course of any unresolved enforcement action.

PERMITTEE:
Monsanto Company

Permit Number: AC 17-142980
Expiration Date: January 1, 1989

GENERAL CONDITIONS:

- b. The permittee shall retain at the facility or other location designated by this permit records of all monitoring information (including all calibration and maintenance records and all original strip chart recordings for continuous monitoring instrumentation), copies of all reports required by this permit, and records of all data used to complete the application for this permit. The time period of retention shall be at least three years from the date of the sample, measurement, report or application unless otherwise specified by Department rule.
- c. Records of monitoring information shall include:
- the date, exact place, and time of sampling or measurements;
 - the person responsible for performing the sampling or measurements;
 - the date(s) analyses were performed;
 - the person responsible for performing the analyses;
 - the analytical techniques or methods used; and
 - the results of such analyses.

15. When requested by the Department, the permittee shall within a reasonable time furnish any information required by law which is needed to determine compliance with the permit. If the permittee becomes aware that relevant facts were not submitted or were incorrect in the permit application or in any report to the Department, such facts or information shall be submitted or corrected promptly.

SPECIFIC CONDITIONS:

1. Only nylon is to be pyrolyzed in this furnace.
2. The annual amount of nylon pyrolyzed shall not exceed 10,000 pounds.
3. Continuous operation of the nylon pyrolysis furnace is approved (8,760 hours annually).
4. Visible emissions (VE) shall not exceed 5% opacity during any 6 minute period. Compliance with this standard shall be determined by EPA Method 9, Visual Determination of the Opacity of Emissions from Stationary Sources as described in Appendix

PERMITTEE:
Monsanto Company

Permit Number: AC 17-142980
Expiration Date: January 1, 1989

SPECIFIC CONDITIONS:

A of 40 CFR 60. If the visible emissions exceed 5% opacity, a Method 5 test, Determination of Particulate Emissions from Stationary Sources, may be required by the Department. The district office shall be notified 15 days prior to any compliance test.

5. Objectionable odors from the furnace shall not be allowed off plant property.

6. Afterburner temperature must exceed 1400° F when the furnace is in operation and the initial operation temperature shall be recorded each time the unit is placed in service.

7. Construction and operation shall reasonably conform to the plans submitted in the application. The permittee shall report any delay in construction of this project to the Department's Northwest District office.

8. The permittee shall submit a complete application for a permit to operate this furnace, which must include an emissions test report, to the DER Northwest District office at least 90 days prior to the expiration date of this construction permit. The permittee may continue to operate this source, if it is in compliance with all conditions of this construction permit, until its expiration date.

9. Upon obtaining a permit to operate, the permittee will be required to submit annual operation reports to the DER Northwest District office which shall include, as a minimum, a recent visible emissions test report for visible emissions as specified in Specific Condition No. 4.

Issued this 10 day of March, 1988

STATE OF FLORIDA DEPARTMENT OF
ENVIRONMENTAL REGULATION

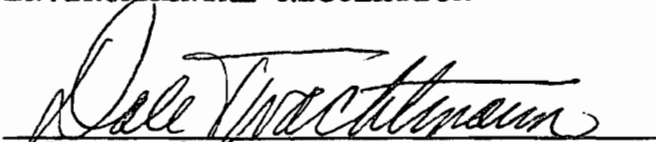
Dale Twachtman, Secretary

RECEIVED Monsanto

FEB 25 1988

DER - BAQM

MONSANTO CHEMICAL COMPANY
P. O. Box 12830
Pensacola, Florida 32575
Phone: (904) 968-7000

VIA OVERNIGHT MAIL

February 17, 1988

Mr. Clair Fancy
Department of Environmental Regulation
2600 Blair Stone Road
Tallahassee, Florida 32301

Dear Mr. Fancy:

Attached is the public notice, which was republished per DER request, for permit AC17-142980.

If you have any questions, I can be reached at 904/968-8725.

Sincerely,



Bruce P. McLeod
Senior Specialist
Environmental Control

Attachment

1082.BPM

Monsanto

MONSANTO CHEMICAL COMPANY

P. O. Box 12830

Pensacola, Florida 32575

RECEIVED
FEB 25 1988
DER-BAQM

VIA OVERNIGHT MAIL

MR CLAIR FANCY
DEPARTMENT OF ENVIRONMENTAL REGULATION
TWIN TOWERS OFFICE BUILDING
2600 BLAIR STONE ROAD
TALLAHASSEE FL 32301-8241

RECEIVED

FEB 25 1988

DER - BAQM

PENSACOLA
**News
Journal**

PUBLISHED DAILY
PENSACOLA, ESCAMBIA COUNTY, FLORIDA

State of Florida,
County of Escambia.

Before the undersigned authority personally appeared

J. Diane Deal

who on oath says that she is Legal Advertising Supervisor
of the Pensacola News Journal, a daily newspaper published at Pensacola in
Escambia County, Florida; with general circulation in Escambia, Santa
Rosa, Okaloosa and Walton Counties that the attached copy of
advertisement, being a NOTICE in the matter of

Intent

_____ in the _____ Court,

was published in said newspaper in the issues of _____

Jan. 13, 1988

Affiant further say that the said The Pensacola News
Journal is a newspaper published at Pensacola, in said Escam-
bia County, Florida, and that the said newspaper has heretofore
been continuously published in said Escambia County, Florida,
each day and has been entered as second class mail matter at
the post office in Pensacola, in said Escambia County, Florida,
for a period of one year next preceding the first publication of
the attached copy of advertisement; and affiant further says
that he has neither paid nor promised any person, firm or cor-
poration any discount, rebate, commission or refund for the
purpose of securing this advertisement for publication in the
said newspaper.

Copied: Willard Hank

J. Diane Deal



sworn to and subscribed before me this _____
day of _____, A.D., 19 88

Betty Penton
NOTARY PUBLIC.

The Department gives notice of its intent to issue a permit to construct a Controlled Pyrolysis Cleaning Furnace with afterburner at the Monsanto Company's existing facility at 3000 Old Chemstrand Road in Escambia County, Florida. A determination of Best Available Control Technology was not required. The emissions from the furnace will not have a significant impact on the ambient air quality.

Persons whose substantial interests are affected by the Department's proposed permitting decision may petition for an administrative determination (hearing) in accordance with Section 120.57, Florida Statutes. The petition must conform to the requirements of Chapter 17-103 and 28-5, Florida Administrative Code, and must be filed (received) in the Department's Office of General Counsel, 2600 Blair Stone Road, Twin Towers Office Building, Tallahassee, Florida 32399-2400, within fourteen (14) days of publication of this notice. Failure to file a petition within this time period constitutes a waiver of any right such person has to request an administrative determination (hearing) pursuant to Section 120.57, Florida Statutes.

If a petition is filed, the administrative hearing process is designed to formulate agency action. Accordingly, the Department's final action may be different from the proposed agency action. Therefore, persons who may not wish to file a petition may wish to intervene in the proceeding. A petition for intervention must be filed pursuant to Rule 28-5.207, Florida Administrative Code, at least five (5) days before the final hearing and be filed with the hearing officer if one has been assigned at the Division of Administrative Hearings, Department of Administration, 2009 Apalachee Parkway, Tallahassee, Florida 32301. If no hearing officer has been assigned, the petition is to be filed with the Department's Office of General Counsel, 2600 Blair Stone Road, Tallahassee, Florida 32399-2400. Failure to petition to intervene within the allowed time frame constitutes a waiver of any right such person has to request a hearing under Section 120.57, Florida Statutes.

The application is available for public inspection during normal business hours, 8:00 a.m. to 5:00 p.m., Monday through Friday except for legal holidays, at:

POST OFFICE TO ADDRESSEE

**EXPRESS MAIL
NEXT DAY SERVICE**



B 33761108

For Postal Use

ORIGIN	Date In: _____	Postage \$ <u>10.00</u>
Post Office: <u>SEED</u>	Time In: _____ A.M. / P.M.	Return Receipt Fee \$ _____
ZIP Code: _____	Weight: _____ lbs. _____ oz.	Total Postage & Fees \$ <u>12.75</u>
Initials of Receiving Clerk: <u>JE</u>	<input checked="" type="checkbox"/> Accepted for next day delivery. <input type="checkbox"/> Accepted for this destination after deposit deadline for next day delivery therefore, for delivery by second day. <small>(Consult your local Express Mail Next Day Service directory for deposit deadlines for different destinations.)</small>	
<input type="checkbox"/> International On Demand? Country Code: _____		

For Customer Use

Account Number: _____
(Using an authorized number indicates postage and fees paid.)
 Express Mail Corporate Account No.: _____
 Federal Agency Control No.: _____

FROM:

**B P MCEED
 MONSANTO
 P O BOX 12630
 PENSACOLA FL 32575**

DESTINATION	Date of Delivery: <u>2/25</u>	Time of Delivery: <u>13:04</u> A.M. / P.M.
<input checked="" type="checkbox"/> Signature of Addressee or Agent: <u>D. Clancy</u>		
DELIVERY WAS ATTEMPTED	Date: _____	Time: _____ A.M. / P.M.
Signature of Delivery Employee: <u>[Signature]</u>		
WAIVER OF SIGNATURE AND INDEMNITY:		I wish delivery to be made without obtaining the signature of the addressee or the addressee's agent and I authorize the delivery employee to sign that the shipment was delivered and understand that the signature of the delivery employee will constitute valid proof of delivery.
SIGNED: _____		

ADDRESSEE'S COPY

TO: Telephone Number: _____

**MR CLAIR FANCY
 DEPT OF ENVIRONMENTAL REGULATION
 TWIN TOWERS BLDG
 2600 BLAIR STONE ROAD
 TALLAHASSEE FL 32301**



Department of
Environmental Regulation
Bureau of Air
Quality Management
2600 Blair Stone Road
Tallahassee, Florida
32399-2400

Department of
Environmental Regulation
Northwest District
160 Governmental Center,
Pensacola Florida
32501-5794.

Any person may send
written comments on the
proposed action to Mr. Bill
Thomas at the Depart-
ment's Tallahassee ad-
dress. All comments
mailed within 14 days of
the publication of this no-
tice will be considered in
the Department's final de-
termination.

LEGAL NO. 33860 1T
Jan. 13, 1988

* U.S.G.P.O. 1985-480-794

PS Form 3800, June 1985

P 274 010 485

RECEIPT FOR CERTIFIED MAIL

NO INSURANCE COVERAGE PROVIDED
NOT FOR INTERNATIONAL MAIL

(See Reverse)

Send to Mr. W.J. Board Monsanto Company Street and No. P.O. Box 12830	
P.O., State and ZIP Code Pensacola, FL 32575	
Postage	S
Certified Fee	
Special Delivery Fee	
Restricted Delivery Fee	
Return Receipt showing to whom and Date Delivered	
Return Receipt showing to whom, Date, and Address of Delivery	
TOTAL Postage and Fees	S
Postmark or Date Mailed: 12-20-87 Permit: AC 17-142980	

PS Form 3811, July 1983 447-845

SENDER: Complete items 1, 2, 3 and 4.

Put your address in the "RETURN TO" space on the reverse side. Failure to do this will prevent this card from being returned to you. The return receipt fee will provide you the name of the person delivered to and the date of delivery. For additional fees the following services are available. Consult postmaster for fees and check box(es) for service(s) requested.

- Show to whom, date and address of delivery.
- Restricted Delivery.

3. Article Addressed to: Mr. W.J. Board
Monsanto Company
P.O. Box 12830
Pensacola, FL 32575

4. Type of Service:	Article Number
<input type="checkbox"/> Registered <input type="checkbox"/> Insured <input checked="" type="checkbox"/> Certified <input type="checkbox"/> COD <input type="checkbox"/> Express Mail	P 274 010 485

Always obtain signature of addressee or agent and **DATE DELIVERED.**

5. Signature - Addressee
X

6. Signature - Agent
X *Deborah Favorite*

7. Date of Delivery
12-31-87 **DEC 31 1987**

8. Addressee's Address (ONLY if requested and fee paid)

DOMESTIC RETURN RECEIPT

file copy

STATE OF FLORIDA
DEPARTMENT OF ENVIRONMENTAL REGULATION

TWIN TOWERS OFFICE BUILDING
2600 BLAIR STONE ROAD
TALLAHASSEE, FLORIDA 32399-2400



BOB MARTINEZ
GOVERNOR
DALE TWACHTMANN
SECRETARY

December 28, 1987

CERTIFIED MAIL - RETURN RECEIPT REQUESTED

Mr. W. J. Board
Monsanto Company
Post Office Box 12830
Pensacola, Florida 32575

Dear Mr. Board:

Attached is one copy of the Technical Evaluation and Preliminary Determination, and proposed permit to construct a Model IGG88 Controlled Pyrolysis Cleaning Furnace at your existing facility in Escambia County, Florida.

Please submit, in writing, any comments which you wish to have considered concerning the Department's proposed action to Mr. Bill Thomas of the Bureau of Air Quality Management.

Sincerely,

for *Ch. H. Fancy*
C. H. Fancy, P.E.
Deputy Chief
Bureau of Air Quality
Management

CHF/ks

attachments

cc: B. McLeod, P.E.
J. Preece

State of Florida
Department of Environmental Regulation
Notice of Intent

The Department gives notice of its intent to issue a permit to construct a Controlled Pyrolysis Cleaning Furnace with afterburner at the applicant's existing facility near the intersection of State Roads 292 and 297 in Escambia County, Florida. A determination of Best Available Control Technology was not required. The emissions from the furnace will not have a significant impact on the ambient air quality.

Persons whose substantial interests are affected by the Department's proposed permitting decision may petition for an administrative determination (hearing) in accordance with Section 120.57, Florida Statutes. The petition must conform to the requirements of Chapters 17-103 and 28-5, Florida Administrative Code, and must be filed (received) in the Department's Office of General Counsel, 2600 Blair Stone Road, Twin Towers Office Building, Tallahassee, Florida 32399-2400, within fourteen (14) days of publication of this notice. Failure to file a petition within this time period constitutes a waiver of any right such person has to request an administrative determination (hearing) under Section 120.57, Florida Statutes.

If a petition is filed, the administrative hearing process is designed to formulate agency action. Accordingly, the Department's final action may be different from the proposed agency action. Therefore, persons who may not wish to file a petition may wish to intervene in the proceeding. A petition for intervention must be filed pursuant to Rule 28-5.207, Florida Administrative Code, at least five (5) days before the final hearing and be filed with the hearing officer if one has been assigned at the Division of Administrative Hearings, Department of Administration, 2009, Apalachee Parkway, Tallahassee, Florida 32301. If no hearing officer has been assigned, the petition is to be filed with the Department's Office of General Counsel, 2600 Blair Stone Road, Tallahassee, Florida 32399-2400. Failure to petition to intervene within the allowed time frame constitutes a waiver of any right such person has to request a hearing under Section 120.57, Florida Statutes.

The application is available for public inspection during normal business hours, 8:00 a.m. to 5:00 p.m., Monday through Friday, except legal holidays, at:

Department of Environmental Regulation
Bureau of Air Quality Management
2600 Blair Stone Road
Tallahassee, Florida 32399-2400

Department of Environmental Regulation
Northwest District
160 Governmental Center
Pensacola, Florida 32501-5794

Any person may send written comments on the proposed action to Mr. Bill Thomas at the department's Tallahassee address. All comments mailed within 14 days of the publication of this notice will be considered in the Department's final determination.

RULES OF THE ADMINISTRATIVE COMMISSION
MODEL RULES OF PROCEDURE
CHAPTER 28-5
DECISIONS DETERMINING SUBSTANTIAL INTERESTS

28-5.15 Requests for Formal and Informal Proceedings

- (1) Requests for proceedings shall be made by petition to the agency involved. Each petition shall be printed, typewritten or otherwise duplicated in legible form on white paper of standard legal size. Unless printed, the impression shall be on one side of the paper only and lines shall be double spaced and indented.
- (2) All petitions filed under these rules should contain:
 - (a) The name and address of each agency affected and each agency's file or identification number, if known;
 - (b) The name and address of the petitioner or petitioners;
 - (c) All disputed issues of material fact. If there are none, the petition must so indicate;
 - (d) A concise statement of the ultimate facts alleged, and the rules, regulations and constitutional provisions which entitle the petitioner to relief;
 - (e) A statement summarizing any informal action taken to resolve the issues, and the results of that action;
 - (f) A demand for the relief to which the petitioner deems himself entitled; and
 - (g) Such other information which the petitioner contends is material.

BEFORE THE STATE OF FLORIDA
DEPARTMENT OF ENVIRONMENTAL REGULATION

In the Matter of
Application for Permit by:

Monsanto Company
Post Office Box 12830
Pensacola, Florida 32575

DER File No. AC 17-142980

INTENT TO ISSUE

The Department of Environmental Regulation hereby gives notice of its Intent to Issue a permit (copy attached) for the proposed project as detailed in the application specified above (copy attached). The Department is issuing this Intent to Issue for the reasons in the attached Technical Evaluation and Preliminary Determination.

The applicant, Monsanto Company, applied December 7, 1987, to the Department of Environmental Regulation for a permit to construct a Controlled Pyrolysis Cleaning Furnace at the applicant's facility in Escambia County, Florida.

The Department has permitting jurisdiction under Chapter 403, Florida Statutes and Florida Administrative Code Rules 17-2 and 17-4. The project is not exempt from permitting procedures. The Department has determined that an air construction permit was needed for the proposed work.

Pursuant to Section 403.815, F.S. and DER Rule 17-103.150, FAC, you (the applicant) are required to publish at your own expense the enclosed Notice of Proposed Agency Action on permit application. The notice must be published one time only in a section of a major local newspaper of general circulation in the county in which the project is located and within thirty (30) days from receipt of this intent. Proof of publication must be provided to the Department within seven days of publication of the notice. Failure to publish the notice and provide proof of publication within the allotted time may result in the denial of the permit.

The Department will issue the permit with the attached conditions unless a petition for an administrative proceeding (hearing) is filed pursuant to the provisions of Section 120.57, Florida Statutes. A person whose substantial interests are affected by the Department's proposed permitting decision may petition for an administrative proceeding (hearing) in accordance with Section 120.57, Florida Statutes. Petitions must comply with the requirement of Florida Administrative Code Rules 17-103.155 and 28-5.201 (copies enclosed) and be filed with (received by) the Office of General Counsel of the Department at 2600 Blair Stone Road, Tallahassee, Florida 32399-2400. Petitions filed by the permit applicant must be filed within fourteen (14) days of receipt of this intent. Petitions filed by other persons must be filed within fourteen (14) days of publication of the public notice or within fourteen (14) days of receipt of this intent, whichever first occurs. Failure to file a petition within this time period shall constitute a waiver of any right such person may have to request an administrative determination (hearing) under Section 120.57, Florida Statutes, concerning the subject permit application. Petitions which are not filed in accordance with the above provisions will be dismissed.

Executed in Tallahassee, Florida.

STATE OF FLORIDA DEPARTMENT
OF ENVIRONMENTAL REGULATION

for *W. H. Thomas*

C. H. Fancy, P.E.
Deputy Chief
Bureau of Air Quality Management

Copies furnished to:

W. J. Board
Bruce P. McLeod, P.E.
J.. Preece

CERTIFICATE OF SERVICE

The undersigned duly designated deputy clerk hereby certifies that this NOTICE OF INTENT TO ISSUE and all copies were mailed before the close of business on 12/30/87.

FILING AND ACKNOWLEDGEMENT
FILED, on this date, pursuant to
§120.52(9), Florida Statutes, with
the designated Department Clerk,
receipt of which is hereby
acknowledged.

Martha Jane Wise 12/30/87
Clerk Date

Technical Evaluation
and
Preliminary Determination

Monsanto Company
Pensacola, Florida
Escambia County

Controlled Pyrolysis Cleaning Furnace
File No. AC 17-142980

Florida Department of Environmental Regulation
Bureau of Air Quality Management
Central Air Permitting

December 28, 1987

I. Project Description

A. Applicant

Monsanto Company
P. O. Box 12830
Pensacola, Florida 32575

B. Project and Location

The company submitted an application for permit to construct a Model IGG88 Controlled Pyrolysis Cleaning Furnace (oven) equipped with an internal afterburner (incinerator) on December 7, 1987. This process equipment is also called the 529B Nylon Pyrolysis oven. The application was considered complete on receipt. Industrial source codes are: SIC 4953; SCC 5-03-001-01 and 5-03-900-06.

This furnace is to be located at the existing site of the Monsanto Fibers and Intermediates Company in Escambia County. The facility is just north of Pensacola, Florida, at the intersection of State Roads 292 and 297; UTM coordinates: Zone 16, 479.96 km E and 3384.3 km N.

C. Process

The furnace will be used to remove 10,000 lbs/yr of nylon from process equipment by melting/burning. Batch operation (100 lbs/batch) of the furnace is used whereby up to 15 lbs/hr of nylon may be removed from the process equipment. The pieces of equipment to be cleaned are placed in the furnace which operates at approximately 800-900°F. A reducing condition exists in the furnace which allows the nylon to melt rather than burn. Some of the nylon in the furnace does sublime, leaving the furnace and being destroyed by the afterburner.

The afterburner is designed to operate at approximately 1400-1500°F and receives all exhaust gases from the furnace. The afterburner operates in an oxidizing environment and burns the combustible gases from the furnace. The predominant products of the afterburner are CO₂ and water vapor. Small amounts of NO_x and particulate matter are also produced and vented to the atmosphere.

The primary furnace is not operable unless the afterburner is in operation. Both the primary furnace and afterburner are fired on natural gas.

II. Rule Applicability

A. State Regulations

The proposed project, construction of a Controlled Pyrolysis Cleaning Furnace with an afterburner, is subject to pre-construction review under the provisions of Chapter 403, Florida Statutes, and 17-2 and 17-4, Florida Administrative Code (FAC).

The facility is situated in an area designated unclassifiable for sulfur dioxide (Rule 17-2.430, FAC) and attainment for all other criteria pollutants (Rule 17-2.420, FAC).

The plant is a major source of volatile organic compounds (Rule 17-2.100, FAC) as total emissions exceed 100 TPY. The proposed source will emit less than the significant emission rate of any criteria pollutant listed in Table 500-2.

The facility is exempt from the Prevention of Significant Deterioration (PSD) regulations because the modifications to the plant will not result in a significant net emission increase of any criteria pollutant (Rule 17-2.500(2)(d)4.a.(ii), FAC).

As the area in which the facility is located is designated attainment for all criteria pollutants, it is not subject to new source review for nonattainment areas (Rule 17-2.510(2)(a)1., FAC).

However, the facility is subject to Rule 17-2.520, FAC, which pertains to sources not subject to PSD or nonattainment requirements. Control of emissions shall be based on Rule 17-2.600(1)(a), FAC, emission standards for incinerators.

III. Technical Evaluation

A. Estimated Emissions

The proposed source will operate similiary to a starved-air incinerator equipped with an afterburner.

The furnace is a two stage design with the primary chamber (oven) inoperable unless the secondary chamber (afterburner) is operating. Up to 10,000 lbs/yr of nylon on process equipment will be removed with this unit. The furnace, which is charged in the batch-feed mode, can process up to 100 pounds of nylon during one cycle. This nylon is processed at a rate up to 15 lbs/hr. The process equipment fouled with approximately 100 pounds of nylon is placed in the furnace whereby the reducing atmosphere inhibits combustion of volatiles while promoting a melt phase of the nylon. The melted nylon resin is collected below in a cooling chamber. The primary chamber (oven) is operated at 800-900°F and is fired on natural gas. The pyrolysis rate in the primary chamber is controlled by water quenching. The rate of water flow is adjusted to maintain 1400-1500°F afterburner temperature.

Smoke and a volatile fraction of the original nylon charge are produced in the oven and then routed to the secondary chamber (afterburner). The afterburner is designed to operate on natural gas at 1400-1500°F. This temperature and an oxidizing atmosphere allow for burning of the combustible products from the furnace stage. A retention time of one-half second is an operation parameter.

The effluent from the stack contains particulate matter, carbon dioxide, NOx and water vapor. This is discharged to the atmosphere via a 70 foot high, 10 inch inside diameter stack.

B. Emissions Summary

Emissions were calculated assuming a worst case scenario where all nitrogen in the nylon is converted to NOx and particulate matter is twice that actually estimated with published emission factors.

Pollutant	Summary
Particulate Matter	0.01 lbs/hr (0.01 TPY)
Nitrogen Oxides	6.2 lbs hr (2.1 TPY)*
Hydrocarbon	1.3 lbs/hr (0.5 TPY)

* Includes conversion of the nitrogen in the natural gas to NOx during combustion.

IV. Ambient Air Quality

When operated properly, the calculated emissions will not have a significant impact on the environment.

V. Conclusion

Based upon information contained in the application, the Department has concluded that the company can construct and operate this proposed furnace in compliance with all applicable air pollution control regulations. The Department proposes to issue a permit to construct the controlled pyrolysis cleaning furnace. The General and Specific Conditions listed in the proposed permit (attached) will assure compliance of the furnace with the Department's air pollution control regulations.

STATE OF FLORIDA
DEPARTMENT OF ENVIRONMENTAL REGULATION

TWIN TOWERS OFFICE BUILDING
2600 BLAIR STONE ROAD
TALLAHASSEE, FLORIDA 32399-2400



BOB MARTINEZ
GOVERNOR
DALE TWACHTMANN
SECRETARY

PERMITTEE:
Monsanto Company
P. O. Box 12830
Pensacola, Florida 32575

Permit Number: AC 17-142980
Expiration Date: January 1, 1989
County: Escambia
Latitude/Longitude: 30° 35' 59" N
87° 14' 50" W
Project: 529B Nylon Pyrolysis
Oven

This permit is issued under the provisions of Chapter 403, Florida Statutes, and Florida Administrative Code Rule(s) 17-2 and 17-4. The above named permittee is hereby authorized to perform the work or operate the facility shown on the application and approved drawing(s), plans, and other documents attached hereto or on file with the Department and made a part hereof and specifically described as follows:

For the construction of a Model IG88 Controlled Pyrolysis Cleaning Furnace (529B Nylon Pyrolysis Oven) at the existing facility located in Escambia County, north of Pensacola, Florida, at the intersection of State Roads 292 and 297. The UTM coordinates of this site are: Zone 16, 479.96 km E and 3384.3 km N.

Construction shall be in accordance with the permit application and plan, documents, amendments, and drawings submitted, except as noted in the Preliminary Determination or the Specific Conditions.

Attachments are as follows:

1. Application to construct air pollution sources, DER Form 17-1.202(1), which was received on December 7, 1987, by FDER Bureau of Air Quality Management.

PERMITTEE:
Monsanto Company

Permit Number: AC 17-142980
Expiration Date: January 1, 1989

GENERAL CONDITIONS:

1. The terms, conditions, requirements, limitations, and restrictions set forth herein are "Permit Conditions" and as such are binding upon the permittee and enforceable pursuant to the authority of Sections 403.161, 403.727, or 403.859 through 403.861, Florida Statutes. The permittee is hereby placed on notice that the Department will review this permit periodically and may initiate enforcement action for any violation of the "Permit Conditions" by the permittee, its agents, employees, servants or representatives.

2. This permit is valid only for the specific processes and operations applied for and indicated in the approved drawings or exhibits. Any unauthorized deviation from the approved drawings, exhibits, specifications, or conditions of this permit may constitute grounds for revocation and enforcement action by the Department.

3. As provided in Subsections 403.087(6) and 403.722(5), Florida Statutes, the issuance of this permit does not convey any vested rights or any exclusive privileges. Nor does it authorize any injury to public or private property or any invasion of personal rights, nor any infringement of federal, state or local laws or regulations. This permit does not constitute a waiver of or approval of any other Department permit that may be required for other aspects of the total project which are not addressed in the permit.

4. This permit conveys no title to land or water, does not constitute state recognition or acknowledgement of title, and does not constitute authority for the use of submerged lands unless herein provided and the necessary title or leasehold interests have been obtained from the state. Only the Trustees of the Internal Improvement Trust Fund may express state opinion as to title.

5. This permit does not relieve the permittee from liability for harm or injury to human health or welfare, animal, plant or aquatic life or property and penalties therefore caused by the construction or operation of this permitted source, nor does it allow the permittee to cause pollution in contravention of Florida Statutes and Department rules, unless specifically authorized by an order from the Department.

PERMITTEE:
Monsanto Company

Permit Number: AC 17-142980
Expiration Date: January 1, 1989

GENERAL CONDITIONS:

6. The permittee shall at all times properly operate and maintain the facility and systems of treatment and control (and related appurtenances) that are installed or used by the permittee to achieve compliance with the conditions of this permit, as required by department rules. This provision includes the operation of backup or auxiliary facilities or similar systems when necessary to achieve compliance with the conditions of the permit and when required by Department rules.

7. The permittee, by accepting this permit, specifically agrees to allow authorized department personnel, upon presentation of credentials or other documents as may be required by law, access to the premises, at reasonable times, where the permitted activity is located or conducted for the purpose of:

- a. Having access to and copying any records that must be kept under the conditions of the permit;
- b. Inspecting the facility, equipment, practices, or operations regulated or required under this permit; and
- c. Sampling or monitoring any substances or parameters at any location reasonably necessary to assure compliance with this permit or Department rules.

Reasonable time may depend on the nature of the concern being investigated.

8. If, for any reason, the permittee does not comply with or will be unable to comply with any condition or limitation specified in this permit, the permittee shall immediately notify and provide the department with the following information:

- a. a description of and cause of non-compliance; and
- b. the period of noncompliance, including exact dates and times; or, if not corrected, the anticipated time the noncompliance is expected to continue, and steps being taken to reduce, eliminate, and prevent recurrence of the noncompliance.

PERMITTEE:
Monsanto Company

Permit Number: AC 17-142980
Expiration Date: January 1, 1989

GENERAL CONDITIONS:

The permittee shall be responsible for any and all damages which may result and may be subject to enforcement action by the Department for penalties or revocation of this permit.

9. In accepting this permit, the permittee understands and agrees that all records, notes, monitoring data and other information relating to the construction or operation of this permitted source, which are submitted to the Department, may be used by the department as evidence in any enforcement case arising under the Florida Statutes or Department rules, except where such use is proscribed by Sections 403.73 and 403.111, Florida Statutes.

10. The permittee agrees to comply with changes in Department rules and Florida Statutes after a reasonable time for compliance, provided however, the permittee does not waive any other rights granted by Florida Statutes or Department rules.

11. This permit is transferable only upon Department approval in accordance with Florida Administrative Code Rules 17-4.12 and 17-30.30, as applicable. The permittee shall be liable for any non-compliance of the permitted activity until the transfer is approved by the Department.

12. This permit is required to be kept at the work site of the permitted activity during the entire period of construction or operation.

13. This permit also constitutes:

- () Determination of Best Available Control Technology (BACT)
- () Determination of Prevention of Significant Deterioration (PSD)
- () Compliance with New Source Performance Standards

14. The permittee shall comply with the following monitoring and record keeping requirements:

- a. Upon request, the permittee shall furnish all records and plans required under department rules. The retention period for all records will be extended automatically, unless otherwise stipulated by the Department, during the course of any unresolved enforcement action.

PERMITTEE:
Monsanto Company

Permit Number: AC 17-142980
Expiration Date: January 1, 1989

GENERAL CONDITIONS:

- b. The permittee shall retain at the facility or other location designated by this permit records of all monitoring information (including all calibration and maintenance records and all original strip chart recordings for continuous monitoring instrumentation), copies of all reports required by this permit, and records of all data used to complete the application for this permit. The time period of retention shall be at least three years from the date of the sample, measurement, report or application unless otherwise specified by Department rule.
- c. Records of monitoring information shall include:
- the date, exact place, and time of sampling or measurements;
 - the person responsible for performing the sampling or measurements;
 - the date(s) analyses were performed;
 - the person responsible for performing the analyses;
 - the analytical techniques or methods used; and
 - the results of such analyses.

15. When requested by the Department, the permittee shall within a reasonable time furnish any information required by law which is needed to determine compliance with the permit. If the permittee becomes aware that relevant facts were not submitted or were incorrect in the permit application or in any report to the Department, such facts or information shall be submitted or corrected promptly.

SPECIFIC CONDITIONS:

1. Only nylon is to be pyrolyzed in this furnace.
2. The annual amount of nylon pyrolyzed shall not exceed 10,000 pounds.
3. Continuous operation of the nylon pyrolysis furnace is approved (8,760 hours annually).
4. Visible emissions (VE) shall not exceed 5% opacity during any 6 minute period. Compliance with this standard shall be determined by EPA Method 9, Visual Determination of the Opacity of Emissions from Stationary Sources as described in Appendix

PERMITTEE:
Monsanto Company

Permit Number: AC 17-142980
Expiration Date: January 1, 1989

SPECIFIC CONDITIONS:

A of 40 CFR 60. If the visible emissions exceed 5% opacity, a Method 5 test, Determination of Particulate Emissions from Stationary Sources, may be required by the Department. The district office shall be notified 15 days prior to any compliance test.

5. Objectionable odors from the furnace shall not be allowed off plant property.

6. Afterburner temperature must exceed 1400° F when the furnace is in operation and the initial operation temperature shall be recorded each time the unit is placed in service.

7. Construction and operation shall reasonably conform to the plans submitted in the application. The permittee shall report any delay in construction of this project to the Department's Northwest District office.

8. The permittee shall submit a complete application for a permit to operate this furnace, which must include an emissions test report, to the DER Northwest District office at least 90 days prior to the expiration date of this construction permit. The permittee may continue to operate this source, if it is in compliance with all conditions of this construction permit, until its expiration date.

9. Upon obtaining a permit to operate, the permittee will be required to submit annual operation reports to the DER Northwest District office which shall include, as a minimum, a recent visible emissions test report for visible emissions as specified in Specific Condition No. 4.

Issued this _____ day of _____, 19____

STATE OF FLORIDA DEPARTMENT OF
ENVIRONMENTAL REGULATION

Dale Twachtmann, Secretary

Receipt # 117503
\$100.00
AC17-142980

Monsanto

MONSANTO CHEMICAL COMPANY
P. O. Box 12830
Pensacola, Florida 32575
Phone: (904) 968-7000

December 2, 1987

Mr. Clair Fancy
Bureau of Air Quality Management
Department of Environmental Regulation
2600 Blair Stone Road
Tallahassee, Florida 32301

Dear Mr. Fancy:

Enclosed are four copies of a construction permit application for a Nylon Pyrolysis Oven and a check for \$100.00 to cover the application fee.

I can be reached at 904/968-8725 for questions.

Sincerely,



Bruce P. McLeod
Senior Specialist
Environmental Control

Enclosures

cc: J. G. Wiley, Monsanto, Pensacola
Copied: Ed Middlemire - NW Dist. } 12-15-87 (m)
BT/CHF

RECEIVED
DER - MAIL ROOM
1987 DEC - 7 AM 7:54

001031

1009.BPM

12.15.87

~~CHF~~
~~BE~~ } FYI

Thanks,

(i)

Monsanto

WORKING FUND ACCOUNT
MONSANTO COMPANY
PENSACOLA, FLORIDA

720 09370

62 20
311

12-03-87

EXACTLY 100.00 DOLLARS

\$100.00

PAY
TO THE
ORDER
OF

DEPARTMENT OF ENVIRONMENTAL REGULATION

Citibank (Delaware)

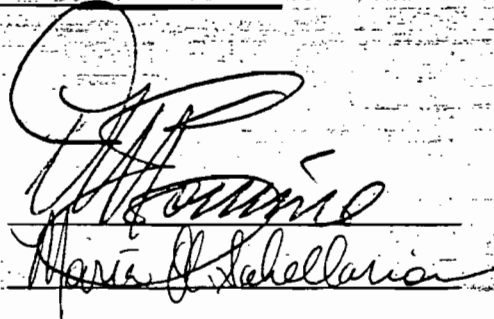

██████████ ██████████ ██████████

Mr. Clair Fancy
Bureau of Air Quality Management
Department of Environmental Regulation
2600 Blair Stone Road
Tallahassee, Florida 32301

Dear Mr. Fancy:

Enclosed are four copies of a construction permit application for a Nylon Pyrolysis Oven and a check for \$100.00 to cover the application fee.

I can be reached at 904/968-8725 for questions.

Sincerely,

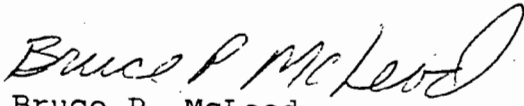

Bruce P. McLeod
Senior Specialist
Environmental Control

Enclosures

cc: J. G. Wiley, Monsanto, Pensacola

RECEIVED
DER - MAIL ROOM
1987 DEC - 7 AM 7: 54

001031

1009.BPM

DEPARTMENT OF ENVIRONMENTAL REGULATION

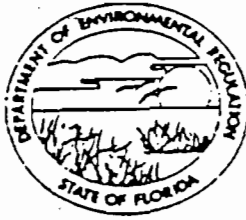

DER

DEC 07 1987

BAQM

BOB GRAHAM GOVERNOR

VICTORIA J. TSCHINKEL SECRETARY

ROBERT V. KRIEGLER DISTRICT MANAGER

NORTHWEST DISTRICT

160 GOVERNMENTAL CENTER PENSACOLA, FLORIDA 32501

APPLICATION TO OPERATE/CONSTRUCT AIR POLLUTION SOURCES

SOURCE TYPE: Construction [X] New [] Existing

APPLICATION TYPE: [X] Construction [] Operation [] Modification

COMPANY NAME: Monsanto Company COUNTY: Escambia

Identify the specific emission point source(s) addressed in this application (i.e. Lime Kiln No. 4 with Venturi Scrubber; Peaking Unit No. 2, Gas Fired) 529B-Nylon Pyrolysis oven

SOURCE LOCATION: Street Intersection State Rds 292 & 297 City

UTM: East North Latitude 30 * 35 ' 28 "N Longitude 87 * 14 ' 25 "W

APPLICANT NAME AND TITLE: W. J. Board, S.E. Dir., Governmental Affairs

APPLICANT ADDRESS: P. O. Box 12830, Pensacola FL 32575

SECTION I: STATEMENTS BY APPLICANT AND ENGINEER

A. APPLICANT

I am the undersigned owner or authorized representative* of Monsanto Company

I certify that the statements made in this application for a construction permit are true, correct and complete to the best of my knowledge and belief. Further I agree to maintain and operate the pollution control source and pollution control facilities in such a manner as to comply with the provision of Chapter 403, Florida Statutes, and all the rules and regulations of the department and revisions thereof. I also understand that a permit, if granted by the department, will be non-transferable and I will promptly notify the department upon sale or legal transfer of the permitted establishment.

*Attach letter of authorization

Signed: WJ Board W. J. Board, S.E. Dir., Gov. Affairs Name and Title (Please Type)

Date: 12/2/87 Telephone No. 904/968-7350

B. PROFESSIONAL ENGINEER REGISTERED IN FLORIDA (where required by Chapter 471, F.S.)

This is to certify that the engineering features of this pollution control project have been designed/examined by me and found to be in conformity with modern engineering principles applicable to the treatment and disposal of pollutants characterized in the permit application. There is reasonable assurance, in my professional judgment, that

1 See Florida Administrative Code Rule 17-2.100(57) and (104)

the pollution control facilities, when properly maintained and operated, will discharge an effluent that complies with all applicable statutes of the State of Florida and the rules and regulations of the department. It is also agreed that the undersigned will furnish, if authorized by the owner, the applicant a set of instructions for the proper maintenance and operation of the pollution control facilities and, if applicable, pollution sources.

Signed Bruce P. McLeod P.E.
Bruce P. McLeod, P.E.

Name (Please Type)
Monsanto Company

Company Name (Please Type)
P. O. Box 18230, Pensacola, FL 32575

Mailing Address (Please Type)
Florida Registration No. 26956 Date: 12/2/87 Telephone No. 904/968-8725

SECTION II: GENERAL PROJECT INFORMATION

Describe the nature and extent of the project. Refer to pollution control equipment, and expected improvements in source performance as a result of installation. State whether the project will result in full compliance. Attach additional sheet if necessary.

Purchase and install a nylon pyrolysis oven with integral afterburner. Unit will be a Pollution Control Products Co. unit IGG 88 (see attached brochure).

Schedule of project covered in this application (Construction Permit Application Only)

Start of Construction _____ Completion of Construction _____

Costs of pollution control system(s): (Note: Show breakdown of estimated costs only for individual components/units of the project serving pollution control purposes. Information on actual costs shall be furnished with the application for operation permit.)

No separate pollution control systems. Afterburner is integral to the pyrolysis unit.

Indicate any previous DER permits, orders and notices associated with the emission point, including permit issuance and expiration dates.

Identical to Permit AC17-127872.

E. Requested permitted equipment operating time: hrs/day 24 ; days/wk 7 ; wks/yr 52 ;
if power plant, hrs/yr _____ ; if seasonal, describe: _____

F. If this is a new source or major modification, answer the following questions.
(Yes or No)

1. Is this source in a non-attainment area for a particular pollutant? No
a. If yes, has "offset" been applied? _____
b. If yes, has "Lowest Achievable Emission Rate" been applied? _____
c. If yes, list non-attainment pollutants. _____
2. Does best available control technology (BACT) apply to this source? No
If yes, see Section VI.
3. Does the State "Prevention of Significant Deterioration" (PSD)
requirement apply to this source? If yes, see Sections VI and VII. No
4. Do "Standards of Performance for New Stationary Sources" (NSPS)
apply to this source? No
5. Do "National Emission Standards for Hazardous Air Pollutants"
(NESHAP) apply to this source? No
- H. Do "Reasonably Available Control Technology" (RACT) requirements apply
to this source? No
a. If yes, for what pollutants? _____
b. If yes, in addition to the information required in this form,
any information requested in Rule 17-2.650 must be submitted.

Attach all supportive information related to any answer of "Yes". Attach any justifi-
cation for any answer of "No" that might be considered questionable.

BEST AVAILABLE COPY

SECTION III: AIR POLLUTION SOURCES & CONTROL DEVICES (Other than Incinerators)

Raw Materials and Chemicals Used in your Process, if applicable:

Description	Contaminants		Utilization Rate - lbs/hr	Relate to Flow Diagram
	Type	% Wt		
Nylon	N/A		15	

Process Rate, if applicable: (See Section V, Item 1)

1. Total Process Input Rate (lbs/hr): _____
2. Product Weight (lbs/hr): _____

Airborne Contaminants Emitted: (Information in this table must be submitted for each emission point, use additional sheets as necessary)

Name of Contaminant	Emission ¹		Allowed Emission Rate per Rule 17-2	Allowable ³ Emission lbs/hr	Potential ⁴ Emission		Relate to Flow Diagram
	Maximum lbs/hr	Actual T/yr			lbs/yr	T/yr	
NOx	6.15 ^(a)	2.1	N/A	N/A	6.15	2.1	
Particulates	0.005 ^(c)	0.01	N/A	N/A	0.005	0.01	
Opacity	5% or less		5% or less	5% or less	N/A		

See Section V, Item 2.

Reference applicable emission standards and units (e.g. Rule 17-2.600(5)(b)2. Table II, E. (1) - 0.1 pounds per million BTU heat input)

Calculated from operating rate and applicable standard.

Emission, if source operated without control (See Section V, Item 3).

- (a) See calculation #1
- (b) 17-2.600(1) (a)
- (c) See calculation #2
- (d) Control device integral to the process so actual = potential emissions.

D. Control Devices: (See Section V, Item 4)

Name and Type (Model & Serial No.)	Contaminant	Efficiency	Range of Particles Size Collected (in microns) (If applicable)	Basis for Efficiency (Section V Item 5)
See supplements 1 and 2				

E. Fuels

Type (Be Specific)	Consumption*		Maximum Heat Input (MMBTU/hr)
	avg/hr	max./hr	
See Section IV			

*Units: Natural Gas--MMCF/hr; Fuel Oils--gallons/hr; Coal, wood, refuse, other--lbs/hr.

Fuel Analysis:

Percent Sulfur: _____ Percent Ash: _____

Density: _____ lbs/gal Typical Percent Nitrogen: _____

Heat Capacity: _____ BTU/lb _____ BTU/gal

Other Fuel Contaminants (which may cause air pollution): _____

F. If applicable, indicate the percent of fuel used for space heating.

Annual Average _____ Maximum _____

G. Indicate liquid or solid wastes generated and method of disposal.

BEST AVAILABLE COPY

Emission Stack Geometry and Flow Characteristics (Provide data for each stack):

Stack Height: _____ ft. Stack Diameter: _____ ft.
 Gas Flow Rate: _____ ACFM _____ DSCFM Gas Exit Temperature: _____ °F.
 Water Vapor Content: _____ % Velocity: _____ FPS

SECTION IV: INCINERATOR INFORMATION

Type of Waste	Type 0 (Plastics)	Type I (Rubbish)	Type II (Refuse)	Type III (Garbage)	Type IV (Pathological)	Type V (Liq. & Gas By-prod.)	Type VI (Solid By-prod.)
Actual lb/hr Incinerated	See Supplement 2						
Uncontrolled (lbs/hr)							

Description of Waste Nylon Polymer

Total Weight Incinerated (lbs/hr) See Supplement 1 Design Capacity (lbs/hr) See supplement 1

Approximate Number of Hours of Operation per day 24 day/wk 7 wks/yr. 52

Manufacturer Pollution Control Products Co., Dallas, Texas

Date Constructed _____ Model No. IG 88

	Volume (ft) ³	Heat Release (BTU/hr)	Fuel		Temperature (°F)
			Type	BTU/hr	
Primary Chamber	83 ft. ³	100,000	nat. gas	200,00	800 F
Secondary Chamber	6.54 ft. ³	150,000	nat. gas	400,000	1,400 F

Stack Height: 70 ft. above grade ft. Stack Diameter: 14" OD, 10" ID Stack Temp. 1,400 F

Gas Flow Rate: 169 (@1,400 °F) ACFM 40 DSCFM* Velocity: 13.3 FPS

*If 50 or more tons per day design capacity, submit the emissions rate in grains per standard cubic foot dry gas corrected to 50% excess air.

Type of pollution control devices: Cyclone Wet Scrubber Afterburner
 Other (specify) _____

Brief description of operating characteristics of control devices:

The exhaust from the oven passes through the afterburner which is controlled between 1400-1500°F by controlling the rate of nylon degradation by means of a variable rate water quench spray.

Ultimate disposal of any effluent other than that emitted from the stack (scrubber water, ash, etc.):

Any ash residue from the nylon would be disposed of in compliance with solid waste and RCRA regulations.

NOTE: Items 2, 3, 4, 6, 7, 8, and 10 in Section V must be included where applicable.

SECTION V: SUPPLEMENTAL REQUIREMENTS

Please provide the following supplements where required for this application.

1. Total process input rate and product weight -- show derivation [Rule 17-2.100(127)]
2. To a construction application, attach basis of emission estimate (e.g., design calculations, design drawings, pertinent manufacturer's test data, etc.) and attach proposed methods (e.g., FR Part 60 Methods 1, 2, 3, 4, 5) to show proof of compliance with applicable standards. To an operation application, attach test results or methods used to show proof of compliance. Information provided when applying for an operation permit from a construction permit shall be indicative of the time at which the test was made.
3. Attach basis of potential discharge (e.g., emission factor, that is, AP42 test).
4. With construction permit application, include design details for all air pollution control systems (e.g., for baghouse include cloth to air ratio; for scrubber include cross-section sketch, design pressure drop, etc.)
5. With construction permit application, attach derivation of control device(s) efficiency. Include test or design data. Items 2, 3 and 5 should be consistent: actual emissions = potential (1-efficiency).
6. An 8 1/2" x 11" flow diagram which will, without revealing trade secrets, identify the individual operations and/or processes. Indicate where raw materials enter, where solid and liquid waste exit, where gaseous emissions and/or airborne particles are evolved and where finished products are obtained.
7. An 8 1/2" x 11" plot plan showing the location of the establishment, and points of airborne emissions, in relation to the surrounding area, residences and other permanent structures and roadways (Example: Copy of relevant portion of USGS topographic map).
8. An 8 1/2" x 11" plot plan of facility showing the location of manufacturing processes and outlets for airborne emissions. Relate all flows to the flow diagram.

- The appropriate application fee in accordance with Rule 17-4.05. The check should be made payable to the Department of Environmental Regulation.
- With an application for operation permit, attach a Certificate of Completion of Construction indicating that the source was constructed as shown in the construction permit.

SECTION VI: BEST AVAILABLE CONTROL TECHNOLOGY

Are standards of performance for new stationary sources pursuant to 40 C.F.R. Part 60 applicable to the source?

Yes No

Contaminant	Rate or Concentration

Has EPA declared the best available control technology for this class of sources (If yes, attach copy)

Yes No

Contaminant	Rate or Concentration

What emission levels do you propose as best available control technology?

Contaminant	Rate or Concentration

Describe the existing control and treatment technology (if any).

- | | |
|---------------------------|--------------------------|
| 1. Control Device/System: | 2. Operating Principles: |
| 3. Efficiency:* | 4. Capital Costs: |

Explain method of determining

5. Useful Life:

6. Operating Costs:

7. Energy:

8. Maintenance Cost:

9. Emissions:

Contaminant

Rate or Concentration

Contaminant	Rate or Concentration

10. Stack Parameters

- a. Height: ft.
- b. Diameter: ft.
- c. Flow Rate: ACFM
- d. Temperature: °F.
- e. Velocity: FPS

E. Describe the control and treatment technology available (As many types as applicable, use additional pages if necessary).

1.

- a. Control Device:
- b. Operating Principles:
- c. Efficiency:¹
- d. Capital Cost:
- e. Useful Life:
- f. Operating Cost:
- g. Energy:²
- h. Maintenance Cost:
- i. Availability of construction materials and process chemicals:
- j. Applicability to manufacturing processes:
- k. Ability to construct with control device, install in available space, and operate within proposed levels:

2.

- a. Control Device:
- b. Operating Principles:
- c. Efficiency:¹
- d. Capital Cost:
- e. Useful Life:
- f. Operating Cost:
- g. Energy:²
- h. Maintenance Cost:
- i. Availability of construction materials and process chemicals:

¹Explain method of determining efficiency.

²Energy to be reported in units of electrical power - KWH design rate.

BEST AVAILABLE COPY

j. Applicability to manufacturing processes:

k. Ability to construct with control device, install in available space, and operate within proposed levels:

3.

a. Control Device:

b. Operating Principles:

c. Efficiency:¹

d. Capital Cost:

e. Useful Life:

f. Operating Cost:

g. Energy:²

h. Maintenance Cost:

i. Availability of construction materials and process chemicals:

j. Applicability to manufacturing processes:

k. Ability to construct with control device, install in available space, and operate within proposed levels:

4.

a. Control Device:

b. Operating Principles:

c. Efficiency:¹

d. Capital Costs:

e. Useful Life:

f. Operating Cost:

g. Energy:²

h. Maintenance Cost:

i. Availability of construction materials and process chemicals:

j. Applicability to manufacturing processes:

k. Ability to construct with control device, install in available space, and operate within proposed levels:

Describe the control technology selected:

1. Control Device:

2. Efficiency:¹

3. Capital Cost:

4. Useful Life:

5. Operating Cost:

6. Energy:²

7. Maintenance Cost:

8. Manufacturer:

9. Other locations where employed on similar processes:

a. (1) Company:

(2) Mailing Address:

(3) City:

(4) State:

Explain method of determining efficiency.

Energy to be reported in units of electrical power - KWH design rate.

ER Form 17-1.202(1)

Effective November 30, 1982

Page 10 of 12

- (5) Environmental Manager:
- (6) Telephone No.:
- (7) Emissions:¹

Contaminant	Rate or Concentration

(8) Process Rate:¹

- b. (1) Company:
- (2) Mailing Address:
- (3) City: (4) State:
- (5) Environmental Manager:
- (6) Telephone No.:
- (7) Emissions:¹

Contaminant	Rate or Concentration

(8) Process Rate:¹

10. Reason for selection and description of systems:

¹Applicant must provide this information when available. Should this information not be available, applicant must state the reason(s) why.

SECTION VII - PREVENTION OF SIGNIFICANT DETERIORATION

A. Company Monitored Data

1. _____ no. sites _____ TSP _____ () SO₂* _____ Wind spd/dir

Period of Monitoring _____ / _____ / _____ to _____ / _____ / _____
month day year month day year

Other data recorded _____

Attach all data or statistical summaries to this application.

*Specify bubbler (B) or continuous (C).

2. Instrumentation, Field and Laboratory

- a. Was instrumentation EPA referenced or its equivalent? [] Yes [] No
- b. Was instrumentation calibrated in accordance with Department procedures?
[] Yes [] No [] Unknown

Meteorological Data Used for Air Quality Modeling

- 1. _____ Year(s) of data from _____ / _____ / _____ to _____ / _____ / _____
month day year month day year
- 2. Surface data obtained from (location) _____
- 3. Upper air (mixing height) data obtained from (location) _____
- 4. Stability wind rose (STAR) data obtained from (location) _____

Computer Models Used

- 1. _____ Modified? If yes, attach description.
- 2. _____ Modified? If yes, attach description.
- 3. _____ Modified? If yes, attach description.
- 4. _____ Modified? If yes, attach description.

Attach copies of all final model runs showing input data, receptor locations, and principle output tables.

Applicants Maximum Allowable Emission Data

Pollutant	Emission Rate
TSP	_____ grams/sec
SO ²	_____ grams/sec

Emission Data Used in Modeling

Attach list of emission sources. Emission data required is source name, description of point source (on NEDS point number), UTM coordinates, stack data, allowable emissions, and normal operating time.

Attach all other information supportive to the PSD review.

Discuss the social and economic impact of the selected technology versus other applicable technologies (i.e., jobs, payroll, production, taxes, energy, etc.). Include assessment of the environmental impact of the sources.

Attach scientific, engineering, and technical material, reports, publications, journals, and other competent relevant information describing the theory and application of the requested best available control technology.

SECTION V SUMMARY

- Item 1. Not applicable
See Supplement 1
- Item 2. See Supplements 1 & 2 and
Calculations 1 & 2
- Item 3. Noted in Section III-C footnote
- Item 4. See Supplements 1 & 2
- Item 5. See Supplement 2
- Item 6. See Supplement 1
- Item 7. See Figure 1
- Item 8. See Figure 1

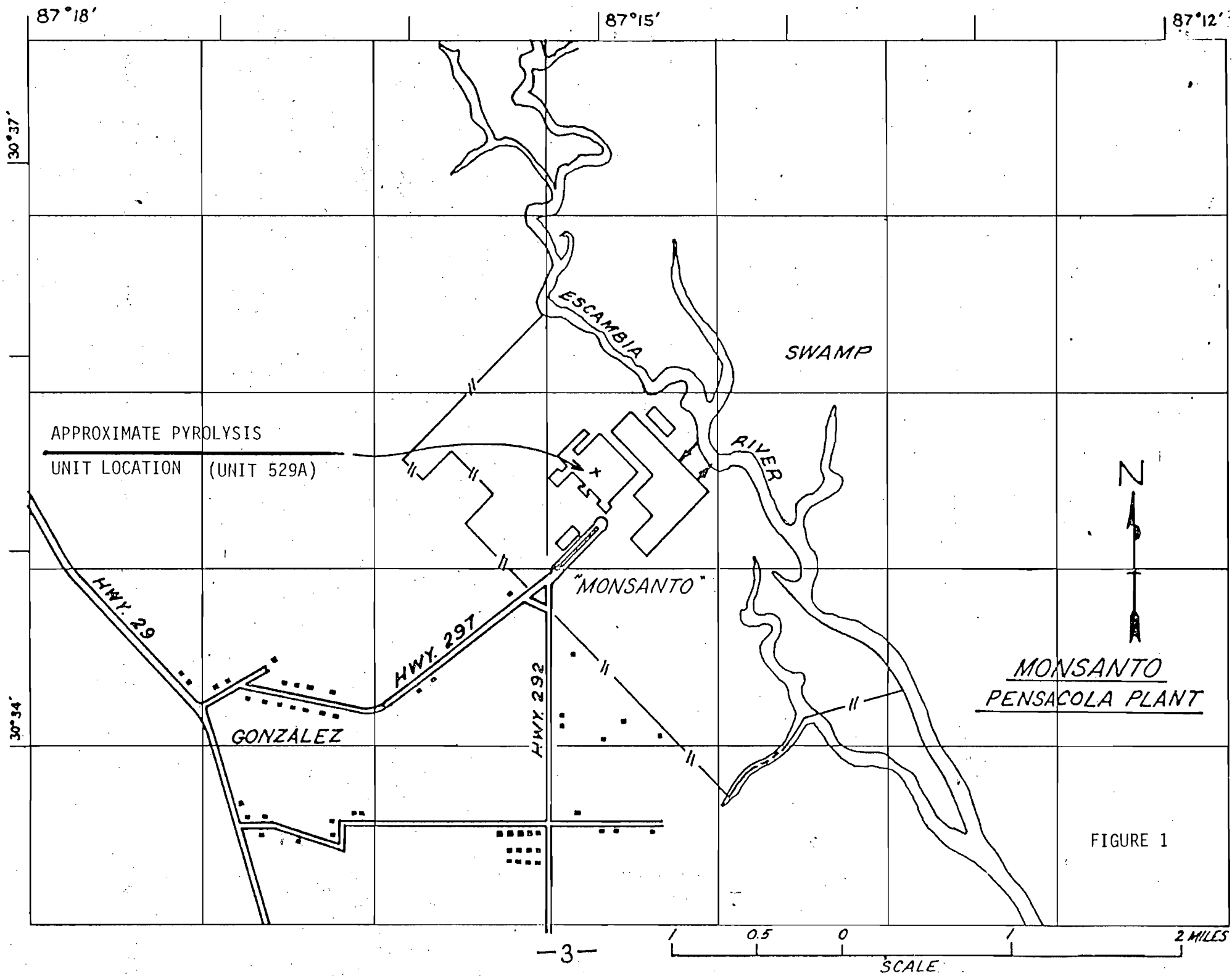

FIGURE 1

CALCULATION #1

MONSANTO PENSACOLA
 NYLON POLYMERIZATION EQUIPMENT

Calculation of NOx emission from natural gas burning - refer-
 ence section 1.4-2, AP42.

$$\text{NOx factor: } \frac{100 \text{ lb. NOx}}{10^6 \text{ ft.}^3 \text{ gas}} \quad (\text{from AP-42})$$

$$\text{Heat input: } \frac{250,000 \text{ Btu}}{\text{Hr.}} = \frac{240 \text{ ft}^3 \text{ gas}}{\text{Hr.}}$$

$$\text{Lbs. NOx} = \frac{240 \text{ ft}^3 \text{ gas}}{\text{Hr.}} \times \frac{100 \text{ lbs. NOx}}{10^6 \text{ ft}^3 \text{ gas}}$$

$$\frac{0.024 \text{ lb. NOx}}{\text{Hr.}} = \frac{0.1 \text{ tons NOx}}{\text{Yr.}}$$

$$\text{Maximum NOx} = 2 \times \text{expected NOx} = 2 \times 0.024 = \frac{0.05 \text{ lb. NOx}}{\text{Hr.}}$$

Calculation of NOx from organic nitrogen (assuming all organic
 nitrogen converted to NOx)

$$\frac{15 \text{ lb.}}{\text{Hr.}} \times \frac{28}{226} \text{ (fraction nitrogen in nylon)} \times$$

$$\frac{46 \text{ (MW NOx)}}{14 \text{ (MW Nitrogen)}} = \frac{6.1 \text{ lb. NOx}}{\text{Hr.}}$$

$$\frac{10,000 \text{ lb nylon.}}{\text{Yr.}} \times \frac{28}{226} \times \frac{46}{14} \times \frac{1 \text{ ton}}{2,000 \text{ lbs.}} =$$

2.0 tons/year

SECTION III C EMISSIONS

$$\text{Maximum hourly lbs/hr. NOx} = 0.05 + 6.1 = 6.15 \text{ lb./hr. NOx}$$

$$\text{Actual tons/yr. NOx} = 0.1 + 2.0 = 2.1 \text{ tons/yr. NOx}$$

CALCULATION #2

MONSANTO PENSACOLA

NYLON POLYMERIZATION EQUIPMENT

Calculation of particulate emission from natural gas burning;
reference section 1.4-2, AP 42.

$$\text{Particulates factor: } \frac{10 \text{ lb. particulates}}{10^6 \text{ ft.}^3 \text{ gas}}$$

$$\text{Heat input} = \frac{250,000 \text{ Btu}}{\text{Hr.}} = \frac{240 \text{ ft.}^3 \text{ gas}}{\text{Hr.}}$$

$$\text{Lb. particulates} = \frac{240 \text{ ft.}^3 \text{ gas}}{\text{Hr.}} \times \frac{10 \text{ lb. NOx}}{10^6 \text{ ft.}^3 \text{ gas}} =$$

$$.0024 \text{ lb./hr. particulates} = 0.01 \text{ tons/year}$$

$$\begin{aligned} \text{Maximum hourly particulates} &= 2 \times \text{expected particulates} = \\ &2 \times .0024 = 0.005 \text{ lb./hr.} \end{aligned}$$

SUPPLEMENT #1

MONSANTO, PENSACOLA

DISCUSSION OF NYLON POLYMER OVEN

AFTERBURNER CONTROL

Gas flow and air flow are held constant in both the oven section (primary chamber) and in the afterburner section (secondary chamber).

The afterburner temperature is factory set to achieve 1400° minimum temperature. This is not a field adjustable parameter.

As pyrolysis gases reach the afterburner, the afterburner temperature rises because of the heating value of these materials.

Pyrolysis rate in the primary chamber is controlled by water quenching. The rate of water flow is adjusted to maintain 1400-1500° afterburner temperature.

The primary chamber gas burners will not operate unless the secondary chamber (afterburner) burners are operating.

PROCESS DESCRIPTION

External oven dimensions are 57" wide x 83" long x 73" high. Nylon is heated in the primary chamber to between 800-900° F where it degrades to volatile compounds. These materials exit through the afterburner which provides 1/2 second residence time at a minimum temperature of 1400° F.

INCINERATION RATE

Maximum nylon per charge is 100 lbs. Maximum nylon burn off rate is 15 lbs./hr. Maximum annual nylon incineration capacity is 10,000 lbs.

Clean your plastics extruder hardware and other polymer or adhesive production equipment the easy way with a

**CONTROLLED
PYROLYSIS**

™

CLEANING FURNACE

THIS FURNACE REMOVES PLASTICS AND COATINGS OF CONVENTIONAL HYDROCARBONS FROM METAL PARTS BY THERMAL PYROLYSIS (CLEANING WITH HEAT). THE PARTS ARE HEATED TO 800-900°F (427-482°C) IN A OXYGEN-DEFICIENT ATMOSPHERE AND THE PLASTICS ARE DECOMPOSED TO VOLATILE SMOKE. THE SMOKE PASSES THROUGH A COMBUSTION CHAMBER AND IS RAISED TO 1400°F (760°C) FOR A MINIMUM OF ONE-HALF SECOND WITH SUFFICIENT AIR TO COMPLETELY BURN IT BEFORE VENTING TO THE ATMOSPHERE. THE DISCHARGED EFFLUENT CONSISTS PRIMARILY OF CARBON DIOXIDE AND WATER VAPOR WHICH ARE INVISIBLE, ODORLESS, AND HARMLESS.

PLASTICS WHICH WILL MELT AND FLOW DURING CLEANING DRAIN FROM THE PARTS INTO A COOL COLLECTION CHAMBER WHERE THE PLASTIC SOLIDIFIES AND CAN BE EASILY REMOVED. THIS FEATURE ALLOWS SIGNIFICANTLY SHORTER CLEANING TIMES FOR METAL PARTS CONTAMINATED WITH RELATIVELY LARGE AMOUNTS OF PLASTIC.

INTERIOR VOLUMES

27 to 340 CUBIC FEET

Available in a wide range of sizes. Seven standard models with interior dimensions 3' wide x 3' high x 3' deep up to 7' x 7' x 7'. Custom sizes also available. Heavy duty carts are designed to hold a variety of parts and rolls outside the furnace on removable tracks for easy loading and unloading.

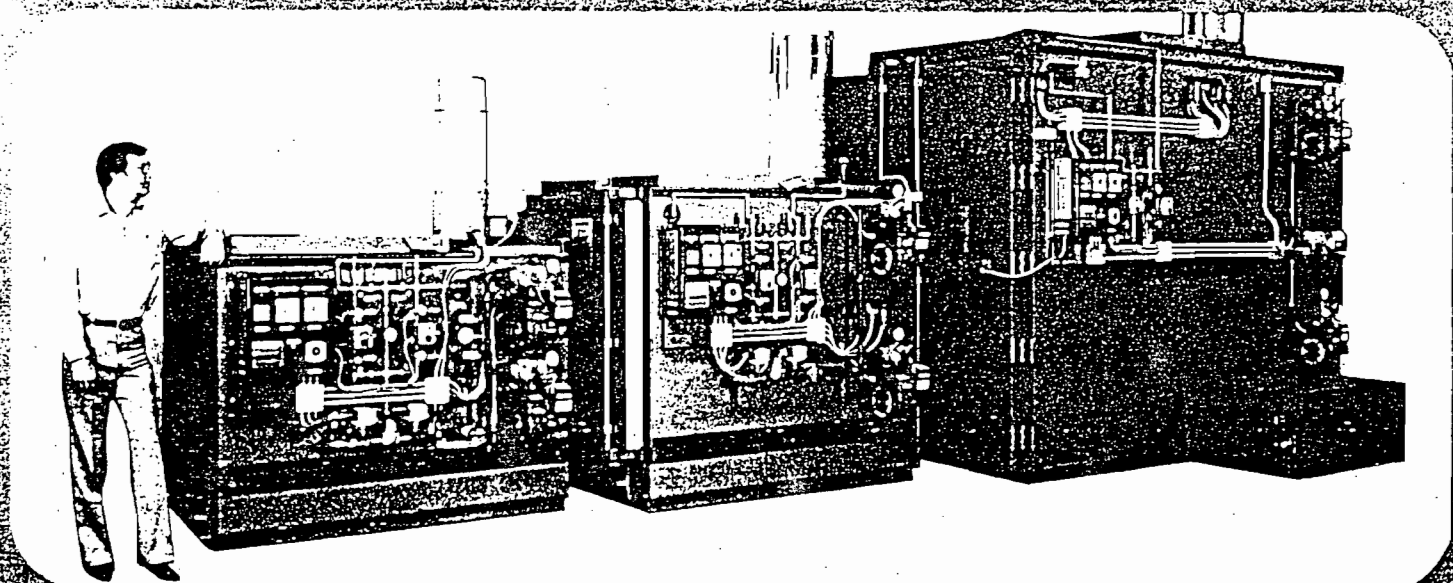
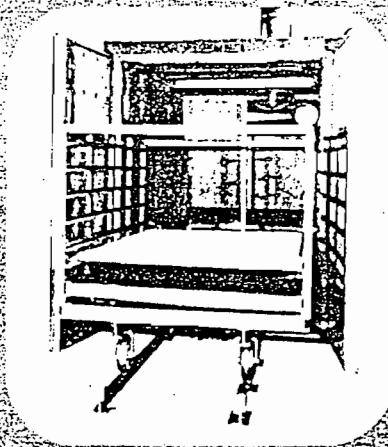

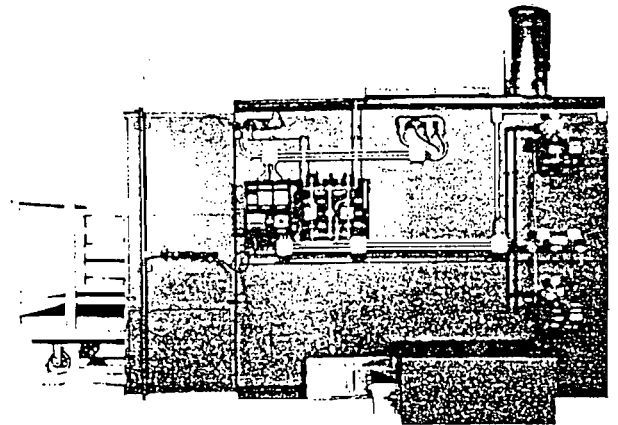
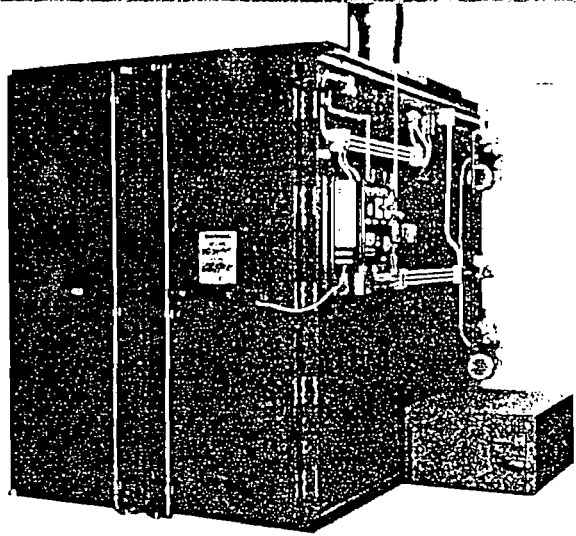

IGG-88, 150, 260, 290, and 340 have collection chambers on side. Carts roll out on removable tracks for easy loading/unloading. IGG-260 shown.

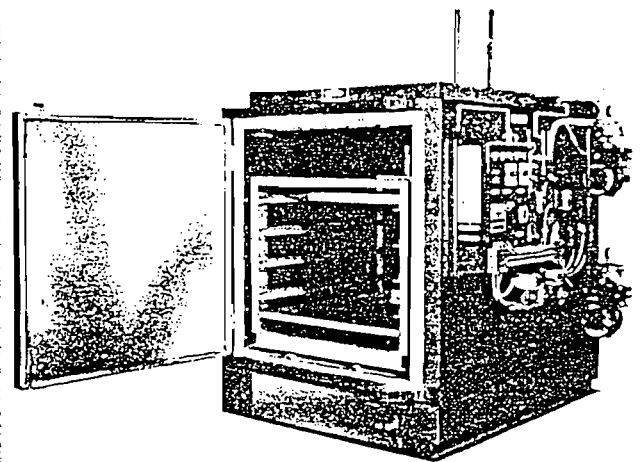
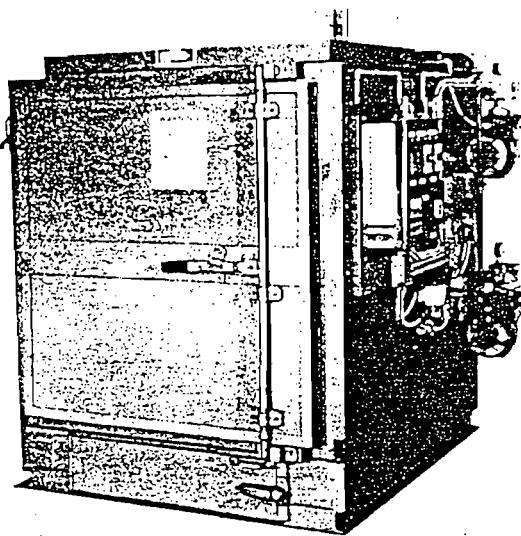

Front loading IGG-52 has collection chamber under furnace.

Cart rolls out on removable tracks. (not shown).

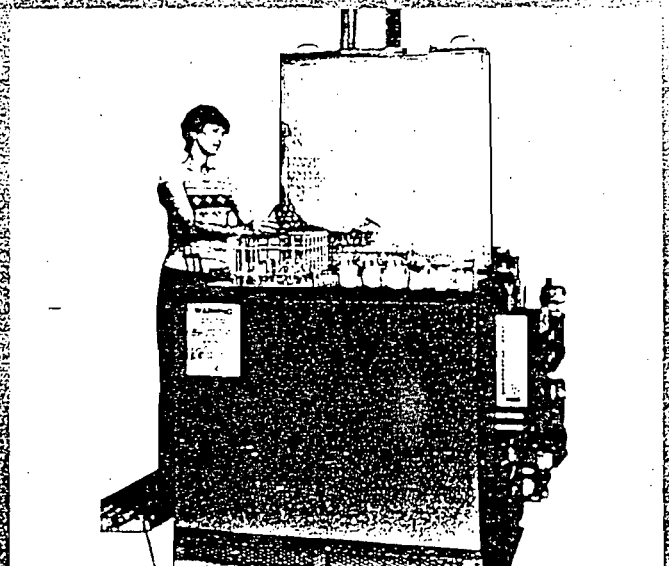
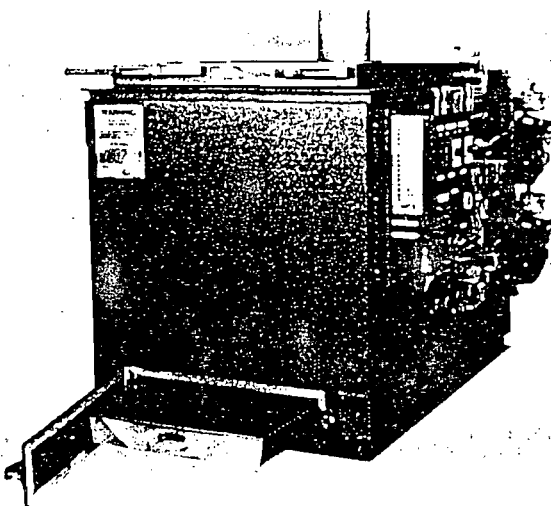

IGG-27 is front loading only and has collection chamber under furnace for maintenance parts.

SPECIFICATIONS AND DATA

CABINET: Heavy-gauge sheet steel supported by structural steel angles and channels. All-welded construction with sealed seams to prevent air leakage gives maximum fuel economy and safety.

FLOOR: Hard castable refractory, 3" thick, reinforced with structural steel channels.

DOORS: Equipped with cam-type lock assemblies, tad-pole sealing gaskets, and stay-open hooks. Doors open slightly over 90°. Door switch ensures door(s) are open during timed purge before burners are ignited.

EXPLOSION RELIEF: Required on all furnaces and ovens. Unique gravity-sealed top relief automatically opens to relieve excess pressure, then closes, preventing air from reaching combustible material. Conventional spring-latched front doors or blow-out panels used for explosion relief do not provide this important safety feature because, once opened, such doors or panels do not close to keep out air, and material inside will burn freely.

INSULATION: Walls are covered with 4" of a two-layered light-weight ceramic fiber blanket insulation anchored on stainless steel pins, stainless wire mesh, and stainless locking washers. Contains no asbestos and has superior properties to asbestos or fiberglass. Hot face insulation rated at 2300°F (1260°C) and one inch is equivalent to 9" of conventional refractory or firebrick with one-tenth the weight, making these furnaces much lighter in weight and much faster to heat with less fuel. Ceilings and doors are covered with 3" of the two layered insulation. Special outer sheet metal panels with air insulating construction reduce the outer wall temperatures of the sides and back to a minimum.

VENT STACK: Made in 36" long light-weight sections for easy erection. Galvanized metal exterior lined with high-temperature ceramic fiber in hard form. Sections snap together. Adjustable-pitch roof flashing, storm collar, and rain cap furnished with stack.

FUELS: Natural gas, propane gas, or #2 fuel oil. Minimum input 250,000 BTU/hr. to maximum 375,000 BTU/hr. Gas pressure required 7 inches water column (.18 meter). Gas train equipped with approved low and high gas pressure switches, electric main safety gas shut-off valve, and test cock.

ELECTRICAL SERVICE: 110-125 volts, 50-60 hertz, single-phase, 7 ampere draw. Optional transformers available for other voltages.

WATER SUPPLY: Minimum pressure 40 psi (2 atmos.); maximum 100 psi (6 atmos.) for water injection system. Minimum flow rate 0.3 gpm (1.2 liter/min.) to 0.9 gpm (3.6 liter/min.). Water spray injection is intermittent, on demand from temperature controllers, not continuous.

NORMAL CLEANING TIME: Typically 2-4 hours plus cooling time. Actual cleaning times vary with the amount of metal and polymer loaded to furnace. Time adjustable 0-12 hours.

NORMAL CLEANING TEMPERATURE: 800-900°F (427-482°C). Two dual-set point temperature controllers, range 0-2000°F (-18°C to 1093°C) with Fahrenheit and Celsius scales.

POLLUTION STANDARDS: Meets latest E.P.A. Federal Standards for Incinerators.

SAFETY AND HEALTH STANDARDS: Meets latest O.S.H.A. Federal Standards.

INSURANCE STANDARDS: Meets most state and local codes.

MODEL NO.	OUTSIDE DIMENSIONS						DOOR OPENING				INSIDE DEPTH FRONT TO BACK	CART INSIDE DIMENSIONS						APPROX. SHIP. WT.		
	WIDTH		DEPTH		HEIGHT		WIDTH		HEIGHT			WIDTH		DEPTH		HEIGHT		LBS	KGS	
	IN.	M.	IN.	M.	IN.	M.	IN.	M.	IN.	M.	IN.	M.	IN.	M.	IN.	M.	IN.	M.		
IGG 27	45	1.14	65	1.65	52	1.32	34	0.86	36	0.91	36	0.91	25	0.64	32	0.82	28	0.71	1960	890
IGG 52	51	1.30	71	1.80	65	1.66	40	1.02	45	1.14	48	1.22	31	0.79	45	1.14	32	0.82	2340	1061
IGG 88	57	1.45	83	2.11	73	1.85	46	1.17	60	1.52	52	1.32	37	0.94	48	1.22	36	0.91	3770	1710
IGG 150	69	1.75	95	2.41	85	2.16	58	1.47	72	1.83	64	1.63	49	1.24	60	1.52	48	1.22	4960	2250
IGG 260	75	1.91	119	3.02	98	2.49	64	1.63	84	2.13	88	2.24	55	1.40	84	2.13	60	1.52	6670	3025
IGG 290	81	2.06	119	3.02	98	2.49	70	1.78	84	2.13	88	2.24	61	1.55	84	2.13	60	1.52	6870	3116
IGG 340	93	2.36	119	3.02	98	2.49	82	2.08	84	2.13	88	2.24	73	1.85	84	2.13	60	1.52	7190	3261
IGG 391	93		131		98		82		84		100		73		96		60		7500	

PROPOSED UNIT →

manufactured by

POLLUTION
CONTROL
PRODUCTS CO.

2677 FREWOOD DRIVE
DALLAS, TEXAS 75220
214-358-1539

79 WHYTELEAFE ROAD
CATERHAM, SURREY CR3 5EJ



©1983 P.C.P.C. CATERHAM (0883) 45044

DISTRIBUTED BY

SUPPLEMENT #2

MONSANTO PENSACOLA

DISCUSSION OF AFTERBURNER EFFICIENCY

See pages 172 and 181 (attached) from the Air Pollution Engineering Manual, Publication AP-40, US-EPA.

These sections show that 1/2 second residence time at a minimum of 1400°F can be expected to yield 95+% destruction efficiency.

AIR POLLUTION ENGINEERING MANUAL

SECOND EDITION



U.S. ENVIRONMENTAL PROTECTION AGENCY

CONTROL EQUIPMENT FOR GASES AND VAPORS

AFTERBURNERS

Afterburners, also called vapor incinerators, are air pollution control devices in which combustion converts the combustible materials in gaseous effluents to carbon dioxide and water. The combustible materials may be gases, vapors, or entrained particulate matter and may contribute opacity, odor, irritants, "fallout" materials, photochemical reactivity, and toxicity to the effluents. In many cases, an afterburner can be designed and operated at an efficiency high enough to eliminate or reduce the opacity, odor, irritants, and fallout and also the photochemically reactive and toxic qualities of the effluent to levels required for compliance with air pollution standards.

The two types of afterburners in use are (1) direct flame and (2) catalytic. Direct-flame afterburners, sometimes called direct-fired afterburners, depend upon flame contact and relatively high temperatures to burn the combustible materials. Catalytic afterburners operate by preheating the contaminated effluent to a predetermined temperature (usually lower than the operating temperature of the direct-flame afterburner) and then promoting further oxidation of the combustibles by bringing them into contact with a catalyst. In Los Angeles County, which has standards for emissions of organic materials (Rule 66), afterburners are essentially all of the direct-flame type.

DIRECT-FLAME AFTERBURNERS

Direct-flame afterburners consist of a refractory-lined chamber (which may vary in cross-sectional size along its length), one or more burners, temperature indicator-controllers, safety equipment, and sometimes heat-recovery equipment such as heat exchangers. Figures 98 through 106 show external views of direct-flame afterburners and illustrate the diversity of shapes and processes that can be vented.

DESIGN PRINCIPLES

An efficient direct-flame afterburner design must provide for (1) contact between the air contaminants and the burner flame, (2) adequate time for the combustion process, (3) sufficiently high temperature in the afterburner for the complete oxidation of the combustibles, and (4) adequate velocities to insure that mixing take place without quenching combustion.

The operation of direct-flame afterburners is relatively simple. The contaminated gases are delivered to the afterburner by an exhaust system. The gases are mixed thoroughly with the burner flames in the upstream part of the unit and then pass through the remaining part of the chamber where the combustion process is completed, prior to being discharged to the atmosphere. Figure 107 shows a sectional view of a typical afterburner.

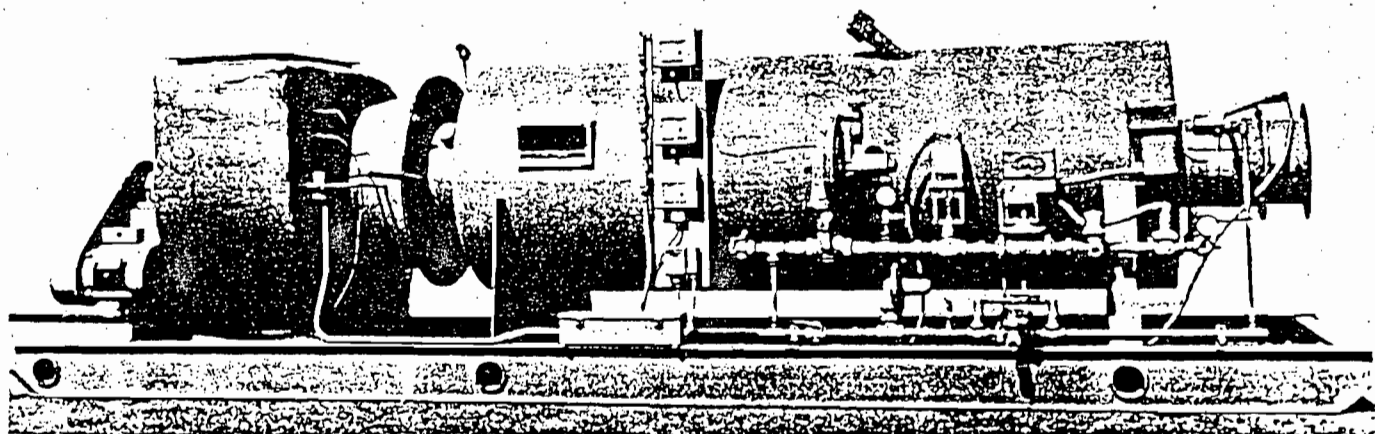

Figure 98. External view of direct-flame afterburner (Gas Processors, Inc., Brea, Calif.).

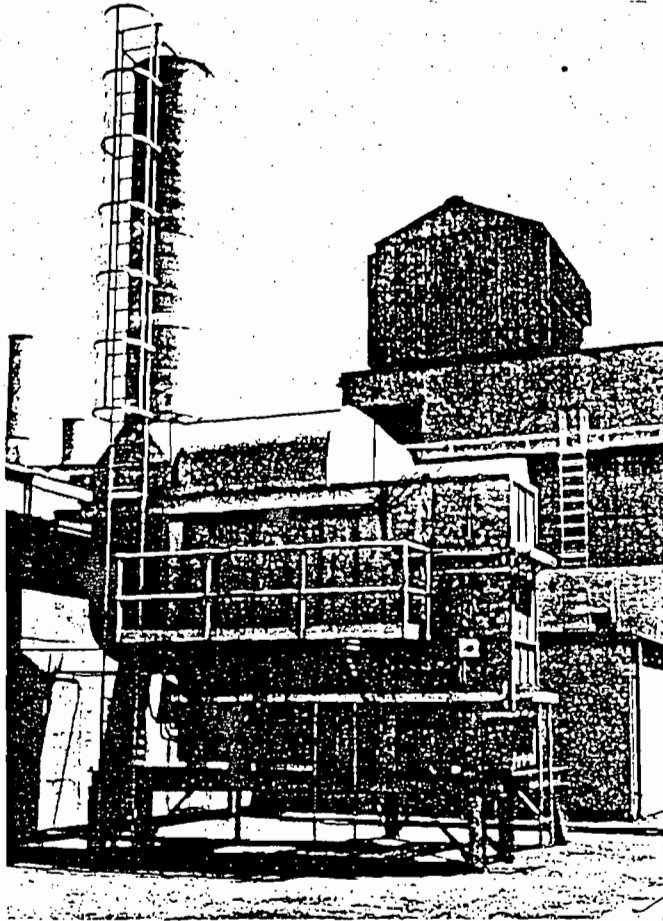

Figure 99. Direct-flame afterburner venting automotive assembly plant oven (GM Assembly Division, General Motors Corporation, Van Nuys, Calif.).

AFTERBURNER CHAMBER

The afterburner chamber may be cylindrical or rectangular in cross section and is constructed of refractory materials inside of a mild-steel shell. The refractory may be fire brick or castable refractory material. The chamber consists of a mixing section and a combustion section. The mixing section must provide for intimate contact between the contaminated gases and the burner flame. This area, therefore, is designed to provide high-velocity flow to insure turbulence and hence good mixing. Usual velocities for this zone vary between 25 and 50 feet per second (fps).

The portion of the chamber downstream of the mixing section is called the combustion chamber, and the velocity in this section is usually 20 to 40 fps. The overall retention time of the gases flowing through the unit should be 0.3 to 0.5 second. Afterburner discharge temperatures range from 1000° to 1500° F, depending upon the particular air pollution problem. Table 51 indicates recommended temperature ranges for various types of equipment. Higher afterburner dis-

charge temperatures than those shown in this table will result in higher afterburner efficiencies.

GAS BURNERS FOR AFTERBURNERS

Among the several types of gas burners used successfully are nozzle-mixing premixing, multi-port, and mixing-plate burners. Nozzle-mixing, premixing, and multi-port burners are described in the burner section of this manual. Mixing-plate burners have been specifically developed for afterburner applications. Figures 108, 109, and 110 show burners of this type. These burners consist of a pipe with orifices for natural gas and vanes or plates, which are perforated or shaped in a variety of ways to give good mixing between a contaminated air stream and the natural gas fuel. Most of the contaminated gases go through the burner.

The choice of burner type and the arrangement of the burners in the afterburner vary widely. The exact method of burner placement depends not only on the burner type, but also on the design consideration that the contaminated gases be in intimate contact with the burner flame. Maximum afterburner efficiency occurs when all of the contaminated material passes through the burner. In contrast, efficiencies are much lower when the contaminated air and burner flame mix far outside the burner. Very low efficiency is associated with minimum flame contact.

Gas burner arrangements, sources of combustion air, and methods for securing flame contact with the contaminated air are discussed below.

Mixing-Plate Burner (Figures 108, 109, and 110)

Mixing-plate burners usually are placed across the inlet section of the afterburner body. All air for combustion of the natural gas originates from the contaminated air stream.

Intimate flame contact is secured by positioning the burners and "profile plates" to force the maximum amount of contaminated air through the burner and burner flames. Profile plates, usually made of stainless steel, are installed around the burner between the afterburner walls and the burners. A space of 1 to 2 inches remains between the plate and the burner. The extremely high velocity (200 fpm) ensures that the contaminated air not flowing through the burner will mix with the burner flames.

Multi-Port Burners

Multi-port burners usually are installed across a section of the afterburner separate from the main afterburner chamber. All air for combustion is taken from the contaminated air stream. However, most multi-port burners are not capable of handling all of the contaminated stream through the

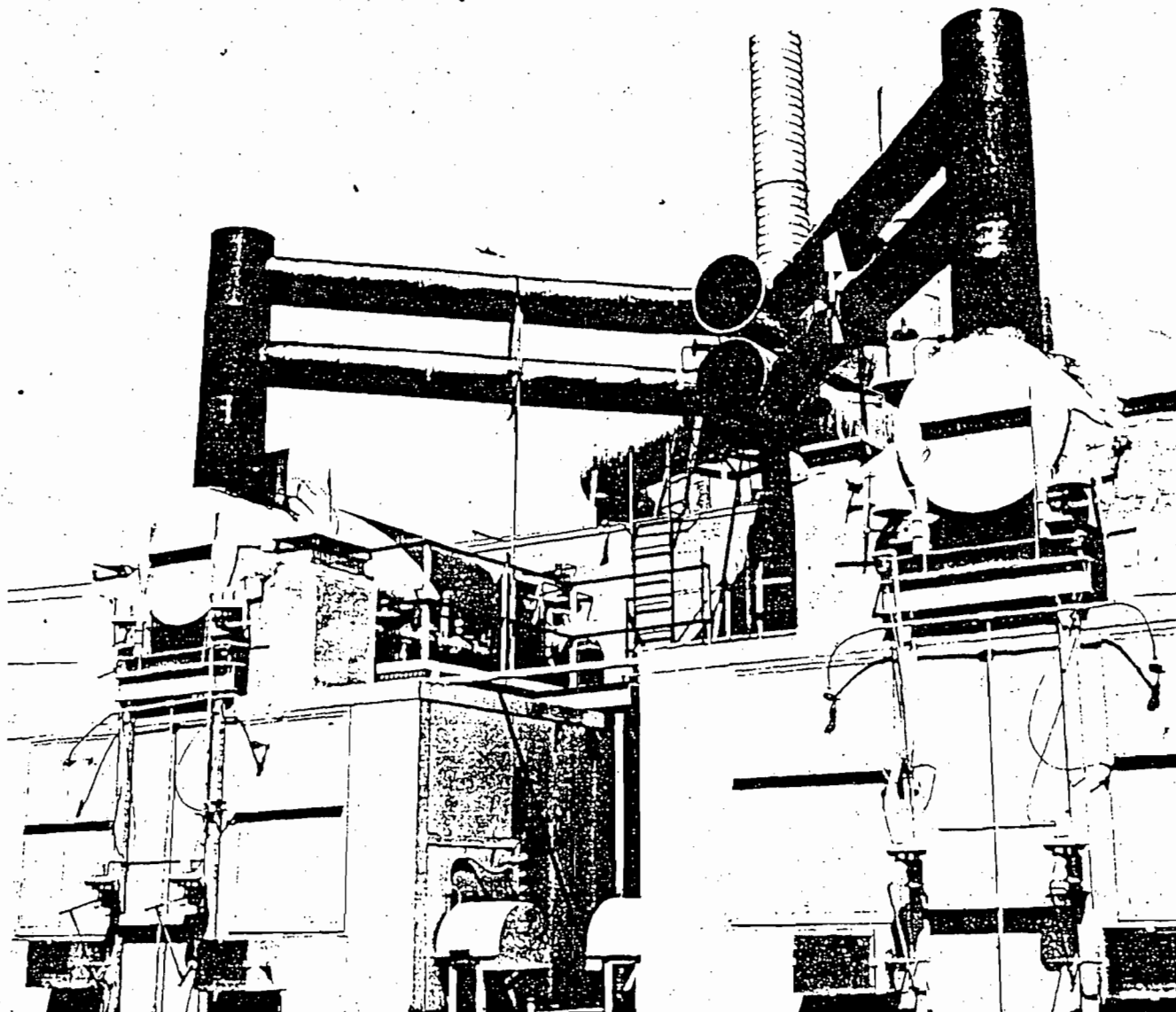

Figure 100. Two direct-flame afterburners controlling venting of organic emissions (American Cyanamid Co., Azusa, Calif.).

burner. Therefore, some of the air must be bypassed around the burner and then thoroughly mixed downstream with burner flames in a restricted and baffled area. For this reason, afterburners with multi-port burners may not be as efficient as units with mixing-plate burners. Efficiency of afterburners with multi-port burners will be influenced by the amount of contaminants that by-pass the burner.

Nozzle Mixing and Premixing Burners

The operation of these two types of burners is somewhat similar. They are arranged to fire

tangentially into a cylindrical afterburner. Several burners or nozzles are required to ensure complete flame coverage. In addition, multiple nozzles may be arranged to fire along the length of the afterburner. Air for combustion of the fuel can be taken from outside air or from the contaminated air stream.

Mixing between the contaminated gases and the burner flame is achieved in a smaller cross-sectional area of the afterburner (called the mixing section). Tangentially fired afterburners may have the contaminated gases introduced tangentially or along the major axis of the cylinder.

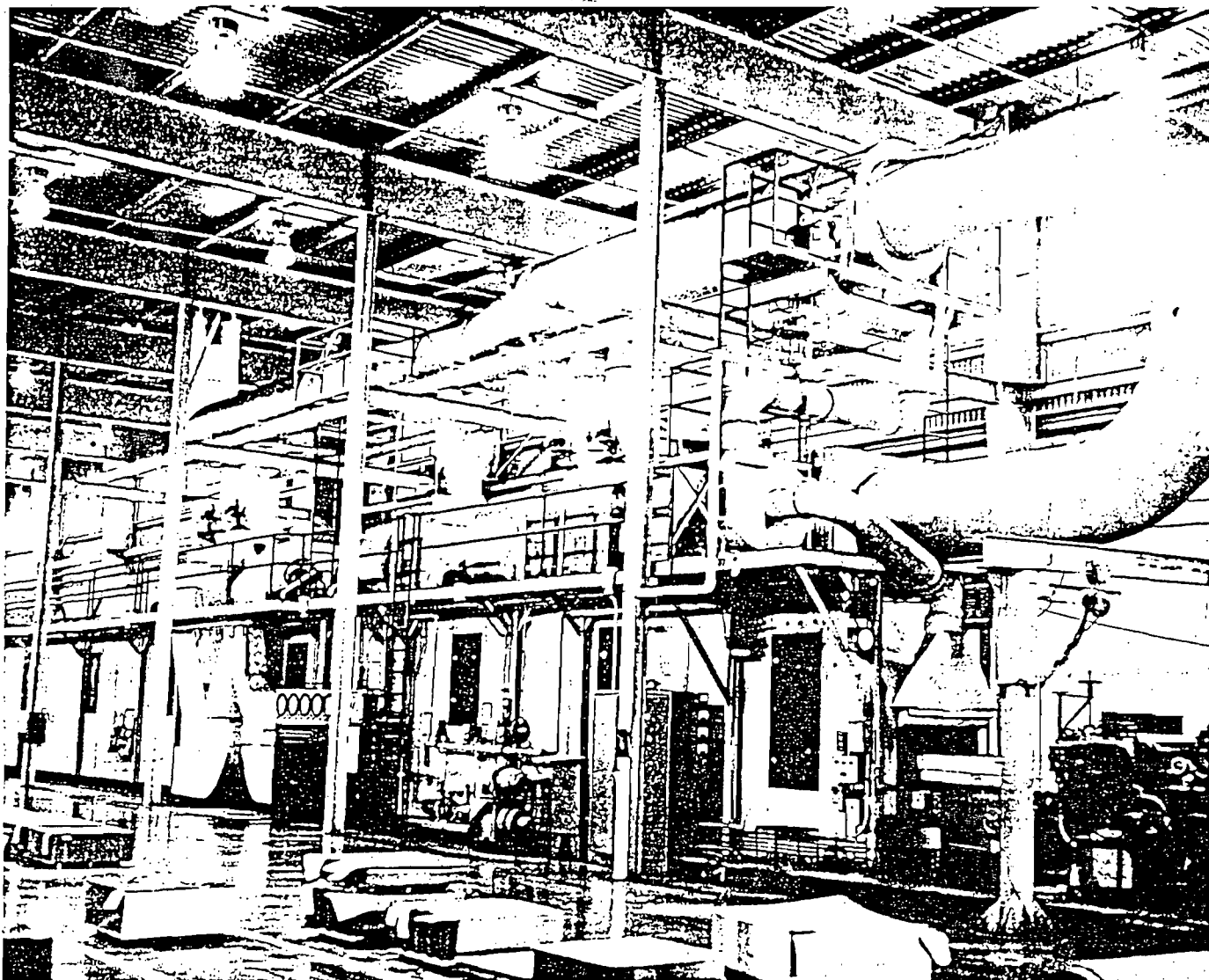

Figure 101. Direct-flame afterburner venting metal sheet lithographing line (American Can Co., Los Angeles, Calif.).

Refractory baffles and orifices also may be required to give the best possible mixing between flame and contaminated gases.

SOURCES OF COMBUSTION AIR FOR GAS BURNERS

As mentioned above, combustion air may be taken from the contaminated air stream or from ambient air. If the contaminated stream contains sufficient oxygen for combustion of the fuel and combustible contaminants, then additional oxygen is not required. Mixing-plate and multi-port burners supply the correct volume of air automatically. Premix and nozzle-mix burners require a blower and air-gas ratio controls to meter the proper mixture and combustion air. The combustion air for these burners comes from the contaminated air stream by branch

ducting from the main exhaust duct. Using this contaminated air for combustion results in higher afterburner efficiency and fuel savings of 20 to 30 percent.

OIL FIRING OF AFTERBURNERS

Oil firing of afterburners is feasible provided that proper design practice is followed and good flame contact is assured. Although oil firing is possible, it may be undesirable from the standpoint of overall air pollution emissions. The combustion of oil produces oxides of sulfur from the sulfur-containing oil and may produce oxides of nitrogen greater than those from gas-fired units. For these reasons, oil firing may not be desirable for many locales or should be restricted, i.e., used only for periods when fuel gas is not available.

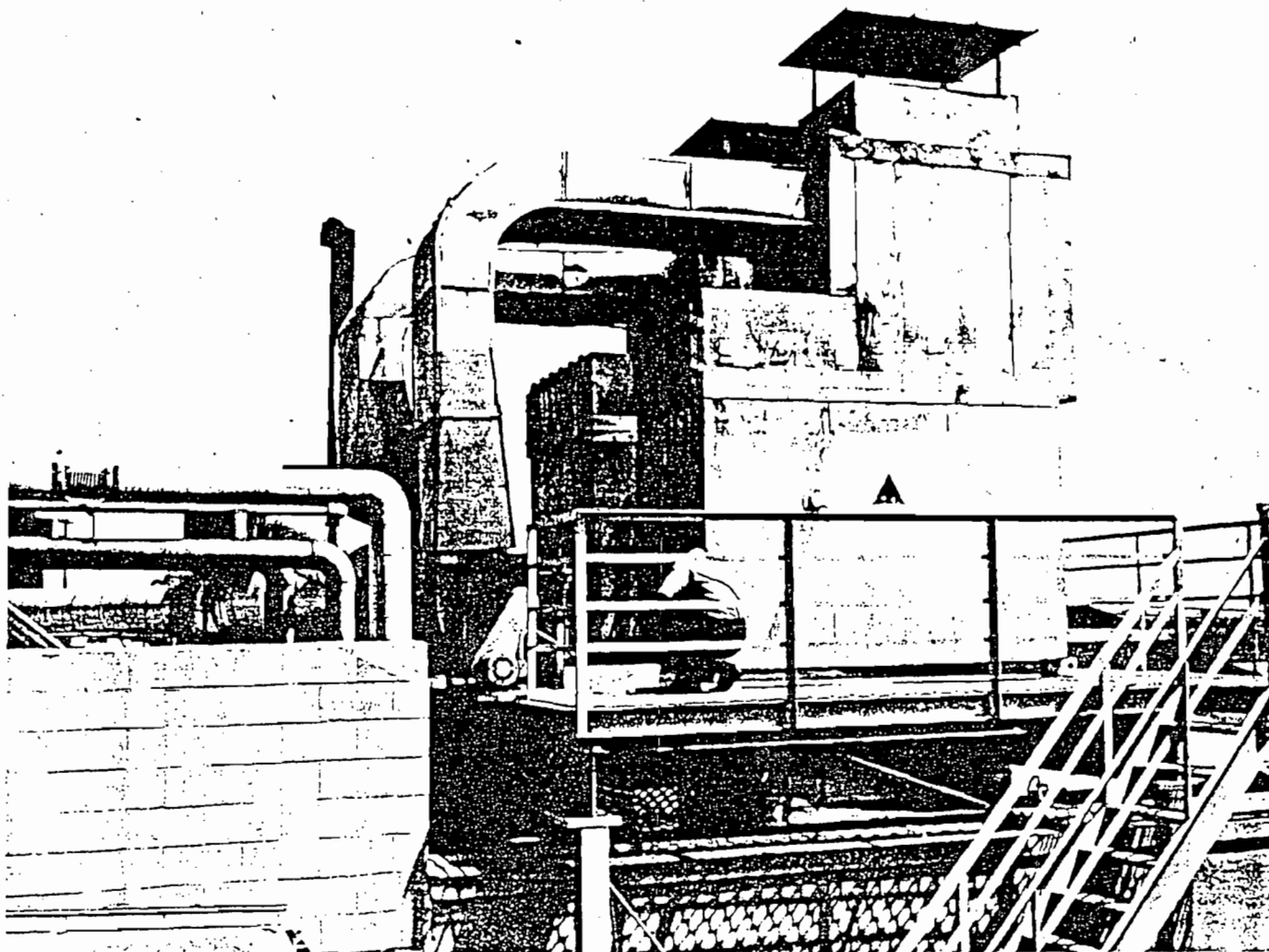

Figure 102. Direct-flame afterburner venting resin impregnating line (Synthane-Taylor Corporation, LaVerne, Calif.).

AFTERBURNER CONTROLS

Afterburner operating controls usually consist of a shielded thermocouple located in the discharge of the afterburner and an indicating-controlling pyrometer, which is coupled to the thermocouple. The pyrometer electrically or pneumatically controls gas and combustion air valves to modulate the amount of fuel fed to the afterburner. The mode of operation is fully modulating or high-low. The on-off control mode is undesirable since there are substantial periods when no burner flame is present with accompanying very low afterburner efficiency.

Safety controls consists of (1) flame safety devices to prove the presence of pilot burner flame, (2) timing devices to ensure that the afterburner is purged of combustibles before burner ignition, (3) high-temperature-limit controls to limit the afterburner temperature to a safe limit, and (4)

pressure switches to detect low gas and air pressures and shut-down the unit if pressures become too low.

DIRECT-FLAME AFTERBURNER EFFICIENCY

Afterburner efficiency is defined as:

$$\text{Efficiency (\%)} = \frac{(\text{lb contam/hr in}) - (\text{lb contam/hr out})}{\text{lb contaminant/hr in}} \times 100$$

As mentioned earlier, the efficiency of an afterburner is a function of retention time, operating temperature, flame contact, and velocity. There is no quantitative mathematical relationship that relates efficiency to these variables because the kinetics of the combustion process are complex and the flow in afterburners is not easily defined. Assuming good design, the following generalizations may be made with respect to afterburner efficiency:

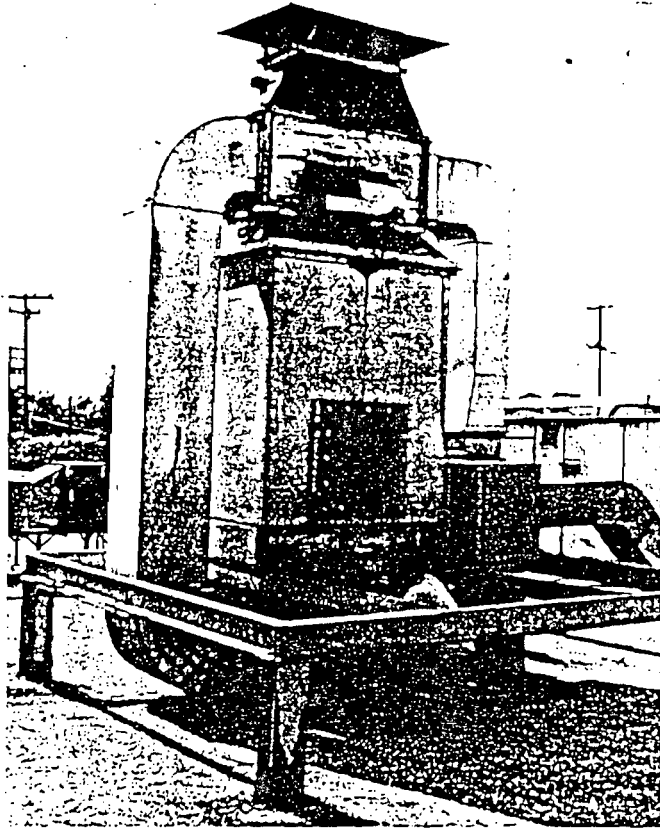

Figure 103. Direct-flame afterburner venting printing system (Avery Label Company, Div. of Avery Products Corporation; Monrovia, Calif.).

1. Overall efficiency increases with increasing afterburner operating temperature. Figure 111 illustrates this point.
2. Overall efficiency decreases if excessive preheat is given to the contaminated gases entering the afterburner.
3. Overall efficiency increases with increased flame contact between the contaminated gases and the burner flame.
4. Efficiency increases with retention time for retention times of less than 1 second.
5. Efficiency is a function of the afterburner design, and the inlet concentration of organic materials. No direct comparison can be made from one design to another.
6. An afterburner rarely attains 90 percent efficiency below 1300° F if the generation of carbon monoxide in the afterburner is included.

Tables 52 and 53 show typical data from tests on a large and a small afterburner.

In moderately efficient afterburners organic materials frequently decrease across the afterburner, but carbon monoxide levels increase. While this indicates some oxidation of organic materials, the materials discharged from the afterburner may be considerably more photochemically reactive, odorous, or irritating than the organic materials entering the afterburner. Thus, there may not be an overall improvement in the environment. In addition, the venting of carbon monoxide to the atmosphere is undesirable.

DIRECT-FLAME AFTERBURNER DESIGN PROBLEM

Given:

- Source of air contaminants - paint bake oven
- Oven effluent air volume - 4000 scfm
- Contaminated air temperature at afterburner inlet - 300° F
- Concentration of solvent - 300 ppm
- Required afterburner efficiency - 90%

Problem:

Determine dimensions of afterburner, burner type, operating temperature, and required natural gas input.

1. Burner selection:

The afterburner inlet gases will be relatively low in concentration (300 ppm). In addition, 90 percent efficiency based on carbon is required by Rule 66, which demands the best flame contact possible. On these bases, select a mixing-plate burner.

2. Temperature selection:

The 90 percent efficiency requirement dictates the choice of 1400° F as the minimum required operating temperature.

3. Burner capacity:

- a. Net heat required to raise contaminate air stream to 1400° F from 300° F

Assumed properties of air:

Enthalpy at 1400° F = 26.13 Btu/scf
(see Table D4 in Appendix D)

Enthalpy at 300° F = 4.42 Btu/scf
(See Table D-4 in Appendix D)

Net enthalpy = 21.71 Btu/scf

$$Q_{\text{net}} = (4000)(60)(21.71) = 5.2 \times 10^6 \text{ Btu/hr}$$

- b. Natural gas input required:

The hypothetical available heat for natural gas with 0% outside primary

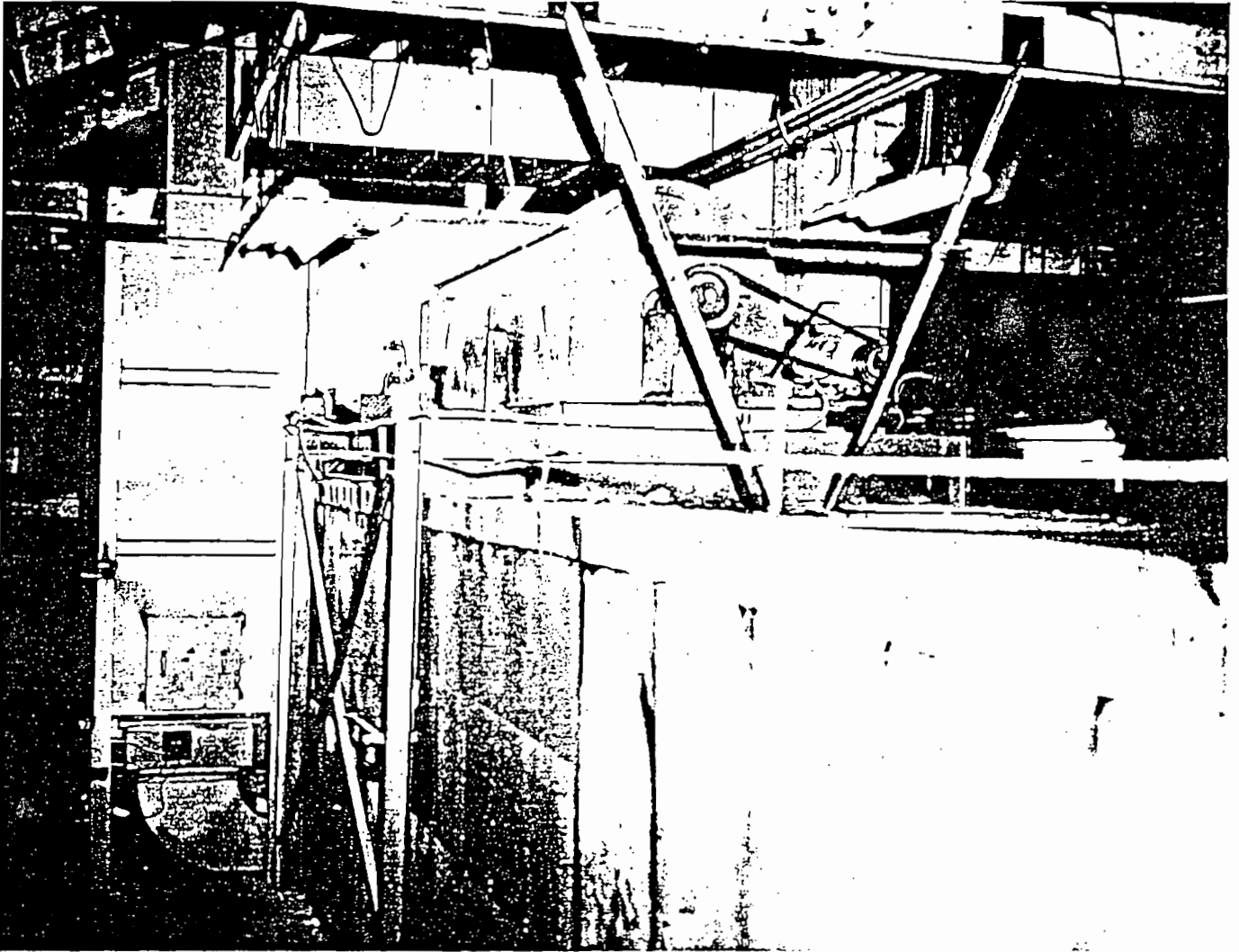

Figure 104. Direct-flame afterburner venting paint baking oven (Weber Show Case and Fixture, Div. of Walter Kidde and Company, Inc., Los Angeles, Calif.).

air = 939 Btu/ft³ (see Table C1 in Appendix C)

Natural gas input =

$$\frac{Q_{\text{net}}}{\text{Hypothetical available heat}} = \frac{5.2 \times 10^6}{939} = 5,550 \text{ ft}^3/\text{hr}$$

4. Combustion chamber diameter:

Chamber is assumed to be cylindrical

a. Volume of gases in afterburner:

Vol = Oven effluent air - effluent used for combustion products from combustion of natural gas.

(1) Air for combustion of natural gas in (3b) above:

Air required = 10.36 ft³/ft³ natural gas (see Table D7 in Appendix D)

$$\frac{(5,550)(10.36)}{60} = 959 \text{ scfm}$$

(2) Products from combustion of natural gas:

Combustion products = 11.45 scfm/ft³ natural gas (see Table D7 in Appendix D)

$$\frac{(5,550)(11.45)}{60} = 1060 \text{ scfm}$$

(3) Volume of gases in afterburner:

$$4000 - 959 + 1060 = 4100 \text{ scfm}$$

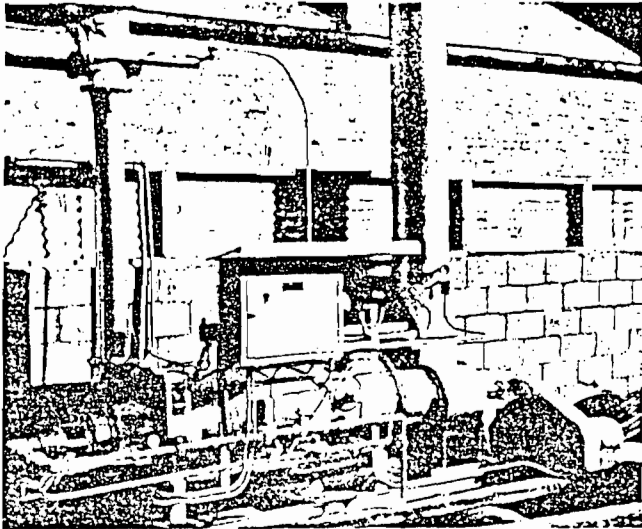

Figure 105. Direct-flame afterburner venting three varnish cooking kettles and a thinning station (National Paint and Varnish Co., Los Angeles, Calif.).

(4) Volume of gases at 1400° F (1560° R):

$$\frac{(1100)(1860)}{(60)(520)} = 244 \text{ cfs}$$

b. Diameter of afterburner:

Velocities of 20 to 40 fps are satisfactory.

Assume 30 fps.

$$\text{Afterburner cross section} = (244)(1/30) = 8.1 \text{ ft}^2$$

Diameter corresponding to 8.1 ft² =

$$\sqrt{\frac{8.1}{0.785}} = 3.2 \text{ ft}$$

5. Combustion chamber length:

Retention times of 0.3 to 0.5 second are adequate.

Assume 0.5 second.

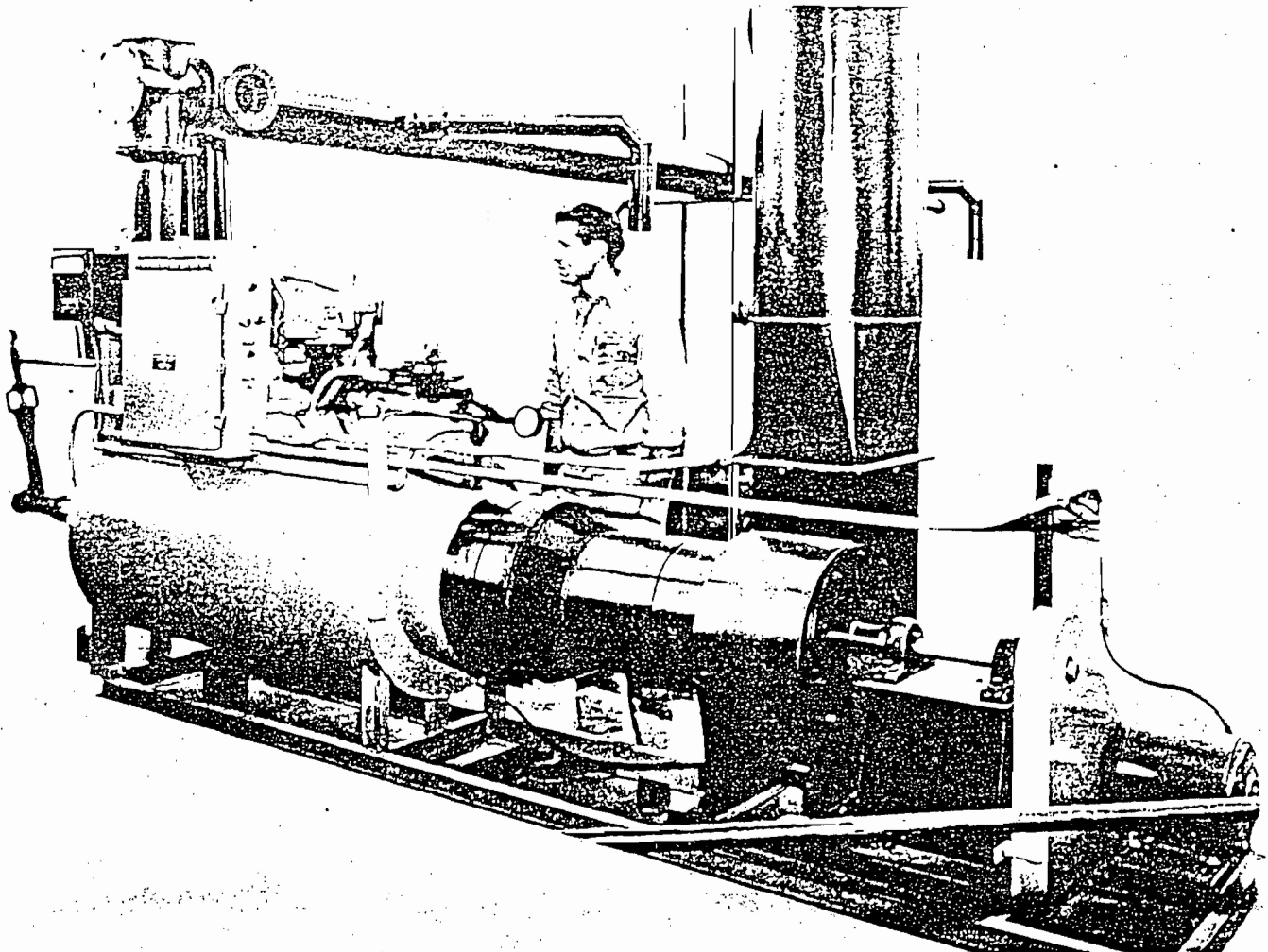

Figure 106. Direct-flame afterburner with induced-draft fan, all mounted on an integral frame and ready for shipment (Hirt Combustion Engineers, Montebello, Calif.).

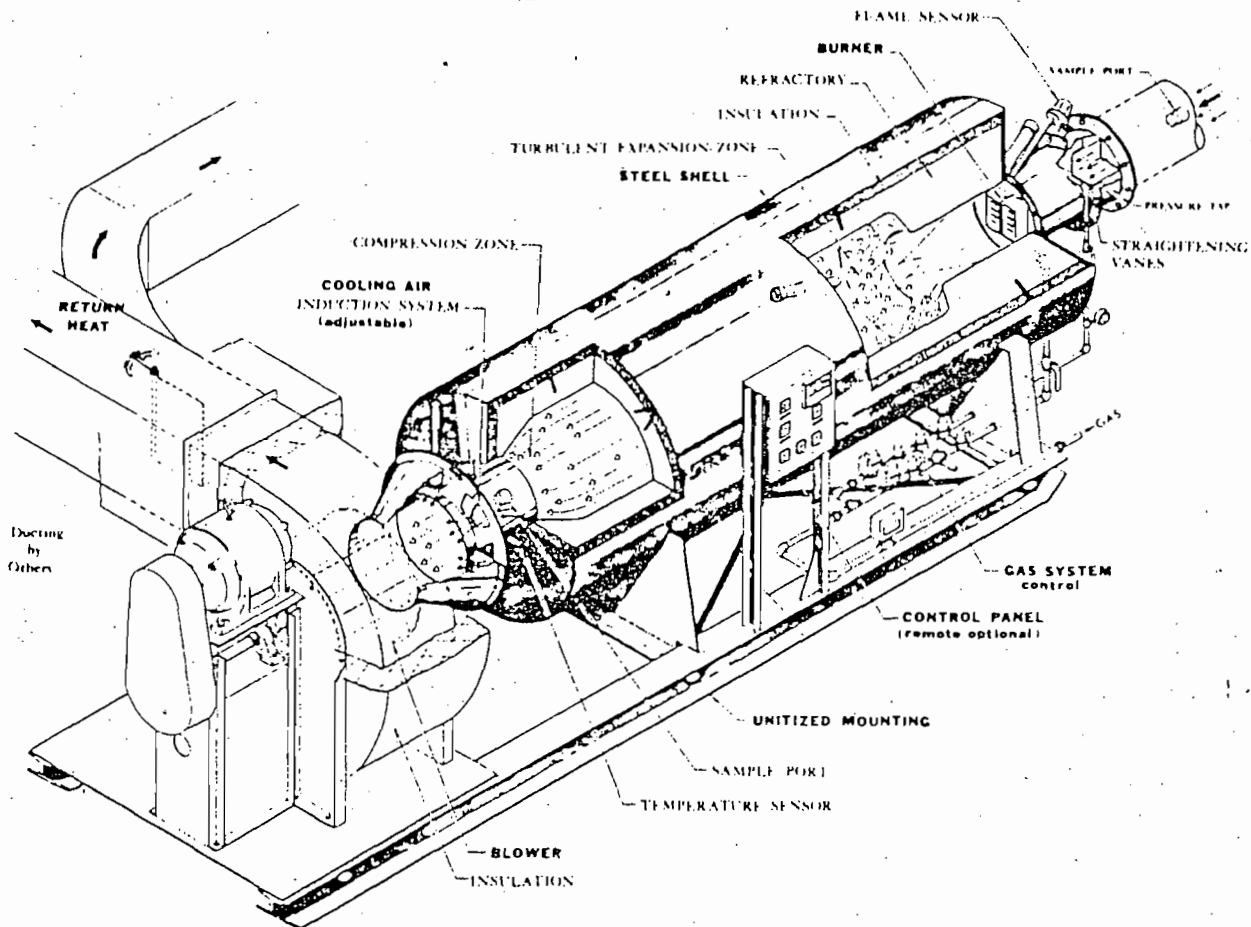

Figure 107. Sectional view of direct-flame afterburner (Gas Processors, Inc., Brea, Calif.).

Table 51. RECOMMENDED AFTERBURNER OPERATING TEMPERATURES

Operation	Recommended temperature, ° F
Carpet laminating	1200 - 1400
Core oven	1400
Cloth carbonization	1800
Deep fat fryers	1200
General opacity problems	1200 - 1400
Odor control	1300 - 1500
Oil and grease smoke	1200 - 1400
Paint bake ovens	1200 - 1500
Pipe wrapping	1400
Rendering operations	1200
Smokehouse	1200
Solvent control	1300 - 1500
Varnish cookers	1200
Vinyl plastisol curing	1200 - 1400

$$\text{Length} = (\text{retention time}) (\text{velocity})$$

$$= (0.5)(30) = 15 \text{ ft}$$

Summary of design:

- Burner type--Mixing plate
- Afterburner temperature = 1400° F
- Burner input = 5,550 cfh
- Afterburner diameter = 3.2 ft
- Afterburner chamber length = 15 ft

CATALYTIC AFTERBURNERS

A catalytic afterburner consists of a preheat burner section, a chamber containing catalyst, temperature indicator-controllers, safety equipment, and heat recovery equipment. Figures 112 through 115 show various arrangements of catalytic afterburners.

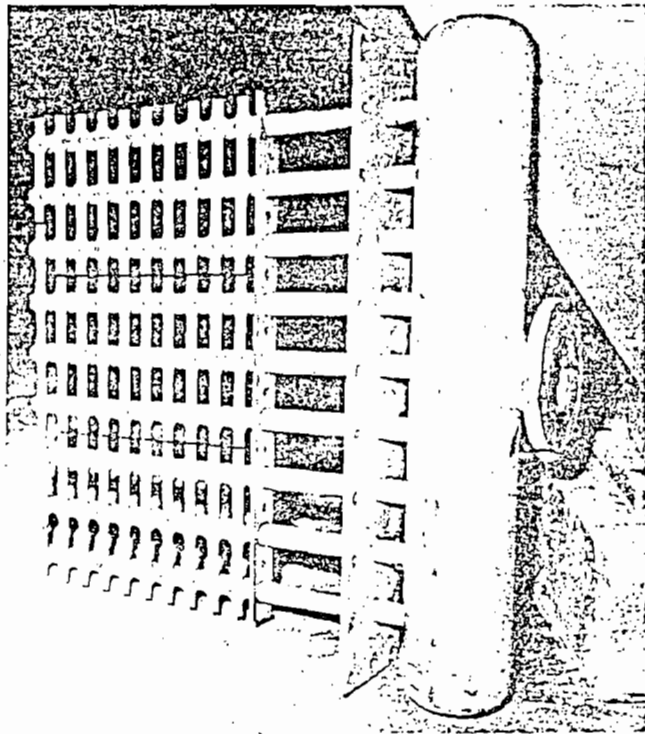

Figure 108. Mixing plate burner (J.T. Thorpe, Inc., Los Angeles, Calif.).

OPERATION

A catalyst is a substance that changes the rate of a chemical reaction and does not appear to change chemically in doing so. In the case of afterburners, the catalyst functions to promote the oxidation reactions at a somewhat lower temperature than occurs in a direct-flame afterburner. The catalyst usually is platinum combined with other metals and deposited in porous form on an inert substrate. The substrate may be in the form of rods, honeycomb, or ribbons. In any case, the objective is to present the maximum catalyst surface area to the contaminated gases.

In operation, the contaminated gases delivered to the afterburner first enter the preheat zone, where they are heated to the temperature required to sustain the catalytic combustion. The preheat zone temperature varies with the composition and type of contaminants to be oxidized, but is generally in the range of 650° to 1100° F. A substantial portion of the overall efficiency of the afterburner can be attributed to the burner in the preheated zone. The preheated gases then flow through the catalytic elements, where the remaining contaminants are burned. The combustion reaction is exothermic, resulting in an increase of catalyst temperature--the greater the concentration of

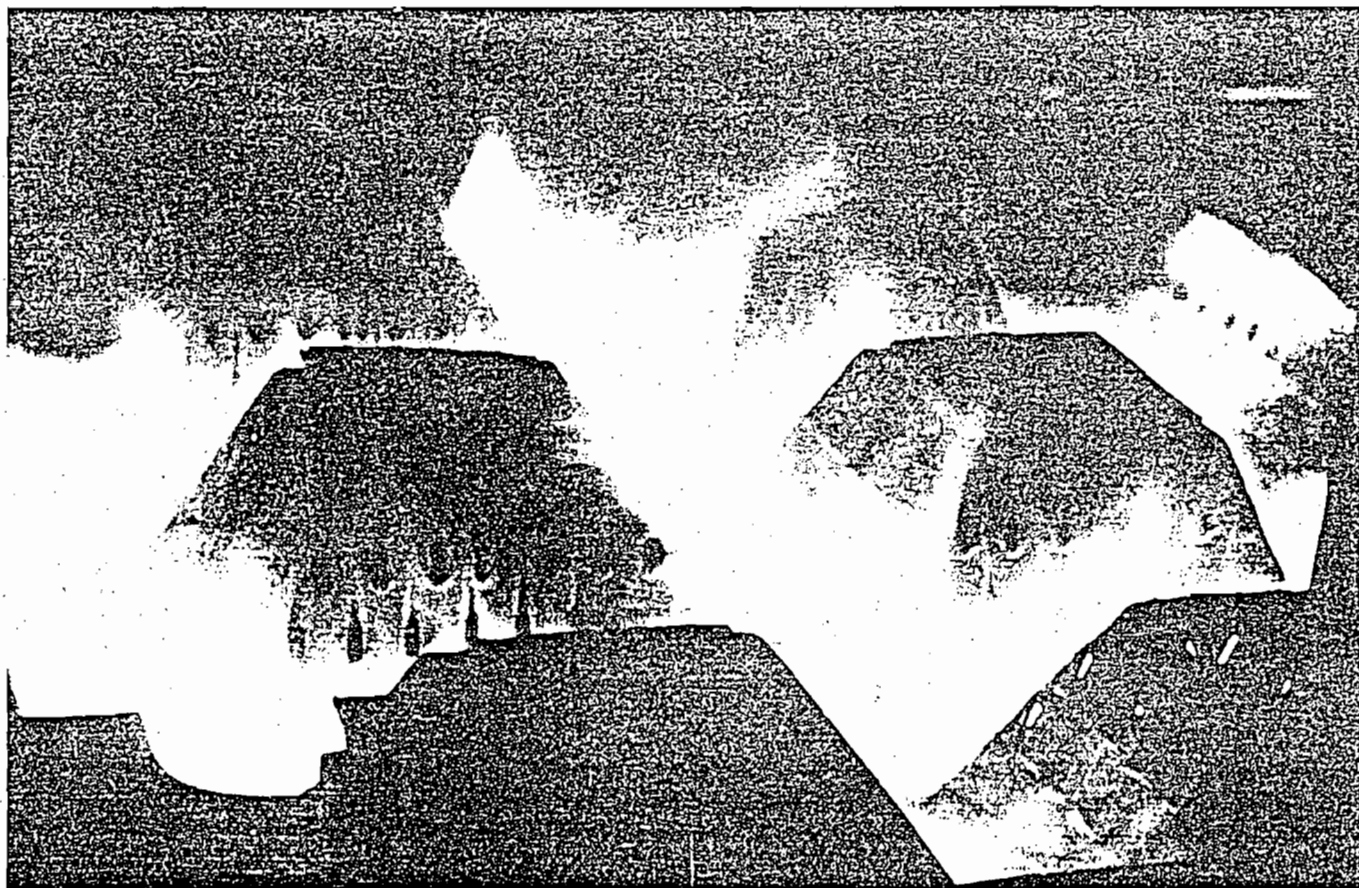

Figure 109. Mixing plate burner (Maxon Premix Burner Co., Inc., Muncie, Ind.).

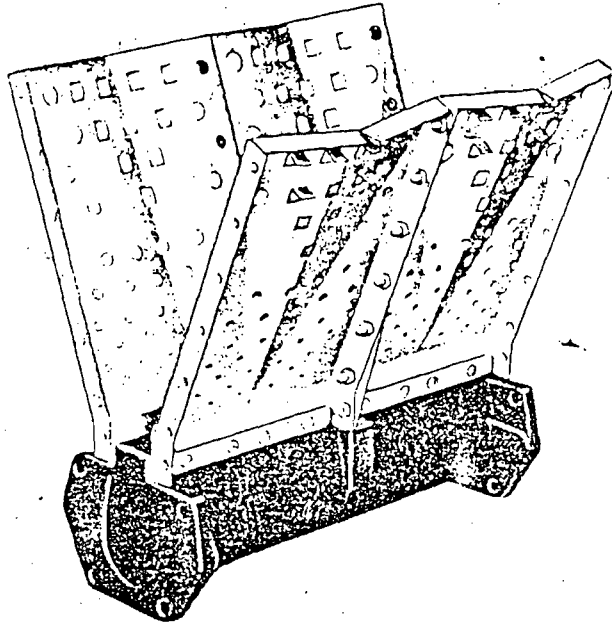

Figure 110. Schematic drawing of mixing plate burner (Maxon Primix Burner Co., Inc., Muncie, Inc.).

combustible material, the higher the catalyst temperature. Under some conditions it is possible to reduce the preheat temperature of the entering gases after the reaction has been initiated.

EFFICIENCY

The efficiency of catalytic afterburners is a function of many variables. These include surface area of the catalyst, catalyst type, uniformity of flow of the gases through the catalyst bed, nature of the material being burned, oxygen concentration, volume of gases per unit of catalyst, and temperature of the unit.

The efficiency of a catalytic afterburner deteriorates as the unit is used, and periodic replacement of the elements is required. This replacement time varies widely, depending upon the service of the unit, from a few months to 2 years. In addition, the performance of the catalyst is seriously affected by materials that "poison" the catalyst. Some of these are mercury, arsenic, zinc, and lead. Substances that coat the catalytic elements such as resin solids and solid oxides must be avoided since these materials will seal off the catalyst from the gases to be treated.

Catalytic afterburners may not be capable of meeting local efficiency requirements, such as 90 percent conversion of the carbon in the organic

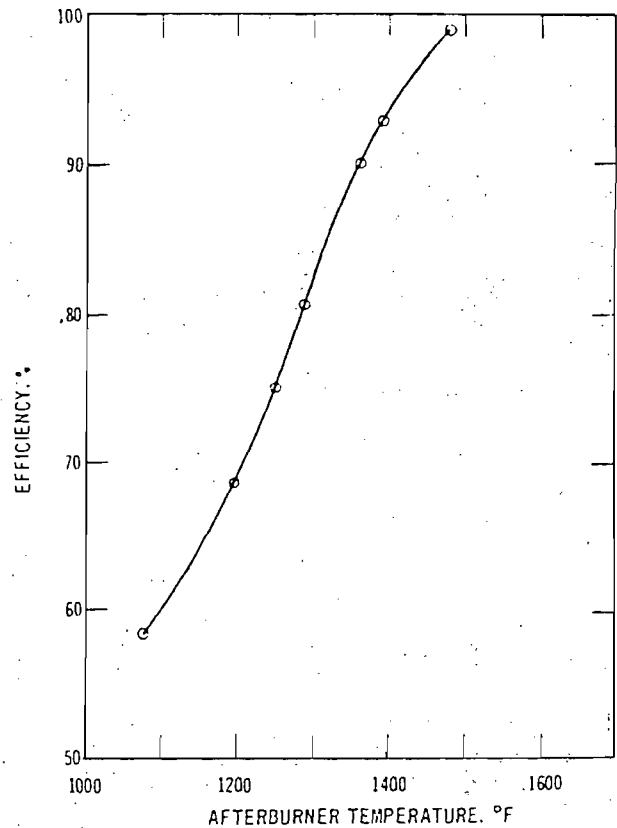

Figure 111. Direct-flame afterburner efficiency as a function of temperature.

materials to carbon dioxide. New catalysts recently made available may increase the afterburner efficiency at relatively high inlet concentrations (greater than 5000 ppm as carbon). At lower concentrations, the catalytic afterburner efficiency decreases markedly even at discharge temperatures as high as 1100° F. Catalytic afterburners operating at less than 900° to 1000° F may exhaust gases that are odorous and eye irritating. This problem appears to be due to the incomplete oxidation of the organic material, resulting in aldehydes, ketones, and organic acids.

RECOVERY OF HEAT FROM AFTERBURNER EXHAUST GASES

The heat discharge in the afterburner exhaust gases frequently can be recovered, and thus the overall cost of afterburner operation may be reduced. Some of the heat recovery schemes that have been used successfully include:

1. Heat exchangers to heat the contaminated gases before entry into the afterburner.

Table 52. TYPICAL ANALYSIS OF EMISSIONS ENTERING AND LEAVING
LARGE DIRECT-FIRED AFTERBURNER

	Temperature			
	1400° F		1500° F	
	In	Out	In	Out
CO ₂ , ppm	6,300	22,000	6,600	27,000
CO, ppm	59	230	65	21
Organics as CO ₂ , ppm	1,568	235 ^a	1,591	70
Volume (dry basis), scfm	11,950	11,800	12,000	11,300
Organics (as carbon), lb/hr	35.6	5.26	36.2	1.6
Afterburner efficiency, %	85		96	

^aIncludes increase of CO across afterburner.

Table 53. TYPICAL ANALYSIS OF EMISSIONS ENTERING AND LEAVING
SMALL DIRECT-FIRED AFTERBURNER

	Temperature			
	1300° F		1400° F	
	In	Out	In	Out
CO ₂ , ppm	1,950	19,000	2,000	23,500
CO, ppm	8	110	9	24
Organics as CO ₂ , ppm	521	122 ^a	408	33 ^a
Volume (dry basis), scfm	2,240	2,200	2,240	2,200
Organics (as carbon), lb/hr	2.21	0.50	1.74	0.14
Afterburner efficiency, %	77		92	

^aIncludes increase of CO across afterburner.

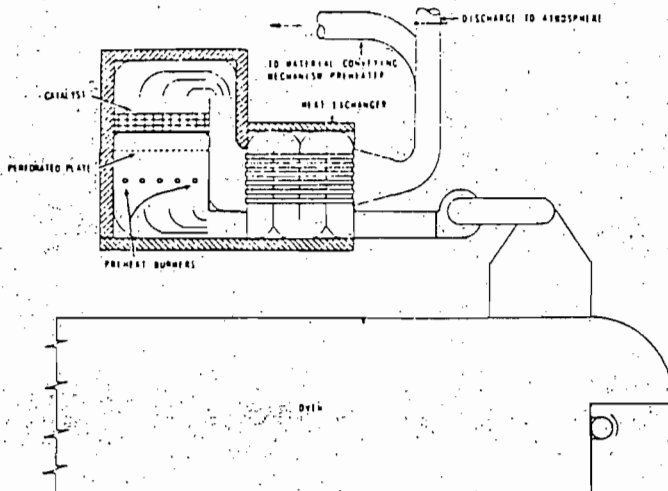

Figure 112. Typical catalytic afterburner utilizing indirect heat recovery.

- Heat exchangers to heat air as a source of heat for the equipment generating the contaminated gases.
- Venting of the afterburner gases to other process equipment such as waste heat boilers, water dry-off ovens, and vaporizers.

PREHEATING OF AFTERBURNER INLET GASES

Use of a heat exchanger for preheating the contaminated gases entering the afterburner is one of the most commonly used methods of recovery of heat from afterburner exhaust gases. The usual method is to use a shell-and-tube heat exchanger with the gases to be heated on the tube side and the afterburner discharge gases on the shell side. There may be one or two passes on the tube side and one pass on the shell side. In heat exchange

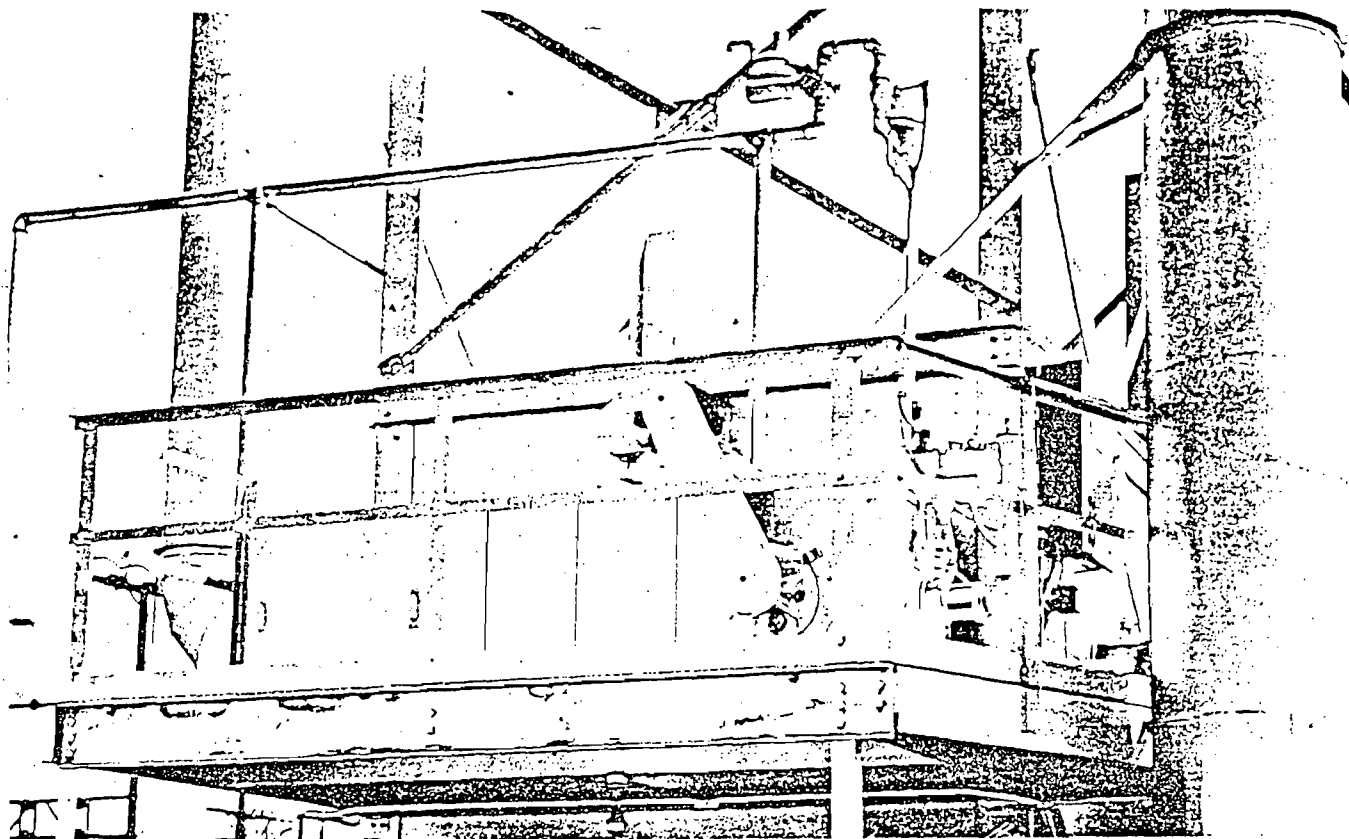

Figure 113. A catalytic afterburner used to control a foundry core baking oven (Catalytic Combustion Corporation, Detroit, Michigan).

terminology, a pass is the number of times an individual stream exchanges heat with another stream. The temperature of the heated, contaminated gas leaving the exchanger usually is about midway between the cool gases entering the exchanger and the temperature of the gases vented to the exchanger from the afterburner.

The stream entering the afterburner should not be preheated to too high a temperature. Excessive preheat will substantially reduce the amount of burner flame present and thus lower the efficiency.

BOILERS USED AS AFTERBURNERS

Fireboxes of boilers and fired heaters can be used, under proper conditions, as afterburners to incinerate combustible air contaminants. This use is unique in that a basic source of air contaminants, a boiler, is used to control pollutants from another source. Boiler firebox conditions approximate those of a well-designed afterburner, provided there are adequate temperature, retention time, turbulence, and flame. Oxidizable contaminants, including smoke and organic vapors and gases, can be converted essentially to carbon dioxide and water in boiler fireboxes.

The discussion of this section is limited to the control of low-calorific-value gases and vapors with common types of steam and hot water boilers and heaters. When appreciable heat is contained in the contaminated gases, the firebox is usually of special design to take advantage of the heat potential. These latter units, commonly known as waste heat boilers, are discussed in Chapter 9.

Completely satisfactory adaptations of boilers for use as afterburners are not common. All aspects of operation should be thoroughly evaluated before this method of air pollution control is used. The primary function of a boiler is to supply steam or hot water, and whenever its use as a control device conflicts with this function, one or both of its purposes will suffer. Some advantages and disadvantages of boilers used as afterburners are shown in Table 54.

CONDITIONS FOR USE

The determination to use a boiler as an afterburner demands that the following conditions exist:

1. The air contaminants to be controlled must be almost wholly combustible since a boiler