

Check Sheet

Company Name: MONSANTO CHEMICAL
Permit Number: ~~AC 17-104180~~ AC 17-104180
PSD Number: _____
Permit Engineer: _____

Application:

- Initial Application
- Incompleteness Letters
- Responses
- Waiver of Department Action
- Department Response
- Other

Cross References:

-
-
-

nylon polymerization oven/incinerator

Intent:

- Intent to Issue
- Notice of Intent to Issue
- Technical Evaluation
- BACT or LAER Determination
- Unsigned Permit

Correspondence with:

- EPA
- Park Services
- Other
- Proof of Publication
 - Petitions - (Related to extensions, hearings, etc.)
 - Waiver of Department Action
 - Other

Final

Determination:

- Final Determination
- Signed Permit
- BACT or LAER Determination
- Other

Post Permit Correspondence:

- Extensions/Amendments/Modifications
- Other

P 408 533 327

RECEIPT FOR CERTIFIED MAIL

NO INSURANCE COVERAGE PROVIDED—
NOT FOR INTERNATIONAL MAIL

(See Reverse)

Sent to Mr. R. L. Monty	
Street and No.	
P.O., State and ZIP Code	
Postage	\$
Certified Fee	
Special Delivery Fee	
Restricted Delivery Fee	
Return Receipt Showing to whom and Date Delivered	
Return Receipt Showing to whom, Date, and Address of Delivery	
TOTAL Postage and Fees	\$
Postmark or Date 11/15/85	

PS Form 3800, Feb. 1982

PS Form 3811, July 1983

SENDER: Complete items 1, 2, 3 and 4.

Put your address in the "RETURN TO" space on the reverse side. Failure to do this will prevent this card from being returned to you. The return receipt fee will provide you the name of the person delivered to and the date of delivery. For additional fees the following services are available. Consult postmaster for fees and check box(es) for service(s) requested.

1. Show to whom, date and address of delivery.
2. Restricted Delivery.

3. Article Addressed to:
Mr. R. L. Monty
Monsanto Company
P. O. Box 12830
Pensacola, FL 32575

4. Type of Service:	Article Number
<input type="checkbox"/> Registered <input type="checkbox"/> Insured <input checked="" type="checkbox"/> Certified <input type="checkbox"/> COD <input type="checkbox"/> Express Mail	P 408 533 327

Always obtain signature of addressee or agent and **DATE DELIVERED.**

5. Signature — Addressee
X

6. Signature — Agent
X *Clayton Rudolph*

7. Date of Delivery
11-15-85

8. Addressee's Address (ONLY if requested and fee paid)

DOMESTIC RETURN RECEIPT

STATE OF FLORIDA
DEPARTMENT OF ENVIRONMENTAL REGULATION

TWIN TOWERS OFFICE BUILDING
2600 BLAIR STONE ROAD
TALLAHASSEE, FLORIDA 32301-8241



BOB GRAHAM
GOVERNOR
VICTORIA J. TSCHINKEL
SECRETARY

STATE OF FLORIDA
DEPARTMENT OF ENVIRONMENTAL REGULATION
NOTICE OF PERMIT

Mr. R. L. Monty
Superintendent, Environmental Health
and Safety
Monsanto Company
Post Office Box 12830
Pensacola, Florida 32575

November 13, 1985

Enclosed is Permit Number AC 17-104180 to Monsanto Company which authorizes the construction of a nylon polymerization equipment incinerator at the company's existing facility in Pensacola, Escambia County, Florida. This permit is issued pursuant to Section 403, Florida Statutes.

Any Party to this permit has the right to seek judicial review of the permit pursuant to Section 120.68, Florida Statutes, by the filing of a Notice of Appeal pursuant to Rule 9.110, Florida Rules of Appellate Procedure, with the clerk of the Department in the Office of General Counsel, 2600 Blair Stone Road, Tallahassee, Florida 32301; and by filing a copy of the Notice of Appeal accompanied by the applicable filing fees with the appropriate District Court of Appeal. The Notice of Appeal must be filed within 30 days from the date this permit is filed with the clerk of the Department.

Sincerely,

C. H. Fancy, P.E.
Deputy Chief
Bureau of Air Quality
Management

Enclosure

cc: Bruce P. McLeod
J. G. Wiley
T. W. Moody

CERTIFICATION

This is to certify that the foregoing Notice of Permit and all copies requested were mailed before the close of business on November 15, 1985.

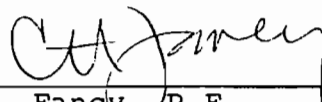

C. H. Fancy, P.E.
Deputy Chief
Bureau of Air Quality
Management
2600 Blair Stone Road
Tallahassee, Florida 32301

FILING AND ACKNOWLEDGEMENT
FILED, on this date, pursuant to
§120.52(9), Florida Statutes, with
the designated Department Clerk,
receipt of which is hereby
acknowledged.

Patricia G. Adams Nov. 15, 1985
Clerk Date

Final Determination

Monsanto Company
Pensacola, Florida
Escambia County

Permit Number
AC 17-104180

Florida Department of Environmental Regulation
Bureau of Air Quality Management
Central Air Permitting

November 1, 1985

Final Determination

Monsanto Company's application for a permit to construct a nylon polymerization equipment oven/incinerator at the company's existing facility in Escambia County, Florida, has been reviewed by the Bureau of Air Quality Management.

Public Notice of the department's Intent to Issue the construction permit was published in the Pensacola News Journal on September 18, 1985.

Copies of the preliminary determination have been available for public inspection at the department's Northwest District office in Pensacola and the Bureau of Air Quality Management office in Tallahassee.

No comments were received as a result of the public notice period.

The final action of the department will be to issue the permit as noticed during the public notice period.

STATE OF FLORIDA
DEPARTMENT OF ENVIRONMENTAL REGULATION

TWIN TOWERS OFFICE BUILDING
2600 BLAIR STONE ROAD
TALLAHASSEE, FLORIDA 32301-8241

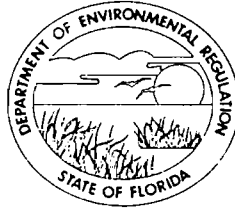

BOB GRAHAM
GOVERNOR
VICTORIA J. TSCHINKEL
SECRETARY

PERMITTEE:
Monsanto Company
P. O. Box 12830
Pensacola, Florida 32575

Permit Number: AC 17-104180
Expiration Date: October 1, 1986
County: Escambia
Latitude/Longitude: 30° 35' 59" N/
87° 14' 50" W
Project: Nylon Polymerization
Equipment Incinerator

This permit is issued under the provisions of Chapter 403, Florida Statutes, and Florida Administrative Code Rule(s) 17-2 and 17-4. The above named permittee is hereby authorized to perform the work or operate the facility shown on the application and approved drawing(s), plans, and other documents attached hereto or on file with the department and made a part hereof and specifically described as follows:

For the construction of a 30 pound per hour (maximum) nylon polymerization equipment incinerator at the existing facility located in Escambia County, north of Pensacola, Florida at the intersection of State Roads 292 and 297.

Construction shall be in accordance with the permit application and plan, documents, amendments, and drawings submitted, except as noted on pages 5 and 6 of the Specific Conditions.

Attachments are as follows:

1. Application to construct air pollution sources, DER Form 17-1.202(1), which was received on May 16, 1985, by FDER Bureau of Air Quality Management.
2. C. H. Fancy's letter dated May 31, 1985.
3. B. P. McLeod's letter with attachments dated July 2, 1985.

PERMITTEE:
Monsanto Company

Permit Number: AC 17-104180
Expiration Date: October 1, 1986

GENERAL CONDITIONS:

1. The terms, conditions, requirements, limitations, and restrictions set forth herein are "Permit Conditions" and as such are binding upon the permittee and enforceable pursuant to the authority of Sections 403.161, 403.727, or 403.859 through 403.861, Florida Statutes. The permittee is hereby placed on notice that the department will review this permit periodically and may initiate enforcement action for any violation of the "Permit Conditions" by the permittee, its agents, employees, servants or representatives.

2. This permit is valid only for the specific processes and operations applied for and indicated in the approved drawings or exhibits. Any unauthorized deviation from the approved drawings, exhibits, specifications, or conditions of this permit may constitute grounds for revocation and enforcement action by the department.

3. As provided in Subsections 403.087(6) and 403.722(5), Florida Statutes, the issuance of this permit does not convey any vested rights or any exclusive privileges. Nor does it authorize any injury to public or private property or any invasion of personal rights, nor any infringement of federal, state or local laws or regulations. This permit does not constitute a waiver of or approval of any other department permit that may be required for other aspects of the total project which are not addressed in the permit.

4. This permit conveys no title to land or water, does not constitute state recognition or acknowledgement of title, and does not constitute authority for the use of submerged lands unless herein provided and the necessary title or leasehold interests have been obtained from the state. Only the Trustees of the Internal Improvement Trust Fund may express state opinion as to title.

5. This permit does not relieve the permittee from liability for harm or injury to human health or welfare, animal, plant or aquatic life or property and penalties therefore caused by the construction or operation of this permitted source, nor does it allow the permittee to cause pollution in contravention of Florida Statutes and department rules, unless specifically authorized by an order from the department.

PERMITTEE:
Monsanto Company

Permit Number: AC 17-104180
Expiration Date: October 1, 1986

GENERAL CONDITIONS:

6. The permittee shall at all times properly operate and maintain the facility and systems of treatment and control (and related appurtenances) that are installed or used by the permittee to achieve compliance with the conditions of this permit, as required by department rules. This provision includes the operation of backup or auxiliary facilities or similar systems when necessary to achieve compliance with the conditions of the permit and when required by department rules.

7. The permittee, by accepting this permit, specifically agrees to allow authorized department personnel, upon presentation of credentials or other documents as may be required by law, access to the premises, at reasonable times, where the permitted activity is located or conducted for the purpose of:

- a. Having access to and copying any records that must be kept under the conditions of the permit;
- b. Inspecting the facility, equipment, practices, or operations regulated or required under this permit; and
- c. Sampling or monitoring any substances or parameters at any location reasonably necessary to assure compliance with this permit or department rules.

Reasonable time may depend on the nature of the concern being investigated.

8. If, for any reason, the permittee does not comply with or will be unable to comply with any condition or limitation specified in this permit, the permittee shall immediately notify and provide the department with the following information:

- a. a description of and cause of non-compliance; and
- b. the period of noncompliance, including exact dates and times; or, if not corrected, the anticipated time the noncompliance is expected to continue, and steps being taken to reduce, eliminate, and prevent recurrence of the noncompliance.

PERMITTEE:
Monsanto Company

Permit Number: AC 17-104180
Expiration Date: October 1, 1986

GENERAL CONDITIONS:

The permittee shall be responsible for any and all damages which may result and may be subject to enforcement action by the department for penalties or revocation of this permit.

9. In accepting this permit, the permittee understands and agrees that all records, notes, monitoring data and other information relating to the construction or operation of this permitted source, which are submitted to the department, may be used by the department as evidence in any enforcement case arising under the Florida Statutes or department rules, except where such use is proscribed by Sections 403.73 and 403.111, Florida Statutes.

10. The permittee agrees to comply with changes in department rules and Florida Statutes after a reasonable time for compliance, provided however, the permittee does not waive any other rights granted by Florida Statutes or department rules.

11. This permit is transferable only upon department approval in accordance with Florida Administrative Code Rules 17-4.12 and 17-30.30, as applicable. The permittee shall be liable for any non-compliance of the permitted activity until the transfer is approved by the department.

12. This permit is required to be kept at the work site of the permitted activity during the entire period of construction or operation.

13. This permit also constitutes:

- () Determination of Best Available Control Technology (BACT)
- () Determination of Prevention of Significant Deterioration (PSD).
- () Compliance with New Source Performance Standards.

14. The permittee shall comply with the following monitoring and record keeping requirements:

- a. Upon request, the permittee shall furnish all records and plans required under department rules. The retention period for all records will be extended automatically, unless otherwise stipulated by the department, during the course of any unresolved enforcement action.

PERMITTEE:
Monsanto Company

Permit Number: AC 17-104180
Expiration Date: October 1, 1986

GENERAL CONDITIONS:

- b. The permittee shall retain at the facility or other location designated by this permit records of all monitoring information (including all calibration and maintenance records and all original strip chart recordings for continuous monitoring instrumentation), copies of all reports required by this permit, and records of all data used to complete the application for this permit. The time period of retention shall be at least three years from the date of the sample, measurement, report or application unless otherwise specified by department rule.
- c. Records of monitoring information shall include:
 - the date, exact place, and time of sampling or measurements;
 - the person responsible for performing the sampling or measurements;
 - the date(s) analyses were performed;
 - the person responsible for performing the analyses;
 - the analytical techniques or methods used; and
 - the results of such analyses.

15. When requested by the department, the permittee shall within a reasonable time furnish any information required by law which is needed to determine compliance with the permit. If the permittee becomes aware that relevant facts were not submitted or were incorrect in the permit application or in any report to the department, such facts or information shall be submitted or corrected promptly.

SPECIFIC CONDITIONS:

1. Only nylon is to be pyrolyzed in this incinerator.
2. The annual amount of nylon pyrolyzed shall not exceed 20,000 pounds.
3. Continuous operation of the incinerator is approved (8,760 hours annually).
4. Visible emissions (VE) shall not exceed 5% opacity during any 6 minute period. Compliance with this standard shall be determined by EPA Method 9, Visual Determination of the Opacity of Emissions from

PERMITTEE:
Monsanto Company

Permit Number: AC 17-104180
Expiration Date: October 1, 1986

SPECIFIC CONDITIONS:

Stationary Sources as described in Appendix A of 40 CFR 60. If VE exceed 5% opacity, Method 5, Determination of Particulate Emissions from Stationary Sources, shall be requested by the Department. The district office shall be notified 15 days prior to test.

5. Objectionable odors shall not be allowed on off-plant property.

6. Afterburner temperature must exceed 1400° F anytime furnace is in operation and the temperature shall be recorded a minimum of once per hour of operation.

7. Construction shall reasonably conform to the plans submitted in the application. The applicant shall report any delay in construction and completion of this project to the Department's Northwest District office.

8. The permittee shall submit a complete application for a permit to operate this incinerator, which must include an emissions test report, to the DER Northwest District office at least 90 days prior to the expiration date of this construction permit. The permittee may continue to operate this source, if it is in compliance with all conditions of this construction permit, until its expiration date.

9. Upon obtaining a permit to operate, the permittee will be required to submit annual operation reports to the DER Northwest District office which shall include as a minimum, the actual hours of operation, total tonnage of nylon material input, and recorded temperatures of the afterburner and an emissions test for particulates as outlined in Specific Condition No. 4.

Issued this 5th day of Nov,
1985

STATE OF FLORIDA DEPARTMENT
OF ENVIRONMENTAL REGULATION

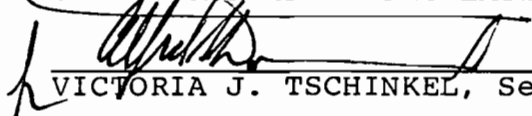
VICTORIA J. TSCHINKEL, Secretary

_____ pages attached.

State of Florida
DEPARTMENT OF ENVIRONMENTAL REGULATION

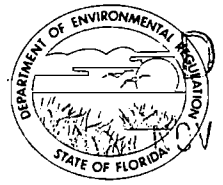

ER
6 1985

Interoffice Memorandum

BAQM

FOR ROUTING TO OTHER THAN THE ADDRESSEE

To: _____ LOCTN: _____
To: _____ LOCTN: _____
To: _____ LOCTN: _____
FROM: _____ DATE: _____

TO: Victoria J. Tschinkel
FROM: Clair Fancy *Clair Fancy*
DATE: November 1, 1985
SUBJ: Approval of Attached Air Construction Permit

Attached for your approval and signature is one Air Construction Permit to Monsanto Company to construct a nylon polymerization equipment incinerator at the company's existing facility in Pensacola, Escambia County, Florida.

Day 90, after which the permit would be issued by default, is November 7, 1985

The Bureau recommends your approval and signature.

CF/pa

Attachment

Monsanto

MONSANTO FIBERS & INTERMEDIATES COMPANY
P. O. Box 12830
Pensacola, Florida 32575
Phone: (904) 968-7000

September 23, 1984

Mr. C. H. Fancy, P.E.
Deputy Chief
Bureau of Air Quality Management
Department of Environmental Regulation
2600 Blair Stone Road
Tallahassee, Florida 32301-8141

Dear Mr. Fancy:

Attached is proof of publication of the public notice for construction permit AC17-104180, Nylon Polymerization Equipment Incinerator.

Please issue this construction permit as soon as possible.

Sincerely,



B. P. McLeod, Specialist
Environmental Control

Attachment

cc: J. G. Wiley, Monsanto, Pensacola

140.BPM

DER
SEP 25 1985
BAQM

PENSACOLA
News Journal

PUBLISHED DAILY
PENSACOLA, ESCAMBIA COUNTY, FLORIDA

State of Florida,
County of Escambia.

Before the undersigned authority personally appeared

J. Diane Deal

who on oath says that she is Legal Advertising Supervisor of the Pensacola News Journal, a daily newspaper published at Pensacola in Escambia County, Florida; with general circulation in Escambia, Santa Rosa, Okaloosa and Walton Counties that the attached copy of advertisement, being a NOTICE in the matter of

DER.

_____ in the _____ Court,

was published in said newspaper in the issues of Sept 18, 1985

Affiant further say that the said The Pensacola News Journal is a newspaper published at Pensacola, in said Escambia County, Florida, and that the said newspaper has heretofore been continuously published in said Escambia County, Florida, each day and has been entered as second class mail matter at the post office in Pensacola, in said Escambia County, Florida, for a period of one year next preceding the first publication of the attached copy of advertisement; and affiant further says that he has neither paid nor promised any person, firm or corporation any discount, rebate, commission or refund for the purpose of securing this advertisement for publication in the said newspaper.

J. Diane Deal

Sworn to and subscribed before me this 18th

day of Sept, 1985

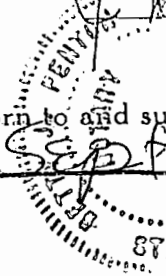

Duffy J. Taylor

NOTARY PUBLIC.

My Commission Expires Oct. 16, 1987

State of Florida
Department of
Environmental Regulation
Notice of
Proposed Agency Action
on Permit Application

The Department of Environmental Regulation gives notice of its intent to issue a permit to Monsanto Company to construct a nylon polymerization equipment oven/incinerator at the applicant's existing facility in Escambia County. This facility is located at the intersection of State Roads 292 and 297 which is north of the city of Pensacola, Florida.

The source consists of an oven with afterburner which operate dependently, inasmuch they are considered an incinerator, whose designed purpose is to remove nylon from polymerization equipment. Operation of this facility will result in no more than 0.025 tons per year (TPY) of particulate emissions and 4.4 TPY of NOx emissions. These emissions will have a minimal effect on the ambient air quality near the facility. A BACT was not required for this project.

Persons whose substantial interests are affected by the Department's proposed permitting decision may petition for an administrative proceeding (hearing) in accordance with Section 120.57, Florida Statutes. The petition must conform to the requirements of Chapters 17-103 and 28-5, Florida Administrative Code, and must be filed (received) in the Office of General Counsel of the Department at 2600 Blair Stone Road, Twin Towers Office Building, Tallahassee, Florida 32301, within fourteen (14) days of publication of this notice. Failure to file a request for hearing within this time period constitutes a waiver of any right such person may have to request an administrative determination (hearing) under Section 120.57, Florida Statutes.

If a petition is filed, the administrative hearing process is designed to formulate agency action. Accordingly, the Department's final action may be different from the proposed agency action. Therefore, persons who may not wish to file a petition may wish to intervene in the proceeding. A petition for intervention must be filed pursuant to Model Rule 28-5.207, Florida Administrative Code, at least five (5) days before the final hearing and be filed with the hearing officer if one has been assigned at the Division of Administrative Hearings, Department of Administration, 2009 Apalachee Parkway, Tallahassee, Florida 32301. If no hearing officer has been assigned, the petition is to be filed with the department's Office of General Counsel, 2600 Blair Stone Road, Tallahassee, Florida 32301. Failure to petition to intervene within the allowed time frame constitutes a waiver of any right such person has to request a hearing under Section 120.57, Florida Statutes.

The application is available for public inspection during normal business hours, 8:00 a.m. to 5:00 p.m., Monday through Friday, except legal holidays, at:

Dept. of
Environmental Regulation
Northwest District
106 Governmental Center
Pensacola, Florida 32501

Dept. of
Environmental Regulation
Bureau of
Air Quality Management
2600 Blair Stone Road
Tallahassee, Florida 32301

Any person may send written comments on the proposed action to Mr. Bill Thomas at the department's Tallahassee address. All comments mailed within 30 days of the publication of this notice will be considered in the department's final determination.

Legal No. 30316 1-T Sept. 18, 1985

P 085 152 651

RECEIPT FOR CERTIFIED MAIL

NO INSURANCE COVERAGE PROVIDED
NOT FOR INTERNATIONAL MAIL

(See Reverse)

U.S.G.P.O. 1984-448-014

PS Form 3800, Feb. 1982

Sent to Mr. R. L. Monty	
Street and No.	
P.O., State and ZIP Code	
Postage	\$
Certified Fee	
Special Delivery Fee	
Restricted Delivery Fee	
Return Receipt Showing to whom and Date Delivered	
Return receipt showing to whom, Date, and Address of Delivery	
TOTAL Postage and Fees	\$
Postmark or Date 9/10/85	

PS Form 3811, July 1983

SENDER: Complete items 1, 2, 3 and 4.
Put your address in the "RETURN TO" space on the reverse side. Failure to do this will prevent this card from being returned to you. The return receipt fee will provide you the name of the person delivered to and the date of delivery. For additional fees the following services are available. Consult postmaster for fees and check box(es) for service(s) requested.

1. Show to whom, date and address of delivery.
2. Restricted Delivery.

3. Article Addressed to:
Mr. R. L. Monty
Monsanto Company
P. O. Box 12830
Pensacola, FL 32575

4. Type of Service: <input type="checkbox"/> Registered <input checked="" type="checkbox"/> Certified <input type="checkbox"/> Express Mail	Article Number P 085 152 651 <input type="checkbox"/> Insured <input type="checkbox"/> COD
--	---

Always obtain signature of addressee or agent and **DATE DELIVERED.**

5. Signature - Addressee
X

6. Signature - Agent
X *Cliff Leide*

7. Date of Delivery

8. Addressee's Address (ONLY if requested and fee paid)

DOMESTIC RETURN RECEIPT



STATE OF FLORIDA
DEPARTMENT OF ENVIRONMENTAL REGULATION

TWIN TOWERS OFFICE BUILDING
2600 BLAIR STONE ROAD
TALLAHASSEE, FLORIDA 32301-8241

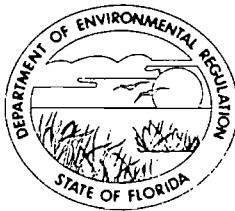

BOB GRAHAM
GOVERNOR
VICTORIA J. TSCHINKEL
SECRETARY

September 9, 1985

CERTIFIED MAIL-RETURN RECEIPT REQUESTED

Mr. R. L. Monty
Superintendent, Environmental Health
and Safety
Monsanto Company
Post Office Box 12830
Pensacola, Florida 32575

Dear Mr. Monty:

Attached is one copy of the Technical Evaluation and Preliminary Determination, and proposed permit to construct a nylon polymerization equipment facility at your existing facility in Pensacola, Escambia County, Florida.

Before final action can be taken on your draft permit, you are required by Florida Administrative Code Rule 17-103.150 to publish the attached Notice of Proposed Agency Action in the legal advertising section of a newspaper of general circulation in Escambia County no later than fourteen days after receipt of this letter. The department must be provided with proof of publication within seven days of the date the notice is published. Failure to publish the notice may be grounds for denial of the permit.

Please submit, in writing, any comments which you wish to have considered concerning the department's proposed action to Mr. Bill Thomas of the Bureau of Air Quality Management.

Sincerely,

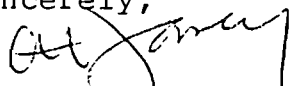
C. H. Fancy, P.E.
Deputy Chief
Bureau of Air Quality
Management

CHF/pa

Attachments

cc: Bruce P. McLeod
J. G. Wiley
T. W. Moody

State of Florida
Department of Environmental Regulation
Notice of Proposed Agency Action
on Permit Application

The Department of Environmental Regulation gives notice of its intent to issue a permit to Monsanto Company to construct a nylon polymerization equipment oven/incinerator at the applicant's existing facility in Escambia County. This facility is located at the intersection of State Roads 292 and 297 which is north of the city of Pensacola, Florida.

The source consists of an oven with afterburner which operate dependently, inasmuch they are considered an incinerator, whose design purpose is to remove nylon from polymerization equipment. Operation of this facility will result in no more than 0.025 tons per year (TPY) of particulate emissions and 4.4 TPY of NO_x emissions. These emissions will have a minimal effect on the ambient air quality near the facility. A BACT was not required for this project.

Persons whose substantial interests are affected by the Department's proposed permitting decision may petition for an administrative proceeding (hearing) in accordance with Section 120.57, Florida Statutes. The petition must conform to the requirements of Chapters 17-103 and 28-5, Florida Administrative Code, and must be filed (received) in the Office of General Counsel of the Department at 2600 Blair Stone Road, Twin Towers Office Building, Tallahassee, Florida 32301, within fourteen (14) days of publication of this notice. Failure to file a request for hearing within this time period constitutes a waiver of any right such person may have to request an administrative determination (hearing) under Section 120.57, Florida Statutes.

If a petition is filed, the administrative hearing process is designed to formulate agency action. Accordingly, the Department's final action may be different from the proposed agency action. Therefore, persons who may not wish to file a petition may wish to intervene in the proceeding. A petition for intervention must be filed pursuant to Model Rule 28-5.207, Florida Administrative Code, at least five (5) days before the final hearing and be filed with the hearing officer if one has been assigned at the Division of Administrative Hearings, Department of Administration, 2009, Apalachee Parkway, Tallahassee, Florida 32301. If no hearing officer has been assigned, the petition is to be filed with the department's Office of General Counsel, 2600 Blair Stone Road, Tallahassee, Florida 32301. Failure to petition to intervene within the allowed time frame constitutes a waiver of any right such person has to request a hearing under Section 120.57, Florida Statutes.

The application is available for public inspection during normal business hours, 8:00 a.m. to 5:00 p.m., Monday through Friday, except legal holidays, at:

Dept. of Environmental Regulation
Northwest District
106 Governmental Center
Pensacola, Florida 32501

Dept. of Environmental Regulation
Bureau of Air Quality Management
2600 Blair Stone Road
Tallahassee, Florida 32301

Any person may send written comments on the proposed action to Mr. Bill Thomas at the department's Tallahassee address. All comments mailed within 30 days of the publication of this notice will be considered in the department's final determination.

BEFORE THE STATE OF FLORIDA
DEPARTMENT OF ENVIRONMENTAL REGULATION

In the Matter of an)
Application for Permit by:)
)
Monsanto Company) DER File No. AC 17-104180
Post Office Box 12830)
Pensacola, Florida 32575)

INTENT TO ISSUE

The Department of Environmental Regulation hereby gives notice of its Intent to Issue, and proposed order of issuance for, a permit pursuant to Chapter 403, Florida Statutes, for the proposed project as detailed in the application specified above. The Department is issuing this Intent to Issue for the reasons stated in the attached Technical Evaluation and Preliminary Determination.

The applicant, The Monsanto Company, applied on May 16, 1985, to the Department of Environmental Regulation for a permit to construct a nylon polymerization equipment incinerator. This is an auxiliary operation to the main polymerization incinerator located at the applicant's existing facility in Pensacola, Escambia County, Florida.

The Department has permitting jurisdiction under Chapter 403, Florida Statutes and Florida Administrative Code Rules 17-2 and 17-4. The project is not exempt from permitting procedures. The applicant was officially notified by the Department that an air construction permit was required for the proposed work.

This intent to issue shall be placed before the Secretary for final action unless an appropriate petition for a hearing pursuant to the provisions of Section 120.57, Florida Statutes, is filed within fourteen (14) days from receipt of this letter or

publication of the public notice (copy attached) required pursuant to Rule 17-103.150, Florida Administrative Code, whichever occurs first. The petition must comply with the requirements of Section 17-103.155 and Rule 28-5.201, Florida Administrative Code (copy attached) and be filed pursuant to Rule 17-103.155(1) in the Office of General Counsel of the Department of Environmental Regulation at 2600 Blair Stone Road, Tallahassee, Florida 32301.

Petitions which are not filed in accordance with the above provisions are subject to dismissal by the Department. In the event a formal hearing is conducted pursuant to Section 120.57(1), all parties shall have an opportunity to respond, to present evidence and argument on all issues involved, to conduct cross-examination of witnesses and submit rebuttal evidence, to submit proposed findings of facts and orders, to file exceptions to any order or hearing officer's recommended order, and to be represented by counsel. If an informal hearing is requested, the agency, in accordance with its rules of procedure, will provide affected persons or parties or their counsel an opportunity, at a convenient time and place, to present to the agency or hearing officer, written or oral evidence in opposition to the agency's action or refusal to act, or a written statement challenging the grounds upon which the agency has chosen to justify its action or inaction, pursuant to Section 120.57(2), Florida Statutes.

If a petition is filed, the administrative hearing process is designed to formulate agency action. Accordingly, the Department's final action may be different from the proposed agency action. Therefore, persons who may not wish to file a petition, may wish to intervene in the proceeding. A petition for intervention must be filed pursuant to Model Rule 28-5.207 at least five (5) days before the final hearing and be filed with the hearing officer if one has been assigned at the Division of

Administrative Hearings, 2009 Apalachee Parkway, Tallahassee, Florida 32301. If no hearing officer has been assigned, the petition is to be filed with the Department's Office of General Counsel, 2600 Blair Stone Road, Tallahassee, Florida 32301. Failure to petition to intervene within the allowed time frame constitutes a waiver of any right such person has to request a hearing under Section 120.57, Florida Statutes.

Executed the 10 day of September, 1985, in Tallahassee, Florida.

STATE OF FLORIDA DEPARTMENT
OF ENVIRONMENTAL REGULATION

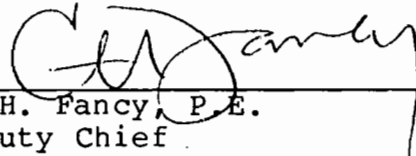

C. H. Fancy, P.E.
Deputy Chief
Bureau of Air Quality
Management

Copies furnished to:

T. W. Moody, NW District
J. G. Wiley, Monsanto Co.
B. P. McLeod, Monsanto Co.

CERTIFICATION

This is to certify that the foregoing Intent to Issue and all copies were mailed before the close of business on Sept. 10, 1985.

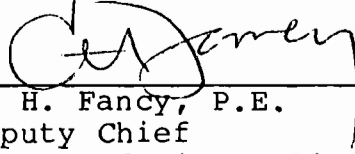

C. H. Fancy, P.E.
Deputy Chief
Bureau of Air Quality
Management
2600 Blair Stone Road
Tallahassee, Florida 32301

FILING AND ACKNOWLEDGEMENT
FILED, on this date, pursuant to
§120.52(9), Florida Statutes, with
the designated Department Clerk,
receipt of which is hereby acknow-
ledged.

Patricia B. Adams Sept. 10, 1985
Clerk Date

RULES OF THE ADMINISTRATIVE COMMISSION
MODEL RULES OF PROCEDURE
CHAPTER 28-5
DECISIONS DETERMINING SUBSTANTIAL INTERESTS

28-5.15 Requests for Formal and Informal Proceedings

- (1) Requests for proceedings shall be made by petition to the agency involved. Each petition shall be printed typewritten or otherwise duplicated in legible form on white paper of standard legal size. Unless printed, the impression shall be on one side of the paper only and lines shall be double spaced and indented.
- (2) All petitions filed under these rules should contain:
 - (a) The name and address of each agency affected and each agency's file or identification number, if known;
 - (b) The name and address of the petitioner or petitioners;
 - (c) All disputed issues of material fact. If there are none, the petition must so indicate;
 - (d) A concise statement of the ultimate facts alleged, and the rules, regulations and constitutional provisions which entitle the petitioner to relief;
 - (e) A statement summarizing any informal action taken to resolve the issues, and the results of that action;
 - (f) A demand for the relief to which the petitioner deems himself entitled; and
 - (g) Such other information which the petitioner contends is material.

Technical Evaluation
and
Preliminary Determination

Monsanto Company
Pensacola, Florida
Escambia County

Permit Number
AC 17-104180

Florida Department of Environmental Regulation
Bureau of Air Quality Management
Central Air Permitting

September 9, 1985

Table of Contents

Notice of Proposed Agency Action

I.	Project Description.....	1
	A. Applicant.....	1
	B. Project and Location.....	1
	C. Process.....	1
II.	Rule Applicability.....	1&2
	A. State and Federal Regulations.....	1&2
III.	Technical Evaluation.....	3&4
	A. Estimated Emissions.....	3&4
	B. Emissions Summary.....	4
IV.	Conclusion.....	4

Appendix

- A. Application
- B. Draft State Permit

I. PROJECT DESCRIPTION

A. Applicant

Monsanto Company
P. O. Box 12830
Pensacola, Florida 32575

B. Project and Location

The company had delivered on May 16, 1985, an application to construct a controlled pyrolysis cleaning furnace with afterburner (an incinerator). Industrial source codes are: SIC 4953; SCC 5-03-001-01 and 5-03-900-06.

This incinerator is to be located at the existing site of the Fibers and Intermediates Company in Escambia County. The facility is just north of Pensacola, Florida at the intersection of State Roads 292 and 297; UTM coordinates: Zone 16, 479.96 km E and 3384.3 km N.

C. Process

The incinerator will be used to clean process equipment of nylon by melting/burning. A batch process is to be used whereby up to 30 lb/hr of nylon may be removed. The pieces of equipment to be cleaned are placed in the cleaning oven which operates at or about 900° F. While in the oven a reducing condition exists which allows the nylon to melt rather than burn. Some of the nylon in the oven does sublime leaving the furnace into the afterburner.

The afterburner is designed to operate at or about 1400° F and receives all exhaust gases from the furnace. The afterburner exists as an oxidizing environment which burns the combustible gases from the furnace. The predominant product of the afterburner is CO₂ and water vapor. Small amounts of NO_x and particulate matter are produced and vented to the atmosphere.

The primary furnace is not operable unless the afterburner is at full operational ready. Both the primary furnace and secondary afterburner are fired on natural gas.

II. RULE APPLICABILITY

A. State Regulations

The proposed project; construction of an incinerator with a charging rate of less than 50 TPD, is subject to pre-construction review under the provisions of Chapter 403, Florida Statutes, and 17-2 and 17-4, Florida Administrative Code (FAC).

The facility is situated in an area designated unclassifiable for sulfur dioxide (Rule 17-2, 430, FAC) and as an attainment area for all other criteria pollutants (Rule 17-2.420, FAC).

The plant is a major source of volatile organic compounds (Rule 17-2.100(99), FAC) as total emissions exceed 100 TPY. The proposed source will emit less than the significant emission rate of any criteria pollutant listed in Table 500-2.

The facility is exempt from the Prevention of Significant Deterioration regulations because the modifications to the plant will not result in a significant net emission increase of any criteria pollutant (Rule 17-2.500(2)(d)4.a.(ii), FAC).

As the area in which the facility is located is designated attainment for particulate matter and volatile organic compounds, it is not subject to new source review for nonattainment areas (Rule 17-2.510(2)(a)1., FAC).

However, the facility is subject to Rule 17-2.520, FAC; which pertains to sources not subject to PSD or nonattainment requirements. Control of emissions shall be based on Rule 17-2.600(1)(a), FAC.

III. TECHNICAL EVALUATION

A. Estimated Emissions

The proposed source will operate similar to a starved-air incinerator equipped with an afterburner.

The incinerator is of two stage design with the primary chamber (furnace) inoperable without the secondary chamber (afterburner) being at stand-by. The furnace, which is charged in the batch-feed mode can process up to 200 lbs of nylon during one cycle. This nylon is processed at a rate up to 30 lbs/hr. The nylon fouled process equipment is placed in the furnace which operates as a recovery step whereby the reducing atmosphere inhibits combustion of volatiles while promoting a melt phase of the nylon which is collected below in a cooling chamber. The primary chamber (furnace) is operated at 900° F and is fired on natural gas.

Smoke and a volatile fraction of the original nylon charge are produced in the furnace which are then routed to the secondary chamber (afterburner). The afterburner is designed to operate on natural gas at 1400° F. This temperature and an oxidizing presence allow for burning of the combustible products from the furnace stage. A retention time of one-half second is an operation parameter.

The effluent from the stack is calculated to be: Particulate matter, carbon dioxide, NO_x, and water vapor. This is discharged to the atmosphere via a 30 foot high, 1 foot diameter, smoke stack.

B. Emissions Summary

Emissions were calculated assuming a worst case scenario where all nitrogen is converted to NO_x and particulate matter is twice that actually estimated. Water vapor and CO₂ are not estimated.

Pollutant	Summary
Particulate Matter	0.012 lb/hr (0.25 TPY)
*Nitrogen Oxides	12.3 lb/hr (4.4 TPY)

*Includes conversion of the nitrogen in the natural gas to NO_x via combustion process.

IV. AMBIENT AIR IMPACT

When operated properly, the calculated emissions will not have a significant impact on the environment.

V. CONCLUSION

Based upon information contained in the application and subsequent communications with the Monsanto Company, the Department has concluded that the Company can construct and operate this proposed incinerator in compliance with all applicable air pollution control regulations. The Department proposes to issue a permit to construct said incinerator. The General and Specific Conditions listed in the proposed permit (find attached) will assure compliance of the incinerator with the Department's air pollution control regulations.

STATE OF FLORIDA
DEPARTMENT OF ENVIRONMENTAL REGULATION

TWIN TOWERS OFFICE BUILDING
2600 BLAIR STONE ROAD
TALLAHASSEE, FLORIDA 32301-8241

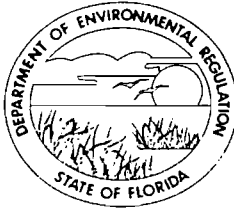

BOB GRAHAM
GOVERNOR
VICTORIA J. TSCHINKEL
SECRETARY

PERMITTEE:
Monsanto Company
P. O. Box 12830
Pensacola, Florida 32575

Permit Number: AC 17-104180
Expiration Date: October 1, 1986
County: Escambia
Latitude/Longitude: 30° 35' 59" N/
87° 14' 50" W
Project: Nylon Polymerization
Equipment Incinerator

This permit is issued under the provisions of Chapter 403, Florida Statutes, and Florida Administrative Code Rule(s) 17-2 and 17-4. The above named permittee is hereby authorized to perform the work or operate the facility shown on the application and approved drawing(s), plans, and other documents attached hereto or on file with the department and made a part hereof and specifically described as follows:

For the construction of a 30 pound per hour (maximum) nylon polymerization equipment incinerator at the existing facility located in Escambia County, north of Pensacola, Florida at the intersection of State Roads 292 and 297.

Construction shall be in accordance with the permit application and plan, documents, amendments, and drawings submitted, except as noted on pages 5 and 6 of the Specific Conditions.

Attachments are as follows:

1. Application to construct air pollution sources, DER Form 17-1.202(1), which was received on May 16, 1985, by FDER Bureau of Air Quality Management.
2. C. H. Fancy's letter dated May 31, 1985.
3. B. P. McLeod's letter with attachments dated July 2, 1985.

PERMITTEE:
Monsanto Company

Permit Number: AC 17-104180
Expiration Date: October 1, 1986

GENERAL CONDITIONS:

1. The terms, conditions, requirements, limitations, and restrictions set forth herein are "Permit Conditions" and as such are binding upon the permittee and enforceable pursuant to the authority of Sections 403.161, 403.727, or 403.859 through 403.861, Florida Statutes. The permittee is hereby placed on notice that the department will review this permit periodically and may initiate enforcement action for any violation of the "Permit Conditions" by the permittee, its agents, employees, servants or representatives.
2. This permit is valid only for the specific processes and operations applied for and indicated in the approved drawings or exhibits. Any unauthorized deviation from the approved drawings, exhibits, specifications, or conditions of this permit may constitute grounds for revocation and enforcement action by the department.
3. As provided in Subsections 403.087(6) and 403.722(5), Florida Statutes, the issuance of this permit does not convey any vested rights or any exclusive privileges. Nor does it authorize any injury to public or private property or any invasion of personal rights, nor any infringement of federal, state or local laws or regulations. This permit does not constitute a waiver of or approval of any other department permit that may be required for other aspects of the total project which are not addressed in the permit.
4. This permit conveys no title to land or water, does not constitute state recognition or acknowledgement of title, and does not constitute authority for the use of submerged lands unless herein provided and the necessary title or leasehold interests have been obtained from the state. Only the Trustees of the Internal Improvement Trust Fund may express state opinion as to title.
5. This permit does not relieve the permittee from liability for harm or injury to human health or welfare, animal, plant or aquatic life or property and penalties therefore caused by the construction or operation of this permitted source, nor does it allow the permittee to cause pollution in contravention of Florida Statutes and department rules, unless specifically authorized by an order from the department.

PERMITTEE:
Monsanto Company

Permit Number: AC 17-104180
Expiration Date: October 1, 1986

GENERAL CONDITIONS:

6. The permittee shall at all times properly operate and maintain the facility and systems of treatment and control (and related appurtenances) that are installed or used by the permittee to achieve compliance with the conditions of this permit, as required by department rules. This provision includes the operation of backup or auxiliary facilities or similar systems when necessary to achieve compliance with the conditions of the permit and when required by department rules.

7. The permittee, by accepting this permit, specifically agrees to allow authorized department personnel, upon presentation of credentials or other documents as may be required by law, access to the premises, at reasonable times, where the permitted activity is located or conducted for the purpose of:

- a. Having access to and copying any records that must be kept under the conditions of the permit;
- b. Inspecting the facility, equipment, practices, or operations regulated or required under this permit; and
- c. Sampling or monitoring any substances or parameters at any location reasonably necessary to assure compliance with this permit or department rules.

Reasonable time may depend on the nature of the concern being investigated.

8. If, for any reason, the permittee does not comply with or will be unable to comply with any condition or limitation specified in this permit, the permittee shall immediately notify and provide the department with the following information:

- a. a description of and cause of non-compliance; and
- b. the period of noncompliance, including exact dates and times; or, if not corrected, the anticipated time the noncompliance is expected to continue, and steps being taken to reduce, eliminate, and prevent recurrence of the noncompliance.

PERMITTEE:
Monsanto Company

Permit Number: AC 17-104180
Expiration Date: October 1, 1986

GENERAL CONDITIONS:

The permittee shall be responsible for any and all damages which may result and may be subject to enforcement action by the department for penalties or revocation of this permit.

9. In accepting this permit, the permittee understands and agrees that all records, notes, monitoring data and other information relating to the construction or operation of this permitted source, which are submitted to the department, may be used by the department as evidence in any enforcement case arising under the Florida Statutes or department rules, except where such use is proscribed by Sections 403.73 and 403.111, Florida Statutes.

10. The permittee agrees to comply with changes in department rules and Florida Statutes after a reasonable time for compliance, provided however, the permittee does not waive any other rights granted by Florida Statutes or department rules.

11. This permit is transferable only upon department approval in accordance with Florida Administrative Code Rules 17-4.12 and 17-30.30, as applicable. The permittee shall be liable for any non-compliance of the permitted activity until the transfer is approved by the department.

12. This permit is required to be kept at the work site of the permitted activity during the entire period of construction or operation.

13. This permit also constitutes:

- () Determination of Best Available Control Technology (BACT)
- () Determination of Prevention of Significant Deterioration (PSD).
- () Compliance with New Source Performance Standards.

14. The permittee shall comply with the following monitoring and record keeping requirements:

- a. Upon request, the permittee shall furnish all records and plans required under department rules. The retention period for all records will be extended automatically, unless otherwise stipulated by the department, during the course of any unresolved enforcement action.

PERMITTEE:
Monsanto Company

Permit Number: AC 17-104180
Expiration Date: October 1, 1986

GENERAL CONDITIONS:

- b. The permittee shall retain at the facility or other location designated by this permit records of all monitoring information (including all calibration and maintenance records and all original strip chart recordings for continuous monitoring instrumentation), copies of all reports required by this permit, and records of all data used to complete the application for this permit. The time period of retention shall be at least three years from the date of the sample, measurement, report or application unless otherwise specified by department rule.
- c. Records of monitoring information shall include:
 - the date, exact place, and time of sampling or measurements;
 - the person responsible for performing the sampling or measurements;
 - the date(s) analyses were performed;
 - the person responsible for performing the analyses;
 - the analytical techniques or methods used; and
 - the results of such analyses.

15. When requested by the department, the permittee shall within a reasonable time furnish any information required by law which is needed to determine compliance with the permit. If the permittee becomes aware that relevant facts were not submitted or were incorrect in the permit application or in any report to the department, such facts or information shall be submitted or corrected promptly.

SPECIFIC CONDITIONS:

1. Only nylon is to be pyrolyzed in this incinerator.
2. The annual amount of nylon pyrolyzed shall not exceed 20,000 pounds.
3. Continuous operation of the incinerator is approved (8,760 hours annually).
4. Visible emissions (VE) shall not exceed 5% opacity during any 6 minute period. Compliance with this standard shall be determined by EPA Method 9. Visual Determination of the Opacity of Emissions from

PERMITTEE:
Monsanto Company

Permit Number: AC 17-104180
Expiration Date: October 1, 1986

SPECIFIC CONDITIONS:

Stationary Sources as described in Appendix A of 40 CFR 60. If VE exceed 5% opacity, Method 5, Determination of Particulate Emissions from Stationary Sources shall be requested by the Department. The district office shall be notified 15 days prior to test.

5. Objectionable odors shall not be allowed on off-plant property.
6. Afterburner temperature must exceed 1400 °F anytime furnace is in operation and the temperature shall be recorded a minimum of once per hour of operation.
7. Construction shall reasonably conform to the plans submitted in the application. The applicant shall report any delay in construction and completion of this project to the Department Northwest District office.
8. The permittee shall submit a complete application for a permit to operate this incinerator; which must include an emissions test report to the FDER-NW District Office at least 90 days prior to the expiration date of this construction permit. The permittee may continue to operate this source, if it is in compliance with all conditions of this construction permit, until its expiration date.
9. Upon obtaining a permit to operate, the permittee will be required to submit annual operation reports to the FDER-NW District Office which shall include as a minimum, the actual hours of operation, total tonnage of nylon material input, and recorded temperatures of the afterburner and an emissions test for particulates as outlined in Specific Condition No. 4.

Issued this _____ day of _____,
19__.

STATE OF FLORIDA DEPARTMENT
OF ENVIRONMENTAL REGULATION

VICTORIA J. TSCHINKEL, Secretary

_____ pages attached.

Monsanto

MONSANTO FIBERS & INTERMEDIATES COMPANY
P. O. Box 12830
Pensacola, Florida 32575
Phone: (904) 968-7000

DEFERRED
JUL 12 1985
BAQM

July 2, 1985

Mr. M. G. Phillips
Department of Environmental Regulation
Twin Towers Office Building
2600 Blair Stone Road
Tallahassee, Florida 32301

Dear Mr. Phillips:

This transmittal is in response to the letter from C. H. Fancy to B. P. McLeod dated May 31, 1985. The item numbers of that letter have been addressed herein as follows:

5/31/85 LETTER
ITEM NUMBER

ENCLOSED RESPONSE

- | | |
|---|---|
| 1 | An amended section II-F, page numbered 3 of 5 is enclosed. |
| 2 | Completed section III-C is enclosed along with calculations 1 and 2. |
| 3 | Calculations 1 and 2 are attached for estimation of criteria pollutants. Supplement 1 addresses stack temperature/afterburner temperature control. Please discard Supplement 1 contained in the original transmittal and replace it with this corrected copy. |
| 4 | Supplement 1 presents an explanation of the afterburner temperature control scheme. Efficiency documentation is attached in Supplement 2. Please discard Supplements 1 and 2 contained in the original transmittal and replace them with these corrected copies. Page 7 of 12, attached, has also been reissued to reflect the above changes. |

Mr. M. G. Phillips
Page 2
July 3, 1985

If you have any questions, please call me at 904/968-8725.

Sincerely,

B.P. McLeod

B. P. McLeod, Specialist
Environmental Control

Attachments

cc: Mr. T. W. Moody, P.E., DER, Pensacola

DER
JUL 12 1985
BPM

DER-14.BPM

E. Requested permitted equipment operating time: hrs/day 24; days/wk 7; wks/yr 52;
if power plant, hrs/yr _____; if seasonal, describe: _____

F. If this is a new source or major modification, answer the following questions.
(Yes or No) Auxiliary facility to main facility at powerhouse (Permit A017-50451).

- 1. Is this source in a non-attainment area for a particular pollutant? NO
 - a. If yes, has "offset" been applied? _____
 - b. If yes, has "Lowest Achievable Emission Rate" been applied? _____
 - c. If yes, list non-attainment pollutants. _____
- 2. Does best available control technology (BACT) apply to this source? NO
If yes, see Section VI.
- 3. Does the State "Prevention of Significant Deterioration" (PSD) requirement apply to this source? If yes, see Sections VI and VII. NO
- 4. Do "Standards of Performance for New Stationary Sources" (NSPS) apply to this source? NO
- 5. Do "National Emission Standards for Hazardous Air Pollutants" (NESHAP) apply to this source? NO

- H. Do "Reasonably Available Control Technology" (RACT) requirements apply to this source? NO
- a. If yes, for what pollutants? _____
 - b. If yes, in addition to the information required in this form, any information requested in Rule 17-2.650 must be submitted.

Attach all supportive information related to any answer of "Yes". Attach any justification for any answer of "No" that might be considered questionable.

SECTION III: AIR POLLUTION SOURCES & CONTROL DEVICES (Other than Incinerators)

A. Raw Materials and Chemicals Used in your Process, if applicable:

Description	Contaminants		Utilization Rate - lbs/hr	Relate to Flow Diagram
	Type	% Wt		

B. Process Rate, if applicable: (See Section V, Item 1)

1. Total Process Input Rate (lbs/hr): _____

2. Product Weight (lbs/hr): _____

C. Airborne Contaminants Emitted: (Information in this table must be submitted for each emission point, use additional sheets as necessary)

Name of Contaminant	Emission ¹		Allowed Emission Rate per See Rule (b) 17-2	Allowable ³ Emission lbs/hr	Potential ⁴ Emission (d)		Relate to Flow Diagram
	Maximum lbs/hr	Actual T/yr			lbs/yr	T/yr	
NOx	12.3 ^(a)	4.4	N/A	N/A	12.3	4.4	
Particulates	.012 ^(c)	.025	N/A	N/A	.012	.025	
Opacity	5% or less		5% or less	5% or less	N/A		

¹See Section V, Item 2.

²Reference applicable emission standards and units (e.g. Rule 17-2.600(5)(b)2. Table II, E. (1) - 0.1 pounds per million BTU heat input)

³Calculated from operating rate and applicable standard.

⁴Emission, if source operated without control (See Section V, Item 3).

(a) See calculation #1

(b) 17-2.600(1)(a)

(c) See calculation #2

(d) Control device integral to the process so actual = potential emissions.

Brief description of operating characteristics of control devices: _____

The exhaust from the oven passes through the afterburner which is controlled between 1400-1500°F by controlling the rate of nylon degradation by means of a variable rate water quench spray.

Ultimate disposal of any effluent other than that emitted from the stack (scrubber water, ash, etc.):

Any ash residue from the nylon would be disposed of in compliance with solid waste and RCRA regulations.

NOTE: Items 2, 3, 4, 6, 7, 8, and 10 in Section V must be included where applicable.

SECTION V: SUPPLEMENTAL REQUIREMENTS

Please provide the following supplements where required for this application.

1. Total process input rate and product weight -- show derivation [Rule 17-2.100(127)]
2. To a construction application, attach basis of emission estimate (e.g., design calculations, design drawings, pertinent manufacturer's test data, etc.) and attach proposed methods (e.g., FR Part 60 Methods 1, 2, 3, 4, 5) to show proof of compliance with applicable standards. To an operation application, attach test results or methods used to show proof of compliance. Information provided when applying for an operation permit from a construction permit shall be indicative of the time at which the test was made.
3. Attach basis of potential discharge (e.g., emission factor, that is, AP42 test).
4. With construction permit application, include design details for all air pollution control systems (e.g., for baghouse include cloth to air ratio; for scrubber include cross-section sketch, design pressure drop, etc.)
5. With construction permit application, attach derivation of control device(s) efficiency. Include test or design data. Items 2, 3 and 5 should be consistent: actual emissions = potential (1-efficiency).
6. An 8 1/2" x 11" flow diagram which will, without revealing trade secrets, identify the individual operations and/or processes. Indicate where raw materials enter, where solid and liquid waste exit, where gaseous emissions and/or airborne particles are evolved and where finished products are obtained.
7. An 8 1/2" x 11" plot plan showing the location of the establishment, and points of airborne emissions, in relation to the surrounding area, residences and other permanent structures and roadways (Example: Copy of relevant portion of USGS topographic map).
8. An 8 1/2" x 11" plot plan of facility showing the location of manufacturing processes and outlets for airborne emissions. Relate all flows to the flow diagram.

SUPPLEMENT #1

MONSANTO, PENSACOLA

DISCUSSION OF NYLON POLYMER OVEN

AFTERBURNER CONTROL

Gas flow and air flow are held constant in both the oven section (primary chamber) and in the afterburner section (secondary chamber).

The afterburner temperature is factory set to achieve 1400° minimum temperature. This is not a field adjustable parameter.

As pyrolysis gases reach the afterburner, the afterburner temperature rises because of the heating value of these materials.

Pyrolysis rate in the primary chamber is controlled by water quenching. The rate of water flow is adjusted to maintain 1400-1500° afterburner temperature.

The primary chamber gas burners will not operate unless the secondary chamber (afterburner) burners are operating.

PROCESS DESCRIPTION

External oven dimensions are 93" wide x 131" long x 98" high. Nylon is heated in the primary chamber to between 800-900°F where it degrades to volatile compounds. These materials exit through the afterburner which provides 1/2 second residence time at a minimum temperature of 1400°F.

INCINERATION RATE

Maximum nylon per charge is 200 lbs. Maximum nylon burn off rate is 30 lbs./hr. Maximum annual nylon incineration capacity is 20,000 lbs. (Sp?)

SUPPLEMENT #2
MONSANTO PENSACOLA
DISCUSSION OF AFTERBURNER EFFICIENCY

See pages 172 and 181 (attached) from the Air Pollution Engineering Manual, Publication AP-40, US-EPA.

These sections show that 1/2 second residence time at a minimum of 1400°F can be expected to yield 95+% destruction efficiency.

AIR POLLUTION ENGINEERING MANUAL

SECOND EDITION



U.S. ENVIRONMENTAL PROTECTION AGENCY

CONTROL EQUIPMENT FOR GASES AND VAPORS

AFTERBURNERS

Afterburners, also called vapor incinerators, are air pollution control devices in which combustion converts the combustible materials in gaseous effluents to carbon dioxide and water. The combustible materials may be gases, vapors, or entrained particulate matter and may contribute opacity, odor, irritants, "fallout" materials, photochemical reactivity, and toxicity to the effluents. In many cases, an afterburner can be designed and operated at an efficiency high enough to eliminate or reduce the opacity, odor, irritants, and fallout and also the photochemically reactive and toxic qualities of the effluent to levels required for compliance with air pollution standards.

The two types of afterburners in use are (1) direct flame and (2) catalytic. Direct-flame afterburners, sometimes called direct-fired afterburners, depend upon flame contact and relatively high temperatures to burn the combustible materials. Catalytic afterburners operate by preheating the contaminated effluent to a predetermined temperature (usually lower than the operating temperature of the direct-flame afterburner) and then promoting further oxidation of the combustibles by bringing them into contact with a catalyst. In Los Angeles County, which has standards for emissions of organic materials (Rule 66), afterburners are essentially all of the direct-flame type.

DIRECT-FLAME AFTERBURNERS

Direct-flame afterburners consist of a refractory-lined chamber (which may vary in cross-sectional size along its length), one or more burners, temperature indicator-controllers, safety equipment, and sometimes heat-recovery equipment such as heat exchangers. Figures 98 through 106 show external views of direct-flame afterburners and illustrate the diversity of shapes and processes that can be vented.

DESIGN PRINCIPLES

An efficient direct-flame afterburner design must provide for (1) contact between the air contaminants and the burner flame, (2) adequate time for the combustion process, (3) sufficiently high temperature in the afterburner for the complete oxidation of the combustibles, and (4) adequate velocities to insure that mixing take place without quenching combustion.

The operation of direct-flame afterburners is relatively simple. The contaminated gases are delivered to the afterburner by an exhaust system. The gases are mixed thoroughly with the burner flames in the upstream part of the unit and then pass through the remaining part of the chamber where the combustion process is completed, prior to being discharged to the atmosphere. Figure 107 shows a sectional view of a typical afterburner.

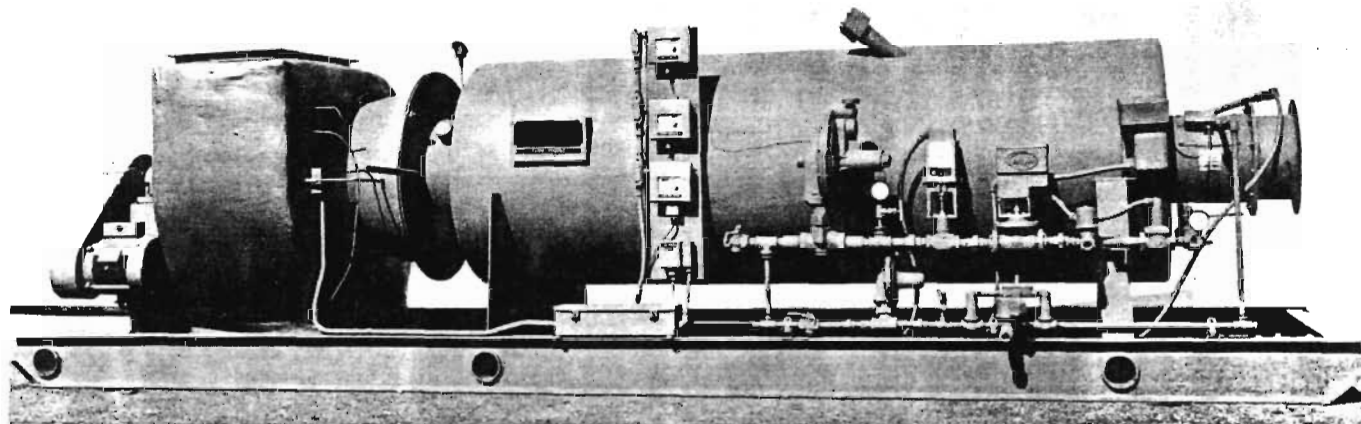

Figure 98. External view of direct-flame afterburner (Gas Processors, Inc., Brea, Calif.).

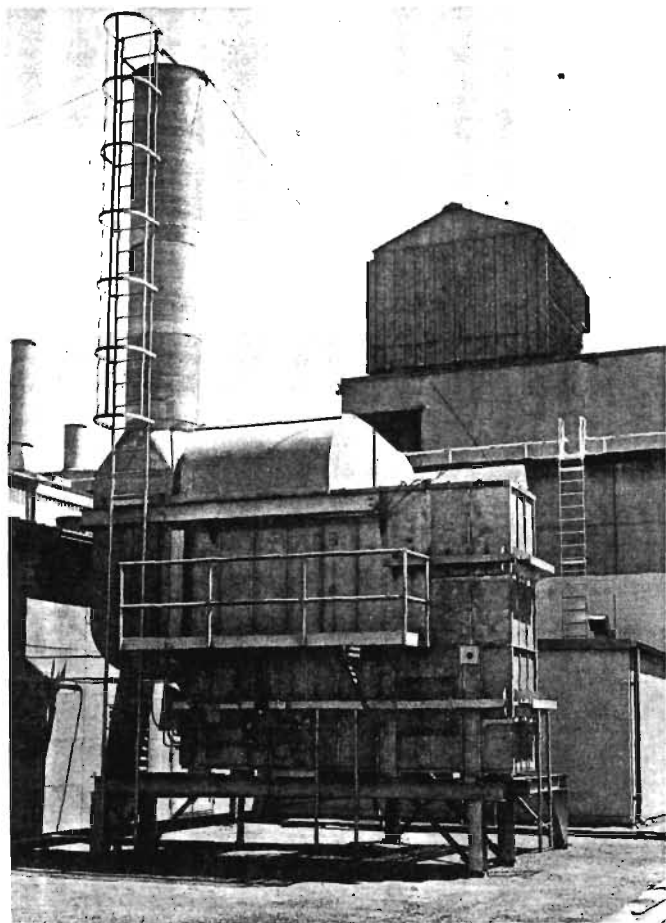

Figure 99. Direct-flame afterburner venting automotive assembly plant oven (GM Assembly Division, General Motors Corporation, Van Nuys, Calif.).

AFTERBURNER CHAMBER

The afterburner chamber may be cylindrical or rectangular in cross section and is constructed of refractory materials inside of a mild-steel shell. The refractory may be fire brick or castable refractory material. The chamber consists of a mixing section and a combustion section. The mixing section must provide for intimate contact between the contaminated gases and the burner flame. This area, therefore, is designed to provide high-velocity flow to insure turbulence and hence good mixing. Usual velocities for this zone vary between 25 and 50 feet per second (fps).

The portion of the chamber downstream of the mixing section is called the combustion chamber, and the velocity in this section is usually 20 to 40 fps. The overall retention time of the gases flowing through the unit should be 0.3 to 0.5 second. Afterburner discharge temperatures range from 1000° to 1500° F, depending upon the particular air pollution problem. Table 51 indicates recommended temperature ranges for various types of equipment. Higher afterburner dis-

charge temperatures than those shown in this table will result in higher afterburner efficiencies.

GAS BURNERS FOR AFTERBURNERS

Among the several types of gas burners used successfully are nozzle-mixing premixing, multi-port, and mixing-plate burners. Nozzle-mixing, premixing, and multi-port burners are described in the burner section of this manual. Mixing-plate burners have been specifically developed for afterburner applications. Figures 108, 109, and 110 show burners of this type. These burners consist of a pipe with orifices for natural gas and vanes or plates, which are perforated or shaped in a variety of ways to give good mixing between a contaminated air stream and the natural gas fuel. Most of the contaminated gases go through the burner.

The choice of burner type and the arrangement of the burners in the afterburner vary widely. The exact method of burner placement depends not only on the burner type, but also on the design consideration that the contaminated gases be in intimate contact with the burner flame. Maximum afterburner efficiency occurs when all of the contaminated material passes through the burner. In contrast, efficiencies are much lower when the contaminated air and burner flame mix far outside the burner. Very low efficiency is associated with minimum flame contact.

Gas burner arrangements, sources of combustion air, and methods for securing flame contact with the contaminated air are discussed below.

Mixing-Plate Burner (Figures 108, 109, and 110)

Mixing-plate burners usually are placed across the inlet section of the afterburner body. All air for combustion of the natural gas originates from the contaminated air stream.

Intimate flame contact is secured by positioning the burners and "profile plates" to force the maximum amount of contaminated air through the burner and burner flames. Profile plates, usually made of stainless steel, are installed around the burner between the afterburner walls and the burners. A space of 1 to 2 inches remains between the plate and the burner. The extremely high velocity (200 fpm) ensures that the contaminated air not flowing through the burner will mix with the burner flames.

Multi-Port Burners

Multi-port burners usually are installed across a section of the afterburner separate from the main afterburner chamber. All air for combustion is taken from the contaminated air stream. However, most multi-port burners are not capable of handling all of the contaminated stream through the

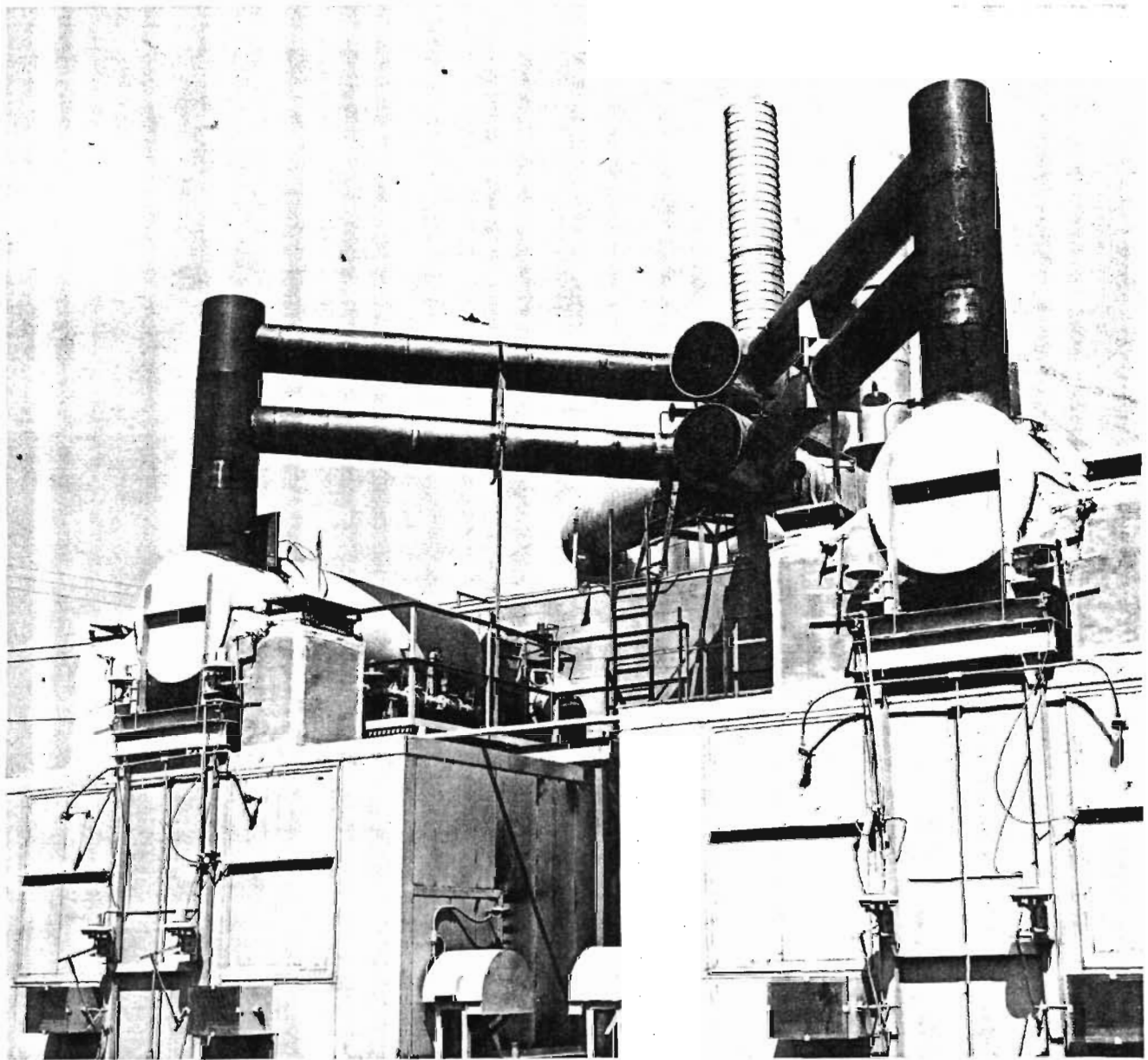

Figure 100. Two direct-flame afterburners controlling venting of organic emissions (American Cyanamid Co., Azusa, Calif.).

burner. Therefore, some of the air must be by-passed around the burner and then thoroughly mixed downstream with burner flames in a restricted and baffled area. For this reason, afterburners with multi-port burners may not be as efficient as units with mixing-plate burners. Efficiency of afterburners with multi-port burners will be influenced by the amount of contaminants that by-pass the burner.

Nozzle Mixing and Premixing Burners

The operation of these two types of burners is somewhat similar. They are arranged to fire

tangentially into a cylindrical afterburner. Several burners or nozzles are required to ensure complete flame coverage. In addition, multiple nozzles may be arranged to fire along the length of the afterburner. Air for combustion of the fuel can be taken from outside air or from the contaminated air stream.

Mixing between the contaminated gases and the burner flame is achieved in a smaller cross-sectional area of the afterburner (called the mixing section). Tangentially fired afterburners may have the contaminated gases introduced tangentially or along the major axis of the cylinder.

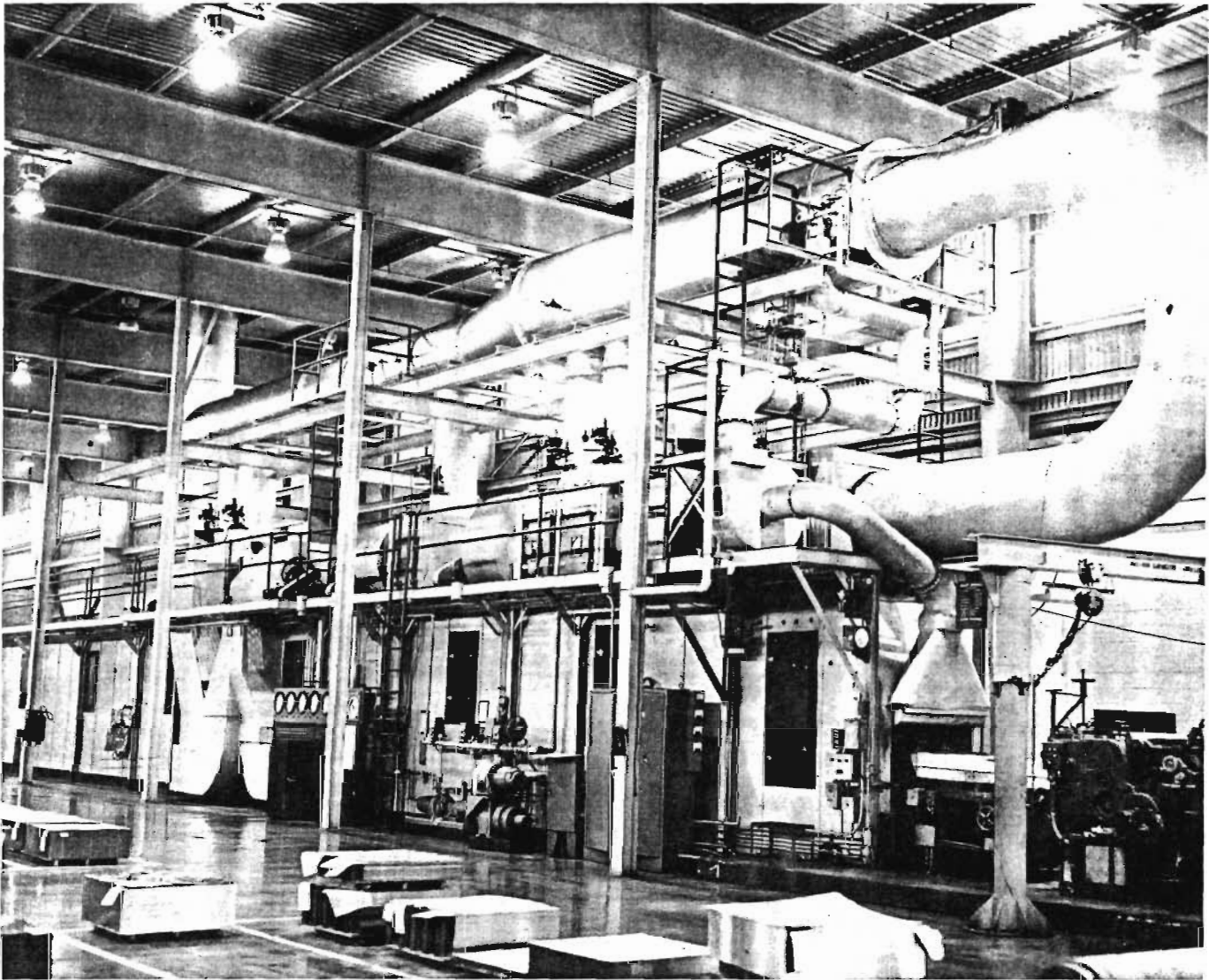

Figure 101. Direct-flame afterburner venting metal sheet lithographing line (American Can Co., Los Angeles, Calif.).

Refractory baffles and orifices also may be required to give the best possible mixing between flame and contaminated gases.

SOURCES OF COMBUSTION AIR FOR GAS BURNERS

As mentioned above, combustion air may be taken from the contaminated air stream or from ambient air. If the contaminated stream contains sufficient oxygen for combustion of the fuel and combustible contaminants, then additional oxygen is not required. Mixing-plate and multi-port burners supply the correct volume of air automatically. Premix and nozzle-mix burners require a blower and air-gas ratio controls to meter the proper mixture and combustion air. The combustion air for these burners comes from the contaminated air stream by branch

ducting from the main exhaust duct. Using this contaminated air for combustion results in higher afterburner efficiency and fuel savings of 20 to 30 percent.

OIL FIRING OF AFTERBURNERS

Oil firing of afterburners is feasible provided that proper design practice is followed and good flame contact is assured. Although oil firing is possible, it may be undesirable from the standpoint of overall air pollution emissions. The combustion of oil produces oxides of sulfur from the sulfur-containing oil and may produce oxides of nitrogen greater than those from gas-fired units. For these reasons, oil firing may not be desirable for many locales or should be restricted, i.e., used only for periods when fuel gas is not available.

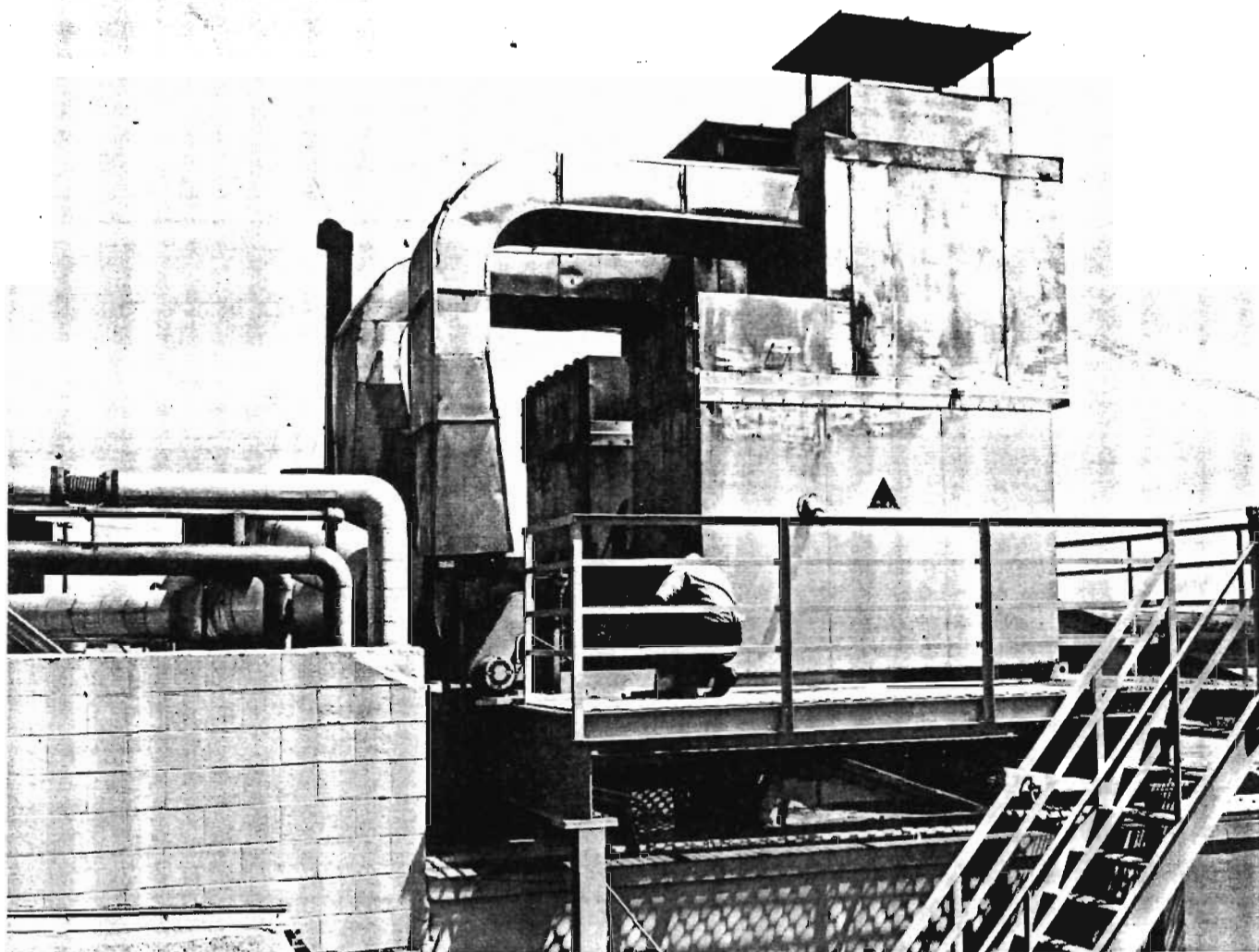

Figure 102. Direct-flame afterburner venting resin impregnating line (Synthane-Taylor Corporation, LaVerne, Calif.).

AFTERBURNER CONTROLS

Afterburner operating controls usually consist of a shielded thermocouple located in the discharge of the afterburner and an indicating-controlling pyrometer, which is coupled to the thermocouple. The pyrometer electrically or pneumatically controls gas and combustion air valves to modulate the amount of fuel fed to the afterburner. The mode of operation is fully modulating or high-low. The on-off control mode is undesirable since there are substantial periods when no burner flame is present with accompanying very low afterburner efficiency.

Safety controls consists of (1) flame safety devices to prove the presence of pilot burner flame, (2) timing devices to ensure that the afterburner is purged of combustibles before burner ignition, (3) high-temperature-limit controls to limit the afterburner temperature to a safe limit, and (4)

pressure switches to detect low gas and air pressures and shut down the unit if pressures become too low.

DIRECT-FLAME AFTERBURNER EFFICIENCY

Afterburner efficiency is defined as:

$$\text{Efficiency (\%)} = \frac{(\text{lb contam/hr in}) - (\text{lb contam/hr out})}{\text{lb contaminant/hr in}} \times 100$$

As mentioned earlier, the efficiency of an afterburner is a function of retention time, operating temperature, flame contact, and velocity. There is no quantitative mathematical relationship that relates efficiency to these variables because the kinetics of the combustion process are complex and the flow in afterburners is not easily defined. Assuming good design, the following generalizations may be made with respect to afterburner efficiency:

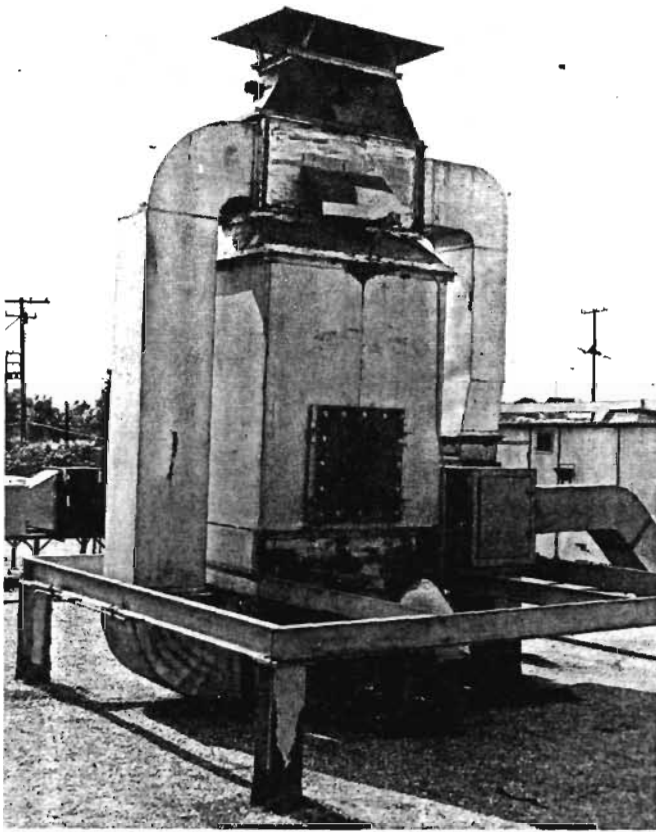

Figure 103. Direct-flame afterburner venting printing system (Avery Label Company, Div. of Avery Products Corporation; Monrovia, Calif.).

1. Overall efficiency increases with increasing afterburner operating temperature. Figure 111 illustrates this point.
2. Overall efficiency decreases if excessive preheat is given to the contaminated gases entering the afterburner.
3. Overall efficiency increases with increased flame contact between the contaminated gases and the burner flame.
4. Efficiency increases with retention time for retention times of less than 1 second.
5. Efficiency is a function of the afterburner design, and the inlet concentration of organic materials. No direct comparison can be made from one design to another.
6. An afterburner rarely attains 90 percent efficiency below 1300° F if the generation of carbon monoxide in the afterburner is included.

Tables 52 and 53 show typical data from tests on a large and a small afterburner.

In moderately efficient afterburners organic materials frequently decrease across the afterburner, but carbon monoxide levels increase. While this indicates some oxidation of organic materials, the materials discharged from the afterburner may be considerably more photochemically reactive, odorous, or irritating than the organic materials entering the afterburner. Thus, there may not be an overall improvement in the environment. In addition, the venting of carbon monoxide to the atmosphere is undesirable.

DIRECT-FLAME AFTERBURNER DESIGN PROBLEM

Given:

- Source of air contaminants - paint bake oven
- Oven effluent air volume - 4000 scfm
- Contaminated air temperature at afterburner inlet - 300° F
- Concentration of solvent - 300 ppm
- Required afterburner efficiency - 90%

Problem:

Determine dimensions of afterburner, burner type, operating temperature, and required natural gas input.

1. Burner selection:

The afterburner inlet gases will be relatively low in concentration (300 ppm). In addition, 90 percent efficiency based on carbon is required by Rule 66, which demands the best flame contact possible. On these bases, select a mixing plate burner.

2. Temperature selection:

The 90 percent efficiency requirement dictates the choice of 1400° F as the minimum required operating temperature.

3. Burner capacity:

- a. Net heat required to raise contaminate air stream to 1400° F from 300° F

Assumed properties of air:

Enthalpy at 1400° F = 26.13 Btu/scf
(see Table D4 in Appendix D)

Enthalpy at 300° F = 4.42 Btu/scf
(See Table D-4 in Appendix D)

Net enthalpy = 21.71 Btu/scf

$$Q_{\text{net}} = (4000)(60)(21.71) = 5.2 \times 10^6 \text{ Btu/hr}$$

b. Natural gas input required:

The hypothetical available heat for natural gas with 0% outside primary

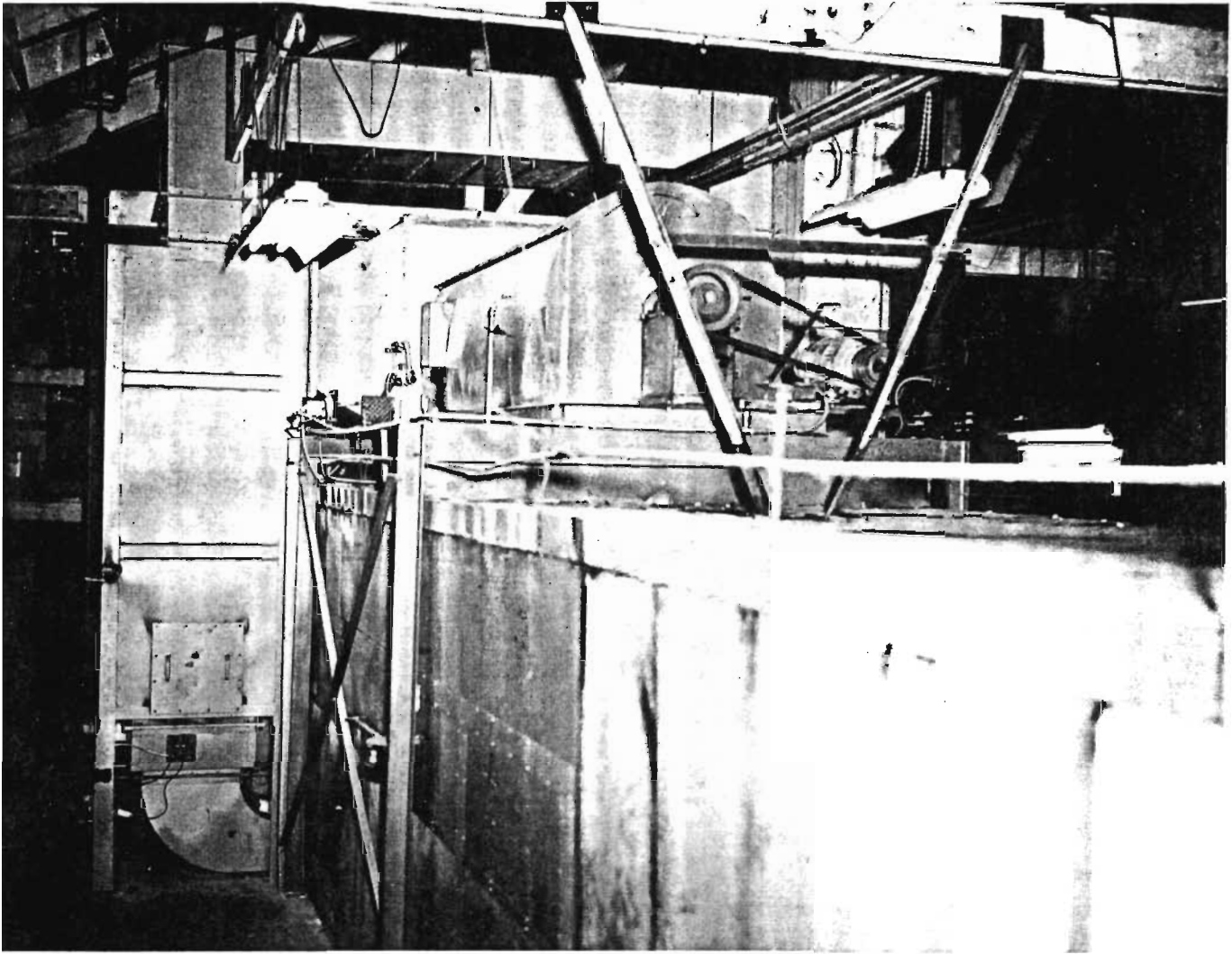

Figure 104. Direct-flame afterburner venting paint baking oven (Weber Show Case and Fixture, Div. of Walter Kidde and Company, Inc., Los Angeles, Calif.).

air = 939 Btu/ft³ (see Table C1 in Appendix C)

Natural gas input =

$$\frac{Q_{\text{net}}}{\text{Hypothetical available heat}} =$$

$$\frac{5.2 \times 10^6}{939} = 5,550 \text{ ft}^3/\text{hr}$$

4. Combustion chamber diameter:

Chamber is assumed to be cylindrical

a. Volume of gases in afterburner:

Vol = Oven effluent air - effluent used for combustion products from combustion of natural gas.

(1) Air for combustion of natural gas in (3b) above:

Air required = 10.36 ft³/ft³ natural gas (see Table D7 in Appendix D)

$$\frac{(5,550)(10.36)}{60} = 959 \text{ scfm}$$

(2) Products from combustion of natural gas:

Combustion products = 11.45 scfm/ft³ natural gas (see Table D7 in Appendix D)

$$\frac{(5,550)(11.45)}{60} = 1060 \text{ scfm}$$

(3) Volume of gases in afterburner:

$$4000 - 959 + 1060 = 4100 \text{ scfm}$$

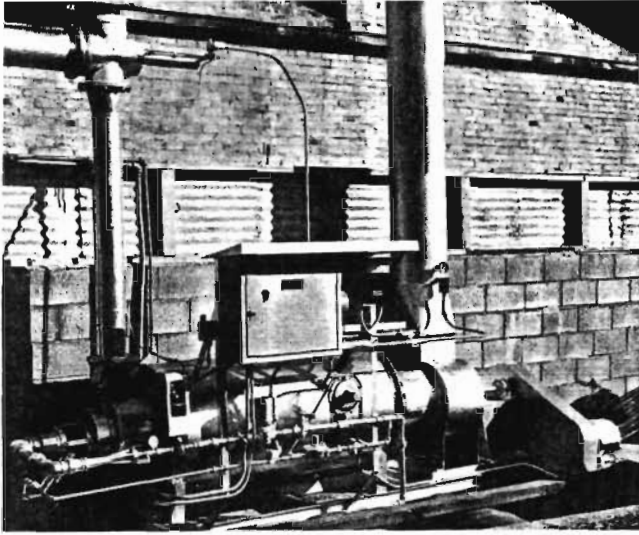

Figure 105. Direct-flame afterburner venting three varnish cooking kettles and a thinning station (National Paint and Varnish Co., Los Angeles, Calif.).

(4) Volume of gases at 1400° F (1360° R):

$$\frac{(4100) (1860)}{(60) (520)} = 244 \text{ cfs}$$

b. Diameter of afterburner:

Velocities of 20 to 40 fps are satisfactory.

Assume 30 fps.

$$\text{Afterburner cross section} = (244) (1/30) = 8.1 \text{ ft}^2$$

Diameter corresponding to 8.1 ft² =

$$\sqrt{\frac{8.1}{0.785}} = 3.2 \text{ ft}$$

5. Combustion chamber length:

Retention times of 0.3 to 0.5 second are adequate.

Assume 0.5 second.

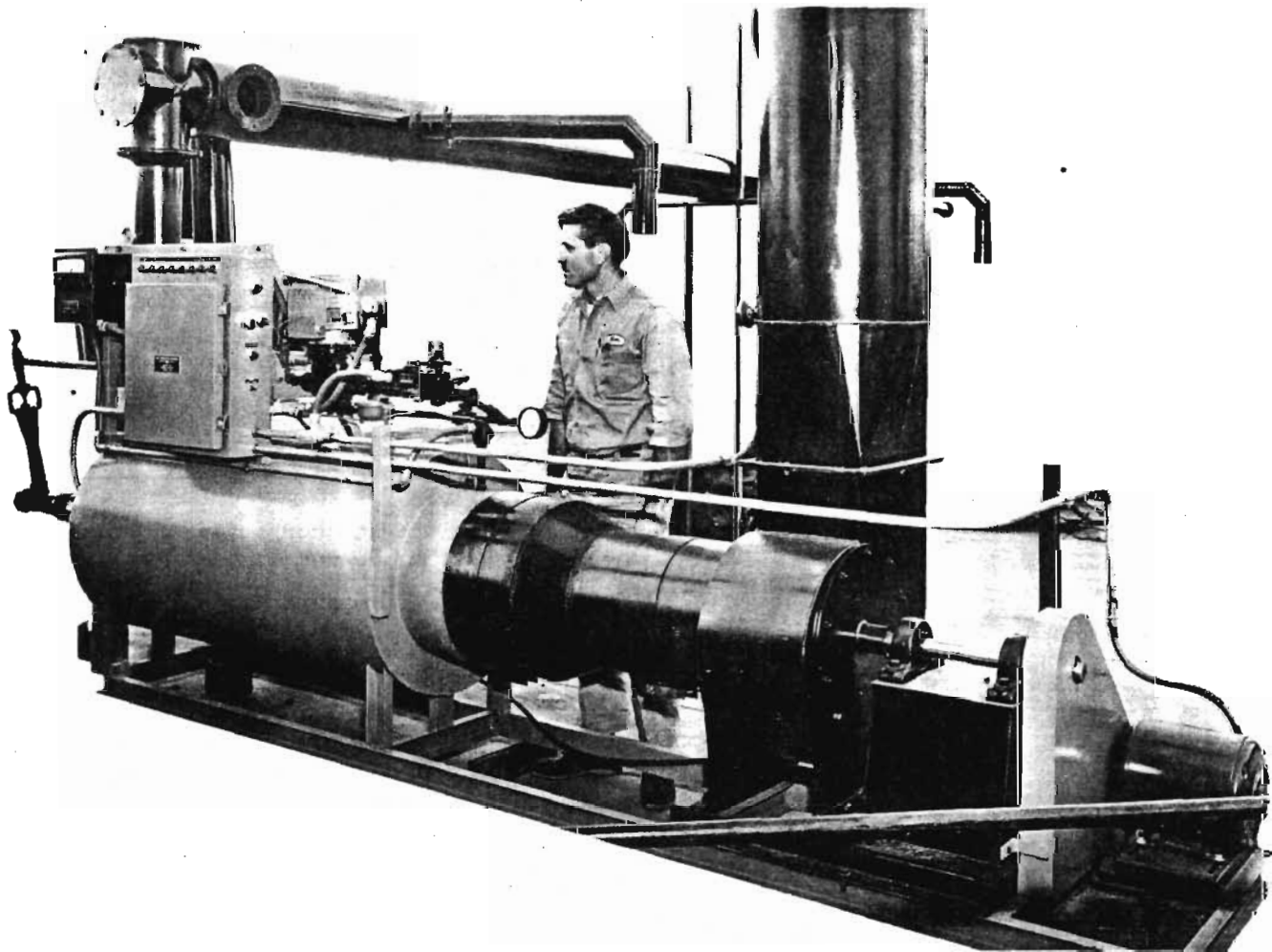

Figure 106. Direct-flame afterburner with induced-draft fan, all mounted on an integral frame and ready for shipment (Hirt Combustion Engineers, Montebello, Calif.).

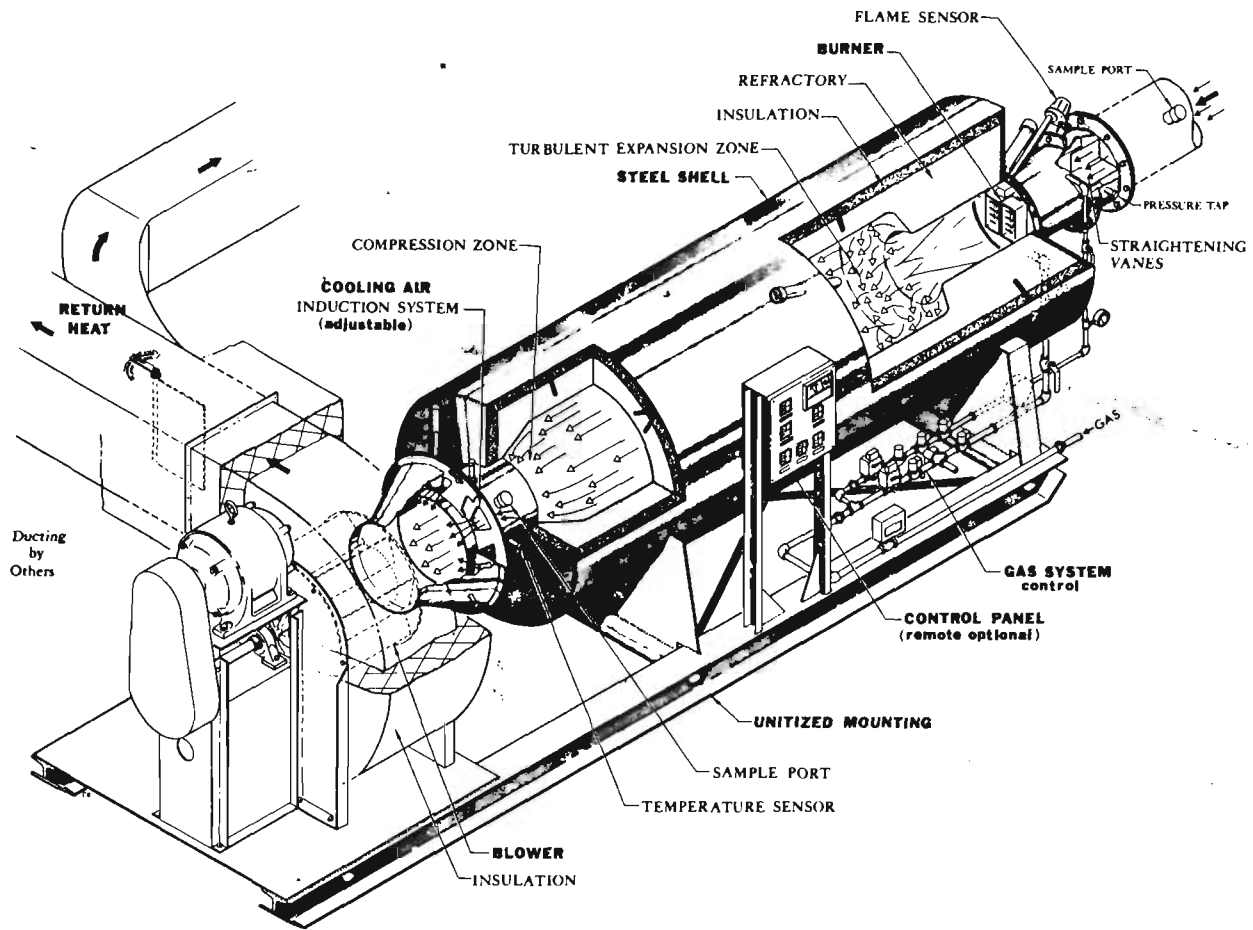

Figure 107. Sectional view of direct-flame afterburner (Gas Processors, Inc., Brea, Calif.).

Table 51. RECOMMENDED AFTERBURNER OPERATING TEMPERATURES

Operation	Recommended temperature, ° F
Carpet laminating	1200 - 1400
Core oven	1400
Cloth carbonization	1800
Deep fat fryers	1200
General opacity problems	1200 - 1400
Odor control	1300 - 1500
Oil and grease smoke	1200 - 1400
Paint bake ovens	1200 - 1500
Pipe wrapping	1400
Rendering operations	1200
Smokehouse	1200
Solvent control	1300 - 1500
Varnish cookers	1200
Vinyl plastisol curing	1200 - 1400

$$\text{Length} = (\text{retention time}) (\text{velocity})$$

$$= (0.5)(30) = 15 \text{ ft}$$

Summary of design:

- Burner type--Mixing plate
- Afterburner temperature = 1400° F
- Burner input = 5,550 cfh
- Afterburner diameter = 3.2 ft
- Afterburner chamber length = 15 ft

CATALYTIC AFTERBURNERS

A catalytic afterburner consists of a preheat burner section, a chamber containing catalyst, temperature indicator-controllers, safety equipment, and heat recovery equipment. Figures 112 through 115 show various arrangements of catalytic afterburners.

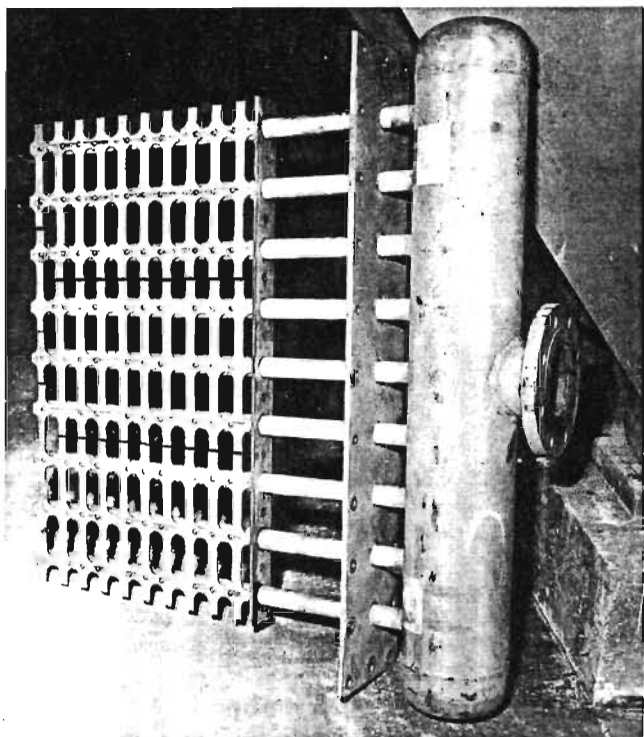

Figure 108. Mixing plate burner (J.T. Thorpe, Inc., Los Angeles, Calif.).

OPERATION

A catalyst is a substance that changes the rate of a chemical reaction and does not appear to change chemically in doing so. In the case of afterburners, the catalyst functions to promote the oxidation reactions at a somewhat lower temperature than occurs in a direct-flame afterburner. The catalyst usually is platinum combined with other metals and deposited in porous form on an inert substrate. The substrate may be in the form of rods, honeycomb, or ribbons. In any case, the objective is to present the maximum catalyst surface area to the contaminated gases.

In operation, the contaminated gases delivered to the afterburner first enter the preheat zone, where they are heated to the temperature required to sustain the catalytic combustion. The preheat zone temperature varies with the composition and type of contaminants to be oxidized, but is generally in the range of 650° to 1100° F. A substantial portion of the overall efficiency of the afterburner can be attributed to the burner in the preheated zone. The preheated gases then flow through the catalytic elements, where the remaining contaminants are burned. The combustion reaction is exothermic, resulting in an increase of catalyst temperature--the greater the concentration of

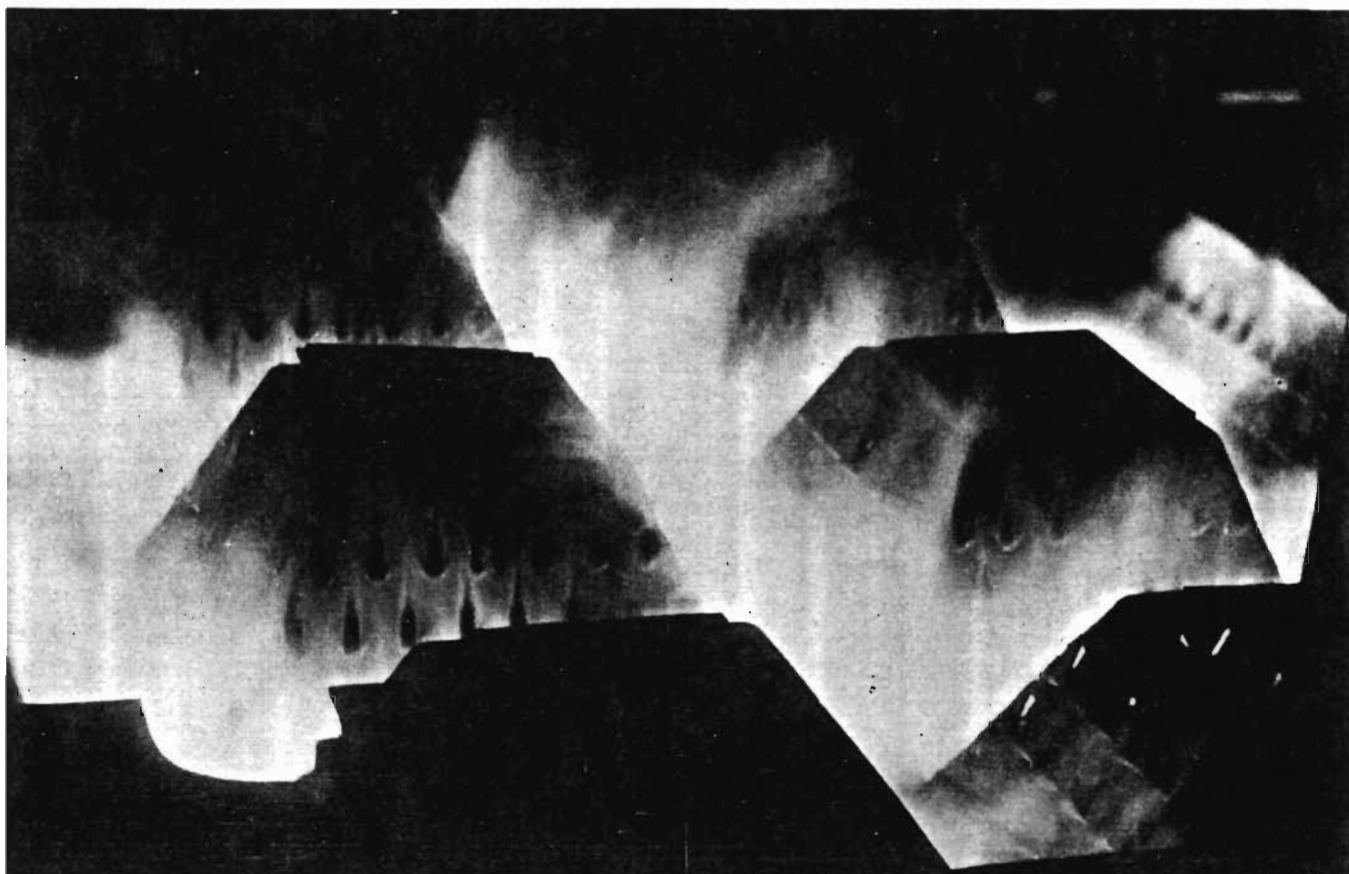

Figure 109. Mixing plate burner (Maxon Premix Burner Co., Inc., Muncie, Ind.).

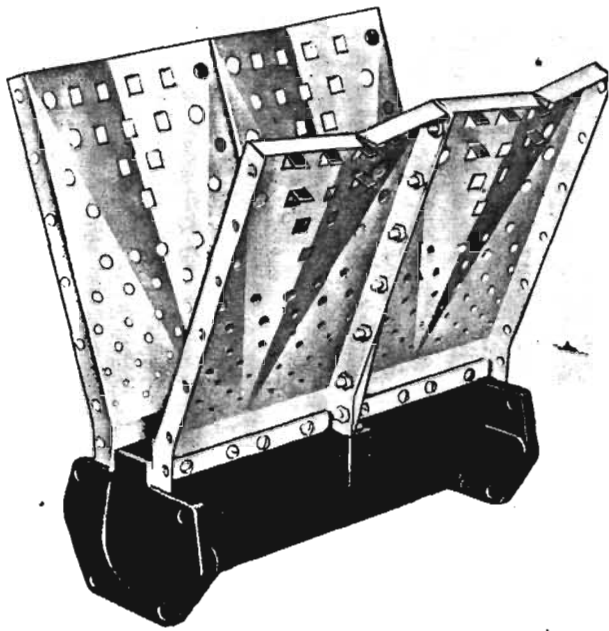

Figure 110. Schematic drawing of mixing plate burner (Maxon Primix Burner Co., Inc., Muncie, Inc.).

combustible material, the higher the catalyst temperature. Under some conditions it is possible to reduce the preheat temperature of the entering gases after the reaction has been initiated.

EFFICIENCY

The efficiency of catalytic afterburners is a function of many variables. These include surface area of the catalyst, catalyst type, uniformity of flow of the gases through the catalyst bed, nature of the material being burned, oxygen concentration, volume of gases per unit of catalyst, and temperature of the unit.

The efficiency of a catalytic afterburner deteriorates as the unit is used, and periodic replacement of the elements is required. This replacement time varies widely, depending upon the service of the unit, from a few months to 2 years. In addition, the performance of the catalyst is seriously affected by materials that "poison" the catalyst. Some of these are mercury, arsenic, zinc, and lead. Substances that coat the catalytic elements such as resin solids and solid oxides must be avoided since these materials will seal off the catalyst from the gases to be treated.

Catalytic afterburners may not be capable of meeting local efficiency requirements, such as 90 percent conversion of the carbon in the organic

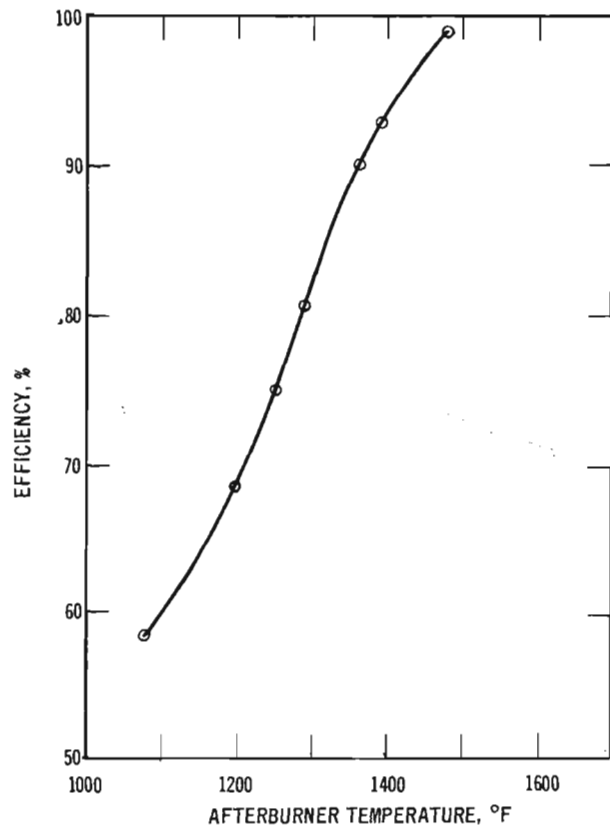

Figure 111. Direct-flame afterburner efficiency as a function of temperature. *

materials to carbon dioxide. New catalysts recently made available may increase the afterburner efficiency at relatively high inlet concentrations (greater than 5000 ppm as carbon). At lower concentrations, the catalytic afterburner efficiency decreases markedly even at discharge temperatures as high as 1100° F. Catalytic afterburners operating at less than 900° to 1000° F may exhaust gases that are odorous and eye irritating. This problem appears to be due to the incomplete oxidation of the organic material, resulting in aldehydes, ketones, and organic acids.

RECOVERY OF HEAT FROM AFTERBURNER EXHAUST GASES

The heat discharge in the afterburner exhaust gases frequently can be recovered, and thus the overall cost of afterburner operation may be reduced. Some of the heat recovery schemes that have been used successfully include:

1. Heat exchangers to heat the contaminated gases before entry into the afterburner.

Table 52. TYPICAL ANALYSIS OF EMISSIONS ENTERING AND LEAVING
LARGE DIRECT-FIRED AFTERBURNER

	Temperature			
	1400° F		1500° F	
	In	Out	In	Out
CO ₂ , ppm	6,300	22,000	6,600	27,000
CO, ppm	59	230	65	21
Organics as CO ₂ , ppm	1,568	235 ^a	1,591	70
Volume (dry basis), scfm	11,950	11,800	12,000	11,800
Organics (as carbon), lb/hr	35.6	5.26	36.2	1.6
Afterburner efficiency, %	85		96	

^aIncludes increase of CO across afterburner.

Table 53. TYPICAL ANALYSIS OF EMISSIONS ENTERING AND LEAVING
SMALL DIRECT-FIRED AFTERBURNER

	Temperature			
	1300° F		1400° F	
	In	Out	In	Out
CO ₂ , ppm	1,950	19,000	2,000	23,500
CO, ppm	8	110	9	24
Organics as CO ₂ , ppm	521	122 ^a	408	33 ^a
Volume (dry basis), scfm	2,240	2,200	2,240	2,200
Organics (as carbon), lb/hr	2.21	0.50	1.74	0.14
Afterburner efficiency, %	77		92	

^aIncludes increase of CO across afterburner.

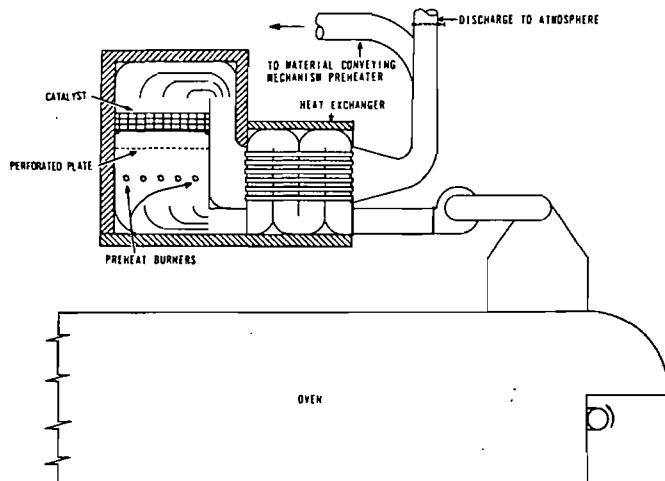

Figure 112. Typical catalytic afterburner utilizing indirect heat recovery.

- Heat exchangers to heat air as a source of heat for the equipment generating the contaminated gases.
- Venting of the afterburner gases to other process equipment such as waste heat boilers, water dry-off ovens, and vaporizers.

PREHEATING OF AFTERBURNER INLET GASES

Use of a heat exchanger for preheating the contaminated gases entering the afterburner is one of the most commonly used methods of recovery of heat from afterburner exhaust gases. The usual method is to use a shell-and-tube heat exchanger with the gases to be heated on the tube side and the afterburner discharge gases on the shell side. There may be one or two passes on the tube side and one pass on the shell side. In heat exchange

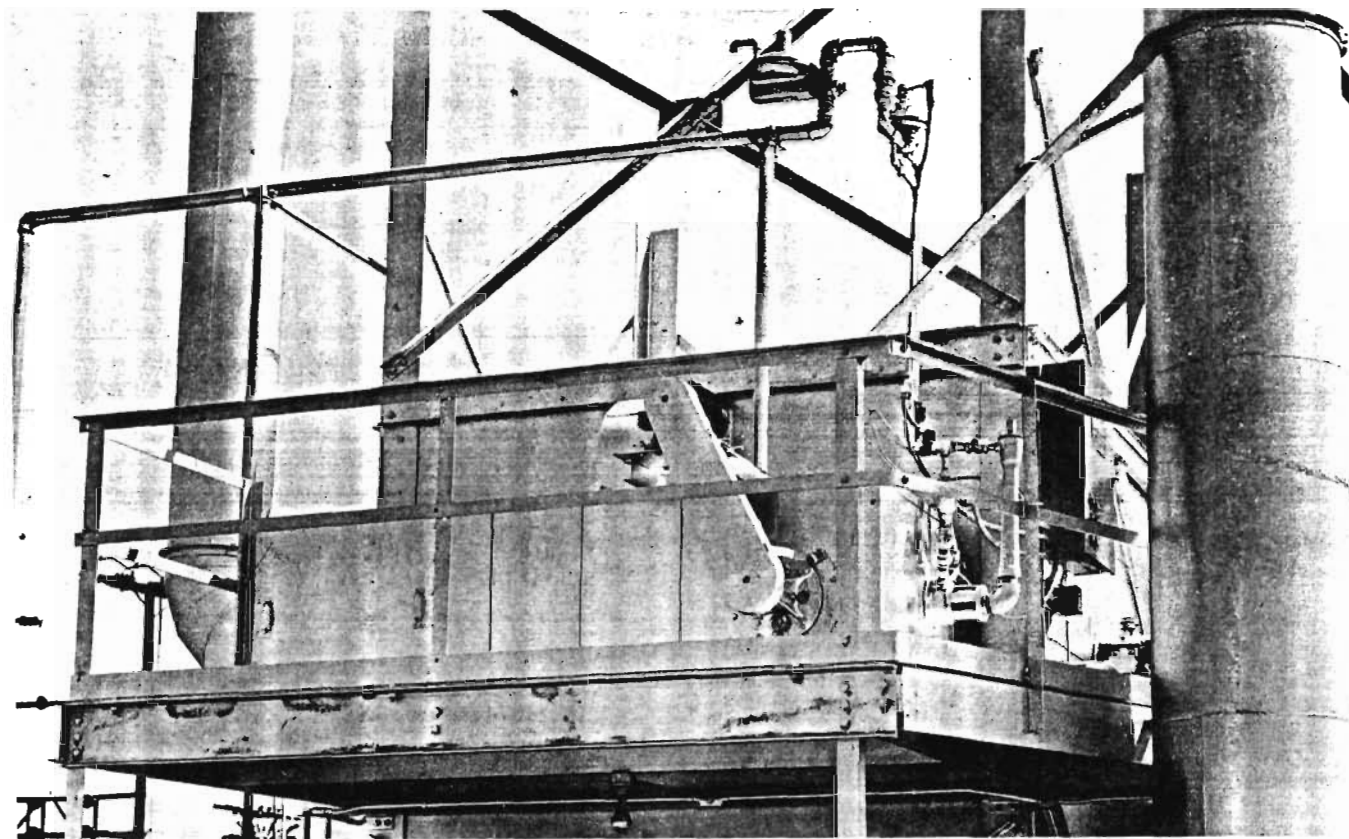

Figure 113. A catalytic afterburner used to control a foundry core baking oven (Catalytic Combustion Corporation, Detroit, Michigan).

terminology, a pass is the number of times an individual stream exchanges heat with another stream. The temperature of the heated, contaminated gas leaving the exchanger usually is about midway between the cool gases entering the exchanger and the temperature of the gases vented to the exchanger from the afterburner.

The stream entering the afterburner should not be preheated to too high a temperature. Excessive preheat will substantially reduce the amount of burner flame present and thus lower the efficiency.

BOILERS USED AS AFTERBURNERS

Fireboxes of boilers and fired heaters can be used, under proper conditions, as afterburners to incinerate combustible air contaminants. This use is unique in that a basic source of air contaminants, a boiler, is used to control pollutants from another source. Boiler firebox conditions approximate those of a well-designed afterburner, provided there are adequate temperature, retention time, turbulence, and flame. Oxidizable contaminants, including smoke and organic vapors and gases, can be converted essentially to carbon dioxide and water in boiler fireboxes.

The discussion of this section is limited to the control of low-calorific-value gases and vapors with common types of steam and hot water boilers and heaters. When appreciable heat is contained in the contaminated gases, the firebox is usually of special design to take advantage of the heat potential. These latter units, commonly known as waste heat boilers, are discussed in Chapter 9.

Completely satisfactory adaptations of boilers for use as afterburners are not common. All aspects of operation should be thoroughly evaluated before this method of air pollution control is used. The primary function of a boiler is to supply steam or hot water, and whenever its use as a control device conflicts with this function, one or both of its purposes will suffer. Some advantages and disadvantages of boilers used as afterburners are shown in Table 54.

CONDITIONS FOR USE

The determination to use a boiler as an afterburner demands that the following conditions exist:

1. The air contaminants to be controlled must be almost wholly combustible since a boiler

CALCULATION #1

MONSANTO PENSACOLA
 NYLON POLYMERIZATION EQUIPMENT

Calculation of NOx emission from natural gas burning - reference section 1.4-2, AP42.

$$\text{NOx factor: } \frac{100 \text{ lb. NOx}}{10^6 \text{ ft.}^3 \text{ gas}} \quad \checkmark \quad (\text{from AP-42})$$

$$\text{Heat input: } \frac{600,000 \text{ Btu}}{\text{Hr.}} \quad \checkmark \quad = \quad \frac{577 \text{ ft.}^3 \text{ gas}}{\text{Hr.}}$$

$$\text{Lbs. NOx} = \frac{577 \text{ ft.}^3 \text{ gas}}{\text{Hr.}} \quad \times \quad \frac{100 \text{ lbs. NOx}}{10^6 \text{ ft.}^3 \text{ gas}} \quad \left. \begin{array}{l} \frac{10^2}{10^6} = 10^{-4} \\ \} 5.77 \times 10^{-2} \end{array} \right\}$$

$$\frac{.06 \text{ lb. NOx}}{\text{Hr.}} = \frac{.25 \text{ tons NOx}}{\text{Yr.}} \quad \left(\begin{array}{l} .26 \\ \text{ton} \approx 2000 \text{ lbs} \end{array} \right)$$

$$\text{Maximum NOx} = 2 \times \text{expected NOx} = 2 \times .06 = \frac{.12 \text{ lb. NOx}}{\text{Hr.}}$$

Calculation of NOx from organic nitrogen (assuming all organic nitrogen converted to NOx)

$$\frac{30 \text{ lb.}}{\text{Hr.}} \quad \times \quad \frac{28}{226} \quad (\text{fraction nitrogen in nylon}) \quad \times$$

$$\frac{46 \text{ (MW NOx)}}{14 \text{ (MW Nitrogen)}} = \frac{12.2 \text{ lb. NOx}}{\text{Hr.}}$$

$$\frac{20,000 \text{ lb nylon.}}{\text{Yr.}} \quad \times \quad \frac{28}{226} \quad \times \quad \frac{46}{14} \quad \times \quad \frac{1 \text{ ton}}{2,000 \text{ lbs.}} =$$

4.1 tons/year

SECTION III C EMISSIONS

Maximum hourly lbs/hr. NOx = .12 + 12.2 = 12.3 lb./hr. NOx

Actual tons/yr. NOx = .25 + 4.1 = 4.4 tons/yr. NOx

DER-14.BPM

CALCULATION #2

MONSANTO PENSACOLA

NYLON POLYMERIZATION EQUIPMENT

Calculation of particulate emission from natural gas burning;
reference section 1.4-2, AP 42.

$$\text{Particulates factor: } \frac{10 \text{ lb. particulates}}{10^6 \text{ ft.}^3 \text{ gas}}$$

$$\text{Heat input} = \frac{600,00 \text{ Btu}}{\text{Hr.}} = \frac{577 \text{ ft.}^3 \text{ gas}}{\text{Hr.}}$$

$$\text{Lb. particulates} = \frac{577 \text{ ft.}^3 \text{ gas}}{\text{Hr.}} \times \frac{10 \text{ lb. NOx}}{10^6 \text{ ft.}^3 \text{ gas}} =$$

$$.006 \text{ lb./hr. particulates} = .025 \text{ tons/year}$$

$$\text{Maximum hourly particulates} = 2 \times \text{expected particulates} =$$
$$.012 \text{ lb./hr.}$$

PS Form 3811, July 1983

SENDER: Complete items 1, 2, 3 and 4.

Put your address in the "RETURN TO" space on the reverse side. Failure to do this will prevent this card from being returned to you. The return receipt fee will provide you the name of the person delivered to and the date of delivery. For additional fees the following services are available. Consult postmaster for fees and check box(es) for service(s) requested.

1. Show to whom, date and address of delivery. -
 2. Restricted Delivery.

3. Article Addressed to:
 Mr. Bruce McLeod
 Monsanto Company
 Post Office Box 12830
 Pensacola, Florida 32575

4. Type of Service:	Article Number
<input type="checkbox"/> Registered <input type="checkbox"/> Insured <input checked="" type="checkbox"/> Certified <input type="checkbox"/> COD <input type="checkbox"/> Express Mail	0155568

Always obtain signature of addressee or agent and DATE DELIVERED.

5. Signature - Addressee
 X *W. B. Small*

6. Signature - Agent
 X

7. Date of Delivery

8. Addressee's Address (ONLY if requested and fee paid)

DOMESTIC RETURN RECEIPT

No. 0155568

RECEIPT FOR CERTIFIED MAIL

NO INSURANCE COVERAGE PROVIDED—
 NOT FOR INTERNATIONAL MAIL
 (See Reverse)

SENT TO		Mr. Bruce McLeod	
STREET AND NO.			
P.O., STATE AND ZIP CODE			
POSTAGE		\$	
CONSULT POSTMASTER FOR FEES	CERTIFIED FEE	¢	
	SPECIAL DELIVERY	¢	
	RESTRICTED DELIVERY	¢	
	OPTIONAL SERVICES	SHOW TO WHOM AND DATE DELIVERED	¢
		SHOW TO WHOM, DATE, AND ADDRESS OF DELIVERY	¢
		SHOW TO WHOM AND DATE DELIVERED WITH RESTRICTED DELIVERY	¢
		SHOW TO WHOM, DATE AND ADDRESS OF DELIVERY WITH RESTRICTED DELIVERY	¢
TOTAL POSTAGE AND FEES	\$		
POSTMARK OR DATE		6/4/85	

PS Form 3800, Apr. 1976

STATE OF FLORIDA
DEPARTMENT OF ENVIRONMENTAL REGULATION

TWIN TOWERS OFFICE BUILDING
2600 BLAIR STONE ROAD
TALLAHASSEE, FLORIDA 32301-8241

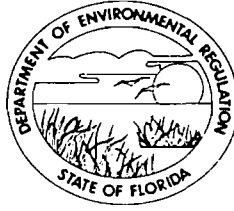

BOB GRAHAM
GOVERNOR
VICTORIA J. TSCHINKEL
SECRETARY

May 31, 1985

CERTIFIED MAIL - RETURN RECEIPT REQUESTED

Mr. Bruce McLeod
Monsanto
P. O. Box 12830
Pensacola, Florida 32575

Dear Mr. McLeod:

Re: Permit Application No. 17-104180, Monsanto Fibers &
Intermediate Co., Nylon Polymer Oven with Natural Gas
Fired Afterburner

A review of your application to construct the referenced air pollution source is incomplete. The following is required to complete your application.

1. Section II-F. This application is a new source added to an existing facility and thus requires the completion of this section.
2. Section III-C. Emissions information is to be completed as required.
3. Section V - Item 2. a) Emission test data from the manufacturer or other reasonable calculations with respect to criteria pollutants is necessarily to be furnished. b) What instrument(s) and recording device is used to monitor stack temperature/afterburner temperature?
4. Section V - Item 5. The application cites a "normal" charge rate of 20 lbs/hr and a "maximum" charge rate of 30 lbs/hr; please furnish the operational procedure (or explanation of automatic regulatory controls) to allow maintenance of 1500°F afterburner temperature. This information should be supported by manufacturers specifications on operation and destruction efficiencies at the burn rates, materials, and temperatures noted in this application.

Upon receipt of this information to the above items, processing of your application will resume. Please refer to this letter in your response.

Mr. Bruce McLeod
Page Two
May 31, 1985

If there are further questions, please call M. G. Phillips, at
(904)488-1344 or write to me at the above address.

Sincerely,



C. H. Fancy, P.E.
Deputy Chief
Bureau of Air Quality
Management

CHF/MP/s

cc: Mr. T. W. Moody, P.E.

Nylon CONH₂ (AMIDE GR) LONG CHAIN POLYMER

- New? 24x7x52 hrs = 8,736 hrs
- INCIN: POLLUTION CONTROL PRODUCTS Co. IGG-391
- 25-100 lbs Nylon/BATCH (10-20 lbs/hr - 30 lbs/hr maximum)

UTM COORS

- ICC 5-03-001-01 SIC (MSW) 4953 } FOR INCUBATOR
- ~~5-03-900-06~~ for aux fuel not gas }

Furnaces
~~Over~~ w/ APC INCIN

Comments SEC III - EMISSIONS, ETC.

RETENTION t; ANY TOXINS GENERATED SUCH AS PCDD/DF

MANU STATEMENT OF AFTERBURNER E

JACK PREECE (TOM MOODY) ^{BOSS} SUNCOM 695-8364

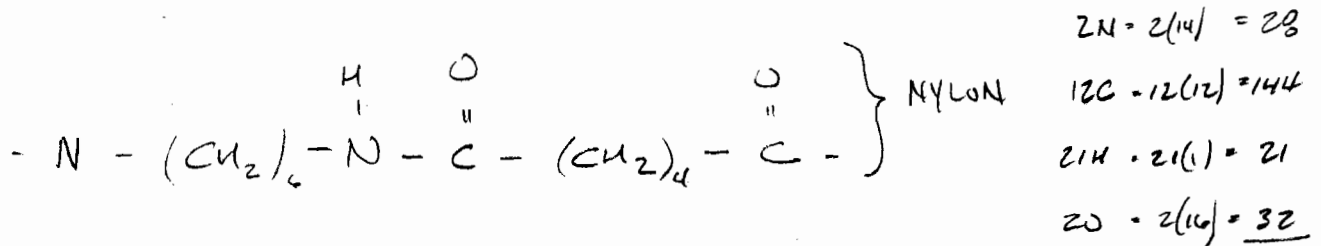

can TUES JACK PREECE comments by 7th, Bruce McLeod

RULES

17.2.600 (1)(a) - CHARGING RATE < 50 TPD

(1)(a) 1. No VE > 5% , ETC 20% FOR UP TO 3 MINS IN ANY ONE HR.

2. No NASTY ODORS

Monsanto

MONSANTO FIBERS & INTERMEDIATES COMPANY
P. O. Box 12830
Pensacola, Florida 32575
Phone: (904) 968-7000

May 14, 1985

DER
MAY 16 1985
BAQM

Mr. Claire Fancy
Department of Environmental Regulation
2600 Blair Stone Road
Tallahassee, Florida 32301

Dear Mr. Fancy:

Enclosed are four copies of an application to construct a nylon polymerization equipment incinerator facility and a check for \$100.00 to cover the construction permit fee.

If upon your review of this application you note an deficiencies, we will appreciate being informed by telephone as soon as possible. If you have any questions or comments, please feel free to contact me at 904/968-8725.

Sincerely,

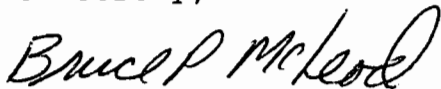

Bruce P. McLeod, Specialist
Environmental Control

Enclosure

cc: Mr. T. W. Moody, P.E.,
Department of Environmental Regulation
160 Governmental Center
Pensacola, Florida 32501

Mr. J. G. Wiley
Monsanto Company
P. O. Box 12830
Pensacola, Florida 32575

FANCY.MC

Monsanto

WORKING FUND ACCOUNT
MONSANTO COMPANY
PENSACOLA, FLORIDA

720 03552
5-14-85

62-20
311

\$100.00

★ **100 AND 00 CTS**

PAY
TO THE
ORDER
OF

DEPARTMENT OF ENVIRONMENTAL REGULATION

Citibank (Delaware)

Claudia Simmons
Ch Day

MONSANTO COMPANY, PENSACOLA, FLORIDA

720 03552

P-20 5-14-85 THE ATTACHED CHECK IS IN PAYMENT OF THE FOLLOWING:

DEPARTMENT OF ENVIRONMENTAL REGULATION

MEMO	DATE	INVOICE NO.	AMOUNT	DEDUCTIONS & DISCOUNT	NET
CONSTRUCTION PERMIT FEE FOR NYLON INCINERATOR (MCLEOD)	5-14-85		\$100.00		\$100.00

DETACH BEFORE DEPOSITING

CH 142

STATE OF FLORIDA
DEPARTMENT OF ENVIRONMENTAL REGULATION

№ 70073

RECEIPT FOR APPLICATION FEES AND MISCELLANEOUS REVENUE

Received from Monsanto Date May 16, 1985
Address P.O. Box 12830, Pensacola, FL 32575 Dollars & 100.00
Applicant Name & Address Same as above
Source of Revenue _____
Revenue Code 001031 Application Number AC 17-104180
By Patricia K. Adams

STATE OF FLORIDA

DEPARTMENT OF ENVIRONMENTAL REGULATION

NORTHWEST DISTRICT
60 GOVERNMENTAL CENTER
ENSACOLA, FLORIDA 32501

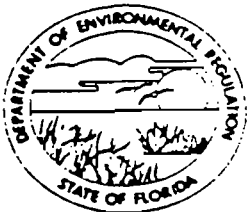

DER

MAY 16 1985

BAOM

BOB GRAHAM
GOVERNOR
VICTORIA J. TSCHINKEL
SECRETARY
ROBERT V. KRIEGLER
DISTRICT MANAGER

APPLICATION TO OPERATE/CONSTRUCT AIR POLLUTION SOURCES

SOURCE TYPE: Incinerator [] New¹ [x] Existing¹

APPLICATION TYPE: [x] Construction [x] Operation [] Modification

COMPANY NAME: Monsanto Company COUNTY: Escambia

Identify the specific emission point source(s) addressed in this application (i.e. Lime Nylon polymerization equipment auxiliary incinerator facility. Kiln No. 4 with Venturi Scrubber; Peaking Unit No. 2, Gas Fired)

SOURCE LOCATION: Street Intersection SR 297 & 292 City _____

UTM: East 16 ^{ZONE} 476.96 North 3384.13

Latitude 30 ° 35 ' 28 "N Longitude 87 ° 14 ' 25 "W

APPLICANT NAME AND TITLE: R. L. Monty, Supt., Environmental Health and Safety

APPLICANT ADDRESS: P. O. Box 12830 Pensacola, FL 32575

SECTION I: STATEMENTS BY APPLICANT AND ENGINEER

A. APPLICANT

I am the undersigned owner or authorized representative* of Monsanto Company

I certify that the statements made in this application for a Construction/Operation permit are true, correct and complete to the best of my knowledge and belief. Further, I agree to maintain and operate the pollution control source and pollution control facilities in such a manner as to comply with the provision of Chapter 403, Florida Statutes, and all the rules and regulations of the department and revisions thereof. I also understand that a permit, if granted by the department, will be non-transferable and I will promptly notify the department upon sale or legal transfer of the permitted establishment.

*Attach letter of authorization

Signed: [Signature]
R. L. Monty, Supt., Env. Health & Safety
Name and Title (Please Type)

Date: 5/14/85 Telephone No. 904/968-7411

B. PROFESSIONAL ENGINEER REGISTERED IN FLORIDA (where required by Chapter 471, F.S.)

This is to certify that the engineering features of this pollution control project have been designed/examined by me and found to be in conformity with modern engineering principles applicable to the treatment and disposal of pollutants characterized in the permit application. There is reasonable assurance, in my professional judgment, that

¹ See Florida Administrative Code Rule 17-2.100(57) and (104)

the pollution control facilities, when properly maintained and operated, will discharge an effluent that complies with all applicable statutes of the State of Florida and the rules and regulations of the department. It is also agreed that the undersigned will furnish, if authorized by the owner, the applicant a set of instructions for the proper maintenance and operation of the pollution control facilities and, if applicable, pollution sources.

Signed Bruce P. McLeod

Bruce P. McLeod
Name (Please Type)

Monsanto Company
Company Name (Please Type)

P. O. Box 12830 Pensacola, FL 32575
Mailing Address (Please Type)

Florida Registration No. 26976 Date: 5/14/85 Telephone No. 904/968-8725

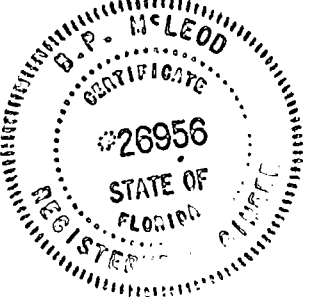

SECTION II: GENERAL PROJECT INFORMATION

Describe the nature and extent of the project. Refer to pollution control equipment, and expected improvements in source performance as a result of installation. State whether the project will result in full compliance. Attach additional sheet if necessary.

Purchase and install pyrolysis type oven with afterburner incinerator. Purpose of this facility is to serve as auxiliary to the main facility (Permit A017-50451) incinerating nylon from polymerization equipment parts (piping, filter housings, etc.). This facility will be in full compliance with existing requirements for incinerators with a charging rate of less than 50 tons/day. See supplements 1 & 3.

Schedule of project covered in this application (Construction Permit Application Only)
Start of Construction 6/1/85 Completion of Construction 6/1/86

Costs of pollution control system(s): (Note: Show breakdown of estimated costs only for individual components/units of the project serving pollution control purposes. Information on actual costs shall be furnished with the application for operation permit.)

Total cost of system - estimated \$40,000.

Indicate any previous DER permits, orders and notices associated with the emission point, including permit issuance and expiration dates.

Main incinerator for nylon polymerization equipment parts (Permit A017-50451)

Requested permitted equipment operating time: hrs/day 24; days/wk 7; wks/yr 52;
if power plant, hrs/yr _____; if seasonal, describe: _____

If this is a new source or major modification, answer the following questions. NO
(Yes or No) Auxiliary facility to main facility at powerhouse (Permit A017-50451).

1. Is this source in a non-attainment area for a particular pollutant? NO
 - a. If yes, has "offset" been applied? _____
 - b. If yes, has "Lowest Achievable Emission Rate" been applied? _____
 - c. If yes, list non-attainment pollutants. _____
2. Does best available control technology (BACT) apply to this source? NO
If yes, see Section VI.
3. Does the State "Prevention of Significant Deterioration" (PSD) requirement apply to this source? If yes, see Sections VI and VII. NO
4. Do "Standards of Performance for New Stationary Sources" (NSPS) apply to this source? NO
5. Do "National Emission Standards for Hazardous Air Pollutants" (NESHAP) apply to this source? NO
- Do "Reasonably Available Control Technology" (RACT) requirements apply to this source? NO
 - a. If yes, for what pollutants? _____
 - b. If yes, in addition to the information required in this form, any information requested in Rule 17-2.650 must be submitted.

Attach all supportive information related to any answer of "Yes". Attach any justification for any answer of "No" that might be considered questionable.

SECTION III: AIR POLLUTION SOURCES & CONTROL DEVICES (Other than Incinerators)

Raw Materials and Chemicals Used in your Process, if applicable:

Description	Contaminants		Utilization Rate - lbs/hr	Relate to Flow Diagram
	Type	% Wt		

Process Rate, if applicable: (See Section V, Item 1)

- 1. Total Process Input Rate (lbs/hr): _____
- 2. Product Weight (lbs/hr): _____

Airborne Contaminants Emitted: (Information in this table must be submitted for each emission point, use additional sheets as necessary)

INCINERATOR

Name of Contaminant	Emission ¹		Allowed Emission Rate per Rule 17-2	Allowable Emission lbs/hr	Potential ⁴ Emission		Relate to Flow Diagram
	Maximum lbs/hr	Actual T/yr			lbs/yr	T/yr	

See Section V, Item 2.

Reference applicable emission standards and units (e.g. Rule 17-2.600(5)(b)2. Table II, (1) - 0.1 pounds per million BTU heat input)

Calculated from operating rate and applicable standard.

Emission, if source operated without control (See Section V, Item 3).

Control Devices: (See Section V, Item 4)

Name and Type (Model & Serial No.)	Contaminant	Efficiency	Range of Particles Size Collected (in microns) (If applicable)	Basis for Efficiency (Section V Item 5)

Fuels

Type (Be Specific)	Consumption*		Maximum Heat Input (MMBTU/hr)
	avg/hr	max./hr	

Units: Natural Gas--MMCF/hr; Fuel Oils--gallons/hr; Coal, wood, refuse, other--lbs/hr.

Fuel Analysis:

Percent Sulfur: _____ Percent Ash: _____

Density: _____ lbs/gal Typical Percent Nitrogen: _____

Heat Capacity: _____ BTU/lb _____ BTU/gal

Other Fuel Contaminants (which may cause air pollution): _____

6. If applicable, indicate the percent of fuel used for space heating.

Annual Average _____ Maximum _____

7. Indicate liquid or solid wastes generated and method of disposal.

Best Available Copy

Emission Stack Geometry and Flow Characteristics (Provide data for each stack):

Stack Height: _____ ft. Stack Diameter: _____ ft.
 Gas Flow Rate: _____ ACFM _____ DSCFM Gas Exit Temperature: _____ °F.
 Water Vapor Content: _____ % Velocity: _____ FPS

SECTION IV: INCINERATOR INFORMATION

Type of Waste	Type 0 (Plastics)	Type I (Rubbish)	Type II (Refuse)	Type III (Garbage)	Type IV (Pathological)	Type V (Liq. & Gas By-prod.)	Type VI (Solid By-prod.)
Actual lb/hr Incinerated	SEE SUPPLEMENT 2						
Uncontrolled (lbs/hr)							

Description of Waste: Nylon Polymer
 Total Weight Incinerated (lbs/hr) See supplement 2 Design Capacity (lbs/hr) See supplement 2
 Approximate Number of Hours of Operation per day 24 day/wk 7 wks/yr. 52
 Manufacturer: Pollution Control Products Co., Dallas, Texas
 Date Constructed _____ Model No. IGG-391

	Volume (ft) ³	Heat Release (BTU/hr)	Fuel		Temperature (°F)
			Type	BTU/hr	
Primary Chamber	391 ft. ³	200,000	nat. gas	200,000	900 F
Secondary Chamber	9.5 ft. ³	400,000	nat. gas	400,000	1,500 F

Stack Height: 30 ft. Stack Diameter: 16" OD, 12" ID Stack Temp. 1500 F
 Gas Flow Rate: 630 (@1500 °F) ACFM 155 DSCFM* Velocity: 13.3 FPS

*If 50 or more tons per day design capacity, submit the emissions rate in grains per standard cubic foot dry gas corrected to 50% excess air.

Type of pollution control device: Cyclone Wet Scrubber Afterburner
 Other (specify) _____

Page 6 of 12

$$\text{Residence Time} = \frac{9.5 \text{ FT}^3}{630 \text{ FT}^3/\text{MIN}} = \frac{9.5}{630} \text{ MIN} = 0.015 \text{ MIN} = 0.9 \text{ SECONDS}$$

= 0.9 SECONDS

Brief description of operating characteristics of control devices: _____

The exhaust from the oven passes through the afterburner which is controlled at 1500°F by adjusting the rate of fuel firing.

Ultimate disposal of any effluent other than that emitted from the stack (scrubber water, ash, etc.):

Any ash residue from the nylon would be disposed of in compliance with solid waste and RCRA regulations.

NOTE: Items 2, 3, 4, 6, 7, 8, and 10 in Section V must be included where applicable.

SECTION V: SUPPLEMENTAL REQUIREMENTS

Please provide the following supplements where required for this application.

- . Total process input rate and product weight -- show derivation [Rule 17-2.100(127)]
- 2. To a construction application, attach basis of emission estimate (e.g., design calculations, design drawings, pertinent manufacturer's test data, etc.) and attach proposed methods (e.g., FR Part 60 Methods 1, 2, 3, 4, 5) to show proof of compliance with applicable standards. To an operation application, attach test results or methods used to show proof of compliance. Information provided when applying for an operation permit from a construction permit shall be indicative of the time at which the test was made.
- . Attach basis of potential discharge (e.g., emission factor, that is, AP42 test).
- . With construction permit application, include design details for all air pollution control systems (e.g., for baghouse include cloth to air ratio; for ^{INCINERATOR} scrubber include cross-section sketch, design pressure drop, etc.)
- 5. With construction permit application, attach derivation of control device(s) efficiency. Include test or design data. Items 2, 3 and 5 should be consistent: actual emissions = potential (1-efficiency).
- . An 8 1/2" x 11" flow diagram which will, without revealing trade secrets, identify the individual operations and/or processes. Indicate where raw materials enter, where solid and liquid waste exit, where gaseous emissions and/or airborne particles are evolved and where finished products are obtained.
- . An 8 1/2" x 11" plot plan showing the location of the establishment, and points of airborne emissions, in relation to the surrounding area, residences and other permanent structures and roadways (Example: Copy of relevant portion of USGS topographic map).
- . An 8 1/2" x 11" plot plan of facility showing the location of manufacturing processes and outlets for airborne emissions. Relate all flows to the flow diagram.

- . The appropriate application fee in accordance with Rule 17-4.05. The check should be made payable to the Department of Environmental Regulation.
- . With an application for operation permit, attach a Certificate of Completion of Construction indicating that the source was constructed as shown in the construction permit.

SECTION VI: BEST AVAILABLE CONTROL TECHNOLOGY

. Are standards of performance for new stationary sources pursuant to 40 C.F.R. Part 60 applicable to the source?

Yes No

Contaminant	Rate or Concentration
_____	_____
_____	_____
_____	_____
_____	_____

. Has EPA declared the best available control technology for this class of sources (If yes, attach copy)

Yes No

Contaminant	Rate or Concentration
_____	_____
_____	_____
_____	_____
_____	_____

. What emission levels do you propose as best available control technology?

Contaminant	Rate or Concentration
_____	_____
_____	_____
_____	_____
_____	_____

. Describe the existing control and treatment technology (if any).

- | | |
|---------------------------|--------------------------|
| 1. Control Device/System: | 2. Operating Principles: |
| 3. Efficiency:* | 4. Capital Costs: |

Explain method of determining

- 5. Useful Life:
- 7. Energy:
- 9. Emissions:

- 6. Operating Costs:
- 8. Maintenance Cost:

Contaminant	Rate or Concentration

10. Stack Parameters

- a. Height: ft. b. Diameter: ft.
- c. Flow Rate: ACFM d. Temperature: °F.
- e. Velocity: FPS

11. Describe the control and treatment technology available (As many types as applicable, use additional pages if necessary).

1.
 - a. Control Device: b. Operating Principles:
 - c. Efficiency:¹ d. Capital Cost:
 - e. Useful Life: f. Operating Cost:
 - g. Energy:² h. Maintenance Cost:
 - i. Availability of construction materials and process chemicals:
 - j. Applicability to manufacturing processes:
 - k. Ability to construct with control device, install in available space, and operate within proposed levels:

2.
 - a. Control Device: b. Operating Principles:
 - c. Efficiency:¹ d. Capital Cost:
 - e. Useful Life: f. Operating Cost:
 - g. Energy:² h. Maintenance Cost:
 - i. Availability of construction materials and process chemicals:

¹ Explain method of determining efficiency.

² Energy to be reported in units of electrical power - KWH design rate.

- j. Applicability to manufacturing processes:
- k. Ability to construct with control device, install in available space, and operate within proposed levels:

3.

- a. Control Device:
- b. Operating Principles:
- c. Efficiency:¹
- d. Capital Cost:
- e. Useful Life:
- f. Operating Cost:
- g. Energy:²
- h. Maintenance Cost:
- i. Availability of construction materials and process chemicals:
- j. Applicability to manufacturing processes:
- k. Ability to construct with control device, install in available space, and operate within proposed levels:

4.

- a. Control Device:
- b. Operating Principles:
- c. Efficiency:¹
- d. Capital Costs:
- e. Useful Life:
- f. Operating Cost:
- g. Energy:²
- h. Maintenance Cost:
- i. Availability of construction materials and process chemicals:
- j. Applicability to manufacturing processes:
- k. Ability to construct with control device, install in available space, and operate within proposed levels:

Describe the control technology selected:

- 1. Control Device:
- 2. Efficiency:¹
- 3. Capital Cost:
- 4. Useful Life:
- 5. Operating Cost:
- 6. Energy:²
- 7. Maintenance Cost:
- 8. Manufacturer:
- 9. Other locations where employed on similar processes:

a. (1) Company:

(2) Mailing Address:

(3) City:

(4) State:

Explain method of determining efficiency.

Energy to be reported in units of electrical power - KWH design rate.

(5) Environmental Manager:

(6) Telephone No.:

(7) Emissions:¹

Contaminant

Rate or Concentration

Contaminant	Rate or Concentration

(8) Process Rate:¹

b. (1) Company:

(2) Mailing Address:

(3) City:

(4) State:

(5) Environmental Manager:

(6) Telephone No.:

(7) Emissions:¹

Contaminant

Rate or Concentration

Contaminant	Rate or Concentration

(8) Process Rate:¹

10. Reason for selection and description of systems:

Applicant must provide this information when available. Should this information not be available, applicant must state the reason(s) why.

SECTION VII - PREVENTION OF SIGNIFICANT DETERIORATION

Company Monitored Data

1. _____ no. sites _____ TSP _____ () SO₂ _____ Wind spd/dir

Period of Monitoring _____ / _____ / _____ to _____ / _____ / _____
month day year month day year

Other data recorded _____

Attach all data or statistical summaries to this application.

Specify bubbler (B) or continuous (C).

2. Instrumentation, Field and Laboratory

- a. Was instrumentation EPA referenced or its equivalent? Yes No
- b. Was instrumentation calibrated in accordance with Department procedures?
 Yes No Unknown

Metorological Data Used for Air Quality Modeling

- 1. _____ Year(s) of data from _____ / _____ / _____ to _____ / _____ / _____
month day year month day year
- 2. Surface data obtained from (location) _____
- 3. Upper air (mixing height) data obtained from (location) _____
- 4. Stability wind rose (STAR) data obtained from (location) _____

Computer Models Used

- 1. _____ Modified? If yes, attach description.
- 2. _____ Modified? If yes, attach description.
- 3. _____ Modified? If yes, attach description.
- 4. _____ Modified? If yes, attach description.

Attach copies of all final model runs showing input data, receptor locations, and principle output tables.

Applicants Maximum Allowable Emission Data

Pollutant	Emission Rate
TSP	_____ grams/sec
SO ₂	_____ grams/sec

Emission Data Used in Modeling

Attach list of emission sources. Emission data required is source name, description of point source (on NEDS point number), UTM coordinates, stack data, allowable emissions, and normal operating time.

- Attach all other information supportive to the PSD review.
- Discuss the social and economic impact of the selected technology versus other applicable technologies (i.e., jobs, payroll, production, taxes, energy, etc.). Include assessment of the environmental impact of the sources.
- Attach scientific, engineering, and technical material, reports, publications, journals, and other competent relevant information describing the theory and application of the requested best available control technology.

SUPPLEMENT 1

MONSANTO-PENSACOLA

NYLON POLYMERIZATION EQUIPMENT AUXILIARY
INCINERATOR FACILITY

PROCESS DESCRIPTION

A batch-type pyrolysis oven removes nylon from polymerization equipment. The external dimensions of the oven are 93" wide x 131" length x 98" height*. The parts (filter housings, piping, etc.) are heated to 900°F in an oxygen-deficient atmosphere and the nylon is decomposed to a volatile organic material. Temperature control is maintained by changes in natural gas burning rate and dual water spray (steam) system. Total cycle time including heat-up is approximately 10-15 hours per batch.

The oven exhausts to an afterburner incinerator. There the exhaust gas passes through a combustion chamber and is raised to 1500°F** for a minimum of one-half second with sufficient air to completely burn it before venting to the atmosphere. Temperature control is maintained by automatic control of gas firing rate. High and low temperature, controllers plus high and low pressure gas switches and electric main safety gas shut-off valve are provided.

Complete combustion of the nylon is assured by maintaining no visible emissions at the afterburner exhaust vent.

* See the cross-section drawing provided. Primary and secondary combustion chamber integrally constructed.

** Minimum afterburner operating temperature is 1400°F.

INCIN.APP

SUPPLEMENT 2

MONSANTO-PENSACOLA

NYLON POLYMERIZATION EQUIPMENT AUXILIARY
INCINERATOR FACILITY

INCINERATION RATE

The pyrolysis oven is typically filled with polymerization equipment containing 25-100 lbs.*. of nylon within the parts. The nylon is incinerated in a batch cycle that depends upon the amount of nylon, at the rate of 10-20 lbs./hours**. Add maximum anual incineration of nylon will not exceed \$20,000 lbs/yr. The process is described in supplement 1.

* Maximum pounds of nylon per charge is 200 lbs.

** Maximum nylon burn-off rate if 30 lbs./hour.

INCIN.APP

SUPPLEMENT 3

MONSANTO - PENSACOLA

NYLON POLYMERIZATION EQUIPMENT AUXILIARY INCINERATOR FACILITY

PROCESS DIAGRAM

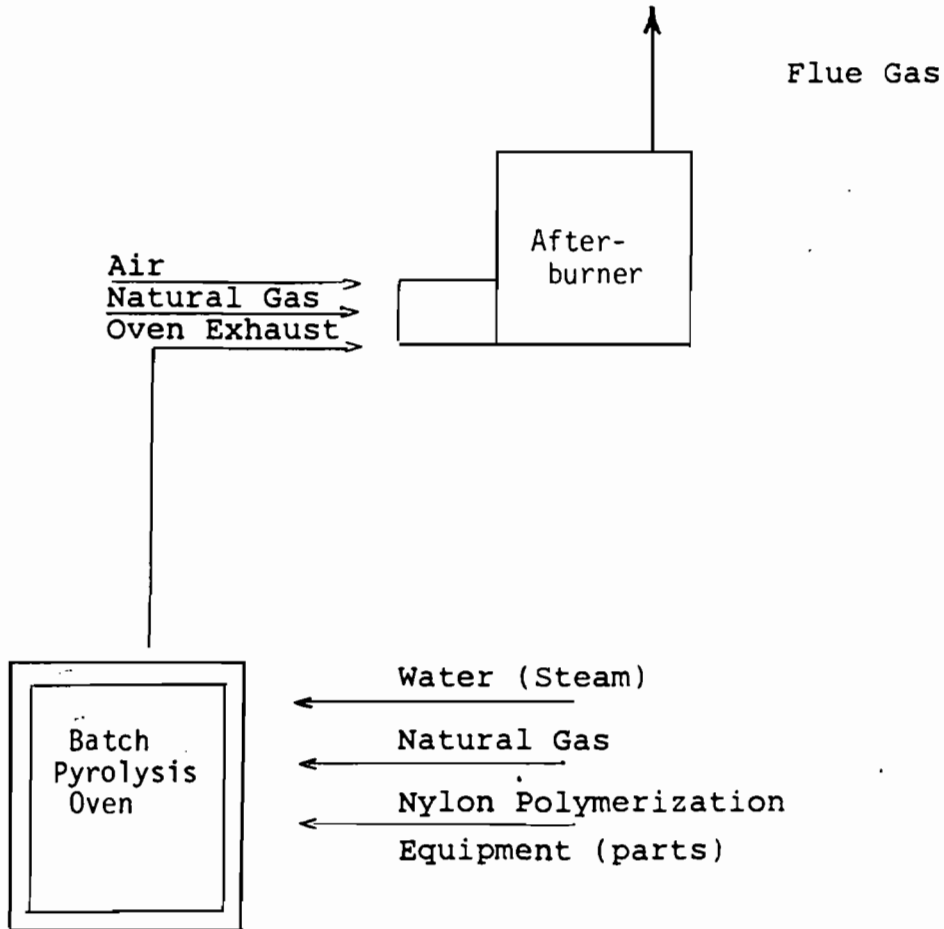

30°37'

30°34'

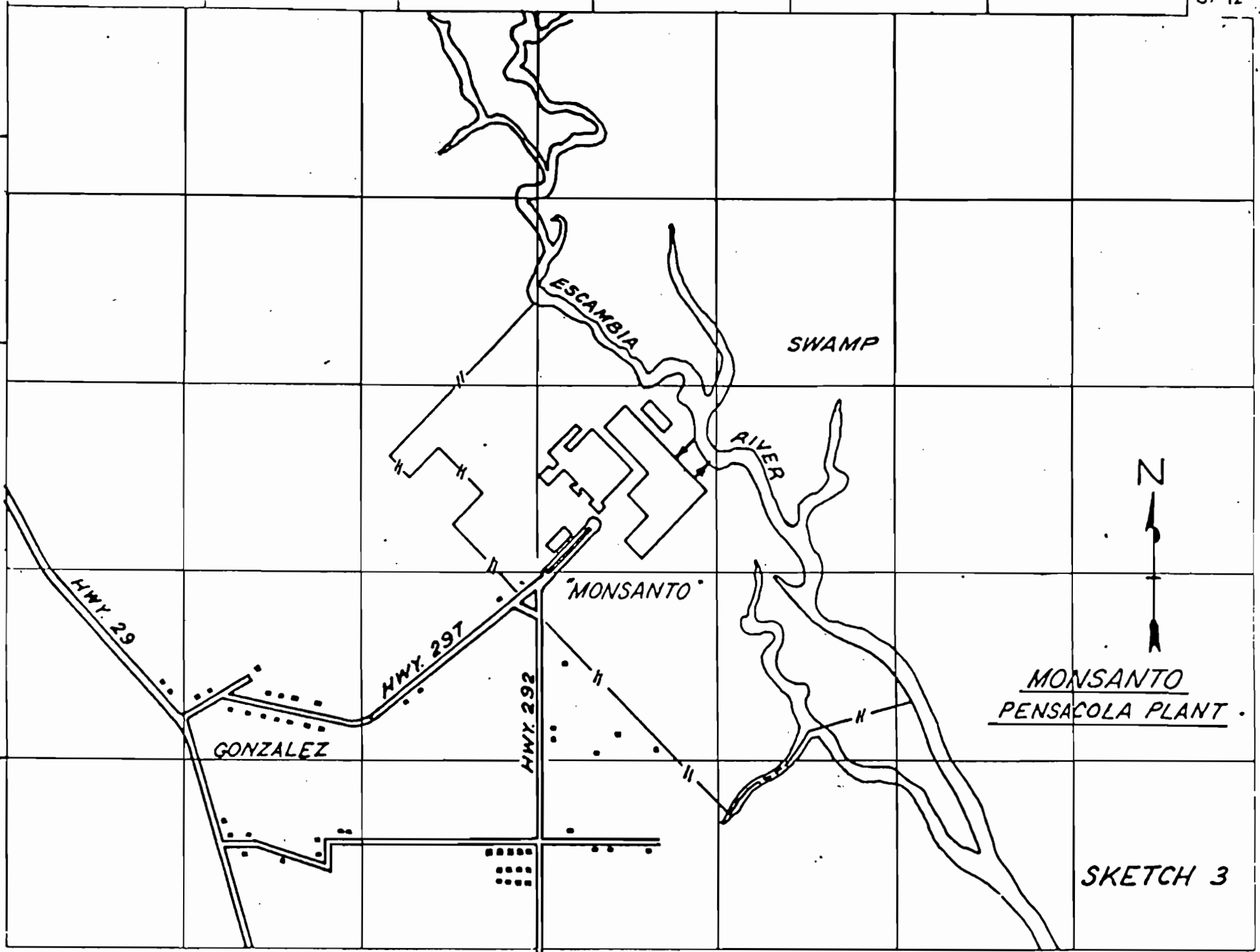

MONSANTO
PENSACOLA PLANT



SKETCH 3

-3-

1 0.5 0 1 2 MILES

SCALE

**MONSANTO
PENSACOLA PLANT
400' GRID**

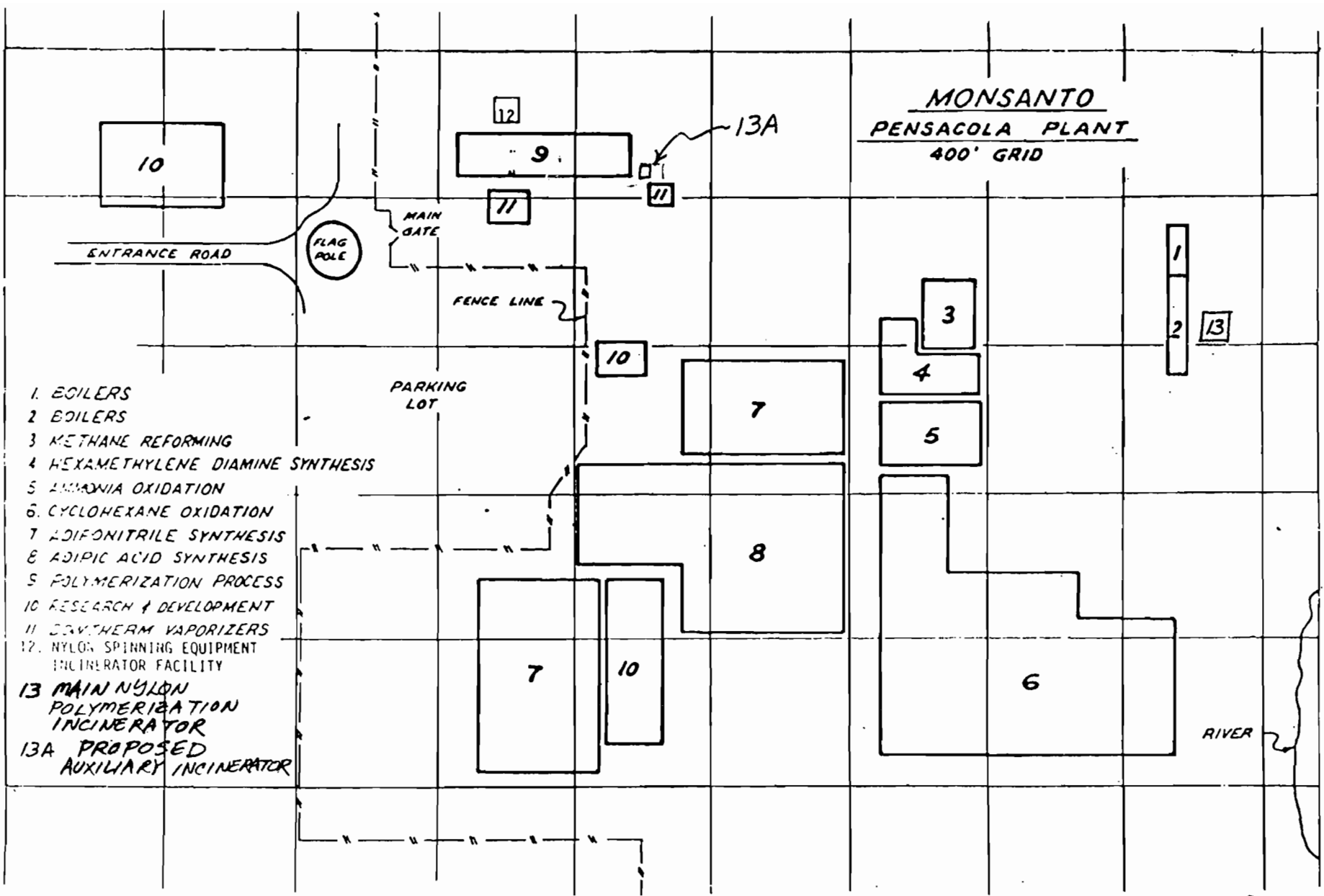

- 1. BOILERS
- 2. BOILERS
- 3. METHANE REFORMING
- 4. HEXAMETHYLENE DIAMINE SYNTHESIS
- 5. AMMONIA OXIDATION
- 6. CYCLOHEXANE OXIDATION
- 7. ADIPONITRILE SYNTHESIS
- 8. ADIPIC ACID SYNTHESIS
- 9. POLYMERIZATION PROCESS
- 10. RESEARCH & DEVELOPMENT
- 11. SOUVENIR VAPORIZERS
- 12. NYLON SPINNING EQUIPMENT
INCINERATOR FACILITY
- 13. MAIN NYLON
POLYMERIZATION
INCINERATOR
- 13A. PROPOSED
AUXILIARY INCINERATOR

**Clean your plastics extruder hardware
and other polymer or adhesive produc-
tion equipment the easy way with a**

**CONTROLLED
PYROLYSIS**™

CLEANING FURNACE

U. S. PATENT 4,270,806

THIS FURNACE REMOVES PLASTICS AND COATINGS OF CONVENTIONAL HYDROCARBONS FROM METAL PARTS BY THERMAL PYROLYSIS (CLEANING WITH HEAT). THE PARTS ARE HEATED TO 800-900°F (427-482°C) IN A OXYGEN-DEFICIENT ATMOSPHERE AND THE PLASTICS ARE DECOMPOSED TO VOLATILE SMOKE. THE SMOKE PASSES THROUGH A COMBUSTION CHAMBER AND IS RAISED TO 1400°F (760°C) FOR A MINIMUM OF ONE-HALF SECOND WITH SUFFICIENT AIR TO COMPLETELY BURN IT BEFORE VENTING TO THE ATMOSPHERE. THE DISCHARGED EFFLUENT CONSISTS PRIMARILY OF CARBON DIOXIDE AND WATER VAPOR WHICH ARE INVISIBLE, ODORLESS, AND HARMLESS.

PLASTICS WHICH WILL MELT AND FLOW DURING CLEANING DRAIN FROM THE PARTS INTO A COOL COLLECTION CHAMBER WHERE THE PLASTIC SOLIDIFIES AND CAN BE EASILY REMOVED. THIS FEATURE ALLOWS SIGNIFICANTLY SHORTER CLEANING TIMES FOR METAL PARTS CONTAMINATED WITH RELATIVELY LARGE AMOUNTS OF PLASTIC.

INTERIOR VOLUMES

27 to 340 CUBIC FEET

Available in a wide range of sizes. Seven standard models with interior dimensions 3' wide x 3' high x 3' deep up to 7' x 7' x 7'. Custom sizes also available. Heavy duty carts are designed to hold a variety of parts and rolls outside the furnace on removable tracks for easy loading and unloading.

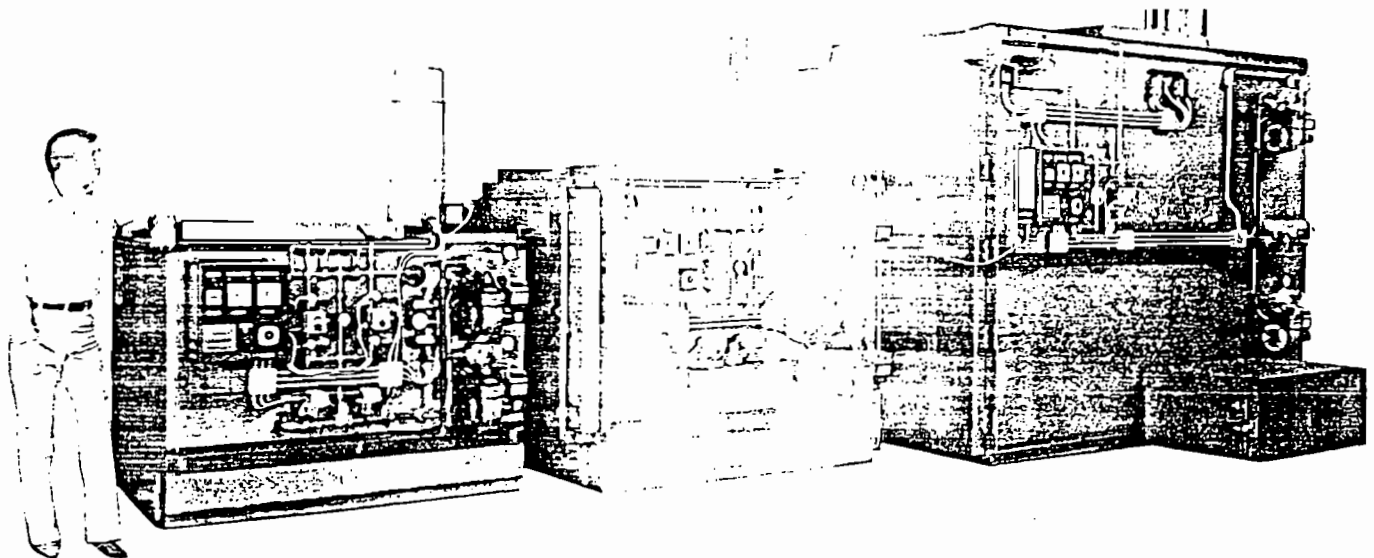
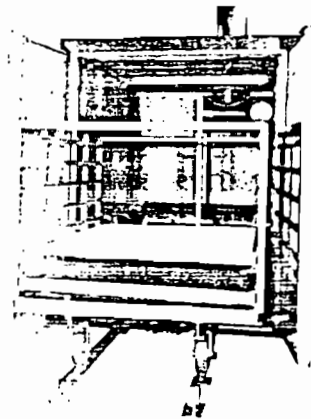

SPECIFICATIONS AND DATA

CABINET: Heavy-gauge sheet steel supported by structural steel angles and channels. All-welded construction with sealed seams to prevent air leakage gives maximum fuel economy and safety.

FLOOR: Hard castable refractory, 3" thick, reinforced with structural steel channels.

DOORS: Equipped with cam-type lock assemblies, tad-pole sealing gaskets, and stay-open hooks. Doors open slightly over 90°. Door switch ensures door(s) are open during timed purge before burners are ignited.

EXPLOSION RELIEF: Required on all furnaces and ovens. Unique gravity-sealed top relief automatically opens to relieve excess pressure, then closes, preventing air from reaching combustible material. Conventional spring-latched front doors or blow-out panels used for explosion relief do not provide this important safety feature because, once opened, such doors or panels do not close to keep out air, and material inside will burn freely.

INSULATION: Walls are covered with 4" of a two-layered light-weight ceramic fiber blanket insulation anchored on stainless steel pins, stainless wire mesh, and stainless locking washers. Contains no asbestos and has superior properties to asbestos or fiberglass. Hot face insulation rated at 2300°F (1260°C) and one inch is equivalent to 9" of conventional refractory or firebrick with one-tenth the weight, making these furnaces much lighter in weight and much faster to heat with less fuel. Ceilings and doors are covered with 3" of the two layered insulation. Special outer sheet metal panels with air insulating construction reduce the outer wall temperatures of the sides and back to a minimum.

VENT STACK: Made in 36" long light-weight sections for easy erection. Galvanized metal exterior lined with high-temperature ceramic fiber in hard form. Sections snap together. Adjustable-pitch roof flashing, storm collar, and rain cap furnished with stack.

FUELS: Natural gas, propane gas, or #2 fuel oil. Minimum input 250,000 BTU/hr. to maximum 375,000 BTU/hr. Gas pressure required 7 inches water column (.18 meter). Gas train equipped with approved low and high gas pressure switches, electric main safety gas shut-off valve, and test cock.

ELECTRICAL SERVICE: 110-125 volts, 50-60 hertz, single-phase, 7 ampere draw. Optional transformers available for other voltages.

WATER SUPPLY: Minimum pressure 40 psi (2 atmos.); maximum 100 psi (6 atmos.) for water injection system. Minimum flow rate 0.3 gpm (1.2 liter/min.) to 0.9 gpm (3.6 liter/min.). Water spray injection is intermittent, on demand from temperature controllers, not continuous.

NORMAL CLEANING TIME: Typically 2-4 hours plus cooling time. Actual cleaning times vary with the amount of metal and polymer loaded to furnace. Time adjustable 0-12 hours.

NORMAL CLEANING TEMPERATURE: 800-900°F (427-482°C). Two dual-set point temperature controllers, range 0-2000°F (-18°C to 1093°C) with Fahrenheit and Celsius scales.

POLLUTION STANDARDS: Meets latest E.P.A. Federal Standards for Incinerators.

SAFETY AND HEALTH STANDARDS: Meets latest O.S.H.A. Federal Standards.

INSURANCE STANDARDS: Meets most state and local codes.

MODEL NO.	OUTSIDE DIMENSIONS						DOOR OPENING				INSIDE DEPTH FRONT TO BACK	CART INSIDE DIMENSIONS						APPROX. SHIP. WT.		
	WIDTH		DEPTH		HEIGHT		WIDTH		HEIGHT			WIDTH		DEPTH		HEIGHT				
	IN.	M.	IN.	M.	IN.	M.	IN.	M.	IN.	M.		IN.	M.	IN.	M.	IN.	M.	LBS	KGS	
IGG 27	45	1.14	65	1.65	52	1.32	34	0.86	36	0.91	36	0.91	25	0.64	32	0.82	28	0.71	1960	890
IGG 52	51	1.30	71	1.80	65	1.66	40	1.02	45	1.14	48	1.22	31	0.79	45	1.14	32	0.82	2340	1061
IGG 88	57	1.45	83	2.11	73	1.85	46	1.17	60	1.52	52	1.32	37	0.94	48	1.22	36	0.91	3770	1710
IGG 150	69	1.75	95	2.41	85	2.16	58	1.47	72	1.83	64	1.63	49	1.24	60	1.52	48	1.22	4960	2250
IGG 260	75	1.91	119	3.02	98	2.49	64	1.63	84	2.13	88	2.24	55	1.40	84	2.13	60	1.52	6670	3025
IGG 290	81	2.06	119	3.02	98	2.49	70	1.78	84	2.13	88	2.24	61	1.55	84	2.13	60	1.52	6870	3116
IGG 340	93	2.36	119	3.02	98	2.49	82	2.08	84	2.13	88	2.24	73	1.85	84	2.13	60	1.52	7190	3261

→ IGG 391 93 131 98 82 84 100 73 96 60 7500
 MONSANTO UNIT

manufactured by

POLLUTION
 CONTROL
 PRODUCTS CO.

2677 FREWOOD DRIVE
 DALLAS, TEXAS 75220
 214-358-1539

79 WHYTELEAF ROAD
 CATERHAM, SURREY CR3 5EJ

©1983 P.C.P.C. CATERHAM (0883) 45044

LOADING DOOR(S) ON ALL SIZES
 TRACK THAT MODEL 166-27. THESE MODELS
 REMOVE CARTS THAT ROLL OUT FOR LOADING/UNLOADING.

EXPLOSION RELIEF DOOR(S) ON TOP
 OF FURNACE. [ALSO SERVES AS
 LOADING DOOR ON MODEL 166-27]

PYROLYSIS SMOKE AND
 GASES INTO AFTERBURNER

CARTS ON RACK TO HOLD PARTS

PARTS TO
 BE CLEANED

FURNACE
 RAISED FROM
 TO 900°F

TEMPERATURE
 ROOM TEMPERATURE
 (482°C)

DRAIN PAN

COLLECTION TRAY FOR POLYMER

COLLECTION CHAMBER

SIDE VIEW

COLLECTION CHAMBER DOOR ON
 MODELS 166-27 and 166-52.
 LARGER MODELS HAVE SIDE
 MOUNTED COLLECTION
 CHAMBER

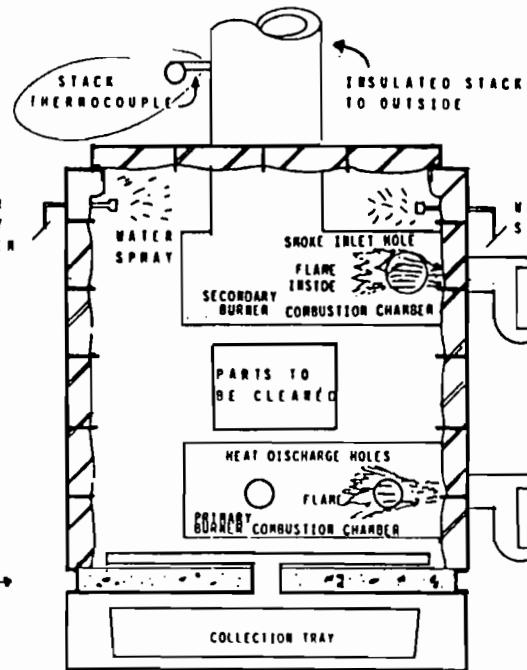

WATER SPRAY SYSTEM NO. 2

INSULATED STACK TO OUTSIDE

WATER SPRAY SYSTEM NO. 1

SECONDARY BURNER
 GAS/AIR RATIO ADJUSTED TO OPERATE
 WITH EXCESS AIR FOR DIRECT FLAME
 INCUBERATION OF PYROLYSIS SMOKE
 AND GASES AT 1400 - 1500 F.

PRIMARY BURNER:
 GAS/AIR RATIO ADJUSTED TO GIVE LOW
 OXYGEN CONTENT (5-10%) COMBUSTION
 GASES FOR HEATING PARTS AND INERTING
 FURNACE ATMOSPHERE

INSULATED FLOOR

COLLECTION CHAMBER

FRONT VIEW

FIGURE 1
 SIMPLIFIED OPERATION OF MODEL 166
 CONTROLLED PYROLYSIS CLEANING FURNACES

REV.	DATE	DESCRIPTION OF CHANGE	BY
<p>POLLUTION CONTROL PRODUCTS CO. DALLAS, TEXAS</p> <p>SIMPLIFIED OPERATION OF MODEL 166 CONTROLLED PYROLYSIS CLEANING FURNACES</p>			
SCALE	80% C	DR. BY	DI TARTAGIO
DATE	6/20/81	CHD. BY	RAIBORD
OWPL	STX 8		
SHEET	OF	OWPL NO.	

CD/FORTROW

RETURN

UTM LL

Return

3 end program

C) -> a flash, ready to go

CD/Fortran

PG PLU

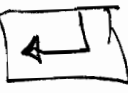
Return → 

Control + P to Print
Ctrl + S ←

hit together
, " again, turned off

7 Run

8 end