

SENDER:

- Complete items 1 and/or 2 for additional services.
- Complete items 3, and 4a & b.
- Print your name and address on the reverse of this form so that we can return this card to you.
- Attach this form to the front of the mailpiece, or on the back if space does not permit.
- Write "Return Receipt Requested" on the mailpiece next to the article number.

I also wish to receive the following services (for an extra fee):

1. Addressee's Address
2. Restricted Delivery

Consult postmaster for fee.

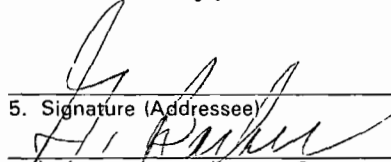
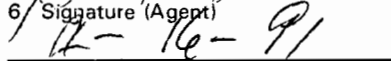
| | |
|--|---|
| 3. Article Addressed to: Mr. L. D. Riley, Jr. Stone Container Corporation P. O. Box 2560 Panama City, FL 32402 | 4a. Article Number P 832 538 751 |
| 5. Signature (Addressee)  | 4b. Service Type <input type="checkbox"/> Registered <input type="checkbox"/> Insured <input checked="" type="checkbox"/> Certified <input type="checkbox"/> COD <input type="checkbox"/> Express Mail <input type="checkbox"/> Return Receipt for Merchandise |
| 6. Signature (Agent)  | 7. Date of Delivery 8. Addressee's Address (Only if requested and fee is paid) |

PS Form 3811, October 1990

☆ U.S. GPO: 1990-273-861

DOMESTIC RETURN RECEIPT

P 832 538 751



Certified Mail Receipt

No Insurance Coverage Provided

Do not use for International Mail

(See Reverse)

PS Form 3800, June 1990

| | |
|---|----|
| Sent to | |
| Mr. L. D. Riley, Jr., Stone | |
| Street & No. Container Corp. | |
| P. O. Box 2560 | |
| P.O., State & ZIP Code | |
| Panama City, FL 32402 | |
| Postage | \$ |
| Certified Fee | |
| Special Delivery Fee | |
| Restricted Delivery Fee | |
| Return Receipt Showing to Whom & Date Delivered | |
| Return Receipt Showing to Whom, Date, & Address of Delivery | |
| TOTAL Postage & Fees | \$ |
| Postmark or Date | |
| Mailed: 12-13-91 | |
| Permit: AC 03-190964 | |

STATE OF FLORIDA
DEPARTMENT OF ENVIRONMENTAL REGULATION
NOTICE OF PERMIT

In the matter of an
Application for Permit by:

DER File No. AC 03-190964
Bay County

Mr. L. D. Riley, Jr.
Stone Container Corporation
P. O. Box 2560
Panama City, Florida 32402

Enclosed is Permit Number AC 03-190964 for a modification to allow the use of the No. 4 Bark Boiler as the back-up TRS incinerator to the lime kiln on a continuous basis (i.e., 8760 hrs/yr) and to establish emission standards and operation requirements while operating at 100% fossil fuel. The facility is located in Panama City, Bay County, Florida. This permit is issued pursuant to Section(s) 403, Florida Statutes.

Any party to this Order (permit) has the right to seek judicial review of the permit pursuant to Section 120.68, Florida Statutes, by the filing of a Notice of Appeal pursuant to Rule 9.110, Florida Rules of Appellate Procedure, with the Clerk of the Department in the Office of General Counsel, 2600 Blair Stone Road, Tallahassee, Florida 32399-2400; and by filing a copy of the Notice of Appeal accompanied by the applicable filing fees with the appropriate District Court of Appeal. The Notice of Appeal must be filed within 30 days from the date this Notice is filed with the Clerk of the Department.

Executed in Tallahassee, Florida.

STATE OF FLORIDA DEPARTMENT
OF ENVIRONMENTAL REGULATION

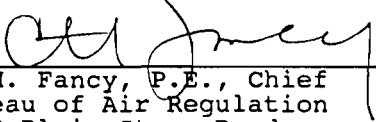

C. H. Fancy, P.E., Chief
Bureau of Air Regulation
2600 Blair Stone Road
Tallahassee, FL 32399-2400
904-488-1344

CERTIFICATE OF SERVICE

The undersigned duly designated deputy agency clerk hereby certifies that this NOTICE OF PERMIT and all copies were mailed before the close of business on 12-13-91 to the listed persons.

Clerk Stamp

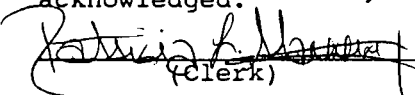
FILING AND ACKNOWLEDGMENT FILED,
on this date, pursuant to
§120.52(11), Florida Statutes,
with the designated Department
Clerk, receipt of which is hereby
acknowledged.

(Clerk)

12-13-91
(Date)

Copies furnished to:

E. Middleswart, NW District
C. T. Fontaine, P.E., SCC
J. Harper, EPA

APIS update

1/27/92
RBS

Final Determination

Stone Container Corporation
Bay County
Panama City, Florida

Construction Permit No.
AC 03-190964

Department of Environmental Regulation
Division of Air Resources Management
Bureau of Air Regulation

December 4, 1991

Final Determination

The construction permit application package has been reviewed by the Department. Public Notice of the Department's Intent to Issue was published in the News Herald on November 8, 1991. The Technical Evaluation and Preliminary Determination was distributed on August 1, 1991, and available for public inspection at the Department's Northwest District office and the Department's Bureau of Air Regulation office.

There were no comments received during the public notice period. However, the expiration date was changed from December 31, 1991, to June 30, 1992, to allow sufficient time for Stone Container Corporation to apply for and obtain an operation permit. Therefore, it is recommended that the construction permit be issued as drafted.



Florida Department of Environmental Regulation

Twin Towers Office Bldg. • 2600 Blair Stone Road • Tallahassee, Florida 32399-2400

Lawton Chiles, Governor

Carol M. Browner, Secretary

PERMITTEE:
Stone Container Corporation
Post Office Box 2560
Panama City, Florida 32402

Permit Number: AC 03-190964
Expiration Date: June 30, 1992
County: Bay
Latitude/Longitude: 30°08'30"N
85°37'25"W

Project: No. 4 Bark Boiler
Modification

This permit is issued under the provisions of Chapter 403, Florida Statutes, Florida Administrative Code (F.A.C.) Chapters 17-2 and 17-4, and 40 CFR (July, 1990 version). The above named permittee is hereby authorized to perform the work or operate the facility shown on the application and approved drawings, plans, and other documents attached hereto or on file with the Department and made a part hereof and specifically described as follows:

For a modification to the No. 4 Bark Boiler by designating it as the secondary control device (incinerator) of the TRS gases from the TRS noncondensable gas handling and transport system on an as needed basis, with the lime kiln remaining as the primary incinerator. The TRS gases are collected from the Nos. 1A, 2, and 3 Multiple Effect Evaporator (MEE) Systems and the batch digesting blow heat recovery system. The No. 4 Bark Boiler's capacity is 300,000 pounds of steam produced per hour. A venturi scrubber system will use pH control (i.e., pH @ 8.0 minimum) to minimize SO₂ emissions. The UTM coordinates of the existing facility are Zone 16, 632.8 km East and 3355.1 km North.

The Standard Industrial Codes are: 2611-Pulp Mill.
2621-Paper Mill.

The Standard Classification Code is:

- o External Combustion Boilers: 1-02-009-02 tons burned
Wood/Bark Waste

The source shall be constructed/modified in accordance with the permit application, plans, documents, amendments and drawings, except as otherwise noted in the General and Specific Conditions.

Attachments to be Incorporated:

1. Mr. David Riley's letter received December 21, 1990, via FAX.
2. Application to Construct/Modify Air Pollution Sources, DER Form 17-1.202(1), received May 23, 1991.
3. Interoffice Memorandum by Bruce Mitchell dated July 26, 1991.
4. Mr. C. H. Fancy's letter dated April 5, 1990.
5. Technical Evaluation and Preliminary Determination dated July 31, 1991.

PERMITTEE:
Stone Container Corporation

Permit Number: AC 03-190964
Expiration Date: June 30, 1992

GENERAL CONDITIONS:

1. The terms, conditions, requirements, limitations, and restrictions set forth in this permit are "Permit Conditions" and are binding and enforceable pursuant to Sections 403.161, 403.727, or 403.859 through 403.861, Florida Statutes. The permittee is placed on notice that the Department will review this permit periodically and may initiate enforcement action for any violation of these conditions.

2. This permit is valid only for the specific processes and operations applied for and indicated in the approved drawings or exhibits. Any unauthorized deviation from the approved drawings, exhibits, specifications, or conditions of this permit may constitute grounds for revocation and enforcement action by the Department.

3. As provided in Subsections 403.087(6) and 403.722(5), Florida Statutes, the issuance of this permit does not convey any vested rights or any exclusive privileges. Neither does it authorize any injury to public or private property or any invasion of personal rights, nor any infringement of federal, state or local laws or regulations. This permit is not a waiver of or approval of any other Department permit that may be required for other aspects of the total project which are not addressed in the permit.

4. This permit conveys no title to land or water, does not constitute State recognition or acknowledgement of title, and does not constitute authority for the use of submerged lands unless herein provided and the necessary title or leasehold interests have been obtained from the State. Only the Trustees of the Internal Improvement Trust Fund may express State opinion as to title.

5. This permit does not relieve the permittee from liability for harm or injury to human health or welfare, animal, or plant life, or property caused by the construction or operation of this permitted source, or from penalties therefore; nor does it allow the permittee to cause pollution in contravention of Florida Statutes and Department rules, unless specifically authorized by an order from the Department.

6. The permittee shall properly operate and maintain the facility and systems of treatment and control (and related appurtenances) that are installed or used by the permittee to achieve compliance with the conditions of this permit, as required by Department rules. This provision includes the operation of backup or auxiliary facilities or similar systems when necessary to achieve compliance with the conditions of the permit and when required by Department rules.

PERMITTEE:
Stone Container Corporation

Permit Number: AC 03-190964
Expiration Date: June 30, 1992

GENERAL CONDITIONS:

7. The permittee, by accepting this permit, specifically agrees to allow authorized Department personnel, upon presentation of credentials or other documents as may be required by law and at a reasonable time, access to the premises, where the permitted activity is located or conducted to:

- a. Have access to and copy any records that must be kept under the conditions of the permit;
- b. Inspect the facility, equipment, practices, or operations regulated or required under this permit; and,
- c. Sample or monitor any substances or parameters at any location reasonably necessary to assure compliance with this permit or Department rules.

Reasonable time may depend on the nature of the concern being investigated.

8. If, for any reason, the permittee does not comply with or will be unable to comply with any condition or limitation specified in this permit, the permittee shall immediately provide the Department with the following information:

- a. a description of and cause of non-compliance; and,
- b. the period of noncompliance, including dates and times; or, if not corrected, the anticipated time the non-compliance is expected to continue, and steps being taken to reduce, eliminate, and prevent recurrence of the non-compliance.

The permittee shall be responsible for any and all damages which may result and may be subject to enforcement action by the Department for penalties or for revocation of this permit.

9. In accepting this permit, the permittee understands and agrees that all records, notes, monitoring data and other information relating to the construction or operation of this permitted source which are submitted to the Department may be used by the Department as evidence in any enforcement case involving the permitted source arising under the Florida Statutes or Department rules, except where such use is proscribed by Sections 403.73 and 403.111, Florida Statutes. Such evidence shall only be used to the extent it is consistent with the Florida Rules of Civil Procedure and appropriate evidentiary rules.

PERMITTEE:
Stone Container Corporation

Permit Number: AC 03-190964
Expiration Date: June 30, 1992

GENERAL CONDITIONS:

10. The permittee agrees to comply with changes in Department rules and Florida Statutes after a reasonable time for compliance, provided, however, the permittee does not waive any other rights granted by Florida Statutes or Department rules.

11. This permit is transferable only upon Department approval in accordance with Florida Administrative Code Rules 17-4.120 and 17-30.300, F.A.C., as applicable. The permittee shall be liable for any non-compliance of the permitted activity until the transfer is approved by the Department.

12. This permit or a copy thereof shall be kept at the work site of the permitted activity.

13. The permittee shall comply with the following:

a. Upon request, the permittee shall furnish all records and plans required under Department rules. During enforcement actions, the retention period for all records will be extended automatically unless otherwise stipulated by the Department.

b. The permittee shall hold at the facility or other location designated by this permit records of all monitoring information (including all calibration and maintenance records and all original strip chart recordings for continuous monitoring instrumentation) required by the permit, copies of all reports required by this permit, and records of all data used to complete the application for this permit. These materials shall be retained at least three years from the date of the sample, measurement, report, or application unless otherwise specified by Department rule.

c. Records of monitoring information shall include:

- the date, exact place, and time of sampling or measurements;
- the person responsible for performing the sampling or measurements;
- the dates analyses were performed;
- the person responsible for performing the analyses;
- the analytical techniques or methods used; and,
- the results of such analyses.

PERMITTEE:
Stone Container Corporation

Permit Number: AC 03-190964
Expiration Date: June 30, 1992

GENERAL CONDITIONS:

14. When requested by the Department, the permittee shall within a reasonable time furnish any information required by law which is needed to determine compliance with the permit. If the permittee becomes aware that relevant facts were not submitted or were incorrect in the permit application or in any report to the Department, such facts or information shall be corrected promptly.

SPECIFIC CONDITIONS:

1. This permit, which is for the No. 4 Bark Boiler, shall supercede previous air permits issued.

2. The No. 4 Bark Boiler may operate continuously, i.e., 8760 hrs/yr, including the incineration of TRS gases.

3. The maximum rated capacity is 300,000 pounds of steam produced per hour from firing any combination of fuels of wood waste, No. 6 fuel oil, coal, and turpentine residue.

4. The maximum fuel utilization rates, heat inputs, and their maximum % sulfur content, by weight, are:

| | | | |
|------------------|--------------|--------------|------|
| o No. 6 Fuel Oil | 3150 gals/hr | 472 MMBtu/hr | 2.4% |
| o Coal | 15.8 TPH | 395 MMBtu/hr | 1.7% |
| o Wood Bark | 30.0 TPH | 273 MMBtu/hr | - |
| o Natural Gas | 0.04 MMcf/hr | 40 MMBtu/hr | - |

5. When the TRS gases from the Nos. 1A, 2, and 3 MEE Systems and the batch digesting system are collected and transported to the No. 4 Bark Boiler for incineration, then the TRS gases shall be subjected to a minimum of 1200°F for at least 0.5 seconds.

6. A continuous temperature monitor shall be installed, calibrated, and operated in accordance with F.A.C. Rule 17-2.710. Also, a continuous recorder for the temperature shall be installed, calibrated, and properly operated.

7. The No. 4 Bark Boiler is subject to the provisions of F.A.C. Rule 17-2.600(4)(c)1.c., which includes the requirement of establishing a contingency plan.

8. The No. 4 Bark Boiler is subject to the provisions of F.A.C. Rules 17-4.130: Plant Operation-Problems; 17-2.240: Circumvention, 17-2.250: Excess Emissions; and, 17-2.710(4): Quarterly Reporting Requirements.

9. The project shall comply with all applicable provisions of F.A.C. Chapters 17-2 and 17-4 and 40 CFR (July, 1990 version).

PERMITTEE:
Stone Container Corporation

Permit Number: AC 03-190964
Expiration Date: June 30, 1992

SPECIFIC CONDITIONS:

10. The No. 4 Bark Boiler emissions shall not exceed:

- a) TRS: 5 ppmvd at standard conditions, corrected to 10% O₂,
12-hr avg (4.35 lbs/hr; 19.1 TPY)
- b) SO₂: 772 lbs/hr; 3381 TPY (No TRS Incineration)
781 lbs/hr; 3420 TPY (TRS Incineration)
- c) PM:
 - o carbonaceous fuel: 0.3 lbs/10⁶ Btu of heat input
 - o fossil fuel: 0.1 lbs/10⁶ Btu of heat input
(86.6 lbs/hr, 379.3 TPY: combination of fuels)
- d) VE:
 - o carbonaceous fuel: ≤ 30% opacity, except ≤ 40% opacity
for ≤ 2 minutes in any 1 hour
 - o fossil fuel only: ≤ 20% opacity, except ≤ 40% opacity
for one 2-minute period per hour

Note: o Fly ash and SO₂ are controlled by a wet caustic scrubber.
o Projected SO₂ removal efficiency is 35% during operation.
o PSD pollutant evaluation will compare "actual emissions"
with "future allowable/potential emissions".

11. Annual compliance tests for PM and visible emissions shall be conducted concurrently, weather permitting, using the following test methods in accordance with F.A.C. Rule 17-2.700 and 40 CFR 60, Appendix A:

- a) EPA Method 5, Determination of Particulate Emissions from Stationary Sources.
- b) EPA Method 9, Visual Determination of the Opacity of Emissions from Stationary Sources.

12. Initial and annual compliance tests for SO₂ shall be conducted using the following test method in accordance with F.A.C. Rule 17-2.700 and 40 CFR 60, Appendix A:

- a) EPA Method 6, Determination of Sulfur Dioxide Emissions from Stationary Sources.

13. Compliance tests for TRS shall be conducted using one of the following test methods in accordance with F.A.C. Rule 17-2.700 and 40 CFR 60, Appendix A:

- a) EPA Method 16, 16A or 16B, Determination of TRS Emissions from Stationary Sources.

14. The Department reserves the right to require testing for TRS, in accordance with No. 13 above, for operating permit renewal (see Mr. C. H. Fancy's letter dated April 5, 1990).

PERMITTEE:
Stone Container Corporation

Permit Number: AC 03-190964
Expiration Date: June 30, 1992

SPECIFIC CONDITIONS:

15. Other test methods and alternate compliance procedures may be used only after prior Departmental approval has been obtained in writing in accordance with F.A.C. Rule 17-2.700(3).

16. The control equipment shall be inspected regularly and maintained in good operating condition to minimize fugitive gaseous emissions.

17. Objectionable odors shall not be allowed off plant property in accordance with F.A.C. Rule 17-2.620(2).

18. The sulfur content of the No. 6 fuel oil and the coal shall be verified using ASTM D1552-83 and ASTM D3177-75, respectively; and, the lab analysis data sheet(s), which are provided by the fuel oil and coal vendors upon delivery, shall be kept on record for at least two years.

19. The Department's Northwest District office shall be notified in writing when the boiler is switched to incinerating TRS gases and/or operating at 100% fossil fuel; and, a log book shall be maintained recording, at a minimum, the date(s) and the beginning and ending "clock time(s)" of operation while incinerating TRS gases and/or firing 100% fossil fuel. Records shall be maintained for at least two years.

20. The Department's Northwest District office shall be notified in writing at least 15 days prior to source testing pursuant to F.A.C. Rule 17-2.700(2). Written reports of the tests shall be submitted to the Department's Northwest District office within 45 days of the test completion in accordance with F.A.C. Rule 17-2.700(7).

21. Any change in the method of operation, raw materials, chemicals processed, equipment, or operating hours pursuant to F.A.C. Rule 17-2.100, Definitions-Modification, shall be submitted for approval to the Department's Bureau of Air Regulation office and Northwest District office.

22. The pH of the associated venturi scrubber system shall be maintained at a minimum of 8.0 while incinerating TRS gases and/or firing fossil fuel only. A continuous pH recorder shall be installed, calibrated, and properly operated to monitor the pH of the scrubbing medium. The records shall be maintained for at least two years.

23. The permittee, for good cause, may request that this construction permit be extended. Such a request shall be submitted to the Department's Bureau of Air Regulation prior to 60 days before the expiration of the permit (F.A.C. Rule 17-4.090).

PERMITTEE:
Stone Container Corporation

Permit Number: AC 03-190964
Expiration Date: June 30, 1992

SPECIFIC CONDITIONS:

24. An application for an operation permit must be submitted to the Department's Northwest District office at least 90 days prior to the expiration date of this construction permit. To properly apply for an operation permit, the applicant shall submit the appropriate application form, fee, certification that construction was completed while noting any deviations from the conditions in the construction permit, and compliance test reports as required by this permit (F.A.C. Rules 17-4.055 and 17-4.220).

Issued this 13th day
of December, 1991

STATE OF FLORIDA DEPARTMENT
OF ENVIRONMENTAL REGULATION

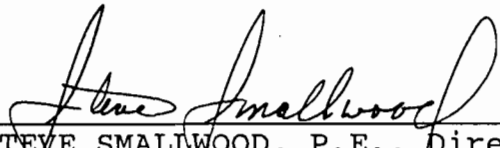

STEVE SMALLWOOD, P.E., Director
Division of Air Resources
Management



State of Florida
DEPARTMENT OF ENVIRONMENTAL REGULATION

| For Routing To Other Than The Addressee | |
|---|-----------------|
| To: _____ | Location: _____ |
| To: _____ | Location: _____ |
| To: _____ | Location: _____ |
| From: _____ | Date: _____ |

Interoffice Memorandum

TO: Steve Smallwood
FROM: Clair Fancy *CF*
DATE: December 3, 1991
SUBJ: Approval of Construction Permit No. AC 03-190964
Stone Container Corporation

Attached for your approval and signature is a construction permit for a modification prepared by the Bureau of Air Regulation for the above referenced company to allow the use of the No. 4 Bark Boiler as the back-up TRS incinerator to the lime kiln on a continuous basis (i.e., 8760 hrs/yr) and to establish emission standards and operation requirements while operating at 100% fossil fuel. The facility is located in Panama City, Bay County, Florida. There were no comments received during the public notice period.

Day 90, after which this permit will be issued by default, is December 17, 1991.

I recommend your approval and signature.

CF/BM/rbm

SENDER: Complete items 1 and 2 when additional services are desired, and complete items 3 and 4.
Put your address in the "RETURN TO" Space on the reverse side. Failure to do this will prevent this card from being returned to you. The return receipt fee will provide you the name of the person delivered to and the date of delivery. For additional fees the following services are available. Consult postmaster for fees and check box(es) for additional service(s) requested.

1. Show to whom delivered, date, and addressee's address. (Extra charge) 2. Restricted Delivery (Extra charge)

| | |
|--|---|
| 3. Article Addressed to: Mr. L.D. Riley, Jr. Stone Container Corp. 1 Everitt Avenue P.O. Box 2560 Panama City, FL 32402 | 4. Article Number P 407 853 137 |
| | Type of Service: <input type="checkbox"/> Registered <input type="checkbox"/> Insured <input checked="" type="checkbox"/> Certified <input type="checkbox"/> COD <input type="checkbox"/> Express Mail <input type="checkbox"/> Return Receipt for Merchandise |
| | Always obtain signature of addressee or agent and DATE DELIVERED. |
| 5. Signature — Addressee <input checked="" type="checkbox"/> | 8. Addressee's Address (ONLY if requested and fee paid) |
| 6. Signature — Agent <input checked="" type="checkbox"/> <i>L. Barker</i> | |
| 7. Date of Delivery <i>2-11-91</i> | |

PS Form 3811, Apr. 1989

*U.S.G.P.O. 1989-238-815

DOMESTIC RETURN RECEIPT

P 407 853 137
RECEIPT FOR CERTIFIED MAIL
 NO INSURANCE COVERAGE PROVIDED
 NOT FOR INTERNATIONAL MAIL
 (See Reverse)

*U.S.G.P.O. 1989-234-555

| | |
|---|----|
| Sent to Mr. L.D. Riley, Jr. Stone Container Corp. | |
| Street and No. 1 Everitt Ave. | |
| P.O. Box 2560 | |
| P.O. State and ZIP Code Panama City, FL 32402 | |
| Postage | \$ |
| Certified Fee | |
| Special Delivery Fee | |
| Restricted Delivery Fee | |
| Return Receipt showing to whom and Date Delivered | |
| Return Receipt showing to whom, Date, and Address of Delivery | |
| TOTAL Postage and Fees | \$ |
| Postmark or Date mailed: 2/1/91 AC03-190964 | |

PS Form 3800, June 1985

File Copy

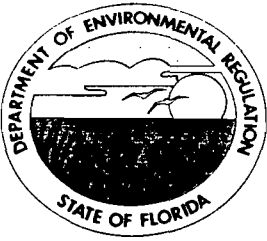

Florida Department of Environmental Regulation

Twin Towers Office Bldg. • 2600 Blair Stone Road • Tallahassee, Florida 32399-2400

Lawton Chiles, Governor

Carol M. Browner, Secretary

February 1, 1991

CERTIFIED MAIL-RETURN RECEIPT REQUESTED

Mr. L. D. Riley, Jr.
Stone Container Corporation
1 Everitt Avenue
Post Office Box 2560
Panama City, Florida 32402

Dear Mr. Riley:

Re: Completeness Review of Application Package to Modify
AC03-190964

The Department has reviewed your letter of December 19, 1990, requesting an amendment to a previously issued construction permit No. AC03-178473. Based on discussions via the phone with Mr. Bruce Mitchell, it was concluded to document the request by issuing a construction permit. A fee of \$200.00 was received on January 2, 1991. However, the following documentation has not been received and the status will remain incomplete until it is received:

1. The application form, DER Form 17-1.202(1), needs to be filled out, completing the appropriate sections, attaching all calculations and reference material, and denoting any assumptions.
2. A Florida registered Professional Engineer needs to affix his or her seal in the appropriate section of the application form referenced in #1 above.
3. What operational procedure, instrumentation, etc., will be used to maintain the scrubber system's pH at a minimum of 8.0?

If there are any questions, please call Mr. Bruce Mitchell at (904)488-1344 or write to me at the above address.

Sincerely,

C. H. Fancy, P.E.
Chief
Bureau of Air Regulation

CHF/BM/bm

c: E. Middleswart, NW District

Ready File }
Bruce Mitchell } 2-1-91 BM



Stone Container Corporation

Panama City Mill

Containerboard and Paper Division

Post Office Box 2560
Panama City, Florida 32402

(904) 785-4311

December 26, 1990

Mr. Bruce Mitchell
Florida Dept. of Environmental Regulation
Twin Towers Office Building
2600 Blair Stone Road
Tallahassee, FL 32399

1990 DEC 28 PM 2:26
RECEIVED
SER - MAIL ROOM

Dear Mr. Mitchell:

Confirming my FAX message to you on December 19, please revise Part A of Section II of our No. 4 bark boiler permit to read: "To be the primary incineration device for our TRS gases. The lime kiln will be the standby incineration device."

SO² Emission from incineration of the TRS gasses in the bark boiler are calculated as follows:

Hours per year: 8,760
SO² Emissions per hour: 2.5 Lbs.
Annual SO² Emissions: $\frac{8,760 \text{ Hrs} \times 2.5 \text{ LBS/Hr}}{2,000 \text{ Lbs/Hr}} = 10.95 \text{ Tons/Yr.}$

The estimated 10.95 Tons/Yr. includes SO² from TRS gasses and fossil fuels.

A check for two hundred dollars (\$200) is enclosed to defray the process fee for this change.

If you have questions or comments, please contact David Riley at (904) 785-4311, ext. 257.

Yours very truly,

L. D. Riley, Jr.
Environmental Supt.

LDRjr:cf

Enclosure

cc: Jack Prescott
C. F. Bogatie

001031



Stone Container Corporation
PANAMA CITY MILL
PANAMA CITY, FLORIDA

NO.50460

| | |
|----------|----------|
| FILE NO. | DATE |
| 12-27 | 12-26-90 |

PAY EXACTLY*****\$200.00*****

\$200.00

PAY TO THE ORDER OF

Stone Container Corporation
GENERAL ACCOUNT-PANAMA CITY MILL

FLORIDA DEPARTMENT OF
ENVIRONMENTAL REGULATION

TO NCNB NATIONAL BANK OF N.C.
ASHEVILLE, NORTH CAROLINA

Jack B. Prescott
P.W. Cunningham Jr.

4311



Mr. Bruce Mitchell
Florida Dept. of Environmental Regulation
Twin Towers Office Building
2600 Blair Stone Road
Tallahassee, FL 32399

RECEIVED
ENVIRONMENTAL
REGULATION
MAIL ROOM
1 DEC 28 PM 2:26

Dear Mr. Mitchell:

Confirming my FAX message to you on December 19, please revise Part A of Section II of our No. 4 bark boiler permit to read: "To be the primary incineration device for our TRS gases. The lime kiln will be the standby incineration device."

SO² Emission from incineration of the TRS gasses in the bark boiler are calculated as follows:

Hours per year: 8,760
 SO² Emissions per hour: 2.5 Lbs.
 Annual SO² Emissions: $\frac{8,760 \text{ Hrs} \times 2.5 \text{ LBS/Hr}}{2,000 \text{ Lbs/Hr}} = 10.95 \text{ Tons/Yr.}$

The estimated 10.95 Tons/Yr. includes SO² from TRS gasses and fossil fuels.

A check for two hundred dollars (\$200) is enclosed to defray the process fee for this change.

If you have questions or comments, please contact David Riley at (904) 785-4311, ext. 257.

Yours very truly,

L. D. Riley, Jr.
L. D. Riley, Jr.
Environmental Supt.

LDRjr:cf

Enclosure

cc: Jack Prescott
C. F. Bogatie

2011031

RECEIVED

DEC 21 1990

DEN. C.A.M.

December 19, 1990

Mr. Duell Mitchell
 Florida Department of Environmental Regulation
 Twin Towers Office Building
 2600 Blair Stone Road
 Tallahassee, Fl. 32399

DEAR MR. MITCHELL:

PER OUR CONVERSATION THIS MORNING, PLEASE REVISE PART A OF SECTION II OF OUR NO. 4 BARK BOILER PERMIT TO READ: "TO BE THE PRIMARY INCINERATION DEVICE FOR OUR TRS GASSES. THE LIME KILN WILL BE THE STANDBY INCINERATION DEVICE."

SO₂ EMISSION FROM INCINERATION OF THE TRS GASSES IN THE BARK BOILER ~~ARE~~ ARE CALCULATED AS FOLLOWS:

HOURS PER YEAR: 8,760

SO₂ EMISSIONS PER HOUR: 2.5 LBS.

ANNUAL SO₂ EMISSIONS: $\frac{8,760 \text{ HRS} \times 2.5 \text{ LBS/HR}}{2000 \text{ LBS/TNS}} = 10.95 \text{ TNS/YR.}$

THE ESTIMATED 10.95 TNS/YR. INCLUDES SO₂ FROM DIL, COAL, & TRS GASSES.

(HARD COPY TO FOLLOW)

THANKS,
 David. Rubin

RECEIVED

DEC 21 1990

DER-BAQM

Number of Sheets

2

Date

12/21/90

To

BRUCE MITCHELL

Location

FDER - AIR

From

DAVID RILEY

(904) 785-4311 EXT. 257

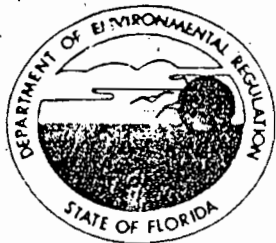

Florida Department of Environmental Regulation

Twin Towers Office Bldg. • 2600 Blair Stone Road • Tallahassee, Florida 32399-2400

Bob Martinez, Governor

Dale Twachtmann, Secretary

John Shearer, Assistant Secretary

April 5, 1990

Mr. Ray Andreu, Chairman
 Florida Pulp and Paper Association
 Technical and Environmental Committee
 Route 3, Box 260
 Perry, Florida 32347

Dear Mr. Andreu:

This is to confirm the agreements made by the Florida Pulp and Paper Association and the Bureau of Air Regulation at our meeting on March 20, 1990, regarding incineration of TRS gases in an incinerator(s).

1. Any company using an incinerator will initially test to show compliance with the 5 ppmvd limit, corrected to 10% oxygen, using DER approved test methods.
2. These tests will not be required annually. The Department reserves the right to require testing for operation permit renewal (every 5 years).
3. Compliance during the five year period will be demonstrated by continuous monitoring and recording of the temperature showing that a minimum temperature of 1200°F is being achieved.
4. By the selected design and the P.E. of record, the construction permit applications shall contain calculations to insure that the specified retention time (i.e., 0.5 seconds) will be achieved by the source in order to provide reasonable assurance to the Department.

Sincerely,

C. H. Fancy, P.E.
 Chief
 Bureau of Air Regulation

CHF/kt



Stone Container Corporation

Panama City Mill

Containerboard and Paper Division

Post Office Box 2560
Panama City, Florida 32402

December 19, 1990

(904) 785-4311

Mr. Steve Smallwood, Division Director
Florida Dept. of Environmental Regulation
Twin Towers Office Building
2600 Blair Stone Road
Tallahassee, FL 32399

Dear Mr. Smallwood:

Confirming our telephone conversation today, we are requesting permission to incinerate our noncondensable gasses in No. 4 bark boiler until the operating permit can be modified to make this unit the primary incineration device for the NCG system. No. 4 bark boiler is currently permitted as the backup incineration unit.

Incineration of the noncondensable gasses in the lime kiln has resulted in increased sulfidity in our liquor system which in turn has caused a critical corrosion problem in the cascade evaporators on our two recovery boilers. If this condition continues uncorrected we will be faced with replacing the four cascade evaporators at considerable expense and significant production losses.

We propose controlling the pH to a minimum of 8.0 in the wet scrubber solution while burning the NCG gasses in No. 4 bark boiler. Technical Services Incorporated, Inc. performed SO₂ emission tests with the boiler operating under these condition and determined that SO₂ emissions were only 2 lbs. per hour. This emission rate is considerably less than the rate during normal boiler operation without noncondensable gas incineration. We anticipate no adverse environmental impact and in fact should see some improvement in ambient air quality from this project.

Again, I emphasize the critical nature of this problem and request your earliest approval of this request.

Thank you for your cooperation in this matter.

Yours very truly,

L. D. Riley, Jr.
Environmental Supt.

RECEIVED

DEC 20 1990

DER-BAQM

LDRjr:cf

cc: Jack Prescott
C. F. Bogatie



Stone Container Corporation

Panama City Mill

Containerboard and Paper Division

Post Office Box 2560
Panama City, Florida 32402

(904) 785-4311

May 21, 1991

RECEIVED

MAY 23 1991

**Bureau of
Air Regulation**

Mr. C. H. Fancy
Chief, Bureau of Air Regulation
Florida Dept. of Environmental Regulation
Twin Towers Office Building
2600 Blair Stone Road
Tallahassee, FL 32399-2400

Dear Mr. Fancy:

Enclosed are four (4) copies of a construction permit application for incinerating TRS gasses in No. 4 bark boiler at the Panama City Mill of Stone Container Corporation.

We are requesting use of this source to incinerate TRS gasses on an as needed basis. Our lime kiln will continue to be an incineration device for TRS gasses also. Test data and technical information supporting the unrestricted use of this unit has previously been submitted.

Our control strategy for SO² emissions will consist of controlling the pH of the scrubbing medium in the wet scrubber to a minimum of 8.0 when incinerating TRS gasses. A continuous pH recorder will be used to monitor the pH and act as a surrogate parameter for SO² emissions.

If you have questions or comments, please contact David Riley at (904) 785-4311, ext. 257.

Yours very truly,

L. D. Riley, Jr.
Environmental Superintendent

/cf

Enclosures

cc: Jack Prescott
C. F. Bogatie
Tem Fontaine
B. Mitchell
G. Preece

BEST AVAILABLE COPY

FEDERAL EXPRESS

QUESTIONS? CALL 800-238-5355 TOLL FREE.

AIRBILL PACKAGE TRACKING NUMBER

8806738426

1101M 8806738426

RECIPIENT'S COPY

| | | | |
|---|-------------|--|-------------|
| Date 5-22-91 | | To (Recipient's Name) Please Print C. H. FANCY | |
| From (Your Name) Please Print D. RILEY, JR. | | Your Phone Number (Very Important) (904) 785-4311 | |
| Company ONE CONTAINER CORPORATION | | Company FLORIDA DEPT. OF ENVIRONMENTAL REGULATION | |
| Street Address EVERITT AVE | | Exact Street Address (We Cannot Deliver to P.O. Boxes or P.O. Zip Codes) TWIN TOWERS OFFICE BUILDING 2600 BLAIR STONE ROAD | |
| City NAMA CITY | State FL | City TALLAHASSEE | State FL |
| ZIP Required 32401 | | ZIP Required 32391 | |
| YOUR INTERNAL BILLING REFERENCE INFORMATION (First 24 characters will appear on invoice.) | | IF HOLD FOR PICK-UP, Print FEDEX Address Here Street Address | |
| PAYMENT 1 <input checked="" type="checkbox"/> Bill Sender 2 <input type="checkbox"/> Bill Recipient's FedEx Acct. No. 3 <input type="checkbox"/> Bill 3rd Party FedEx Acct. No. 4 <input type="checkbox"/> Bill Credit Card | | City State ZIP Required | |
| 5 <input type="checkbox"/> Cash/Check | | | |

| SERVICES (Check only one box) | | DELIVERY AND SPECIAL HANDLING (Check services required) | | | PACKAGES | WEIGHT In Pounds Only | YOUR DECLARED VALUE | Emp. No. | Date | Federal Express Use |
|--|---|---|--|--|----------|-----------------------|---------------------|--|------|--|
| Priority Overnight Service (Delivery by next business morning) 11 <input type="checkbox"/> YOUR PACKAGING 16 <input checked="" type="checkbox"/> FEDEX LETTER 12 <input type="checkbox"/> FEDEX PAK 13 <input type="checkbox"/> FEDEX BOX 14 <input type="checkbox"/> FEDEX TUBE Economy Two-Day Service (formerly Standard Air) (Delivery by second business day) 30 <input type="checkbox"/> ECONOMY TWO-DAY SVC. Standard Overnight Service (Delivery by next business afternoon) 51 <input type="checkbox"/> YOUR PACKAGING 56 <input type="checkbox"/> FEDEX LETTER 52 <input type="checkbox"/> FEDEX PAK 53 <input type="checkbox"/> FEDEX BOX 54 <input checked="" type="checkbox"/> FEDEX TUBE Heavyweight Service (for Extra Large or any package over 150 lbs.) (Delivery by second business day) 70 <input type="checkbox"/> HEAVYWEIGHT 80 <input type="checkbox"/> DEFERRED HEAVYWEIGHT *Declared Value Limit \$100. **Call for delivery schedule. | 1 <input type="checkbox"/> HOLD FOR PICK-UP (Fails in Box H) 2 <input checked="" type="checkbox"/> DELIVER WEEKDAY 3 <input type="checkbox"/> DELIVER SATURDAY (Extra charge) (Not available to all locations) 4 <input checked="" type="checkbox"/> DANGEROUS GOODS (Extra charge) 5 <input type="checkbox"/> 6 <input type="checkbox"/> DRY ICE lbs. 7 <input type="checkbox"/> OTHER SPECIAL SERVICE 8 <input type="checkbox"/> 9 <input type="checkbox"/> SATURDAY PICK-UP (Extra charge) 10 <input type="checkbox"/> 11 <input type="checkbox"/> 12 <input type="checkbox"/> HOLIDAY DELIVERY (if offered) (Extra charge) | | | | | | | | | Base Charges Declared Value Charge Other 1 Other 2 Total Charges REVISION DATE 8/90 PART #119501 / NCREC 8/90 FORMAT #041 041 © 1990 F.E.C. PRINTED IN U.S.A. |
| IF HOLD FOR PICK-UP, Print FEDEX Address Here Street Address City State ZIP Required | | | | | | | | Emp. No. Date <input type="checkbox"/> Cash Received <input type="checkbox"/> Return Shipment <input type="checkbox"/> Third Party <input type="checkbox"/> Chg. To Del. <input type="checkbox"/> Chg. To Hold Street Address City State ZIP Received By: X Date/Time Received FedEx Employee Number 5 Release Signature: Date/Time | | |
| SHIPMENT (Chargeable Weight) <input type="checkbox"/> lbs. Received At: 1 <input checked="" type="checkbox"/> Regular Stop 3 <input type="checkbox"/> Drop Box 2 <input type="checkbox"/> On-Call Stop 4 <input type="checkbox"/> B.S.C. 5 <input type="checkbox"/> Station | | | | | | | | | | |
| FedEx Emp. No. | | | | | | | | | | |

DEPARTMENT OF ENVIRONMENTAL REGULATION

RECEIVED

NORTHWEST DISTRICT
BRANCH OFFICE
340 WEST 23RD STREET
PANAMA CITY, FLORIDA 32405

MAY 23 1991



Bureau of
Air Regulation

AC 03-190964

BOB MARTINEZ
GOVERNORDALE TWACHTMANN
SECRETARY

APPLICATION TO OPERATE/CONSTRUCT AIR POLLUTION SOURCES

SOURCE TYPE: Air Emissions [] New¹ [] Existing¹

APPLICATION TYPE: [X] Construction [] Operation [] Modification

COMPANY NAME: Stone Container Corporation COUNTY: BayIdentify the specific emission point source(s) addressed in this application (i.e. Lime No. 4 Bark Boiler with Kiln No. 4 with Venturi Scrubber; Peaking Unit No. 2, Gas Fired) Venturi ScrubberSOURCE LOCATION: Street #1 Everitt Avenue City Panama CityUTM: East x North _____Latitude 30° 08' 30"N Longitude 85° 37' 25"WAPPLICANT NAME AND TITLE: Stone Container CorporationAPPLICANT ADDRESS: P. O. Box 2560 - Panama City, FL 32402

SECTION I: STATEMENTS BY APPLICANT AND ENGINEER

A. APPLICANT

I am the undersigned owner or authorized representative* of Stone Container

I certify that the statements made in this application for a Construction permit are true, correct and complete to the best of my knowledge and belief. Further, I agree to maintain and operate the pollution control source and pollution control facilities in such a manner as to comply with the provision of Chapter 403, Florida Statutes, and all the rules and regulations of the department and revisions thereof. I also understand that a permit, if granted by the department, will be non-transferable and I will promptly notify the department upon sale or legal transfer of the permitted establishment.

*Attach letter of authorization

Signed: L. D. Riley, Jr.

L. D. Riley, Jr. - Environmental Superintendent
Name and Title (Please Type)

Date: 4/19/91 Telephone No. (904)785-4311

B. PROFESSIONAL ENGINEER REGISTERED IN FLORIDA (where required by Chapter 471, F.S.)

This is to certify that the engineering features of this pollution control project have been designed/examined by me and found to be in conformity with modern engineering principles applicable to the treatment and disposal of pollutants characterized in the permit application. There is reasonable assurance, in my professional judgment, that

¹ See Florida Administrative Code Rule 17-2.100(57) and (104)

the pollution control facilities, when properly maintained and operated, will discharge an effluent that complies with all applicable statutes of the State of Florida and the rules and regulations of the department. It is also agreed that the undersigned will furnish, if authorized by the owner, the applicant a set of instructions for the proper maintenance and operation of the pollution control facilities and, if applicable, pollution sources.

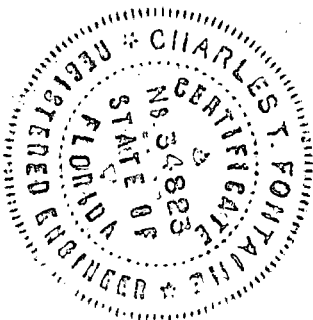

Signed Charles Temple Fontaine

Charles Temple Fontaine
Name (Please Type)

Stone Container Corporation
Company Name (Please Type)

P. O. Box 2560 - Panama City, FL 32402
Mailing Address (Please Type)

Florida Registration No. 34823 Date: 5/22/91 Telephone No. (904)785-4311

SECTION II: GENERAL PROJECT INFORMATION

A. Describe the nature and extent of the project. Refer to pollution control equipment, and expected improvements in source performance as a result of installation. State whether the project will result in full compliance. Attach additional sheet if necessary.

The purpose of this project is to permit No. 4 Bark Boiler to incinerate TRS gases.

B. Schedule of project covered in this application (Construction Permit Application Only)
Start of Construction _____ Completion of Construction Feb. 6, 1989

C. Costs of pollution control system(s): (Note: Show breakdown of estimated costs only for individual components/units of the project serving pollution control purposes. Information on actual costs shall be furnished with the application for operation permit.)

N/A

D. Indicate any previous DER permits, orders and notices associated with the emission point, including permit issuance and expiration dates.

Operating permit No. A003-169285

E. Requested permitted equipment operating time: hrs/day 24 ; days/wk 7 ; wks/yr 50 ;
if power plant, hrs/yr _____ ; if seasonal, describe: _____

F. If this is a new source or major modification, answer the following questions.
(Yes or No) N/A

1. Is this source in a non-attainment area for a particular pollutant? _____

a. If yes, has "offset" been applied? _____

b. If yes, has "Lowest Achievable Emission Rate" been applied? _____

c. If yes, list non-attainment pollutants. _____

2. Does best available control technology (BACT) apply to this source?
If yes, see Section VI. No

3. Does the State "Prevention of Significant Deterioration" (PSD)
requirement apply to this source? If yes, see Sections VI and VII. No

4. Do "Standards of Performance for New Stationary Sources" (NSPS)
apply to this source? No

5. Do "National Emission Standards for Hazardous Air Pollutants"
(NESHAP) apply to this source? No

H. Do "Reasonably Available Control Technology" (RACT) requirements apply
to this source? No

a. If yes, for what pollutants? _____

b. If yes, in addition to the information required in this form,
any information requested in Rule 17-2.650 must be submitted.

Attach all supportive information related to any answer of "Yes". Attach any justifi-
cation for any answer of "No" that might be considered questionable.

SECTION III: AIR POLLUTION SOURCES & CONTROL DEVICES (Other than Incinerators)

A. Raw Materials and Chemicals Used in your Process, if applicable:

N/A

| Description | Contaminants | | Utilization Rate - lbs/hr | Relate to Flow Diagram |
|-------------|--------------|------|---------------------------|------------------------|
| | Type | % Wt | | |
| | | | | |
| | | | | |
| | | | | |
| | | | | |
| | | | | |
| | | | | |

B. Process Rate, if applicable: (See Section V, Item 1) N/A

1. Total Process Input Rate (lbs/hr): _____

2. Product Weight (lbs/hr): _____

C. Airborne Contaminants Emitted: (Information in this table must be submitted for each emission point, use additional sheets as necessary)

| Name of Contaminant | Emission ¹ | | Allowed Emission Rate per Rule 17-2 | Allowable ³ Emission lbs/hr | Potential ⁴ Emission | | Relate to Flow Diagram |
|---------------------|-----------------------|-------------|-------------------------------------|--|---------------------------------|------|------------------------|
| | Maximum lbs/hr | Actual T/yr | | | lbs/yr | T/yr | |
| Particulate | | 120.7 | 0.11 lbs/MM BTU Fossil fuel | 86.6 | 7,586,000 | 3793 | (A) |
| | | | 0.3 lbs/MM BTU carbonaceous | | | | |
| SO ² | | 1449 | 2.75 lbs/MMBTU | 1105 | 9,680,000 | 4840 | (A) |
| | | | | | | | |
| | | | | | | | |

¹See Section V, Item 2.

²Reference applicable emission standards and units (e.g. Rule 17-2.600(5)(b)2. Table II, E. (1) - 0.1 pounds per million BTU heat input)

³Calculated from operating rate and applicable standard.

⁴Emission, if source operated without control (See Section V, Item 3).

D. Control Devices: (See Section V, Item 4)

| Name and Type (Model & Serial No.) | Contaminant | Efficiency | Range of Particles Size Collected (in microns) (If applicable) | Basis for Efficiency (Section V Item 5) |
|---------------------------------------|-------------|------------|---|--|
| FMC Link Belt Model 200K | Particulate | 90-3 | N/A | Manufactured Guarantee |
| Dual Throat Wet Scrubber | | | | |
| | | | | |
| | | | | |
| | | | | |

E. Fuels

| Type (Be Specific) | Consumption* | | Maximum Heat Input (MMBTU/hr) |
|--------------------|---------------|---------------|----------------------------------|
| | avg/hr | max./hr | |
| No. 6 Fuel Oil | 196 Gal/Hr | 2,000 Gal/Hr | 300.00 |
| Coal | 16,380 Lbs/Hr | 22,000 Lbs/Hr | 102.30 |
| Wood Bark | 17,352 Lbs/Hr | 4,1700 Lbs/Hr | 193.90 |
| | | | |

*Units: Natural Gas--MMCF/hr; Fuel Oils--gallons/hr; Coal, wood, refuse, other--lbs/hr.

Fuel Analysis:

Percent Sulfur: Oil 2.5% Max. Coal 1.7% Max. Oil: 0.1% Max.
 Percent Ash: Coal: 10% Bark: 1.45%
 Density: 8.1 Oil lbs/gal Typical Percent Nitrogen: _____
 Heat Capacity: Coal: 13,000 Bark: 4650 BTU/lb Oil: 18,500 BTU/gal
 Other Fuel Contaminants (which may cause air pollution): _____

F. If applicable, indicate the percent of fuel used for space heating.

Annual Average 0 Maximum 0

G. Indicate liquid or solid wastes generated and method of disposal.

Ash - Pumped to settling pond - Decanted water returned to waste treatment system.

Ash stored on site.

H. Emission Stack Geometry and Flow Characteristics (Provide data for each stack):

Stack Height: 213'-9" (Elevation 222'-3" ft. Stack Diameter: 7'-10" ft.
 Gas Flow Rate: 236,500 ACFM 179,200 DSCFM Gas Exit Temperature: 141 °F.
 Water Vapor Content: 19 % Velocity: 86.5 FPS

SECTION IV: INCINERATOR INFORMATION

N/A

| Type of Waste | Type 0 (Plastics) | Type I (Rubbish) | Type II (Refuse) | Type III (Garbage) | Type IV (Pathological) | Type V (Liq. & Gas By-prod.) | Type VI (Solid By-prod.) |
|--------------------------|-------------------|------------------|------------------|--------------------|------------------------|------------------------------|--------------------------|
| Actual lb/hr Incinerated | | | | | | | |
| Uncontrolled (lbs/hr) | | | | | | | |

Description of Waste _____

Total Weight Incinerated (lbs/hr) _____ Design Capacity (lbs/hr) _____

Approximate Number of Hours of Operation per day _____ day/wk _____ wks/yr. _____

Manufacturer _____

Date Constructed _____ Model No. _____

| | Volume (ft) ³ | Heat Release (BTU/hr) | Fuel | | Temperature (°F) |
|-------------------|--------------------------|-----------------------|------|--------|------------------|
| | | | Type | BTU/hr | |
| Primary Chamber | | | | | |
| Secondary Chamber | | | | | |

Stack Height: _____ ft. Stack Diameter: _____ Stack Temp. _____

Gas Flow Rate: _____ ACFM _____ DSCFM* Velocity: _____ FPS

*If 50 or more tons per day design capacity, submit the emissions rate in grains per standard cubic foot dry gas corrected to 50% excess air.

Type of pollution control device: Cyclone Wet Scrubber Afterburner
 Other (specify) _____

Brief description of operating characteristics of control devices: Wet Scrubber
operating with DP of 9-10 inches. pH of scrubbing liquid controlled with caustic. A
continuous recording pH meter will be installed on the scrubbing medium to insure that a
minimum pH of 8.0 is maintained. This will serve as the surrogate parameter for
demonstrating compliance.

Ultimate disposal of any effluent other than that emitted from the stack (scrubber water, ash, etc.):

Scrubber water is pumped to settling pond - settled ash is removed and stored on site.
Decanted water is returned to waste treatment system.

NOTE: Items 2, 3, 4, 6, 7, 8, and 10 in Section V must be included where applicable.

SECTION V: SUPPLEMENTAL REQUIREMENTS

Please provide the following supplements where required for this application.

1. Total process input rate and product weight -- show derivation [Rule 17-2.100(127)]
2. To a construction application, attach basis of emission estimate (e.g., design calculations, design drawings, pertinent manufacturer's test data, etc.) and attach proposed methods (e.g., FR Part 60 Methods 1, 2, 3, 4, 5) to show proof of compliance with applicable standards. To an operation application, attach test results or methods used to show proof of compliance. Information provided when applying for an operation permit from a construction permit shall be indicative of the time at which the test was made.
3. Attach basis of potential discharge (e.g., emission factor, that is, AP42 test).
4. With construction permit application, include design details for all air pollution control systems (e.g., for baghouse include cloth to air ratio; for scrubber include cross-section sketch, design pressure drop, etc.)
5. With construction permit application, attach derivation of control device(s) efficiency. Include test or design data. Items 2, 3 and 5 should be consistent: actual emissions = potential (1-efficiency).
6. An 8 1/2" x 11" flow diagram which will, without revealing trade secrets, identify the individual operations and/or processes. Indicate where raw materials enter, where solid and liquid waste exit, where gaseous emissions and/or airborne particles are evolved and where finished products are obtained.
7. An 8 1/2" x 11" plot plan showing the location of the establishment, and points of airborne emissions, in relation to the surrounding area, residences and other permanent structures and roadways (Example: Copy of relevant portion of USGS topographic map).
8. An 8 1/2" x 11" plot plan of facility showing the location of manufacturing processes and outlets for airborne emissions. Relate all flows to the flow diagram.

9. The appropriate application fee in accordance with Rule 17-4.05. The check should be made payable to the Department of Environmental Regulation.
10. With an application for operation permit, attach a Certificate of Completion of Construction indicating that the source was constructed as shown in the construction permit.

SECTION VI: BEST AVAILABLE CONTROL TECHNOLOGY N/A

A. Are standards of performance for new stationary sources pursuant to 40 C.F.R. Part 60 applicable to the source?

Yes No

| Contaminant | Rate or Concentration |
|-------------|-----------------------|
| | |
| | |
| | |
| | |

B. Has EPA declared the best available control technology for this class of sources (If yes, attach copy)

Yes No

| Contaminant | Rate or Concentration |
|-------------|-----------------------|
| | |
| | |
| | |
| | |

C. What emission levels do you propose as best available control technology?

| Contaminant | Rate or Concentration |
|-------------|-----------------------|
| | |
| | |
| | |
| | |

D. Describe the existing control and treatment technology (if any).

- | | |
|---------------------------|--------------------------|
| 1. Control Device/System: | 2. Operating Principles: |
| 3. Efficiency:* | 4. Capital Costs: |

*Explain method of determining

5. Useful Life:

6. Operating Costs:

7. Energy:

8. Maintenance Cost:

9. Emissions:

Contaminant

Rate or Concentration

| Contaminant | Rate or Concentration |
|-------------|-----------------------|
| | |
| | |
| | |

10. Stack Parameters

- a. Height: ft. b. Diameter: ft.
- c. Flow Rate: ACFM d. Temperature: °F.
- e. Velocity: FPS

E. Describe the control and treatment technology available (As many types as applicable, use additional pages if necessary).

- 1.
 - a. Control Device: b. Operating Principles:
 - c. Efficiency:¹ d. Capital Cost:
 - e. Useful Life: f. Operating Cost:
 - g. Energy:² h. Maintenance Cost:
 - i. Availability of construction materials and process chemicals:
 - j. Applicability to manufacturing processes:
 - k. Ability to construct with control device, install in available space, and operate within proposed levels:

- 2.
 - a. Control Device: b. Operating Principles:
 - c. Efficiency:¹ d. Capital Cost:
 - e. Useful Life: f. Operating Cost:
 - g. Energy:² h. Maintenance Cost:
 - i. Availability of construction materials and process chemicals:

¹Explain method of determining efficiency.

²Energy to be reported in units of electrical power - KWH design rate.

- j. Applicability to manufacturing processes:
- k. Ability to construct with control device, install in available space, and operate within proposed levels:

- 3.
 - a. Control Device:
 - b. Operating Principles:
 - c. Efficiency:¹
 - d. Capital Cost:
 - e. Useful Life:
 - f. Operating Cost:
 - g. Energy:²
 - h. Maintenance Cost:
 - i. Availability of construction materials and process chemicals:
 - j. Applicability to manufacturing processes:
 - k. Ability to construct with control device, install in available space, and operate within proposed levels:

- 4.
 - a. Control Device:
 - b. Operating Principles:
 - c. Efficiency:¹
 - d. Capital Costs:
 - e. Useful Life:
 - f. Operating Cost:
 - g. Energy:²
 - h. Maintenance Cost:
 - i. Availability of construction materials and process chemicals:
 - j. Applicability to manufacturing processes:
 - k. Ability to construct with control device, install in available space, and operate within proposed levels:

F. Describe the control technology selected:

- 1. Control Device:
- 2. Efficiency:¹
- 3. Capital Cost:
- 4. Useful Life:
- 5. Operating Cost:
- 6. Energy:²
- 7. Maintenance Cost:
- 8. Manufacturer:
- 9. Other locations where employed on similar processes:
 - a. (1) Company:
 - (2) Mailing Address:
 - (3) City:
 - (4) State:

¹Explain method of determining efficiency.

²Energy to be reported in units of electrical power - KWH design rate.

(5) Environmental Manager:

(6) Telephone No.:

(7) Emissions:¹

Contaminant

Rate or Concentration

| | |
|--|--|
| | |
| | |
| | |

(8) Process Rate:¹

b. (1) Company:

(2) Mailing Address:

(3) City:

(4) State:

(5) Environmental Manager:

(6) Telephone No.:

(7) Emissions:¹

Contaminant

Rate or Concentration

| | |
|--|--|
| | |
| | |
| | |

(8) Process Rate:¹

10. Reason for selection and description of systems:

¹Applicant must provide this information when available. Should this information not be available, applicant must state the reason(s) why.

SECTION VII - PREVENTION OF SIGNIFICANT DETERIORATION

A. Company Monitored Data

1. _____ no. sites _____ TSP _____ () SO₂* _____ Wind spd/dir

Period of Monitoring _____ / _____ / _____ to _____ / _____ / _____
month day year month day year

Other data recorded _____

Attach all data or statistical summaries to this application.

*Specify bubbler (B) or continuous (C).

2. Instrumentation, Field and Laboratory

- a. Was instrumentation EPA referenced or its equivalent? Yes No
- b. Was instrumentation calibrated in accordance with Department procedures?
 Yes No Unknown

B. Meteorological Data Used for Air Quality Modeling

- 1. _____ Year(s) of data from _____ / _____ / _____ to _____ / _____ / _____
month day year month day year
- 2. Surface data obtained from (location) _____
- 3. Upper air (mixing height) data obtained from (location) _____
- 4. Stability wind rose (STAR) data obtained from (location) _____

C. Computer Models Used

- 1. _____ Modified? If yes, attach description.
- 2. _____ Modified? If yes, attach description.
- 3. _____ Modified? If yes, attach description.
- 4. _____ Modified? If yes, attach description.

Attach copies of all final model runs showing input data, receptor locations, and principle output tables.

D. Applicants Maximum Allowable Emission Data

| Pollutant | Emission Rate |
|-----------------|-----------------|
| TSP | _____ grams/sec |
| SO ² | _____ grams/sec |

E. Emission Data Used in Modeling

Attach list of emission sources. Emission data required is source name, description of point source (on NEDS point number), UTM coordinates, stack data, allowable emissions, and normal operating time.

F. Attach all other information supportive to the PSD review.

G. Discuss the social and economic impact of the selected technology versus other applicable technologies (i.e., jobs, payroll, production, taxes, energy, etc.). Include assessment of the environmental impact of the sources.

H. Attach scientific, engineering, and technical material, reports, publications, journals, and other competent relevant information describing the theory and application of the requested best available control technology.

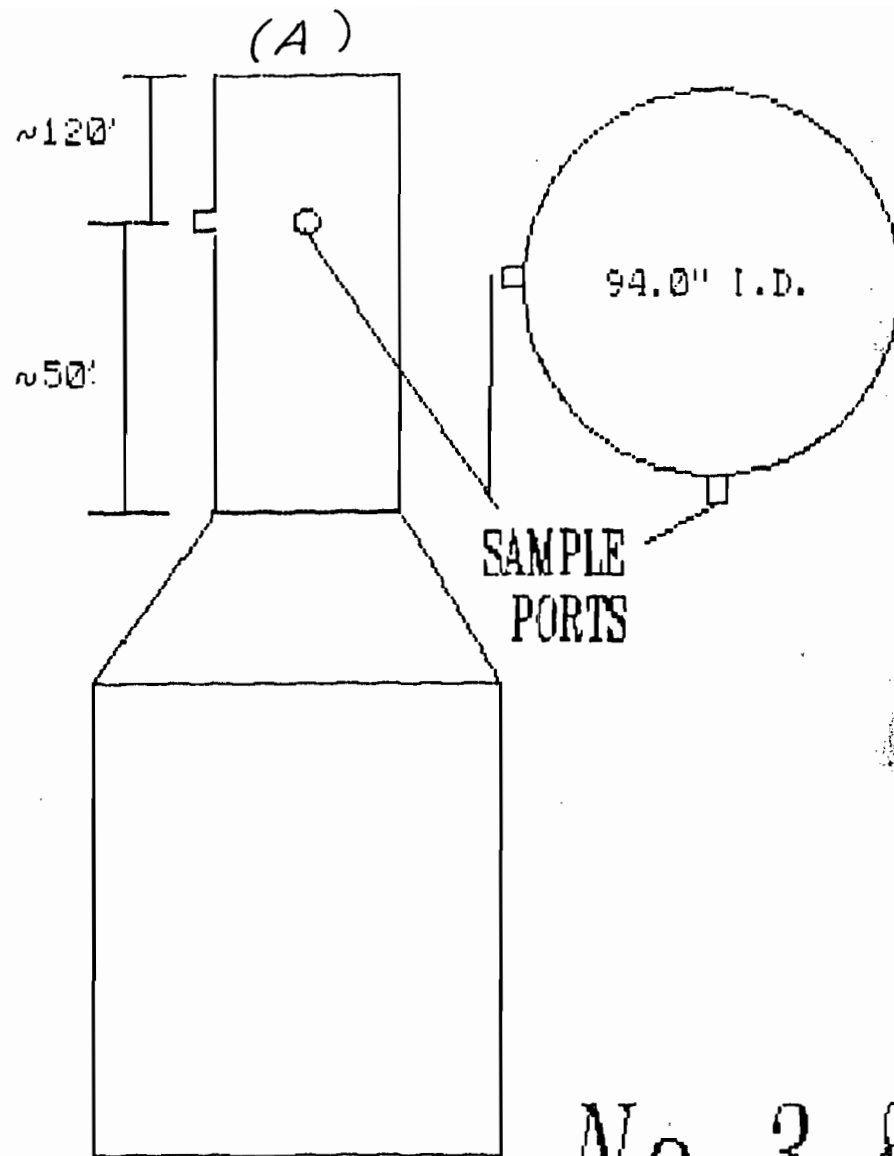

| TRAVERSE POINT No. | INCHES INSIDE STACK WALL |
|--------------------|--------------------------|
| 1 | 1.97 |
| 2 | 6.30 |
| 3 | 11.09 |
| 4 | 16.64 |
| 5 | 23.50 |
| 6 | 33.46 |
| 7 | 60.54 |
| 8 | 70.50 |
| 9 | 77.36 |
| 10 | 82.91 |
| 11 | 87.70 |
| 12 | 92.03 |

No. 3 & 4 BARK BOILER

READER:

- Complete items 1 and/or 2 for additional services.
- Complete items 3, and 4a & b.
- Print your name and address on the reverse of this form so that we can return this card to you.
- Attach this form to the front of the mailpiece, or on the back if space does not permit.
- Write "Return Receipt Requested" on the mailpiece next to the article number.

I also wish to receive the following services (for an extra fee):

- Addressee's Address
- Restricted Delivery

Consult postmaster for fee.

| | |
|--|---|
| 3. Article Addressed to: Mr. L. D. Riley, Jr. Stone Container Corp. 1 Everitt Avenue Post Office Box 2560 Panama City, FL 32402 | 4a. Article Number P 832 538 666 |
| 5. Signature (Addressee) <i>L. D. Riley, Jr.</i> | 4b. Service Type <input type="checkbox"/> Registered <input type="checkbox"/> Insured <input checked="" type="checkbox"/> Certified <input type="checkbox"/> COD <input type="checkbox"/> Express Mail <input type="checkbox"/> Return Receipt for Merchandise |
| 6. Signature (Agent) <i>[Signature]</i> | 7. Date of Delivery |
| | 8. Addressee's Address (Only if requested and fee is paid) |

PS Form 3811, October 1990 *U.S. GPO: 1990-273-881 **DOMESTIC RETURN RECEIPT**

P 832 538 666

Certified Mail Receipt
No Insurance Coverage Provided
Do not use for International Mail
(See Reverse)



| | |
|---|----|
| Sent to | |
| Mr. L. D. Riley, Stone Cont. | |
| Street & No. Corp. | |
| P. O. Box 2560 | |
| P.O., State & ZIP Code | |
| Panama City, FL 32402 | |
| Postage | \$ |
| Certified Fee | |
| Special Delivery Fee | |
| Restricted Delivery Fee | |
| Return Receipt Showing to Whom & Date Delivered | |
| Return Receipt Showing to Whom, Date, & Address of Delivery | |
| TOTAL Postage & Fees | \$ |
| Postmark or Date | |
| Mailed: 8-1-91 | |
| Permit: AC 03-190964 | |

PS Form 3800, June 1990

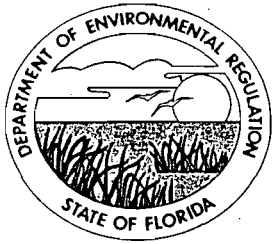

Florida Department of Environmental Regulation

Twin Towers Office Bldg. • 2600 Blair Stone Road • Tallahassee, Florida 32399-2400

Lawton Chiles, Governor

Carol M. Browner, Secretary

July 31, 1991

CERTIFIED MAIL-RETURN RECEIPT REQUESTED

Mr. L. D. Riley, Jr.
Stone Container Corporation
1 Everitt Avenue
Post Office Box 2560
Panama City, Florida 32402

Dear Mr. Riley:

Attached is one copy of the Technical Evaluation and Preliminary Determination and proposed permit to modify the No. 4 Bark Boiler, which is to designate it as the secondary incinerator of the TRS gases from the TRS noncondensable gas handling and transport system on an as needed basis, with the lime kiln remaining as the primary incinerator.

Please submit any written comments you wish to have considered concerning the Department's proposed action to Mr. Barry Andrews of the Bureau of Air Regulation.

Sincerely,

for C. H. Fancy, P.E.
Chief
Bureau of Air Regulation

CHF/BM/plm

Attachments

c: E. Middleswart, NW District
C. T. Fontaine, P.E., SCC
J. Harper, EPA

BEFORE THE STATE OF FLORIDA
DEPARTMENT OF ENVIRONMENTAL REGULATION

In the Matter of
Application for Permit by:

Stone Container Corporation
1 Everitt Avenue
Post Office Box 2560
Panama City, Florida 32402

DER File No. AC 03-190964
Bay County

INTENT TO ISSUE

The Department of Environmental Regulation hereby gives notice of its intent to issue an air construction permit (copy attached) for the proposed project as detailed in the application specified above. The Department is issuing this Intent to Issue for the reasons stated in the attached Technical Evaluation and Preliminary Determination.

The applicant, Stone Container Corporation, applied on May 23, 1991, to the Department of Environmental Regulation for a permit to modify the No. 4 Bark Boiler, which is to designate it as the secondary incinerator of the TRS gases from the TRS noncondensable gas handling and transport system on an as needed basis, with the lime kiln remaining as the primary incinerator.

The Department has permitting jurisdiction under Chapter 403, Florida Statutes, and Florida Administrative Code Chapters 17-2 and 17-4. The project is not exempt from permitting procedures. The Department has determined that an air construction permit is required for the proposed work.

Pursuant to Section 403.815, F.S. and DER Rule 17-103.150, F.A.C., you (the applicant) are required to publish at your own expense the enclosed Notice of Intent to Issue Permit. The notice shall be published one time only within 30 days, in the legal ad section of a newspaper of general circulation in the area affected. For the purpose of this rule, "publication in a newspaper of general circulation in the area affected" means publication in a newspaper meeting the requirements of Sections 50.011 and 50.031, F.S., in the county where the activity is to take place. Where there is more than one newspaper of general circulation in the county, the newspaper used must be the one with significant circulation in the area that may be affected by the permit. If you are uncertain that a newspaper meets these requirements, please contact the Department at the address or telephone number listed below. The applicant shall provide proof of publication to the Department's Bureau of Air Regulation, 2600 Blair Stone Road, Tallahassee, Florida 32399-2400 (904-488-1344), within seven days of publication. Failure to publish the notice and provide proof of publication within the allotted time may result in the denial of the permit.

The Department will issue the permit with the attached conditions unless a petition for an administrative proceeding (hearing) is filed pursuant to the provisions of Section 120.57, F.S.

A person whose substantial interests are affected by the Department's proposed permitting decision may petition for an administrative proceeding (hearing) in accordance with Section 120.57, Florida Statutes. The petition must contain the information set forth below and must be filed (received) in the Office of General Counsel of the Department at 2600 Blair Stone Road, Tallahassee, Florida 32399-2400. Petitions filed by the permit applicant and the parties listed below must be filed within 14 days of receipt of this intent. Petitions filed by other persons must be filed within 14 days of publication of the public notice or within 14 days of receipt of this intent, whichever first occurs. Petitioner shall mail a copy of the petition to the applicant at the address indicated above at the time of filing. Failure to file a petition within this time period shall constitute a waiver of any right such person may have to request an administrative determination (hearing) under Section 120.57, Florida Statutes.

The Petition shall contain the following information;

- (a) The name, address, and telephone number of each petitioner, the applicant's name and address, the Department Permit File Number and the county in which the project is proposed;
- (b) A statement of how and when each petitioner received notice of the Department's action or proposed action;
- (c) A statement of how each petitioner's substantial interests are affected by the Department's action or proposed action;
- (d) A statement of the material facts disputed by Petitioner, if any;
- (e) A statement of facts which petitioner contends warrant reversal or modification of the Department's action or proposed action;
- (f) A statement of which rules or statutes petitioner contends require reversal or modification of the Department's action or proposed action; and,
- (g) A statement of the relief sought by petitioner, stating precisely the action petitioner wants the Department to take with respect to the Department's action or proposed action.

If a petition is filed, the administrative hearing process is designed to formulate agency action. Accordingly, the Department's final action may be different from the position taken by it in this notice. Persons whose substantial interests will be affected by any decision of the Department with regard to the application(s) have the right to petition to become a party to the proceeding. The petition must conform to the requirements specified above and be filed (received) within 14 days of publication of this notice in the Office in General Counsel at the above address of the Department. Failure to petition within the allowed time frame constitutes a waiver of any right such person has to request a hearing under Section 120.57, F.S., and to participate as a party to this

proceeding. Any subsequent intervention will only be at the approval of the presiding officer upon motion filed pursuant to Rule 28-5.207, F.A.C.

Executed in Tallahassee, Florida.

STATE OF FLORIDA DEPARTMENT
OF ENVIRONMENTAL REGULATION

for Barry D. Anheuer
C. H. Fancy, P.E.
Chief
Bureau of Air Regulation

CERTIFICATE OF SERVICE

The undersigned duly designated deputy clerk hereby certifies that this INTENT TO ISSUE and all copies were mailed by certified mail before the close of business on 8-1-91 to the listed persons.

Clerk Stamp

FILING AND ACKNOWLEDGMENT

FILED, on this date, pursuant to §120.52(11), Florida Statutes, with the designated Department Clerk, receipt of which is hereby acknowledged.

Kenn Joken 8-1-91
Clerk Date

Copies furnished to:

E. Middleswart, NW District
C. T. Fontaine, P.E., SCC

State of Florida
Department of Environmental Regulation
Notice of Intent to Issue

The Department of Environmental Regulation hereby gives notice of its intent to issue a permit to Stone Container Corporation, 1 Everitt Avenue, Panama City, Bay County, Florida 32402, to modify the No. 4 Bark Boiler, which is to designate it as the secondary incinerator of the TRS gases from the TRS noncondensable gas handling and transport system on an as needed basis, with the lime kiln remaining as the primary incinerator. A determination of Best Available Control Technology (BACT) was not required. The Department is issuing this Intent to Issue for the reasons stated in the Technical Evaluation and Preliminary Determination.

A person whose substantial interests are affected by the Department's proposed permitting decision may petition for an administrative proceeding (hearing) in accordance with Section 120.57, Florida Statutes. The petition must contain the information set forth below and must be filed (received) in the Office of General Counsel of the Department at 2600 Blair Stone Road, Tallahassee, Florida 32399-2400, within fourteen (14) days of publication of this notice. Petitioner shall mail a copy of the petition to the applicant at the address indicated above at the time of filing. Failure to file a petition within this time period shall constitute a waiver of any right such person may have to request an administrative determination (hearing) under Section 120.57, Florida Statutes.

The Petition shall contain the following information:

- (a) The name, address, and telephone number of each petitioner, the applicant's name and address, the Department Permit File Number and the county in which the project is proposed;
- (b) A statement of how and when each petitioner received notice of the Department's action or proposed action;
- (c) A statement of how each petitioner's substantial interests are affected by the Department's action or proposed action;
- (d) A statement of the material facts disputed by Petitioner, if any;
- (e) A statement of facts which petitioner contends warrant reversal or modification of the Department's action or proposed action;
- (f) A statement of which rules or statutes petitioner contends require reversal or modification of the Department's action or proposed action; and,
- (g) A statement of the relief sought by petitioner, stating precisely the action petitioner wants the Department to take with respect to the Department's action or proposed action.

If a petition is filed, the administrative hearing process is designed to formulate agency action. Accordingly, the Department's final action may be different from the position taken by it in this Notice. Persons whose substantial interests will be affected by any decision of the Department with regard to the application have the right to petition to become a party to the proceeding. The petition must conform to the requirements specified above and be filed (received) within 14 days of publication of this notice in the Office of General Counsel at the above address of the Department. Failure to petition within the allowed time frame constitutes a waiver of any right such person has to request a hearing under Section 120.57, F.S., and to participate as a party to this proceeding. Any subsequent intervention will only be at the approval of the presiding officer upon motion filed pursuant to Rule 28-5.207, F.A.C.

The application is available for public inspection during business hours, 8:00 a.m. to 5:00 p.m., Monday through Friday, except legal holidays, at:

Department of Environmental Regulation
Bureau of Air Regulation
2600 Blair Stone Road
Tallahassee, Florida 32399-2400

Department of Environmental Regulation
Northwest District
160 Governmental Center
Pensacola, Florida 32501-5794

Any person may send written comments on the proposed action to Mr. Barry Andrews at the Department's Tallahassee address. All comments mailed within 14 days of the publication of this notice will be considered in the Department's final determination.

Technical Evaluation
and
Preliminary Determination

Stone Container Corporation
Bay County
Panama City, Florida

Construction Permit Number
AC 03-190964

Department of Environmental Regulation
Division of Air Resources Management
Bureau of Air Regulation

July 31, 1991

I. Application

A. Applicant and Address

Stone Container Corporation
1 Everitt Avenue
Post Office Box 2560
Panama City, Florida 32402

B. Project and Location

The mill intends to modify the No. 4 Bark Boiler by designating it as the secondary incinerator of the TRS gases from the TRS noncondensable gas handling and transport system on an as needed basis, with the lime kiln remaining as the primary incinerator. The project will take place at Stone Container Corporation's existing mill located in Bay County, Florida. The UTM coordinates are Zone 16, 632.8 km East and 3335.1 km North.

C. Process and Controls

The No. 4 Bark Boiler is permitted to fire combinations of coal, No. 6 fuel oil, turpentine residue, natural gas and wood waste. The maximum fuel sulfur content, by weight, is limited to 2.4% in the fuel oil and 1.7% for coal.

The combustion/oxidation of the TRS gases from the NCG system will result in emissions of sulfur dioxide (SO₂).

The boiler has an associated venturi caustic scrubber system to control pollutant emissions. In order to minimize SO₂ emissions, the scrubber water's pH will be maintained at a minimum of 8.0 while incinerating TRS gases and/or firing fossil fuel only.

D. SIC and SCC

1. The Standard Industrial Codes are:

- o 2611: Pulp Mills
- o 2621: Paper Mills

2. The Source Classification Codes are:

- o Major Group 49:

External Combustion Boiler 1-02-099-02 tons burned
Wood/Bark Waste

II. Rule Applicability

The modification is subject to preconstruction review in accordance with Chapter 403, Florida Statutes, Florida Administrative Code (F.A.C.) Chapters 17-2 and 17-4, and 40 CFR (July, 1990 version).

The application package was deemed complete on May 23, 1991.

The existing facility is a major facility for all of the criteria pollutants pursuant to F.A.C. Rule 17-2.100, Definitions. The No. 4 Bark Boiler is a major source for SO₂ pursuant to F.A.C. Rule 17-2.100.

The existing facility is located in Bay County, which is an area designated attainment for all pollutants pursuant to F.A.C. Rule 17-2.420.

The following table exhibits the net potential pollutant emissions from the modification in tons per year (TPY):

Table 1

| Source | Net Potential Pollutant Emissions (TPY) | |
|-------------------|---|-----------------|
| | TRS | SO ₂ |
| No. 4 Bark Boiler | 0.00 | <39.0 |

- Note:
- o Maximum annual hours of operation are 8760, including incineration of TRS gases.
 - o SO₂: less than the PSD significant rate for New Source Review (based on actual test results plus a margin of safety - synthetic minor).
 - o Future PSD evaluations will be based on "actual emissions" vs. "potential/allowable emissions".

Since the net potential pollutant emissions are not greater than the significant levels in Table 500-2, F.A.C. Chapter 17-2, the modification's potential pollutant emissions will be reviewed in accordance with F.A.C. Rule 17-2.520, Sources Not Subject to Prevention of Significant Deterioration (PSD) or Nonattainment Requirements.

The No. 4 Bark Boiler is subject to the provisions of F.A.C. Rule 17-2.600(10)(a), Carbonaceous Fuel Burning Equipment, and F.A.C. Rule 17-2.600(5)(a), Fossil Fuel Steam Generators with more than 250 MMBtu/hr Heat Input.

The No. 4 Bark Boiler is subject to the provisions of F.A.C. Rule 17-2.600(4)(c)6. pursuant to F.A.C. Rule 17-2.600(4)(c)1.

While burning a combination of carbonaceous and fossil fuels, visible emissions shall not exceed 30% opacity, except that 40% opacity is permissible for not more than 2 minutes in any one hour pursuant to F.A.C. Rule 17-2.600(10)(a)2.a. While burning fossil fuel only, visible emissions shall not exceed 20% opacity, except that 40% opacity is permissible for one 2-minute period per hour pursuant to F.A.C. Rule 17-2.600(5)(a)1. Initial and annual compliance tests shall be conducted using EPA Method 9 pursuant to F.A.C. Rule 17-2.700 and 40 CFR 60, Appendix A.

Particulate matter emissions shall be limited to 0.3 lbs/10⁶ Btu of heat input of carbonaceous fuel and 0.1 lbs/10⁶ Btu of heat input of fossil fuel. Initial and annual compliance tests shall be conducted using EPA Method 5 pursuant to F.A.C. Rule 17-2.700 and 40 CFR 60, Appendix A.

Particulate matter and visible emissions compliance tests shall be conducted concurrently, weather permitting.

All compliance test methods shall be in accordance with F.A.C. Rule 17-2.700 and 40 CFR 60, Appendix A (July, 1990 version).

The No. 4 Bark Boiler is subject to the provisions of F.A.C. Rule 17-2.620(2), Objectionable Odors Prohibited.

The No. 4 Bark Boiler is subject to the provisions of F.A.C. Rule 17-2.710, which includes quarterly reporting requirements.

An initial TRS mass compliance test using EPA Method 16, 16A or 16B, shall be required in accordance with F.A.C. Rule 17-2.700 and 40 CFR 60, Appendix A. The Department shall reserve the right to require TRS mass emissions tests for annual compliance and for permit renewal times and will require that a continuous temperature monitor and recorder be installed, properly operated, and maintained (see attachment: C. H. Fancy's letter dated April 5, 1990).

The No. 4 Bark Boiler is subject to the provisions of F.A.C. Rules 17-2.240: Circumvention; 17-2.250: Excess Emissions; and, 17-4.130: Plant Operations-Problems.

The modification to the No. 4 Bark Boiler is subject to all applicable provisions of F.A.C. Chapters 17-2 and 17-4 and 40 CFR (July, 1990 version).

III. Summary of Emissions

A. Emission Limitations

The No. 4 Bark Boiler will have allowable emission limits and standards for the pollutants TRS, PM, SO₂ and visible emissions (VE). The following table reflects these emission limitations/standards:

Table 2

| Source | Pollutant | Allowable Emission Limits/Standards |
|-------------------|-----------------|---|
| No. 4 Bark Boiler | TRS | 5 ppmvd @ standard conditions, @ 10% O ₂ , 12-hr average (4.45 lbs/hr, 19.5 TPY) |
| | PM | 0.3 lbs/10 ⁶ Btu heat input - carbonaceous fuel 0.1 lbs/10 ⁶ Btu heat input - fossil fuel (86.6 lbs/hr, 379.3 TPY - combination of both types of fuels) |
| | SO ₂ | 772 lbs/hr, 3381 TPY (No TRS Incineration) ¹ 781 lbs/hr, 3420 TPY (TRS Incineration) ² |
| | VE | carbonaceous fuel: ≤ 30% opacity, except ≤ 40% opacity for ≤ 2 mins. in any one hour; and, fossil fuel: ≤ 27% opacity, except ≤ 40% opacity for one 2-minute period per hour |

- Note:
- o Maximum permitted hours of operation are 8760, which includes incinerating TRS gases from the TRS NCG System.
 - o PM: F.A.C. Rules 17-2.600(10)(a)2. and 17-2.600(5)(a)2.
 - o SO₂: scrubber removal efficiency @ 35%
 1. No TRS Incineration: based on AP-42, Table 1.3-1 for fuel oil - industrial boiler: 157S lbs/1000 gals; 2.4%S, 3150 gals/hr.
 2. TRS Incineration: Sum of the amount from "no TRS incineration" and 39.0 TPY.
 - o Pulp production capacity is 1694 TPD ADP.
 - o TRS emissions @ 5 ppmvd, corr. to 10% O₂, @ std. cond., 12-hr avg. (4.45 lbs/hr, 19.5 TPY).
 - o Boiler capacity is 300,000 lbs/hr steam produced.

B. Ambient Air Quality Analysis

Based on a technical review of the proposed project, an air quality analysis was not required.

IV. Conclusion

Based on the information provided by Stone Container Corporation, the Department has reasonable assurance that the modification of the No. 4 Bark Boiler to allow the incineration of TRS gases on an as needed basis, as described in this evaluation, and subject to the conditions proposed herein, will not cause or contribute to a violation of any air quality standard, PSD increment, or any other technical provision of Chapter 17-2 of the Florida Administrative Code.

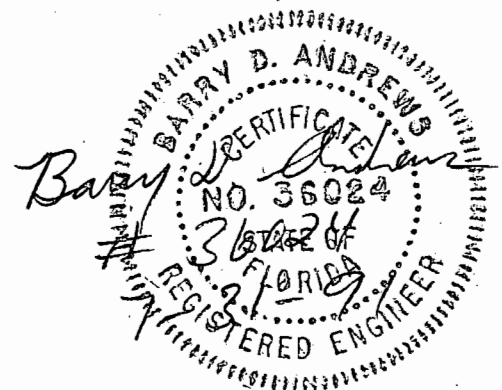



Florida Department of Environmental Regulation

Twin Towers Office Bldg. • 2600 Blair Stone Road • Tallahassee, Florida 32399-2400

Lawton Chiles, Governor

Carol M. Browner, Secretary

PERMITTEE:

Stone Container Corporation
Post Office Box 2560
Panama City, Florida 32402

Permit Number: AC 03-190964
Expiration Date: Dec. 31, 1991
County: Bay
Latitude/Longitude: 30°08'30"N
85°37'25"W

Project: No. 4 Bark Boiler
Modification

This permit is issued under the provisions of Chapter 403, Florida Statutes, Florida Administrative Code (F.A.C.) Chapters 17-2 and 17-4, and 40 CFR (July, 1990 version). The above named permittee is hereby authorized to perform the work or operate the facility shown on the application and approved drawings, plans, and other documents attached hereto or on file with the Department and made a part hereof and specifically described as follows:

For a modification to the No. 4 Bark Boiler by designating it as the secondary control device (incinerator) of the TRS gases from the TRS noncondensable gas handling and transport system on an as needed basis, with the lime kiln remaining as the primary incinerator. The TRS gases are collected from the Nos. 1A, 2, and 3 Multiple Effect Evaporator (MEE) Systems and the batch digesting blow heat recovery system. The No. 4 Bark Boiler's capacity is 300,000 pounds of steam produced per hour. A venturi scrubber system will use pH control (i.e., pH @ 8.0 minimum) to minimize SO₂ emissions. The UTM coordinates of the existing facility are Zone 16, 632.8 km East and 3355.1 km North.

The Standard Industrial Codes are: 2611-Pulp Mill.
2621-Paper Mill.

The Standard Classification Code is:

- o External Combustion Boilers: 1-02-009-02 tons burned
Wood/Bark Waste

The source shall be constructed/modified in accordance with the permit application, plans, documents, amendments and drawings, except as otherwise noted in the General and Specific Conditions.

Attachments to be Incorporated:

1. Mr. David Riley's letter received December 21, 1990, via FAX.
2. Application to Construct/Modify Air Pollution Sources, DER Form 17-1.202(1), received May 23, 1991.
3. Interoffice Memorandum by Bruce Mitchell dated July 26, 1991.
4. Mr. C. H. Fancy's letter dated April 5, 1990.
5. Technical Evaluation and Preliminary Determination dated July 31, 1991.

PERMITTEE:
Stone Container Corporation

Permit Number: AC 03-190964
Expiration Date: December 31, 1991

GENERAL CONDITIONS:

1. The terms, conditions, requirements, limitations, and restrictions set forth in this permit are "Permit Conditions" and are binding and enforceable pursuant to Sections 403.161, 403.727, or 403.859 through 403.861, Florida Statutes. The permittee is placed on notice that the Department will review this permit periodically and may initiate enforcement action for any violation of these conditions.

2. This permit is valid only for the specific processes and operations applied for and indicated in the approved drawings or exhibits. Any unauthorized deviation from the approved drawings, exhibits, specifications, or conditions of this permit may constitute grounds for revocation and enforcement action by the Department.

3. As provided in Subsections 403.087(6) and 403.722(5), Florida Statutes, the issuance of this permit does not convey any vested rights or any exclusive privileges. Neither does it authorize any injury to public or private property or any invasion of personal rights, nor any infringement of federal, state or local laws or regulations. This permit is not a waiver of or approval of any other Department permit that may be required for other aspects of the total project which are not addressed in the permit.

4. This permit conveys no title to land or water, does not constitute State recognition or acknowledgement of title, and does not constitute authority for the use of submerged lands unless herein provided and the necessary title or leasehold interests have been obtained from the State. Only the Trustees of the Internal Improvement Trust Fund may express State opinion as to title.

5. This permit does not relieve the permittee from liability for harm or injury to human health or welfare, animal, or plant life, or property caused by the construction or operation of this permitted source, or from penalties therefore; nor does it allow the permittee to cause pollution in contravention of Florida Statutes and Department rules, unless specifically authorized by an order from the Department.

6. The permittee shall properly operate and maintain the facility and systems of treatment and control (and related appurtenances) that are installed or used by the permittee to achieve compliance with the conditions of this permit, as required by Department rules. This provision includes the operation of backup or auxiliary facilities or similar systems when necessary to achieve compliance with the conditions of the permit and when required by Department rules.

PERMITTEE:
Stone Container Corporation

Permit Number: AC 03-190964
Expiration Date: December 31, 1991

GENERAL CONDITIONS:

7. The permittee, by accepting this permit, specifically agrees to allow authorized Department personnel, upon presentation of credentials or other documents as may be required by law and at a reasonable time, access to the premises, where the permitted activity is located or conducted to:

- a. Have access to and copy any records that must be kept under the conditions of the permit;
- b. Inspect the facility, equipment, practices, or operations regulated or required under this permit; and,
- c. Sample or monitor any substances or parameters at any location reasonably necessary to assure compliance with this permit or Department rules.

Reasonable time may depend on the nature of the concern being investigated.

8. If, for any reason, the permittee does not comply with or will be unable to comply with any condition or limitation specified in this permit, the permittee shall immediately provide the Department with the following information:

- a. a description of and cause of non-compliance; and,
- b. the period of noncompliance, including dates and times; or, if not corrected, the anticipated time the non-compliance is expected to continue, and steps being taken to reduce, eliminate, and prevent recurrence of the non-compliance.

The permittee shall be responsible for any and all damages which may result and may be subject to enforcement action by the Department for penalties or for revocation of this permit.

9. In accepting this permit, the permittee understands and agrees that all records, notes, monitoring data and other information relating to the construction or operation of this permitted source which are submitted to the Department may be used by the Department as evidence in any enforcement case involving the permitted source arising under the Florida Statutes or Department rules, except where such use is proscribed by Sections 403.73 and 403.111, Florida Statutes. Such evidence shall only be used to the extent it is consistent with the Florida Rules of Civil Procedure and appropriate evidentiary rules.

PERMITTEE:
Stone Container Corporation

Permit Number: AC 03-190964
Expiration Date: December 31, 1991

GENERAL CONDITIONS:

10. The permittee agrees to comply with changes in Department rules and Florida Statutes after a reasonable time for compliance, provided, however, the permittee does not waive any other rights granted by Florida Statutes or Department rules.

11. This permit is transferable only upon Department approval in accordance with Florida Administrative Code Rules 17-4.120 and 17-30.300, F.A.C., as applicable. The permittee shall be liable for any non-compliance of the permitted activity until the transfer is approved by the Department.

12. This permit or a copy thereof shall be kept at the work site of the permitted activity.

13. The permittee shall comply with the following:

a. Upon request, the permittee shall furnish all records and plans required under Department rules. During enforcement actions, the retention period for all records will be extended automatically unless otherwise stipulated by the Department.

b. The permittee shall hold at the facility or other location designated by this permit records of all monitoring information (including all calibration and maintenance records and all original strip chart recordings for continuous monitoring instrumentation) required by the permit, copies of all reports required by this permit, and records of all data used to complete the application for this permit. These materials shall be retained at least three years from the date of the sample, measurement, report, or application unless otherwise specified by Department rule.

c. Records of monitoring information shall include:

- the date, exact place, and time of sampling or measurements;
- the person responsible for performing the sampling or measurements;
- the dates analyses were performed;
- the person responsible for performing the analyses;
- the analytical techniques or methods used; and,
- the results of such analyses.

PERMITTEE:
Stone Container Corporation

Permit Number: AC 03-190964
Expiration Date: December 31, 1991

GENERAL CONDITIONS:

14. When requested by the Department, the permittee shall within a reasonable time furnish any information required by law which is needed to determine compliance with the permit. If the permittee becomes aware that relevant facts were not submitted or were incorrect in the permit application or in any report to the Department, such facts or information shall be corrected promptly.

SPECIFIC CONDITIONS:

1. This permit, which is for the No. 4 Bark Boiler, shall supercede previous air permits issued.

2. The No. 4 Bark Boiler may operate continuously, i.e., 8760 hrs/yr, including the incineration of TRS gases.

3. The maximum rated capacity is 300,000 pounds of steam produced per hour from firing any combination of fuels of wood waste, No. 6 fuel oil, coal, and turpentine residue.

4. The maximum fuel utilization rates, heat inputs, and their maximum % sulfur, by weight, are:

| | | | |
|------------------|--------------|--------------|------|
| o No. 6 Fuel Oil | 3150 gals/hr | 472 MMBtu/hr | 2.4% |
| o Coal | 15.8 TPH | 395 MMBtu/hr | 1.7% |
| o Wood Bark | 30.0 TPH | 273 MMBtu/hr | - |
| o Natural Gas | 0.04 MMcf/hr | 40 MMBtu/hr | - |

5. When the TRS gases from the Nos. 1A, 2, and 3 MEE Systems and the batch digesting system are collected and transported to the No. 4 Bark Boiler for incineration, then the TRS gases shall be subjected to a minimum of 1200°F for at least 0.5 seconds.

6. A continuous temperature monitor shall be installed, calibrated, and operated in accordance with F.A.C. Rule 17-2.710. Also, a continuous recorder for the temperature shall be installed, calibrated, and properly operated.

7. The No. 4 Bark Boiler is subject to the provisions of F.A.C. Rule 17-2.600(4)(c)1.c., which includes the requirement of establishing a contingency plan.

8. The No. 4 Bark Boiler is subject to the provisions of F.A.C. Rules 17-4.130: Plant Operation-Problems; 17-2.240: Circumvention, 17-2.250: Excess Emissions; and, 17-2.710(4): Quarterly Reporting Requirements.

9. The project shall comply with all applicable provisions of F.A.C. Chapters 17-2 and 17-4 and 40 CFR (July, 1990 version).

PERMITTEE:
Stone Container Corporation

Permit Number: AC 03-190964
Expiration Date: December 31, 1991

SPECIFIC CONDITIONS:

10. The No. 4 Bark Boiler emissions shall not exceed:

- a) TRS: 5 ppmvd at standard conditions, corrected to 10% O₂,
12-hr avg (4.35 lbs/hr; 19.1 TPY)
- b) SO₂: 772 lbs/hr; 3381 TPY (No TRS Incineration)
781 lbs/hr; 3420 TPY (TRS Incineration)
- c) PM: o carbonaceous fuel: 0.3 lbs/10⁶ Btu of heat input
o fossil fuel: 0.1 lbs/10⁶ Btu of heat input
(86.6 lbs/hr, 379.3 TPY: combination of fuels)
- d) VE:
 - o carbonaceous fuel: ≤ 30% opacity, except ≤ 40% opacity
for ≤ 2 minutes in any 1 hour
 - o fossil fuel only: ≤ 20% opacity, except ≤ 40% opacity
for one 2-minute period per hour

Note: o Fly ash and SO₂ are controlled by a wet caustic scrubber.
o Projected SO₂ removal efficiency is 35% during operation.
o PSD pollutant evaluation will compare "actual emissions"
with "future allowable/potential emissions".

11. Annual compliance tests for PM and visible emissions shall be conducted concurrently, weather permitting, using the following test methods in accordance with F.A.C. Rule 17-2.700 and 40 CFR 60, Appendix A:

- a) EPA Method 5, Determination of Particulate Emissions from Stationary Sources.
- b) EPA Method 9, Visual Determination of the Opacity of Emissions from Stationary Sources.

12. Initial and annual compliance tests for SO₂ shall be conducted using the following test method in accordance with F.A.C. Rule 17-2.700 and 40 CFR 60, Appendix A:

- a) EPA Method 6, Determination of Sulfur Dioxide Emissions from Stationary Sources.

13. Compliance tests for TRS shall be conducted using one of the following test methods in accordance with F.A.C. Rule 17-2.700 and 40 CFR 60, Appendix A:

- a) EPA Method 16, 16A or 16B, Determination of TRS Emissions from Stationary Sources.

14. The Department reserves the right to require testing for TRS, in accordance with No. 13 above, for operating permit renewal (see Mr. C. H. Fancy's letter dated April 5, 1990).

PERMITTEE:
Stone Container Corporation

Permit Number: AC 03-190964
Expiration Date: December 31, 1991

SPECIFIC CONDITIONS:

15. Other test methods and alternate compliance procedures may be used only after prior Departmental approval has been obtained in writing in accordance with F.A.C. Rule 17-2.700(3).

16. The control equipment shall be inspected regularly and maintained in good operating condition to minimize fugitive gaseous emissions.

17. Objectionable odors shall not be allowed off plant property in accordance with F.A.C. Rule 17-2.620(2).

18. The sulfur content of the No. 6 fuel oil and the coal shall be verified using ASTM D1552-83 and ASTM D3177-75, respectively; and, the lab analysis data sheet(s), which are provided by the fuel oil and coal vendors upon delivery, shall be kept on record for at least two years.

19. The Department's Northwest District office shall be notified when the boiler is switched to operating at 100% fossil fuel; and, a log book shall be maintained recording, at a minimum, the date(s) and the beginning and ending "clock time(s)" of operation while firing 100% fossil fuel.

20. The Department's Northwest District office shall be notified in writing at least 15 days prior to source testing pursuant to F.A.C. Rule 17-2.700(2). Written reports of the tests shall be submitted to the Department's Northwest District office within 45 days of the test completion in accordance with F.A.C. Rule 17-2.700(7).

21. Any change in the method of operation, raw materials, chemicals processed, equipment, or operating hours pursuant to F.A.C. Rule 17-2.100, Definitions-Modification, shall be submitted for approval to the Department's Bureau of Air Regulation office and Northwest District office.

22. The pH of the venturi scrubber system shall be maintained at a minimum of 8.0 while incinerating TRS gases. A continuous pH recorder shall be installed, calibrated, and properly operated to monitor the pH of the scrubbing medium.

23. The permittee, for good cause, may request that this construction permit be extended. Such a request shall be submitted to the Department's Bureau of Air Regulation prior to 60 days before the expiration of the permit (F.A.C. Rule 17-4.090).

PERMITTEE:
Stone Container Corporation

Permit Number: AC 03-190964
Expiration Date: December 31, 1991

SPECIFIC CONDITIONS:

24. An application for an operation permit must be submitted to the Department's Northwest District office at least 90 days prior to the expiration date of this construction permit. To properly apply for an operation permit, the applicant shall submit the appropriate application form, fee, certification that construction was completed while noting any deviations from the conditions in the construction permit, and compliance test reports as required by this permit (F.A.C. Rules 17-4.055 and 17-4.220).

Issued this _____ day
of _____, 1991

STATE OF FLORIDA DEPARTMENT
OF ENVIRONMENTAL REGULATION

STEVE SMALLWOOD, P.E., Director
Division of Air Resources
Management



State of Florida
DEPARTMENT OF ENVIRONMENTAL REGULATION

| For Routing To Other Than The Addressee | |
|---|-----------------|
| To: _____ | Location: _____ |
| To: _____ | Location: _____ |
| To: _____ | Location: _____ |
| From: _____ | Date: _____ |

Interoffice Memorandum

TO: Main File: AC 03-190964
FROM: Bruce Mitchell *BBM*
DATE: July 26, 1991
SUBJ: Calculation of TRS Limits From the Emission Limiting Standard

Based on stack test parameters received from Mr. David Riley, with Stone Container Corporation, the TRS emission limits are calculated:

Parameters: September, 1989 test data
258,000 acfm
182,849 dscfm
9.5% O₂
19.5% H₂O
140°F

Standard: 5 ppmvd @ standard conditions corrected to 10% O₂

Correction for O₂:
 $(21-10)/(21-9.5) = 0.957$
 $5 \text{ ppm}/0.957 = 5.22 \text{ ppm}$

Therefore,

$$PV = mRT$$

$$M = PV/RT$$

$$m = (14.7 \times 144) \text{ lbf/ft}^2 \times 182,849 \text{ dcfm} \times \text{lbfm-R}^\circ/45.44 \text{ ft-lbf} \times \\ 1/(460 + 140) \text{ R}^\circ \times 60 \text{ min/hr} \times 5.22 \text{ ppm}/10^6 = 4.45 \text{ lbs/hr} \\ \text{as H}_2\text{S}$$

$$4.45 \text{ lbs/hr} \times 8760 \text{ hrs/yr} - 2000 \text{ lbs/ton} = 19.5 \text{ TPY}$$

BM/rbm



Stone Container Corporation

Panama City Mill

Containerboard and Paper Division

Post Office Box 2560
Panama City, Florida 32402

RECEIVED

NOV 14 1991

(904) 785-4311

November 12, 1991
Division of Air
Resources Management

Mr. C.H. Fancy, Chief
Bureau of Air Regulations
Florida Department of Environmental Regulation
2600 Blainstone Road
Tallahassee, Florida 32399-2400

Dear Mr. Fancy:

Enclosed is proof of publication of the intent to issue the construction permit concerning Stone Container Corporation's No. 4 bark boiler at its Panama City Facility.

Sincerely yours,

L.D. Riley, Jr.
Environmental Superintendent

LDR/smj
Enclosure

cc: Jack Prescott
C.F. Bogatie
Ches Fensom

Florida Freedom Newspapers, Inc.

PUBLISHERS OF THE NEWS HERALD
Panama City, Bay County, Florida
Published Daily

State of Florida }
County of Bay }

Before the undersigned authority appeared _____
DENNIS KOZAK

_____, who on oath says that (s)he
is _____
ADVERTISING DIRECTOR

of the News Herald, a daily
newspaper published at Panama City, in Bay County, Florida; that the attached copy
of advertisement, being a _____
LEGAL ADVERTISEMMENT

in the matter of _____
NOTICE OF INTENT TO ISSUE PERMIT
STONE CONTAINER

in the _____
BAY COUNTY

Court, was published in said newspaper in the issues of _____
NOVEMBER 8, 1991

Affiant further says that the News Herald is a direct successor of the Panama City News and that this publication, together with its direct predecessor, has been continuously published in said Bay County, Florida, each day (except that the predecessor, Panama City News, was not published on Sundays), and that this publication together with its said predecessor, has been entered as a second class mail matter at the post office in Panama City in said Bay County, Florida, for a period of one year next preceding the first publication of the attached copy of the advertisement, all in accordance with the provisions of section 49.03, Florida Statutes; and affiant further says that (s)he has neither paid nor promised any person, firm or corporation any discount, rebate, commission or refund for the purpose of securing this advertisement for publication in the said newspaper.

[Signature]

Sworn to and subscribed before me this _____ 8th day of
NOVEMBER _____, 1991

[Signature]
Notary Public, State of Florida at Large

Notary Public, State of Florida
My Commission Expires Aug. 25, 1992
My Commission Expires _____

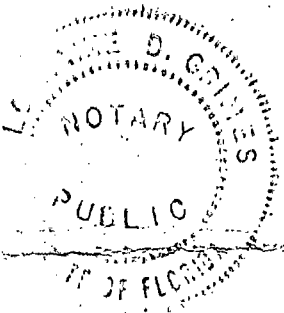

2351
State of Florida Department of
Environmental Regulation
Notice of Intent to Issue

The Department of Environmental Regulation hereby gives notice of its intent to issue a permit to Stone Container Corporation, 1 Everitt Avenue, Panama City, Bay County, Florida 32402, to modify the No. 4 Bark Boiler, which is to designate it as the secondary incinerator of the TRS gases from the TRS noncondensable gas handling and transport system on an as needed basis, with the lime kiln remaining as the primary incinerator. A determination of Best Available Control Technology (BACT) was not required. The Department is issuing this Intent to Issue for the reasons stated in the Technical Evaluation and Preliminary Determination.

A person whose substantial interests are affected by the Department's proposed permitting decision may petition for an administrative proceeding (hearing) in accordance with Section 120.57, Florida Statutes. The petition must contain the information set forth below and must be filed (received) in the Office of General Counsel of the Department at 2600 Blair Stone Road, Tallahassee, Florida 32399-2400, within fourteen (14) days of publication of this notice. Petitioner shall mail a copy of the petition to the applicant at the address indicated above at the time of filing. Failure to file a petition within this time period shall constitute a waiver of any right such person may have to request an administrative determination (hearing) under Section 120.57, Florida Statutes.

The Petition shall contain the following information:

- (a) The name, address, and telephone number of each petitioner, the applicant's name and address, the Department Permit File Number and the county in which the project is proposed;
- (b) A statement of how and when each petitioner received notice of the Department's action or proposed action;
- (c) A statement of how each petitioner's substantial interests are affected by the Department's action or proposed action;
- (d) A statement of the material facts disputed by Petitioner, if any;
- (e) A statement of facts which petitioner contends warrant reversal or modification of the Department's action or proposed action;
- (f) A statement of which rules or statutes petitioner contends require reversal or modification of the Department's action or proposed action; and
- (g) A statement of the relief sought by petitioner, stating precisely the action petitioner wants the Department to take with respect to the Department's action or proposed action.

When a petition is filed, the administrative hearing process is designed to formulate agency action. Accordingly, the Department's final action may be different from the position taken by it in this Notice. Persons whose substantial interests will be affected by any decision of the Department with regard to the application have the right to petition to become a party to the proceeding. The petition must conform to the requirements specified above and be filed (received) within 14 days of publication of this notice in the Office of General Counsel at the above address of the Department. Failure to petition within the allowed time frame constitutes a waiver of any right such person has to request a hearing under Section 120.57, F.S., and to participate as a party to this proceeding. Any subsequent intervention will only be at the approval of the presiding officer upon motion filed pursuant to Rule 28-5.207, F.A.C.

The application is available for public inspection during business hours, 8:00 a.m. to 5:00 p.m., Monday through Friday, except legal holidays, at:

Department of Environmental
Regulation
Bureau of Air Regulation
2600 Blair Stone Road
Tallahassee, Florida 32399-
2400

Department of Environmental
Regulation
Northwest District
160 Governmental Center
Pensacola, Florida 32501-5794

Any person may send written comments on the proposed action to Mr. Barry Andrews at the Department's Tallahassee address. All comments mailed within 14 days of the publication of this notice will be considered in the Department's final determination.
November 1, 1991



Florida Department of Environmental Regulation

Northwest District • 160 Governmental Center • Pensacola, Florida 32501-5794

Lawton Chiles, Governor

Carol M. Browner, Secretary

July 6, 1992

Michael H. Wheeler, P.E.
Acting Environmental Supervisor
Stone Container Corporation
Panama City Mill
Post Office Box 2560
Panama City, Florida 32402

Dear Mr. Wheeler:

This is in response to your letter dated June 30, 1992, requesting an extension of expiration for permit AC03-190964. Your permit is being processed by our Bureau of Air Regulation in Tallahassee. We have forwarded your request to that office.

If you have any questions or comments, please contact Preston Lewis at (904) 488-1344.

Sincerely,

Ed K. Middleswart, P.E.
Program Administrator
Air Resources Management

EKM:aac

cc: Clair Fancy
Preston Lewis
Bob Kriegel

Department of Environmental Regulation
Routing and Transmittal Slip

To: (Name, Office, Location) *Bruce Carzon?*

1. *Preston Jones* *handle?*

2. *BAK permitting* *Pratt*

3. *Two Towers, Room 306B* *7/14*

4.

Remarks:

*Stone Container Corp request
 for permit expiration extension*

7-15-92

9:30am

RECEIVED

JUL 07 1992

*Division of Air
 Resources Management*

*I called and left a
 message that they owe
 the Dept. a processing
 fee.*

*Shanta,
 Bru*

From: *Andy Allen, NWD Air*

Date: *7/6/92*

Phone: *SC 695-8364*



Stone Container Corporation

Panama City Mill

Containerboard and Paper Division

P.O. Box 2560
Panama City, Florida 32402

June 30, 1992

(904) 785-4311

Mr. Ed Middleswart, Air Programs Supervisor
Florida Department of Environmental Regulation
160 Governmental Center
Pensacola, Florida 32501-5794

Re: DER Permit #AC03-190964
Expiration Date: June 30, 1992

Dear Mr. Middleswart:

Pursuant to our conversation on this date, we would like to request a time extension of thirty days to meet the requirements of SPECIFIC CONDITION No. 24 of the above referenced permit. That condition requires that we submit an application for an operating permit.

The necessity of this request is based on the recent absence of L.D. Riley, Jr., our Environmental Superintendent, who has been ill.

Furthermore, we have recently completed construction of the modifications to No. 4 Bark Boiler as required by SPECIFIC CONDITION No. 6 and at this time are currently operating the facility in full accordance with all the general and specific conditions of the permit.

If you have any questions or desire any additional information please feel free to contact me at (904)785-4311, ext 359.

Sincerely yours,

Michael H. Wheeler
Michael H. Wheeler, PE
Project Engineer
(Acting Env. Supt.)

/smj

cc: Jack Prescott
Chuck Bogatie
Dave Riley

RECEIVED

JUL 1 - 1992

Northwest Florida
DER

SENDER:

- Complete items 1 and/or 2 for additional services.
- Complete items 3, and 4a & b.
- Print your name and address on the reverse of this form so that we can return this card to you.
- Attach this form to the front of the mailpiece, or on the back if space does not permit.
- Write "Return Receipt Requested" on the mailpiece below the article number.
- The Return Receipt Fee will provide you the signature of the person delivered to and the date of delivery.

I also wish to receive the following services (for an extra fee):

1. Addressee's Address
 2. Restricted Delivery
- Consult postmaster for fee.

| | |
|---|---|
| 3. Article Addressed to: <i>M. & D. Riley, Jr.</i> <i>Stone Container Corp.</i> <i>PO BOX 2560</i> <i>Panama City, FL</i> <i>32402</i> | 4a. Article Number <i>P 710 058 512</i> |
| 5. Signature (Addressee) <i>L. D. Riley</i> | 4b. Service Type <input type="checkbox"/> Registered <input type="checkbox"/> Insured <input checked="" type="checkbox"/> Certified <input type="checkbox"/> COD <input type="checkbox"/> Express Mail <input type="checkbox"/> Return Receipt for Merchandise |
| 6. Signature (Agent) <i>[Signature]</i> | 7. Date of Delivery |
| <i>7-22-92</i> | 8. Addressee's Address (Only if requested and fee is paid) |

PS Form 3811, November 1990 ☆ U.S. GPO: 1991-287-066 **DOMESTIC RETURN RECEIPT**

P 710 058 512



Certified Mail Receipt

No Insurance Coverage Provided
 Do not use for International Mail
 (See Reverse)

| | | |
|---|---------------------|------------------------|
| Sent to | | <i>L. D. Riley</i> |
| Street & No. | | <i>Stone Container</i> |
| P.O., State & ZIP Code | | <i>PC, FL</i> |
| Postage | | \$ |
| Certified Fee | | |
| Special Delivery Fee | | |
| Restricted Delivery Fee | | |
| Return Receipt Showing to Whom & Date Delivered | | |
| Return Receipt Showing to Whom, Date, & Address of Delivery | | |
| TOTAL Postage & Fees ¹ | | \$ |
| Postmark or Date | <i>AC 03-190964</i> | |
| | <i>7-20-92</i> | |

PS Form 3800, June 1990

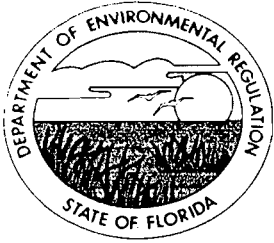

Florida Department of Environmental Regulation

Twin Towers Office Bldg. • 2600 Blair Stone Road • Tallahassee, Florida 32399-2400

Lawton Chiles, Governor

Carol M. Browner, Secretary

July 17, 1992

CERTIFIED MAIL-RETURN RECEIPT REQUESTED

Mr. L. D. Riley, Jr.
Environmental Superintendent
Stone Container Corporation
1 Everitt Avenue
Post Office Box 2560
Panama City, Florida 32402

Dear Mr. Riley:

Re: Amendment to Construction Permit-Expiration Date Extension
AC 03-190964: No. 4 Bark Boiler

The Department has reviewed the above request contained in Mr. Michael H. Wheeler's letter received July 1, 1992, by the Department's Northwest District. The request is acceptable and the following will be changed and added:

1. Expiration Date

From: June 30, 1992

To: December 31, 1992

2. Attachments to be Incorporated

o Mr. Michael H. Wheeler's letter received July 1, 1992, by the Department's Northwest District.

o Mr. Ed K. Middleswart's letter dated July 6, 1992.

A person whose substantial interests are affected by the Department's proposed permitting decision may petition for an administrative proceeding (hearing) in accordance with Section 120.57, Florida Statutes (F.S.). The petition must contain the information set forth below and must be filed (received) in the Office of General Counsel of the Department at 2600 Blair Stone Road, Tallahassee, Florida 32399-2400. Petitions filed by the amendment applicant and the parties listed below must be filed within 14 days of receipt of this intent. Petitions filed by other persons must be filed within 14 days of publication of the public notice or within 14 days of receipt of this intent, whichever first occurs. Petitioner shall mail a copy of the petition to the applicant at the address indicated above at the time of filing. Failure to file a petition within this time period shall constitute a waiver of any right such person may have to request an administrative determination (hearing) under Section 120.57, F.S.

The Petition shall contain the following information:

(a) The name, address, and telephone number of each petitioner, the applicant's name and address, the Department Permit Amendment File Number and the county in which the project is proposed;

Mr. L. D. Riley
Amendment to AC 03-190964
July 17, 1992
Page 2

(b) A statement of how and when each petitioner received notice of the Department's action or proposed action;

(c) A statement of how each petitioner's substantial interests are affected by the Department's action or proposed action;

(d) A statement of the material facts disputed by Petitioner, if any;

(e) A statement of facts which petitioner contends warrant reversal or modification of the Department's action or proposed action;

(f) A statement of which rules or statutes petitioner contends require reversal or modification of the Department's action or proposed action; and,

(g) A statement of the relief sought by petitioner, stating precisely the action petitioner wants the Department to take with respect to the Department's action or proposed action.

If a petition is filed, the administrative hearing process is designed to formulate agency action. Accordingly, the Department's final action may be different from the position taken by it in this notice. Persons whose substantial interests will be affected by any decision of the Department with regard to the request/application have the right to petition to become a party to the proceeding. The petition must conform to the requirements specified above and be filed (received) within 14 days of publication of this notice in the Office in General Counsel at the above address of the Department. Failure to petition within the allowed time frame constitutes a waiver of any right such person has to request a hearing under Section 120.57, F.S., and to participate as a party to this proceeding. Any subsequent intervention will only be at the approval of the presiding officer upon motion filed pursuant to Rule 28-5.207, Florida Administrative Code.

This letter must be attached to the construction permit, No. AC 03-190964, and shall become a part of the permit.

Sincerely,



Howard L. Rhodes, P.E.
Interim Director
Division of Air Resources
Management

HLR/RBM/rbm

Attachments

cc: M. Wheeler, P.E., SCC
P. Comer, Esq., DER

E. Middleswart, NWD
W. Congdon, Esq., DER



State of Florida
DEPARTMENT OF ENVIRONMENTAL REGULATION

| For Routing To Other Than The Addressee | |
|---|-----------------|
| To: _____ | Location: _____ |
| To: _____ | Location: _____ |
| To: _____ | Location: _____ |
| From: _____ | Date: _____ |

Interoffice Memorandum

TO: Howard L. Rhodes

FROM: *for* Clair Fancy *JRP*

DATE: July 15, 1992

SUBJ: Amendment to Construction Permit-Expiration Date Extension
Stone Container Corporation: No. 4 Bark Boiler
AC 03-190964

Attached for your approval and signature is a letter amending the above referenced construction permit extending the expiration date. There is no controversy associated with this action.

I recommend approval and signature of this amendment.

HLR/CHF/rbm

Attachment

Check Sheet

Company Name: Stone Container Corporation
Permit Number: AC 03-190964
PSD Number: _____
Permit Engineer: _____

Application:

- | | |
|---|--------------------------|
| <input checked="" type="checkbox"/> Initial Application | Cross References: |
| <input type="checkbox"/> Incompleteness Letters | <input type="checkbox"/> |
| <input type="checkbox"/> Responses | <input type="checkbox"/> |
| <input type="checkbox"/> Waiver of Department Action | <input type="checkbox"/> |
| <input type="checkbox"/> Department Response | |
| <input type="checkbox"/> Other | |

Intent:

- Intent to Issue
 - Notice of Intent to Issue
 - Technical Evaluation
 - BACT or LAER Determination
 - Unsigned Permit
- Correspondence with:
- EPA
 - Park Services
 - Other
- Proof of Publication
 - Petitions - (Related to extensions, hearings, etc.)
 - Waiver of Department Action
 - Other

Final

Determination:

- Final Determination
- Signed Permit
- BACT or LAER Determination
- Other

Post Permit Correspondence:

- Extensions/Amendments/Modifications
- Other



AC 03-190910A

Department of Environmental Protection

Lawton Chiles
Governor

Northwest District
160 Governmental Center
Pensacola, Florida 32501-5794

Virginia B. Wetherell
Secretary

DECEMBER 4, 1995

David Buff, P.E.
KBN Engineering and Applied Sciences, Inc.
Suite 500
6241 Northwest 23rd Street
Gainesville, Florida 32653-1500

RECEIVED

DEC 5 1995

BUREAU OF
AIR REGULATION

Dear Mr. Buff:

This is in response to your letter dated September 20, 1995 requesting changes to several permits issued to Stone Container. Your letter responded to issues raised by our letter dated July 11, 1995, and our subsequent teleconference.

This letter approves the requested changes as detailed below.

Woodyard Facility; AC03-148859, and AO03-190807:

You requested substitution of a visible emissions limit of 20% in lieu of projected potential PM emissions identified in specific condition 6 of permit AC03-148859, explaining that fugitive PM emissions could not be measured and compliance verified. We agree. As such, the following amendments are approved:

AC03-148859:

Specific condition 6 is deleted.

AO03-190807:

Specific condition 16 is changed to include:

- f) Visible emissions resulting from activities at the woodyard shall not be equal to or greater than 20%.

Lime Kiln, AC03-149719, AO03-174793:

You requested that the maximum process input rate be identified as 85,000 lbs/hr lime mud (dry) which is measured rather than the production rate of 36,700 lbs/ CaO/hr which is calculated based on the input rate. Additionally, you requested that the sulfur content limit of natural gas be deleted explaining that pipeline natural gas has negligible sulfur content. You also requested that

requirements concerning QA procedures and excess emissions reporting simply reference the appropriate regulations or rules. Lastly you request deletion of a specific condition concerning runoff since it is not germane to an air permit. We agree. As such, the following amendments are approved.

AC03-149719:

Specific condition 2 is changed to read:

The maximum process input rate shall not exceed 85,000 lbs/hr lime mud (dry) based on a maximum lime production of 36,700 lbs CaO/hr dry.

Specific condition 3 is changed by deleting the sentence:

The sulfur content of the natural gas shall not exceed 0.1 percent by weight.

AO03-174793:

Specific condition 15 is changed to read:

The maximum allowable operating rate is 85,000 lbs/hr lime mud (dry) input.

Specific condition 16 is changed by deleting the references to the sulfur content of the natural gas.

Specific condition 17 is changed so that the first sentence reads as follows:

Particulate emissions shall not exceed 29.83 pounds per hour at the maximum allowable operating rate of 85,000 lbs/hr lime mud (dry) input.

The first paragraph of specific condition 23 is revised to read:

A continuous TRS monitor for TRS shall be calibrated, maintained, and operated on the lime kiln in accordance with FAC Rule 62-296.404(5) and 40 CFR 60, Appendix F.

Paragraph A of specific condition 23 is revised to delete the sentence:

A reassessment of the QA Program plan shall be made and submitted to the Northwest District of the DEP within 60 days of the performance specification test.

Specific condition 24 is changed to read as follows:

- 1) The magnitude of excess emissions computed, and the date and time of commencement and completion of each period of excess emissions, in accordance with 62-296.404(6)(a)1.
- 2) The rule reference is changed to 62-296.404(6)(a)2
- 3) The rule reference is changed to 62-296.404(6)(a)3
- 4) The rule reference is changed to 62-296.404(6)(a)4
- 5) The rule reference is changed to 62-296.404(6)(b)

Specific condition 27 is deleted.

No. 1 and 2 Smelt Dissolving Tanks, AO03-222668, AO03-240550:

You requested changes in these permits for consistency between the permits, to cite the correct references, and to improve clarity. Additionally, you request deletion of a specific condition concerning runoff since it is not germane to an air permit. We agree with your suggestions. As such the following amendments are approved.

AO03-222668:

The description is changed to read:

Operation of the No. 1 Smelt Dissolving Tank at a maximum operating rate equal to the maximum allowed operating rate of the No. 1 Recovery Boiler which is 123,700 pounds Black Liquor Solids per hour. Smelt from the recovery boiler is dissolved in weak wash. Particulate emissions are controlled by demister pads made by Otto H. York Company; total reduced sulfur (TRS) emissions are controlled by weak wash sprays. The flow rate of weak wash sprays is monitored as a surrogate compliance parameter.

Specific condition 2 is changed to read as follows:

The maximum allowable operating rate is 123,700 lbs/hr Black Liquor Solids fed to Recovery Boiler No. 1. This is the operating rate at which compliance with standards shall be demonstrated. Testing of emissions shall be conducted with the source operating at capacity. Capacity is defined as 90 to 100% of rated capacity. If it is impracticable to test at capacity, then sources may be tested at less than capacity; if the source is tested at less than capacity subsequent source operation is limited to 110% of the test load until a new test is conducted. Once the unit is so limited, then operation at higher capacity is allowed for no more than fifteen days for purposes of additional compliance testing to regain the rated capacity in the permit with prior notification to the Department.

Specific condition 4 is changed as follows:

FAC Rule reference 17-296.710(2) is changed to 62-296.310(1)
FAC Rule reference 17-296.404(d)(1) is changed to 62-296.404(3)(d)(1)
The two columns labeled "Estimated Emissions" are deleted

Specific condition 10 is deleted.

AO03-240550

The second sentence of the description is changed to read as follows:

Smelt from the recovery boiler is dissolved in weak wash to produce green liquor.

Specific condition 6 is changed by adding:

Weak wash spray flow rate shall be recorded at least once per shift.

No. 1 and 2 Recovery Boilers, AO03-222669, AO03-240555:

You requested changes in these permits for consistency between the permits, and to cite the correct references. You also requested that requirements concerning QA procedures and excess emissions reporting simply reference the appropriate regulations or rules. We agree. As such, the following amendments are approved.

AO03-222669:

Specific condition 4 is changed as follows:

The two columns labeled "Estimated Emissions" are deleted.

Under allowable emissions, TRS delete all and replace with footnote 2 to read as follows:

2. 17.5 ppm by volume, dry basis at standard conditions, at 8% O₂, 12 hour average.

Specific condition 7 is changed as follows:

The first sentence is revised to read:

A continuous TRS monitor for TRS shall be calibrated, maintained and operated on the recovery boiler in accordance with FAC Rule 62-296.404(5) and 40 CFR 60, Appendix F.

The second sentence is deleted.

A. Delete the sentence: A reassessment of the QA Program plan shall be made and submitted to the Northwest District of the DEP within 60 days of the performance specification test.

Specific condition 8 is changed to read as follows:

- A) The magnitude of excess emissions computed, and the date and time of commencement and completion of each period of excess emissions, in accordance with 62-296.404(6)(a)1.
- B) The rule reference is changed to 62-296.404(6)(a)2
- C) The rule reference is changed to 62-296.404(6)(a)3
- D) The rule reference is changed to 62-296.404(6)(a)4
- E) The rule reference is changed to 62-296.404(6)(b)

AO03-240555

The general description is changed to read as follows:

Operation of Recovery Boiler No. 2, fueled by 123,700 pounds of black liquor solids (BLS) per hour. No. 6 fuel oil and/or natural gas is used as auxiliary fuel. The maximum sulfur content of the fuel oil is 2.5%. Particulates (PM) are controlled by an electrostatic precipitator manufactured by Koppers, two sections of four fields each. Total reduced sulfur (TRS) emissions are controlled by oxidation of the black liquor prior to entering the boiler fire box.

Specific condition 6 is changed as follows:

The first sentence is revised to read as follows:

The continuous monitor (CEM) for TRS shall be calibrated, maintained and operated in accordance with FAC Rule 62-296.404(5) and 40 CFR 60, Appendix F.

The following sentence is deleted from paragraph A:

A reassessment of the AQ Program plan shall be made and submitted to the Northwest District of the DEP within 60 days of the performance specification test.

The language "and surrogate parameter" is deleted from specific condition 9.

No. 3 & 4 Bark Boilers; AO03-252353, AC03-190964, AO03-223447

You requested changes to these permits adding emissions limits identified by rule, providing consistency between permits, and eliminating unnecessary notifications.

AO03-252353

Add to the column "Allowable Emissions" in Specific condition 6 for PM, after natural gas, "and fossil fuels"

AC03-190964

Add to the list of fuels in specific condition 4:

Primary clarified wood waste; 10 TPD; 0 Btu/hr

Delete the following language from specific condition 19:

The Department's Northwest District office shall be notified in writing when the boiler is switched to incinerating TRS gases and/or operating at 100% fossil fuel..

AO03-223447

Change the fourth sentence in the general description to read as follows:

Sulfur dioxide emissions when incinerating TRS gases or when burning 100 percent fuel oil are controlled by maintaining a minimum pH of 8.0 in the wet scrubber.

If you have any questions or comments, please contact Bob Kriegel of this office at (904) 444-8364.

Sincerely,

A handwritten signature in cursive script that reads "Ed K. Middleswart". The signature is written in black ink and includes a stylized star-like flourish at the end.

Ed K. Middleswart, P.E.
Program Administrator
Air Resources Management

EKM:bkc

cc: David Riley, Stone Container Corporation
A. A. Linero, DEP Division of Air Resources Management, Tallahassee
Jenny Arias, DEP Northwest District Branch Office, Panama City