



# Florida Department of Environmental Protection

Bob Martinez Center  
2600 Blair Stone Road  
Tallahassee, Florida 32399-2400

Charlie Crist  
Governor

Jeff Kottkamp  
Lt. Governor

Michael W. Sole  
Secretary

December 24, 2008

Mr. Joseph L. Staley  
Operations Manager  
Steven Counts, Incorporated  
CP 427 Mayo Correctional Facility  
8784 U.S. Highway 27 West  
Mayo, Florida 32066

Dear Mr. Staley:

This is to acknowledge that your notification of intent to use the authority of Rule 62-210.310 to operate your facility was received on November 21, 2008. We have assigned ARMS No. 7775553-001 to this facility.

As you know, pursuant to Florida Statutes section 403.814, authority to operate under general permits commences thirty (30) days after receipt of the registration form unless you have been notified by this office that your facility has not shown entitlement to operate pursuant to the rule provisions.

For your information, authority to operate pursuant to Rule 62-210.310 expires after five (5) years. Therefore, a new registration form must be received no later than five (5) years after the date your notice was received as indicated above. If your general permit rule conditions require testing, such testing must be completed within the time frame specified in the rule.

If you have any additional questions, please contact Dickson Dibble at 850/921-9586.

Sincerely,

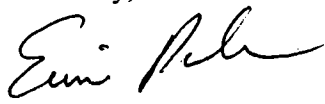
  
for Sandra F. Veazey, Chief  
Bureau of Air Monitoring  
and Mobile Sources

SFV/pg

RECEIVED

NOV 21 2008

CONCRETE BATCHING PLANT  
AIR GENERAL PERMIT REGISTRATION FORM

Bureau of Air Monitoring  
& Mobile Sources

Part II. Notification to Permitting Office

(Detach and submit to appropriate permitting office; keep copy onsite)

**Instructions:** To give notice to the Department of an eligible facility's intent to use this air general permit, the owner or operator of the facility must detach and complete this part of the Air General Permit Registration Form and submit it to the appropriate Department of Environmental Protection or local air pollution control program office which has permitting authority. Please type or print clearly all information, and enclose the appropriate air general permit registration processing fee pursuant to Rule 62-4.050, F.A.C. (\$100 as of the effective date of this form)

7775553-001

Bureau of Air Monitoring  
& Mobile Sources  
NOV 26 2008

RECEIVED

Registration Type

Check one:

**INITIAL REGISTRATION** - Notification of intent to:

- Construct and operate a proposed new facility.
- Operate an existing facility not currently using an air general permit (e.g., a facility proposing to go from an air operation permit to an air general permit).

**RE-REGISTRATION** (for facilities currently using an air general permit) - Notification of intent to:

- Continue operating the facility after expiration of the current term of air general permit use.
- Continue operating the facility after a change of ownership.
- Make an equipment change requiring re-registration pursuant to Rule 62-210.310(2)(e), F.A.C., or any other change not considered an administrative correction under Rule 62-210.310(2)(d), F.A.C.

Surrender of Existing Air Operation Permit(s) - For Initial Registrations Only

If the facility currently holds one or more air operation permits, such permit(s) must be surrendered by the owner or operator upon the effective date of this air general permit. In such case, check the first box, and indicate the operation permits being surrendered. If no air operation permits are held by the facility, check the second box.

- All existing air operation permits for this facility are hereby surrendered upon the effective date of this air general permit; specifically permit number(s):
- No air operation permits currently exist for this facility.

General Facility Information

Facility Owner/Company Name (Name of corporation, agency, or individual owner who or which owns, leases, operates, controls, or supervises the facility.)

Steven Counts Incorporated

Site Name (Name, if any, of the facility site; e.g., Plant A, Metropolis Plant, etc. If more than one facility is owned, a registration form must be completed for each.)

CP 427 Mayo Correctional Facility

Facility Location (Provide the physical location of the facility, not necessarily the mailing address.)

Street Address: 8784 US Highway 27 West

City: Mayo

County: Lafayette

Zip Code: 32066

Facility Start-Up Date (Estimated start-up date of proposed new facility.) (N/A for existing facility)

12/1/2009

**Owner/Authorized Representative**

Name and Position Title (Person who, by signing this form below, certifies that the facility is eligible to use this air general permit.)

Print Name and Title: Joseph L. Staley - Operations Manager

Owner/Authorized Representative Mailing Address

Organization/Firm: Steven Counts, Inc.

Street Address: NW 27th Avenue Rd

City: Ocala

County: FL

Zip Code: 34475

VERIFIED BY PHONE 12/3/08  
6760 NW 27th Avenue Rd W.C.D.

Owner/Authorized Representative Telephone Numbers

Telephone: (352) 369-8884

Fax: (352) 369-8882

Cell phone (optional): (352) 427-9173

**Facility Contact (If different from Owner/Authorized Representative)**

Name and Position Title (Plant manager or person to be contacted regarding day-to-day operations at the facility.)

Print Name and Title: Same as Authorized Agent

Facility Contact Mailing Address

Organization/Firm:

Street Address:

City:

County:

Zip Code:

Facility Contact Telephone Numbers

Telephone:

Fax:

Cell phone (optional):

**Owner/Authorized Representative Statement**

This statement must be signed and dated by the person named above as owner or authorized representative

*I, the undersigned, am the owner or authorized representative of the owner or operator of the facility addressed in this Air General Permit Registration Form. I hereby certify, based on information and belief formed after reasonable inquiry, that the facility addressed in this registration form is eligible for use of this air general permit and that the statements made in this registration form are true, accurate and complete. Further, I agree to operate and maintain the facility described in this registration form so as to comply with all applicable standards for control of air pollutant emissions found in the statutes of the State of Florida and rules of the Department of Environmental Protection and revisions thereof.*

*I will promptly notify the Department of any changes to the information contained in this registration form.*

Signature

Joseph L. Staley

Date

11/20/08

2008 NOV 24 AM 9:22  
RECEIVED  
DEPARTMENT OF ENVIRONMENTAL PROTECTION

**Type of Facility**

Check one:

Stationary Facility

Relocatable Facility

**Type(s) of Reasonable Precautions Used to Prevent Unconfined Emissions**

Check all precautions to be used for the management of roads, parking areas, stock piles and yards:

Pave Roads

Pave Parking Areas

Pave Yards

Maintain Roads/Parking/Yards

Use Water Application

Use Dust Suppressant

Remove Particulate Matter

Reduce Stock Pile Height

Install Wind Breaks

Check all precautions to be used for the management of drop points to trucks:

Spray Bar

Chute

Enclosure

Partial enclosure

**Description of Reasonable Precautions**

Below, or as an attachment to this form, provide details of all types of reasonable precautions to be used to prevent unconfined emissions at the facility. Water aggregate piles, dust suppressant as necessary, and water spray truck to control dust.

2008 NOV 24 AM 9:22  
REVENUE

NOV 24 2008

**Description of Facility**

Below, or as an attachment to this form, provide a description of the concrete batching plant operations at the facility in sufficient detail to demonstrate the facility's eligibility for use of this air general permit and to provide a basis for tracking any future equipment or process changes at the facility. Describe all air pollutant-emitting processes and equipment at the facility, and identify any air pollution control measures or equipment used.

Please see attached Site Plan and specifications.

Cement/flyash will be blown into silo by a pneumatic tanker truck. The dust collection system on the plant has suction ports to collect the dust and out into flyash silo for reuse. The cement and flyash will be augered into a weigh scale and then deposited into an horizontal shaft mixer then discharged into a dump truck or agitating truck for delivery. Aggrgate bins will be erected using concrete bin blocks as wind barriers and containment. Coarse aggregate will be sprinled with water to reduce dusting and achieve optimum moisture for concrete production. A water truck will be utilized to keep dust down at plant facility.

2008 NOV 24 AM 9:22  
DEP  
RECEIVED

DEPARTMENT OF ENVIRONMENTAL CONSERVATION

#4 13 SLB 2317  
AUDIT #



TRANSACTION ID#

L# 176508  
T# 528251747  
B# 121666

STATE OF FLORIDA  
APPLICATION FOR VEHICLE/VESSEL  
CERTIFICATE OF TITLE

TITLE NUMBER	VEHICLE/VESSEL IDENTIFICATION #	YR. MAKE	MAKE or MANUFACTURER	BODY TYPE	VEHICLE COLOR	WT/LENGTH	GVW/LOC	
100117542	990729	1999	VINC 7	TL		77000		
DATE OF ISSUE MO. DAY YEAR	TRANS CODE	VEHICLE USE	HULL MATERIAL	PROPULSION	FUEL	VESSEL TYPE	WATER	FL NUMBER
02 06 08	OUT	PRIVATE						

Applicant/Owner's Name & Address  
STEVE COUNTS INC  
3601 SW 38TH AVE  
OCALA, FL 34474

BIRTHDATE SEX MO. DAY YEAR	RESIDENT Y N ALIEN	CITY RES.#
	X	14

1st OWNER FL/DL# OR F.E.I.D.#	2nd OWNER FL/DL# OR UNIT #

VOLUNTARY CONTRIBUTIONS

\_\_\_\_\_

AGENCY FEE	TITLE FEE	SALES TAX	GRAND TOTAL
4.75	29.00	0.00	33.75

Action Requested: ORIG USED TITLE

Brands:

PREV. STATE	DATE ACQUIRED	NEW	USED	ODOMETER / VESSEL MANUFACTURER	ODOMETER DECLARATION CERTIFICATION
TX	09/17/2007		XX		<input type="checkbox"/>

LIEN INFORMATION      DATE OF LIEN      RECEIVED DATE      FEID # OR FL / DL AND SEX AND DATE OF BIRTH      DMV ACCOUNT #

NAME OF FIRST LIENHOLDER:

ADDRESS

SALVAGE TYPE

SELLER INFORMATION

NAME OF SELLER, FLORIDA DEALER, OR OTHER PREVIOUS OWNER

ADDRESS

DEALER LICENSE NO

CONSUMER OR SALES TAX EXEMPTION #

SALES TAX AND USE REPORT

TRANSFER OF TITLE  PURCHASER HOLDS VALID  
IS EXEMPT FROM EXEMPTION CERTIFICATE  
FLORIDA SALES OR  VEHICLE / VESSEL WILL BE  
USE TAX FOR THE USED EXCLUSIVELY FOR RENTAL  
REASON(S) CHECKED  OTHER OTHER

INDICATE TOTAL PURCHASE PRICE, INCLUDING ANY UNPAID BALANCE DUE SELLER, BANK OR OTHERS \$ \_\_\_\_\_  
INDICATE SALES OR USE TAX DUE AS PROVIDED BY CHAPTER 212, FLORIDA STATUTES \$ 0.00

SELLING PRICE VERIFIED

APPLICANT CERTIFICATION

I/WE HEREBY CERTIFY THAT THE VEHICLE/VESSEL TO BE TITLED WILL NOT BE OPERATED UPON THE PUBLIC HIGHWAYS/WATERWAYS OF THIS STATE.  
I CERTIFY THAT THE CERTIFICATE OF TITLE IS LOST OR DESTROYED.  
I CERTIFY THAT THIS MOTOR VEHICLE/VESSEL WAS REPOSSESSED UPON DEFAULT OF THE LIEN INSTRUMENT AND IS NOW IN MY POSSESSION.

I/WE HEREBY CERTIFY THAT I/WE LAWFULLY OWN THE ABOVE DESCRIBED VEHICLE/VESSEL, AND MAKE APPLICATION FOR TITLE. IF LIEN IS BEING RECORDED NOTICE IS HEREBY GIVEN THAT THERE IS AN EXISTING WRITTEN LIEN INSTRUMENT INVOLVING THE VEHICLE/VESSEL DESCRIBED ABOVE AND HELD BY LIENHOLDER SHOWN ABOVE. I/WE FURTHER AGREE TO DEFEND THE TITLE AGAINST ALL CLAIMS.

UNDER PENALTIES OF PERJURY, I DECLARE THAT I HAVE READ THE FOREGOING DOCUMENT AND THAT THE FACTS STATED IN IT ARE TRUE.

Signature of Applicant/Owner

Signature of Applicant/Co-Owner

HSMV 82041 REVISED 02/06

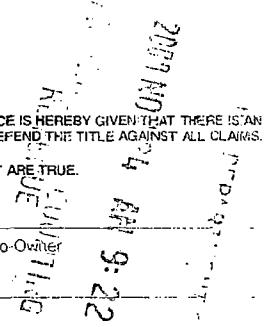

MIXER



L# 176473  
T# 528235044  
B# 121645

### STATE OF FLORIDA APPLICATION FOR VEHICLE/VESSEL CERTIFICATE OF TITLE

TITLE NUMBER	VEHICLE/VESSEL IDENTIFICATION #	YR. MAKE	MAKE or MANUFACTURER	BODY TYPE	VEHICLE COLOR	WT/LENGTH	GVM/LOC	
100116288	99115E	1999	VINC	TL		20000		
DATE OF ISSUE MO. DAY YEAR	TRANS CODE	VEHICLE USE	HULL MATERIAL	PROPULSION	FUEL	VESSEL TYPE	WATER	FL NUMBER
02 06 08	OUT	PRIVATE						

Applicant/Owner's Name & Address  
STEVEN COUNTS INC  
3601 SW 38TH AVENUE  
OCALA, FL 34474

BIRTHDATE	RESIDENT	CNTY
SEX MO. DAY YEAR	Y N ALIEN	RES.#
	X	14

1st OWNER FL/DL# OR F.E.I.D.#      2nd OWNER FL/DL# OR UNIT #

593645153-01

VOLUNTARY CONTRIBUTIONS

AGENCY FEE	TITLE FEE	SALES TAX	GRAND TOTAL
4.75	39.00	22825.00	22868.75

Action Requested: ORIG USED TITLE

Brands:

PREV STATE	DATE ACQUIRED	NEW	USED	ODOMETER / VESSEL MANUFACTURER	ODOMETER DECLARATION CERTIFICATION
SD	09/17/2007		XX		<input type="checkbox"/>

LIEN INFORMATION      DATE OF LIEN      RECEIVED DATE      FEID # OR FL / DL AND SEX AND DATE OF BIRTH      DMV ACCOUNT #

NAME OF FIRST LIENHOLDER:

ADDRESS

SALVAGE TYPE

SELLER INFORMATION

NAME OF SELLER, FLORIDA DEALER, OR OTHER PREVIOUS OWNER

ADDRESS

DEALER LICENSE NO.

CONSUMER OR SALES TAX EXEMPTION #

SALES TAX AND USE REPORT

TRANSFER OF TITLE  PURCHASER HOLDS VALID EXEMPTION CERTIFICATE  
 IS EXEMPT FROM FLORIDA SALES OR USE TAX FOR THE REASON(S) CHECKED  VEHICLE / VESSEL WILL BE USED EXCLUSIVELY FOR RENTAL  
 OTHER

INDICATE TOTAL PURCHASE PRICE, INCLUDING ANY UNPAID BALANCE DUE SELLER, BANK OR OTHERS \$ 380,000.00

INDICATE SALES OR USE TAX DUE AS PROVIDED BY CHAPTER 212, FLORIDA STATUTES \$ 22,825.00

SELLING PRICE VERIFIED

APPLICANT CERTIFICATION

I/WE HEREBY CERTIFY THAT THE VEHICLE/VESSEL TO BE TITLED WILL NOT BE OPERATED UPON THE PUBLIC HIGHWAYS/WATERWAYS OF THIS STATE.  
 I CERTIFY THAT THE CERTIFICATE OF TITLE IS LOST OR DESTROYED.  
 I CERTIFY THAT THIS MOTOR VEHICLE/VESSEL WAS REPOSSESSED UPON DEFAULT OF THE LIEN INSTRUMENT AND IS NOW IN MY POSSESSION.  
 I/WE HEREBY CERTIFY THAT I/WE LAWFULLY OWN THE ABOVE DESCRIBED VEHICLE/VESSEL, AND MAKE APPLICATION FOR TITLE. IF LIEN IS BEING RECORDED NOTICE IS HEREBY GIVEN THAT THERE IS AN EXISTING WRITTEN LIEN INSTRUMENT INVOLVING THE VEHICLE/VESSEL DESCRIBED ABOVE AND HELD BY LIENHOLDER SHOWN ABOVE. I/WE FURTHER AGREE TO DEFEND THE TITLE AGAINST ALL CLAIMS.

UNDER PENALTIES OF PERJURY, I DECLARE THAT I HAVE READ THE FOREGOING DOCUMENT AND THAT THE FACTS STATED IN IT ARE TRUE.

Signature of Applicant/Owner

Signature of Applicant/Co-Owner

~~MAINTENANCE~~  
Auxiliary/510



STATE OF FLORIDA  
APPLICATION FOR VEHICLE/VESSEL  
CERTIFICATE OF TITLE

TRANSACTION CODE

L# 176502  
T# 528248676  
B# 121663

TITLE NUMBER	VEHICLE/VESSEL IDENTIFICATION #	YR. MAKE	MAKE or MANUFACTURER	BODY TYPE	VEHICLE COLOR	WT/LENGTH	GVW/LOC	
100117293	99L115A 10	1999	VINC	TL		68000		
DATE OF ISSUE MO. DAY YEAR	TRANS CODE	VEHICLE USE	HULL MATERIAL	PROPULSION	FUEL	VESSEL TYPE	WATER	FL NUMBER
02 06 08	GUT	PRIVATE						

Applicant/Owner's Name & Address  
STEVEN COUNTS INC  
3601 SW 38TH AVENUE  
OCALA, FL 34474

BIRTHDATE  
SEX MO. DAY YEAR Y # ALIEN RESA

1st OWNER FL/DL# OR F.E.I.D.#  
2nd OWNER FL/DL# OR UNIT #

593645153-01

VOLUNTARY CONTRIBUTIONS

AGENCY FEE	TITLE FEE	SALES TAX	GRAND TOTAL
4.75	39.00	0.00	43.75

Action Requested: ORIG USED TITLE

Brands:

PREV. STATE SP	DATE ACQUIRED 09/17/2007	NEW	USED XX	ODOMETER / VESSEL MANUFACTURER	<input type="checkbox"/> ODOMETER DECLARATION CERTIFICATION
-------------------	-----------------------------	-----	------------	--------------------------------	---

LIEN INFORMATION

NAME OF FIRST LIENHOLDER:

ADDRESS

SALVAGE TYPE

SELLER INFORMATION

NAME OF SELLER, FLORIDA DEALER, OR OTHER PREVIOUS OWNER

ADDRESS

DEALER LICENSE NO.

CONSUMER OR SALES TAX EXEMPTION #

SALES TAX AND USE REPORT

TRANSFER OF TITLE  PURCHASER HOLDS VALID  
 IS EXEMPT FROM EXEMPTION CERTIFICATE  
 FLORIDA SALES OR  VEHICLE / VESSEL WILL BE  
 USE TAX FOR THE USED EXCLUSIVELY FOR RENTAL  
 REASON(S) CHECKED  OTHER OTHER

INDICATE TOTAL PURCHASE PRICE, INCLUDING ANY UNPAID BALANCE DUE SELLER, BANK OR OTHERS \$  
 INDICATE SALES OR USE TAX DUE AS PROVIDED BY CHAPTER 212, FLORIDA STATUTES \$  
 SELLING PRICE VERIFIED

APPLICANT CERTIFICATION

I/WE HEREBY CERTIFY THAT THE VEHICLE/VESSEL TO BE TITLED WILL NOT BE OPERATED UPON THE PUBLIC HIGHWAYS/WATERWAYS OF THIS STATE.  
 I CERTIFY THAT THE CERTIFICATE OF TITLE IS LOST OR DESTROYED.  
 I CERTIFY THAT THIS MOTOR VEHICLE/VESSEL WAS REPOSSESSED UPON DEFAULT OF THE LIEN INSTRUMENT AND IS NOW IN MY POSSESSION.  
 I/WE HEREBY CERTIFY THAT I/WE LAWFULLY OWN THE ABOVE DESCRIBED VEHICLE/VESSEL, AND MAKE APPLICATION FOR TITLE. IF LIEN IS BEING RECORDED NOTICE IS HEREBY GIVEN THAT THERE IS AN EXISTING WRITTEN LIEN INSTRUMENT INVOLVING THE VEHICLE/VESSEL DESCRIBED ABOVE AND HELD BY LIENHOLDER SHOWN ABOVE. I/WE FURTHER AGREE TO DEFEND THE TITLE AGAINST ALL CLAIMS.  
 UNDER PENALTIES OF PERJURY, I DECLARE THAT I HAVE READ THE FOREGOING DOCUMENT AND THAT THE FACTS STATED IN IT ARE TRUE.

Signature of Applicant/Owner

Signature of Applicant/Co-Owner

MAIN PART



# THE VINCE HAGAN co.

Designers, Engineers & Manufacturers of Concrete Batching Plants and Material Handling Equipment

Continuing to build better products

## MODEL 1083-JP INTRUSS BAGHOUSE

### SPECIFICATIONS

CLOTH FILTERING AREA.....	1083 FT <sup>2</sup>
NUMBER OF BAGS.....	99
BAG DIAMETER .....	6"
BAG LENGTH.....	84"
CLOTH TYPE .....	POLYESTER FELT
CLOTH WEAVE.....	POLYESTER .065" (NOM.)
CONSTRUCTION.....	NEEDLE PUNCHED, SCRIM SUPPORTED
PERMEABILITY .....	25 TO 35 CFM/SQ. FT. CLOTH AREA AT .5" GAUGE RESISTANCE
AIR VOLUME INTAKE (20" BLOWER).....	6500 CFM
EXHAUST OPENING SIZE.....	19 7/16" x 17 3/8"
EFFICIENCY .....	99%+ AT 1 MICRON
MANUFACTURER .....	THE VINCE HAGAN COMPANY
BAG WEIGHT .....	16± 1 OZ./SQ. YD.
MULLEN BURST.....	400 PSI MIN.
FINISH.....	PLAIN, SINGED, ACRYLIC COATED, TEFLON COATED & MEMBRANE
TEMPERATURE .....	275°F CONTINUOUS TO 300°F SURGE
MOTOR.....	15 HP @ 3450 RPM 254T
FAN SPEED.....	2150 RPM (NOM.)



MEMBER OF:  
NATIONAL READY MIXED  
CONCRETE ASSOCIATION



# CONSIDER THE HAGAN CEMENT RECYCLE SYSTEM

**RECLAIM THE CEMENT ACCUMULATED IN YOUR DUST COLLECTOR!**

**An Investment that:**

- Pays For Itself
- Generates Profit
- Keeps the Environment Clean
- Eliminates Clean Up Costs

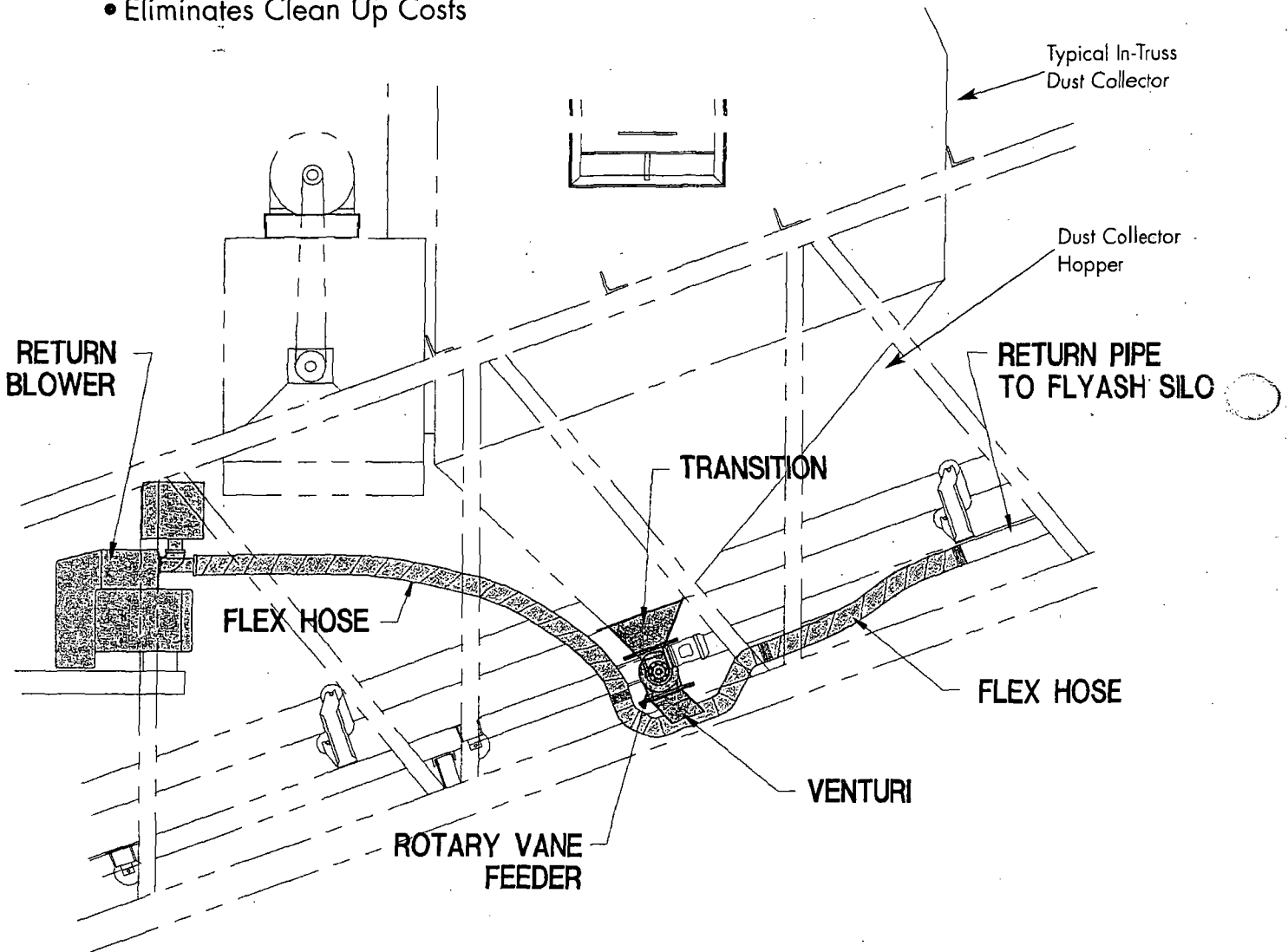

**FREE STANDING DUST COLLECTOR**

Transition Mounting Flange	1
Rotary Vane Feeder	1
Venturi	1
Blower	1
Flex Hose	Var.
Return Pipe	Var.

**IN-TRUSS DUST COLLECTOR SYSTEM**

Transition Mounting Flange	2
Rotary Vane Feeder	2
Venturi	2
Blower	2
Flex Hose	Var.
Return Pipe	Var.

# DUST COLLECTOR COMPONENTS

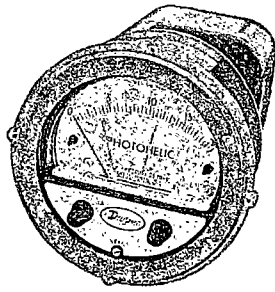

Photohelic - Jet Pulse Control Gauge  
08-1543

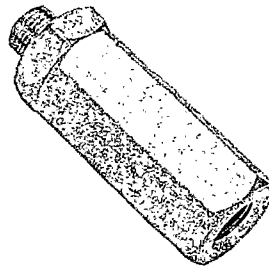

Filter 08-1544

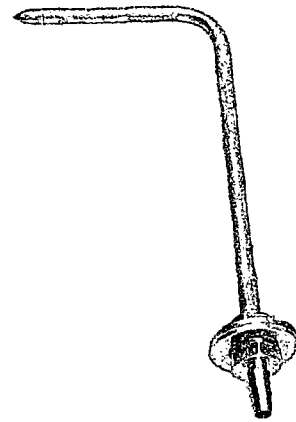

Static Tip 08-1545

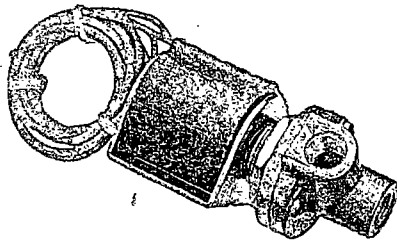

1/8" Solenoid  
08-1531 - Discontinued  
08-4661 (New)

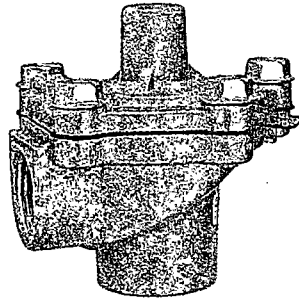

3/4" Diaphragm Valve  
08-1530 - Discontinued  
08-4659 (New)  
08-4660 Repair Kit (New)  
08-2085 Repair Kit for 08-1530



Magnehelic Pressure Differential Gauge  
08-1542

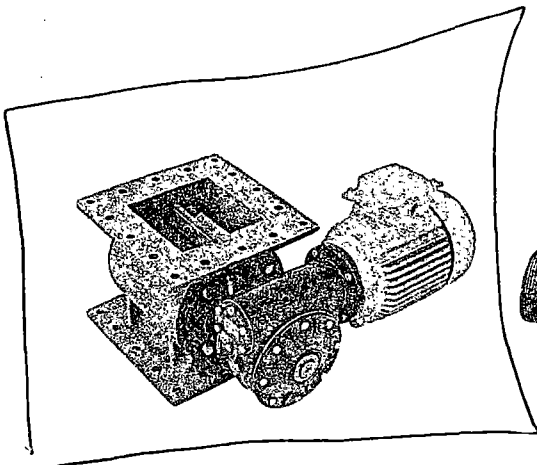

Rotary Vane Feeder 08-1535  
Blade Tips 08-0218  
Motor 30-0218 (Metric)  
Motor 30-0219 (Std)

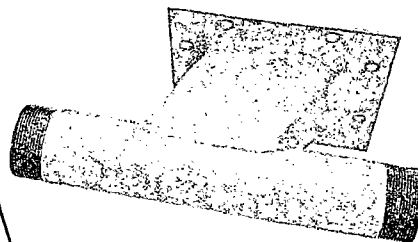

Feeder Venturi  
D1094P07-VEN

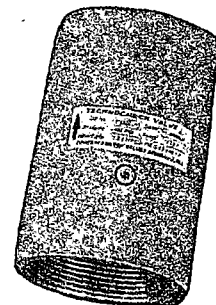

3" Check Valve  
08-4425

## ASSEMBLY DIAGRAM DRX RAIL MOUNT BLOWERS

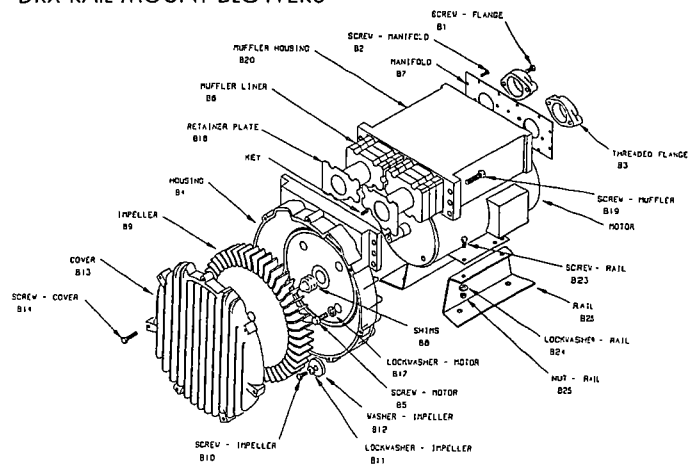
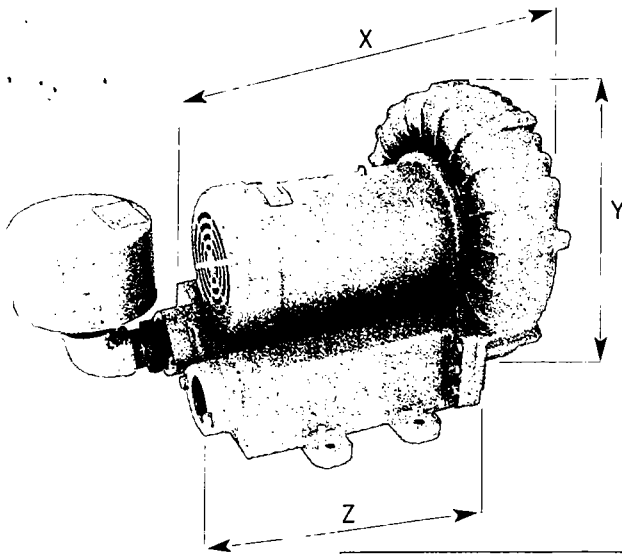

	2 H.P.	5 H.P.	10 H.P.
Blower No.	03-1413	03-1412	03-1425
Z	10.93	17.44	21.80
X	14.70	18.17	24.10
Y	13.53	16.00	18.60
Motor No.	30-4684	30-2787	30-2614
Impeller	03-3750	03-3752	03-3754
Filter	03-1417	03-1418	03-1810
Muffler	03-3751	03-3753	03-3755
Relief Valve	03-1415	03-1415	03-1415
Retainer		08-4341	08-4341

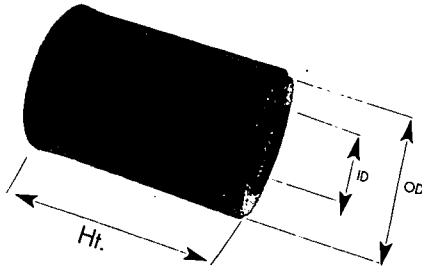

FILTER PT. NO.	I. D.	O. D.	HT.
03-1417 (2 HP)	3.00	4-3/8	4-3/4
03-1418 (5 HP)	3-5/8	5-7/8	4-3/4
03-1810 (10 HP)	3-5/8	5-7/8	9-1/2

## AERATION COMPONENTS

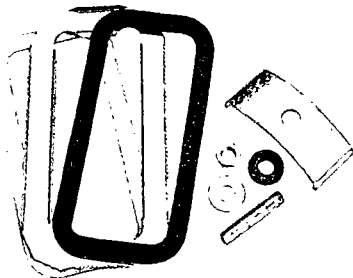

Aeration Mounting Kit 03-1362

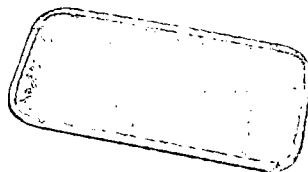

Aeration Pad 03-1361



Aeration Nozzle  
03-1363

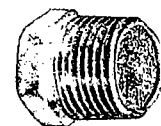

Aeration Nozzle  
03-2266 (3/8")  
03-3999 (3/4")

PHONE: 1-800-354-3238

FAX: 214-331-9177

# DUST COLLECTOR FILTER BAGS



BASIC SIZE	PART NUMBER
4" x 38.5"	08-2091
4" x 42"	08-3771
4" x 79"	08-2615
4" x 84"	08-2725
5" x 48"	08-3772
6" x 42"	FB-642 D-GR
* 6" x 84" *	08-1524 *
6.5" x 64"	08-1996
7" x 72"	08-2057
8" x 48"	08-2754
8" x 60"	08-2779
8" x 65"	08-2383
8" x 69"	08-1525
8" x 72"	08-2087
8" x 77"	08-1526
8" x 115"	FB-115 D
8" x 115"	08-1527

CUSTOM FILTERS AVAILABLE

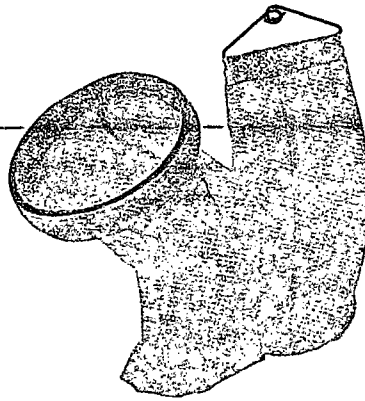

SUPER SEAL

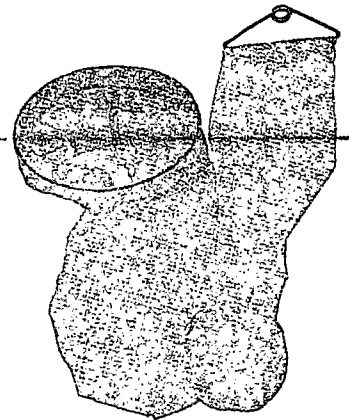

SNAP BAND

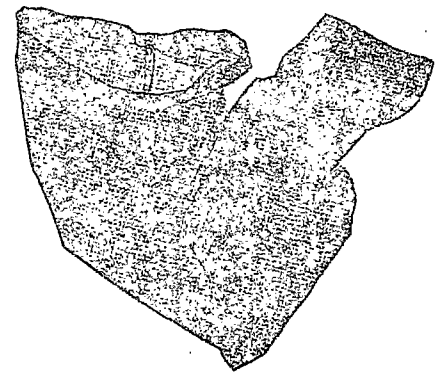

LOOP

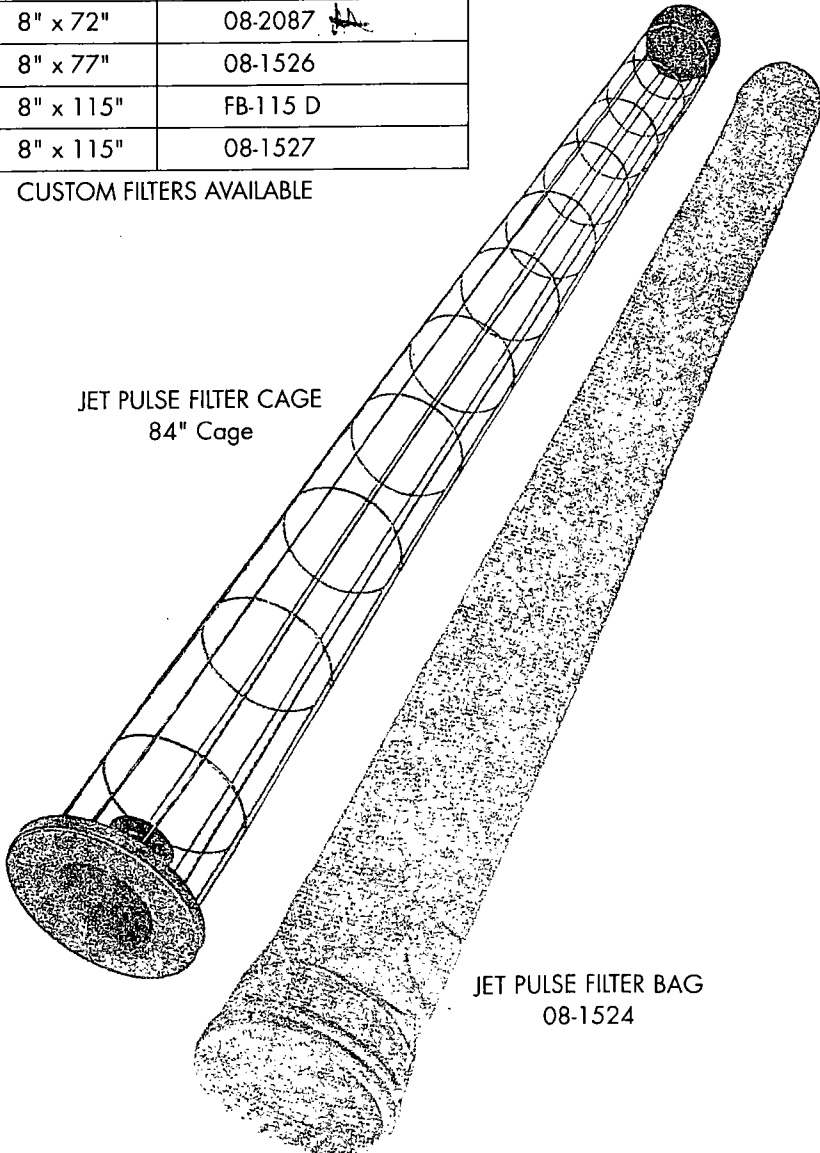

JET PULSE FILTER CAGE  
84" Cage

JET PULSE FILTER BAG  
08-1524

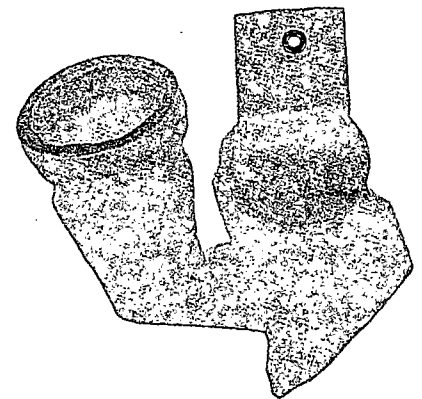

SUPER SEAL GROMMET TOP

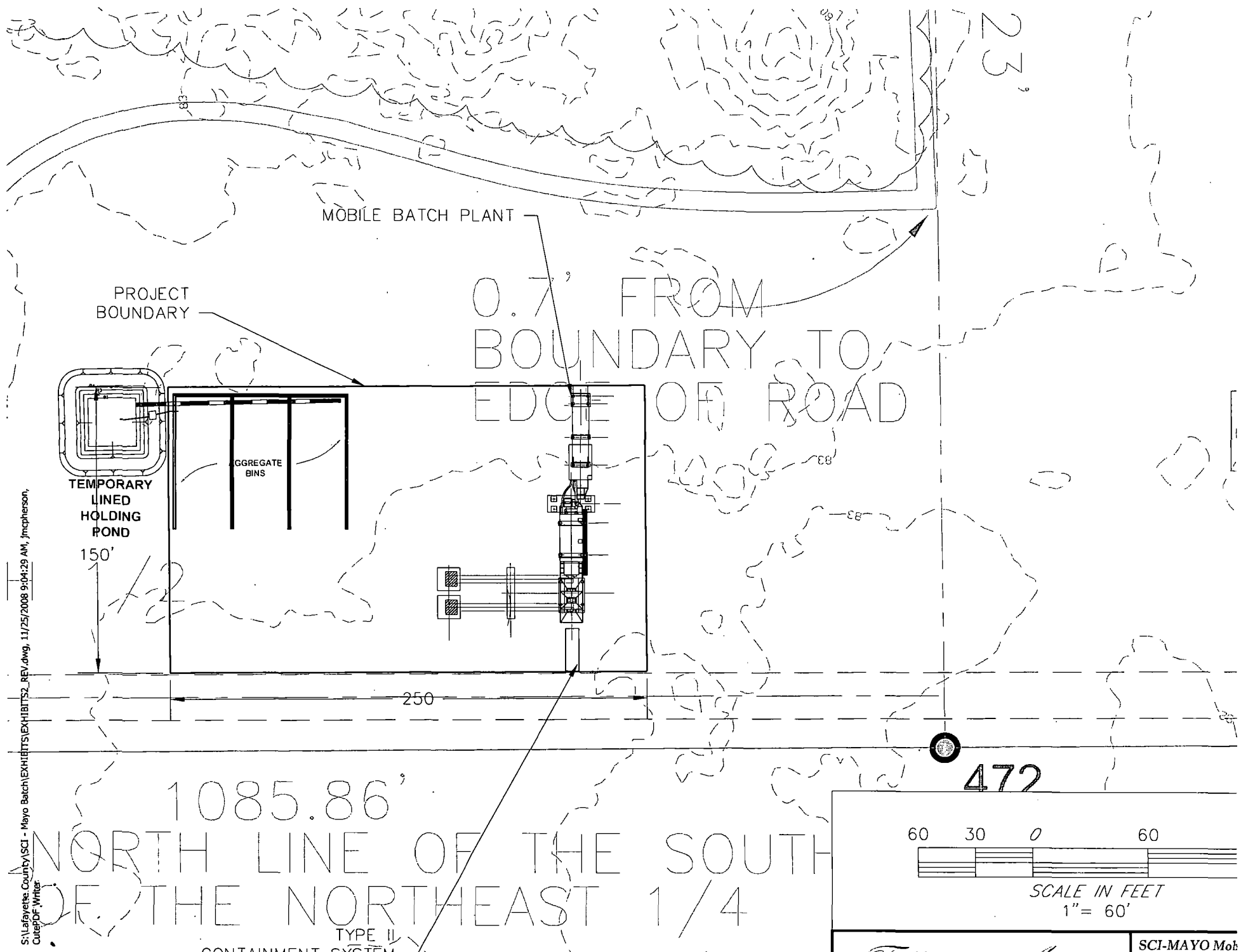

S:\Lafayette County\SCI - Mayo Batch\EXHIBITS\EXHIBITS2\_REV.dwg, 11/25/2008 9:04:29 AM, jmcpherson, CUE/DF/White

TYPE II  
 CONTAINMENT SYSTEM

60 30 0 60  
  
 SCALE IN FEET  
 1" = 60'  
 SCI-MAYO Mob

**Dibble, Dickson**

---

**From:** Jeff McPherson [JMcPherson@tillmaneng.com]  
**Sent:** Tuesday, November 25, 2008 9:19 AM  
**To:** Dibble, Dickson  
**Cc:** Joey Staley  
**Subject:** SCI Mobile Batch Plant - Mayo - FDEP Air Permit  
**Attachments:** SCI MB-MAYO 8.5x11.pdf

Mr. Dibble,

Per your conversation with Joey Staley with SCI on 11/21, attached is an 8 ½ x 11 PDF of the proposed site plan. If there is anything else you need, just let me know. Thanks

**Jeff McPherson, E.I.**

Staff Engineer

*Tillman & Associates Engineering*

Civil Engineering - Planning - Landscape Architecture - Environmental

1720 SE 16th Ave; Bldg 100

Ocala FL 34471

352.307.1947 o

352.307.2420 f

352.458.1176 m

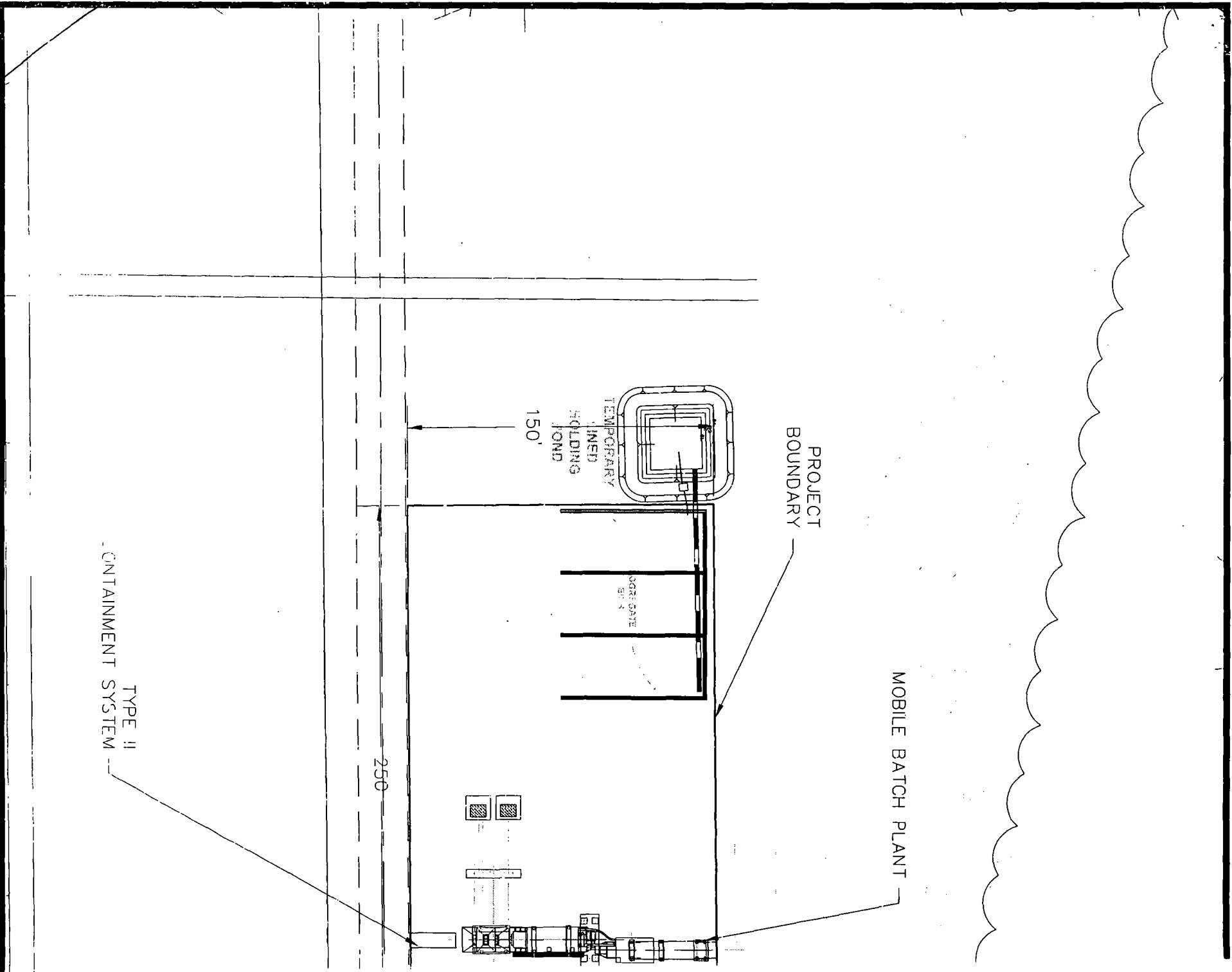



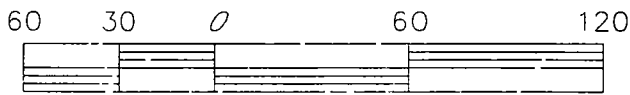
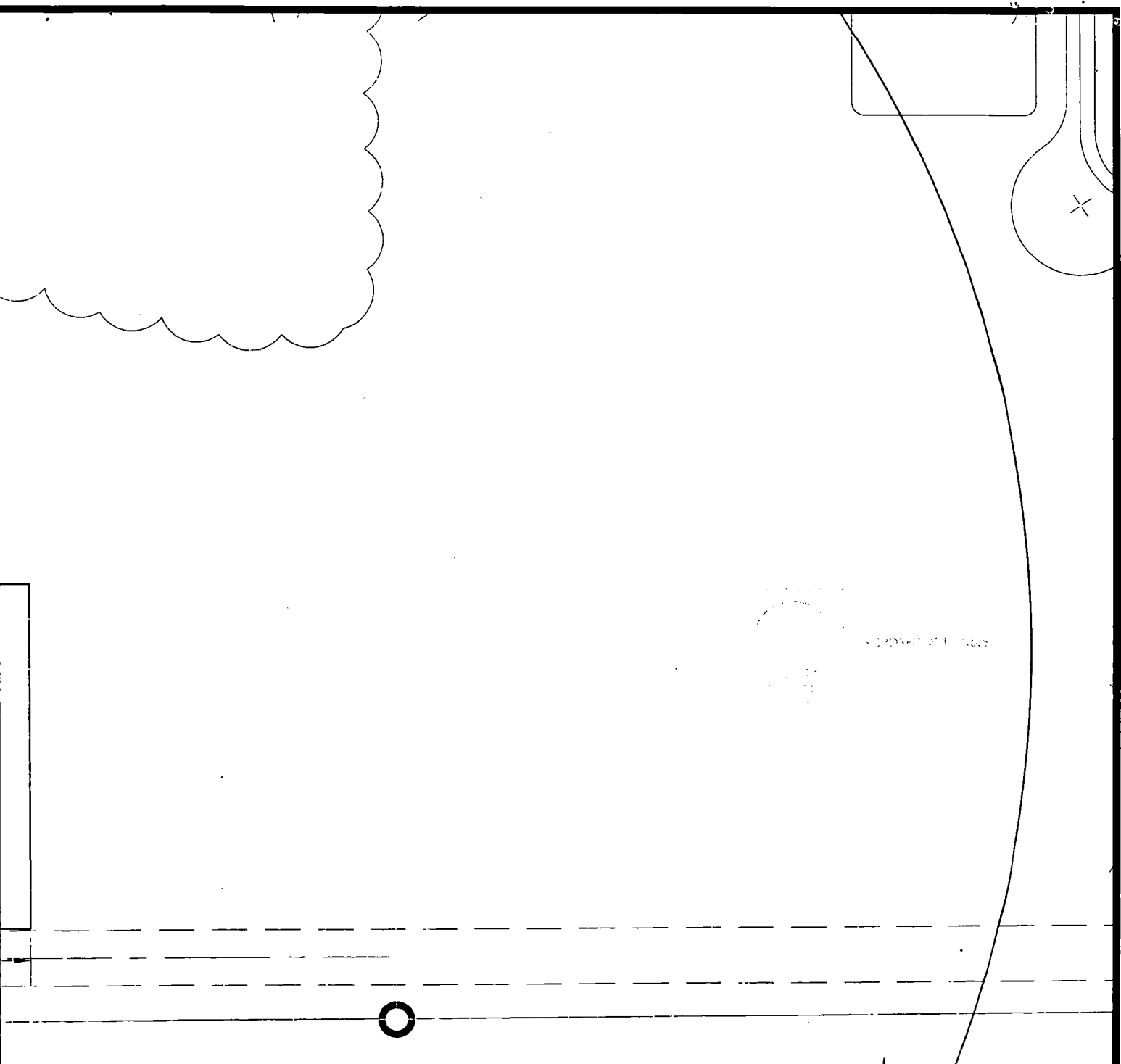

SCALE IN FEET  
1" = 60'

*Tillman & Associates*  
ENGINEERING, LLC.

2119 SW Hwy 184 • Ocala, FL 34473  
Office: (352) 307-1947 • Fax: (352) 307-2420  
CERTIFICATE OF AUTHORIZATION #26756

SCI-MAYO Mobile Batch Plant  
LAFAYETTE COUNTY, FLORIDA

**SITE PLAN**

DATE 07-24-08  
DRAWN BY DIS  
CHK'D BY JDT  
JOB NO. 08-3067  
DWG. \_\_\_\_\_  
SHT. 6 OF 8

S:\Projects\City\City\SCI - Mayo Batch\EXHIBITS\EXHIBITS2\_REV.dwg, 11/20/2006 5:48:45 PM, jmcpherson, HP, LaserJet 3150 Series PCL

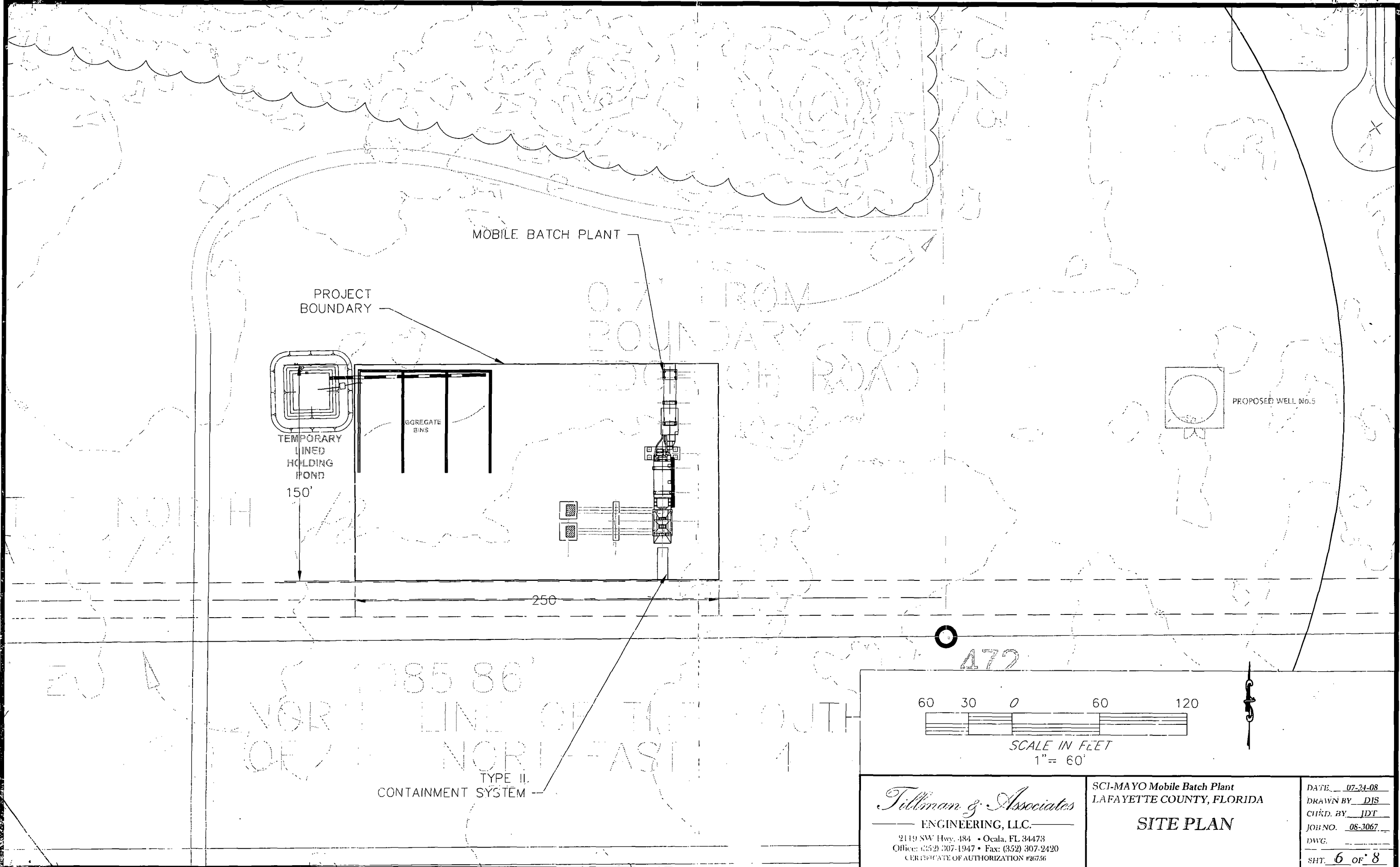

<p><i>Tillman &amp; Associates</i> ENGINEERING, LLC. 2119 SW Hwy. 484 • Ocala, FL 34473 Office: (352) 307-1947 • Fax: (352) 307-2420 CERTIFICATE OF AUTHORIZATION #26756</p>		<p>SCI-MAYO Mobile Batch Plant LAFAYETTE COUNTY, FLORIDA</p>		<p>DATE: 07-24-08 DRAWN BY: DIS CHKD. BY: JDT JOB NO. 08-3067 DWG. _____ SHT. 6 OF 8</p>
		<p><b>SITE PLAN</b></p>		

BILL OF MATERIALS

ITEM	QTY.	DESCRIPTION	REMARKS
1	1	AGGREGATE BIN 65 TON, 3-COMP.	N-619A
2	1	AGGREGATE WEIGH BATCHER, 10 CU. YD. W/2" VIBRATOR	N-617A
3	1	FOLD UP WALKWAY	970530-3
4	1	CEMENT WEIGH BATCHER 111 CU. FT. W/ 1 1/4 VIBRATOR	N-54A
5	1	12 FT. TRUSS ASSY	HT--0010
6	1	INTRUSS CONVEYOR 48" W/60HP MOTOR (650 FPM)	SCCDB001
7	2	STUB LEG ASS'Y	HT--0008
8	1	TELESCOPIC LEG ASS'Y	HT--0014
9	1	3" WATER SYSTEM	
10	2	12" x 22'-6" CEMENT FEEDERS W/ 25 HP DRIVES	CFCAE004
11	1	10" x 10' CEMENT FEEDER W/ 10 HP DRIVE	
12	1	INTRUSS SILO 480 BBL 25/75 SPLIT	
13	1	15 HP AIR W/ 120 GAL TANK	
14	1	VH-1083JP "JET PULSE" INTRUSS BAGHOUSE	
15	1	10 YD. HORIZONTAL MIXER	HM10A004
16	1	2" TEMPER WATER LINE	
17	1	3"/15 HP WATER PUMP	
18	1	5HP AERATION BLOWER	
19	2	ROTARY VANE FEEDERS	
20	2	10HP RETURN BLOWER	
21	1	SWING LEG ASS'Y	HT--0014
22	2	(1) 36" x 65' STACKER, (1) 36" x 65' CONVEYOR	RSTCF007
23	1	300 BBL. HCA AUXILIARY SILO	
24	1	450 GALLON HOLDING TANK	N-936
25	1	0-HEAD BIN LEGS	HT--0017
26	1	BEAR SUPPORT	HT--0013
27	3	4" FILL PIPES W/PT COUPLING (CEMENT)	
28	2	4" FILL PIPES W/PT COUPLING (FLY ASH)	

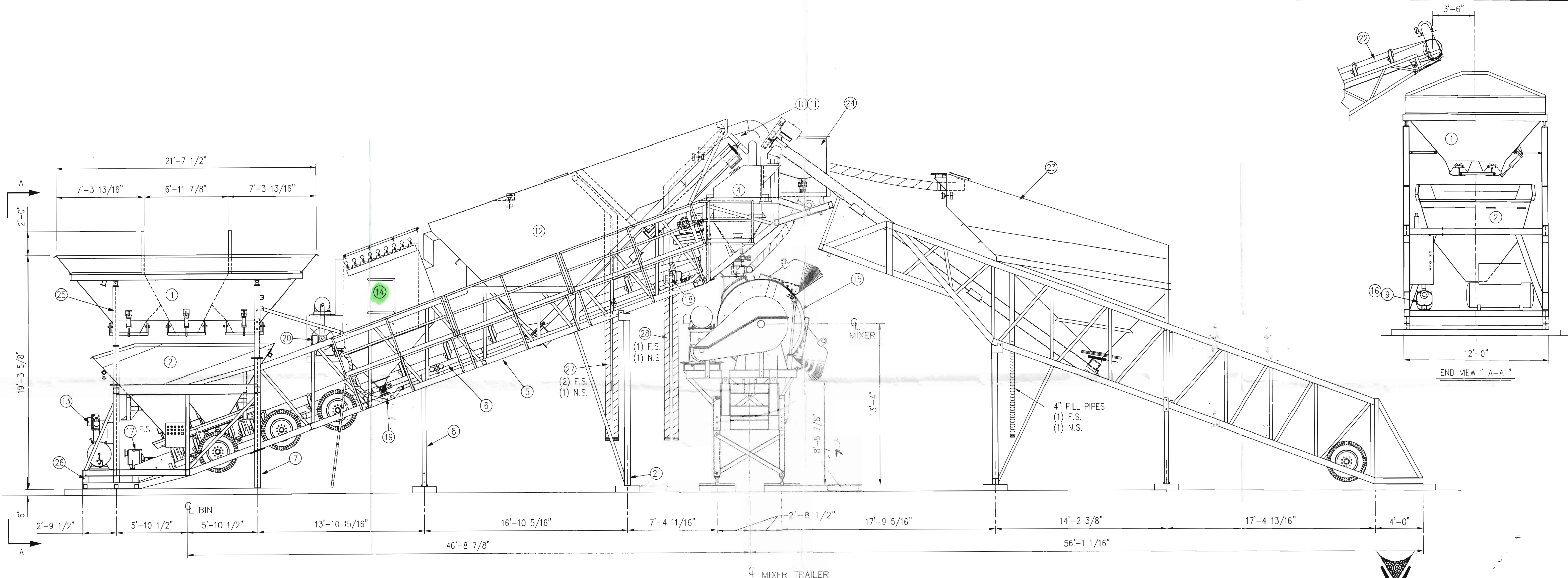
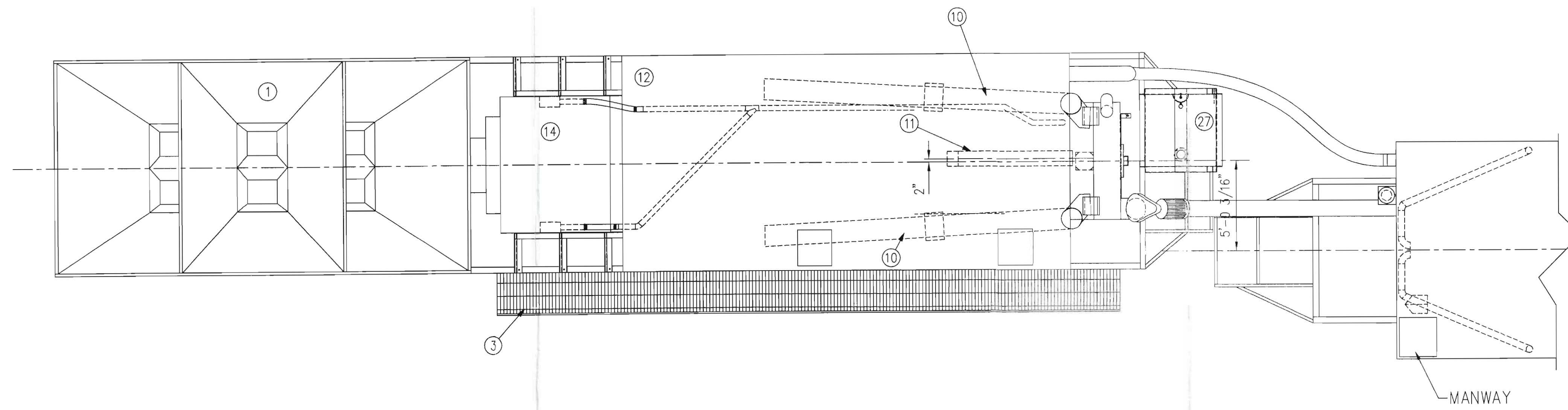

1' 10" Lower than L.P

MADE FROM	REV.	<b>THE VINCE HAGAN COMPANY</b> DALLAS, TEXAS
JOB# 991115		
OWNER	DEAVERS CONSTRUCTION	
DIST.		
MODEL NO.	HT/CM-10480/2D-65/3	
TITLE	PLANT GENERAL ARRANGEMENT	
DWN. BY	CKD. BY	DATE REL.
LOCKLEAR		11/22/99
SCALE	1/4"=1'-0"	
DRAWING NO.	HTBA0084	

REV.	BY	DATE	DESCRIPTION

**Florida Department of Environmental Protection**  
**Cash Receiving Application (CRA)**  
 Cashlisting by Deposit #: 291286 thru 291286  
 Printed: 11/24/2008 3:52:46 PM - Page 16

Cashlisting: 72291      Cashlist Area: 3755      Description: **DIV OF AIR RESOURCES MGMT.**  
 Deposit No: 291286      Date Deposited: 11/24/2008      Contact: **E. WALKER**

Object	Transmittal	Dep	DDN	Receipt Number	Pre- Numbered Receipt	Name	Check Number	Payment Amount	Reference Account	Payment Number	Remittance Number	Fund	Grant
002272	51637	ppd		645106		STEVEN COUNTS INC	129111	\$100.00	7775553-001	911067	804584	PFTF	/
	51644		488895	645256		RYBOVICH BOAT CO, LLLP	106158	\$100.00	12/7/2008-CCB	911494	804734	PFTF	
<b>Object Code 002272 Subtotal:</b>								\$200.00					
002278	51628		488792	645099		CROSS CONSTRUCTION SERVICES, I	8734	\$1,000.00	51421	911217	804577	APCTF	
<b>Object Code 002278 Subtotal:</b>								\$1,000.00					
002309	51644		488888	645248		BROWARD COUNTY	001158171	\$150.00		911486	804726	PFTF	
<b>Object Code 002309 Subtotal:</b>								\$150.00					
<b>Cashlisting 72291 Total:</b>								\$1,350.00					

STEVEN COUNTS, INC.  
Department of Environmental Protection

11/20/2008

129111

100.00

RECEIVED

NOV 21 2008

Bureau of Air Monitoring  
& Mobile Sources

**TAPE IT!**

Citizens First Sweep Mayo Air Permit

100.00