

**HUMAN CREMATORY
AIR GENERAL PERMIT REGISTRATION FORM**

Bureau of Air Monitoring
& Mobile Sources

FEB 09 2009

RECEIVED

Part II. Notification to Permitting Office

(Detach and submit to appropriate permitting office; keep copy onsite)

Instructions: To give notice to the Department of an eligible facility's intent to use this air general permit, the owner or operator of the facility must detach and complete this part of the Air General Permit Registration Form and submit it to the appropriate Department of Environmental Protection or local air pollution control program office which has permitting authority. Please type or print clearly all information, and enclose the appropriate air general permit registration processing fee pursuant to Rule 62-4.050, F.A.C. (\$100 as of the effective date of this form)

1110050-003

Registration Type

Check one:

INITIAL REGISTRATION - Notification of intent to:

- Construct and operate a proposed new facility.
 Operate an existing facility not currently using an air general permit (e.g., a facility proposing to go from an air operation permit to an air general permit).

RE-REGISTRATION (for facilities currently using an air general permit) - Notification of intent to:

- Continue operating the facility after expiration of the current term of air general permit use.
 Continue operating the facility after a change of ownership.
 Make an equipment change requiring re-registration pursuant to Rule 62-210.310(2)(e), F.A.C., or any other change not considered an administrative correction under Rule 62-210.310(2)(d), F.A.C.

Surrender of Existing Air Operation Permit(s) - For Initial Registrations Only

If the facility currently holds one or more air operation permits, such permit(s) must be surrendered by the owner or operator upon the effective date of this air general permit. In such case, check the first box, and indicate the operation permits being surrendered. If no air operation permits are held by the facility, check the second box.

- All existing air operation permits for this facility are hereby surrendered upon the effective date of this air general permit; specifically permit number(s): _____
 No air operation permits currently exist for this facility.

General Facility Information

Facility Owner/Company Name (Name of corporation, agency, or individual owner who or which owns, leases, operates, controls, or supervises the facility.)

Haisley-Hobbs Funeral Home (DBA: Haisley Funeral & Cremation Service)

Site Name (Name, if any, of the facility site; e.g., Plant A, Metropolis Plant, etc. If more than one facility is owned, a registration form must be completed for each.)

Same as Above

Facility Location (Provide the physical location of the facility, not necessarily the mailing address.)

Street Address: 3015 Okeechobee Road

City: Fort Pierce

County: Saint Lucie

Zip Code: 34947

Facility Start-Up Date (Estimated start-up date of proposed new facility.) (N/A for existing facility)

n/a

Owner/Authorized Representative

Name and Position Title (Person who, by signing this form below, certifies that the facility is eligible to use this air general permit.)

Print Name and Title:

Richard F. Haisley/President

Owner/Authorized Representative Mailing Address

Organization/Firm: Haisley Funeral & Cremation Service

Street Address: 3015 Okeechobee Road

City: Fort Pierce

County: St. Lucie

Zip Code: 34947

Owner/Authorized Representative Telephone Numbers

Telephone: 772-461-5211

Fax: 772-461-5282

Cell phone (optional):

Facility Contact (If different from Owner/Authorized Representative)

Name and Position Title (Plant manager or person to be contacted regarding day-to-day operations at the facility.)

Print Name and Title:

Larry I. Kidd/Director of Funeral Operations

Facility Contact Mailing Address

Organization/Firm: Haisley Funeral & Cremation Service

Street Address: 3015 Okeechobee Road

City: Fort Pierce

County: St. Lucie

Zip Code: 34947

Facility Contact Telephone Numbers

Telephone: 772-461-5211

Fax: 772-461-5282

Cell phone (optional):

Owner/Authorized Representative Statement

This statement must be signed and dated by the person named above as owner or authorized representative

I, the undersigned, am the owner or authorized representative of the owner or operator of the facility addressed in this Air General Permit Registration Form. I hereby certify, based on information and belief formed after reasonable inquiry, that the facility addressed in this registration form is eligible for use of this air general permit and that the statements made in this registration form are true, accurate and complete. Further, I agree to operate and maintain the facility described in this registration form so as to comply with all applicable standards for control of air pollutant emissions found in the statutes of the State of Florida and rules of the Department of Environmental Protection and revisions thereof.

I will promptly notify the Department of any changes to the information contained in this registration form.

Signature

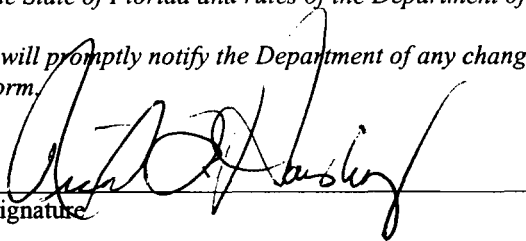

January 30, 2008

Date

Design Calculations

If this is an initial registration for a proposed new human crematory unit, provide design calculations to confirm a sufficient volume in the secondary chamber combustion zone to provide for at least a 1.0 second gas residence time at 1800 degrees F. N/A

- Manufacturer's' design calculations attached.
- Registration is not for proposed new human crematory unit(s).

Description of Facility

Below, or as an attachment to this form, provide a description of all crematory operations at the facility in sufficient detail to demonstrate the facility's eligibility for use of this air general permit and to provide a basis for tracking any future equipment or process changes at the facility. Describe all air pollutant-emitting processes and equipment at the facility, and identify any air pollution control measures or equipment used.

See Attached Description

2.0 PROCESS DESCRIPTION

Haisley-Hobbs Funeral Home operates a natural gas fired Matthews, Model IE43-M-94 Cremation Unit designed to cremate human remains. The unit is a multiple chamber incinerator with a 100 pounds per hour capacity. The afterburner ignites and preheats the secondary chamber to an operating temperature of 1,400 °F. A human body enclosed within a container is loaded into the primary chamber onto the hearth. The control timers are set and the power switch is activated.

After loading the remains into the chamber, the low fire ignition burner in the primary chamber starts. Within 30 minutes the high fire cremation burner in the primary chamber begins a controlled cycling range of 1,750 to 1,800 °F. The cycling continues until the cremation process is complete.

The approximate time for complete cremation is 2 hours, but may vary depending on body weight. A flow schematic is shown in Figure 1.

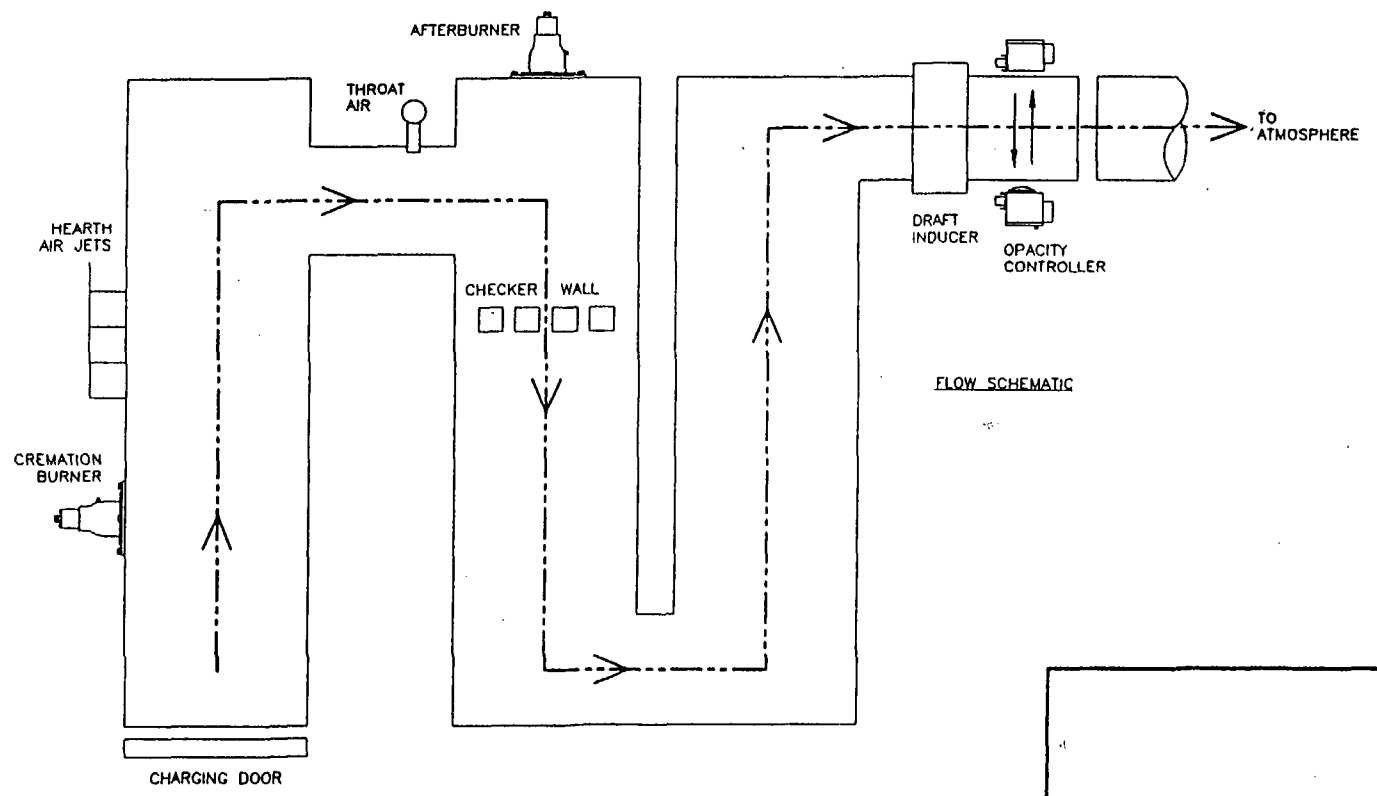
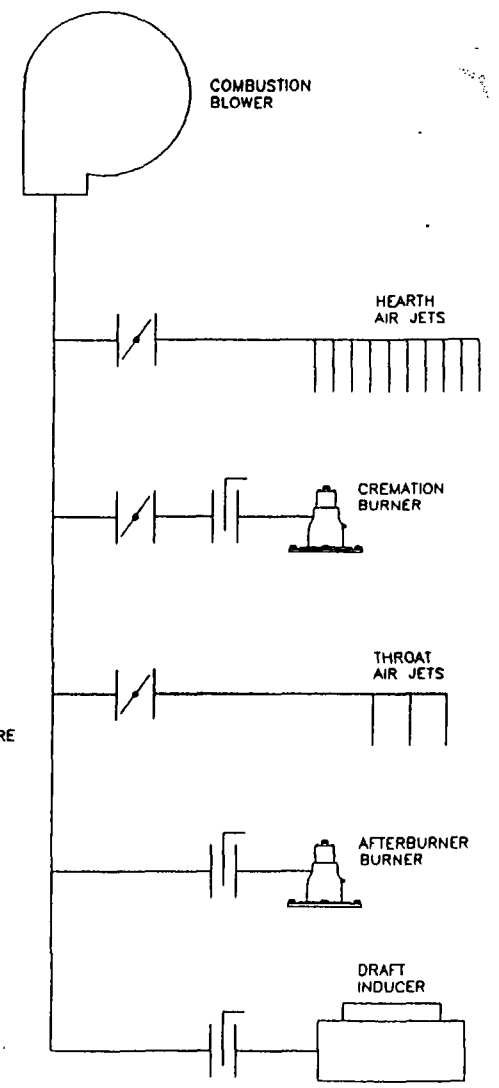
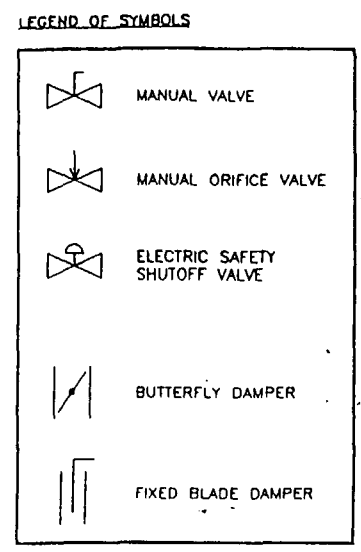
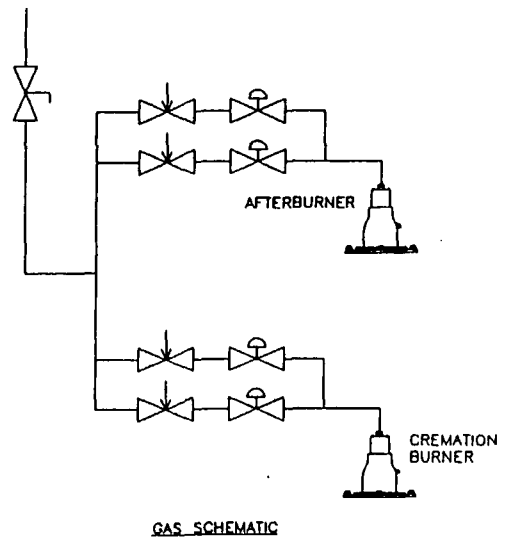

IE43-M94			
SCHEMATICS & FLOWS			
DESIGNED BY	G. BRAGUE	DATE	12-20-93
CHECKED BY	R. THOMAS	APPROVED BY	P. RANILL
SCALE	N.T.S.	PROJECT NO.	MPP-EM14
			5
			of 5 sheets

VISIBLE EMISSIONS TEST REPORT

PREPARED FOR:

Haisley Hobbs Funeral Home

3015 Okeechobee Road

Fort Pierce, FL 34947

TEST SITE:

Haisley Hobbs Funeral Home

3015 Okeechobee Road

Fort Pierce, Florida 34947

I hereby certify that the information contained in this report is true to the best of my knowledge.

Eugene D Schaltenbrand, PE 23 January 2009

TABLE OF CONTENTS

1.0 Summary

2.0 Description of Sampling Locations

3.0 Visible Emissions Field Data Sheets

4.0 Photographs

Haisley Hobbs Funeral Home
3015 Okeechobee Road
Fort Pierce, Florida

1.0 SUMMARY

Brooks & Associates conducted a visible emissions test on 22 January 2009 at the Haisley Hobbs Funeral Home in Fort Pierce.

The tests were conducted in strict accordance with the Environmental Protection Agency's Method 9 as described in 40CFR60 Appendix A, as amended. These tests were conducted to comply with the conditions set forth in Haisley Hobbs Funeral Home Operating Permit as issued by Florida DEP and to determine compliance with Chapter 62-296 and 62-297 of the Florida Administrative Code.

The crematory was loaded with approximately 150 Lb of remains for the test.

Eugene Schaltenbrand was the Certified Emissions Evaluator. Eugene Schaltenbrand was responsible for the overall testing program and preparation of this report. Eugene Schaltenbrand coordinated the test with Southeast District Florida DEP. Mr. Rick Haisley represented Haisley Hobbs. Mr. Manny Delosantos DEP.

Haisley Hobbs Funeral Home
3015 Okeechobee Road
Fort Pierce, Florida

2.0 DESCRIPTION OF SAMPLING LOCATIONS

The Crematory has a single stack on the service building. Observation was from the southeast of that building. The observer's view can be seen in the Section 5.0 Picture

The location of the observer's positions for the tests are given both as vectors from the emissions point and by GPS position.

Haisley Hobbs Funeral Home
3015 Okeechobee Road
Fort Pierce, Florida

3.0 VISIBLE EMISSIONS OBSERVATIONS FORMS- FIELD DATA

Haisley Hobbs Funeral Home
 3015 Okeechobee Road
 Fort Pierce, Florida

BROOKS & ASSOCIATES
VISIBLE EMISSION OBSERVATION FORM 1

Method (Use Multiple One) (Method 9) 203A 203B Other: _____

Form Number _____ (Page) 07
 Continued on VEO Form Number: _____

Company Name
 Haisley Hobbs
 Facility Name
 3015 OKEECHOBEE RD
 City State Zip
 FT PIERCE FL 34947

Process
 CREMATORIUM
 Control Equipment
 AIR PURIFIER
 Unit #
 150 E
 Operating Mode
 1600 P1

Describe Emission Point
 ONLY STACK ON PROPERTY

Height of Emission Pt. to Observer
 Start 16' End 16' Start 12' End 12'
 Distance to Emission Pt.
 Start 80' End 80' Start 345' End 345'

Vertical Angle to Obs. Pt.
 Start 11° End 11° Start 345' End 345'
 Distance and Direction to Observation Point from Emission Point
 Start 0/0 End 0/0

Describe Emission
 Start Clear / None End Clear / None
 Emission Color
 Start - End - Attached Detached None

Describe Plume Background
 Start SKY End SKY
 Background Color
 Start Blue End Blue Start 0 End 0
 Wind Speed
 Start 5 End 5 Start N End N
 Ambient Temp.
 Start 48 End 48 Start 24 End 41

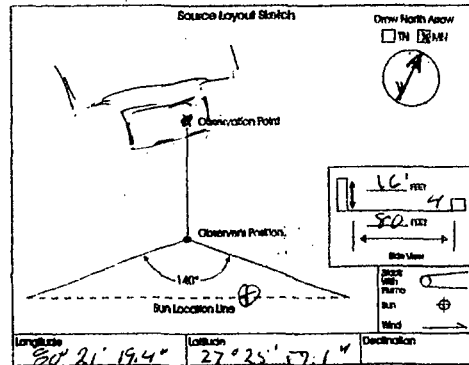

Longitude 80° 21' 19.4" Latitude 27° 25' 57.1" Direction
 Additional Information

	Observation Date				Start Time	End Time		
	22 Jan 09	Time Zone	185T	0908			1008	
	0	15	30	45	0	15	30	45
1	0	0	0	0	31	0	0	0
2	0	0	0	0	32	0	0	0
3	0	0	0	0	33	0	0	0
4	0	0	0	0	34	0	0	0
5	0	0	0	0	35	0	0	0
6	0	0	0	0	36	0	0	0
7	0	0	0	0	37	0	0	0
8	0	0	0	0	38	0	0	0
9	0	0	0	0	39	0	0	0
10	0	0	0	0	40	0	0	0
11	0	0	0	0	41	0	0	0
12	0	0	0	0	42	0	0	0
13	0	0	0	0	43	0	0	0
14	0	0	0	0	44	0	0	0
15	0	0	0	0	45	0	0	0
16	0	0	0	0	46	0	0	0
17	0	0	0	0	47	0	0	0
18	0	0	0	0	48	0	0	0
19	0	0	0	0	49	0	0	0
20	0	0	0	0	50	0	0	0
21	0	0	0	0	51	0	0	0
22	0	0	0	0	52	0	0	0
23	0	0	0	0	53	0	0	0
24	0	0	0	0	54	0	0	0
25	0	0	0	0	55	0	0	0
26	0	0	0	0	56	0	0	0
27	0	0	0	0	57	0	0	0
28	0	0	0	0	58	0	0	0
29	0	0	0	0	59	0	0	0
30	0	0	0	0	60	0	0	0

Observer Name (Print)
 EUGENE D. SCHULTENBRAND
 Date
 22 JAN 09
 Organization
 BROOKS & ASSOCIATES
 Checked By
 W. HILLOW
 Date
 JAN 09

5068 NW 85th RD
 Coral Springs, FL 33067
 954.796.1980 or 954.796.1987

Haisley Hobbs Funeral Home
3015 Okeechobee Road
Fort Pierce, Florida

4.0 PHOTOGRAPHS

Haisley Hobbs Funeral Home
3015 Okeechobee Road
Fort Pierce, Florida

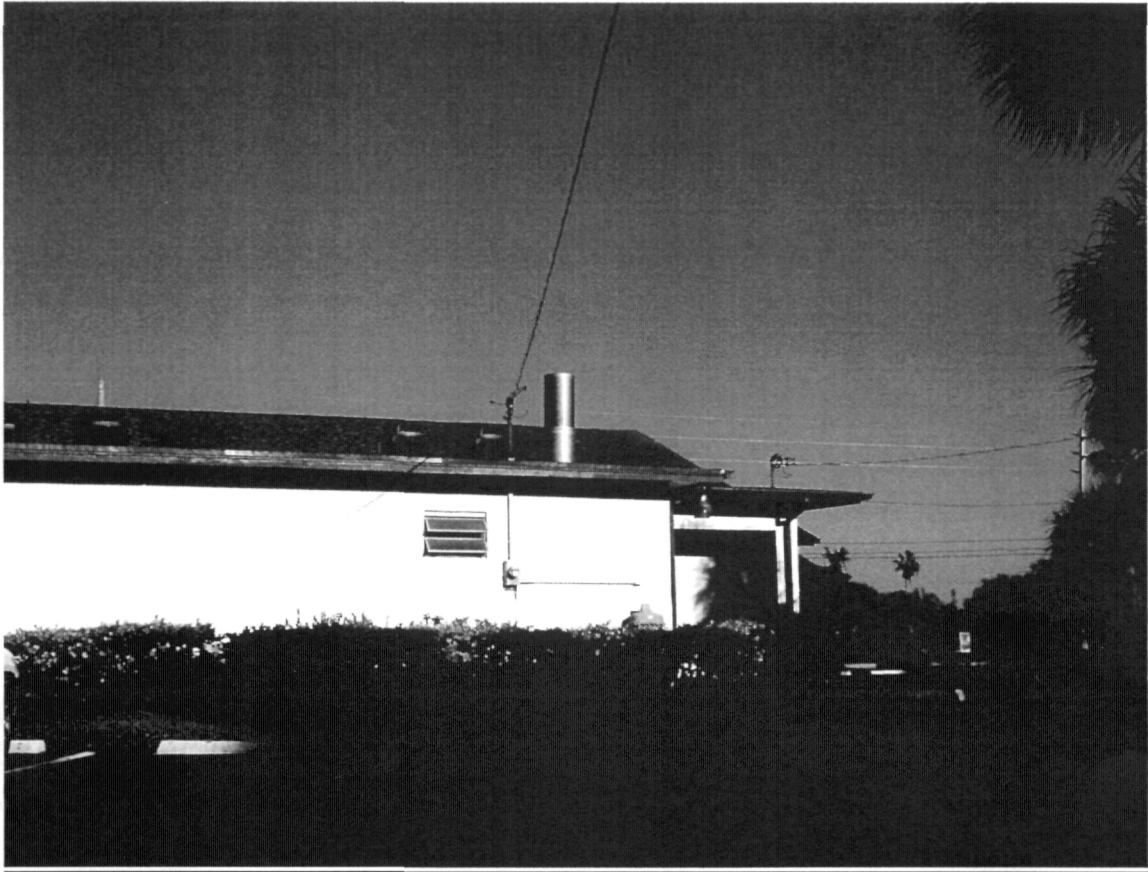

Brooks & Associates
5068 NW 85th. Rd.
Coral Springs, Fl 33067



Lawton Chiles
Governor

Florida Department of Environmental Protection

Southeast District
P.O. Box 15425
West Palm Beach, Florida 33416

Virginia B. Wetherell
Secretary

PERMITTEE:

Mr. Claude M. Hobbs, Jr., President
Haisley-Hobbs Funeral Home
3015 Okeechobee Road
Ft. Pierce, Florida 34947

I.D. NUMBER: 50/WPB/56/C050
PERMIT/CERTIFICATION NUMBER: AO 56-245:67
DATE OF ISSUE: **MAY 16 1994**
EXPIRATION DATE: April 20, 1999
COUNTY: St. Lucie
LATITUDE/LONGITUDE: 27°25'59"N/80°21'20"W
UTM: Zone 17; 563.69 Km. E; 3034.40 Km. N
PROJECT: Haisley-Hobbs Funeral Home
Human Crematory

This permit is issued under the provisions of Chapter 403, Florida Statutes, and Florida Administrative Code Rules 17-210, 17-296 and 17-297, and in conformance with all existing regulations of the Florida Department of Environmental Protection. The above named permittee is hereby authorized to perform the work or operate the facility shown on the application and approved drawing(s), plans, and other documents attached hereto or on file with the Department and made a part hereof and specifically described as follows:

OPERATE: An air pollution source consisting of a human cremation incinerator - Industrial Equipment and Engineering Co., Model IE43-PP (Power Pak) operating on natural gas or liquified petroleum gas with a permitted load rate of 100 lbs./hour.

IN ACCORDANCE WITH: Application to Operate Air Pollution Sources received February 17, 1994 with additional information received March 14, 1994 and April 6, 1994. (none are attached)

LOCATED AT: 3015 Okeechobee Road, Ft. Pierce, St. Lucie County, Florida 34947.

TO SERVE: A human crematory incinerator (SIC # 7261).

SUBJECT TO: General Conditions 1-14 and Specific Conditions 1-12.



H AISLEY

Funeral & Cremation Service

3015 Okeechobee Road, Fort Pierce, FL 34947



7006 0100 0000 9588 5300



UNITED STATES
POSTAL SERVICE

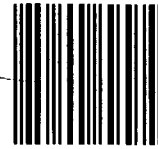

0000

32315

U.S. POSTAGE
PAID
FORT PIERCE, FL
34981
FEB 03, '09
AMOUNT

\$6.07
00070108-27

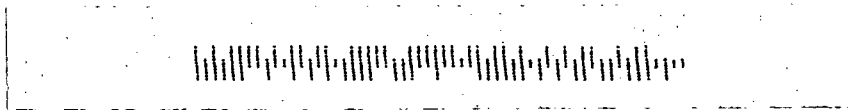

Florida Dept. Environmental Protection - RECEIPTS
PO Box 3070
Tallahassee, FL 32315-3070

**RETURN RECEIPT
REQUESTED**