

RECEIVED

JAN 30 2012

**HUMAN CREMATORY
AIR GENERAL PERMIT REGISTRATION FORM**

DIVISION OF AIR
RESOURCE MANAGEMENT

Part II. Notification to Permitting Office

(Detach and submit to appropriate permitting office; keep copy onsite)

Instructions: To give notice to the Department of an eligible facility's intent to use this air general permit, the owner or operator of the facility must detach and complete this part of the Air General Permit Registration Form and submit it to the appropriate Department of Environmental Protection or local air pollution control program office which has permitting authority. Please type or print clearly all information, and enclose the appropriate air general permit registration processing fee pursuant to Rule 62-4.050, F.A.C. (\$100 as of the effective date of this form)

Registration Type

Check one:

INITIAL REGISTRATION - Notification of intent to:

- Construct and operate a proposed new facility.
 Operate an existing facility not currently using an air general permit (e.g., a facility proposing to go from an air operation permit to an air general permit).

RE-REGISTRATION (for facilities currently using an air general permit) - Notification of intent to:

- Continue operating the facility after expiration of the current term of air general permit use.
 Continue operating the facility after a change of ownership.
 Make an equipment change requiring re-registration pursuant to Rule 62-210.310(2)(e), F.A.C., or any other change not considered an administrative correction under Rule 62-210.310(2)(d), F.A.C.

1050442-001

Surrender of Existing Air Operation Permit(s) - For Initial Registrations Only

If the facility currently holds one or more air operation permits, such permit(s) must be surrendered by the owner or operator upon the effective date of this air general permit. In such case, check the first box, and indicate the operation permits being surrendered. If no air operation permits are held by the facility, check the second box.

- All existing air operation permits for this facility are hereby surrendered upon the effective date of this air general permit; specifically permit number(s): _____
 No air operation permits currently exist for this facility.

General Facility Information

Facility Owner/Company Name (Name of corporation, agency, or individual owner who or which owns, leases, operates, controls, or supervises the facility.)

Lew Hall/ Gentry Morrison Funeral Home

Site Name (Name, if any, of the facility site; e.g., Plant A, Metropolis Plant, etc. If more than one facility is owned, a registration form must be completed for each.)

Gentry Morrison Funeral Home

Facility Location (Provide the physical location of the facility, not necessarily the mailing address.)

Street Address: 1813 Richmond Road

City: Lakeland

County: Polk

Zip Code: 33801 - 2541

Facility Start-Up Date (Estimated start-up date of proposed new facility.) (N/A for existing facility)

April 2012

Owner/Authorized Representative

<u>Name and Position Title</u> (Person who, by signing this form below, certifies that the facility is eligible to use this air general permit.) Print Name and Title: Lew Hall, Owner		
<u>Owner/Authorized Representative Mailing Address</u> Organization/Firm: Gentry Morrison Funeral Home Street Address: 1833 S. Florida Ave. City: Lakeland County: Polk Zip Code: 33803		
<u>Owner/Authorized Representative Telephone Numbers</u> Telephone: 863-688-7679 Fax: 863-683-4167 Cell phone (optional):		

Facility Contact (If different from Owner/Authorized Representative)

<u>Name and Position Title</u> (Plant manager or person to be contacted regarding day-to-day operations at the facility.) Print Name and Title: Same as Above		
<u>Facility Contact Mailing Address</u> Organization/Firm: Street Address: City: County: Zip Code:		
<u>Facility Contact Telephone Numbers</u> Telephone: Fax: Cell phone (optional):		

Owner/Authorized Representative Statement

This statement must be signed and dated by the person named above as owner or authorized representative

I, the undersigned, am the owner or authorized representative of the owner or operator of the facility addressed in this Air General Permit Registration Form. I hereby certify, based on information and belief formed after reasonable inquiry, that the facility addressed in this registration form is eligible for use of this air general permit and that the statements made in this registration form are true, accurate and complete. Further, I agree to operate and maintain the facility described in this registration form so as to comply with all applicable standards for control of air pollutant emissions found in the statutes of the State of Florida and rules of the Department of Environmental Protection and revisions thereof.

I will promptly notify the Department of any changes to the information contained in this registration form.

Signature  Date 12/31/11

Design Calculations

If this is an initial registration for a proposed new human crematory unit, provide design calculations to confirm a sufficient volume in the secondary chamber combustion zone to provide for at least a 1.0 second gas residence time at 1800 degrees F.

- Manufacturer's' design calculations attached.
- Registration is not for proposed new human crematory unit(s).

Description of Facility

Below, or as an attachment to this form, provide a description of all crematory operations at the facility in sufficient detail to demonstrate the facility's eligibility for use of this air general permit and to provide a basis for tracking any future equipment or process changes at the facility. Describe all air pollutant-emitting processes and equipment at the facility, and identify any air pollution control measures or equipment used.

Funeral Home and crematory operating a B&L Cremation Systems, Inc. Human crematory with internal afterburner with a minimum of a one second retention time at 1800°F.

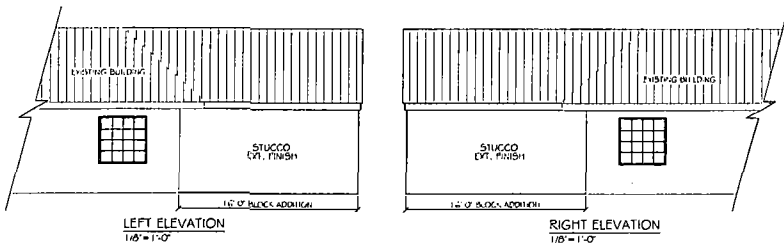
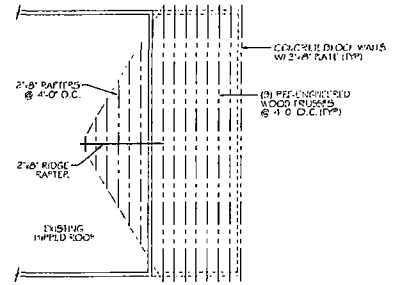
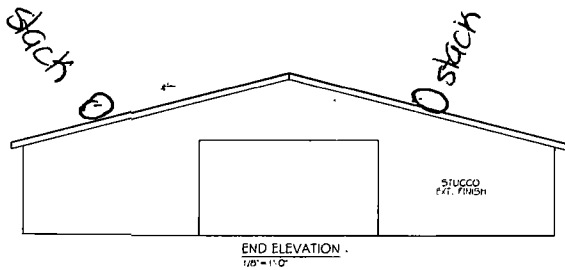

Trusses Manufactured By
 DJ Trusses Enterprises, Inc.
 305 W. Major Road, Fort Meade,
 Lakeland, FL 33810
 Phone: (888) 687-4786
 Fax: (888) 367-9920
 Email: info@djtrusses.com

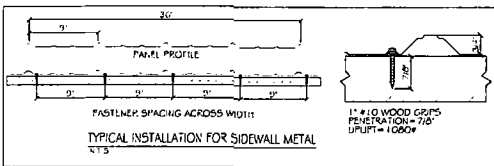
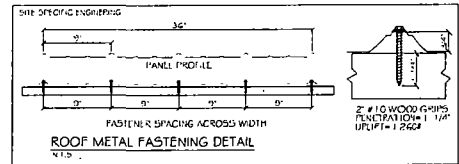

Antonio J. Basso, P.E. Florida Reg. No. 21549 STRUCTURAL ENGINEERING INDUSTRIAL, COMMERCIAL & RESIDENTIAL PHONE: OFF: 863-315-9541 FAX: 863-658-0861 OFFICE: 921 SHADOWN OAK BLVD., #3 LAKE WORTH, FL 33469 E-MAIL: antonio@blissecorp.com steeve@blissecorp.com		FLOOR PLAN ELEVATIONS	PLANS FOR: LEW HALL CREMATORIUM
BLISS ENTERPRISES OF TAMPA, INC. CBC 1257107	3940 LONGHITS GRIFFIN RD. PLANT CITY, FLORIDA 33565 PHONE: 813-754-1166	SCALE: AS SHOWN DATE: 01.10.12	SHEET: A2

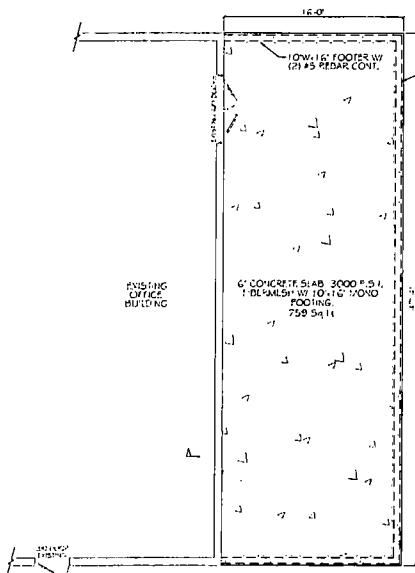

FOUNDATION PLAN
1/8" = 1' 0"

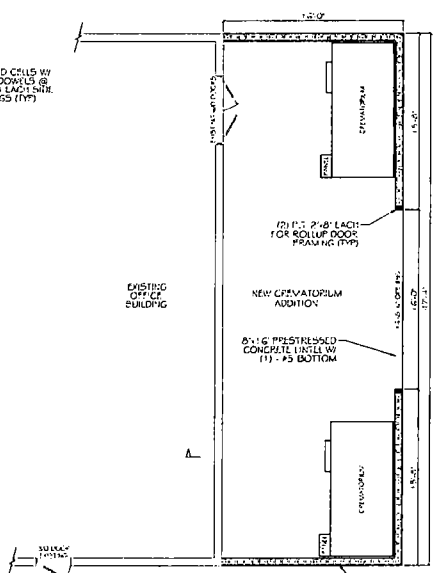

FLOOR PLAN
1/8" = 1' 0"

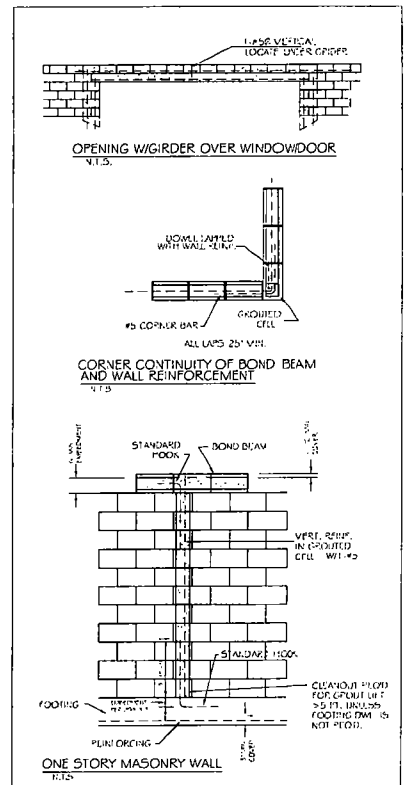

Antonio J. Bonni - P.E. License No. 21548 STRUCTURAL ENGINEERING INDUSTRIAL, COMMERCIAL & RESIDENTIAL PHONE: OFF. 863 815 2344 FAX: 863 858 2821 OFFICE: 251 SANDHURST DR., #3 WINDLAND, FL 33629 E-MAIL: antonio@blisseng.com www.blisseng.com	FLOOR PLAN ELEVATIONS	PLANS FOR: LEW MALL CREMATORIUM	SCALE: AS SHOWN DATE: 01.10.12 SHEET: A1
	BLISS ENTERPRISES OF TAMPA, INC.		3840 N.W. 116th AVENUE, #20 PLANO, FLORIDA 33065 TEL: 813 755 1700

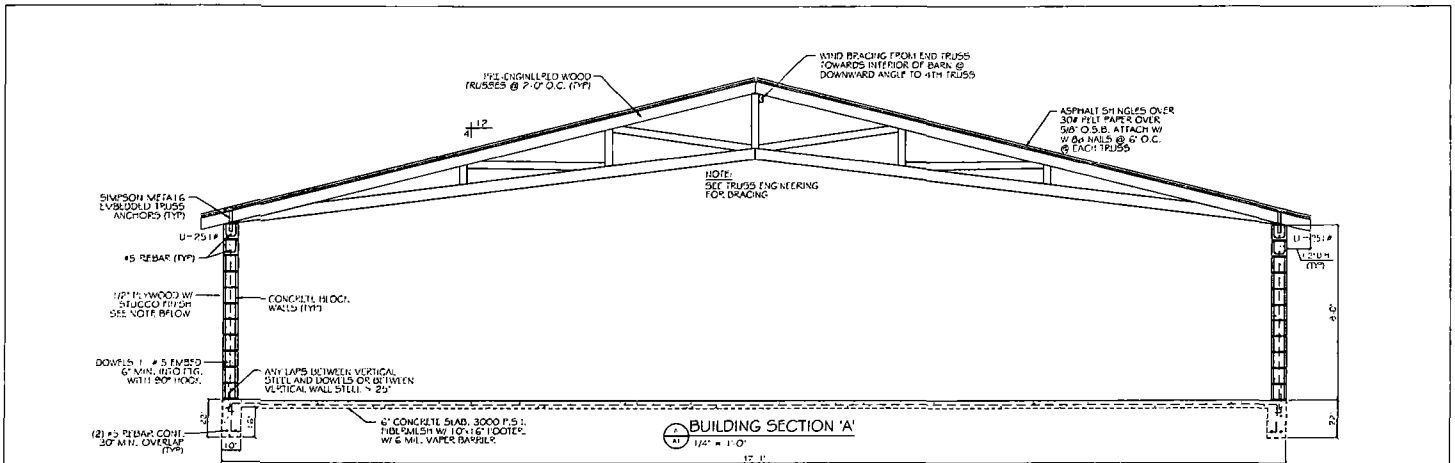

NOTE: EXTERIOR FINISH
 3/4\"/>

- GENERAL NOTES:**
- THIS BUILDING IS IN ACCORDANCE WITH 2007 FLORIDA BUILDING CODE.
 - BASIC WIND SPEED = 120 MPH.
 - EXPOSURE CATEGORY: B.
 - IMPORTANCE FACTOR: 1.75.
 - ALL WOOD IN THIS STRUCTURE TO BE SP #2 GRAD OR BETTER.
 - ANCHORED TO SOIL BASED ON FOUNDATION DESIGN SP-486 PER ASCE (AMERICAN SOCIETY OF AGRICULTURAL ENG.)
 - FOR STRUCTURAL INTEGRITY, METAL SHEETING SHALL BE MINIMUM STANDARD 29 GA., 50,000 LB. TENSILE STRENGTH.
 - DESIGN WIND PRESSURE FOR EXTERIOR COMPONENTS AND CLADDING - (+) 30 PSF.
 - INTERNAL PRESSURE COEFFICIENT - ENCLOSED (+) 0.18.
10. ALL PRESSURE TREATED LUMBER SHALL BE AS FOLLOWS:
 REFERENCE (LBS/CU FT) USE/EXPOSURE
 .25 ABOVE GROUND
 .40 GROUND CONTACT
 .60 FRESH WATER
 2.50 WOOD FOUNDATION
 SALT WATER
- ALL DOORS, WINDOWS & ROOFING/SHED MATERIALS TO BE INSTALLED AS PER MANUFACTURERS INSTRUCTIONS, (UNLESS OTHERWISE STATED). CONTRACTOR OR OWNER SHALL SUPPLY VENDOR DATA STATING THE ABOVE ITEMS COMPLY WITH 2007 FLORIDA BUILDING CODE FOR 120 MPH WINDS.
 - ELECTRICAL, PLUMBING & HVAC IF REQUIRED FOR THIS PROJECT WILL BE FINISHED AT A LATER DATE.
 - SIDEWALL OR GABLE METAL FASTENED @ 9' O.C. HORIZONTAL AND 24\"/>

NAILING SCHEDULE (AS NEEDED)		
TYPE	NAILING	ALLOWABLE UPLIFT (LBS)
SIMPSON METAL G	3-10d x 1 1/2\"/>	
SIMPSON H1	4-8d NAILS	490
SIMPSON H10	6-8d NAILS	905
SIMPSON H1S12	12-10d NAILS	775

Arizona J. Deems, P.E.
 Florida Reg. No. 21549

STRUCTURAL ENGINEERING
 INDUSTRIAL, COMMERCIAL, & RESIDENTIAL

PHONE: OFF: 813-815-0511 FAX: 813-830-9061
 E-MAIL: jess@bliss-engineering.com
 OFFICE: 3275 BRADSHAW RD, SUITE #3 TAMPA, FL 33629

BUILDING SECTION	PLANS FOR: LEW HALL CREMATORIUM
BLISS ENTERPRISES OF TAMPA, INC.	 3940 KNIGHTS GOLFWAY RD. PLANT CITY, FLORIDA 33563 Ph: 813-754-1766 Fax: 813-754-1766
DWN. AS SHOWN DATE: 01.10.13 DRAWN BY:	SHEET: 51

SKETCH OF PROPOSED DESCRIPTION

Sec.: 28
Twp.: 28
Rng.: 24

S. This Boundary Survey was prepared for Lew Hall, Jr. on 01 / 02 / 12

Sketch #: 12-7469
File ID #: 11-7466
Drafted by: MSM

These documents and all data and/or information depicted shall remain the sole Professional intellectual property of M. Stewart McDonald until the Professional fee is paid in full.

Copyright © 2012 by M. Stewart McDonald - P.L.S.
All rights reserved.



*Wind Direction is generally from the West

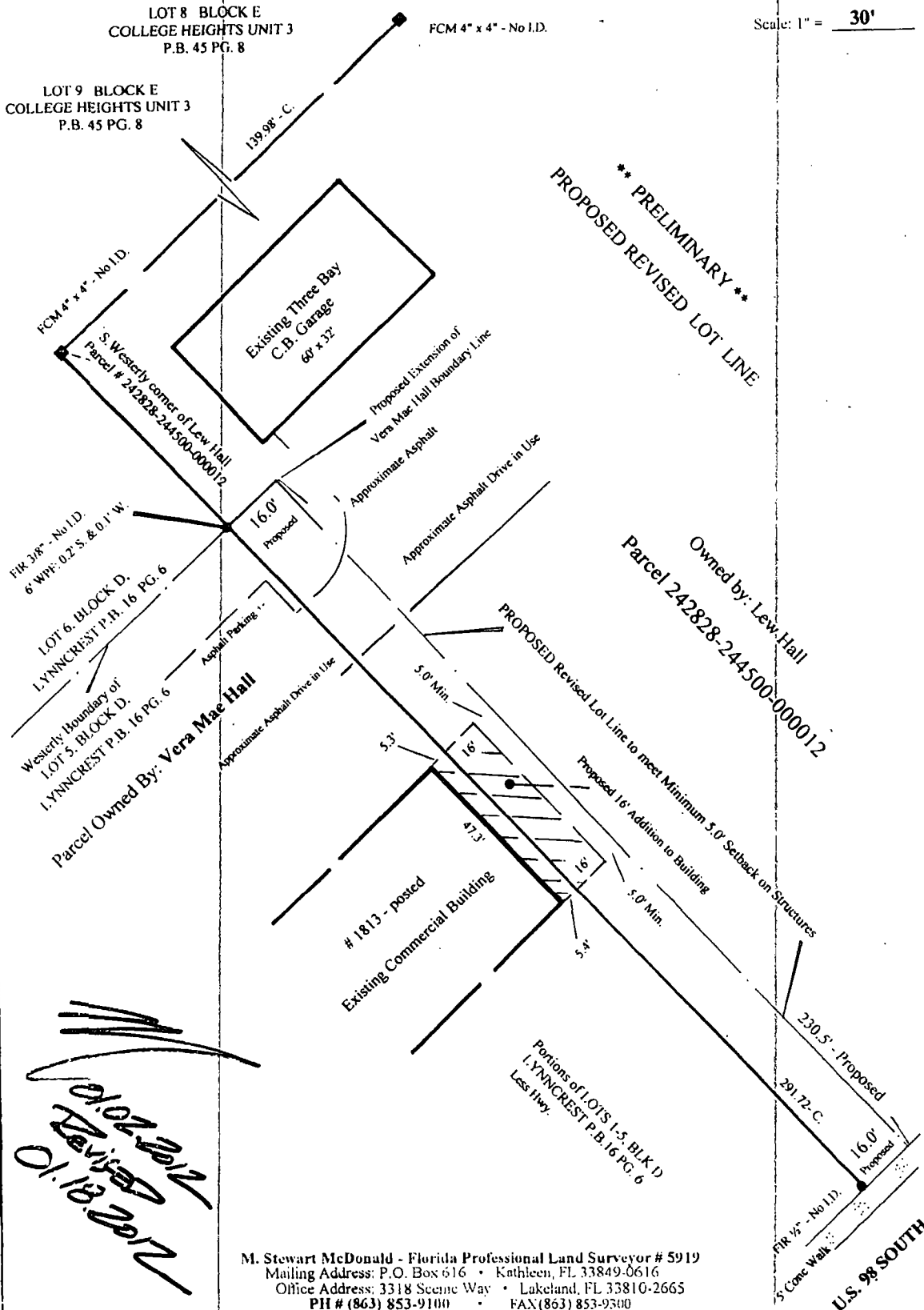

Revised 01.18.2012

M. Stewart McDonald - Florida Professional Land Surveyor # 5919
Mailing Address: P.O. Box 616 • Kathleen, FL 33849-0616
Office Address: 3318 Scenic Way • Lakeland, FL 33810-2665
PH # (863) 853-9100 • FAX (863) 853-9300

**CALCULATIONS FOR PRODUCTS OF COMBUSTION
AND RESIDENCE TIME FOR 150 LB/hr
TYPE IV WASTE. B&L N-20 SERIES CREMATORY**

PROPANE

A. BASIS: 1 LB WASTE

1. $\frac{1 \text{ lb waste} \times 1000 \text{ Btu/lb waste} \times 15 \text{ lbs air}}{10,000 \text{ Btu}} = 1.5 \text{ lbs air}$
2. $\frac{1 \text{ lb waste} \times 0.10 \text{ lb combustible}}{1 \text{ lb waste}} = 0.10 \text{ lbs of combustibles}$
3. $\frac{1 \text{ lb waste} \times 0.85 \text{ lb H}_2\text{O} \times 1.6^*}{1 \text{ lb waste}} = 1.36 \text{ lbs of water}$
4. $\frac{6,500 \text{ Btu aux fuel}^{**} \times 23.8 \text{ cu ft air/cu ft fuel}}{2,500 \text{ Btu/cu ft fuel} \times 13.35 \text{ cu ft air/lb air @ 70f}} = 4.64 \text{ lbs of air for aux fuel}$
5. $\frac{6,500 \text{ Btu aux fuel} \times 0.044 \text{ lb fuel/cu ft fuel}}{2,500 \text{ Btu/cu ft fuel}} = 0.11 \text{ lb of aux fuel}$
6. Sum = PRODUCTS OF COMBUSTION (POC) = 7.71 lbs POC per lb waste @ 70f

B. RESIDENCE TIME @ 1600 F

1. $\frac{7.71 \text{ lbs POC/lbs waste} \times 51.89 \text{ cu ft / lb POC @ 1600f} \times 150 \text{ lbs waste / hr}}{3600 \text{ sec/hr}}$
 $= 16.67 \text{ cu ft / sec @ 1600 f} = 17.00 \text{ cu ft for 1 second residence time}$

RESIDENCE TIME @ 1800 F

2. $\frac{7.71 \text{ lbs POC/lbs waste} \times 56.93 \text{ cu ft / lb POC @ 1800f} \times 150 \text{ lbs waste / hr}}{3600 \text{ sec/hr}}$
 $= 18.1 \text{ cu ft / sec @ 1800 f} = 19.00 \text{ cu ft for 1 second residence time}$

* Correction multiplier for dry air and water vapor

** Fuel is propane

Referances: Incinerator institute of America.
North American Combustion Handbook
Eclipse Combustion Engineering guide

C. THERMOCOUPLE PLACEMENT.

Secondary chamber operating temperature at > or = to 1600f = 17.00 cu ft from flame tip.
1800f = 19.00 cu ft from flame tip.



^{Cremation}
Systems, Inc.

7205 - 114th Avenue North • Largo, Florida 33773
1-800-622-5411 • 727-541-4666 • Facsimile 727-547-0669

PROCESS DESCRIPTION

This project consists of the construction of one new cremation retort. This crematorium will consist of one B & L Systems Model N-20AA Human Cremator. The cremation unit will be fired on propane.

Deceased human remains are manually placed into the primary chamber of the cremator. The door of the cremator is then closed. After a preheat of the afterburning chambers by the auxiliary burner, initial and supplementary combustion is provided by a propane fired burner located in the primary chamber of the cremator. Once material combustion is initiated, the rate of the combustion is controlled by limiting both the combustion air and fuel supplied to the primary chamber through the primary burner. This process generates a highly combustible gas mixture that flows into a secondary chamber where more air is admitted to insure further oxidation of the gases. The auxiliary burner is installed in the secondary chamber of the cremator to facilitate complete combustion of all gaseous materials entering this chamber.

Once the cremation process is complete, the remains are removed from the primary chamber of the cremator. These remains are placed in urns and returned to the family for interment or disposal.



Cremation
Systems, Inc.

7205 - 114th Avenue North • Largo, Florida 33773
1-800-622-5411 • 727-541-4666 • Facsimile 727-547-0669

TEMPERATURE CONTROL SEQUENCE

A type "K" thermocouple is placed 19³ ft. down stream of the flame tip to measure temperature, the signal is sent to the *main control panel* where it is received by a FUJI PYZ series temperature controller with digital readout and a DR4200 *temperature recorder*. The FUJI PYZ series temperature controller controls the temperature via a *motorized butterfly valve* located on the *afterburner inlet gas assembly*. Gas demand is controlled by temperature to maintain a steady temperature. The *ignition/cremation burner* is interlocked to the *afterburning temperature* by the FUJI PYZ series temperature controller set point. Combustion cannot start until *temperature set point* is reached. Alarm contacts in the FUJI PYZ series temperature controller are utilized for over (high) temperature conditions. 100° F over set point the *afterburner* will be in maximum low fire and the *ignition/cremation burner* will shut off. The *butterfly valve* located on the *secondary air inlet* is controlled by a separate temperature out put to add air to cool the system. At *set point* the unit will return to normal operation. An optimonitor smoke detector is placed on the stack and set at 10% opacity if emissions occur the alarm will sound; a visual *red warning lamp* located on the *control panel* will illuminate and the *primary burners* will shut off. The *excess air butterfly valve* will open to add air to the *secondary chamber* to oxidize the emissions. After a five (5) minute period the unit will revert to normal operation.

World's Largest Independent Cremation Equipment Manufacturer



Cremation
Systems, Inc.

7205 - 114th Avenue North • Largo, Florida 33773
1-800-622-5411 • 727-541-4666 • Facsimile 727-547-0669

PROCESS FLOW DIAGRAM

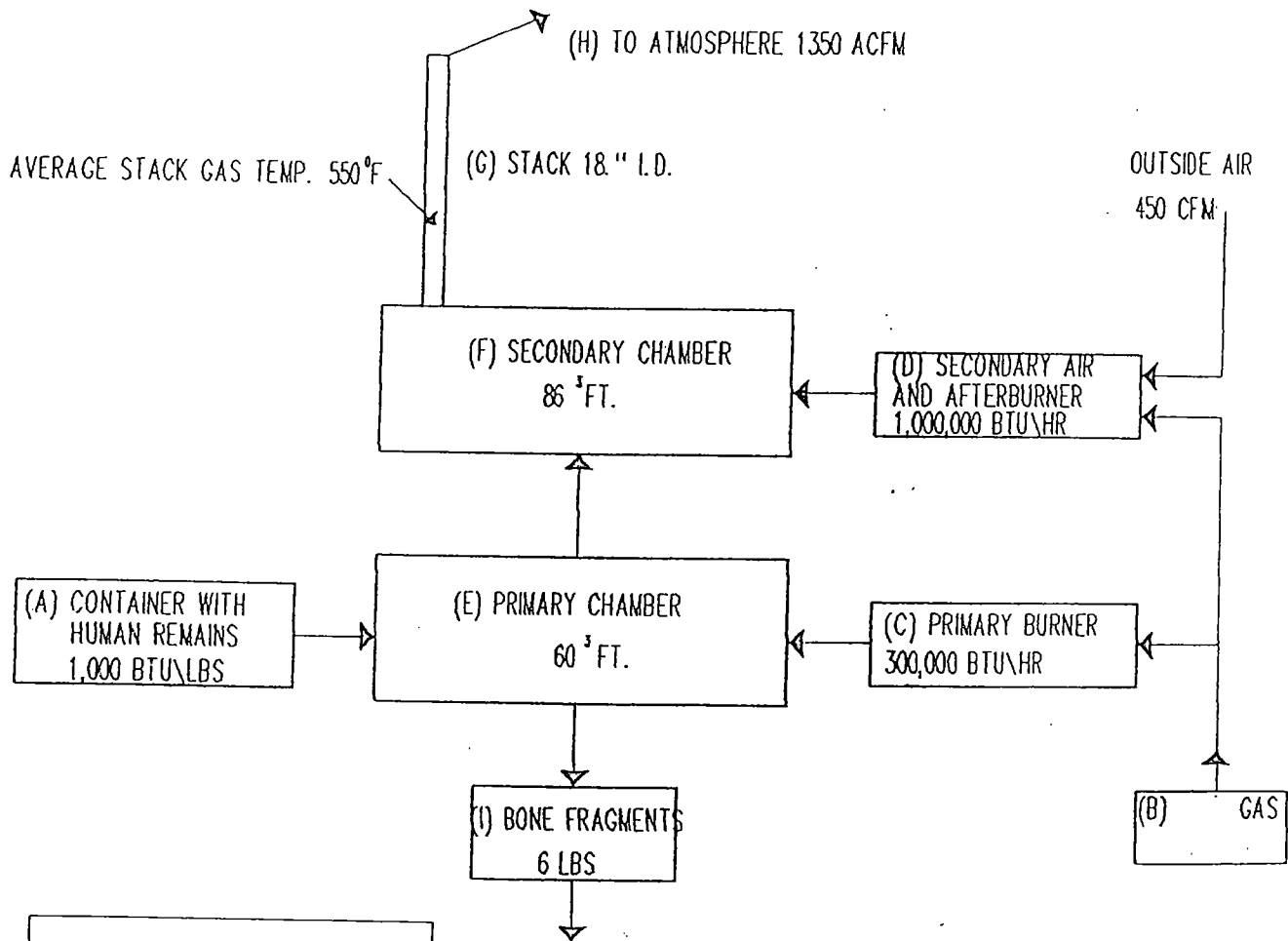

ELEVATION	_____
STACK HEIGHT	_____
ROOF HEIGHT	_____

World's Largest Independent Cremation Equipment Manufacturer

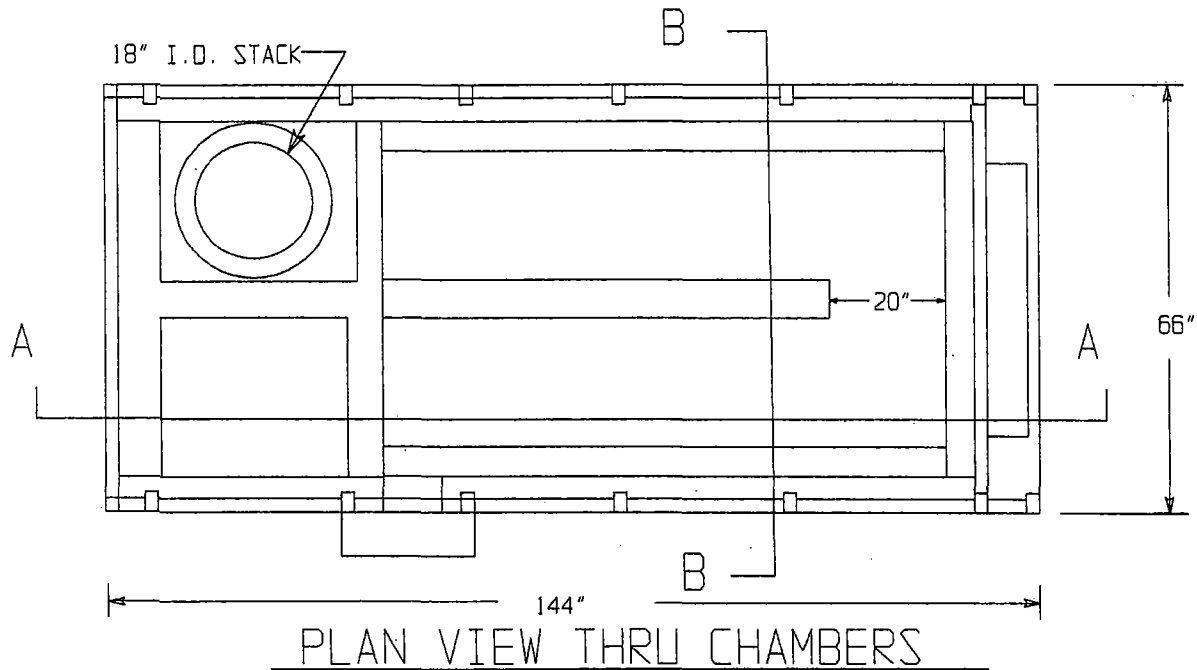
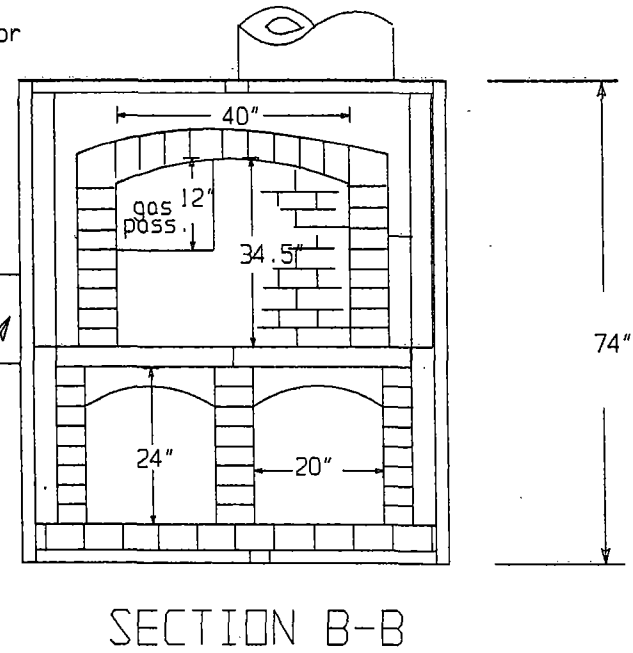
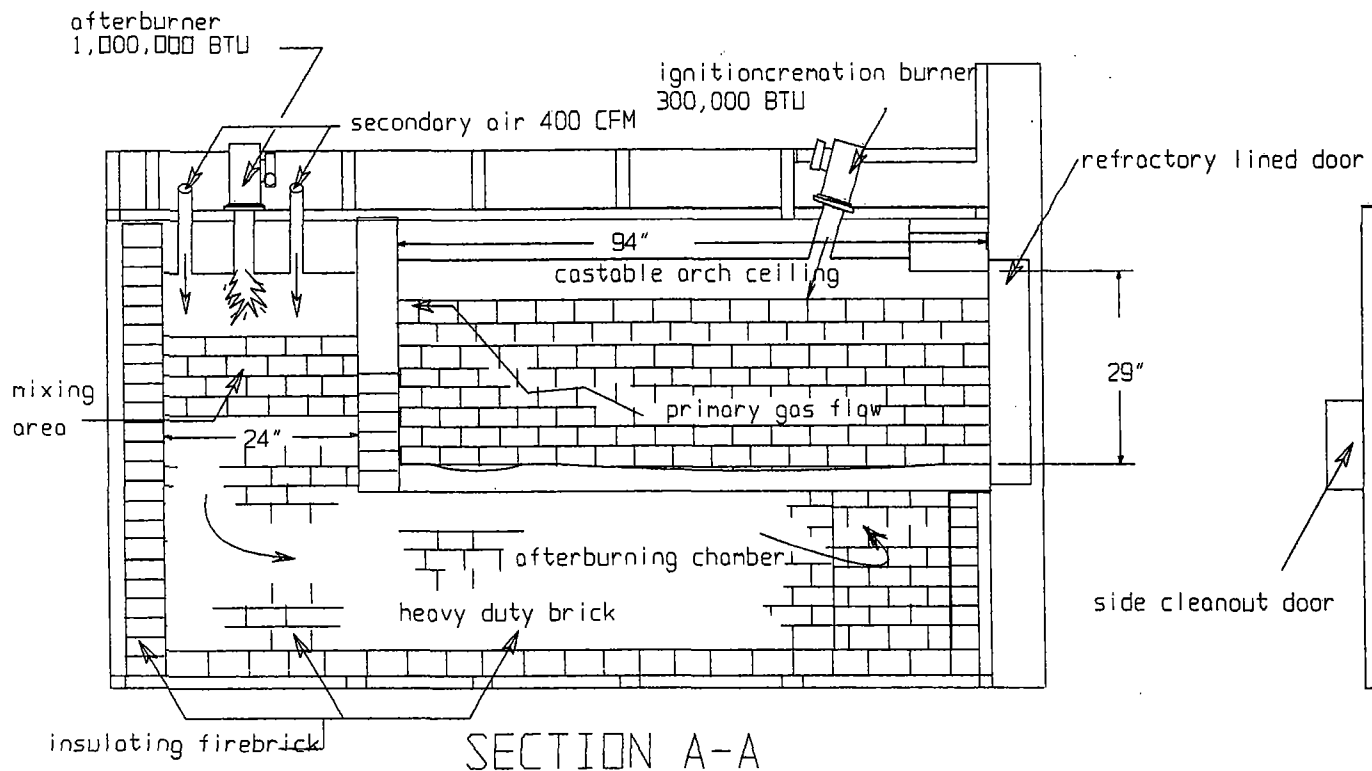

ALL COMPONENTS U.L. ANDR A.G.A. APPROVED
C.S.A.-C.G.A

N20AA REFRACTORY

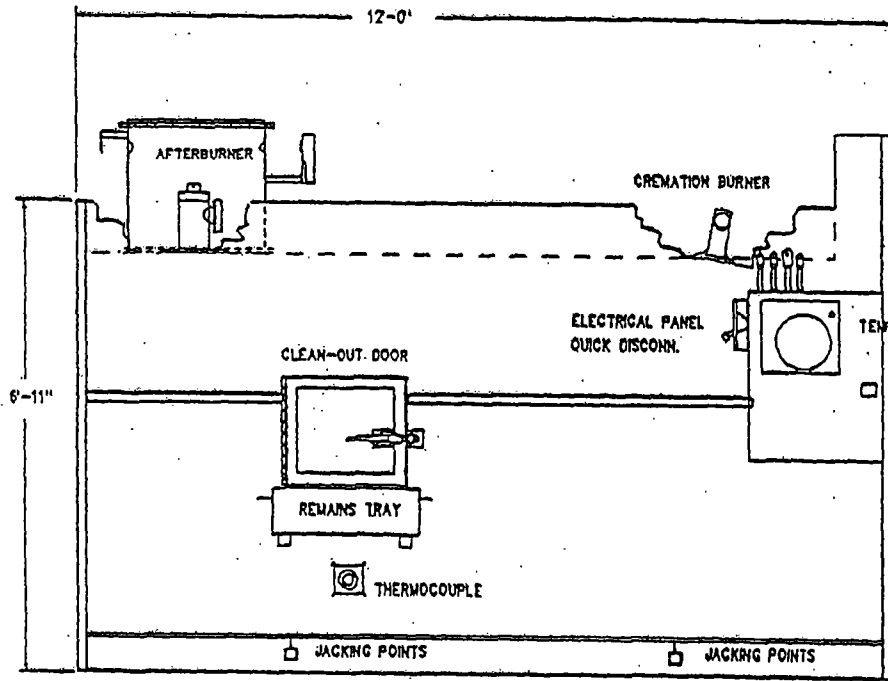

SIDE ELEVATION

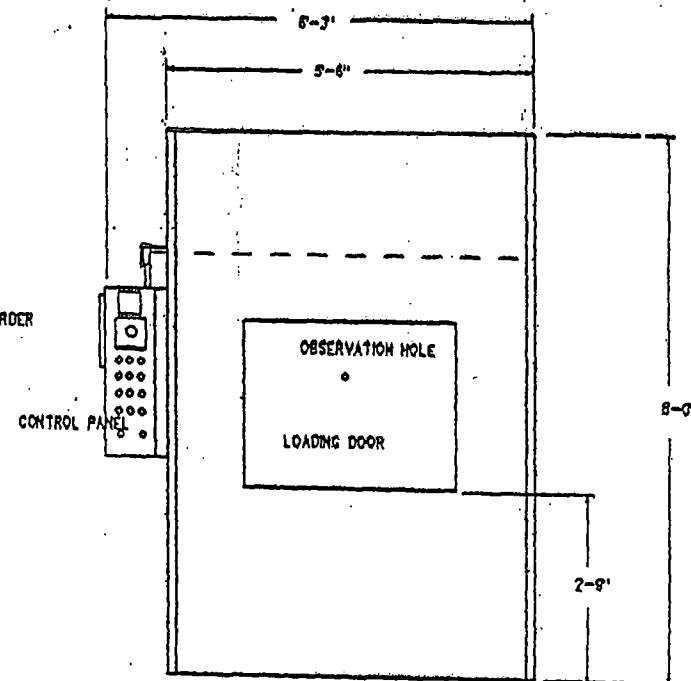

FRONT ELEVATION

FOR SIZES ONLY
ORIENTATION MAY CHANGE

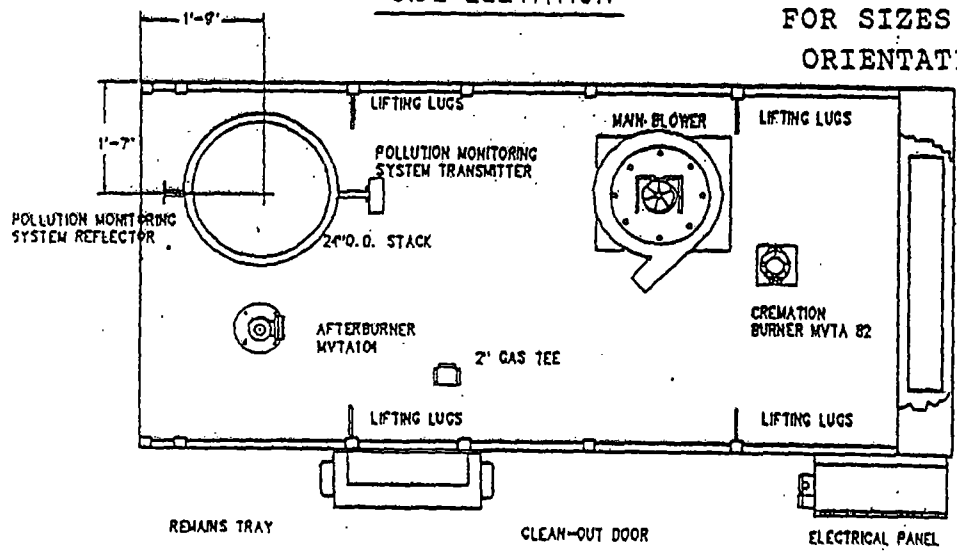

PLAN VIEW

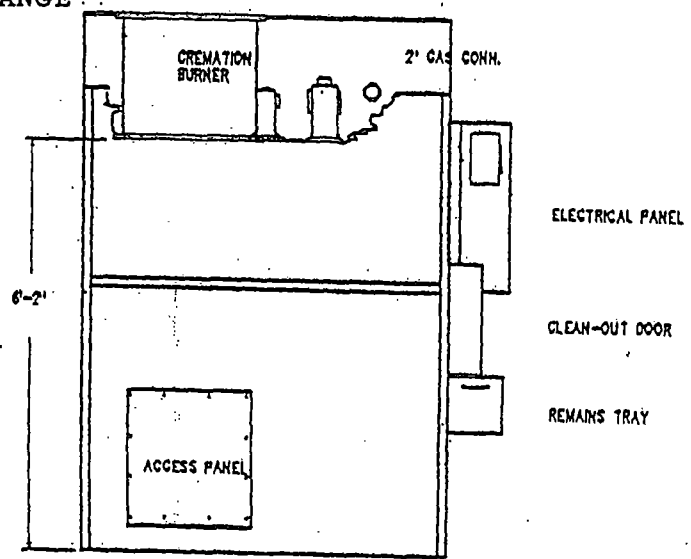

REAR ELEVATION

N20AA

Drawing #8

AFTERBURNER

B & L SYSTEMS N20 SERIES

SECONDARY AIR

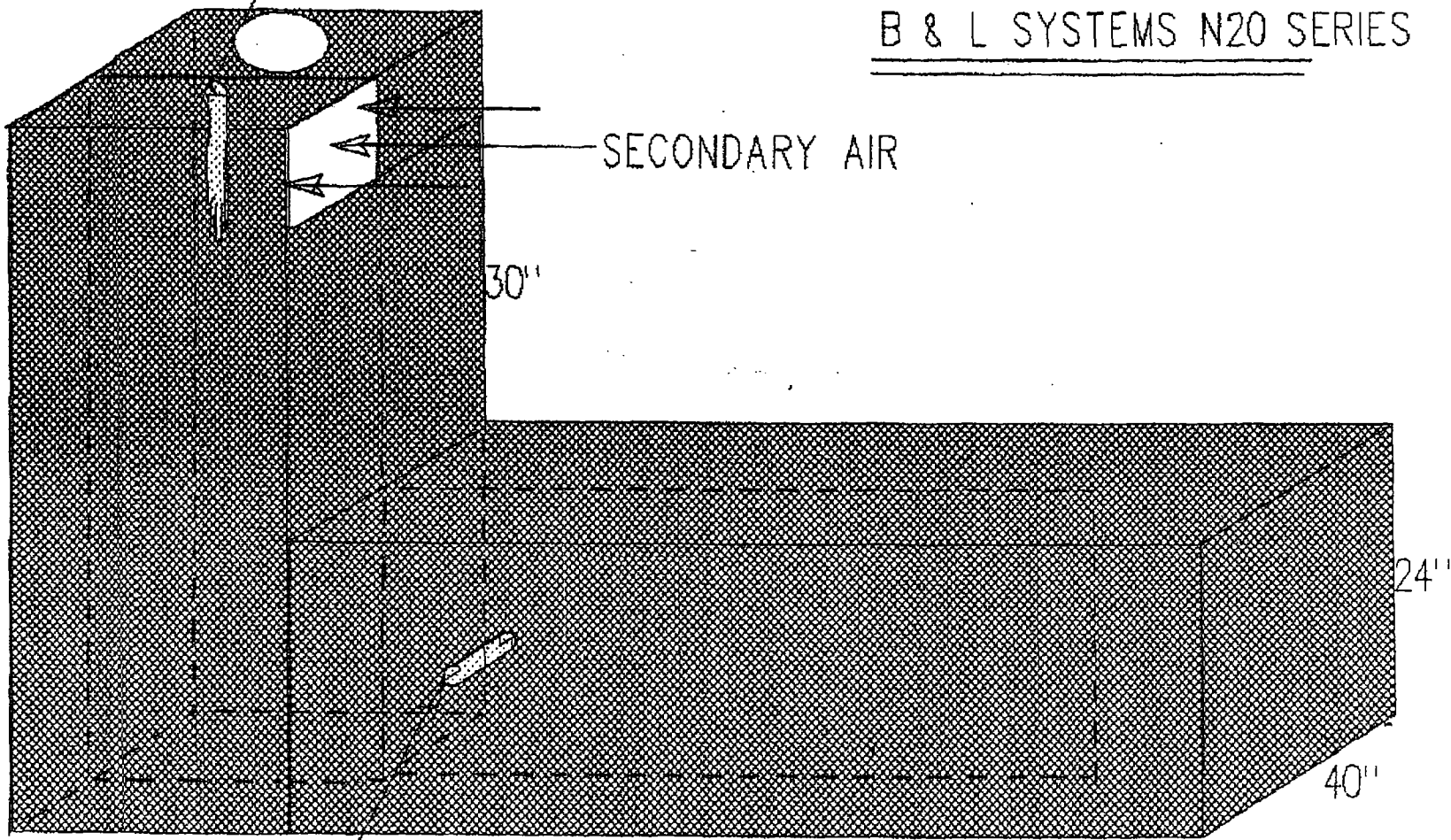

THERMOCOUPLE LOCATION
20.0 FT³

SHADED AREA REPRESENTS AFTERBURNER CHAMBER VOLUME OF
83.00 FT³ @ 1800°F





Cremation
Systems, Inc.

7205 - 114th Avenue North • Largo, Florida 33773
1-800-622-5411 • 727-541-4666 • Facsimile 727-547-0669

SECONDARY
AIR BURNER

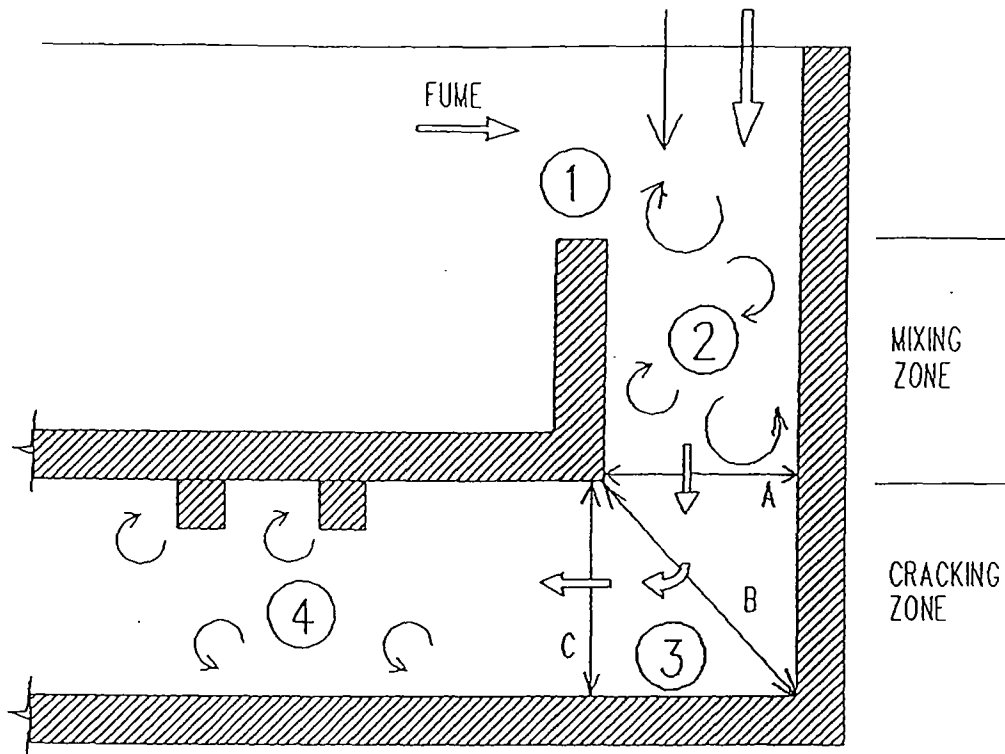

1. At the back of primary chamber, waste fume, air and burner flame all meet with different viscosities, volumes, velocities and flow directions which causes turbulence in the mixing zone of the secondary chamber.
2. Turbulence continues in the mixing zone as flows are traversing the flame tip.
3. Changing velocity at flame front zone and cornering cause additional turbulence at the base of the unit. $V_A > V_B < V_C$.
4. Uneven cross sectional area due to arches in the ceiling to support the primary chamber floor and additional changes in directional flow causes further turbulence downstream in the secondary chamber.

World's Largest Independent Cremation Equipment Manufacturer

Eclipse Velocity Burners

ThermJet Series (version 1.0)

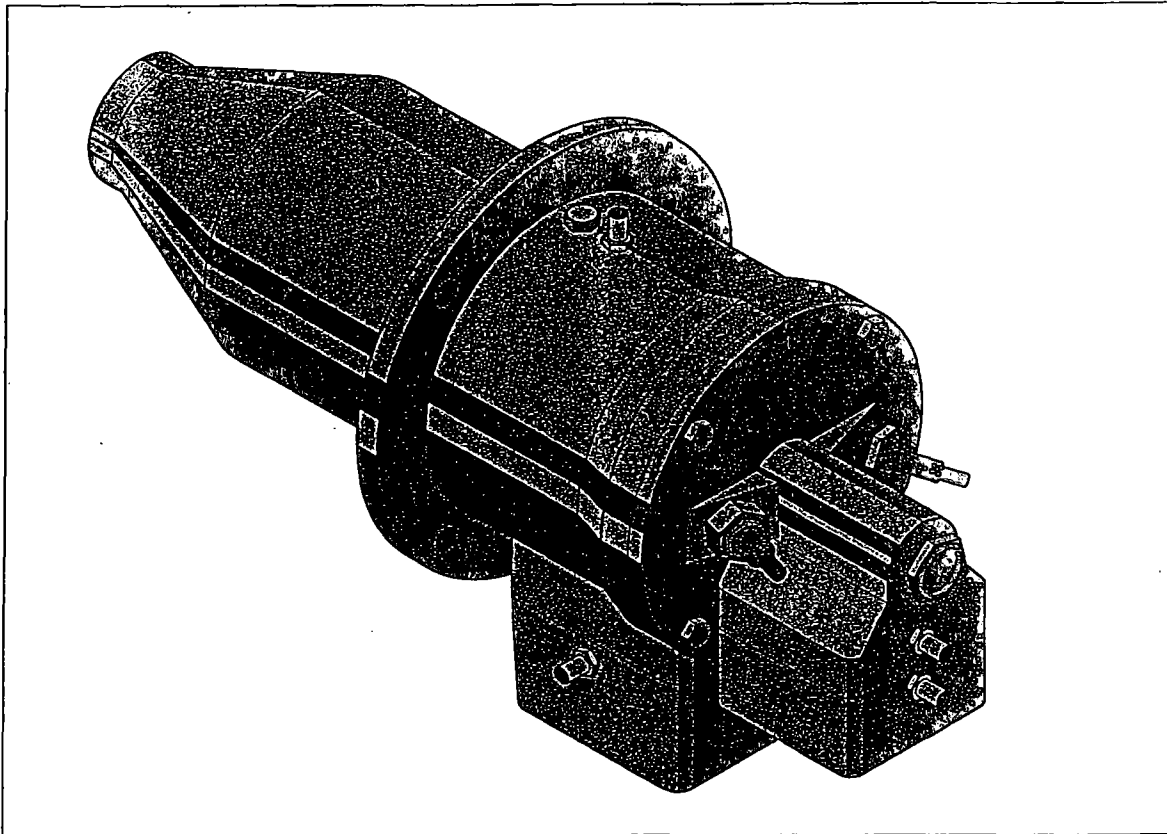

Specifications

3

INTRODUCTION

This section gives a detailed overview of the burner specifications. It also lists several options that are available for the Thermjet.

Figure 3.1 The Thermjet burner

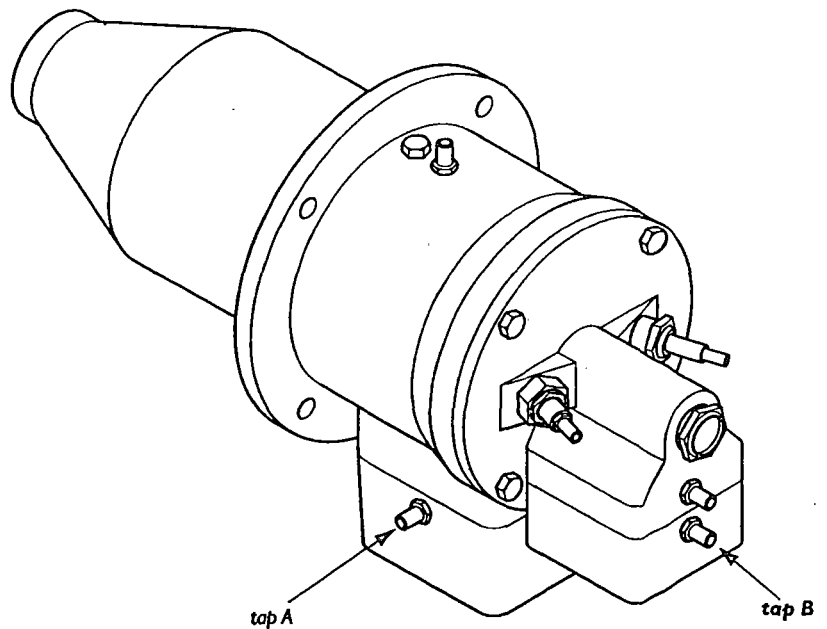

Table 3.1 Options

PARAMETER	OPTIONS
Fuel	<ul style="list-style-type: none"> • natural gas • propane • butane. <p><i>For any other mixed gas, contact Eclipse for orifice sizing.</i></p>
Flame detection	<ul style="list-style-type: none"> • U.V. scanner • flame rod, for use with alloy or silicon carbide firing tubes only.
Ignition	<ul style="list-style-type: none"> • direct spark ignition (6 kV AC).
Combustor	<ul style="list-style-type: none"> • alloy firing tube • silicon carbide firing tube • refractory block.

SPECIFICATIONS

Main specifications

Table 3.2 Thermjet performance data

PARAMETER	BURNER TYPE (VELOCITY)	BURNER SIZE				
		50	75	100	150	
High fire input (Btu/hr)	Medium & High velocity	500,000	750,000	1,000,000	1,500,000	
Low firing rate, on-ratio (Btu/hr)	Medium & High velocity	50,000	75,000	100,000	150,000	
Low firing rate, fixed air (Btu/hr)	Medium & High velocity	10,000	15,000	20,000	30,000	
Static air pressure ("w.c.) • 15% excess air, at maximum input with standard orifice plate installed, measured at tap A (See Figure 3.1)	High velocity	12.0	16.0	14.5	18.5	
	Medium velocity	7.5	8.0	7.5	9.5	
Static gas pressure ("w.c.) • at maximum input with standard orifice plate installed, measured at tap B (See Figure 3.1)	High velocity	11.0	15.5	16.0	16.5	
	Medium velocity	6.0	6.5	7.5	8.0	
Flame length (In) (from end of firing tube)	High velocity	Nat. gas	25	30.4	33	38
		Propane	33	34	34	42
		Butane	30	30	35	43
	Medium velocity	Nat. gas	28	28	38	43
		Propane	36	38	37	42
		Butane	39	30	42	40
Maximum flame velocity (ft/s) • 15% excess air, at maximum input	High velocity	500	500	500	500	
	Medium velocity	250	250	250	250	

- all information is given for general sizing purposes only
- refer to data sheet for burner specific information
- all inputs based on gross calorific values

Performance graphs

The graphs that follow give you an approximate picture of the performance. Should you want more exact information, contact Eclipse Combustion.

Figure 3.2 NO_x emissions

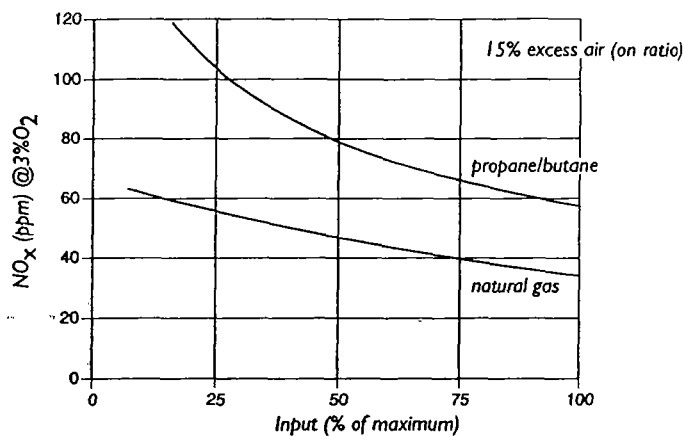

The emissions from the burner are influenced by:

- the fuel type
- the combustion air temperature
- the firing rate
- the chamber conditions
- the percent of excess air.

For estimates of other emissions, contact Eclipse Combustion.

Figure 3.3 Operational zone

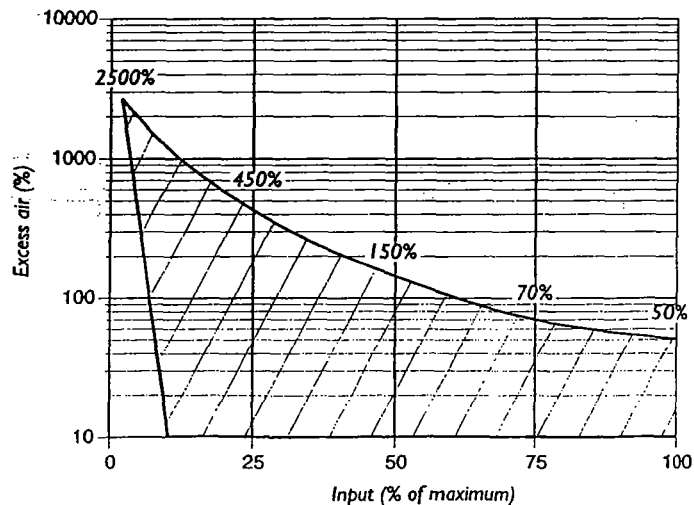

Orion Drawings:

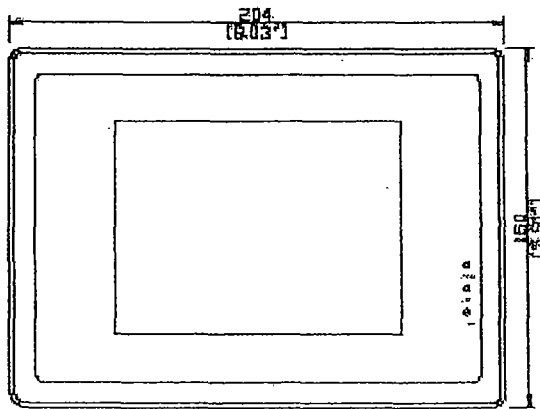

Front View

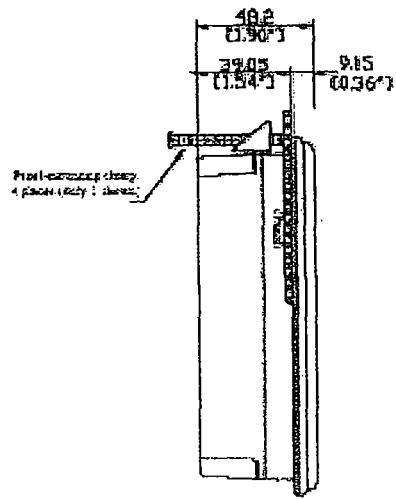

Side View

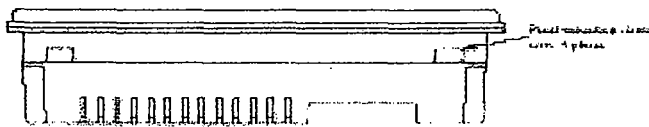

Bottom View

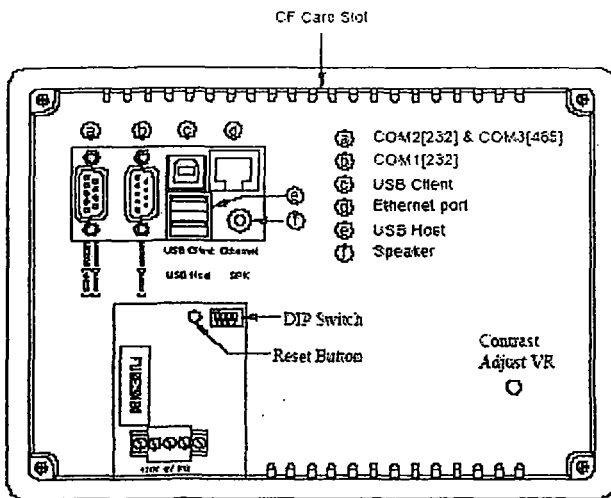

Rear View

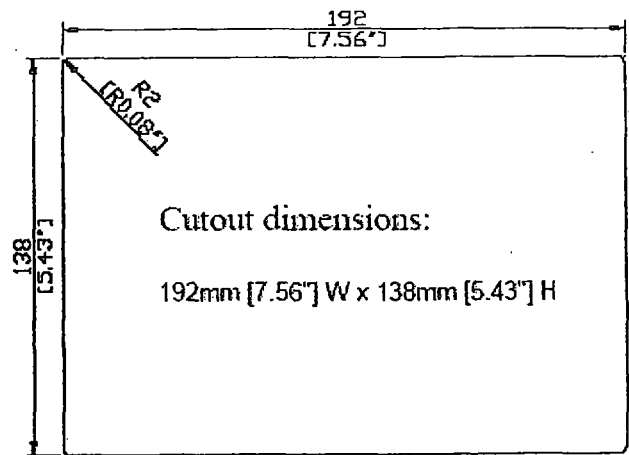

FUTUREDESIGN
CONTROLS

P.O Box 1196 * 7524 BridgeView, ILL 60455 * Phone: 888.751.5444 - Fax 888.245.2883

Power

24VDC - 500mA maximum current draw.

Display:

Display Type: STN Color LCD

Display Size: 5.7"

Max Colors: 4096

Resolution: 320 X 240

Pixel pitch (HxV,mm): 0.36 X 0.36

Luminance(cd/m²): 100

Storage Temp (C): -20 to 60

Operating Temp (C): 0 to 45

Backlight: 1 CCFL

Contrast Ratio: 30:1

Backlight life: Approx 40,000 hours

TouchScreen:

Type: 4 wire, analog resistive

Resolution: Continuous

Light transmission: above 80%

Life: 1 million activation minimal

Processor:

Type: Intel Xscale PXA255 200Mhz

Memory and OS:

Memory: 64MB of internal RAM

Operating System: Windows CE.net

Loop Interface:

Type: 300 series control/RS485 multi-drop interface

Max Loops: 20

Data Storage:

Type: 128 Mb compact flash

Connections:

Serial: Com1, 2 & 3 - RS232/RS485

Ethernet: 10 baseT

USB: 1 client - 2 host

Sound: 16 bit sound output

Physical:

Front Panel: Meets Nema4/IP65

Shock: 10 to 25Hz (X,Y,Z direction 2G, 30 mins)

Dimensions: 204" (H) x 150" (W) x 48" (D) - mm

Weight: 28.21.0 oz. (0.8 kg)

Orion interface ports (RS485, USB and Ethernet)

MicroSmart

The Next Generation of PLC

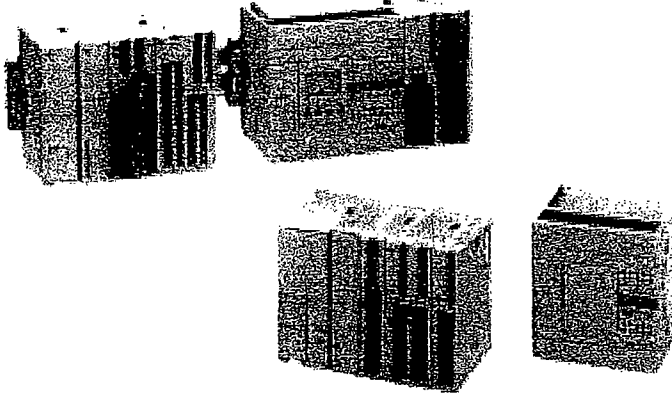

Key features of the MicroSmart series include:

- 10, 16, or 24 I/O All-in-one type CPU modules with Sink/Source DC input and Relay Output
- 20 I/O Slim type CPU modules with Sink/Source DC input and Transistor Sink or Source Output
- 20 I/O Slim type CPU modules with Sink/Source DC input and Relay Output with high-speed Transistor Sink or Source Output
- 40 I/O Slim type CPU modules with Sink/Source DC input and Transistor Sink or Source Output
- DC Input, Relay Output, Transistor Output, Combination I/O and Analog I/O expansion modules available
- 24 I/O All-in-one CPU expandable to 88 I/O points; 20 I/O slim types expandable up to 148 or 244 I/O; 40 I/O slim type expandable up to 264 I/O points
- Standard RS232 port, optional plug-in RS485/RS232 port
- Optional memory cartridge or real-time clock and calendar cartridge
- Data link to other MicroSmart modules, PLCs, PCs or HG series operator interfaces
- Approved for Class 1-Div. 2 hazardous locations (UL1604)
- Compact size
- Now available with AC input expansion module



UL Listed
File No. E211795



CE Certified

Pulse Output/Trapezoidal Control

Independent dual-axis control is available with two pulse outputs. Locational values can be easily defined for precise positional (trapezoidal) control.

- Pulse output instruction
- PWM instruction (Pulse Width Modulation control)

Pulse Output Function Specifications

Number of output points	2
Maximum output frequency	20 kHz

*Only one point of trapezoidal control is available.

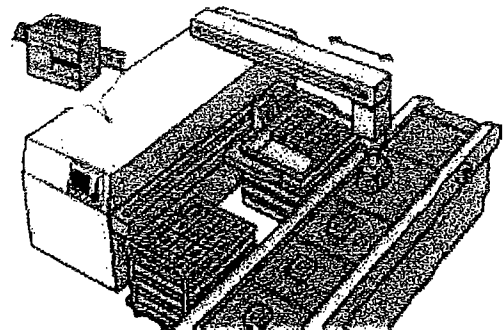

Programmable Logic Controllers

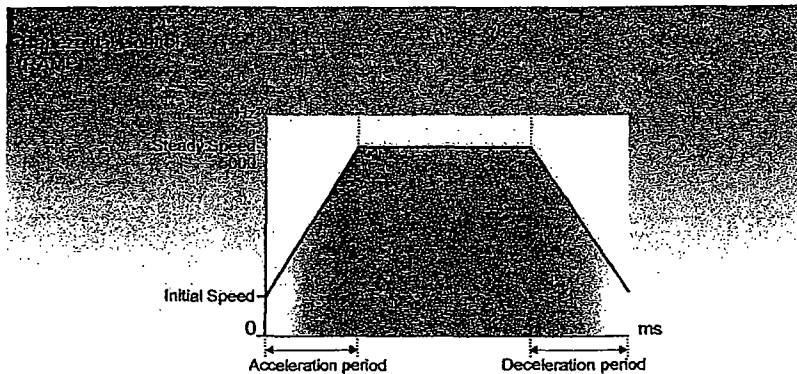

Setting the desired values enables you to precisely manage the trapezoidal control

Operation mode (S1)	1
Steady pulse frequency (S1 + 1)	50
Initial pulse frequency (S1 + 2)	10
Frequency change rate (S1 + 3)	2
Present value (S1 + 6, 7)	10,000

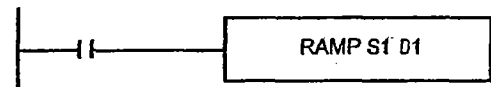

CPU and Module Combination Examples

All-In-One Type

- Attach Maximum 4 Expansion Modules
- Maximum I/O 88 points
- Only FC4A-C24R2/C24R2C CPU Module is expandable



The maximum number of relay outputs that can be turned on simultaneously is 33 points including relay outputs on the CPU module.

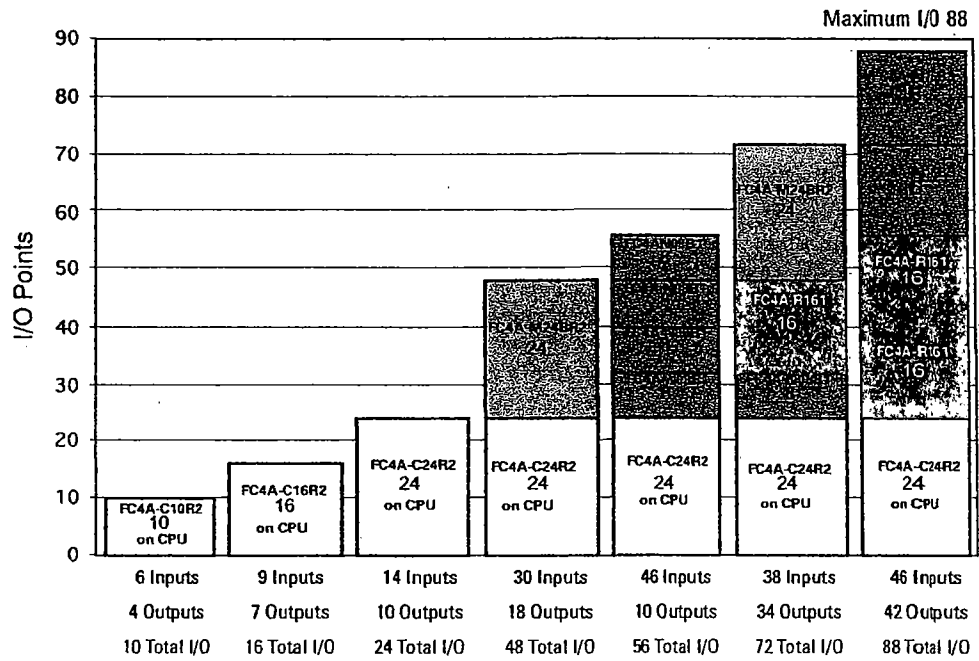

Slim Type



Programmable Logic Controllers

- Attach Maximum 7 Expansion Modules
- Maximum I/O
 - 148 points (D20K3, D20S3)
 - 244 points (D20RK1, D20RS1)
 - 264 points (D40K3, D40S3)



The maximum number of relay outputs that can be turned on simultaneously is 54 points including relay outputs on the CPU module.

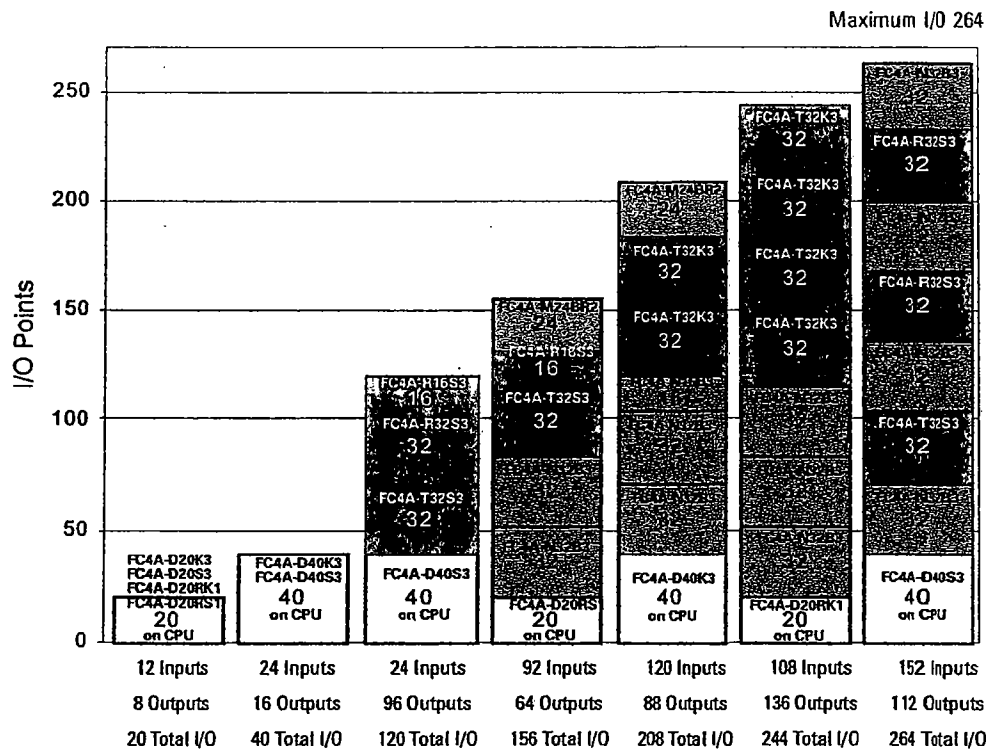

VISIBLE EMISSIONS ALARM (VEA)

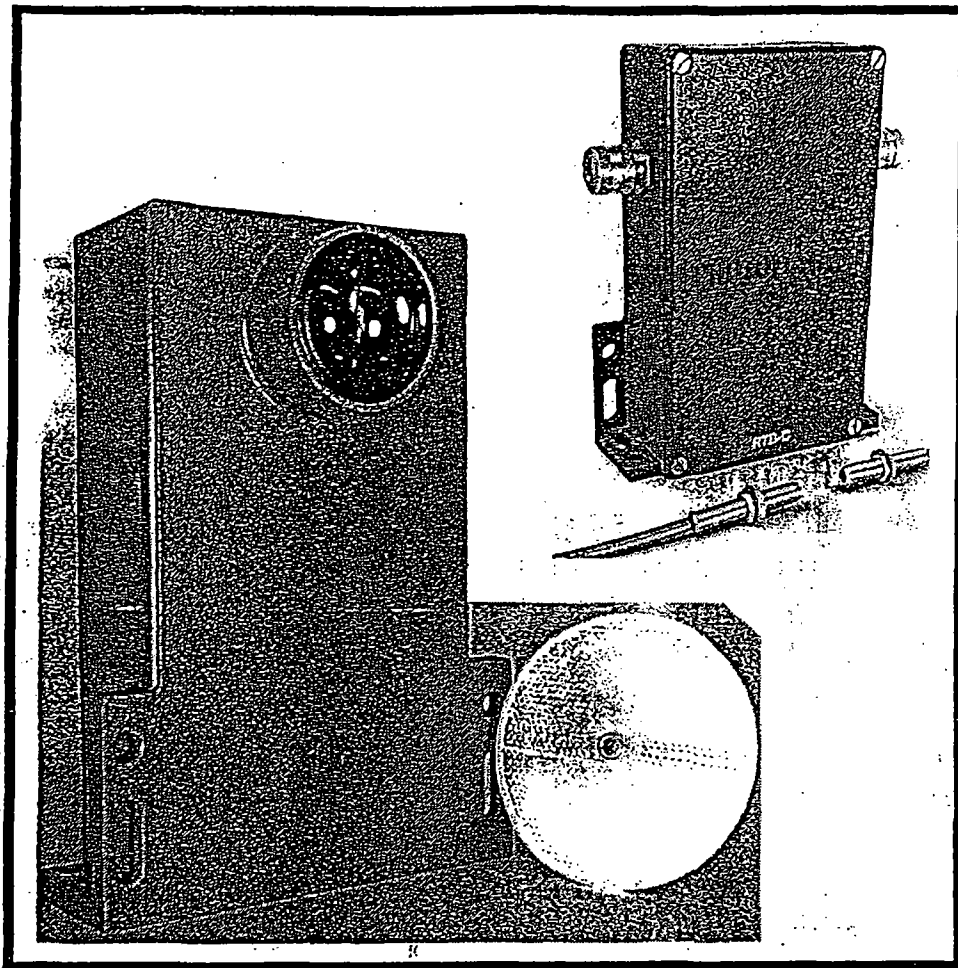

APPLICATION: Alarm and control for Opacity used on small and large sources for warning operators and shutting down systems based on opacity, haze or clarity.

- Proven Rugged Design
- Unaffected by Ambient Light
- Spans up to 6 Feet
- Visible LED Light Source
- Dual Beam or Single Beam
- Adjustable Delay up to 3 min.
- Easy to Install & Support
- External Adjustment

ECLIPSE TURBO BLOWERS

SERIES "SMJ"

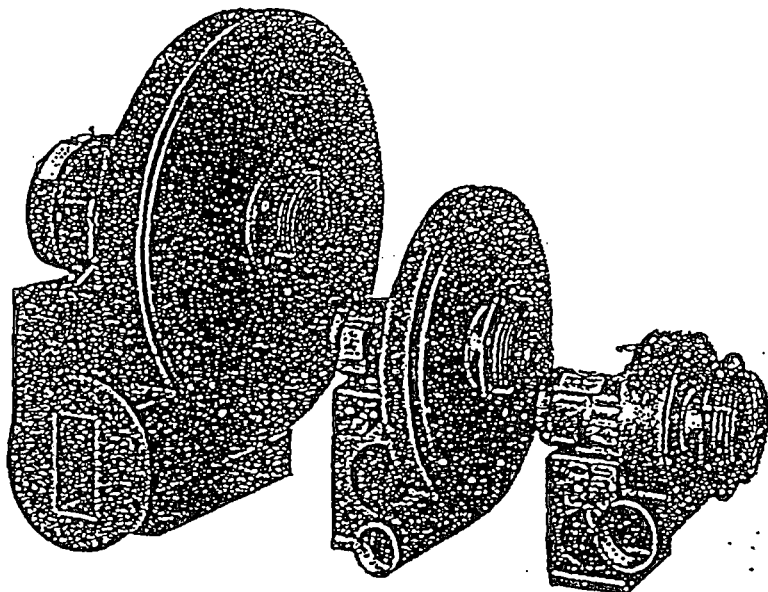

- High efficiency
- Heavy gauge steel base and housing
- Aluminum impellers balanced statically and dynamically
- Matching air filters available
- Changeable outlet positions

Eclipse "SMJ" Blowers are centrifugal blowers that provide low pressure air for industrial combustion systems. They are also used for cooling, conveying, drying, liquid agitation, smoke abatement, vacuum cleaning, fume and dust exhausting, and other applications where air temperatures are under 220°F.

All "SMJ" Blowers are constructed of continuous welded, heavy gauge steel. The impellers are made of lightweight, high strength, riveted aluminum. Outlets on 3" and 4" models are threaded, while all others are flanged for a standard 125# ANSI companion flange. Discharge ports are sized to keep pressure losses within reasonable limits.

Blower inlet flanges are equipped with a grill that complies with OSHA regulations. If desired, the grill may be removed and the inlet bolted to a standard ANSI companion flange. Eclipse-supplied motors are standard shaft and starting torque, ball bearing, 3600 rpm units. On any blower requiring 3/4 HP or more, Eclipse recommends that polyphase motors be used.

There are four possible outlet positions. Any existing position is easily changed by removing the housing from the

blower base and remounting it in the desired position. Positions 1 through 3 can be specified for any blower. Position 4, however, requires factory approval before ordering. Position 1 is the standard assembly (bottom, horizontal) unless otherwise specified.

"SMJ" Blowers can be supplied with counterclockwise (CCW) or clockwise (CW) rotation as viewed from the motor side. CCW rotation is furnished standard unless otherwise specified.

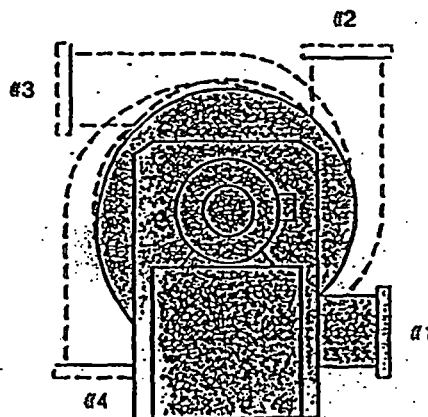

Outlet Positions

Table 5.5-5
ELEMENTAL CONTENT OF BODY FAT AND
BODY WATER

Component	Mass (g)	Carbon Quantity* (g)	Hydrogen Quantity* (g)	Oxygen Quantity* (g)
Body fat	13,500	1.0E + 4	1.6E + 3	1.5E + 3
Essential	1,500	1.2E + 3	1.8E + 2	1.7E + 2
Nonessential	12,000	9.2E + 3	1.4E + 3	1.3E + 3
Body water	42,000		4.6E + 3	3.7E + 4
Extracellular	18,000		20.E + 3	1.6E + 4
Intracellular	24,000		2.6E + 3	2.1E + 4

* For sources, see Reference 1.

From Snyder, W. S., Cook, M. J., Karhausen, L. R., Nasset, E. S., Howells, G. P., and Tipton, I. H., *Report of the Task Force on Reference Man*. ICRP Report No. 23, International Commission on Radiological Protection, Pergamon Press, Oxford, 1975, 1. With permission.

Table 5.5-6
REFERENCE MAN: TOTAL BODY CONTENT FOR SOME ELEMENTS

Element	Amount (g)	Percent of total body weight	Element	Amount (g)	Percent of total body weight
Oxygen	43,000	61	Lead	0.12	0.00017
Carbon	16,000	23	Copper	0.072	0.00010
Hydrogen	7,000	10	Aluminum	0.061	0.00009
Nitrogen	1,800	2.6	Cadmium	0.050	0.00007
Calcium	1,000	1.4	Boron	<0.048	0.00007
Phosphorus	780	1.1	Barium	0.022	0.00003
Sulfur	140	0.20	Tin	<0.017	0.00002
Potassium	140	0.20	Manganese	0.012	0.00002
Sodium	100	0.14	Iodine	0.013	0.00002
Chlorine	95	0.12	Nickel	0.010	0.00001
Magnesium	19	0.027	Gold	<0.010	0.00001
Silicon	18	0.026	Molybdenum	<0.0093	0.00001
Iron	4.2	0.006	Chromium	<0.0018	0.000003
Fluorine	2.6	0.0037	Cesium	0.0015	0.000002
Zinc	2.3	0.0033	Cobalt	0.0015	0.000002
Rubidium	0.32	0.00046	Uranium	0.00009	0.0000001
Strontium	0.32	0.00046	Beryllium	0.000036	
Bromine	0.20	0.00029	Radium	3.1×10^{-11}	

From Snyder, W. S., Cook, M. J., Karhausen, L. R., Nasset, E. S., Howells, G. P., and Tipton, I. H., *Report of the Task Group on Reference Man*, ICRP Report No. 23, International Commission on Radiological Protection, Pergamon Press, Oxford, 1975, 1. With permission.

**EMISSIONS TESTING
of the
FIRST CALL CREMATORY
B & L CREMATION SYSTEMS, INC. N20 SERIES
HUMAN CREMATORY
Clearwater, Florida**

April 5, 2008

FDEP Permit No. 1030473-008AG
EU No. 008
SES Reference No. 08S131

Conducted by:

SOUTHERN ENVIRONMENTAL SCIENCES, INC.
1204 North Wheeler Street
Plant City, Florida 33566
Phone (831) 752-5014, Fax (813)752-2475

Project Participants

Byron E. Nelson
Mark S. Gierke
Dale A. Wingler
Travis B. Nelson

SPECIAL EMISSIONS

EMISSION TESTING
of the
FIRST CALL CREMATORY
B & L CREMATION SYSTEMS, INC. N20 SERIES
HUMAN CREMATORY
Clearwater, Florida

April 5, 2008

TABLE OF CONTENTS

1.0	INTRODUCTION.....	1
2.0	SUMMARY OF RESULTS.....	1
3.0	PROCESS DESCRIPTION.....	1
4.0	SAMPLING PROCESDURES.....	4
	4.1 Methods.....	4
	4.2 Sampling Locations.....	5
	4.3 Sampling Trains.....	5
	4.4 Sample Collection.....	12
	4.5 Sample Recovery.....	12
5.0	ANALYTICAL PROCEDURE.....	14
	5.1 Pretest Preparation.....	14
	5.2 Analysis.....	14
	APPENDIX.....	15
	Project Participants	
	Certification	
	Visible Emissions Evaluation	
	Process Operational Data	
	Laboratory Data	
	Field Data Sheets	
	Analyzer Strip Charts	
	Calibration Data	
	Calculations and Symbols	

1.0 INTRODUCTION

Southern Environmental Sciences, Inc. conducted emissions testing of the First Call Crematory, B & L Cremation Systems, Inc. N20 Series human crematory on April 5, 2008. This facility is located at 12660 34th Street North, Clearwater, Florida. Testing was conducted for particulates, carbon monoxide (CO), sulfur dioxide (SO₂), nitrogen oxides (NO_x), total hydrocarbons (VOC) and visible emissions. Oxygen (O₂) concentrations were measured to correct emission rates to 7% O₂. Mr. Jose Rodriguez of the Pinellas County Department of Environmental Management was present as an observer during a portion of the testing.

2.0 SUMMARY OF RESULTS

Results of the particulate, carbon monoxide, sulfur dioxide, nitrogen oxides and total hydrocarbons are summarized in Table 1. A visible emissions evaluation was performed over a one hour period. The average maximum six minute opacity was zero percent.

3.0 PROCESS DESCRIPTION

The B & L Cremation Systems N20 Series crematory incinerator cremates human remains in an environmentally acceptable manner. The unit consists of a primary and secondary (afterburner) chamber each fired with natural gas. The unit is designed to incinerate human remains at a rate of 150 pounds per hour with a maximum heat input rate of 1.5 MMBTU per hour (primary chamber 0.5 MMBTU per hour, secondary chamber 1.0 MMBTU per hour).

TABLE 1. EMISSIONS TEST SUMMARY**Company: FIRST CALL CREMATORY****Source: B & L Cremation Systems, Inc.****N20 Series Human Crematory**

	Run 1	Run 2	Run 3
Date of Run	4/5/08	4/5/08	4/5/08
Weight of Human Remains (lbs.)	170	165	140
Start Time (24-hr. clock)	1005	1348	1722
End Time (24-hr. clock)	1107	1452	1824
Vol. Dry Gas Sampled Meter Cond. (DCF)	39.324	47.848	41.832
Gas Meter Calibration Factor	0.994	0.994	0.994
Barometric Pressure at Barom. (in. Hg.)	30.39	30.29	30.39
Elev. Diff. Manom. To Barom. (ft.)	0	0	0
Vol. Liquid Collected Std. Cond. (SCF)	3.305	5.073	2.966
Moisture in Stack Gas (% Vol.)	7.8	9.9	8.6
Molecular Weight Wet Stack Gas	28.48	28.17	28.62
Stack Gas Static Press. (in. H ₂ O gauge)	-0.03	-0.03	-0.03
Average Square Root Velocity Head	0.166	0.208	0.187
Average Orifice Differential (in. H ₂ O)	1.132	1.669	1.291
Average Gas Meter Temperature (°F)	81.5	88.3	91.7
Average Stack Gas Temperature (°F)	834.3	1013.6	998.3
Pilot Tube Coefficient	0.84	0.84	0.84
Stack Gas Vel. Stack Cond. (ft./sec.)	16.78	19.88	17.65
Effective Stack Area (sq. ft.)	1.87	1.87	1.87
Stack Gas Flow Rate Std. Cond. (DSCFM)	623	715	659
Stack Gas Flow Rate Stack Cond. (ACFM)	1,833	2,202	1,977
Net Time of Run (min.)	60	60	60
Nozzle Diameter (in.)	0.600	0.600	0.600
Percent Isokinetic	98.7	102.6	97.6

TABLE 1. EMISSIONS TEST SUMMARY (con't)

Company: FIRST CALL CREMATORY
Source: B&L Cremation Systems, Inc.
 N20 Series Human Crematory

	Run 1	Run 2	Run 3	
Date of Run	4/5/08	4/5/08	4/5/08	
Weight of Human Remains (lbs.)	170	165	140	
Start Time (24 hr. clock)	1005	1348	1722	
End Time (24 hr. clock)	1107	1452	1824	
Oxygen (%)	12.7	12.1	13.1	
Particulate Collected (mg.)	27.0	69.1	99.2	
			(Avg.)	
Particulate Emissions (gr./DSCF)	0.011	0.023	0.038	0.024
Particulate Emissions (gr./DSCF @ 7% O ₂)	0.018	0.036	0.066	0.040
Particulate Emissions (lb./hr.)	0.06	0.14	0.21	0.136
CO Emissions (ppm)	3.05	2.27	4.98	3.43
CO Emissions (ppm @ 7% O ₂)	3.4	2.95	6.7	4.35
CO Emissions (lb./hr.)	0.007	0.006	0.018	0.010
NO _x Emissions (ppm)	110.23	122.3	115.7	116.1
NO _x Emissions (lb./hr.)	0.58	0.71	0.74	0.677
VOC Emissions (ppm)	1.5	0.80	1.41	1.237
VOC Emissions (lb./hr.)	0.007	0.004	0.009	0.007
SO ₂ Collected (mg)	33.1	49.4	59.7	47.4
SO ₂ Emissions (lb./hr.)	0.088	0.142	0.167	0.13

Note: Standard conditions 68°F, 29.92 in. Hg

1.0 MMBTU/hr.). Emissions are controlled by the afterburner that is preheated and maintained at a minimum operating temperature of 1600°F prior to and during ignition of the primary chamber. Process operational data was provided by facility personnel and is included in the appendix.

4.0 SAMPLING PROCEDURES

4.1 Methods

All sampling was performed using methods currently acceptable to the FDEP. All test methods are contained in Title 40 of the Code of Federal Regulations, Appendix A and are as follows:

<u>Pollutant</u>	<u>EPA Method No.</u>	<u>Title</u>
Particulates	5	Determination of Particulate Emissions from Stationary Sources
Carbon Monoxide	10	Determination of Carbon Monoxide Emissions from Stationary Sources
Oxygen	3B	Gas analysis for the Determination of Emissions Rate Correction Factor or Excess Air
Nitrogen Oxides	7E	Determination of Nitrogen Oxides Emissions from Stationary Sources (Instrumental Analyzer Procedure)
Sulfur Dioxide	6	Determination of Sulfur Dioxide Emissions from Stationary Sources, Section 2.1
Total Hydrocarbons	25A	Determination of Total Gaseous Organic Concentration Using a Flame Ionization Analyzer
Visible Emissions	9	Visual Determination of the Opacity of Emissions of Stationary Sources.

Sulfur dioxide emissions were determined simultaneous with particulates as per Section 6.1 of EPA Method 6.

4.2 Sampling Locations

Locations of the sample ports and stack dimensions are shown in Figure 1.

Particulate/SO₂ sampling was accomplished by conducting horizontal traverses through each of two ports located on the stack at a ninety degree angle from one another. Twenty four sample points were chosen in accordance with EPA Method 1 – Sample and Velocity Traverses for Stationary Sources, 40 CFR 60, Appendix A. Carbon monoxide, nitrogen oxides, total hydrocarbon and oxygen sampling were performed from the same sampling ports as the particulate/SO₂ sampling.

4.3 Sampling Trains

The particulate/SO₂ sampling train consisted of a 3 foot Inconel probe utilizing a one piece quartz glass nozzle and liner, a heated glass fiber filter and four impingers arranged as shown in Figure 2. Flexible tubing was used between the heated filter and the impingers. The first impinger was charged with 100 milliliters of 80% isopropanol, the second and third impingers were each charged with 100 milliliters of a 3% percent hydrogen peroxide solution and the fourth impinger was charged with indicating silica gel desiccant. The impingers were cooled in an ice and water bath during sampling. A Nutech Corporation control console was used to monitor the gas flow rates and stack conditions during sampling.

The carbon monoxide sampling train consisted of a stainless steel probe, Teflon sample line, condenser, silica gel and carbon dioxide adsorbent tubes and a Thermo Environmental Instruments, Inc. Model 48 Gas Filter Correlation CO analyzer arranged as shown in Figure 3.

The nitrogen oxides sampling train consisted of a stainless steel probe, Teflon sample line, and a California Analytical Inc. Model 300 FID analyzer arranged as shown in Figure 5.

The oxygen sampling train consisted of a probe, sample line, tedlar bag in a rigid container, valve, vacuum pump, and flow meter.

4.4 Sample Collection

Prior to particulate/SO₂ sampling, the pitot tubes were checked for leaks and the manometers were zeroed. A pretest leak check of the sampling train was conducted by sealing the nozzle and applying a 15" Hg vacuum. A leak rate of less than 0.02 cubic feet per minute was considered acceptable. Sample was collected isokinetically for two and one half minutes at each of the points sampled.

All instrumental analyzers were calibrated immediately prior to the beginning and checked after each run by introducing known gases into the instrument through the sampling.

The tedlar bag used for obtaining an integrated oxygen sample was leak checked prior to the test by pressurizing it to 2 to 4 in. H₂O and allowing it to stand overnight. The bag was considered leak free if it remained inflated. A one hour integrated sample was obtained at a rate 0.5 liters per minute for each run.

All sampling was conducted simultaneously.

4.5 Sample Recovery

A post test leak check of the particulate/SO₂ sampling train was performed at the completion of each run by sealing the nozzle and applying a vacuum equal to or greater than the maximum value reached during the sample period. A leak rate of less than 0.02 CFM or 4 percent of the average sampling rate (whichever was less) was considered acceptable. The probe was then disconnected, the ice bath was drained and the remaining part of the sampling train was purged by drawing charcoal filtered air through the system for fifteen minutes at the average flow rate used during sampling. The nozzle and probe were then brushed and rinsed with reagent grade acetone and the washings were placed in clean polyethylene containers and sealed. The glass fiber filter was removed from the holder with forceps and placed in a covered Petri dish for return to the laboratory. The front half of the filter holder was rinsed with acetone and the washings were added to the nozzle and probe wash. The contents of impingers 1 through 3 were measured volumetrically and the silica gel in the fourth impinger was weighed to the nearest 0.1 gram for determination of moisture content. The 80 percent isopropanol in the first

impinger was discarded and the impinger was rinsed with deionized, distilled water. The 3 percent hydrogen peroxide in the second and third impingers was placed in a clean polyethylene sample bottle. The impingers, associated glassware and back half of the filter holder were then rinsed with de-ionized, distilled water which was added to the sample bottle.

Two calculations of the moisture content of the stack gas were made for each run, one from the impinger analysis and one from the assumption of saturated conditions based upon the average stack gas temperature and a psychrometric chart as described in EPA Method 4, Determination of Moisture Content in Stack Gases, 40 CFR 60, Appendix A. The lower of the two values of moisture content was considered to be correct and was used in the emissions computations.

5.0 ANALYTICAL PROCEDURE

5.1 Pretest Preparation

The glass fiber filters for the particulate train were numbered, oven dried at 105°C for two to three hours, desiccated and weighed to a constant weight in preparation for the test. Results were recorded to the nearest 0.1 milligram. Filters were loaded into holders and a filter was set aside as a control blank. The impingers were charged as described in section 4.3 and the contents of the fourth impinger were weighed to the nearest 0.1 gram. The 3 percent hydrogen peroxide solution for the sulfur dioxide sampling was prepared the morning of the test from 30 percent reagent grade stock solution.

5.2 Analysis

Upon return to the laboratory, the particulate filters were removed from the containers with forceps, dried at 105°C for two to three hours, desiccated and weighed to a constant weight. Results were recorded to the nearest 0.1 milligram. The probe and nozzle washes and an acetone blank were measured volumetrically and transferred to clean, tared evaporating dishes and evaporated to dryness over low heat. The evaporating dishes were then oven dried at 105°C for two to three hours, desiccated and weighed to a constant weight. Results were recorded to the nearest 0.1 milligram. The total particulate reported is the sum of the filter weight gain and the weight gain of the evaporating dishes, corrected for the acetone blank. The impinger solutions were analyzed for sulfur dioxide procedures specified in Section 4.3 of EPA Method 8.

PROJECT PARTICIPANTS AND CERTIFICATION

**FIRST CALL CREMATORY
B & L CREMATION SYSTEMS, INC. N20 SERIES
HUMAN CREMATORY
Clearwater, Florida**

April 5, 2008

Project Participants:

Marke S. Gierke
Byron E. Nelson
Dale A. Wingle
Travis B. Nelson

Kenneth M. Roberts

Certification:

I certify that to my knowledge all data submitted in this report is true and correct.

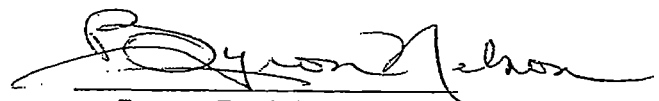
Byron E. Nelson, CIH

Southern Environmental Sciences, Inc.

1204 North Wheeler Street □ Plant City, Florida 33563 □ (813) 752-5014, Fax (813) 752-2475

VISIBLE EMISSIONS EVALUATION

COMPANY <i>FIRST Call Crematory</i>	
UNIT <i>N20 AA Crematory Incinerator</i>	
ADDRESS <i>12660 34th St. N #A-1</i> <i>Clearwater, FL</i>	
PERMIT NO. <i>1030473-003-AG</i>	COMPLIANCE? YES <input checked="" type="checkbox"/> NO <input type="checkbox"/>
AIRS NO. <i>1030473</i>	EU NO. <i>001</i>
PROCESS RATE <i>160 lb Body</i>	PERMITTED RATE <i>Adult size body - (150 lb/hr)</i>
PROCESS EQUIPMENT <i>B&L N20AA Crematory Incinerator</i>	
CONTROL EQUIPMENT <i>Afterburner</i>	
OPERATING MODE <i>Mt. Gas Fired</i>	AMBIENT TEMP. (° F) START <i>85</i> STOP <i>85</i>
HEIGHT ABOVE GROUND LEVEL START <i>230'</i> STOP <i>same</i>	HEIGHT RELATIVE TO OBSERVER START <i>230'</i> STOP <i>same</i>
DISTANCE FROM OBSERVER START <i>290'</i> STOP <i>same</i>	DIRECTION FROM OBSERVER START <i>50°</i> STOP <i>50°</i>
EMISSION COLOR <i>NONE</i>	PLUME TYPE <i>N/A</i> CONTIN. <input type="checkbox"/> INTERMITTENT <input type="checkbox"/>
WATER DROPLETS PRESENT? NO <input checked="" type="checkbox"/> YES <input type="checkbox"/>	IS WATER DROPLET PLUME ATTACHED <input type="checkbox"/> DETACHED <input checked="" type="checkbox"/> <i>N/A</i>
POINT IN PLUME AT WHICH OPACITY WAS DETERMINED START <i>Stack Exit</i> STOP <i>same</i>	
DESCRIBE BACKGROUND START <i>SKY</i> STOP <i>sky</i>	
BACKGROUND COLOR START <i>light</i> STOP <i>same</i>	SKY CONDITIONS START <i>scattered</i> STOP <i>same</i>
WIND SPEED (MPH) START <i>0-10</i> STOP <i>same</i>	WIND DIRECTION START <i>Var.</i> STOP <i>Var.</i>
AVERAGE OPACITY FOR HIGHEST PERIOD <i>0%</i>	RANGE OF OPACITY READINGS MIN. <i>0</i> MAX. <i>0</i>

SOURCE LAYOUT SKETCH Draw North Arrow

Comments

OBSERVATION DATE		START TIME		STOP TIME					
<i>4/5/08</i>		<i>1348</i>		<i>1448</i>					
SEC					SEC				
	MIN	0	15	30		45	MIN	0	15
0	0	0	0	0	30	0	0	0	0
1	0	0	0	0	31	0	0	0	0
2	0	0	0	0	32	0	0	0	0
3	0	0	0	0	33	0	0	0	0
4	0	0	0	0	34	0	0	0	0
5	0	0	0	0	35	0	0	0	0
6	0	0	0	0	36	0	0	0	0
7	0	0	0	0	37	0	0	0	0
8	0	0	0	0	38	0	0	0	0
9	0	0	0	0	39	0	0	0	0
10	0	0	0	0	40	0	0	0	0
11	0	0	0	0	41	0	0	0	0
12	0	0	0	0	42	0	0	0	0
13	0	0	0	0	43	0	0	0	0
14	0	0	0	0	44	0	0	0	0
15	0	0	0	0	45	0	0	0	0
16	0	0	0	0	46	0	0	0	0
17	0	0	0	0	47	0	0	0	0
18	0	0	0	0	48	0	0	0	0
19	0	0	0	0	49	0	0	0	0
20	0	0	0	0	50	0	0	0	0
21	0	0	0	0	51	0	0	0	0
22	0	0	0	0	52	0	0	0	0
23	0	0	0	0	53	0	0	0	0
24	0	0	0	0	54	0	0	0	0
25	0	0	0	0	55	0	0	0	0
26	0	0	0	0	56	0	0	0	0
27	0	0	0	0	57	0	0	0	0
28	0	0	0	0	58	0	0	0	0
29	0	0	0	0	59	0	0	0	0

OBSERVER: *Mark Gierke*

Certified by: *FRP* thru *EA* Certif. # _____ Certified at: *Tampa, FL*

Date Certified: *2/08* Exp. Date: *8/08*

I certify that all data provided to the person conducting the test was true and correct to the best of my knowledge:

Signature: *See process wt. statement*

Title: _____

Process Weight Statement

DATE 4/5/08 SAMPLING TIME: FROM 10:05 A.M. TO 6:24 P.M.

STATEMENT OF PROCESS WEIGHT

COMPANY	First Call Crematory.
MAILING ADDRESS	12660 34 TH ST. N. CLEARWATER FL
SOURCE IDENTIFICATION	B&L Systems N-20 Series Crematory.
SOURCE LOCATION	12660 34 TH ST. N. CLEARWATER FL

DATA ON OPERATING CYCLE TIME

START OF OPERATION, TIME	
END OF OPERATION, TIME	
ELAPSED TIME	
IDLE TIME DURING CYCLE	
DESIGN PROCESS RATING	PROCESS WEIGHT RATE (INPUT) 150 lb/hr
	PRODUCT (OUTPUT)

DATA ON ACTUAL PROCESS RATE DURING OPERATION CYCLE

MATERIAL	Human remains	RATE	160 lbs (Run 1)
MATERIAL	" "	RATE	155 lbs (Run 2)
MATERIAL	" "	RATE	140 lbs (Run 3)
AVERAGE PROCESS WEIGHT		RATE	
PRODUCT		RATE	
PRODUCT		RATE	
PRODUCT		RATE	

I certify that the above information is true and correct to the best of my knowledge.
Name (Please Print)

Signature _____

Title operator.

SOUTHERN ENVIRONMENTAL SCIENCES, INC.

PARTICULATE MATTER COLLECTED

PLANT: FIRST CALL CREMATORY
 UNIT NO.: B & L CREMATION SYSTEMS, INC. - N20 SERIES HUMAN CREMATORY
 TEST DATE: 4/5/08

ANALYZED BY: MG

Acetone blank container no.	405	Filter blank no.	6752
Acetone blank volume, ml., (VA)	200	Filter blank tare weight, g.	0.3402
Acetone blank final weight, g.	101.0509	Filter blank final weight, g.	0.3409
Acetone blank tare weight, g.	101.0507	Filter weight diff., g.	0.0007
Acetone blank weight diff., g. (ma)	0.00012		

Run No. 1

Filter No. 6768

Liquid lost during transport 0

Acetone wash volume, ml (Vaw) 100

Acetone wash residue, g.(Wa) 0.0001

Acetone wash container no. 4

Container Number	Weight of Particulate Collected		
	Final Weight	Tare Weight	Weight Gain
1 (Filter)	0.3603	0.3434	0.0169
2 (Wash)	103.1076	105.6522	0.0102
Total			0.0271
Less acetone blank, g. (Wa)			0.0001
Weight of particulate matter, g			0.0270

Run No. 2

Filter No. 6770

Liquid lost during transport, ml. 0

Acetone wash container no. 18

Acetone wash volume, ml (Vaw) 125

Acetone wash residue, g.(Wa) 0.0001

Container Number	Weight of Particulate Collected		
	Final Weight	Tare Weight	Weight Gain
1 (Filter)	0.3972	0.3391	0.0581
2 (Wash)	105.6633	105.6522	0.0111
Total			0.0692
Less acetone blank, g. (Wa)			0.0001
Weight of particulate matter, g			0.0691

Run No. 3

Filter No. 6769

Liquid lost during transport, ml. 0

Acetone wash container no. 53

Acetone wash volume, ml (Vaw) 130

Acetone wash residue, g.(Wa) 0.0001

Container Number	Weight of Particulate Collected		
	Final Weight	Tare Weight	Weight Gain
1 (Filter)	0.4182	0.3373	0.0362
2 (Wash)	100.6350	100.6166	0.0184
Total			0.0993
Less acetone blank, g. (Wa)			0.0001
Weight of particulate matter, g			0.0992

SOUTHERN ENVIRONMENTAL SCIENCES, INC.

MOISTURE COLLECTED

Plant FIRST COIL CREMATORY

Unit NZOAA CREMATORY

Date 4/5/08

Run No. 1

Impinger Number	1	2	3	4	Weighed by:
Final Weight (g):	<u>160.0</u>	<u>104.0</u>	<u>0</u>	<u>259.4</u>	<u>DW</u>
Initial Weight (g):	<u>100.0</u>	<u>100.0</u>	<u>0</u>	<u>253.3</u>	<u>DW</u>
Difference (g):	<u>60.0</u>	<u>4.0</u>	<u>0</u>	<u>6.1</u>	
Total Condensate (g):				<u>70.1</u>	

Unit CREMATORY

Date 4/5/08

Run No. 2

Impinger Number	1	2	3	4	Weighed by:
Final Weight (grams)	<u>195.0</u>	<u>105.0</u>	<u>0</u>	<u>266.8</u>	<u>DW</u>
Initial Weight (grams)	<u>100.0</u>	<u>100.0</u>	<u>0</u>	<u>259.2</u>	<u>DW</u>
Difference (grams)	<u>95.0</u>	<u>5.0</u>	<u>0</u>	<u>7.6</u>	
Total Condensate (grams)				<u>107.6</u>	

Unit CREMATORY

Date 4/5/08

Run # 3

Impinger Number	1	2	3	4	Weighed by:
Final Weight	<u>144.0</u>	<u>110.0</u>	<u>0</u>	<u>263.2</u>	<u>DW</u>
Initial Weight (grams)	<u>100.0</u>	<u>100.0</u>	<u>0</u>	<u>254.3</u>	<u>DW</u>
Difference (grams)	<u>44.0</u>	<u>10.0</u>	<u>0</u>	<u>8.9</u>	
Total Condensate (grams)				<u>62.9</u>	

SOUTHERN ENVIRONMENTAL SCIENCES, INC.
GAS ANALYSIS DATA FORM

Plant: <u>Forest Hill Crematory</u>	
Unit: <u>N-20 AA Crematory</u>	Test No.: <u>1</u>
Date: <u>4/5/08</u>	Sampling Loc.: <u>Stack</u>
Sampling Time (24 hr. clock) <u>10:05 - 11:05</u>	
Sampling Type: Continuous <input type="checkbox"/> Integrated Bag <input checked="" type="checkbox"/> Grab <input type="checkbox"/>	
Analytical Method <u>Orsat</u>	Ambient Temp. <u>75</u>
Operator <u>Me</u>	

RUN→	1		2		3		Average Net Volume	Multiplier	Molecular Weight of Stack Gas (Dry Basis (MD))
	Actual Reading	Net	Actual Reading	Net	Actual Reading	Net			
CO ₂	5.4	5.4	5.5	5.5	5.5	5.4		.44	
O ₂ (Net is Actual O ₂ Reading minus actual CO ₂ Reading)	18.0	12.6	18.2	12.7	18.1	12.7		.32	
CO (Net is Actual CO Reading minus actual O ₂ Reading)								.28	
N ₂ (Net is 1000 minus actual CO Reading)								.28	
								TOTAL	

SOUTHERN ENVIRONMENTAL SCIENCES, INC.
GAS ANALYSIS DATA FORM

Plant: <u>First Call Crematory</u>	
Unit: <u>N-20 PA Crematory</u>	Test No.: <u>2</u>
Date: <u>4/5/08</u>	Sampling Loc.: <u>Stack</u>
Sampling Time (24 hr. clock) <u>13:48 - 14:48</u>	
Sampling Type: Continuous <input type="checkbox"/> Integrated Bag <input checked="" type="checkbox"/> Grab <input type="checkbox"/>	
Analytical Method <u>Oxset</u>	Ambient Temp. <u>80</u>
Operator <u>MC</u>	

RUN→	1		2		3		Average NetVolume	Multiplier	Molecular Weight of Stack Gas(Dry Basis (MD))
	Actual Reading	Net	Actual Reading	Net	Actual Reading	Net			
GAS									
CO2	<u>5.1</u>	<u>5.1</u>	<u>5.1</u>	<u>5.1</u>	<u>5.0</u>	<u>5.0</u>		<u>.44</u>	
O2 (Net is Actual O2 Reading minus actual CO2 Reading)	<u>17.1</u>	<u>12.0</u>	<u>17.1</u>	<u>12.0</u>	<u>17.1</u>	<u>12.1</u>		<u>.32</u>	
CO (Net is Actual CO Reading minus actual O2 Reading)								<u>.28</u>	
N2 (Net is 1000 minus actual CO Reading)								<u>.28</u>	
								TOTAL	

SOUTHERN ENVIRONMENTAL SCIENCES, INC.
GAS ANALYSIS DATA FORM

Plant: <u>Prest Cell Brombery,</u>	
Unit: <u>N. To AA Brombery,</u>	Test No.: <u>3</u>
Date: <u>4/5/08</u>	Sampling Loc.: <u>Stack</u>
Sampling Time (24 hr. clock) <u>17:22-18:22</u>	
Sampling Type: Continuous <input type="checkbox"/> Integrated Bag <input checked="" type="checkbox"/> Grab <input type="checkbox"/>	
Analytical Method <u>crest</u>	Ambient Temp. <u>85</u>
Operator <u>MB</u>	

RUN→	1		2		3		Average NetVolume	Multiplier	Molecular Weight of Stack Gas(Dry Basis (MD))
	Actual Reading	Net	Actual Reading	Net	Actual Reading	Net			
CO2	5.6	5.6	5.4	5.4	5.5	5.5		.44	
O2 (Net is Actual O2 Reading minus actual CO2 Reading)	18.4	12.8	18.3	12.9	18.5	13.0		.32	
CO (Net is Actual CO Reading minus actual O2 Reading)								.28	
N2 (Net is 1000 minus actual CO Reading)								.28	
								TOTAL	

SOUTHERN ENVIRONMENTAL SCIENCES, INC.
Type S Pitot Tube Inspection Form

Pitot Tube ID No.	00.INC	
Inspection Date	4/1/2002	
Inspected By	M. Gierke	
Pitot Tube Assembly Level?	Yes	No
Pitot Tube Openings Damaged?	Yes (explain please)	No

ANGLE	MEASUREMENT	LIMITS
o1	1°	<10°
a2	1°	<10°
b1	1°	<5°
B2	1°	<5°
Y	1°	
0	2°	
A	.290 inches	
$z = A \sin Y$.010 inches	<1/8 inch
$w = A \sin 0$.021 inches	<1/32 inch
Pa	.145 inches	
Pb	.145 inches	
Dt	.190 inches	

COMMENTS

CALIBRATION REQUIRED	YES	No
----------------------	-----	----

GENTRY-MORRISON
FUNERAL HOMES
Southside Chapel
1727 Bartow Road • Lakeland, FL 33801

DEPARTMENT OF ENVIROMENTAL PROTECTION
RECEIPTS
P.O. BOX 3070
TALLAHASSEE, FLORIDA 32315-3070

(800)850-0114



1000



32315

U.S. POSTAGE
PAID
EATON PARK, FL
33840
JAN 25, 12
AMOUNT

\$2.50

00052167-07

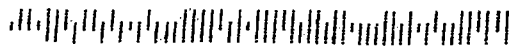

FIRST CLASS MAIL