

F&A RECEIPT 532278
MAR 26 2012

HUMAN CREMATORY
AIR GENERAL PERMIT REGISTRATION FORM

Part II. Notification to Permitting Office

(Detach and submit to appropriate permitting office; keep copy onsite)

Instructions: To give notice to the Department of an eligible facility's intent to use this air general permit, the owner or operator of the facility must detach and complete this part of the Air General Permit Registration Form and submit it to the appropriate Department of Environmental Protection or local air pollution control program office which has permitting authority. Please type or print clearly all information, and enclose the appropriate air general permit registration processing fee pursuant to Rule 62-4.050, F.A.C. (\$100 as of the effective date of this form)

Registration Type

0990699-001

Check one:

INITIAL REGISTRATION – Notification of intent to:

- Construct and operate a proposed new facility.
 Operate an existing facility not currently using an air general permit (e.g., a facility proposing to go from an air operation permit to an air general permit).

RE-REGISTRATION (for facilities currently using an air general permit) - Notification of intent to:

- Continue operating the facility after expiration of the current term of air general permit use.
 Continue operating the facility after a change of ownership.
 Make an equipment change requiring re-registration pursuant to Rule 62-210.310(2)(e), F.A.C., or any other change not considered an administrative correction under Rule 62-210.310(2)(d), F.A.C.

Surrender of Existing Air Operation Permit(s) - For Initial Registrations Only

If the facility currently holds one or more air operation permits, such permit(s) must be surrendered by the owner or operator upon the effective date of this air general permit. In such case, check the first box, and indicate the operation permits being surrendered. If no air operation permits are held by the facility, check the second box.

- All existing air operation permits for this facility are hereby surrendered upon the effective date of this air general permit; specifically permit number(s): _____
 No air operation permits currently exist for this facility.

General Facility Information

Facility Owner/Company Name (Name of corporation, agency, or individual owner who or which owns, leases, operates, controls, or supervises the facility.)

Zahn-Stow Funeral Home, Inc.

Site Name (Name, if any, of the facility site; e.g., Plant A, Metropolis Plant, etc. If more than one facility is owned, a registration form must be completed for each.)

Tillman Funeral Home

Facility Location (Provide the physical location of the facility, not necessarily the mailing address.)

Street Address: 2170 S. Military Trail

City: West Palm Beach

County: Palm Beach

Zip Code: 33415 -6443

Facility Start-Up Date (Estimated start-up date of proposed new facility.) (N/A for existing facility)

May- June 2012

Owner/Authorized Representative

Name and Position Title (Person who, by signing this form below, certifies that the facility is eligible to use this air general permit.)

Print Name and Title: Bradford P. Zahn, President

Owner/Authorized Representative Mailing Address

Organization/Firm: Zahn-Stow Funeral Home, Inc.

Street Address: 2170 S. Military Trail

City: West Palm Beach

County: Palm Beach

Zip Code: 33415

Owner/Authorized Representative Telephone Numbers

Telephone: (561)965-4412

Fax: (561)434-9615

Cell phone (optional):

Facility Contact (If different from Owner/Authorized Representative)

Name and Position Title (Plant manager or person to be contacted regarding day-to-day operations at the facility.)

Print Name and Title: Bradford Zahn, Owner

Facility Contact Mailing Address

Organization/Firm: Tillman Funeral Home

Street Address: 2170 S. Military Trail

City: West Palm Beach

County: Palm Beach

Zip Code: 33415

Facility Contact Telephone Numbers

Telephone: (561)965-4412

Fax: (561)434-9615

Cell phone (optional):

Owner/Authorized Representative Statement

This statement must be signed and dated by the person named above as owner or authorized representative

I, the undersigned, am the owner or authorized representative of the owner or operator of the facility addressed in this Air General Permit Registration Form. I hereby certify, based on information and belief formed after reasonable inquiry, that the facility addressed in this registration form is eligible for use of this air general permit and that the statements made in this registration form are true, accurate and complete. Further, I agree to operate and maintain the facility described in this registration form so as to comply with all applicable standards for control of air pollutant emissions found in the statutes of the State of Florida and rules of the Department of Environmental Protection and revisions thereof.

I will promptly notify the Department of any changes to the information contained in this registration form.

Bradford P Zahn

Signature

3-22-12

Date

Design Calculations

If this is an initial registration for a proposed new human crematory unit, provide design calculations to confirm a sufficient volume in the secondary chamber combustion zone to provide for at least a 1.0 second gas residence time at 1800 degrees F.

- Manufacturer's' design calculations attached. - See Attachment 1 for compliance test report
- Registration is not for proposed new human crematory unit(s).

Description of Facility

Below, or as an attachment to this form, provide a description of all crematory operations at the facility in sufficient detail to demonstrate the facility's eligibility for use of this air general permit and to provide a basis for tracking any future equipment or process changes at the facility. Describe all air pollutant-emitting processes and equipment at the facility, and identify any air pollution control measures or equipment used.

Equipment Description

The "Classic" is a multi-chamber unit having an average 150 - 200 lbs/hr fired with natural gas. The primary chamber burner is rated at 500,000 Btu/hr, and the secondary chamber burner is rated at 1,500,000 Btu/hr, for a total of 2,000,000 Btu/hr. Control of air pollution is achieved through the design of the "Classic" crematory, including its ability to operate the secondary chamber between 1600 - 1850 degrees Fahrenheit at a residence time in excess of 1.0 second. The design also includes fully automatic PLC based controls, independent fuel/air systems, preheated combustion air, secondary chamber temperature monitor and recorder, primary burner temperature interlock (prevents primary burner from firing prior to the secondary chamber reaching its set point temperature), UV continuous scanning flame detectors on burners, and an opacity sensor which can temporarily suspend operation of the primary chamber burner. In attachment 2 we have include a copy of the crematory spec.

Emissions Summary

Emission Summary and Calculations – Air pollution control is demonstrated through identical source stack testing. (see Attachment 1). See Attachment 3 for tabular summary of emissions. Criteria pollutant emissions values, except CO and PM are based on emission factors from AP-42, Table 2.1-12. The emission for CO and PM are derived from results of the identical source stack test.

Retention Time

The retention time was measured on an identical unit at 1.75 seconds at 1800^oF.

Attachment 1
Compliance Test Report

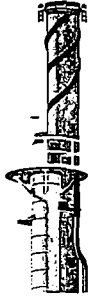

Arlington Environmental Services, Inc.

Post Office Box 657 ~ Okeechobee, Florida 34973
605 SW Park Street, Suite 209 ~ Okeechobee, Florida 34974
Telephone (863) 467-0555 ~ Facsimile (863) 357-0810
www.arlingtonenvironmental.com

U.S. Cremation Equipment
598 South Northlake Boulevard, Suite 1016
Altamonte Springs, FL 32701

RE: FID 0112701 – Guiding Light Cremations, LLC
Emission Testing Report
Make: US Cremation Equipment
Model: Classic

To Whom It May Concern:

Emission testing for Particulate, Visible, Carbon Monoxide, and Hydrogen Chloride, EPA Methods 1-5, 9, 10, and 26A, was conducted on March 3 & 4, 2010 at the above referenced facility. Upon request of the manufacturer the results from Methods 1-5, 10, and 26A have been corrected to twelve percent (12%) Carbon Dioxide and fifty percent (50%) Excess Air. In addition the results were corrected to seven percent (7%) Oxygen. These results are presented in the attached Emissions Report.

Sincerely,

Noah A. Handley, P.E.
Vice President, Principal Engineer,
Arlington Environmental Services, Inc.

**Source Test Report
for
Particulate, Visible, CO and HCl Emissions**

EPA Methods 1-5, 9, 10 and 26A

Report 2985-S

March 03 and 04, 2010

prepared for

**Guiding Light Cremations, LLC
Unit #2
Facility ID 0112701**



Arlington Environmental Services, Inc.

Post Office Box 657 ~ Okeechobee, Florida 34973 ~ Telephone 863.467.0555

Table of Contents

	<u>Page</u>
1.0 Introduction	1
2.0 Certification of Test Results.....	2
3.0 Allowable Emission Determination	3
4.0 Cyclonic Flow Determination.....	3
5.0 Summary of Results.....	4
6.0 Visible Emission Results.....	5
7.0 Particulate Emission Results.....	6
8.0 Carbon Monoxide Emission Results.....	7
9.0 Hydrochloric Acid Emission Results.....	8
10.0 Overview of Field and Analytical Procedures.....	9
10.1 EPA Method 1	9
10.2 EPA Method 2	9
10.3 EPA Method 3	9
10.4 EPA Method 4	10
10.5 EPA Method 5	10
10.6 EPA Method 9	11
10.7 EPA Method 10	11
10.8 EPA Method 26A	11
11.0 Sampling Point Determination.....	12
11.1 Number of Sampling Points per Traverse	13
12.0 Summary of Field and Laboratory Data.....	14
Attachment A - Field Data	
Attachment B - Laboratory Data	
Attachment C - Process Data	
Attachment D - Calculations for Run 1	
Attachment E - Calibration Data	
Attachment F - Project Participants	

1.0 Introduction

Guiding Light Cremations LLC operates a human crematory located at 2431 SW 56th Terrace in West Park, FL. On March 03 and 04, 2010, source tests for particulate, visible, carbon monoxide and HCl emissions (EPA Methods 1-5, 9, 10 and 26A) were conducted on Unit #2 exhaust stack servicing the Model: Classic Crematory, Manufactured by U.S. Cremations Equipment.

The tests were performed in order to comply with the Broward County Department of Planning and Environmental Protection, Air Quality Division, Chapter 27 Article IV, Air Quality, Section 27-179(c)(2). The results comply with Florida's Human Crematory Rule 62-296.401(5), FAC.

Courtney Pitters of the Broward County Division of Environmental Protection, Air Quality Division was present for a portion of the tests.

The retention time for this unit during the test was 1.75 seconds. The substantiating calculations are presented in Appendix D.

The results of this test verify compliance with the Code of Federal Regulations and Florida Department of Environmental Protection Human Crematory Rule 62-296.401(5), Florida Administrative Code.

2.0 Certification of Test Results

Facility Tested: Guiding Light Cremations LLC Report 2985-S
2431 SW 56th Terrace
West Park, FL 33325

Type Process - Human Crematory Abatement Device - Afterburner
March 03 and 04, 2010 Run Numbers 1, 2 and 3

Visible Emissions - 0.0%

Allowable Visible Emissions - 5% with up to 15% allowed in a one hour period

Particulate Emissions - 0.0159gr/dscf (corrected to 7% O₂)

Particulate Emissions - 0.0150 gr/dscf (corrected to 50% Excess Air)

Particulate Emissions - 0.0208 gr/dscf (corrected to 12% CO₂)

Allowable Particulate Emissions - 0.1 gr./dscf (corrected to 12% CO₂)

Carbon Monoxide Emissions - 0.86 ppm (corrected to 7% O₂)

Carbon Monoxide Emissions - 0.81 ppm (corrected to 50% Excess Air)

Allowable Carbon Monoxide Emissions - 500 ppm (corrected to 50% Excess Air)

Carbon Monoxide Emissions - 1.14 ppm (corrected to 12% CO₂)

HCl Emissions - 27.37 ppm (corrected to 7% O₂)

HCl Emissions - 25.99 ppm (corrected to 50% Excess Air)

HCl Emissions - 36.29 ppm (corrected to 12% CO₂)

All testing and analysis were performed in accordance with the Florida Department of Environmental Protection Human Crematory Rule 62-296.401(5), Florida Administrative Code.

I hereby certify that to my knowledge, all information and data submitted in this report is true and correct.



William D. Arlington

3.0 Allowable Emission Determination

The allowable emissions were determined in accordance with 62.296.401(5) F.A.C. Substantiating data and calculations are presented in the Appendix D.

4.0 Cyclonic Flow Determination

Due to the configuration of the system, cyclonic flow was considered to be non-existent at the sampling site.

5.0 Summary of Results
 Guiding Light Cremations, LLC
 Unit #2
 Report 2985-S

	Run 1	Run 2	Run 3	Average
Date	3/3/2010	3/4/2010	3/4/2010	
Start Time	16:20	9:30	11:00	
Stop Time	17:23	10:33	12:05	
Process Rate (lbs.)	175	180	—	178
Visible Emission Rate (%) (highest six minute average)				0.00
Allowable Visible Emission Rate (%) (with up to 20% for 3 min. per hour)				5
Particulate Emission Rate (gr./ dscf @ 7% O ₂)	0.0188	0.0099	0.0189	0.0159
Particulate Emission Rate (gr./ dscf @ 50% Excess Air)	0.0178	0.0094	0.0179	0.0150
Particulate Emission Rate (gr./ dscf @ 12% CO ₂)	0.0238	0.0136	0.0251	0.0208
Allowable Particulate Emission Rate (gr./ dscf @12% CO ₂)	0.10	0.10	0.10	0.10
Carbon Monoxide Emission Rate (ppm @7% O ₂)	0.79	1.05	0.74	0.86
Carbon Monoxide Emissions (PPM) @ 50% Excess Air	0.75	0.99	0.70	0.81
Allowable Carbon Monoxide Emissions (PPM) @ 50% Excess Air	500	500	500	500
Carbon Monoxide Emissions (PPM) @ 12% CO ₂	1.00	1.43	0.98	1.14
Hydrogen Chloride Emission Rate(PPM)@7% O ₂	25.26	24.88	31.96	27.37
Hydrogen Chloride Emission Rate (PPM) @ 50% Excess Air	24.09	23.52	30.36	25.99
Hydrogen Chloride Emission Rate (PPM) @ 12% CO ₂	32.18	34.04	42.64	36.29

6.0 Visible Emission Results
Guiding Light Cremations, LLC
Unit #2
Report 2985-S

Emission Point	Allowable Emission Rate (highest six minute average)	Emission Rate (highest six minute average)	Average Opacity
Exhaust Stack	5	0.00	0.00

7.0 Particulate Emission Results
 Guiding Light Cremations, LLC
 Unit #2
 Report 2985-S

	Run 1	Run 2	Run 3
Area (square feet)	3.08	3.08	3.08
Stack Pressure (inches Hg)	29.88	30.07	30.07
Meter Pressure (inches Hg)	30.06	30.26	30.29
Sample Volume (Std. Cu. Ft.)	52.965	54.952	57.861
Water Vapor (Cubic Feet)	5.52	5.85	6.03
Sample Moisture (percent)	9.44	9.62	9.43
Saturation Moisture (percent)	100.00	100.00	100.00
Molecular Weight (lbs/lb Mole wet)	28.29	28.18	28.27
Velocity (fpm)	887	879	985
Volumetric Flow Rate (acfm)	2734	2710	3036
Volumetric Flow Rate (scfm)	891	933	963
Percent Carbon Dioxide (Measured)	5.1	4.5	5.0
Percent Oxygen (Measured)	13.4	13.8	13.2
Carbon Monoxide (PPM) (Measured)	0.42	0.53	0.41
Percent Excess Air (Calculated)	165.11	177.63	157.23
PM Concentration (gr/dscf)	0.0101	0.0051	0.0104
PM Concentration (gr/dscf) @7% O2	0.0188	0.0099	0.0189
PM Concentration (gr/dscf) @ 50% Excess Air	0.0178	0.0094	0.0179
PM Concentration (gr/dscf) @ 12% CO2	0.0238	0.0136	0.0251
Mass Emission Rate (lbs./hr.)	0.08	0.04	0.09
Percent Isokinetic	99.51	98.54	100.56

8.0 Carbon Monoxide Emission Results

Guiding Light Cremations, LLC

Unit #2

Report 2985-S

	Run1	Run 2	Run 3	Average
Date	3/3/2010	3/4/2010	3/4/2010	
Start Time	16:20	9:30	11:00	
Stop Time	17:23	10:33	12:05	
Percent Carbon Dioxide (Measured)	5.1	4.5	5.0	
Percent Oxygen (Measured)	13.4	13.8	13.2	
Carbon Monoxide (PPM) (Measured)	0.42	0.53	0.41	
Percent Excess Air (Calculated)	165.11	177.63	157.23	166.66
Carbon Monoxide Emissions (PPM @ 7% O ₂)	0.79	1.05	0.74	0.86
Carbon Monoxide Emissions (PPM) @ 50% Excess Air	0.75	0.99	0.70	0.81
Carbon Monoxide Emissions (PPM) @ 12% CO ₂	1.00	1.43	0.98	1.14

9.0 HCl Emission Results
Guiding Light Cremations, LLC
Unit #2
Report 2985-S

	Run 1	Run 2	Run 3	Average
Date	3/3/2010	3/4/2010	3/4/2010	
Sample Volume (Std. Cu. Ft.)	52.965	54.952	57.861	
Percent Carbon Dioxide (Measured)	5.1	4.5	5.0	
Percent Oxygen (Measured)	13.4	13.8	13.2	
Carbon Monoxide (PPM) (Measured)	0.42	0.53	0.41	
Percent Excess Air (Calculated)	165.11	177.63	157.23	166.66
Volume of Solution (mls)	400	400	400	
HCl (ug collected)	31,000	30,000	44,000	35,000
HCl (ug/DSCF)	585.29	545.93	760.45	630.56
HCl PPM (volume)	13.63	12.71	17.70	14.68
HCl PPM (volume) @ 7% O2	25.26	24.88	31.96	27.37
HCL PPM (volume) @ 50% Excess Air	24.09	23.52	30.36	25.99
HCl PPM (volume) @ 12% CO2	32.18	34.04	42.64	36.29

10.0 Overview of Field and Analytical Procedures

10.1 EPA Method 1 - Sample and Velocity Traverses for Stationary Sources

Principle - To aid in the representative measurement of pollutant emissions and/or total volumetric flow rate from a stationary source, a measurement site where the effluent stream is flowing in a known direction is selected and the cross-section of the stack is divided into a number of equal areas. A traverse point is then located within each of these equal areas. See Sampling Point Determination.

Applicability - This method is applicable to flowing gas streams in ducts, stacks and flues. This method cannot be used when: 1) flow is cyclonic or swirling 2) a stack is smaller than about 12 inches in diameter, or 0.071 cross-sectional area or 3) the measurement site is less than two stack or duct diameters downstream or less than a half diameters upstream from a flow disturbance. The procedures in this method were utilized in its entirety according to the procedures outlined in 40 CFR Part 60, Appendix A.

10.2 EPA Method 2 - Determination of Stack Gas Velocity and Volumetric Flow Rate

Principle - Type S Pitot Tube - The average gas velocity in a stack is determined from the gas density and from measurement of the average velocity head with a Type S pitot tube.

Applicability - This method is applicable for measurement of the average velocity of a gas stream and for quantifying gas flow.

This procedure is not applicable at measurement sites which fail to meet the criteria of Method 1. This method cannot be used for direct measurement in cyclonic or swirling gas streams. The procedures in this method were utilized in its entirety according to the procedures outlined in 40 CFR Part 60, Appendix A.

10.3 Method 3 - Gas Analysis for the EPA Determination of Dry Molecular Weight

Principle - A gas sample is extracted from a stack by one of the following methods 1) Single-point grab sampling 2) single-point, integrated sampling or 3) multi-point, integrated sampling, the gas sample is analyzed for percent CO₂, percent O₂, and if necessary for CO. For dry molecular weight determination, either an Orsat or a Fyrite analyzer may be used for the analysis.

Applicability - This method is applicable for determining carbon dioxide and oxygen concentrations and dry molecular weight of a sample from a gas stream of a fossil fuel combustion process. The method may also be applicable to other processes where it has been determined that compounds other than CO₂, O₂, CO, and nitrogen are not present in concentrations sufficient to affect the results. The procedures in this method were utilized in its entirety according to the procedures outlined in 40 CFR Part 60, Appendix A.

10.4 EPA Method 4 - Determination of Moisture Content in Stack Gases

Principle - A gas sample is extracted at a constant rate from the source; moisture is removed from the sample stream and determined either volumetrically or gravimetrically.

Applicability - This method is applicable for determining the moisture content of stack gas. There are two procedures given to determine the moisture. The procedure for the reference method to determine the moisture content was used to calculate the emission data. The reference method was conducted simultaneously with the pollutant emission measurement run, calculation of percent isokinetic, pollutant emission rate, etc. for the run is based upon the results of the reference method or its equivalent. The procedures in this method were utilized in its entirety according to the procedures outlined in 40 CFR Part 60, Appendix A.

10.5 EPA Method 5 - Determination of Particulate Emissions from Stationary Sources

Principle - Particulate matter is withdrawn isokinetically from the source and collected on a glass fiber filter maintained at a temperature in the range of 120 - 248° For such other temperature as specified by an applicable subpart of the standards or approved by the Administrator, U.S. Environmental Protection Agency, for a particular application.

The particulate mass which includes any material that condenses at or above the filtration temperature, is determined gravimetrically after removal of uncombined water.

Applicability - This method is applicable for the determination of particulate emissions from stationary sources. The procedures in this method were utilized in its entirety according to the procedures outlined in 40 CFR Part 60, Appendix A.

Diagram of EPA Method 5 Sampling Train

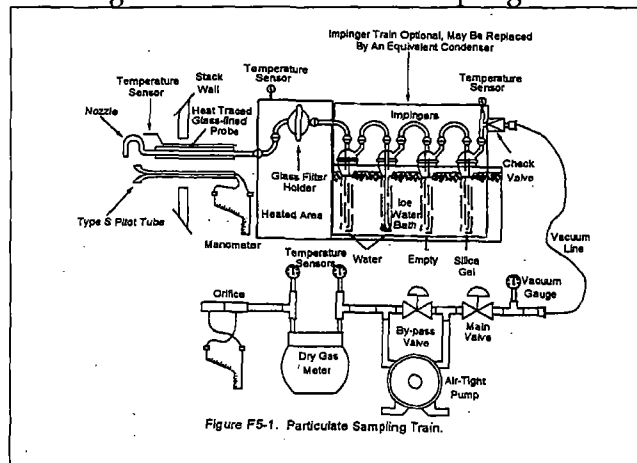

10.6 EPA Method 9 - Visual Determination of the Opacity of Emissions from Stationary Sources

Principle - The opacity of emissions from stationary sources is determined visually by a qualified observer.

Applicability - This method is applicable for the determination of the opacity of emissions from stationary sources pursuant to 60.11(b) and for qualifying observers for visually determining the opacity of emissions.

10.7 EPA Method 10 - Determination of Carbon Monoxide Emissions from Stationary Sources

Principle - An integrated or continuous gas sample is extracted from a sampling point and analyzed for carbon monoxide (CO) content using a Luft-type nondispersive infrared analyzer or equivalent.

Applicability - This method is applicable for the determination of carbon monoxide emissions from stationary sources only when specified by the test procedures for determining compliance with new source performance standards. The procedures in this method were utilized in its entirety according to the procedures outlined in 40 CFR Part 60, Appendix A.

10.8 EPA Method 26A - Determination of Hydrogen Halide and Halogen Emissions from Stationary Sources - Isokinetic Method

Principle - Gaseous and particulate pollutants are withdrawn isokinetically from the source and collected in an optional cyclone, on a filter, and in absorbing solutions. The cyclone collects any liquid droplets and is not necessary if the source emissions do not contain them; however, it is preferable to include the cyclone in the sampling train to protect the filter from any liquid present. The filter collects particulate matter including halide salts but is not routinely recovered or analyzed. Acidic and alkaline absorbing solutions collect the gaseous hydrogen halides and halogens respectively. Following sampling of emissions containing liquid droplets, any halides/halogens dissolved in the liquid in the cyclone and on the filter are vaporized to gas and collected in the impingers by pulling conditioned ambient air through the sampling train. The hydrogen halides are solubilized in the acidic solution and form chloride (Cl), bromide (Br) and Fluoride (F) ions. The halogens have a very low solubility in the acidic solution and pass through to the alkaline solution where they are hydrolyzed to form a proton (H⁺), the halide ion, and the hypohalous acid (HClO or HBrO). Sodium theosulfate is added to the alkaline solution to assure reaction with the hypohalous acid to form a second halide ion such that 2 halide ions are formed for each molecule of halogen gas. The halide ions in the separate solutions are measured by ion chromatography (IC). If desired, the particulate matter recovered from the filter and the probe is analyzed following the procedures in Method 5.

Note: During this test we were sampling for HCl so the fifth and sixth impingers, intended for the collection of halogen samples were not used.

11.0 Minimum Number of Sampling Points Minimum Number of Sampling Points Per Particulate Traverse

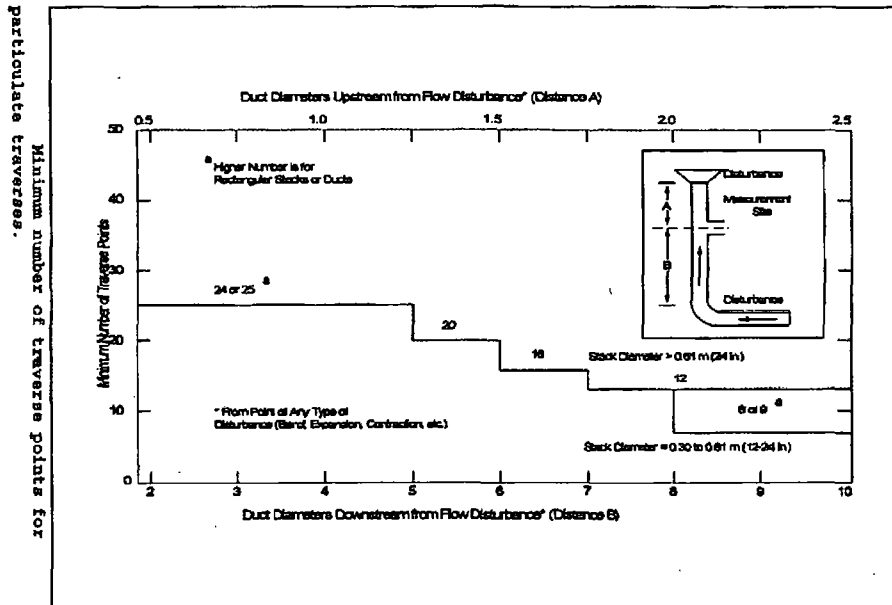

Circular Stacks

The number of sampling points is selected according to the above diagram, with the number of points equaling the next higher multiple of four.

Rectangular Stacks

The number of sampling points is determined using the matrix below.

Number of Traverse Points	Subarea Layout Matrix
9	3 x 3
12	4 x 3
16	4 x 4
20	5 x 4
25	5 x 5
30	6 x 5
36	6 x 6
42	7 x 6
49	7 x 7

11.1 Sampling Point Determination

Guiding Light Cremations, LLC

Unit #2

Report 2985-S

Stack Configuration	Rectangular
Side 1 - with ports (inches)	24
Side 2 - (inches)	18.5
Equivalent Diameter	20.89
Distance A - Ports to Downstream Disturbance (inches)	24
Distance A - Ports to Downstream Disturbance (diameters)	1.15
Distance B - Ports to Upstream Disturbance (inches)	48
Distance B - Ports to Upstream Disturbance (diameters)	2.30
Number of Test Ports	6
Number of Sampling points per Traverse	5
Number of Points Sampled	25

Photograph of Stack

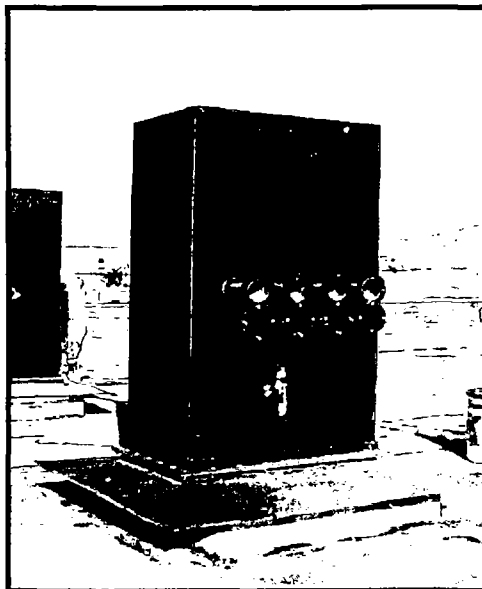

Traverse Point Location	
Traverse Point No.	Inches to Stack Wall
1	1.9
2	5.6
3	9.3
4	13.0
5	16.7

12.0 Summary of Field and Laboratory Data
 Guiding Light Cremations, LLC
 Unit #2
 Report 2985-S

	Run 1	Run 2	Run 3
Date	3/3/2010	3/4/2010	3/4/2010
Start Time	16:20	9:30	11:00
Stop Time	17:23	10:33	12:05
CP	0.84	0.84	0.84
Y	0.9947	0.9947	0.9947
ΔH_a (inches H ₂ O)	1.7304	1.7304	1.7304
Diameter of Nozzle (inches)	0.7503	0.7503	0.7503
Stack Diameter or Equivalent (inches)	20.89	20.89	20.89
Static Pressure (inches H ₂ O)	-0.02	-0.02	-0.02
Barometric Pressure (inches Hg)	29.88	30.07	30.07
Test Time (minutes)	60	60	60
Meter Volume (cubic feet)	53.623	54.165	57.845
Square Root ΔP (inches H ₂ O)	0.156	0.159	0.171
Orifice Pressure ΔH (inches H ₂ O)	2.458	2.583	3.000
Average Meter Temperature (Deg. F)	74.0	63.4	71.4
Average Stack Temperature (Deg. F)	1004.4	931.5	1054.1
Particulate Sample Weight (grms)	0.0347	0.0181	0.0391
Water Collected (grms)	117.1	124.1	127.8
Percent CO ₂	5.1	4.5	5.0
Percent O ₂	13.4	13.8	13.2
Molecular Weight (lbs/lb Mole)	29.36	29.27	29.33
Nozzle Area (square feet)	0.00307	0.00307	0.00307

Attachment A - Field Data



Arlington Environmental Services, Inc.

(863) 467-0555

VISIBLE EMISSION TEST

Method Used (Circle One) Method 9			203A	203B	Report # 9985-S
Company Name <u>Everglades Crematorium</u>					
Facility Name <u>AIRS 0112701</u>					
Street Address <u>2431 SW 56 Terrace</u>					
City <u>West Park FL</u>				Zip <u>33023</u>	
Phone No. <u>(954) 381-8888</u>					
Process <u>Human Crematory</u>		Unit # <u>2</u>		Operating Mode <u>N180 lbs</u>	
Control Equipment <u>After burner</u>		Operating Mode <u>N1625 °F</u>			
Describe Emission Point <u>Rectangular Stack</u>					
Ht of Emis. Point <u>~20'</u>			Ht Rel to Observer <u>~15'</u>		
Distance to Emis. Pt. <u>~800'</u>			Direction to Emis. Pt (Degrees) <u>~338°</u>		
Verticle Angle to Obs. <u><18°</u>			Direction to Obs. Pt. (Degrees) <u>~338°</u>		
Distance and Direction to Obs. Pt from Emission Pt <u>~1' above</u>					
Describe Emissions <u>None</u>					
Emission Color <u>Clear</u>			Water Droplet Plume Attached Detached <u>None X</u>		
Describe Plume Background <u>SKY</u>					
Background Color <u>Blue & White</u>			Sky Conditions <u>Scattered</u>		
Wind Speed <u>~12-15 MPH</u>			Wind Direction <u>NW</u>		
Ambient Temp. <u>~58°f</u>		Wet Bulb Temp.		% RH	
Source Layout Sketch					
				Draw North Arrow <input type="checkbox"/> IN <input type="checkbox"/> MN <input checked="" type="checkbox"/>	
Latitude		Longitude		Declination	
Comments					

Observation Date					Start Time					Stop Time																																																																																																																																																																																																																																																																																																	
3-4-10					0930					030																																																																																																																																																																																																																																																																																																	
Min Sec	0				15				30				45				Min Sec	0				15				30				45																																																																																																																																																																																																																																																																													
	1	0	0	0	0	31	0	0	0	0	2	0	0	0	0	32		0	0	0	0	3	0	0	0	0	33	0	0	0	0	4	0	0	0	0	34	0	0	0	0	5	0	0	0	0	35	0	0	0	0	6	0	0	0	0	36	0	0	0	0	7	0	0	0	0	37	0	0	0	0	8	0	0	0	0	38	0	0	0	0	9	0	0	0	0	39	0	0	0	0	10	0	0	0	0	40	0	0	0	0	11	0	0	0	0	41	0	0	0	0	12	0	0	0	0	42	0	0	0	0	13	0	0	0	0	43	0	0	0	0	14	0	0	0	0	44	0	0	0	0	15	0	0	0	0	45	0	0	0	0	16	0	0	0	0	46	0	0	0	0	17	0	0	0	0	47	0	0	0	0	18	0	0	0	0	48	0	0	0	0	19	0	0	0	0	49	0	0	0	0	20	0	0	0	0	50	0	0	0	0	21	0	0	0	0	51	0	0	0	0	22	0	0	0	0	52	0	0	0	0	23	0	0	0	0	53	0	0	0	0	24	0	0	0	0	54	0	0	0	0	25	0	0	0	0	55	0	0	0	0	26	0	0	0	0	56	0	0	0	0	27	0	0	0	0	57	0	0	0	0	28	0	0	0	0	58	0	0	0	0	29	0	0	0	0	59	0	0	0	0	30	0	0	0	0	60	0	0
Number of Readings Above % were										Average Opacity for Highest 6 Min Period																																																																																																																																																																																																																																																																																																	
Range of opacity Readings Min 0 Max 0										Average Opacity for 2nd Highest 6 Min Period																																																																																																																																																																																																																																																																																																	
Observers Name (Print) Steve Webb																																																																																																																																																																																																																																																																																																											
Observers Signature <u>Stephen L. Webb</u> Date <u>3-4-10</u>																																																																																																																																																																																																																																																																																																											
Organization Arlington Environmental Services, Inc.																																																																																																																																																																																																																																																																																																											
Certified By Whitlow Enterprises Date 1/15/10																																																																																																																																																																																																																																																																																																											



Whitlow Enterprises, LLC

www.smokeschool.net

Certifies that

Stephen Webb of Coastal Air Consulting

**Has passed the certification test required by EPA Method 9
40 CFR 60 Appendix A and is qualified as a visible emissions evaluator.**

Certification Date: 1/15/2010 Location: Tampa/Mulberry, FL

George Whitlow

President

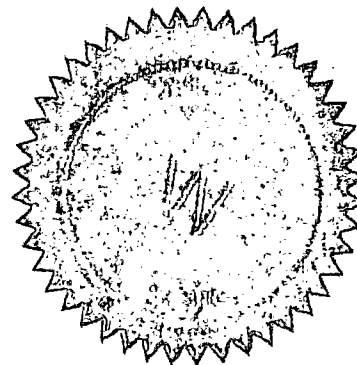

TMFL011510-32

Attachment B - Laboratory Data

Particulate Laboratory Data
Guiding Light Cremations, LLC
Unit #2
Report 2985-S

Run 2

Filter Number	1485	
	Final Weight	0.3827 grams
	Tare Weight	0.3704 grams
	Difference	0.0123 grams
Beaker Number	2C	
	Final Weight	117.5130 grams
	Tare Weight	117.5064 grams
	Difference	0.0066 grams
Filter Blank Number	1483	
	Final Weight	0.3700 grams
	Tare Weight	0.3699 grams
	Difference	0.0001 grams
Wash Down Blank		
	Volume of Rinse	95 mls
	Solution Residue	0.00000784 grams/ml
	Total Residue	0.0007448 grams/ml
Total Particulate Weight		0.0181 grams
Water Collected		
	Final Impinger Water	315 MLS
	Initial Impinger Water	200 MLS
	Final Silica Weight	209.3 GRAMS
	Silica Tare Weight	200.0 GRAMS
Total Water Collected		124.1 grams
Analyst	<u> </u>	

Particulate Laboratory Data
Guiding Light Cremations, LLC
Unit #2
Report 2985-S

Run 3

Filter Number	1486	
	Final Weight	0.4004 grams
	Tare Weight	0.3677 grams
	Difference	0.0327 grams
Beaker Number	3C	
	Final Weight	114.4563 grams
	Tare Weight	114.4492 grams
	Difference	0.0071 grams
Filter Blank Number	1483	
	Final Weight	0.3700 grams
	Tare Weight	0.3699 grams
	Difference	0.0001 grams
Wash Down Blank		
	Volume of Rinse	75 mls.
	Solution Residue	0.00000784 grams/ml.
	Total Residue	0.000588 grams
Total Particulate Weight		0.0391 grams
Water Collected		
	Final Impinger Water	317 mls.
	Initial Impinger Water	200 mls.
	Final Silica Weight	211.0 grams
	Silica Tare Weight	200.0 grams
Total Water Collected		127.8 grams

Analyst NT

Attention: William D. Arlington
Arlington Environmental Services Inc
605 Park Street, Suite 209
Okeechobee, FL
USA 34974

Report Date: 2010/03/30

CERTIFICATE OF ANALYSIS

MAXXAM JOB #: B032474
Received: 2010/03/18, 23:30

Sample Matrix: Impinger Solution
Samples Received: 8

Analyses	Quantity	Date Extracted	Date Analyzed	Laboratory Method	Method Reference
Hydrogen Halides in H2SO4 Imp. @	8	2010/03/26	2010/03/26	BRL SOP-00108	EPA Method 26A
Volume of Sulfuric Acid Impinger	8	N/A	2010/03/26		

* RPDs calculated using raw data. The rounding of final results may result in the apparent difference.

(1) This test was performed in Maxxam Mississauga under Maxxam Burlington SCC Accreditation

Encryption Key

Please direct all questions regarding this Certificate of Analysis to your Project Manager.

LINA BARRETO, Project Manager Assistant
Email: Lina.Barreto@maxxamanalytics.com
Phone# (905) 817-5700

=====
Maxxam has procedures in place to guard against improper use of the electronic signature and have the required "signatories", as per section 5.10.2 of ISO/IEC 17025:2005(E), signing the reports. For Service Group specific validation please refer to the Validation Signature Page.

Total cover pages: 1

Maxxam Job #: B032474
 Report Date: 2010/03/30

RESULTS OF ANALYSES OF IMPINGER SOLUTION

Maxxam ID		FJ1059	FJ1060		FJ1061	FJ1062	FJ1065		FJ1066		
Sampling Date		2010/03/15	2010/03/02		2010/03/04	2010/03/04	2010/03/04		2010/03/11		
	Units	BLANK M26A-H2SO4	2983-S-1-HCL 3/02	RDL	2985-S-1-HCL 3/04	2985-S-2-HCL 3/04	2985-S-3-HCL 3/04	RDL	2996-S-1-HCL 3/11	RDL	QC Batch

Volume	ml	400	400	1	400	400	400	1	400	1	2110433
Hydrochloric Acid	ug	<200	3700	200	31000	30000	44000	400	8300	200	2110447

RDL = Reportable Detection Limit
 QC Batch = Quality Control Batch

Maxxam ID		FJ1067	FJ1068		
Sampling Date		2010/03/11	2010/03/11		
	Units	2996-S-2-HCL 3/11	2996-S-3-HCL 3/11	RDL	QC Batch

Volume	ml	400	400	1	2110433
Hydrochloric Acid	ug	9800	10000	200	2110447

RDL = Reportable Detection Limit
 QC Batch = Quality Control Batch

Maxxam Job #: B032474
Report Date: 2010/03/30

Test Summary

Maxxam ID FJ1059 **Collected** 2010/03/15
Sample ID BLANK M26A-H2SO4 **Shipped**
Matrix Impinger Solution **Received** 2010/03/18

Test Description	Instrumentation	Batch	Extracted	Analyzed	Analyst
Hydrogen Halides in H2SO4 Imp.	IC/SPEC	2110447	2010/03/26	2010/03/26	A S
Volume of Sulfuric Acid Impinger		2110433	N/A	2010/03/26	A S

Maxxam ID FJ1060 **Collected** 2010/03/02
Sample ID 2983-S-1-HCL 3/02 **Shipped**
Matrix Impinger Solution **Received** 2010/03/18

Test Description	Instrumentation	Batch	Extracted	Analyzed	Analyst
Hydrogen Halides in H2SO4 Imp.	IC/SPEC	2110447	2010/03/26	2010/03/26	A S
Volume of Sulfuric Acid Impinger		2110433	N/A	2010/03/26	A S

Maxxam ID FJ1060 Dup **Collected** 2010/03/02
Sample ID 2983-S-1-HCL 3/02 **Shipped**
Matrix Impinger Solution **Received** 2010/03/18

Test Description	Instrumentation	Batch	Extracted	Analyzed	Analyst
Hydrogen Halides in H2SO4 Imp.	IC/SPEC	2110447	2010/03/26	2010/03/26	A S

Maxxam ID FJ1061 **Collected** 2010/03/04
Sample ID 2985-S-1-HCL 3/04 **Shipped**
Matrix Impinger Solution **Received** 2010/03/18

Test Description	Instrumentation	Batch	Extracted	Analyzed	Analyst
Hydrogen Halides in H2SO4 Imp.	IC/SPEC	2110447	2010/03/26	2010/03/26	A S
Volume of Sulfuric Acid Impinger		2110433	N/A	2010/03/26	A S

Maxxam ID FJ1062 **Collected** 2010/03/04
Sample ID 2985-S-2-HCL 3/04 **Shipped**
Matrix Impinger Solution **Received** 2010/03/18

Test Description	Instrumentation	Batch	Extracted	Analyzed	Analyst
Hydrogen Halides in H2SO4 Imp.	IC/SPEC	2110447	2010/03/26	2010/03/26	A S
Volume of Sulfuric Acid Impinger		2110433	N/A	2010/03/26	A S

Maxxam ID FJ1065 **Collected** 2010/03/04
Sample ID 2985-S-3-HCL 3/04 **Shipped**
Matrix Impinger Solution **Received** 2010/03/18

Test Description	Instrumentation	Batch	Extracted	Analyzed	Analyst
Hydrogen Halides in H2SO4 Imp.	IC/SPEC	2110447	2010/03/26	2010/03/26	A S
Volume of Sulfuric Acid Impinger		2110433	N/A	2010/03/26	A S

Maxxam Job #: B032474
 Report Date: 2010/03/30

Test Summary

Maxxam ID FJ1066
 Sample ID 2996-S-1-HCL 3/11
 Matrix Impinger Solution
 Collected 2010/03/11
 Shipped
 Received 2010/03/18

Test Description	Instrumentation	Batch	Extracted	Analyzed	Analyst
Hydrogen Halides in H2SO4 Imp.	IC/SPEC	2110447	2010/03/26	2010/03/26	A S
Volume of Sulfuric Acid Impinger		2110433	N/A	2010/03/26	A S

Maxxam ID FJ1067
 Sample ID 2996-S-2-HCL 3/11
 Matrix Impinger Solution
 Collected 2010/03/11
 Shipped
 Received 2010/03/18

Test Description	Instrumentation	Batch	Extracted	Analyzed	Analyst
Hydrogen Halides in H2SO4 Imp.	IC/SPEC	2110447	2010/03/26	2010/03/26	A S
Volume of Sulfuric Acid Impinger		2110433	N/A	2010/03/26	A S

Maxxam ID FJ1068
 Sample ID 2996-S-3-HCL 3/11
 Matrix Impinger Solution
 Collected 2010/03/11
 Shipped
 Received 2010/03/18

Test Description	Instrumentation	Batch	Extracted	Analyzed	Analyst
Hydrogen Halides in H2SO4 Imp.	IC/SPEC	2110447	2010/03/26	2010/03/26	A S
Volume of Sulfuric Acid Impinger		2110433	N/A	2010/03/26	A S

Maxxam Job #: B032474
Report Date: 2010/03/30

GENERAL COMMENTS

Results relate only to the items tested.

Arlington Environmental Services Inc
 Attention: William D. Arlington
 Client Project #:
 P.O. #:
 Project name:

Quality Assurance Report
 Maxxam Job Number: GB032474

QA/QC Batch Num Init	QC Type	Parameter	Date Analyzed yyyy/mm/dd	Value	%Recovery	Units	QC Limits
2110447 A_S	Matrix Spike (FJ1060)	Hydrochloric Acid	2010/03/26		94	%	80 - 120
	Spiked Blank	Hydrochloric Acid	2010/03/26		101	%	90 - 110
	Method Blank RPD - Sample/Sample Dup	Hydrochloric Acid	2010/03/26	<200		ug	
		Hydrochloric Acid	2010/03/26	1.3		%	20

Matrix Spike: A sample to which a known amount of the analyte of interest has been added. Used to evaluate sample matrix interference.
 Spiked Blank: A blank matrix to which a known amount of the analyte has been added. Used to evaluate analyte recovery.
 Method Blank: A blank matrix containing all reagents used in the analytical procedure. Used to identify laboratory contamination.

Validation Signature Page

Maxxam Job #: B032474

The analytical data and all QC contained in this report were reviewed and validated by the following individual(s).



FRANK MO, B.Sc., Inorganic Lab. Manager

Maxxam has procedures in place to guard against improper use of the electronic signature and have the required "signatories", as per section 5.10.2 of ISO/IEC 17025:2005(E), signing the reports. For Service Group specific validation please refer to the Validation Signature Page.

Attachment C - Process Data

Emission Control Device and Process Data

Company Guiding Light Cremations

Installation Unit #2

Date 3-4-10 Report No. 2985-S

Type of Installation Crematory

Type of Material Processed Human Remains

Type(s) of Fuel Used Natural Gas

Type of Pollution Control System After burner

General Condition of Control Equipment Normal

Run No.	3-3-10	3-4-10	3-4-10
Start Time	16:20	9:30	11:00
Stop Time	17:23	10:33	12:05
Fuel Used	NG	NG	NG
Scrubber Water Flow Rate (GPM)	NA	NA	NA
Pressure Drop (in. H ₂ O)	NA	NA	NA
Total Operating Temp °F	1680	1630	1720
Process Rate (lbs/Hr.)	175	— 180 —	
Percent Recycle	NA	NA	NA

Signature *[Signature]* Title _____

Name _____
(Please Print)

Attachment D - Calculations for Run 1

STACK AREA
 (SIDE 1) X (SIDE 2) / 144
 24.00 X 18.50 / 144
 3.08 SQ.FT.

STACK PRESSURE
 BAROMETRIC PRESSURE + (STATIC PRESSURE/ 13.6)
 29.88 + (-0.02 /13.6)
 29.88 IN.HG

METER PRESSURE
 BAROMETRIC PRESSURE + (ORIFICE PRESURE/13.6)
 29.88 + (2.46 / 13.6)
 30.06 IN.Hg

SAMPLE VOLUME
 17.64 X (Y) X METER VOLUME X METER PRESSURE / (METER TEMP. + 460)
 17.64 X 0.9947 X 53.623 X 30.06 / (74.0 + 460)
 52.965 STD.CU.FT.

WATER VAPOR VOLUME
 .04715 X WATER COLLECTED
 0.04715 X 117.1
 5.52 STD.CU.FT.

SAMPLE MOISTURE
 100 X WATER VAPOR VOLUME / (WATER VAPOR VOLUME + SAMPLE VOLUME)
 100 X 5.52 / (5.52 + 52.965)
 9.44 %

SATURATION MOISTURE
 100 X (VAPOR PRESSURE @ STACK TEMP. / STACK PRESSURE)
 100 X (47,255.20 / 29.88)
 100.00 %

STACK MOISTURE FRACTION
 (THE LESSER OF SAMPLE MOISTURE OR SATURATION MOISTURE) / 100
 0.094

DRY MOLECULAR WEIGHT OF STACK GAS
 (.28 X (100-%N2)) + (.44 X %CO2) + (.32 X %O2)
 (.28 X (100 - (5.14 + 13.43)) + (.44 X 5.1 + (.32 X 13.43))
 29.36

MOLECULAR WEIGHT OF STACK GAS
 MOLECULAR WEIGHT X (1 - MOISTURE) + (18 X MOISTURE)
 29.36 X (1 - 0.094) + (18 X 0.094)
 28.29

STACK VELOCITY
 $85.49 \times CP \times 60 \times SQ.(\wedge P) \times SQ.(STACK\ TEMP + 460) / SQ.(STACK\ PRESSURE \times MOLECULAR\ WT.)$
 85.49 X 0.840 X 60 X 0.156 X SQ.(1004.4 + 460) / SQR(29.88 X 28.29
 887 FPM

VOLUMETRIC FLOW RATE (ACFM)
 STACK AREA X STACK VELOCITY
 3.08 X 887
 2734 ACFM

VOLUMETRIC FLOW RATE (SCFM) DRY
 $17.64 \times (ACFM) \times STACK\ PRESSURE \times (1 - MOISTURE) / (STACK\ TEMP. + 460)$
 17.64 X 2734 X 29.88 X (1 - 0.094) / (1004.4 + 460)
 891 SCFM (DRY)

CONCENTRATION (gr/dscf)
 Total Particulate Weight X 15.43 / Sample Volume
 0.0347 X 15.43 / 52.96
 0.0101

CONCENTRATION@7% O2 (gr/dscf)
 Concentration X 13.9 / (20.9 - %o2)
 0.0101 X 13.9 / (20.9 - 13.43)
 0.0188

MASS EMISSION RATE (LBS./HR.)
 CONCENTRATION X (SCFM- DRY) X 60 / 7000
 0.0101 X 891 X 60 / 7000
 0.08 LBS/HR

PERCENT ISOKINETIC
 $.0945 \times (STACK\ TEMP. + 460) \times SAMPLE\ VOLUME \times 60$
 (STACK PRES. X VELOCITY X NOZZLE AREA X TEST TIME X (1-MOISTURE))
 $\frac{0.0945 \times (1004.38 + 460) \times 52.96 \times 60}{29.88 \times 887 \times 0.00307 \times 60.00 \times (1 - 0.094)}$
 99.51 %

CALCULATIONS FOR RUN 1
Guiding Light Cremations, LLC
Unit #2
Report 2985-S

Page 3 of 3

Note Emissions Calculation for Correcting Pollutant Emission to 7% O₂, 50% Excess Air, and 12% CO₂ are provided for HCl but are the same for the rest of the pollutants (PM and Carbon Monoxide)

PERCENT EXCESS AIR

$$\frac{100 \times (\%O_2(\text{MEASURED}) - 0.5 \times \text{PPM}_{\text{CO}} + 10,000\%/\text{PPM})}{0.264 \times (100 - (\%O_2 + \%CO_2 + \text{PPM}_{\text{CO}} + 10,000\%/\text{PPM})) - (\%O_2 - 0.5 \times (\text{PPM}_{\text{CO}} + 10,000\%/\text{PPM}))}$$

$$\frac{100 \times (13.4 - 0.5 \times (0.42 + 10,000))}{0.264 \times (100 - (13.4 + 5.1 + (0.42 / 10,000))) - (13.4 - 0.5 \times 0.42 / 10,000)}$$

Percent Excess Air = **165.11%**

CONCENTRATION HCl (VOLUME)

$$\text{PPM (volume @ 20 deg C)} = \text{HCl(ug/dscf)} \times 24040 / (28.32 \times M \times 10^3)$$

$$\text{PPM} = \text{HCl(ug/dscf)} \times 24040 / (28.32 \times 36.461 \times 10^3)$$

$$\text{PPM} = 585.29 \times 24.040 / (28.32 \times 36.461 \times 10^3)$$

HCl Concentration = **13.63 PPM**

EMISSIONS CORRECTED TO 7% O₂

$$\text{Pollutant Concentration} \times (\%O_2(\text{Air}) - \%O_2(\text{Referenced})) / (\%O_2(\text{Air}) - \%O_2(\text{Measured}))$$

$$13.63 \times (20.9 - 7) / (20.9 - 13.4)$$

HCl @ 7% O₂ = **25.26 PPM**

EMISSIONS CORRECTED TO 50% EXCESS AIR

$$\frac{\text{PPM}_{\text{HCl}} (100 + \text{EXCESS AIR})}{150}$$

$$\frac{13.63 (100 + 165.11)}{150}$$

HCl @ 50% Excess Air = **24.09 PPM**

EMISSIONS CORRECTED TO 12% CO₂

$$\text{Pollutant Concentration} \times (\%CO_2(\text{Air}) - \%CO_2(\text{Referenced})) / (\%CO_2(\text{Air}) - \%CO_2(\text{Measured}))$$

$$13.63 \times (0.03 - 12) / (0.03 - 5.1)$$

HCl Concentration @ 12% CO₂ = **32.18 PPM**

ResidenceTime Unit 2

CORRECTION FOR QUENCHED AIR AT OUTLET			
SCC DRY AIR			
$(M \times \text{ENTHALPY CHANGE})_{\text{scc}} = (M \times \text{ENTHALPY CHANGE})_{\text{amb}}$			
H(M _{scc}) =		152.5	BTU/lbm
H(M _{amb}) =		250.1	BTU/lbm
M(amb) =		0.610	x M(scc)
M(scc) + M(amb) =		69.660	lb/min
M(scc)AIR =		43.274	lb/min
SCC H2O			
$M(\text{scc})\text{H}_2\text{O} + M(\text{amb})\text{H}_2\text{O} = M(\text{outlet})\text{H}_2\text{O}$			
M(amb.) H ₂ O =		0.02	lb/lb dry air
M(amb.) AIR =		26.39	lb/min
M(amb.) H ₂ O =		0.53	lb/min
M(scc) H ₂ O =		2.14	lb/min
SCC VOLUMETRIC FLOW			
V = MRT/PM	@	1624	F
		14.77	psi
AIR:	V =	2261.3	ACFM
H2O:	V =	179.9	ACFM
TOTAL SCC:	V =	2441.2	ACFM
SCC RESIDENCE TIME			
RESIDENCE TIME =		1.75	SECONDS

Attachment E - Calibration Data

ANNUAL METER CALIBRATION		METER NO. 002047		ORIFICE SET NO. JC40-73															
DATE	9/20/2009	Y=	0.9947	MAX % VARIATION	1.8562%	PASS													
BAROMETRIC PRESSURE	29.98	^Ha=	1.7304	MAX % VARIATION	1.2487%	PASS													
CRITICAL ORIFICE DATA																			
ORIFICE SERIAL NO.	ORIFICE K FACTOR	ACTUAL VACUUM	^H (IN H2O)	TIME (MIN.)	AMBIENT TEMP INITIAL	AMBIENT TEMP. FINAL	METER TEMP. INITIAL	METER TEMP. FINAL	METER READING INITIAL	METER READING FINAL	VM (CU.FT.)	VM :ORRECTE	Vcr STD	Vcr NOMINAL	Y	VARIATION	^H (IN. H2O)	VARIATION	
40	0.2435	24.0	0.31	10	83	83	82	83	719.500	722.767	3.2670	3.1872	3.1328	3.2166	0.9829	0.0015	1.7327	0.0037	
40	0.2435	24.0	0.31	10	83	83	83	84	722.767	726.050	3.2830	3.1969	3.1328	3.2166	0.9799	-0.0015	1.7285	0.0005	
40	0.2435	24.0	0.31	10	83	83	85	85	726.050	729.337	3.2870	3.1920	3.1328	3.2166	0.9814	0.0000	1.7247	-0.0042	
AVERAGE															0.9814	0.0186	1.7290	0.0008	
48	0.3557	22.5	0.66	10	84	84	86	86	730.400	735.138	4.7380	4.5966	4.5721	4.7031	0.9947	-0.0030	1.7208	0.0005	
48	0.3557	22.5	0.66	10	84	84	86	87	735.138	739.858	4.7200	4.5749	4.5721	4.7031	0.9994	0.0017	1.7193	-0.0011	
48	0.3557	22.0	0.66	10	85	85	87	87	739.858	744.580	4.7220	4.5727	4.5679	4.7074	0.9980	0.0013	1.7208	0.0005	
AVERAGE															0.9977	0.0023	1.7203	0.0058	
55	0.4616	19.5	1.15	10	86	86	88	89	745.400	751.583	6.1830	5.9783	5.9224	6.1145	0.9907	-0.0057	1.7788	0.0268	
55	0.4616	18.0	1.15	10	87	87	90	90	751.583	757.678	6.0950	5.8771	5.9170	6.1201	1.0068	0.0105	1.7772	0.0252	
55	0.4616	18.0	1.10	10	88	88	91	91	757.678	763.873	6.1950	5.9620	5.9116	6.1257	0.9916	-0.0048	1.7000	-0.0520	
AVERAGE															0.9963	0.0037	1.7520	0.0125	
63	0.5916	20.5	1.85	10	88	88	91	92	765.300	773.178	7.8780	7.5887	7.5765	7.8509	0.9984	0.0020	1.7390	0.0021	
63	0.5916	20.5	1.85	10	88	88	92	92	773.178	781.096	7.9180	7.6203	7.5765	7.8509	0.9943	-0.0021	1.7375	0.0005	
63	0.5916	20.5	1.85	10	88	88	93	93	781.096	789.010	7.9140	7.6027	7.5765	7.8509	0.9966	0.0002	1.7343	-0.0026	
AVERAGE															0.9964	0.0036	1.7369	0.0038	
73	0.8234	17.5	3.55	10	88	88	93	94	790.000	800.963	10.9630	10.5659	10.5451	10.9270	0.9980	-0.0039	1.7164	0.0026	
73	0.8234	17.5	3.55	10	88	88	94	95	800.963	811.885	10.9220	10.5074	10.5451	10.9270	1.0036	0.0017	1.7133	-0.0005	
73	0.8234	17.5	3.55	10	88	88	95	95	811.885	822.812	10.9270	10.5028	10.5451	10.9270	1.0040	0.0021	1.7118	-0.0021	
AVERAGE															1.0019	0.0019	1.7139	0.0096	
SEMI ANNUAL CALIBRATION		DATE	3/21/2009		BAROMETRIC PRESSURE		30.12												
ORIFICE SERIAL NO.	ORIFICE K FACTOR	ACTUAL VACUUM	^H (IN H2O)	TIME (MIN.)	AMBIENT TEMP INITIAL	AMBIENT TEMP. FINAL	METER TEMP. INITIAL	METER TEMP. FINAL	METER READING INITIAL	METER READING FINAL	VM (CU.FT.)	VM :ORRECTE	Vcr STD	Vcr NOMINAL	Y	VARIATION	^H (IN. H2O)	VARIATION	
55	0.4616	21.0	1.15	10	76	75	82	81	679.000	685.182	6.1820	6.0828	6.0082	6.0555	0.9877	-0.0086	1.7590	-0.0011	
55	0.4616	21.0	1.15	10	75	75	81	80	685.182	691.342	6.1600	6.0723	6.0110	6.0526	0.9899	-0.0064	1.7606	0.0005	
55	0.4616	21.0	1.15	10	75	74	80	80	691.342	697.478	6.1360	6.0543	6.0138	6.0498	0.9933	-0.0030	1.7606	0.0005	
AVERAGE															0.9903	-0.0060	1.7600	0.0171	
																PASS	PASS		
METER COMPARISON CHECK (Y _{qa})		Y _{qa} =		$(O / Vm) \times \text{sq}(\sqrt{.319 \times Tm \times 29 / (^Ha \times (Pb + (Havg / 13.6) \times Md))}) \times \text{sq} ^H \text{ avg}$															
	Run 1	Run 2	Run 3	Average															
Y _{qa}	0.9871	0.9884	1.0045	0.9934															
THERMOCOUPLE CALIBRATION		DATE	9/20/2009																
	TC-1 (DEG F)	ASTM THERMOMETER (DEG F)																	
ICE	31	32																	
BOILING H2O	211	212																	
OIL	354	352																	
NOZZLE CALIBRATION		DATE	3/4/2010																
READINGS IN (IN.)	AVERAGE																		
#24	0.750	0.750	0.751	0.7503															
PITOT TUBE	CP=.84	ACCORDING TO DESIGN SPECIFICATIONS																	

Nozzle Calibration

Nozzle ID #24

A = 0.750

B = 0.750

C = 0.751

Average 0.7503

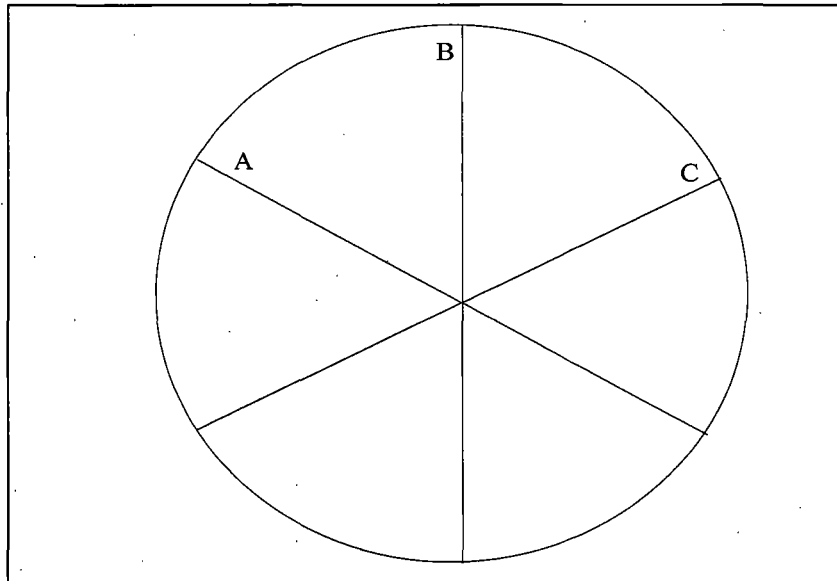

Calibration Date 3/4/2010

Calibrated by *NA*

PITOT CALIBRATION

(Type S Pitot Tube Inspection)

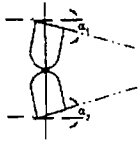

Degree indicating level position for determining α_1 and α_2 .

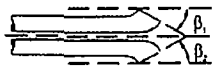
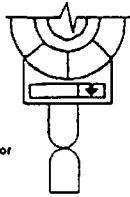

Degree indicating level position for determining β_1 and β_2 .

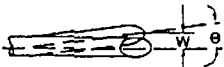
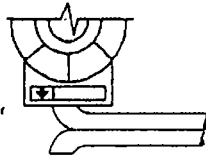

Degree indicating level position for determining θ .

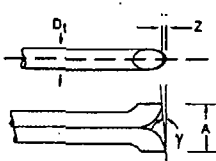
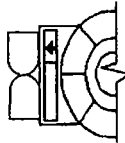

Degree indicating level position for determining γ then calculate Z.

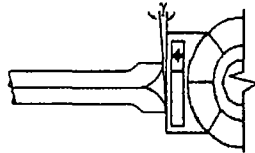

Level and Perpendicular?	Yes
Obstruction?	No
Damaged?	No
α_1 ($-10^\circ \leq \alpha_1 \leq +10^\circ$)	2
α_2 ($-10^\circ \leq \alpha_2 \leq +10^\circ$)	0
β_1 ($-5^\circ \leq \beta_1 \leq +5^\circ$)	1
β_2 ($-5^\circ \leq \beta_2 \leq +5^\circ$)	1
Y	1
θ	-2
$z = A \tan \gamma$ ($\leq 0.125^\circ$)	0.017
$w = A \tan \theta$ ($\leq 0.03125^\circ$)	-0.034
D_t ($3/16'' \leq D_t \leq +3/8''$)	0.375
A	0.961
$A/2 D_t$ ($1.05 \leq P_A / D_t \leq 1.51$)	1.281

Certification

I hereby certify that type S pitot tube ID# P-5AC meets or exceeds all specifications, criteria and applicable design features, and is hereby assigned a pitot tube calibration factor of 0.84.

Certified by: *W. G. Gillingham*

Date: 9/20/09

EVERGLADES CREMATIONS

DATE: 3/3/2010
 RUN: 1
 UNIT: 2

AVG. ADJUSTED CO ppmvd @ 7% O2	0.79
CORRECTED O2 %	13.43
CORRECTED CO2 %	5.14
CORRECTED CO ppmvd	0.42

ANALYZER RESPONSE, SYSTEM BIAS AND SYSTEM DRIFT DATA

RANGE SETTING	CAL GASES	CERTIFIED GAS VALUE	ANALYZER VALUE	DIFFERENCE PPM	% SPAN	ANALYZER PRETEST VALUE	% SPAN	ANALYZER POSTTEST VALUE	% SPAN	% DRIFT	ANALYZER SERIAL #
25	% O2	0.00	0.00	0.00	0.00	0.00	0.00	0.00	0.00	0.00	01420B153
		12.04	12.00	-0.04	-0.18	12.00	0.00	12.00	0.00	0.00	
		22.62	22.50	-0.12	-0.53						
20	% CO2	0.00	0.00	0.00	0.00	0.00	0.00	0.00	0.00	0.00	01410B139
		9.62	9.60	-0.02	-0.12	9.60	0.00	9.60	0.00	0.00	
		17.27	17.30	0.03	0.17						
100	PPM CO	0.00	0.00	0.00	0.0	0.00	0.0	0.00	0.0	0.0	48C-68845-361
		48.5	48.4	-0.10	-0.1	48.30	-0.1	48.20	-0.2	-0.1	
		102.00	102.90	0.90	0.9						

UNCORRECTED RAW DATA

DATE & TIME	O2 %	CO2 %	CO PPM
16:20	12.78	6.17	0.70
16:21	12.53	5.92	0.60
16:22	13.07	5.18	0.60
16:23	13.48	5.00	0.65
16:24	13.45	5.04	0.50
16:25	13.34	5.10	0.60
16:26	13.28	5.12	0.45
16:27	13.28	5.05	0.55
16:28	13.39	4.93	0.50
16:29	13.51	4.76	0.45
16:30	13.86	4.65	0.45
16:31	13.96	4.67	0.30
16:32	13.78	4.82	0.35
16:33	13.51	4.95	0.30
16:34	13.43	4.95	0.55
16:35	13.63	4.84	0.85
16:36	13.91	4.72	0.80
16:37	13.96	4.80	0.50
16:38	13.68	5.00	0.45
16:39	13.46	5.04	0.50
16:40	13.52	4.94	0.60
16:41	13.82	4.78	0.60
16:42	13.91	4.84	0.75
16:43	13.66	4.93	0.75
16:44	13.63	4.91	0.90
16:45	13.78	4.77	1.00
16:46	13.97	4.73	0.90
16:47	13.92	4.88	0.55
16:48	13.23	5.44	0.60
16:49	12.81	5.31	0.65
16:50	13.48	4.94	0.70
16:51	13.68	5.10	0.75
16:52	13.10	5.17	1.00
16:53	13.49	5.07	0.80
16:54	13.46	4.97	0.20
16:55	13.78	4.89	0.10
16:56	13.49	5.19	0.10
16:57	12.91	5.39	0.15
16:58	13.13	5.02	0.20
16:59	13.91	4.69	0.05
17:00	13.82	5.05	0.15
17:01	13.01	5.39	0.15
17:02	12.96	5.31	0.20
17:03	13.01	5.49	0.20
17:04	13.25	5.39	0.25
17:05	13.14	5.61	0.20
17:06	12.69	5.69	0.30
17:07	12.75	5.51	0.30
17:08	13.31	5.19	0.20
17:09	13.48	5.32	0.15
17:10	12.92	5.57	0.25
17:11	12.84	5.42	0.25
17:12	13.41	5.06	0.05
17:13	13.63	5.18	0.00
17:14	13.03	5.52	0.05
17:15	12.77	5.48	0.25
17:16	13.20	5.13	0.15
17:17	13.73	4.95	0.00
17:18	13.40	5.34	0.05
17:19	12.73	5.55	0.15

MEAN ANALYZER VALUES

Avg. % O2	13.39
Avg. % CO2	5.13
Avg. CO ppmvd	0.42

EVERGLADES CREMATIONS

DATE: 3/4/2010
 RUN: 2
 UNIT: 2

AVG. ADJUSTED CO ppmvd @ 7% O2	1.04
CORRECTED O2 %	13.79
CORRECTED CO2 %	4.46
CORRECTED CO ppmvd	0.53

ANALYZER RESPONSE, SYSTEM BIAS AND SYSTEM DRIFT DATA

RANGE SETTING	CAL GASES	CERTIFIED GAS VALUE	ANALYZER VALUE	DIFFERENCE PPM	% SPAN	ANALYZER PRETEST VALUE	% SPAN	ANALYZER POSTTEST VALUE	% SPAN	% DRIFT	ANALYZER SERIAL #
25	% O2	0.00	0.00	0.00	0.00	0.00	0.00	0.00	0.00	0.00	014208153
		12.04	12.00	-0.04	-0.18	12.00	0.00	11.90	0.00	-0.44	
		22.62	22.50	-0.12	-0.53						
20	% CO2	0.00	0.00	0.00	0.00	0.10	0.58	0.00	0.00	-0.58	01410/B139
		9.62	9.60	-0.02	-0.12	9.60	0.00	9.60	0.00	0.00	
		17.27	17.30	0.03	0.17						
50	PPM CO	0.00	0.00	0.00	0.0	0.10	0.1	0.00	0.0	-0.1	48C-68845-361
		48.50	48.40	-0.10	-0.1	48.80	0.2	48.10	-0.3	-0.5	
		102.00	102.90	0.90	0.9						

UNCORRECTED RAW DATA

DATE & TIME	O2 %	CO2 %	CO PPM
9:30	11.82	7.41	0.60
9:31	10.44	7.54	1.15
9:32	11.59	5.91	1.25
9:33	13.23	4.97	1.20
9:34	13.35	5.06	0.90
9:35	13.06	5.06	0.65
9:36	13.03	5.04	0.50
9:37	13.14	4.89	0.45
9:38	13.28	4.78	0.45
9:39	13.40	4.67	0.45
9:40	13.50	4.60	0.45
9:41	13.56	4.54	0.40
9:42	13.63	4.49	0.40
9:43	13.71	4.41	0.40
9:44	13.79	4.36	0.40
9:45	13.78	4.38	0.45
9:46	13.77	4.36	0.40
9:47	13.80	4.34	0.45
9:48	13.83	4.32	0.30
9:49	13.83	4.29	0.30
9:50	13.85	4.27	0.30
9:51	13.88	4.23	0.25
9:52	13.93	4.18	0.25
9:53	13.99	4.13	0.25
9:54	14.00	4.12	0.25
9:55	14.04	4.09	0.30
9:56	14.04	4.09	0.30
9:57	14.07	4.06	0.25
9:58	14.09	4.06	0.20
9:59	13.85	4.49	0.15
10:00	13.06	4.88	0.25
10:01	12.97	4.55	0.35
10:02	14.02	4.17	1.25
10:03	14.04	4.13	0.85
10:04	14.08	4.14	0.70
10:05	14.01	4.19	0.75
10:06	13.98	4.20	0.80
10:07	13.94	4.26	0.80
10:08	13.93	4.23	0.80
10:09	13.94	4.22	0.70
10:10	13.98	4.19	0.80
10:11	14.03	4.14	0.75
10:12	14.06	4.12	0.70
10:13	14.09	4.10	0.70
10:14	14.13	4.10	0.70
10:15	14.16	4.07	0.75
10:16	14.19	4.07	0.70
10:17	14.17	4.08	0.70
10:18	14.15	4.09	0.65
10:19	14.18	4.11	0.65
10:20	14.11	4.14	0.65
10:21	14.09	4.16	0.60
10:22	14.06	4.18	0.80
10:23	14.05	4.19	0.65
10:24	14.02	4.24	0.65
10:25	13.92	4.35	0.70
10:26	13.79	4.44	0.70
10:27	13.89	4.53	0.65
10:28	13.56	4.64	0.65
10:29	13.39	4.80	0.65

MEAN ANALYZER VALUES

Avg. % O2	13.68
Avg. % CO2	4.48
Avg. CO ppmvd	0.58

EVERGLADES CREMATIONS

DATE: 3/4/2010
 RUN: 3
 UNIT: 2

AVG. ADJUSTED CO ppmvd @ 7% O2	0.74
CORRECTED O2 %	13.23
CORRECTED CO2 %	5.03
CORRECTED CO ppmvd	0.41

ANALYZER RESPONSE, SYSTEM BIAS AND SYSTEM DRIFT DATA

RANGE SETTING	CAL GASES	CERTIFIED GAS VALUE	ANALYZER VALUE	DIFFERENCE PPM	% SPAN	ANALYZER PRETEST VALUE	% SPAN	ANALYZER POSTTEST VALUE	% SPAN	% DRIFT	ANALYZER SERIAL#
25	% O2	0.00	0.00	0.00	0.00	0.00	0.00	0.00	0.00	0.00	01420B153
		12.04	12.00	-0.04	-0.18	11.90	-0.44	11.90	-0.44	0.00	
		22.62	22.50	-0.12	-0.53						
20	% CO2	0.00	0.00	0.00	0.00	0.00	0.00	0.00	0.00	0.00	01410/B139
		9.62	9.60	-0.02	-0.12	9.60	0.00	9.60	0.00	0.00	
		17.27	17.30	0.03	0.17						
50	PPM CO	0.00	0.00	0.00	0.0	0.00	0.0	0.00	0.0	0.0	48C-68845-361
		48.50	48.40	-0.10	-0.1	48.10	-0.3	47.80	-0.6	-0.3	
		102.00	102.90	0.90	0.9						

UNCORRECTED RAW DATA

DATE & TIME	O2 %	CO2 %	CO PPM
11:00	16.14	3.07	1.30
11:01	15.99	3.06	0.60
11:02	16.01	3.16	0.50
11:03	15.08	3.89	0.35
11:04	14.37	4.14	0.40
11:05	14.06	4.44	0.45
11:06	13.64	4.76	0.45
11:07	13.22	5.12	0.55
11:08	12.91	5.26	0.65
11:09	12.60	5.34	0.75
11:10	12.73	5.37	0.80
11:11	12.68	5.41	0.75
11:12	12.64	5.40	0.85
11:13	12.64	5.41	0.85
11:14	12.59	5.44	0.95
11:15	12.58	5.44	0.95
11:16	12.68	5.33	1.00
11:17	12.91	5.13	0.90
11:18	13.41	4.83	0.75
11:19	13.66	4.86	0.65
11:20	13.33	5.10	0.75
11:21	13.09	5.13	0.70
11:22	13.13	5.03	0.65
11:23	13.24	4.98	0.65
11:24	13.26	4.99	0.60
11:25	13.28	4.94	0.65
11:26	13.36	4.89	0.60
11:27	13.41	4.88	0.65
11:28	13.41	4.84	1.30
11:29	13.71	4.84	0.85
11:30	12.43	5.59	0.15
11:31	12.17	5.56	0.05
11:32	12.19	5.57	0.05
11:33	12.20	5.52	0.05
11:34	12.26	5.48	0.05
11:35	12.29	5.47	0.05
11:36	12.30	5.44	0.10
11:37	12.35	5.41	0.05
11:38	12.38	5.38	0.05
11:39	12.42	5.36	0.05
11:40	12.43	5.36	0.20
11:41	12.46	5.31	0.10
11:42	12.54	5.28	0.10
11:43	12.54	5.28	0.10
11:44	12.58	5.24	0.10
11:45	12.58	5.28	0.10
11:46	12.59	5.23	0.10
11:47	12.63	5.22	0.10
11:48	12.65	5.17	0.15
11:49	12.74	5.13	0.15
11:50	12.78	5.10	0.05
11:51	12.83	5.08	0.05
11:52	12.85	5.06	0.05
11:53	12.90	5.03	0.05
11:54	12.96	4.98	0.05
11:55	13.02	4.93	0.05
11:56	13.08	4.92	0.10
11:57	13.09	4.90	0.10
11:58	13.12	4.88	0.05
11:59	13.21	4.77	0.00

MEAN ANALYZER VALUES

Avg. % O2	13.07
Avg. % CO2	5.02
Avg. CO ppmvd	0.40

Attachment F - Project Participants

Project Participants

Arlington Environmental Services, Inc.

William Arlington
Project Director

Rufus Rhoden
Field Technician

Kaye Arlington
Laboratory Analyst

Debra Carter
Computer Analysis

Coastal Air Consultants, Inc

Stephen Webb

Guiding Light Cremations, Unit 2

Geronimo Mena
Facility Manager

Broward County Environmental Management

Courtney Pitters
Inspector

Attachment 2
Equipment Drawings and Brochures

The "Classic" Cremator

PERFORMANCE BEYOND EXPECTATIONS

BUILT to exacting quality and safety standards and backed by a two-year limited warranty, the fuel efficient "Classic" outperforms every other cremator in its price range. Take a look at some of the performance benefits the "Classic" offers!

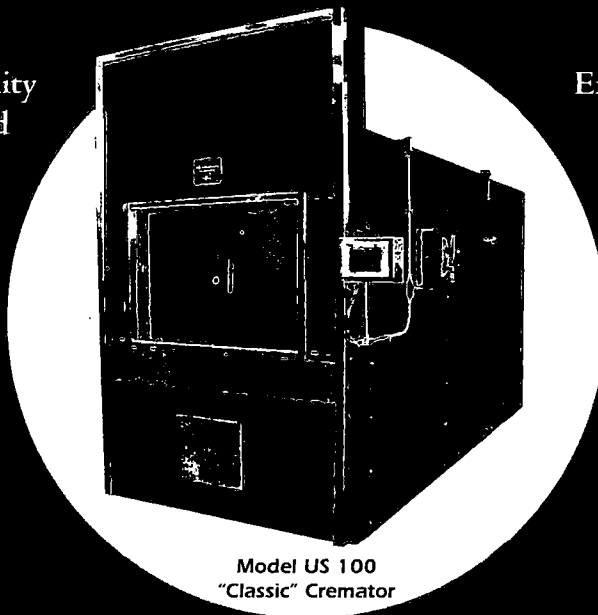

Model US 100
"Classic" Cremator

Exceptional standard features combine with professional expertise to deliver the product and service you demand. Unsurpassed in customer support, you can rely on U. S. Cremation Equipment's "Classic" to provide years of trouble-free operation.

CLASSIC PERFORMANCE

- Cremate up to six bodies in a 10-hour work day
- Complete cremation every 60 - 90 minutes
- No cool down required between cremations
- Designed to cremate obese cases up to 800 lbs.
- Fully automatic PLC operating system

CLASSIC FEATURES

- Power charging door//dual hydraulic cylinders
- Primary chamber viewport
- Secondary chamber temperature recorder
- Color touch screen control = standard
- Powder coat finish with stainless steel trim

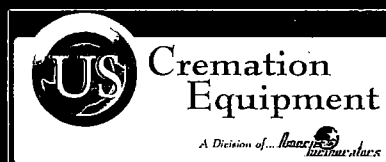

370 S. North Lake Boulevard, Suite 1004 • Altamonte Springs, FL 32701 • Ph: 321.282.7357 • Fax: 321.282.7358
www.uscremationequipment.com • E-mail: info@uscremationequipment.com

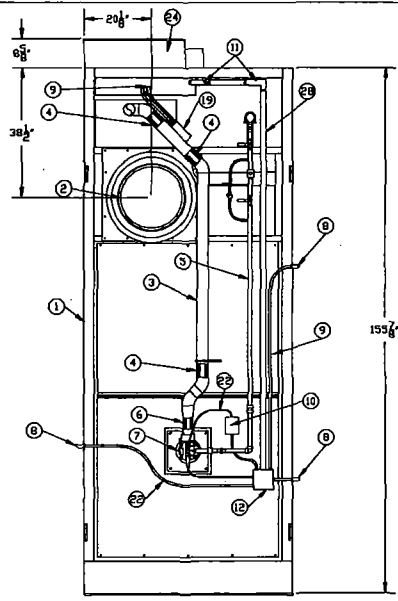

TOP

ITEM	QTY	DESCRIPTION
1	1	113 - FRAME ASSEMBLY
2	1	141 - STACK LAYOUT SMOKE SENSOR LOCATION
3	1	146 - MACHINE AIR SUPPLY
4	7	3" FERROD COUPLING
5	1	287 - GAS TRAIN 3 PIPING SYSTEM
6	1	2 1/2" FERROD COUPLING
7	1	TOP BURNER ECLIPS T.J50
8	3	1/2" ELECTRICAL LB
9	A/R	1/2" CONDUIT
10	2	DOGAN INTERCHANGEABLE IGNITOR TRANSFORMER A06-S46
11	3	1 1/2" ELECTRICAL LB
12	2	HOFFMAN ENCLOSURE ASG 6 X 6 X 4
13	A/R	1/2" CADDY BRACKETS
14	2	THERMOCOUPLE THERMAL EQUIP SYSTEM K11-16-B4-18-31
15	1	NAME PLATE SUPPLIED BY US CREMATION
16	1	135 - PEP SITE ASSEMBLY
17	1	290 - ASH BIN ASSEMBLY
18	1	LIQUID LEVEL SIGHTS P/N 1210K26 MCHASTER-CARR
19	3	BELIND LF120 US
20	1	SIEMENS TOUCH SCREEN
21	1	PARTLOW CHART RECORDER NRC5000
22	A/R	1/2" ELECTRICAL FLEX CONDUIT
23	1	134 - TRIN SS LAYOUT
24	1	S81 - ASSEMBLY ELECTRICAL 30 X 30 CONTROL PANEL
25	1	AMERICAN FAN COMPANY PH/ 24133 FAIRFIELD OHIO
26	2	LIV SCANNER MODEL S60090A ECLIPS
27	1	BOTTOM BURNER ECLIPS T.J150
28	A/R	1 1/2" ELECTRICAL CONDUIT
29	1	WORLD WIDE ELECTRICAL CROP INDUSTRIAL FRACTIONAL MOTOR AT 1.5-18-56CB
30	1	SQUARE D SENSOR P/N 9007C482

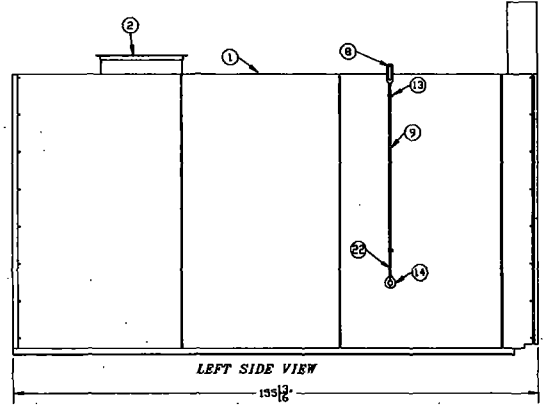

LEFT SIDE VIEW

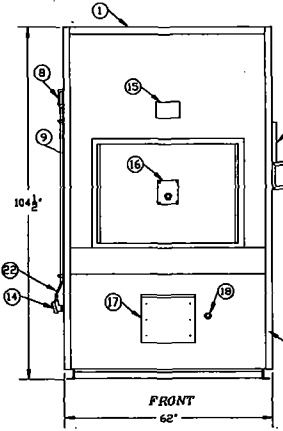

FRONT

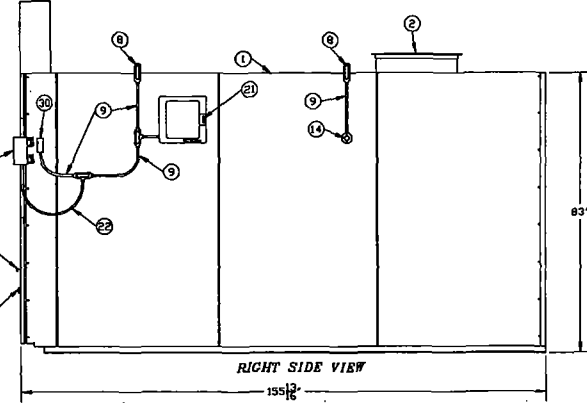

RIGHT SIDE VIEW

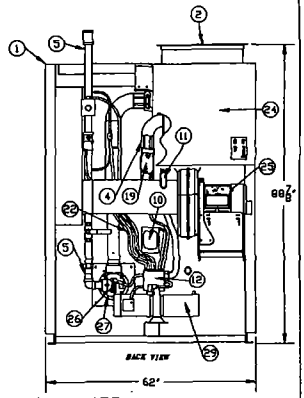

BACK VIEW

RELEASED TO SHOP DATE:

		MADE IN USA 2/1/78	US CREMATION EQUIPMENT MAIN ASSEMBLY W 30 X 30 ELECTRICAL CONTROL PANEL
NO. 584 DATE: 2/1/78 DRAWN BY: [blank] CHECKED BY: [blank]	CLASSIC	584	3/4" x 3/4" x 1/2"

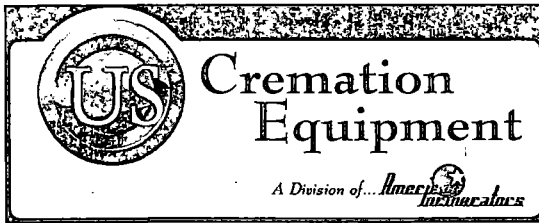

HUMAN CREMATION CHAMBER SPECIFICATION

EQUIPMENT:

US Cremation Equipment a division of American Incinerators Co. - Multiple Chambered human Crematory, Natural Gas, Propane (LP) or Oil fired.

MANUFACTURER:

US Cremation Equipment a division of American Incinerators Corp.

CONSTRUCTION STANDARDS:

The American Incinerators cremation chamber shall be constructed of U.L./CSA listed components and will meet or exceed nationally accepted incinerator construction standards per the Incinerator Institute of America (IIA) publication guidelines; i.e.:

- A. Primary chamber will not exceed 60% of total furnace volumes. Flue connection shall not be considered part of furnace volume.
- B. Flame supervision through continuous ultraviolet scanning flame detectors on all burners.
- C. High temperature refractory construction with air-cooled walls to prevent excessive heat radiation.
- D. Exhaust gas temperature reduction.

INCINERATION CHAMBER DIMENSIONS:

Chamber volumes:	Primary - 73 CF Secondary - 71 CF
Structural footprint:	12'0" (L) x 5'0" (W)
Over-all dimensions:	12'7" (L) x 6'0" (W) x 9'2" (H) w/std. hyd. door

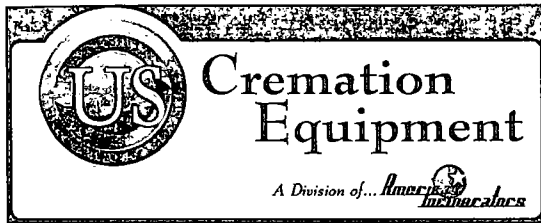

OPERATING TEMPERATURE:

Temperatures are determined as a result of federal, state or local permitting authority operating standards.

Typical primary chamber setting: 1,000°F-1,200°F

Typical secondary chamber setting: 1,400°F-1,800°F

RETENTION TIME:

In excess of 1 second.

CAPACITY:

One body and associated container per cremation cycle. 200 pounds per hour or 750 pounds per batch.

DRAFT:

Induced via refractory lined draft inducer.

SHIPPING WEIGHT:

24,500 lbs.

EMISSIONS:

The American Incinerators cremation chamber shall meet or exceed federal, state and local environmental regulations.

EMISSION CONTROL:

Secondary chamber equipped with one, 1,500,000 BTU/HR burner. Also equipped with an electronic exhaust gas scanner system which temporarily suspends operation of the primary chamber burner.

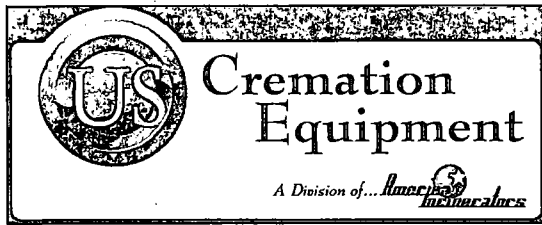

STEEL CONSTRUCTION SPECIFICATIONS:

- A. The structure to be heavy 3" steel angle , square tube; 3/8" steel plate, seal welded construction.
- B. Subfloors to be 3/16" steel plate, seal welded construction.
- C. The exterior shell to be 12 gauge steel removable panels.
- D. Interior shell to be 10 gauge steel, seal welded construction.

INSULATION & REFRACTORY SPECIFICATIONS:

- A. Hot Hearth: 3000°F abrasion resistant castable refractory, monolithic cast 7" - 13" thick, 1 -1/2" recessed top and rounded, stressed arched bottom.
- B. Chamber Floors: 3000°F abrasion resistant castable refractory, 5" thick on top of 2" 2400°F light weight insulating castable.
- C. Chamber Ceilings: 3000°F castable refractory, monolithic cast, rounded, stressed arched, 5"-9" thick, topped by 2" 2400°F light weight insulating castable.
- D. Interior Walls: 2800°F. alumina-silicate firebrick, 2 1/2" x 4 1/2" x 9", all chambers are backed by 4" of 1900°F ceramic fiber insulation
- E. Stack: Lined with 2" of 2200°F insulating refractory.

SKIN TEMPERATURE CONTROL:

Integral dual casing, completely air-cooled design to prevent excessive heat radiation.

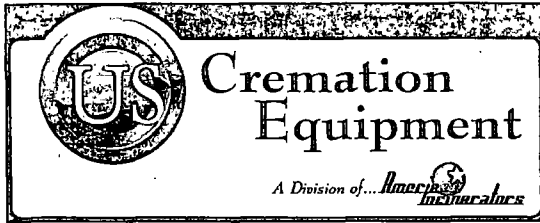

COMBUSTION EQUIPMENT:

- A. Combustion Air - One, 3 phase, 208-230/460V, 17-15.5/7.6 amp 7 hp air-blower motor (1,400 CFM)
- B. Primary Chamber - One 500,000 BTU/HR nozzle mix, gas-fired burner. Eclipse, North American, or equal.
- C. Secondary Chamber - One, 1,500,000 BTU/HR modulating, nozzle mix, gas-fired burner. Eclipse, North American, or equal.
- D. Burner Flame Safeguard - Control supervision on each burner via a flame safeguard relay and ultra-violet light detector.
- E. Low Air Pressure Safety Switch - Interlocked to all burners.

EXHAUST GAS TEMPERATURE REDUCTION:

Hot air duct operating exit temperature: 900°F

HOT AIR DUCT:

10 gauge carbon steel, high temperature 2" refractory lining, pre-drilled flanges, 24" Outside Diameter, 28" at flanges.

UTILITY REQUIREMENTS:

A. GAS:

- 1. Pressure:
 - a) Natural Gas: 7" to 9" W.C.
 - b) Propane: 11" W.C.
- 2. Flow Rate: 2,000,000 BTU/HR

B. ELECTRICAL:

- 1. One, three phase, 208-230/460V, 17-15/8 amp connection for 5hp blower.

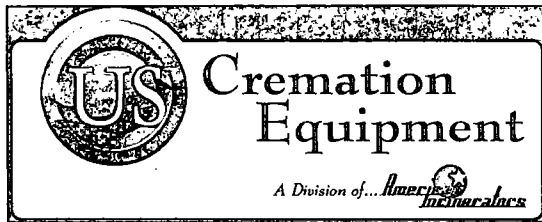

CREMATION CHAMBER LOADING/CLEAN-OUT DOOR:

Hydraulically operated, refractory lined, upward movement guillotine style door with gate view port.

CREMATION PROCESS CONTROL:

The cremation cycle is controlled by a programmable logic control (PLC) system. A visual confirmation of the system status is provided through control panel indicator lights and digital temperature display. Continuous fuel and air modulation is automatically controlled by a time/temperature actuated system. Operator interface is through two sets of simple push button controls and panel timer.

EXTERIOR FINISH:

The cremation chamber is finished with grey hi-resistance powder coating with stainless steel trim. Back of unit is coated with an epoxy type black coating.

Attachment 2
Emissions Calculations

US Cremation Equipment
Model "Classic"

Pounds Incinerated Per Hour (Average)	Hours Per Year	SO2 lb/ton	SO2 lb/hr	SO2 TPY	Nox lb/ton	Nox lb/hr	Nox TPY	TOC lb/ton	TOC lb/hr	TOC TPY
200	8760	2.5	0.25	1.095	3	0.3	1.314	3	0.3	1.314

CO=100 PPM @ 7% O2 MAX, Actual CO Emissions Measured at 3.49 PPM
 CO = 100 PPM X 28 MW X 1700 DSCFM X 2.595E-09 X 60 min/hr = 0.74 lb/hr CO
 0.74 lb/hr CO X 8760 hrs/yr X 1 ton/2000 lb = 3.24 TPY CO

Actual Emissions were measured at 0.04 gr/dscfm at 7% O2
 PM = 0.08 gr/dscf X 1 pound/7000 gr X 1700 DSCFM X 60 min/hr = 1.17 lb/hr PM
 1.17 lb/hr PM X 8760 hrs/yr X 1 ton/2000 lb = 5.12 TPY PM

Attachment 4
Process Flow Diagram

Process Flow Diagram

"Classic" Crematory

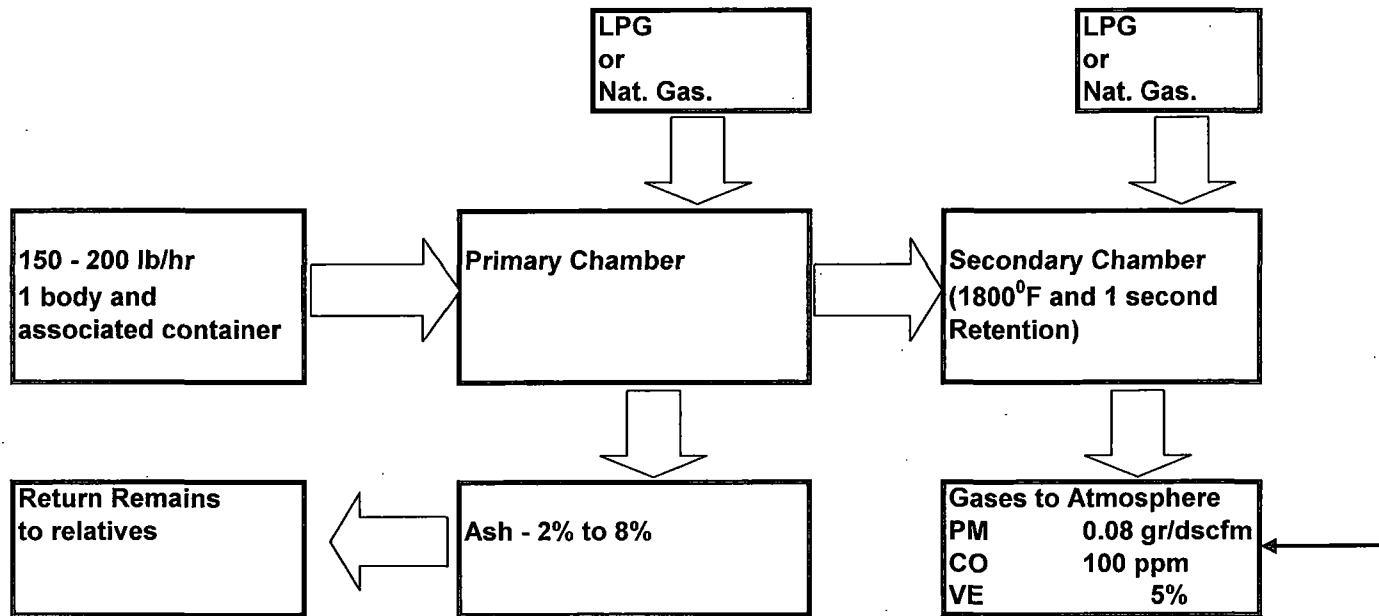



March 20, 2012

Florida Department of Environmental Protection
FDEP Receipts
PO Box 3070
Tallahassee, FL 32315-3070

RECEIVED

MAR 27 2012

DIVISION OF AIR
RESOURCE MANAGEMENT

Re: General Permit Application

To whom it may Concern:

Enclosed is one (1) copy of the above referenced application along with a check made payable to the Florida Department of Environmental Protection in the amount of \$100.00 for the application fee.

I trust this application is complete; however, should you have any questions or need any additional information for issuing the general permit, please contact me at (407) 574-2021 or e-mail at AI@CFL.RR.COM.

Respectfully submitted,
AI ENVIRONMENTAL CONSULTING SERVICES

A handwritten signature in black ink, appearing to read 'Luis Llorens', is written over a set of horizontal lines.

Luis Llorens
President/Project Manager

Enclosures: One (1) Application and check

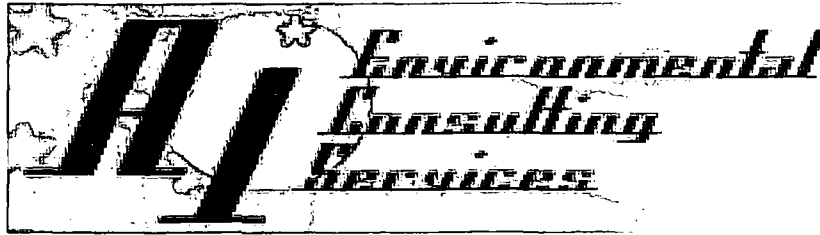

***General Permit Application
Human Crematory***

Prepared for:

***Zahn-Stow Funeral Home, Inc
dba: Tillman Funeral Home
2170 S. Military Trail
West Palm Beach, Florida 33415***

Palm Beach County

Prepared By:

***AI Environmental Consulting Services, Inc.
598 Northlake Blvd, Ste. 1016
Altamonte Springs, Florida 32701***

Date: March 2012

Application Contents

Form 62-210.920(2)(c) General Permit Application
Attachment 1 - Compliance Test Report
Attachment 2 - Equipment Drawings and Brochures
Attachment 3 - AP-42 Emissions Calculations
Attachment 4 - Process Flow Diagram

Tillman Funeral Home

2170 South Military Trail
West Palm Beach, Florida 33415



7009 2820 0000 5430 5182

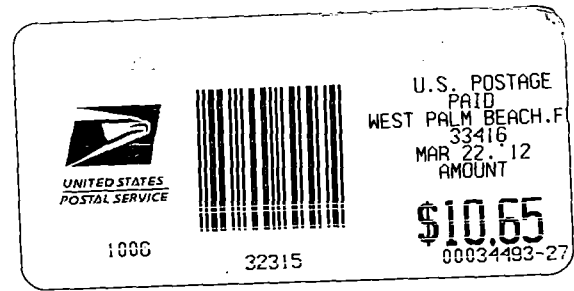

Florida Department of Environmental Protection
FDEP Receipts
P.O. Box 3070
Tallahassee, FL 32315-3070

